



Read this manual first!

Congratulations on purchasing this Philips product. We've included everything you need to get started. If you have any problems, Philips representatives can help you get the most from your new product by explaining:

- Hookups,
- First time setup, and
- Operation.

For fast help, call us first!

Tel: see back page of this manual



PHILIPS

Important notes for users in the U.K.

Mains plug

This apparatus is fitted with an approved 13 Amp plug. To change a fuse in this type of plug proceed as follows:

- 1 Remove fuse cover and fuse.
- 2 Fix new fuse which should be a BS1362 5 Amp, A.S.T.A. or BSI approved type.
- 3 Refit the fuse cover.

If the fitted plug is not suitable for your jack outlets, it should be cut off and an appropriate plug fitted in its place.

If the mains plug contains a fuse, this should have a value of 5 Amp. If a plug without a fuse is used, the fuse at the distribution board should not be greater than 5 Amp.

Note: The severed plug must be disposed to avoid a possible shock hazard should it be inserted into a 13 Amp jack elsewhere.

How to connect a plug

The wires in the mains lead are coloured with the following code: blue = neutral (N), brown = live (L).

- As these colours may not correspond with the colour markings identifying the terminals in your plug, proceed as follows:
 - Connect the blue wire to the terminal marked N or coloured black.
 - Connect the brown wire to the terminal marked L or coloured red.
 - Do not connect either wire to the earth terminal in the plug, marked E (or \perp) or coloured green (or green and yellow).

Before replacing the plug cover, make certain that the cord grip is clamped over the sheath of the lead - not simply over the two wires.

Copyright in the U.K.

Recording and playback of material may require consent. See Copyright Act 1956 and The Performer's Protection Acts 1958 to 1972.

CAUTION

Use of controls or adjustments or performance of procedures other than herein may result in hazardous radiation exposure or other unsafe operation.

VAROITUS

Muiden kuin tässä esitettyjen toimintojen säädön tai asetusten muutto saattaa altistaa vaaralliselle säteilylle tai muille vaarallisille toiminnoille.

DK

Advarsel: Usynlig laserstråling ved åbning når sikkerhedsafbrydere er ude af funktion. Undgå udsættelse for stråling.

Bemærk: Netafbryderen er sekundært indkoblet og afbryder ikke strømmen fra nettet. Den indbyggede netdel er derfor tilsluttet til lysnettet så længe netstikket sidder i stikkontakten.

S

Klass 1 laserapparat

Varning! Om apparaten används på annat sätt än i denna bruksanvisning specificerats, kan användaren utsättas för osynlig laserstrålning, som överskrider gränsen för laserklass 1.

Observera! Stömbrytaren är sekundärt kopplad och bryter inte strömmen från nätet. Den inbyggda nätdelen är därför ansluten till elnätet så länge stickproppen sitter i vägguttaget.

SF

Luokan 1 laserlaite

Varoitus! Laitteen käyttäminen muulla kuin tässä käyttöohjeessa mainitulla tavalla saattaa altistaa käyttäjän turvallisuusluokan 1 ylittävälle näkymättömälle lasersäteilylle.

Oikeus muutoksiin varataan. Laite ei saa olla alttiina tippu- ja roiskevedelle.

Huom. Toiminnanvalitsin on kytketty toisiopuolelle, eikä se kytke laitetta irti sähköverkosta. Sisäänrakennettu sähköverkkoon aina silloin, kun pistoke on pistorasiassa.

General Information

Environmental Information

All unnecessary packaging has been omitted. The packaging has been made easy to separate into three materials: cardboard (box), polystyrene foam (buffer) and polyethylene (bags, protective foam sheet).

Your DVD player consists of materials which can be recycled and reused if disassembled by a specialised company. Please observe the local regulations regarding the disposal of packaging materials, exhausted batteries and old equipment.

Manufactured under license from Dolby Laboratories. "Dolby", "Pro Logic" and the double-D symbol are trademarks of Dolby Laboratories.

DivX, DivX Certified, and associated logos are trademarks of DivX Networks, Inc and are used under license.



Laser safety

This unit employs a laser. Due to possible eye injury, only a qualified service person should remove the cover or attempt to service this device.

**NOTE:
PICTURES SHOWN MAYBE
DIFFERENT BETWEEN
COUNTRIES.**

**CAUTION
(WARNING LOCATION: ON THE
BACKPLATE OF THE SET)**

**NEVER MAKE OR CHANGE
CONNECTIONS WITH THE
POWER SWITCHED ON.**

Important Note:
Due to the numerous versions of new CD-Audio copy protection or enhanced CD-Audio protection recently available on certain discs, Philips is unable to guarantee that this DVD Player is fully compatible with such new discs. Should you have difficulty playing any such CD-Audio discs, kindly refer them to your CD-Audio disc retailer.

CE The DVD VIDEO player is in conformity with the EMC directive and low-voltage directive.

For Customer Use:

Read carefully the information located at the bottom of your DVD VIDEO player and enter below the Serial No. Retain this information for future reference.

Model No. DVD VIDEO 737

Serial No. _____

LASER

Type	Semiconductor laser GaAlAs
Wave length	650 nm (DVD) 780 nm (VCD/CD)
Output Power	7 mW (DVD) 10 mW (VCD/CD)
Beam divergence	60 degree

English 6

Français 33

Deutsch 61

Nederlands 89

English

Français

Deutsch

Nederlands

CAUTION

VISIBLE AND INVISIBLE LASER
RADIATION WHEN OPEN.
AVOID EXPOSURE TO BEAM.

ADVARSEL

SYNLIG OG USYNLIG
LASERSTRÅLING VED ÅBNING
UNDGÅ UDSÆTTELSE FOR STRÅLING

VARNING

SYNLIG OCH OSYNLIG
LASERSTRÅLNING NÄR DENNA DEL
ÄR ÖPPNAD BETRAKTA EJ STRÅLEN

VARO!

AVATTAESSA OLET ALTTIINA
NÄKYVÄLLE JA NÄKYMÄTTÖMÄLLE
LASER SÄTEILYLLE. ÄLÄ KATSO
SÄTEESEEN

VORSICHT

GEFAHR VON SICHTBARER UND
UNSICHTBARER LASERSTRAHLUNG
BEI GEÖFFNETEM GEHÄUSE.

ATTENTION

RAYONNEMENT LASER VISIBLE ET
INVISIBLE EN CAS D'OUVERTURE
EXPOSITION DANGEREUSE AU
FAISCEAU

Contents

Introduction

Supplied accessories	7
Region Codes	7
Care and safety information	7

Connections

Basic Connections	8
Picture	8
Sound	8
Connecting TV	8-9
Using SCART jack	8
Using CVBS jack	9
Connecting the power cord	9
Optional : Connecting to an Audio System	10
Optional: Connecting Digital AV Receiver	10

Functional Overview

Front and Rear Panels	11
Remote Control	12

Getting Started

Step 1: Inserting batteries into the Remote Control	13
Using the Remote Control to operate the Player	13
Step 2: Setting up the TV	14
Selecting the colour system that corresponds to your TV	14
Step 3: Setting language preference	15
Setting the OSD Language	15
Setting the Audio, Subtitle and Disc menu language	15

Disc Operations

Playable Discs	16
Playing discs	16
Using the Disc Menu	17
Symbols Used in this Manual	17
Basic playback controls	17-18
Pausing playback	17
Selecting track/chapter	17
Mute	17
Resuming playback from the last stopped point	17
Zoom	18
Repeat	18

Repeat A-B	18
Time Search	18
Special DVD features	19
Playing a Title	19
Camera Angle	19
Changing the Audio Language	19
Changing the Audio Channel	19
Subtitles	19
Special VCD & SVCD Features	19
Playback Control (PBC)	19
Preview	20
Playing MP3/Picture disc	21
General Operation	21
Playback selection	21
Program playback	21
Special MP3/JPEG features	22
Preview Function (JPEG)	22
Zoom picture (JPEG)	22
Playback with multi-angles (JPEG)	22
Scan Effect (JPEG)	22
Playback speed control (MP3)	22
JPEG and MP3 simultaneous playback	22

DVD Menu Options

Basic Operations	23
General Setup menu	23
Screen Saver	23
Smart Power	23
Audio Setup Menu	24-25
DOWNMIX	24
3D	24
Night Mode	24
Digital Output	25
Analog Output	25
Video Setup Menu	26-27
TV Display	26
Smart Picture	26
Brightness	27
Preference Setup Menu	27-28
Parental	27-28
Password	28
Default	28

Troubleshooting

Specifications

Glossary

Supplied accessories

SCART cable
(black)



Audio cable
(white, red)

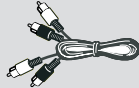

Remote Control
and
two AA batteries

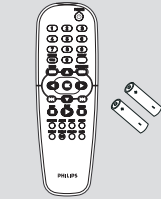

Region Codes

DVD discs must be labeled for ALL regions or Region 2 in order to play on this Player.

You cannot play Discs that are labeled for other regions.

Look for symbols above on your DVD discs.



Care and safety information

● Power supply voltage

– Check that the operating voltage indicated on the typeplate is identical to the voltage of your local power supply. If not, please consult your dealer.

● Power consumption

– When the system is switched to Standby mode, it is still consuming power. To disconnect the system from the power supply completely, remove the AC power plug from the wall jack.

● Avoid high temperatures, moisture, water and dust

– Do not expose the player, batteries or discs to humidity, rain, sand or excessive heat (caused by heating equipment or direct sunlight.)

● Avoid condensation problem

– The lens may cloud over when the player is suddenly moved from cold to warm surroundings, making it impossible to play a disc. Leave the player in the warm environment until the moisture evaporates.

● Do not block the vents

– Do not operate the DVD Player in an enclosed cabinet, allow about 10 cm (4 inches) of free space all around the player for adequate ventilation.

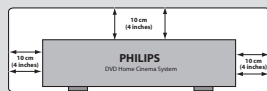

● Care of the cabinet

– Use a soft cloth slightly moistened with a mild detergent solution. Do not use a solution containing alcohol, spirits, ammonia or abrasives.

● Finding a suitable location

– Place the player on a flat, hard, and stable surface.

● Disc handling

– To clean a CD, wipe it in a straight line from the center towards the edge using a soft, lint-free cloth. A cleaning agent may damage the disc!

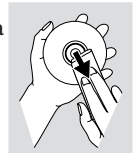

– Write only on the printed side of a CDR(W) and only with a soft felt-tipped pen.
– Handle the disc by its edge, do not touch the surface.

Connections

Basic Connections

- Please refer to the instruction books of your TV, VCR, Stereo or other devices as necessary to make the best connections.

The following guidelines are options for the best picture and sound quality available on your DVD player.

Picture

- * Use CVBS Video Output for good picture quality.
- * Use SCART Output for best picture quality.

Sound

- 1 Digital audio connections provide the clearest sound with a digital amplifier or receiver. Connect the DVD player's COAXIAL DIGITAL AUDIO OUT to your amplifier or receiver.
- 2 If the digital connection is not possible, use the audio cables (white/red) to connect AUDIO IN (L/R) jacks to your amplifier, receiver, stereo or TV.

Warning!

- Never make or change connections with the power switched on.
- Connect the DVD Player directly to the TV.
- Do not connect the DVD player AUDIO OUT to the PHONO IN of your amplifier or receiver.

Connecting TV

IMPORTANT!

- You only need to make one video connection from the following options, depending on the capabilities of your TV system.
- SCART connection will let you use the features of both the Audio and Video in the DVD Player.

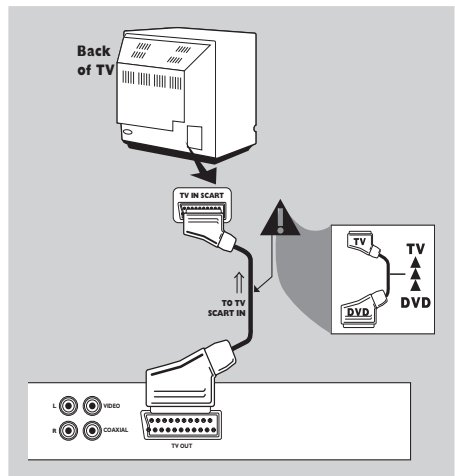

Using SCART jack

- Use the SCART cable (black) to connect the DVD Player's SCART jack (TV OUT) to the connector (TV IN) on the TV (cable supplied).

Helpful Hint:

- Ensure that the "TV" indication on SCART cable is connected to the TV set and "DVD" indication on SCART cable is connected to the DVD Player.

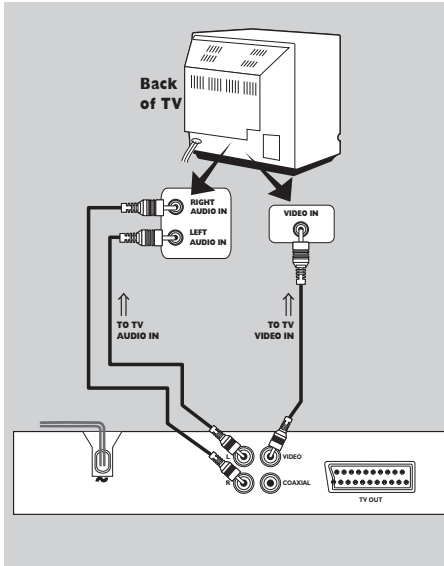

Connecting the power cord

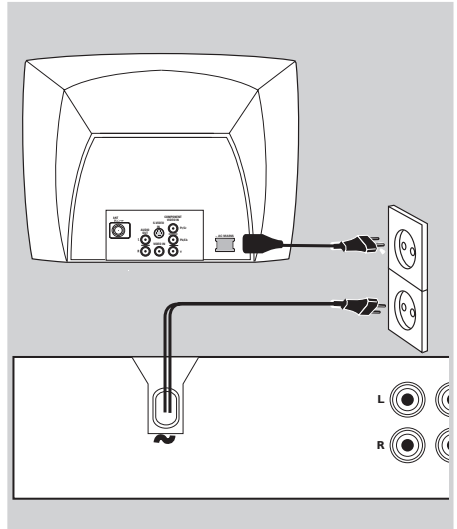

Using Composite Video jack (CVBS)

- 1 Use the composite video cable (yellow) to connect the DVD Player's CVBS (VIDEO) jack to the video input jack (or labeled as A/V In, Video In, Composite or Baseband) on the TV (*cable not supplied*).
- 2 To hear the sound of this DVD Player through your TV, use the audio cables (white/red) to connect AUDIO OUT (L/R) jacks of the DVD Player to the corresponding AUDIO IN jacks on the TV (*cable supplied*).

After everything is connected properly, plug in the AC power cord to the power outlet.

Never make or change any connections with the power switched on.

Press **STANDBY ON on the DVD Player front panel, "NO DISC" may appear on the display panel.**

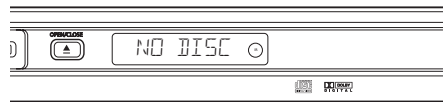

Optional : Connecting to an Audio System

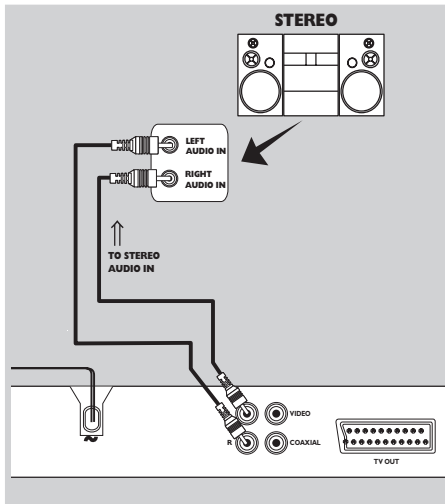

Stereo system has Dolby Pro Logic or Right / Left Audio In jack

- 1 Use the composite video cable (yellow) to connect the DVD Player's CVBS (VIDEO) jack to the video input jack (or labeled as A/V In, Video In, Composite or Baseband) on the TV (*cable not supplied*).
- 2 Use the audio cables (white/red) to connect **AUDIO OUT (L/R)** jacks of the DVD Player to the corresponding AUDIO IN jacks on the stereo system (*cable supplied*).

Optional : Connecting Digital AV Receiver

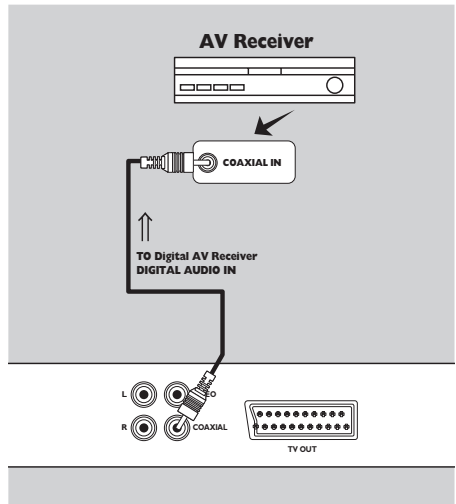

Receiver has a PCM, Dolby Digital, or MPEG2 decoder

- 1 Select one of the video connections (CVBS VIDEO IN or SCART jack (**TV OUT**)) depending on the options available on your TV.
- 2 Connect the COAXIAL jack of the DVD Player to the corresponding COAXIAL Digital Audio In jack on your Receiver (*cable not supplied*).
- 3 Set the DVD Player's Digital Output to PCM-ONLY or ALL depending on the capabilities of your Receiver (see page 25 "Digital Output").

Helpful Hint:

– If the audio format of the Digital Output does not match the capabilities of your receiver, the receiver will produce a strong, distorted sound or no sound at all.

Front and Rear Panels

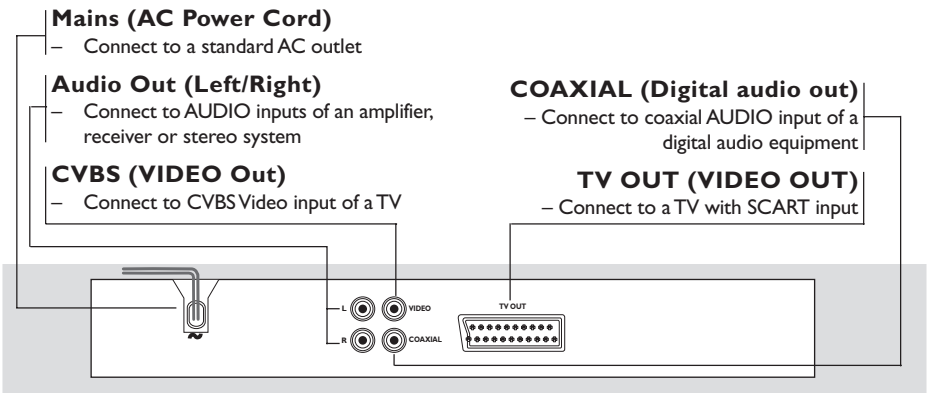
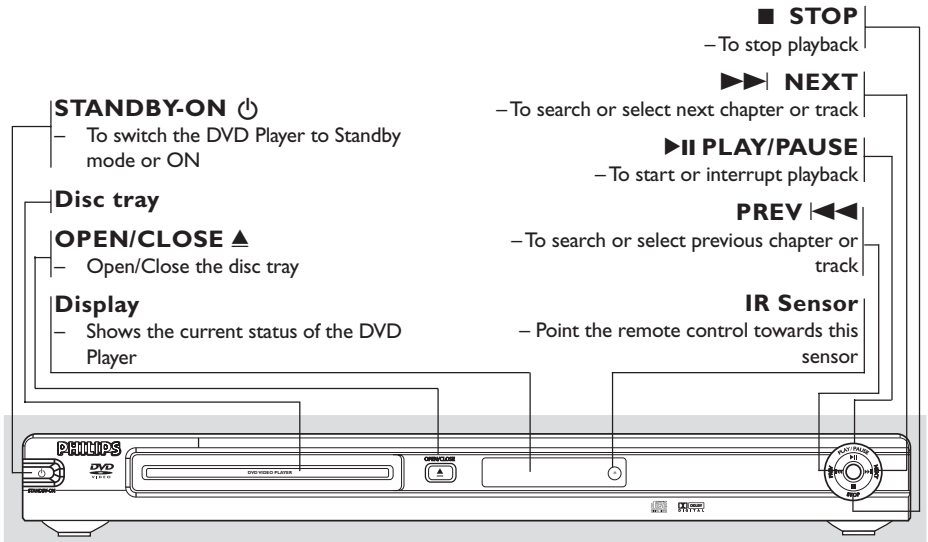

Caution: Do not touch the inner pins of the jacks on the rear panel. Electrostatic discharge may cause permanent damage to the unit.

Functional Overview

Remote Control

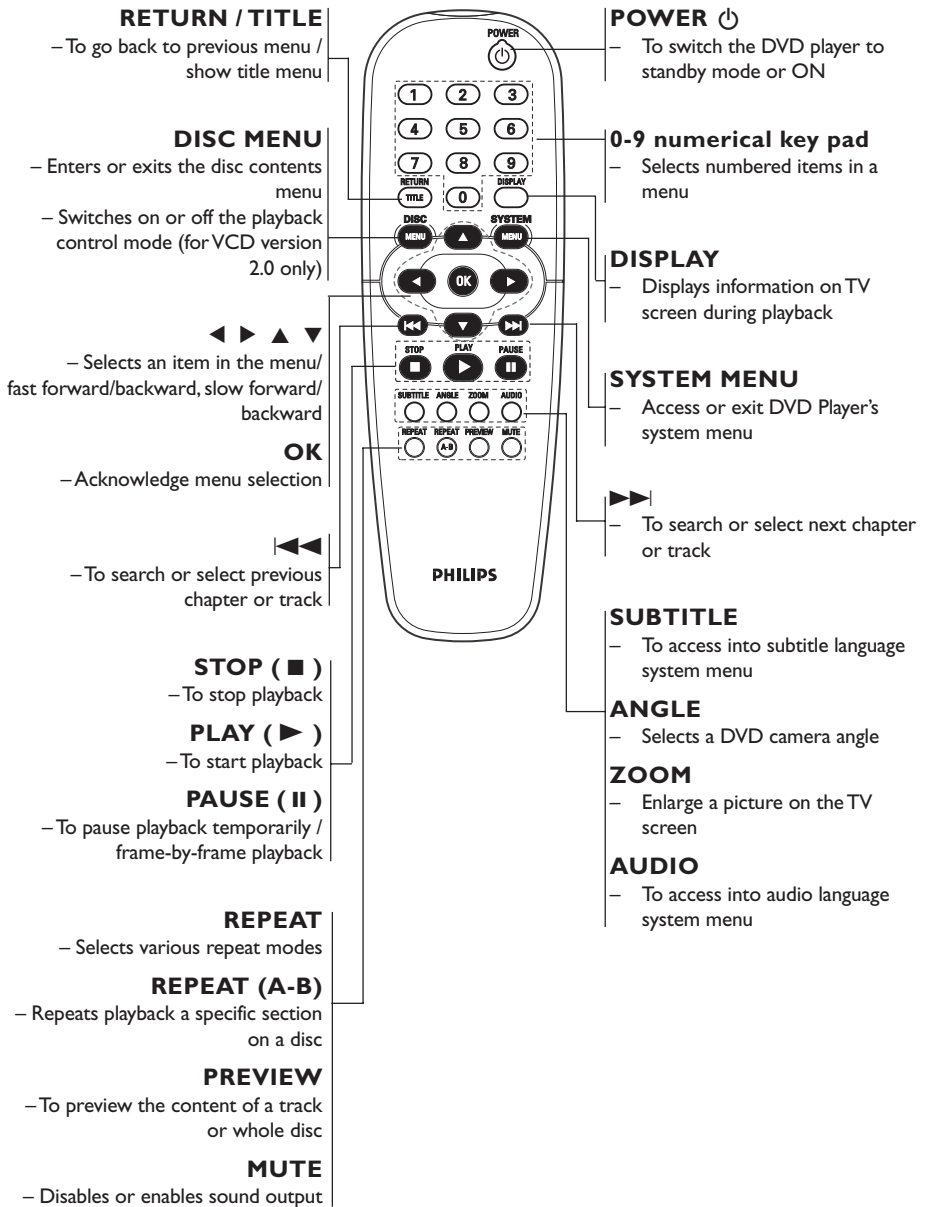

Helpful Hint:
Press "STOP" for about 2 seconds to OPEN or CLOSE disc tray.

Step 1: Inserting batteries into the Remote Control

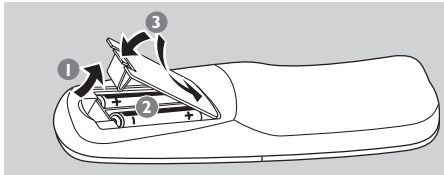

- 1 Open the battery compartment.
- 2 Insert two batteries type R06 or AA, following the indications (+ -) inside the compartment.
- 3 Close the cover.

Using the Remote Control to operate the Player

- 1 Aim the Remote Control directly at the remote sensor (iR) on the front panel.
- 2 Do not put any objects between the Remote Control and the DVD Player while operating the DVD Player.



CAUTION!

- Remove batteries if they are exhausted or if the Remote Control is not being used for a long time.
- Do not use old and new or different types of batteries in combination.
- Batteries contain chemical substances, so they should be disposed properly.

Getting Started

Step 2: Setting up the TV

IMPORTANT!

Make sure you have completed all the necessary connections. (See pages 8-9 "Connecting TV").

- 1 Turn on the TV and set to the correct video-in channel. You should see the blue Philips DVD background screen on the TV.
- 2 Usually these channels are between the lowest and highest channels and may be called FRONT, A/V IN, or VIDEO. See your TV manual for more details.
→ Or, you may go to channel 1 on your TV, then press the Channel down button repeatedly until you see the Video In channel.
→ Or, the TV Remote Control may have a button or switch that chooses different video modes.
→ Or, set the TV to channel 3 or 4 if you are using an RF modulator.
- 3 If you are using external equipment, (eg. audio system or receiver), turn it on and select the appropriate input source for the DVD Player output. Refer to the equipment owner's manual for detail.

Selecting the colour system that corresponds to your TV

This DVD Player is compatible with both NTSC and PAL. In order for a DVD disc to play on this Player, the colour system of the Disc, the TV and the DVD Player should match.

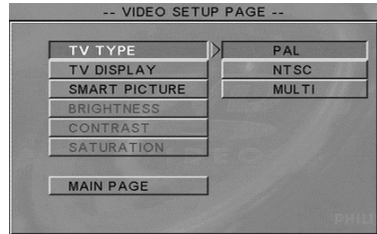

- 1 Stop playback and press **SYSTEM MENU**.
- 2 Press **▼ ▲** to select 'Video Setup' page.
- 3 Enter its submenu by pressing **OK**.
- 4 Use the **◀ ▶ ▲ ▼** keys on the Remote Control to navigate in the menu.
Move to 'TV Type' and press **▶**.
PAL – Select this if the connected TV is PAL system. It will change the video signal of a NTSC disc and output in PAL format.
NTSC – Select this if the connected TV is NTSC system. It will change the video signal of a PAL disc (VCD only) and output in NTSC format.
Multi – Select this if the connected TV is compatible with both NTSC and PAL (multi-system). The output format will be in accordance with the video signal of the disc.
- 5 Select an item and press **OK**.
- 6 Press **◀** to return to 'Video Setup' page.

To remove the menu
Press **SYSTEM MENU**.

Step 3: Setting language preference

You can select your own preferred language settings. This DVD system will automatically switch to the language for you whenever you load a disc. If the language selected is not available on the disc, the disc's default language will be used instead. The OSD language in the system menu, will remain once selected.

Setting the OSD Language

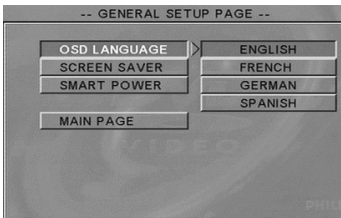

- 1 Stop playback and press **SYSTEM MENU**.
- 2 Press **▼▲** to select 'General Setup' page.
- 3 Enter its submenu by pressing **OK**.
- 4 Use the **◀▶▲▼** keys on the Remote Control to navigate in the menu.
Move to 'OSD Language' and press **▶**.
- 5 Select a language and press **OK**.

To remove the menu
Press **SYSTEM MENU**.

Setting the Audio, Subtitle and Disc menu language

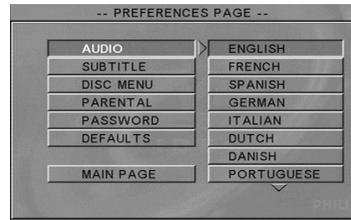

- 1 Stop playback (if any) and press **SYSTEM MENU**.
- 2 Press **▼▲** to select 'Preference Page'.
- 3 Enter its submenu by pressing **OK**.
- 4 Press **▲▼** to highlight the following in the Preference Page.
 - 'Audio' (disc's soundtrack)
 - 'Subtitle' (disc's subtitles)
 - 'Disc Menu' (disc's menu)
- 5 Enter its submenu by pressing **▶**.
- 6 Select a language and press **OK**.
- 7 Repeat steps 3~5 for other settings.

To remove the menu
Press **SYSTEM MENU**.

If you choose OTHERS in Audio, Subtitle or Disc Menu,

- 1 Press **▲▼** to highlight 'Others'.
- 2 Press **OK** and when you are asked to enter a language code (see 'Language Code' at the end of this user manual).
- 3 Input a language code by using the **numeric keypad (0-9)**.
- 4 Press **OK** to confirm.

Disc Operations

IMPORTANT!

- Depending on the DVD or VIDEO CD, some operations may be different or restricted.
- Do not push on the disc tray or put any objects other than disc on the disc tray. Doing so may cause the disc player malfunction.

Playable Discs

Your DVD Player will play:

● Discs:

- Digital Video Discs (DVDs)
- Video CDs (VCDs)
- Super Video CDs (SVCDs)
- Digital Video Discs + Recordable(DVD+R)
- Digital Video Discs + Rewritable(DVD+RW)
- Compact Discs (CDs)
- MP3 disc on CD-R(W):
 - Maximum 30 characters display.
 - Supported sampling frequencies : 32 kHz, 44.1 kHz, 48 kHz (MPEG-1) 16 kHz, 22.05 kHz, 24 kHz (MPEG-2)
 - Supported Bit-rates : 32~256 kbps (MPEG-1), 8~160 kbps (MPEG-2) variable bitrates
- Picture (JPEG) files on CD-R(W):
 - JPEG/ISO 9660 format.
- MPEG-4 disc on CD-R(W):
 - Simple profile
 - Advanced simple profile (640-480)
- DivX® disc on CD-R(W):
 - DivX 4.x and 5.x
 - GMC (Global Motion Compensation) and Q-Pel (Quarter Pixel) not supported



Helpful Hint:

- If you are having trouble playing a certain disc, remove the disc and try a different one. Improper formatted disc will not play on this DVD Player.

IMPORTANT!

 If the inhibit icon appears on the TV screen when a button is pressed, it means the function is not available on the current disc or at the current time.

Playing discs

- 1 Connect the power cords of the DVD Player and TV (and any optional stereo or AV receiver) to a power outlet.
- 2 Turn on the TV power and set to the correct Video In channel. (See page 14 "Setting up the TV").
- 3 Press **STANDBY-ON** on the DVD Player front panel.
 - You should see the blue Philips DVD background screen on the TV.
- 4 Press **OPEN-CLOSE**  button to open the disc tray and load in a disc, then press the same button again to close the disc tray.
 - Make sure the label side is facing up. For double-sided discs, load the side you want to play facing up.
- 5 Playback will start automatically (depending on the disc type).
 - If a disc menu shows on the TV, see next page on "Using the Disc Menu".
 - If the disc is locked by parental control, you must enter your four-digit password. (See page 27-28).
- 6 At any time, simply press **STOP** to stop playback.

Using the Disc Menu

Depending on the disc, a menu may appear on the TV screen once you load the disc.

To select a playback feature or item







- Use the ◀▶ ▲▼ or numeric keypad (0-9) on the Remote Control, then press **PLAY ▶** to start playback.

To access or remove the menu

- Press **DISC MENU** on the Remote Control.

Symbols Used in this Manual

The below symbols appear in some headings and notes with the following meanings:

	- Description refers to playback of DVD-video discs
	- Description refers to playback of Video CDs
	- Description refers to playback of Audio CDs
	- Description refers to playback of MP3 files
	- Description refers to playback of JPG files
	- Description refers to playback of DivX files

Basic playback controls

Unless otherwise stated, all operations described are based on Remote Control use.

Pausing playback

- 1 During playback, press **PAUSE II**.
→ Playback will pause and sound will be muted.
- 2 Press **PAUSE II** again to select the previous or next picture frame.
- 3 To return to normal playback, press **PLAY ▶**.

Selecting track/chapter

- 1 Press and hold ▶▶▶ / | ◀◀◀, then press ▶ to resume normal playback.
→ While searching, pressing ▶▶▶ / | ◀◀◀ again will decrease/increase the search speed.

Mute

- 1 Press **MUTE** repeatedly to disable and enable the sound output.

Resuming playback from the last stopped point

Resume playback of the last 5 discs is possible, even if the disc was ejected or the power switched off.

- Load one of the last 5 discs.
→ "LOADING" appears.
- Press **PLAY ▶** and the disc will be played back from the last point.

To cancel resume mode

- In stop mode, press **STOP ■** again.

Helpful Hint:

- Resume option may not be available on some discs.

Disc Operations

Zoom

Zooming allows you to enlarge the video image during playback.

- 1 Press **ZOOM** during playback to select the zoom factor.
- 2 Within 5 seconds, press ◀▶ ▲▼ to pan across the TV screen.
- 3 Press **ZOOM** repeatedly to increase and decrease the zoom factor.
→ Playback will continue.

Repeat

You can play a chapter, track, title or entire disc repeatedly.

- Press **REPEAT** continuously to choose a Repeat mode during playback.

→ 

‘CHAPTER REPEAT ON/TITLE REPEAT ON/REPEAT OFF’ appears on the TV screen.

→  

‘REP-ONE/REP-ALL/OFF’ appears on the TV screen.

→ 

‘REP-ONE/FOLDER REPEAT/DISC REPEAT/REPEAT OFF’ appears on the TV screen.

Repeat A-B

You can play only a specific portion of a Title or Track repeatedly.

- 1 During playback, press REPEAT A-B as your chosen starting point.
→ ‘A TO B SET A’ appears on the TV screen.
- 2 When the disc reaches your selected ending point, press REPEAT A-B again.
→ ‘A TO B SET B’ appears briefly on the TV screen, and the repeat sequence begins.
- 3 To resume regular playback, press REPEAT A-B again.
→ ‘A TO B CANCELLED’ appears on the TV screen.

Time Search

The Time Search function allows you to start playback at any chosen time on the disc.

- 1 Press and hold **DISPLAY**.
→ The time edit box appears.
- 2 Enter hours, minutes and seconds in the time edit box using Remote Control numerical key pad.
→ If incorrect or invalid time is entered, the numbers will blink on the TV screen.

For DVD

→ Title/Chapter Remain: displays the remaining time of the current title/chapter.

→ Title/Chapter Elapsed: displays the elapsed time of the current title/chapter.

For VCD

→ Title/Single Remain: displays the remaining time of the current title/single track.

→ Title/Single Elapsed: displays the elapsed time of the current title/single track.

- 3 Press **OK** to confirm selection.
→ Playback starts from the selected time on the disc.

Helpful Hint:

– This feature will not be applicable to VCD discs with Playback control in PBC ON.

Special DVD Features

Playing a Title

- 1 Press **DISC MENU**.
→ The disc title menu appears on the TV screen.
- 2 Use **▲▼◀▶** keys or **numeric keypad (0-9)** to select a play option.
- 3 Press **OK** key to confirm.

Camera Angle

- Press **ANGLE** repeatedly to select different desired angle.

Changing the Audio Language

- Press **AUDIO** repeatedly to select different audio languages.

Changing the Audio Channel

For VCD

- Press **AUDIO** to select the available audio channels provided by the disc (STEREO, LEFT MONO, RIGHT MONO or MIX MONO).

Subtitles

- Press **SUBTITLE** repeatedly to select different subtitle languages.

Special VCD & SVCD Features

Playback Control (PBC)

For VCD with Playback Control (PBC) feature (version 2.0 only)

- In stop mode, press **DISC MENU** to toggle between 'PBC ON' and 'PBC OFF'.
→ If you select 'PBC ON', the disc menu (if available) will appear on the TV.
→ Use the **◀◀ / ▶▶** to highlight your selection and press **OK** to confirm or use the numeric keypad (0-9) to select a play option.
- During playback, pressing **DISC MENU** will return to the menu screen (if PBC is on).

If you want to skip the index menu and playback directly from the beginning,

- In stop mode, press **DISC MENU** key on the remote control to switch off the function.

Disc Operations

Preview **VCD** **SVCD**

- At stop mode, press **PREVIEW** on the remote control.
→ The preview menu will be displayed.

1. INTRO 3. TRACK
2. DISC 4. EXIT

1. INTRO

DVD player will playback every track for few seconds with full screen to obtain a summary of the disc content.

- Press numerical key pad '1'.
- Press **OK** to confirm.
→ The full screen of each track will appear in sequence.
- Press **STOP** to quit previewing.

2. DISC

Reduce the picture of 9 tracks enough to display in a full screen.



- Press numerical key pad '2'.
- Press **OK** to confirm.
→ The preview of 9 track with full screen will appear.
- To select other tracks beyond this page, press **◀◀** or **▶▶**.
- Press the numerical key pad to select preferred track.
- Press **OK** to confirm.

3. TRACK

Reduce the picture of a single track enough to display in a full screen.



- Press numerical key pad '3'.
- Press **OK** to confirm.
→ The preview of one track with 9 parts in a full screen will appear.
- To select other tracks, press **◀◀** or **▶▶**.
- Press the numerical key pad to choose the starting point.
- Press **OK** to playback the starting point.

4. EXIT

- Press numerical key pad '4'.
- Press **OK** to exit.

This player can playback DivX, MPEG-4, MP3, JPEG, VCD & SVCD files on a personally recorded CD-R/RW disc or commercial CD.

- Maximum files programmable is 99.
- MP3: Maximum supported bitrate is 320 kbps or 48 kHz.
- DivX: DivX4.x and 5.x comply with this standard, except GMC (Global Motion Compensation) and QP (Quarter Pixel) features.
- MPEG-4: All video codecs that comply with specifications of ISO-MPEG4.
- JPEG: For baseline JPEG, maximum resolution is 5120 x 3840 (beyond this, picture will be cropped) For progressive JPG, maximum resolution 2048 x 1536 (beyond this, picture will not be displayed).

Playing MP3/DivX/MPEG-4/JPEG

IMPORTANT!

You have to turn on your TV and set to the correct Video In channel. (See page 14 "Setting up the TV").

General Operation

- 1 Load an MP3/DivX/MPEG-4/JPEG disc.
→ The disc menu appears on the TV screen.
- 2 Use ▲ ▼ to select the folder and press **OK** to open the folder.
- 3 Press ► to enter the file list.

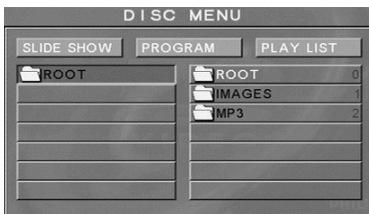

- 4 Press ▲ ▼ or use the numeric keypad (0-9) to highlight an option.
- 5 Press **OK** to confirm.
→ The playback will start from the selected file to the end of the folder.

Playback selection

During playback, you can;

- Press ◀◀ / ▶▶ to select another file in the current folder.
- Use ◀ ▶ ▲ ▼ on the remote to rotate/flip the picture files.
- Press **II** repeatedly to pause/resume playback.

In stop mode, you can;

- Press **REPEAT** continuously to access different 'Play Mode'.
→ **FOLDER**: files will be played back once.
→ **REPEAT ONE**: one file being played repeatedly.
→ **REPEAT FOLDER**: all files in one folder being played repeatedly.
→ **SHUFFLE**: all files in the current folder being played at random order.

Possible experience encountered:

- It is normal to experience an occasional "skip" while listening to your MP3 discs.
- It is normal to experience an occasional pixelation during MPEG-4/DivX playback due to clarity of digital contents during internet downloading.
- Some files may be distorted during playback due to the configuration and characteristics of the disc.

Program Playback

- 1 In the **DISC MENU**, press the ▲ ▼ to select one file or ◀◀ / ▶▶ to open the next six files.
- 2 Press **DISC MENU** select 'Program'.
- 3 Press **OK** or **PLAY** to add the selected file into the program.
→ The maximum is 99 files.
- 4 To view the selected program file, select 'Playlist'.
→ The programmed file(s) list appears.
- 5 Select one of the programmed file(s) and press **OK** or **PLAY**.
→ The playback will start from the selected file to the end of the playlist.

Disc Operations

Special MP3/JPEG features

IMPORTANT!

You have to turn on your TV and set to the correct Video In channel. (See page 14 "Setting up the TV").

Preview Function (JPEG)

This function shows the content of the current folder or the whole disc.

- 1 Press **PREVIEW** during playback.
→ Thumbnails of 9 pictures appears on the TV screen.

(example for 9 thumbnail pictures display)



- 2 Press **◀◀** / **▶▶** to display the other pictures on the previous/next page.
- 3 Use **◀▶** **▲▼** to highlight one of the picture and press **OK** to start playback, or;
Move the cursor to highlight **SLIDE SHOW** on the bottom of the page to start playback from the first picture on the current page.
- 4 Press **DISC MENU** to return to MP3/ Picture CD menu.

Zoom picture (JPEG)

- During playback, press **ZOOM** repeatedly to display the picture with different scales.
- Use **◀▶** **▲▼** to view the zoomed picture.

Playback with multi-angles (JPEG)

- During playback, press **▲▼◀▶** to rotate the picture on the TV screen.
▲: flip the picture vertically
▼: flip the picture horizontally
◀: rotate the picture anti-clockwise
▶: rotate the picture clockwise

Scan Effect (JPEG)

- Press **ANGLE** repeatedly to choose different scan effect.
→ Various of scan effect appears on the top left hand corner on the TV screen.

Playback speed control (MP3)

- Press **◀▶** repeatedly to play backward/ forward at different speed.
- You can press **◀◀** / **▶▶** to change the tracks.

JPEG and MP3 simultaneous playback

- 1 Select an MP3 file, press **DISC MENU** to select 'Slide Show'.



- 2 Select a picture file and press **OK** or **PLAY** to start music slide show.
→ The picture will be played back in sequence together with MP3 music.
- 3 To quit simultaneous playback, press **STOP**.
→ The picture and MP3 music playback will stopped.

Helpful Hint:

– During simultaneous playback of JPEG and MP3, **◀◀** / **▶▶** keys are invalid.

Basic Operations

- 1 Press **SYSTEM MENU** in the STOP mode to enter the Setup Menu.
- 2 Press **OK** to enter the next level submenu or confirm your selection.
- 3 Press **◀▶** to enter the submenu or return to the previous menu.
- 4 Press **▲▼** to highlight the desired menu.
- 5 Press **SYSTEM MENU** to quit the setup menu.
→ The settings will be stored in the player's memory even if the player is switched off.

General Setup menu

The options included in General Setup menu are: 'OSD Language', 'Screen Saver' and 'Smart Power'.

Follow the steps below:

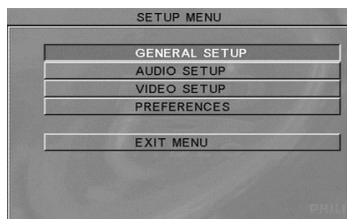

- 1 Press **SYSTEM MENU** to enter the setup menu.
- 2 Press **▲▼** to select the 'General Setup' page.
- 3 Press **OK** to confirm.

NOTE:

Some of the features in the DVD Menu Options are described in "Getting Started".

Screen Saver

This function is used to turn the screen saver on or off.

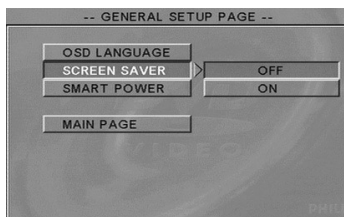

- 1 Press **▲▼** to highlight 'Screen Saver'.
- 2 Enter its submenu by pressing **▶**.
- 3 Move the cursor by pressing **▲▼** to highlight the selected item.
→ **Off**: Screen saver is disabled.
→ **On**: In STOP or No DISC mode, if no actions are performed within 5 minutes, the screen saver will be activated.
- 4 Press **OK**, then press **◀** to return to General Setup Page.

Smart Power

When in 'Stop' or 'No Disc' mode, the DVD Player will switch to standby mode after 15 minutes of inactivity for energy saving.

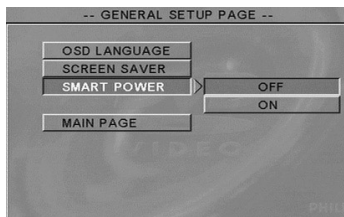

- 1 Press **▲▼** to highlight 'Smart Power'.
- 2 Enter its submenu by pressing **▶**.
- 3 Move the cursor by pressing **▲▼** to highlight the selected item.
→ **Off**: Smart Power is disabled.
→ **On**: In STOP or No DISC mode, if no actions are performed for 15 minutes, the smart power will be activated.
- 4 Press **OK**, then press **◀** to return to General Setup Page.

DVD Menu Options

Audio Setup Menu

The options included in Audio Setup menu are: 'Downmix', '3D', 'Night Mode', 'Digital Output' and 'LPCM Output'.

- 1 Press **SYSTEM MENU**.
- 2 Press **▲ ▼** to select the 'Audio Setup' page.
- 3 Press **OK** to confirm.

Downmix

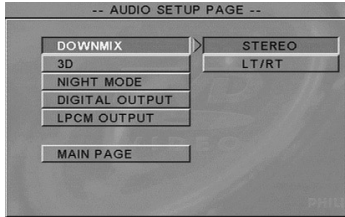

- 1 Press the **▲▼** keys to highlight 'Downmix'.
- 2 Enter its submenu by pressing **▶**.
- 3 Move the cursor by pressing the **▲▼** keys to highlight the selected item.
→ **LT/RT**: Select this option if your DVD Player is connected to a Dolby Prologic decoder.
→ **Stereo**: Select this option when output delivers sound from only the two front speakers and subwoofer.
- 4 Press **OK**, then press **◀** to return to Audio Setup Page.

3D

3D sound provides a virtual surround sound experience using just two speakers.

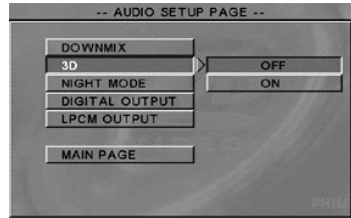

- 1 Press **▲▼** to highlight '3D'.
- 2 Enter its submenu by pressing **▶**.
- 3 Move the cursor by pressing **▲▼** to highlight the selected item.
→ **Off**: Disable 3D sound.
→ **On**: Enable 3D sound.
- 4 Press **OK**, then press **◀** to return to Audio Setup Page.

Night Mode

High volume outputs are softened, enabling you to watch your favourite action movie without disturbing others at night.

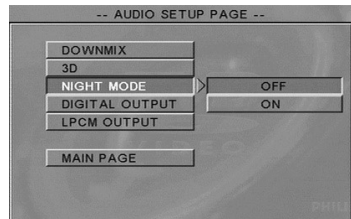

- 1 Press **▲▼** to highlight 'Night Mode'.
- 2 Enter its submenu by pressing **▶**.
- 3 Move the cursor by pressing **▲▼** to highlight the selected item.
→ **Off**: Disable night mode.
→ **On**: Enable night mode.
- 4 Press **OK**, then press **◀** to return to Audio Setup Page.

Digital Output

Set the Digital output according to your optional audio equipment connection.

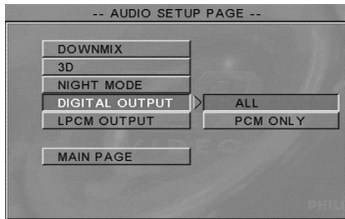

- 1 Press ▲▼ to highlight 'Digital Output'.
- 2 Enter its submenu by pressing ►.
- 3 Move the cursor by pressing ▲▼ to highlight the selected item.
 → **All**: If you have connected your DIGITAL AUDIO OUT to a multi-channel decoder/receiver.
 → **PCM Only**: Only if your receiver is not capable of decoding multi-channel audio.
- 4 Press **OK**, then press ◀ to return to Audio Setup Page.

Helpful Hint:

– If **DIGITAL OUTPUT** is set to 'All', all audio settings except **MUTE** are invalid.

LPCM Output

If you connect the DVD Player to a PCM compatible receiver via the digital terminals, such as coaxial or optical etc, you may need to adjust 'LPCM Output'. Discs are recorded at a certain sampling rate. The higher the sampling rate, the better the sound quality.

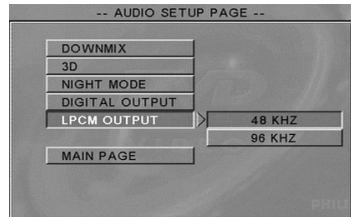

- 1 Press ▲▼ to highlight 'LPCM Output'.
- 2 Enter its submenu by pressing ►.
- 3 Move the cursor by pressing ▲▼ to highlight the selected item.
 → **48kHz**: Playback a disc recorded at the sampling rate of 48kHz.
 → **96kHz**: Playback a disc recorded at the sampling rate of 96kHz.
- 4 Press **OK**, then press ◀ to return to Audio Setup Page.

DVD Menu Options

Video Setup Menu

The options included in Video Setup menu are: 'TV Type', 'TV Display', 'Smart Picture', 'Brightness', 'Contrast' and 'Saturation'.

- 1 Press **SYSTEM MENU**.
- 2 Press **▲ ▼** to select the 'Video Setup' page.
- 3 Press **OK** to confirm.

TV Display

Set the aspect ratio of the DVD Player according to the TV you have connected.

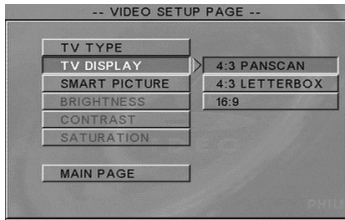

- 1 Press **▲▼** to highlight 'TV Display'.
- 2 Enter its submenu by pressing **▶**.
- 3 Move the cursor by pressing **▲▼** to highlight the selected item.

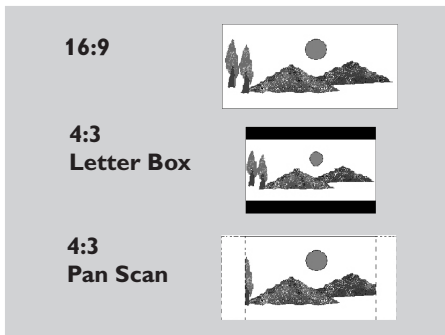

16:9

→ If you have a wide-screen TV.

4:3 Letter Box

→ If you have a normal TV. In this case, a wide picture with black bands on the upper and lower portions of the TV screen will be displayed.

4:3 Pan Scan

→ If you have a normal TV and want both sides of the picture to be trimmed or formatted to fit your TV screen.

- 4 Press **OK**, then press **◀** to return to Video Setup Page.

Smart Picture

In this menu, you can choose a picture setting from a fixed set of ideal predefined picture settings.

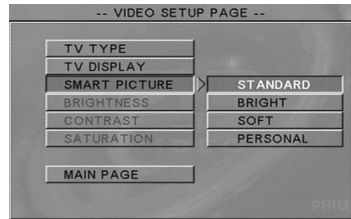

- 1 Press **▲▼** to highlight 'Smart Picture'.
- 2 Enter its submenu by pressing **▶**.
- 3 Move the cursor by pressing **▲▼** to highlight the selected item.
 - **Standard**: select the standard picture setting.
 - **Bright**: make the TV picture brighter.
 - **Soft**: make the TV picture softer.
 - **Personal**: achieve the colour effect set in the 'Brightness', 'Contrast' and 'Saturation' menu.
- 4 Press **OK**, then press **◀** to return to Video Setup Page.

Brightness

You can personalise your picture colour by adjusting brightness, contrast and saturation.

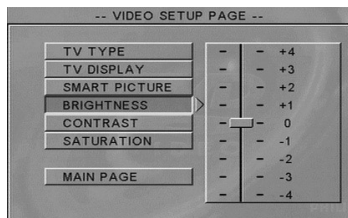

- 1 Press ▲▼ to highlight 'Brightness'.
- 2 Press ► to open the level bar.
- 3 Press ▲▼ to decrease or increase the brightness level.
- 4 Press OK, then press ◀ to return to Video Setup Page.
- Repeat steps 1 - 4 for adjusting the contrast and saturation feature.

Preference Setup Menu

The options included in Preference Setup menu are: 'Audio', 'Subtitle', 'Disc Menu', 'Parental', 'Password' and 'Default'.

- 1 Press **STOP** twice.
- 2 Press **SYSTEM MENU** to enter the setup menu.
- 3 Press ▲▼ to select the 'Preference' page.
- 4 Press **OK** to confirm.

Parental

Some DVDs may have a parental level assigned to the complete disc or to certain scenes on the disc. This feature lets you set a playback limitation level. The rating levels are from 1 to 8 and are country dependent. You can prohibit the playing of certain discs that are not suitable for your children or have certain discs played with alternative scenes.

- VCD, SVCD, CD have no level indication, so parental control function has no effect on those kinds of discs. This applies to most illegal DVD discs.

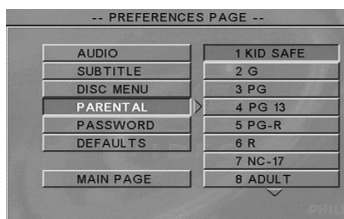

DVD Menu Options

Parental - cont'd

- 1 Press **▲▼** to highlight 'Parental'.
- 2 Enter its submenu by pressing **►**.
- 3 Use **▲▼** to highlight a rating level for the disc inserted.
→ DVDs that are rated above the level you selected will not play unless you enter your four-digit password and choose a higher level rating.
→ To disable Parental controls and have all Discs play, choose 'No Parental'.
- 4 Press **OK**, then press **◀** to return to Preference Setup Page.

Helpful Hint:

– Some DVDs are not encoded with a rating though the movie rating may be printed on the Disc cover. The rating level feature does not work for such Discs.

Rating explanations

2 G

– General Audience; recommended as acceptable for viewers of all ages.

3 PG

– Parental Guidance suggested.

4 PG13

– Material is unsuitable for children under age 13.

5-6 PG-R

– Parental Guidance - Restricted; recommended that parents restrict children under 17 from viewing or allow to view only when supervised by a parent or adult guardian.

7 NC-17

– No children under age 17; not recommended viewing for children under age 17.

8 ADULT

– Mature material; should be viewed only by adults due to graphic sexual material, violence or language.

NO PARENTAL

– It will play all discs.

Password

This feature is used for Parental Control. Enter your four digit password when a hint is displayed on the screen. The default password is 0000.

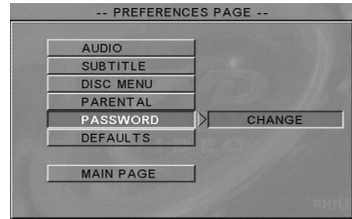

- 1 Press **▲▼** to highlight 'Password'.
- 2 Enter its submenu by pressing **►**.
- 3 Press **OK** to open the password 'Change' page.
- 4 Enter the new 4-digit code.
- 5 Enter the new 4-digit code a second time to confirm.
→ The new 4 digit code will be take effect.
- 6 Press **OK**, then press **◀** to return to Preference Setup Page.

Default

Setting the 'Default' function will reset all options and your personal settings to the factory defaults and all your personal settings will be erased.

- 1 Press **▲▼** to highlight 'Default'.
- 2 Highlight RESET by pressing **►**.
- 3 Press **OK**, then press **◀** to return to Preference Setup Page.

Caution!

– **When this function is activated, all settings will be reset to factory defaults.**

WARNING

Under no circumstances should you try to repair the system yourself, as this will invalidate the warranty. Do not open the system as there is a risk of electric shock.

If a fault occurs, first check the points listed below before taking the system for repair. If you are unable to remedy a problem by following these hints, consult your dealer or Philips for help.

Problem	Solution
No power	<ul style="list-style-type: none"> – Check if the AC power cord is properly connected. – Press the STANDBY ON on the front of the DVD system to turn on the power.
No picture	<ul style="list-style-type: none"> – Refer to your TV's manual for correct Video In channel selection. Change the TV channel until you see the DVD screen. – Check if the TV is switched on.
Distorted picture	<ul style="list-style-type: none"> – Sometimes a small amount of picture distortion may appear depending on the disc being played back. This is not a malfunction.
Completely distorted picture or black/white picture with DVD	<ul style="list-style-type: none"> – Connect DVD Player directly to the TV. – Make sure the disc is compatible with the DVD/Player. – Ensure that the DVD Player's TV System is set to match that of the Disc and your TV.
No sound or distorted sound	<ul style="list-style-type: none"> – Adjust the volume. – Check that the speakers are connected correctly.
No audio at digital output	<ul style="list-style-type: none"> – Check the digital connections. – Check if your receiver can decode MPEG-2 or DTS and if not, please make sure the digital output is set to PCM. – Check if the audio format of the selected audio language matches your receiver capabilities.
No sound and picture	<ul style="list-style-type: none"> – Check that the SCART cable is connected to the correct device (See Connecting TV).
Disc can't be played	<ul style="list-style-type: none"> – The DVD+R/CD-R must be finalized. – Ensure the disc label is facing up. – Check if the disc is defective by trying another disc. – If you have recorded a Picture CD or MP3 CD yourself, ensure that your disc contains at least 10 pictures or 5 MP3 tracks. – Region code incorrect.
Picture freezes momentarily during playback	<ul style="list-style-type: none"> – Check the disc for fingerprints/scratches and clean with a soft cloth wiping from centre to edge.
No return to start-up screen when disc is removed	<ul style="list-style-type: none"> – Reset the unit by switching the player off, then on again.

Troubleshooting

Problem	Solution
The player does not respond to the Remote Control	<ul style="list-style-type: none">- Aim the Remote Control directly at the sensor on the front of the player.- Reduce the distance to the player.- Replace the batteries in the Remote Control.- Re-insert the batteries with their polarities (+/- signs) as indicated.
Buttons do not work	<ul style="list-style-type: none">- To completely reset the player, unplug the AC cord from the AC outlet for 5-10 seconds.
Player does not respond to some operating commands during playback.	<ul style="list-style-type: none">- Operations may not be permitted by the disc. Refer to the instructions of the disc jacket.
DVD Player cannot read CDs/DVDs	<ul style="list-style-type: none">- Use a commonly available cleaning CD/DVD to clean the lens before sending the DVD Player for repair.
Menu items cannot be selected	<ul style="list-style-type: none">- Press STOP twice before selecting System Menu.- Depending on the disc availability, some menu items cannot be selected.
Unable to play DivX movies	<ul style="list-style-type: none">- Check that the DivX file is encoded in 'Home Theater' mode with DivX 5.x encoder.

If you are unable to remedy a problem by following these hints, consult your dealer or service center (HOTLINE).

TV STANDARD (PAL/50Hz) (NTSC/60Hz)

Number of lines	625	525
Playback	Multistandard	(PAL/NTSC)

VIDEO PERFORMANCE

CVBS	1Vpp — 75
RGB (SCART)	0.7Vpp — 75

VIDEO FORMAT

Digital Compression	MPEG 2 for DVD,SVCD
	MPEG 1 forVCD
	MPEG-4

DVD	50Hz	60Hz
Horiz. resolution	720 pixels	720 pixels
Vertical resolution	576 lines	480 lines

VCD	50Hz	60Hz
Horiz. resolution	352 pixels	352 pixels
Vertical resolution	288 lines	240 lines

AUDIO FORMAT

Digital	Mpeg/ AC-3/ DTS/PCM	compressed Digital 16, 20, 24 bits fs, 44.1, 48, 96 kHz
	MP3(ISO 9660)	96, 112, 128, 256 kbps & variable bit rate fs, 32, 44.1, 48 kHz

Analog Sound Stereo

Dolby Surround compatible downmix from Dolby Digital multi-channel sound

3D Sound for virtual 5.1 channel sound on 2 speakers

AUDIO PERFORMANCE

DA Converter	24bit
DVD	fs 96 kHz 4Hz- 44kHz
	fs 48 kHz 4Hz- 22kHz
SVCD	fs 48 kHz 4Hz- 22kHz
	fs 44.1kHz 4Hz- 20kHz
CD/VCD	fs 44.1kHz 4Hz- 20kHz
Signal-Noise (1kHz)	110 dB
Dynamic range(1kHz)	100 dB
Crosstalk (1kHz)	105 dB
Distortion/noise (1kHz)	90 dB
MPEG MP3	MPEG Audio L3

CONNECTIONS

Scart Output	Euroconnector
Video Output	Cinch (yellow)
Audio Output(L+R)	Cinch (white/red)
Digital Output	1 coaxial
	IEC60958 for CDDA / LPCM
	IEC61937 for MPEG 1/2, Dolby
	Digital and DTS

CABINET

Dimensions (w x h x d)	435 x 43 x 310 mm
Weight	Approximately 2.5 kg

POWER CONSUMPTION

Power consumption in Standby mode <5W

* typical playing time for movie with 2 spoken languages and 3 subtitle languages

Specifications subject to change without prior notice

Analog: Sound that has not been turned into numbers. Analog sound varies, while digital sound has specific numerical values. These jacks send audio through two channels, the left and right.

Aspect ratio: The ratio of vertical and horizontal sizes of a displayed image. The horizontal vs. vertical ratio of conventional TVs. is 4:3, and that of wide-screens is 16:9.

AUDIO OUT Jacks: Jacks on the back of the DVD System that send audio to another system (TV, Stereo, etc.).

Bit Rate: The amount of data used to hold a given length of music; measured in kilobits per seconds, or kbps. Or, the speed at which you record. Generally, the higher the bit rate, or the higher the recording speed, the better the sound quality. However, higher bit rates use more space on a Disc.

Chapter: Sections of a picture or a music piece on a DVD that are smaller than titles. A title is composed of several chapters. Each chapter is assigned a chapter number enabling you to locate the chapter you want.

Disc menu: A screen display prepared for allowing selection of images, sounds, subtitles, multi-angles, etc recorded on a DVD.

Digital: Sound that has been converted into numerical values. Digital sound is available when you use the DIGITAL AUDIO OUT COAXIAL or OPTICAL jacks. These jacks send audio through multiple channels, instead of just two channels as analog does.

Dolby Digital: A surround sound system developed by Dolby Laboratories containing up to six channels of digital audio (front left and right, surround left and right, center and subwoofer).

DTS: Digital Theater Systems. This is a surround sound system, but it is different from Dolby Digital. The formats were developed by different companies.

JPEG: A very common digital still picture format. A still-picture data compression system proposed by the Joint Photographic Expert Group, which features small decrease in image quality in spite of its high compression ratio.

MP3: A file format with a sound data compression system. "MP3" is the abbreviation of Motion Picture Experts Group 1 (or MPEG-1) Audio Layer 3. By using MP3 format, one CD-R or CD-RW can contain about 10 times as much data volume as a regular CD can.

Multichannel: DVD is specified to have each sound track constitute one sound field. Multichannel refers to a structure of sound tracks having three or more channels.

Parental Level: A function of the DVD to limit playback of the disc by the age of the users according to the limitation level in each country. The limitation varies from disc to disc; when it is activated, playback will be prohibited if the software's level is higher than the user-set level.

PCM (Pulse Code Modulation): A system for converting analog sound signal to digital signal for later processing, with no data compression used in conversion.

Playback control (PBC): Refers to the signal recorded on video CDs or SVCDs for controlling reproduction. By using menu screens recorded on a Video CD or SVCD that supports PBC, you can enjoy interactive-type software as well as software having a search function.

Region code: A system for allowing discs to be played back only in the region designated beforehand. This unit will only play discs that have compatible region codes. You can find the region code of your unit by looking on the product label. Some discs are compatible with more than one region (or ALL regions).

Title: The longest section of a picture or music feature on DVD, music, etc., in video software, or the entire album in audio software. Each title is assigned a title number enabling you to locate the title you want.

VIDEO OUT jack: Jack on the back of the DVD System that sends video to a TV.

Free Manuals Download Website

<http://myh66.com>

<http://usermanuals.us>

<http://www.somanuals.com>

<http://www.4manuals.cc>

<http://www.manual-lib.com>

<http://www.404manual.com>

<http://www.luxmanual.com>

<http://aubethermostatmanual.com>

Golf course search by state

<http://golfingnear.com>

Email search by domain

<http://emailbydomain.com>

Auto manuals search

<http://auto.somanuals.com>

TV manuals search

<http://tv.somanuals.com>