





**MAGNAVOX**  
SMART. VERY SMART.

MDV456

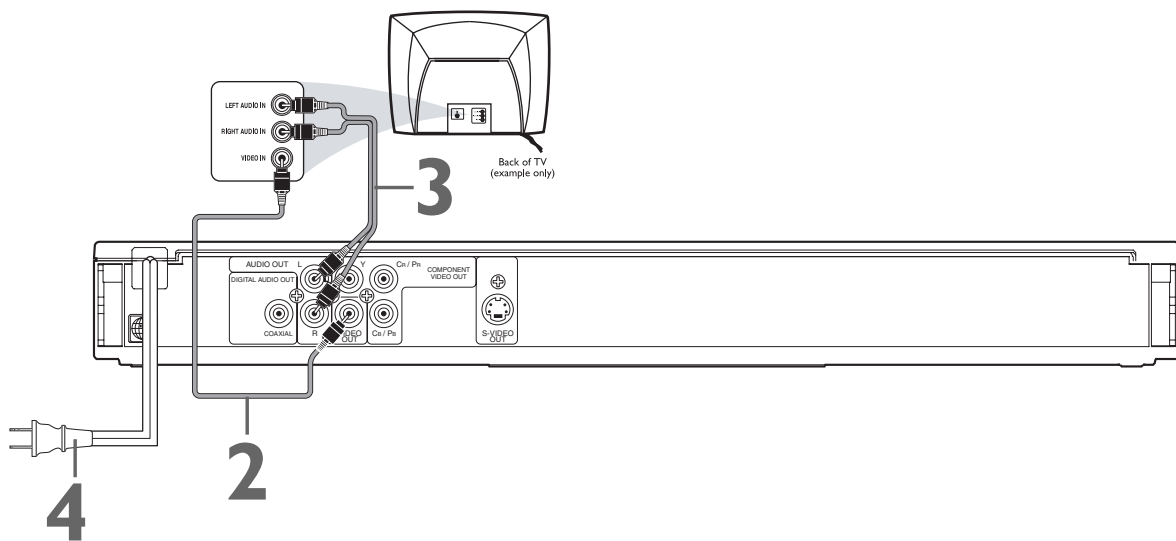

There are many ways to connect your new DVD Player to your Television and other equipment. This Quick-Use Guide shows the easiest, most common connection between the DVD Player and a TV. Higher quality connections are explained in the accompanying owner's manual and will provide better sound or picture if your TV and/or audio system is compatible.



- 1** Disconnect all equipment from the power outlets. Connect the equipment to the power outlets only after you have finished hooking up everything. Never make or change connections with equipment connected to the power outlet.
- 2** Connect the yellow VIDEO OUT jack of the DVD Player to the corresponding VIDEO IN jack on your TV. Use the supplied video cable, which has yellow ends. On the TV, the VIDEO IN jack is usually yellow and might be labeled video, CVBS, composite, or baseband.
- 3** Connect the supplied audio cable to the red and white (Right and Left) AUDIO OUT jacks on the DVD Player and to the right/left AUDIO IN jacks on the TV. The supplied audio cable has red and white ends. Match the cable colors to the jack colors. On the TV, the AUDIO IN jacks are usually labeled Audio. The red jack is the right (stereo channel) and the white jack is the left (stereo channel).
- 4** Plug the power cords of the DVD Player and the TV into an active power outlet. Press the STANDBY-ON  button on the front of the DVD Player to turn on the DVD Player.
- 5** Turn on the TV power. Set the TV to the correct Video In channel. Such channels may be called AUX or AUXILIARY IN, AUDIO/VIDEO or A/V IN, EXT1 or EXT2 or External In, etc. These channels are often near channel zero (0). See your TV manual for details. Or, change TV channels until you see the DVD logo on the TV screen.

**Remember...**

- Connect the DVD Player directly to the TV. For example, do not connect the DVD Player to a VCR, then connect the VCR to a TV. This type of connection may distort the picture and sound or give you a black and white picture. Also, your VCR might have the copy protection system, which could distort the DVD image or prevent playback of some Discs.
- If your TV does not have red, white, and yellow Audio and Video In jacks, refer to the owner's manual for other hookup options. If your TV only has a single Antenna In or RF In jack, you will need an RF modulator. See the owner's manual for details.

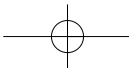

# Quick-Use Guide (cont'd)

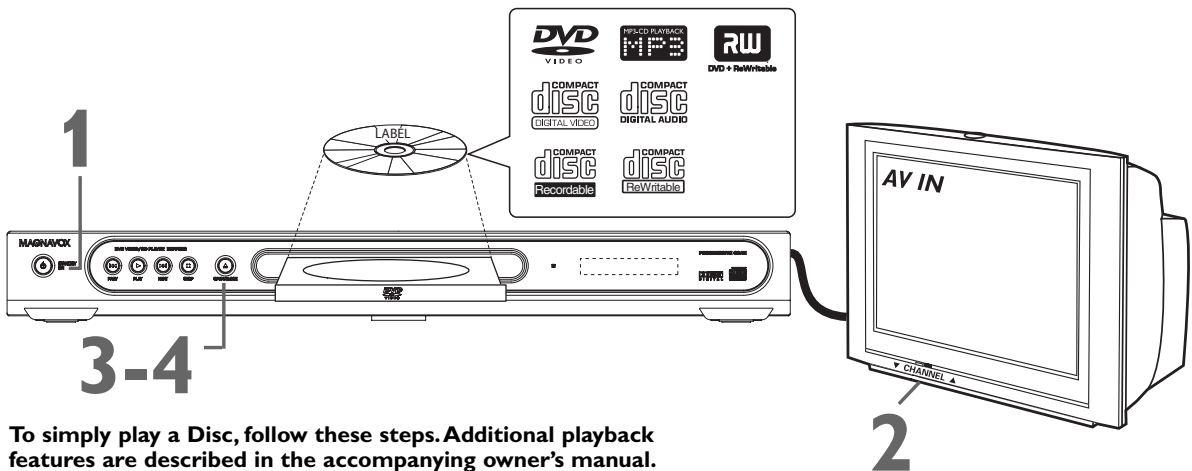

To simply play a Disc, follow these steps. Additional playback features are described in the accompanying owner's manual.

- 1** Press **STANDBY-ON** on the front of the DVD Player to turn on the DVD Player.
- 2** Turn on your TV. Set it to the correct Video In channel. You should see the DVD logo on the TV screen (if no Disc is in the DVD Player).
- 3** Press **OPEN/CLOSE** on the front of the DVD Player to open the disc tray.
- 4** Load your Disc in the tray, with the label facing up. If the Disc (DVD) is two-sided, make sure the label of the side you want to play is facing up. **Press PLAY to close the tray.**
- 5** Playback may start automatically. If not, press **PLAY .** If a Disc menu appears, use the , , , , **OK**, or Number buttons to select features or start playback from a menu. Follow the instructions in the Disc menu.
- 6** To stop playing the Disc, press **STOP** .

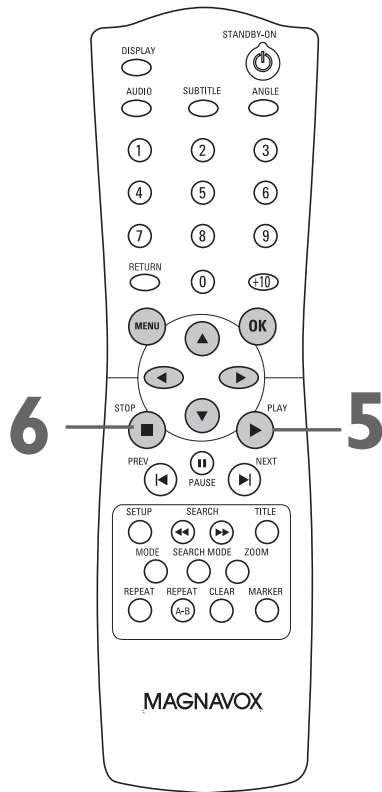

## Region Codes

DVDs must be labeled for ALL regions or for Region 1 in order to play on this DVD Player. You cannot play Discs that are labeled for other regions. If one of these logos appears on your DVD or its case, it should play on this DVD Player.

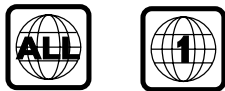

DVDs must be recorded in either the **NTSC** or **PAL** color system. Your TV must also have the NTSC or PAL color system.

8239 300 37651  
1VMN20389/E6170UD\*\*\*\*  
Printed in China



Detailed playback features and additional functions are described in the accompanying owner's manual.

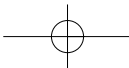

## Free Manuals Download Website

<http://myh66.com>

<http://usermanuals.us>

<http://www.somanuals.com>

<http://www.4manuals.cc>

<http://www.manual-lib.com>

<http://www.404manual.com>

<http://www.luxmanual.com>

<http://aubethermostatmanual.com>

Golf course search by state

<http://golfingnear.com>

Email search by domain

<http://emailbydomain.com>

Auto manuals search

<http://auto.somanuals.com>

TV manuals search

<http://tv.somanuals.com>