

Quick Start Guide



Step A *Connect*

Step B *Setup*

Step C *Enjoy*

What's in the Box?

You should find these items upon opening the box.

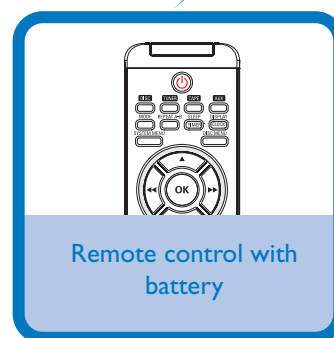
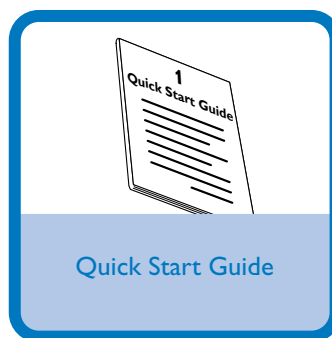
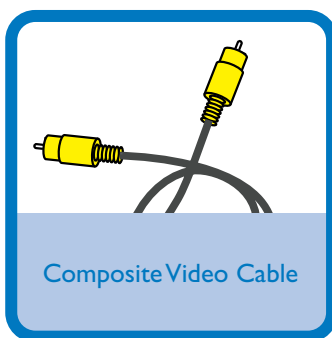

Remove the plastic protective sheet

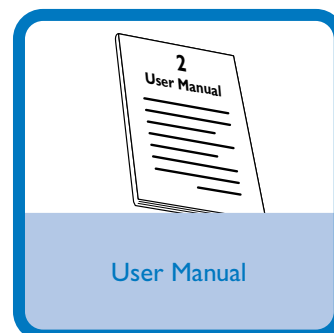
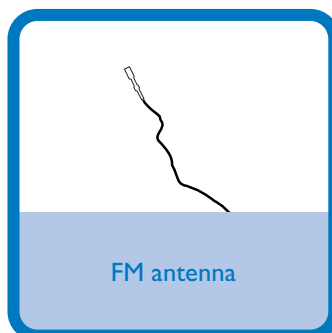
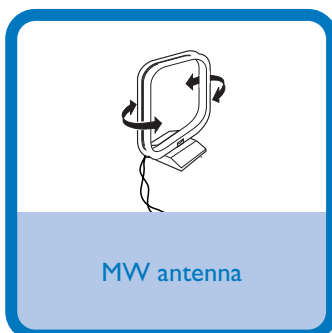
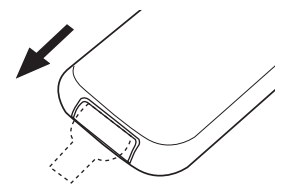

PHILIPS

Step A Connect

Tip

See the User Manual for other TV connection options.

1

Connect the speaker cables.

2

Connect the FM and MW antenna.

3

Connect the composite video cable to a TV.

4

Connect the power cords of the system and TV.

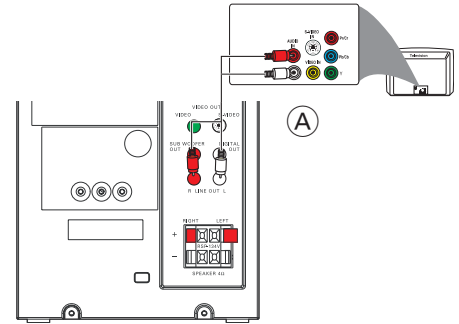
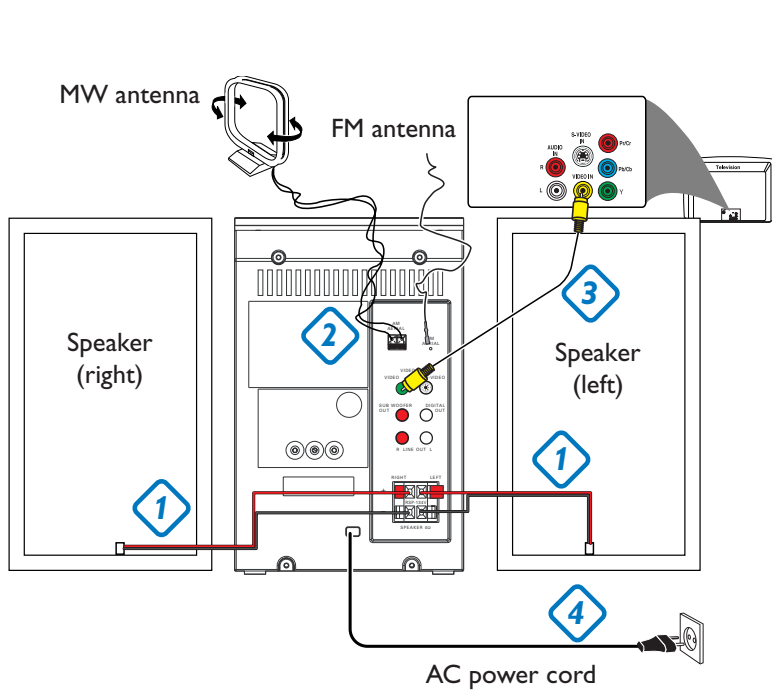

A To listen to the sound of this DVD Player through your TV, use the audio cables (white/red-not supplied) to connect **LINE OUT (L/R)** jacks of the DVD Player to the corresponding **AUDIO IN** jacks on the TV.

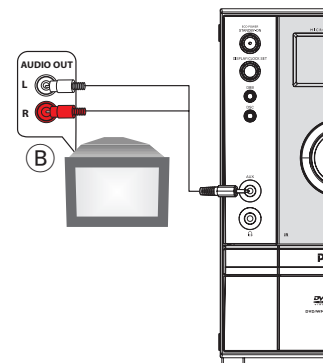

B To listen to the sound of your TV through this DVD player, use a cinch cable (not supplied) to connect **AUX** on the front panel of the DVD player to the corresponding **AUDIO OUT** jacks on the TV.

Step B Setup

Setting up the TV

1

Press **SOURCE** (**DISC** on the remote) to select disc source.

2

Turn on the TV and set it to the correct Video In channel.

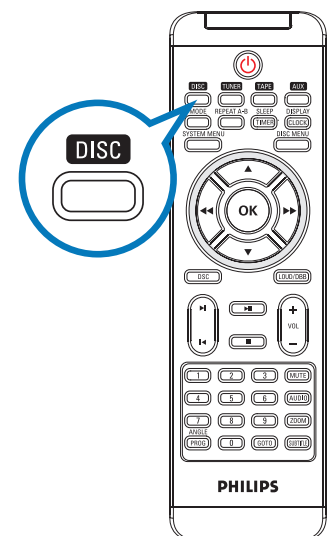

Step B Setup

Setting the clock

- 1 In standby mode, press and hold **DISPLAY/CLOCK SET** on the system.
- 2 When the hour digits flash, press **◀/▶** on the front panel or on the remote to set the hours.
- 3 Press **DISPLAY/CLOCK SET** again and the minute digits flash. Then press **◀/▶** on the front panel or on the remote to set the minutes.
- 4 Press **DISPLAY/CLOCK SET** again to confirm the time setting.

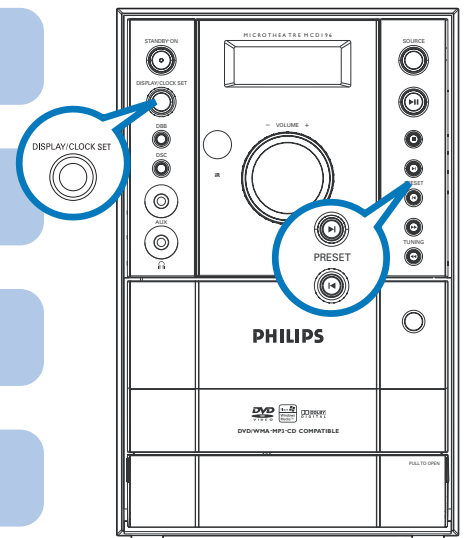

Setting system menu options

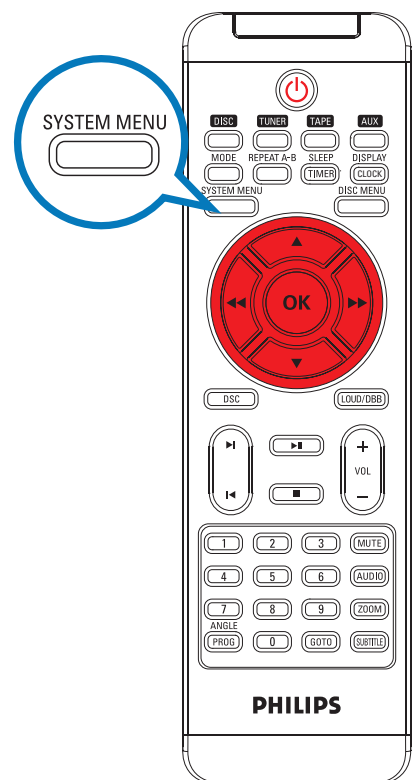
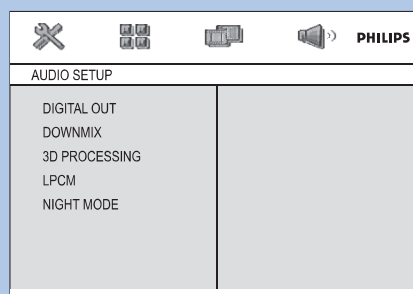
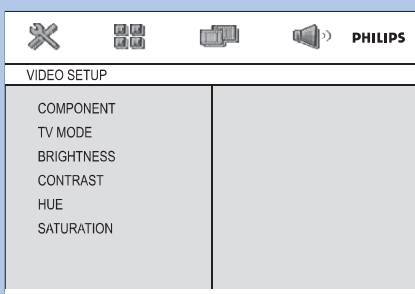
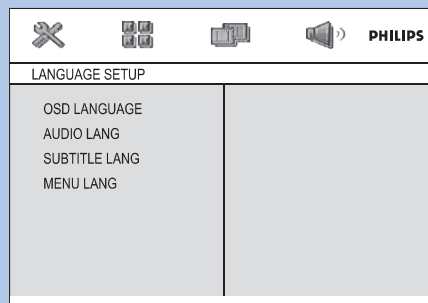
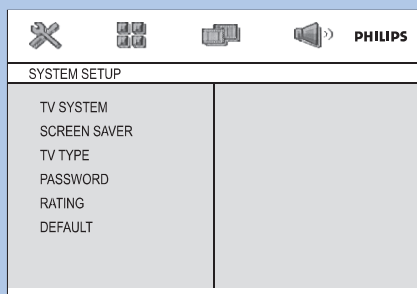

Tip

See chapters "Preparations" and "System Menu Options" in the User Manual for detailed descriptions.

Playing a disc



1 Press **OPEN•CLOSE** to open the disc tray and load in a disc, then press the same button again to close the disc tray.
→ Make sure the label side of the disc is facing up.

2 Playback will start automatically. If not press **▶ ||**.

3 To stop playback, press **■**.

Programming and tuning to radio stations

1 Press **SOURCE (TUNER)** on the remote to select tuner source.

2 Press **PROG/ANGLE** for more than two seconds to program all available stations in order of waveband.

3 Press **PRESET** **◀/▶** until the desired preset station is displayed.

Tip

Detailed playback features and additional functions are described in the accompany owner's manual.

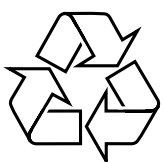

Free Manuals Download Website

<http://myh66.com>

<http://usermanuals.us>

<http://www.somanuals.com>

<http://www.4manuals.cc>

<http://www.manual-lib.com>

<http://www.404manual.com>

<http://www.luxmanual.com>

<http://aubethermostatmanual.com>

Golf course search by state

<http://golfingnear.com>

Email search by domain

<http://emailbydomain.com>

Auto manuals search

<http://auto.somanuals.com>

TV manuals search

<http://tv.somanuals.com>