

DVD Recorder

DVDR610
DVDR615
DVDR616

User manual

Visit us at www.p4c.philips.com for service support

Make your own DVD

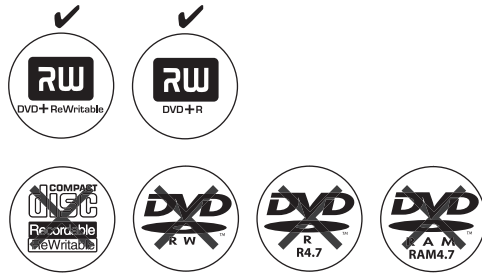

SHOWVIEW[®]

PHILIPS

Connecting DVD Recorder + TV + Cable Box + VCR or DVD player

1 First, connect your DVD recorder to your TV set and Cable Box or antenna.

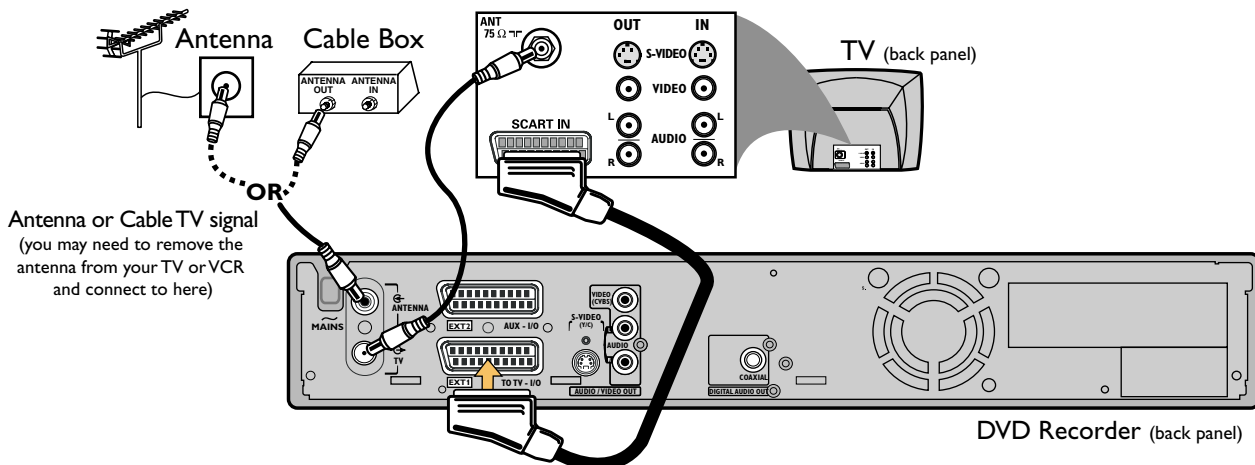

2 Then, select one of the options below to connect your VCR or DVD player.

a If your VCR or DVD player has SCART connector :

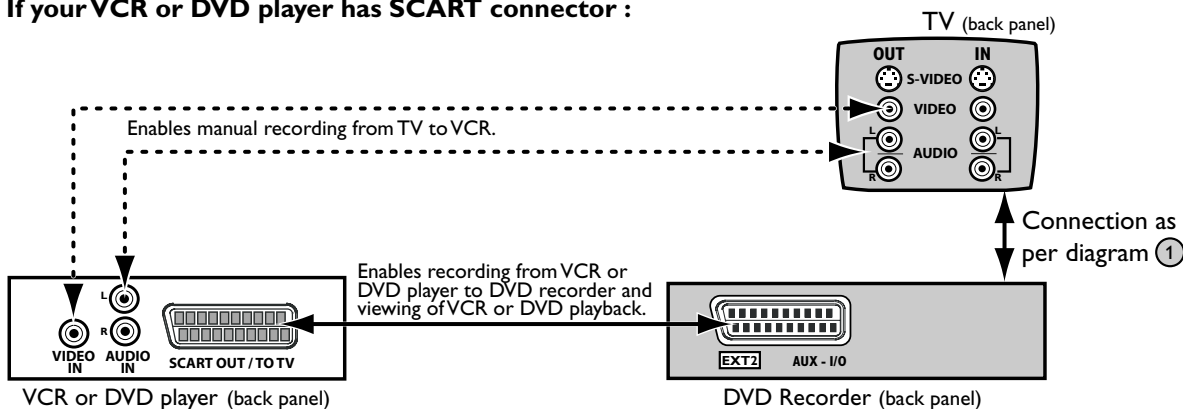

b If your VCR or DVD player does not have SCART connector :

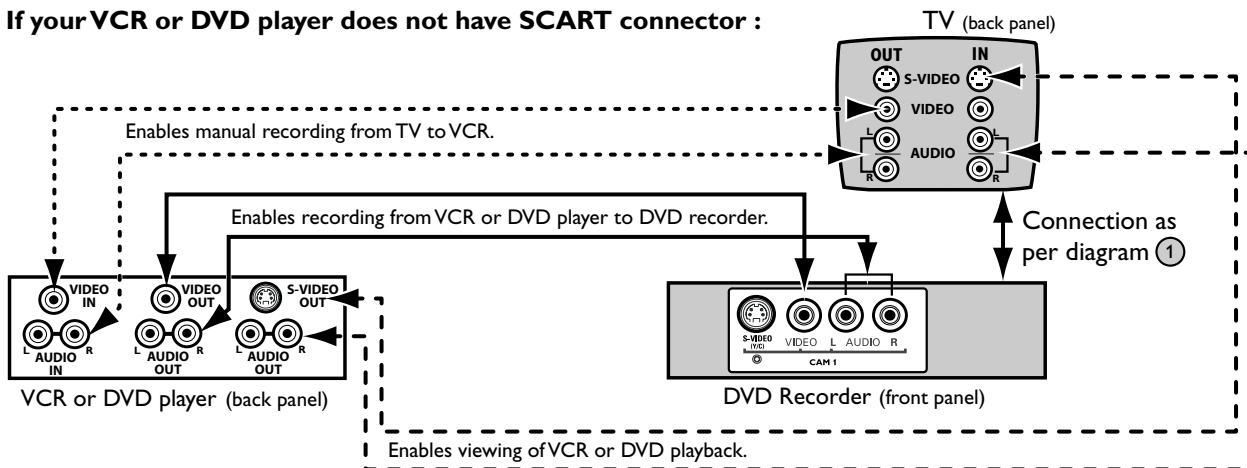

HELPFUL HINT:

The connections between VCR and TV shown on the above diagrams are for reference only. Refer to the table below for others possible connections if the same sockets are available on both sets of devices.

	VCR	TV
Playback	SCART OUT	SCART IN
	S-VIDEO OUT and AUDIO OUT	S-VIDEO IN and AUDIO IN
	VIDEO OUT and AUDIO OUT	VIDEO IN and AUDIO IN
Recording	SCART IN	SCART OUT
	S-VIDEO IN and AUDIO IN	S-VIDEO OUT and AUDIO OUT
	VIDEO IN and AUDIO IN	VIDEO OUT and AUDIO OUT

WARNING!
Recording from VCR or DVD player to DVD Recorder may not be possible due to copy protection.

Continued ...

If you wish to connect your cable box TV signal to your VCR, follow the connections below.

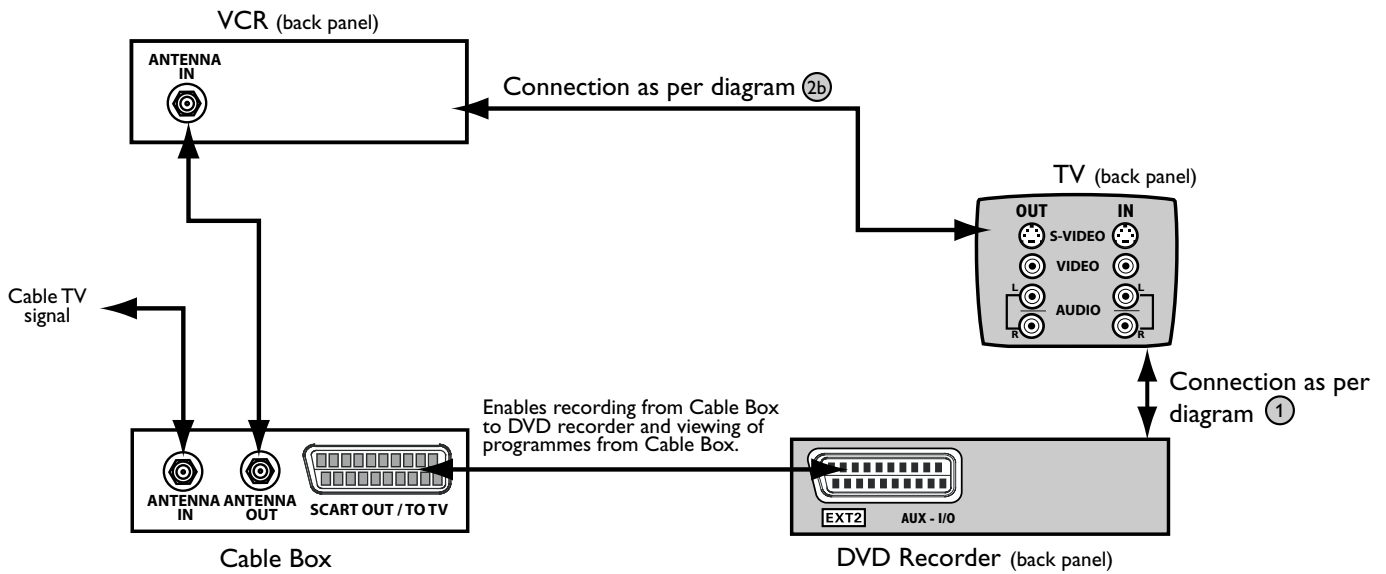

HELPFUL HINT:

To record from Cable Box's channel to your DVD recorder, you have to select the channel from the Cable Box directly. In this case, ShowView/Video Plus+ programme recording is not possible.

If you wish to connect an amplifier/receiver :

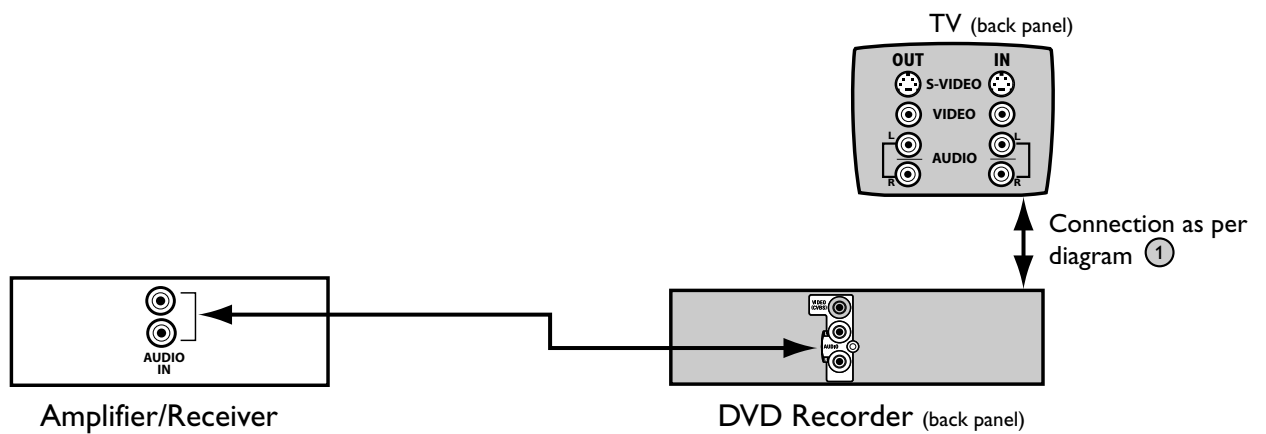

Important notes for users in the U.K.

Mains plug

This apparatus is fitted with an approved 13 Amp plug. To change a fuse in this type of plug proceed as follows:

- 1 Remove fuse cover and fuse.
- 2 Fix new fuse which should be a BS1362 5 Amp, A.S.T.A. or BSI approved type.
- 3 Refit the fuse cover.

If the fitted plug is not suitable for your socket outlets, it should be cut off and an appropriate plug fitted in its place.

If the mains plug contains a fuse, this should have a value of 5 Amp. If a plug without a fuse is used, the fuse at the distribution board should not be greater than 5 Amp.

Note: The severed plug must be disposed of to avoid a possible shock hazard should it be inserted into a 13 Amp socket elsewhere.

How to connect a plug

The wires in the mains lead are coloured with the following code: blue = neutral (N), brown = live (L).

- As these colours may not correspond with the colour markings identifying the terminals in your plug, proceed as follows:
 - Connect the blue wire to the terminal marked N or coloured black.
 - Connect the brown wire to the terminal marked L or coloured red.
 - Do not connect either wire to the earth terminal in the plug, marked E (or \perp) or coloured green (or green and yellow).

Before replacing the plug cover, make certain that the cord grip is clamped over the sheath of the lead - not simply over the two wires.

Copyright in the U.K.

Recording and playback of material may require consent. See Copyright Act 1956 and The Performer's Protection Acts 1958 to 1972.

CAUTION

Use of controls or adjustments or performance of procedures other than herein may result in hazardous radiation exposure or other unsafe operation.

Due to the inconsistency of disc formats provided by various disc manufacturers, your DVD system/ player/recorder may require a playability enhancement or upgrade. As DVD technology advances, these enhancement will become common and will be easy to complete. Go to www.p4c.philips.com for software upgrade.

For Customer Use:

Read carefully the information located at the bottom or rear of your DVD Recorder and enter below the Serial No. Retain this information for future reference.

Model No. DVD RECORDER DVDR610 / DVDR615 / DVDR616

Serial No. _____

LASER

Type	Semiconductor laser InGaAlP (DVD) AlGaAs (CD)
Wave length	658 nm (DVD) 790 nm (CD)
Output Power	30 mW (DVD+RW write) 1.0 mW (DVD read) 1.0 mW (CD read)
Beam divergence	84 degrees (DVD) 61 degrees (CD)

This product complies with the radio interference requirements of the European Community.



Manufactured under license from Dolby Laboratories. "Dolby"

and the double-D symbol are trademarks of Dolby Laboratories.



This product complies with the requirements of the following directives and guidelines: 73/23/EEC + 89/336/EEC + 93/68/EEC

CAUTION

VISIBLE AND INVISIBLE LASER RADIATION WHEN OPEN AVOID EXPOSURE TO BEAM

ADVARSEL

SYNLIG OG USYNLIG LASERSTRÅLING VED ÅBNING
UNDGÅ UDSÆTTELSE FOR STRÅLING

VARNING

SYNLIG OCH OSYNLIG LASERSTRÅLNING NÄR DENNA DEL ÄR ÖPPNAD BETRakta EJ STRÅLEN

VARO!

AVATTAESSA OLET ALTTIINA NÄKYVÄLLE JA NÄKYMÄTTÖMÄLLE LASER SÄTEILYLLE. ÄLÄ KATSO SÄTEESEEN

VORSICHT

SICHTBARE UND UNSICHTBARE LASERSTRAHLUNG WENN ABDECKUNG GEÖFFNET NICHT DEM STRAHL AUSSETZEN

ATTENTION

RAYONNEMENT LASER VISIBLE ET INVISIBLE EN CAS D'OUVERTURE EXPOSITION DANGEREUSE AU FAISCEAU

Notes

English

Special Functions

Your PHILIPS DVD recorder has a number of special functions that will make day-to-day use of your new DVD recorder easier for you.



Using the 'Digital Photo Manager', you can view and modify JPEG pictures from a Picture CD, DVD, or a CD ROM. You can create slide shows and play them on a DVD player (*for DVDR615 and DVDR616 only*).



This function automatically transfers all the television channel settings onto your DVD recorder via the scart cable (**EXT1 TO TV-I/O** socket).

Direct Record

At the touch of a button, your DVD recorder will check which channel is currently playing on your television set and record it even if it is in Standby mode.



This connection is also known as 'FireWire' and 'IEEE 1394.' This connection is used for the transfer of high bandwidth digital signals as used by digital video (DV) camcorders. Audio and video signals are transmitted using an i-Link cable. In addition to DV and Hi8 camcorders, some personal computers with digital video output can also be connected to this digital input (*for DVDR615 and DVDR616 only*).



This product incorporates copyright protection technology that is protected by method claims of certain US patents and other intellectual property rights owned by Macrovision Corporation and other rights owners. Use of this copyright protection technology must be authorized by Macrovision Corporation, and is intended for home and other limited viewing uses only unless otherwise authorized by Macrovision Corporation. Reverse engineering or disassembly is prohibited.

SHOWVIEW

This is a simple programming system for DVD recorders. To use it, enter the programming number associated with your television programme. You can find this number in your favourite listings magazine.

SHOWVIEW is a registered trademark of Gemstar Development Corporation. SHOWVIEW is manufactured under license from Gemstar Development Corporation.

Table of Contents

Special Functions 5

Care and Safety Information

Setup	8
Cleaning discs	8
About recycling	8

General Information

Introduction	9
Accessories supplied	9
Region codes	9

Connecting to TV

General	10
Selecting a suitable connection to your TV	10
Setting the TV to the correct video in channel	10
Option 1 : Using SCART socket	11
Option 2 : Using S-Video (Y/C) socket	12
Option 3 : Using Video (CVBS) socket	13

Connecting to Additional Devices

Using second SCART socket (EXT2-AUX-I/O)	14
Connecting a Cable Box/Decoder	14
Connecting a VCR/DVD player	14
Connecting a camcorder to the front sockets	15
Option 1: Using DV In socket	15
Option 2: Using S-VIDEO In or VIDEO In socket	15
Using analogue audio output sockets ...	16
Using digital audio output socket	16

Front Panel 17

Sockets behind the flap	17
-------------------------------	----

Remote Control 18-19

Inserting batteries	20
Using the remote control to operate the system	20
Using the alphanumeric keypad to enter the characters	20

Installing the DVD Recorder

First Installation	21-22
TV channel programming	23
Automatic TV channel search	23
Sorting TV channels according to TV sequence	23-24
Sorting the TV channels	24
Setting favourite TV channels	25
Manual TV channel search	25-26
Allocating a decoder	26
Fine tuning the TV channels	27
Setting the time and date	27
Setting the language	28

Playback

Playable discs	29
Inserting a disc	29
Starting disc playback	30
Playing a DVD video disc	30
Playing a (Super) Video CDs	30
Playing an audio CDs	30
Playing a DVD+R(W)	31
Playing an MP3 CD	31
Playing a picture disc (slide show)	31
Supported JPEG picture formats	31

Additional Playback Features

Using Toobal options	32
Changing subtitle language	32
Changing audio soundtrack language	33
Switching camera angles	33
Zooming in	33
Time search	33
Changing to another title/chapter/track	34
Searching forwards/backwards	34
Pausing playback / slow motion play	34
Selecting various play mode	35
Repeat play	35
Repeating a specific segment (A-B)	35
Shuffle play	35
Scan disc	35

Table of Contents

Recording

Discs for recording	36
Recording settings	36
Recording mode	37
Recording language	37
Inserting chapter markers	37
Direct record function	38
Filter mode	38
Manual recording	38-39
Manual recording with automatic turn-off (one touch recording)	39
Direct recording	40
Deleting a recording	40

Timer Recording

Introduction	41
Programming recordings	41-42
Programming recording from a Cable Box	42
Programming recordings with ShowView® System	43
Changing a programmed recording	44
Deleting a programmed recording	44

Editing/Finalising Recording

About editing	45
Colour coded buttons functions	45
Index Picture screen	45
Changing the disc/title name	46
Making the editing compatible (DVD+RW)	46
Finalising disc (DVD+R)	46
Video editing	47
Hiding unwanted chapter	47
Editing chapter (merge/split/hide)	48
Editing title (divide/append/ index picture)	48-49
Deleting chapter markers	49
Photo editing	49

Using the Browser

Browsing the disc	50
Colour coded buttons functions	50
Browsing the picture disc	51
Adding pictures to an album	51
Changing the picture order within an album	52
Deleting an album	52
Deleting picture in an album	52
Changing the slide show settings	53
Protecting the recorded title (DVD+RW)	53

System Menu - Preferences

Accessing to the Preferences options ..	54
Recording	54
Sound	54
Disc	55
Access	55
Features	55

System Menu - Setup

Accessing to the Setup options	56
System	56-57
Time-date	57
Analogue channels	57
Video output	57-58
Audio output	58
Language	58

Setting Access Control

About Access Control	59
Setting or changing the pin code	59
Activating/Deactivating the child lock ..	59
Authorising discs	60

Troubleshooting

Display panel symbols/ messages

Specifications

Glossary

TV System Guide

Care and Safety Information

CAUTION!

High voltage! Do not open.
You run the risk of getting an electric shock.

The machine does not contain any user-serviceable parts. Please leave all maintenance work to qualified personnel.

Setup

Finding a suitable location

- Place the set on a flat, hard and stable surface. Do not place the set on a carpet.
- Do not position the set on top of other equipment that might heat it up (e.g., receiver or amplifier).
- Do not put anything under the set (e.g., CDs, magazines).

Space for ventilation

- Place the apparatus in a location with adequate ventilation to prevent internal heat build up. Allow at least 10 cm (4.5") clearance from the rear and the top of the set and 5 cm (2.3") from the left and right to prevent overheating.

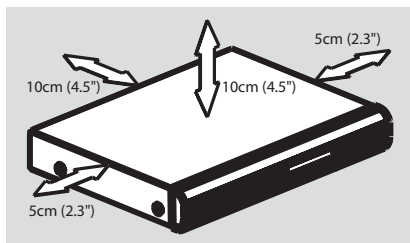

Avoid high temperatures, moisture, water and dust

- Apparatus shall not be exposed to dripping or splashing.
- Do not place any sources of danger on the apparatus (e.g., liquid filled objects, lighted candles).

Cleaning discs

Some problems occur because the disc inside the recorder is dirty (frozen picture, sound disruptions, picture distortions). To avoid these problems, discs should be cleaned on a regular basis.

To clean a disc, use a micro fibre cleaning cloth and wipe the disc from the center to the edge in a straight line.

CAUTION!

Do not use solvents such as benzene, thinner, commercially available cleaners, or anti-static sprays intended for discs.

Since the optical unit (laser) of the DVD recorder operates at a higher power than regular DVD or CD players, cleaning CDs intended for DVD or CD players may damage the optical unit (laser). Therefore, refrain from using a cleaning CD.

About recycling

These operating instructions have been printed on non-polluting paper. This electronic equipment contains a large number of materials that can be recycled. If you are disposing of an old machine, please take it to a recycling centre. Please observe the local regulations regarding disposal of packaging materials, exhausted batteries, and old equipment.

General Information

Introduction

Your Philips DVD recorder allows you to record the TV programmes or duplicate camcorder recordings to a DVD+RW or DVD+R and play pre-recorded DVDs. The recordings you make on the Recorder will play on some DVD players and DVD-ROM drives. The DVD+R discs have to be finalised before they can be played on other DVD players.

Please take the time to read this user manual before using your DVD recorder. It contains important information and notes regarding operation.

Helpful Hints:

- *If you have questions or if problems come up during operation, please see the chapter 'Troubleshooting'.*
- *If you need further assistance, please call the customer support service for your country. The corresponding telephone numbers and e-mail addresses are given in the guarantee booklet.*

Accessories supplied

- Remote control and batteries
- Scart cable
- Antenna cable
- Quick Use Guide

Region codes

DVD films are usually not released at the same time in all regions of the world, thus all DVD players/recorders are keyed to a specific region code.

This device will only play **Region 2** DVDs or DVDs manufactured to be played in all regions ('**ALL**'). DVDs from other regions cannot be played on this DVD recorder.



Connecting to TV

General

The necessary cable connections must be made before you can record or playback TV programmes using your DVD recorder.

Selecting a suitable connection to your TV

When you install your DVD recorder for the first time, select **one** of the following options to connect the DVD recorder and your TV.

- **Option 1: Using Scart socket**
Select this if your TV is equipped with a scart socket. It provides the best picture quality (see pages 11).
- **Option 2: Using S-Video (Y/C) socket**
Select this if your TV is equipped with a S-Video (SVHS) socket. It provides excellent picture quality (see page 12).
- **Option 3: Using Video (CVBS) socket**
Select this if your TV is equipped with a Video (CVBS) socket. It provides good picture quality (see page 13).

Setting the TV to the correct video in channel

- ① Press **STANDBY-ON**  on the DVD recorder to turn it on.
- ② Turn on the TV and set it to the correct video-in channel. You should see the blue DVD background screen or the first installation screen on the TV.
 - Usually this channel is between the lowest and highest channels and may be called FRONT, A/V IN, VIDEO. See your TV's manual for more details.
 - Or, you may go to channel 1 on your TV, then press the Channel down button repeatedly until you see the Video In channel.
 - Or, the TV remote control may have a button or switch that chooses different video modes.

IMPORTANT!

When you complete the connections and turn on the DVD recorder for the first time, you must complete the First Installation. This set up TV channels, menu languages and other features (see pages 21-22).

Option 1: Using SCART socket

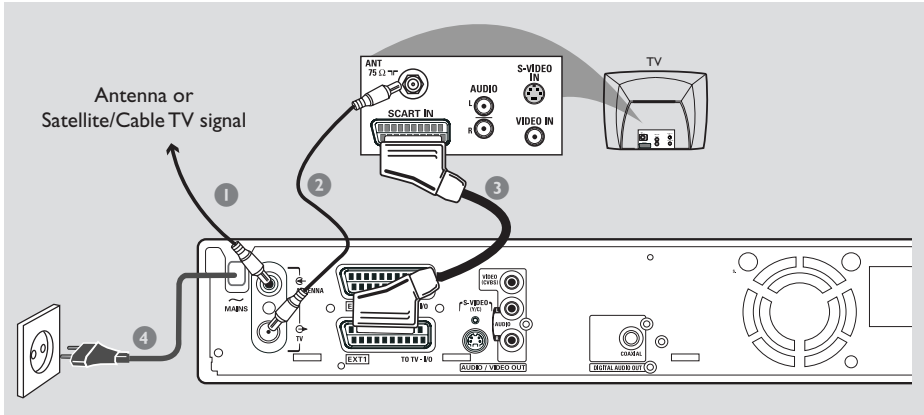

The scart or Euro AV cable serves as the universal connector for picture, sound and control signals. With this type of connection, there is practically no loss of quality in picture or sound transmission.

Have the following cables ready:

- 1) Antenna cable
- 2) SCART cable

- 1 Turn off your TV and remove the antenna cable from your TV (or Satellite Receiver/Cable Box). Insert it into the **ANTENNA IN** socket at the back of the DVD recorder.
- 2 Use the supplied antenna cable to connect the DVD recorder's **TV OUT** socket to the antenna input socket at the back of your TV set.
- 3 Use a SCART cable to connect the DVD recorder's **EXT 1 (TO TV-I/O)** socket to the SCART socket at the back of your TV set.
- 4 Connect the power cable from the DVD recorder's ~ **MAINS** to the power supply.

- 5 Press **STANDBY-ON**  on the DVD recorder to turn it on.

→ The message 'IS THE TV ON?' appears on the display panel.

- 6 Turn on the TV power.

→ If the connection has properly made, your TV will automatically turn on to the Video Input channel for the SCART socket and you should see the { **Language and Country** } menu appears on the TV.

→ If not, select the correct Video In channel at the TV manually until you see the { **Language and Country** } menu.

- 7 Proceed to **page 21** to continue the first installation.

Helpful Hints:

- If your TV set has several SCART sockets, select the SCART socket that is suitable for both video output and video input.
- If your TV set displays a selection menu for the SCART socket, select 'VCR' as the source for the SCART socket.
- The EXT 2 AUX-I/O socket is intended only for additional devices.

Connecting to TV (cont'd)

Option 2: Using S-Video (Y/C) socket

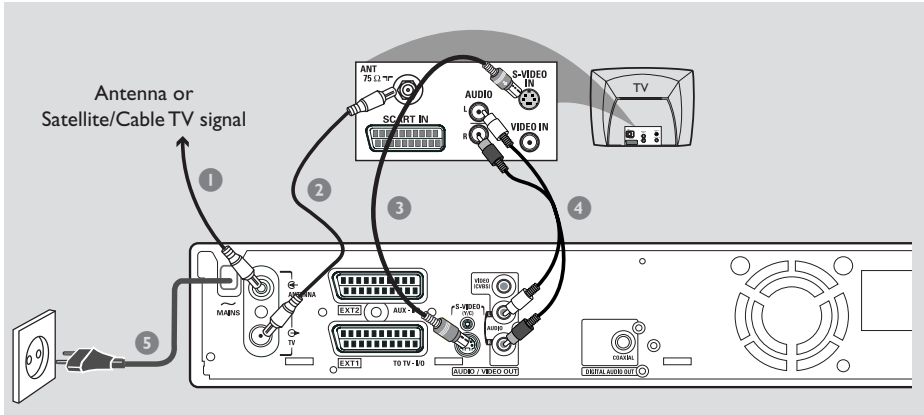

This connecting cable, also known as the SVHS cable, is used to transmit the brightness signal (Y signal) and colour signal (C signal) separately. This mini DIN socket is also called a Hosiden jack.

Have the following cables ready:

- 1) Antenna cable
- 2) S-Video (SVHS) cable (not supplied)
- 3) Audio cables (red/white, not supplied)

- 1 Turn off your TV and remove the antenna cable from your TV (or Satellite Receiver/ Cable Box). Insert it into the **ANTENNA IN** socket at the back of the DVD recorder.
- 2 Use the supplied antenna cable to connect the DVD recorder's **TV OUT** socket to the antenna input socket at the back of your TV set
- 3 Use an S-Video (SVHS) cable to connect the DVD recorder's **S-VIDEO (Y/C) OUT** socket to the S-Video In socket at the back of your TV set (or labelled as S-Video In or SVHS).

- 4 Use an audio cable (red/white) to connect the DVD recorder's **AUDIO L/R OUT** socket to the audio input socket at the back of your TV set (or labelled as AV In or Audio In).
- 5 Connect the power cable from the DVD recorder's **~ MAINS** to the power supply.
- 6 Press **STANDBY-ON**  on the DVD recorder to turn it on.
→ The message 'IS THE TV ON?' appears on the display panel.
- 7 Turn on the TV power. Select the correct Video In channel at the TV (see page 10).
→ The first installation menu { **Language and Country** } will appear on the TV.
- 8 Proceed to **page 21** to continue the first installation.

Option 3 : Using Video (CVBS) socket

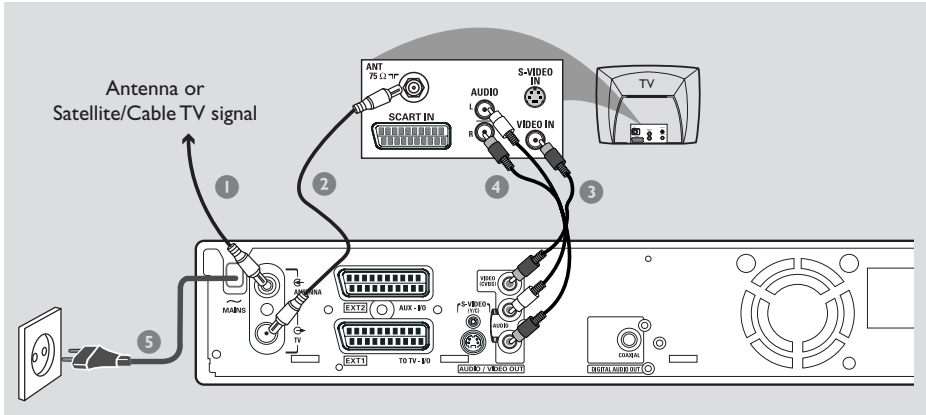

This cable, usually featuring yellow cinch plugs, is used for transmitting the Composite Video signal (FBAS, CVBS). In this method of transmission, the colour signal and the brightness signal are transmitted on the same cable.

Have the following cables ready:

- 1) Antenna cable
- 2) Video (CVBS) cable (yellow, not supplied)
- 3) Audio cables (red/white, not supplied)

- 1 Turn off your TV and remove the antenna cable from your TV (or Satellite Receiver/ Cable Box). Insert it into the **ANTENNA IN** socket at the back of the DVD recorder.
- 2 Use the supplied antenna cable to connect the DVD recorder's **TV OUT** socket to the antenna input socket at the back of your TV set.
- 3 Use a video (CVBS) cable to connect the DVD recorder's **VIDEO (CVBS) OUT** socket to the Video In socket at the back of your TV set (or labelled as Video In, AV In or Composite).

- 4 Use an audio cable (red/white) to connect the DVD recorder's **AUDIO L/R OUT** socket to the audio input socket at the back of your TV set (or labelled as AV In or Audio In).
- 5 Connect the power cable from the DVD recorder's ~ **MAINS** to the power supply.
- 6 Press **STANDBY-ON**  on the DVD recorder to turn it on.
→ The message 'IS THE TV ON?' appears on the display panel.
- 7 Turn on the TV power. Select the correct Video In channel at the TV (see page 10).
→ The first installation menu { **Language and Country** } will appear on the TV.
- 8 Proceed to **page 21** to continue the first installation.

Connecting to Additional Devices

Using second SCART socket (EXT2-AUX-I/O)

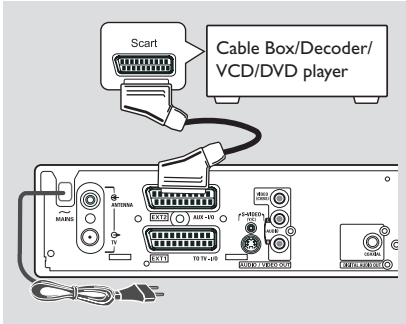

You can connect a video cassette recorder (VCR), DVD player, decoder, satellite receiver or cable box to **EXT 2 AUX-I/O** socket at the back of the DVD recorder.

When playback is started on this additional device, the DVD recorder will automatically send the video/audio signals from **EXT 2 AUX-I/O** socket to **EXT 1 TO TV-I/O** socket. You will then see the picture from the additional device on your TV, even if the DVD recorder is turned off (only if you have connected your TV via **EXT 1 TO TV-I/O** socket, see page 11).

To switch between playback from the additional devices and playback from the DVD recorder

- Press **TV/DVD** on the remote control.

Connecting a Cable Box/Decoder

If your Cable Box/Decoder has a scart socket, you can choose to connect it to the second scart socket.

- 1 Use a scart cable to connected the Cable Box/Decoder scart socket (usually labelled as 'TV' or 'TO TV') to **EXT 2 AUX-I/O** socket at the back of the DVD recorder.
- 2 Select the TV channels to be received by the Cable Box directly on the receiver itself.

Connecting a VCR/DVD player

You will need this connection if you want to record the video tapes or discs to a DVD+R(W)s.

- Use a scart cable to connect the scart socket (usually labelled as 'SCART OUT' or 'TO TV') of the VCD/DVD player to **EXT 2 AUX-I/O** socket.
- Alternatively, you can choose to connect via the front sockets of the DVD recorder if your VCR/DVD player have the same output sockets.
→ Before start operating, select 'CAM 1' as the input channel. For recording, see pages 38~39.

- 1) Connect to **S-VIDEO** input socket and **AUDIO L/R** input sockets.

OR

- 2) Connect to **VIDEO** input socket and **AUDIO L/R** input sockets.

Helpful Hint:

– Most prerecorded video cassettes and DVDs are copy-protected. If you try to copy them, the message 'COPY PRO' appears on the display panel.

Connecting Additional Devices (cont'd)

Connecting a camcorder to the front sockets

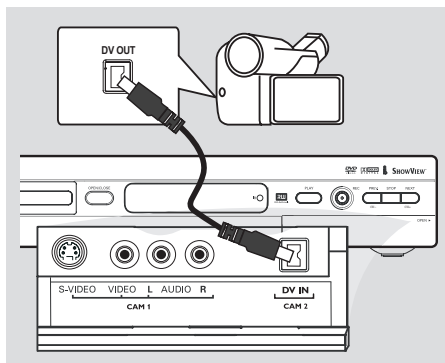

You can use the front sockets to copy camcorder recordings. These sockets are located behind the flap on the right hand side.

Option 1: Using DV IN socket

(for DVDR615 and DVDR616 only)

Use this connection if you have a Digital Video or Digital 8 camcorder. The DV socket will conform to the i.Link standard. It provides the best picture quality.

- Use an i.LINK 4-pin cable to connect the DVD recorder's **DV IN** socket to the appropriate DV output socket on the camcorder.

Before start operating, select '**CAM 2**' as the input channel.

For recording, see pages 38~39.

Helpful Hints:

- You can also use the DV IN to connect the DVD recorder to a Personal Computer that has a DV output socket. The PC must have an IEEE 1394 Firewire connector.
- The DV socket on this recorder can only receive input signals, it cannot output signals.

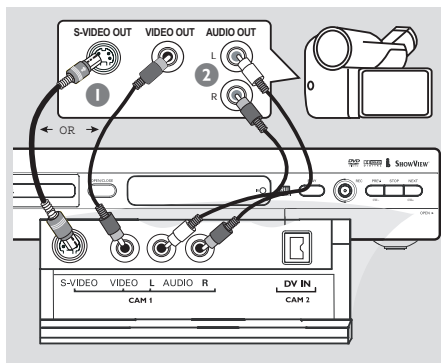

Option 2: Using S-VIDEO In or VIDEO In socket

Use S-VIDEO connection if you have a Hi8 or S-VHS(C) camcorder. It provides very good picture quality.

Alternatively, you can use VIDEO connection if your camcorder has only a single video output (Composite Video, CVBS). It provides good picture quality.

- 1 Use a S-video cable to connect the DVD recorder's **S-VIDEO** input socket to the appropriate S-VHS output socket on the camcorder.

OR

Use a video cable (yellow) to connect the DVD recorder's **VIDEO** input socket to the appropriate video output socket on the camcorder.

- 2 Use an audio cable (red/white) to connect the DVD recorder's **AUDIO L/R** input socket to the audio output socket on the camcorder.

Before start operating, select '**CAM 1**' as the input channel.

For recording, see pages 38~39.

Connecting to Additional Devices (cont'd)

Using analogue audio output sockets

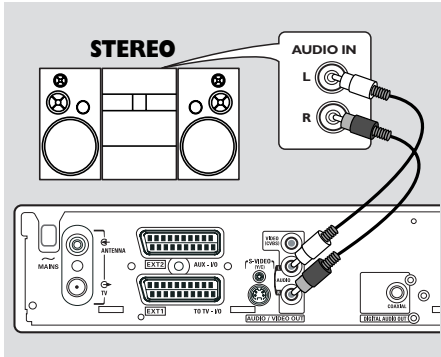

You can connect the DVD recorder to a two channel stereo system or receiver in order to enjoy the stereo sound system.

- Use an audio cable (red/white) to connect **AUDIO L/R** (red/white) to one of the following devices :
 - a stereo system (for example, mini system or TV)
 - a receiver with Dolby Surround Pro Logic
 - a receiver with two channel analogue stereo

Before start operating, set the Analogue Output accordingly (see page 54). Choose a sound mode setting that is most compatible with the connected devices.

CAUTION!

Do not use the 'Phono' input on an amplifier to connect to the DVD recorder. This input socket is designed only for record players without preamplifiers. The DVD recorder or the amplifier may be damaged as a result.

Using digital audio output socket

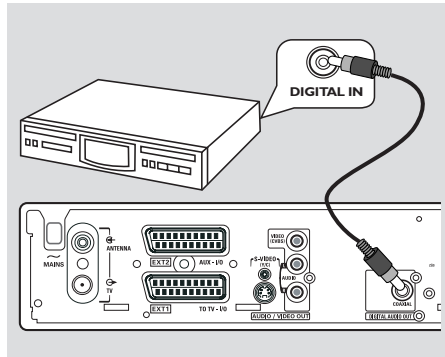

You can connect the DVD recorder to a A/V receiver or amplifier in order to enjoy the home theatre system's surround sound capabilities.

- Use a coaxial cable to connect **COAXIAL** to one of the following devices :
 - an A/V receiver or an A/V amplifier with a digital multi-channel sound decoder
 - a receiver with two channel digital stereo (PCM)

Before start operating, set the Digital Output accordingly (see page 58). If the Digital Output setting does not match your stereo's capabilities, the stereo may produce a strong, distorted sound or no sound at all.

Helpful Hints:

- Digital multi-channel sound offers the best possible sound quality. You will need a multi-channel A/V receiver or amplifier that supports at least one of the audio formats of the DVD recorder (MPEG2, Dolby Digital). See your receiver's manual to find out which audio formats it supports.
- Playback in six-channel digital surround sound is only possible if the receiver has a digital multi-channel sound decoder.

Front Panel

English

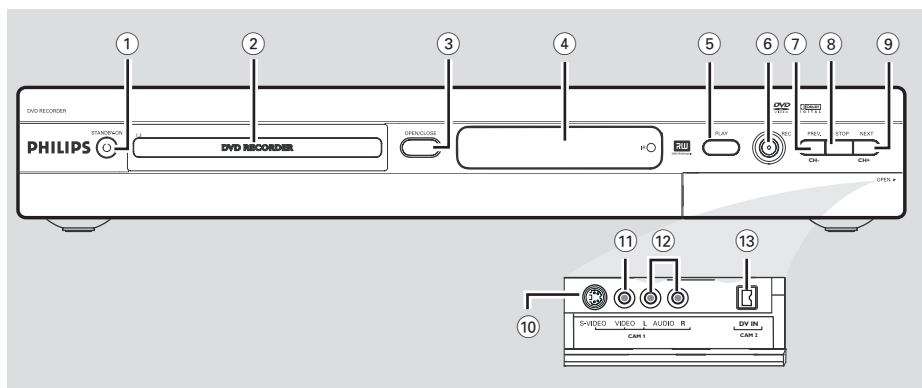

- ① **STANDBY-ON**
- Turn on or off the DVD recorder.
- ② **Disc tray**
- ③ **OPEN/CLOSE**
- Open or close the disc tray.
- ④ **Display panel**
- Show information about the current status of the DVD recorder.
- ⑤ **PLAY**
- Play a disc.
- ⑥ **REC**
- Start recording the current TV channel or the current video input source.
- ⑦ **PREV/CH-**
- Go to the previous chapter/track, do a reverse search, or go to the previous channel.
- ⑧ **STOP**
- Stop playback/recording.
- ⑨ **NEXT/CH+**
- Go to the next chapter/track, do a forward search, or go to the next channel.

Sockets behind the flap

Flip down the door as indicated by the **OPEN** label at the right hand corner.

- ⑩ **S-VIDEO**
- S-video input for SVHS/Hi8 camcorders or SVHS/Hi8 video recorders (input channel number 'CAM 1').
- ⑪ **VIDEO**
- Video input for camcorders or video recorders (input channel number 'CAM 1').
- ⑫ **L/R AUDIO**
- Audio input for camcorders or video recorders (input channel number 'CAM 1').
- ⑬ **DV IN** (for DVDR615, DVDR616 only)
- Input for digital camcorders or other suitable devices using this connector (input channel number 'CAM 2').

Remote Control

English

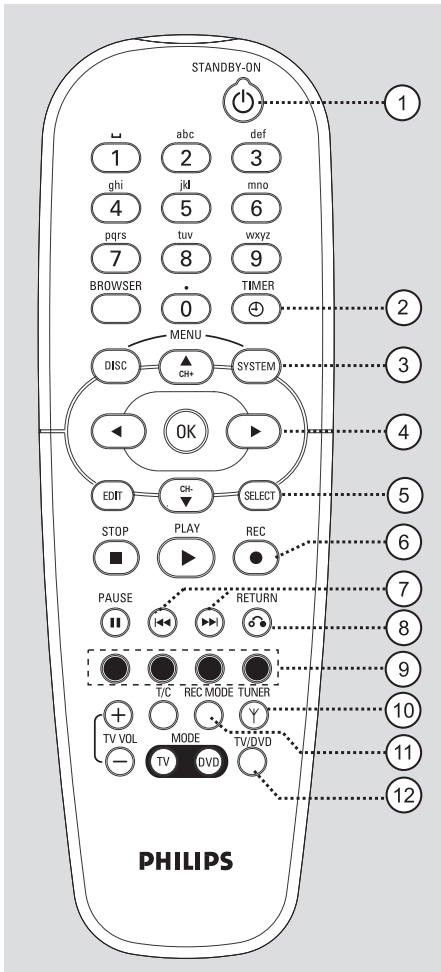

- ① **STANDBY-ON**
 - Turn on or off the DVD recorder.
- ② **TIMER**
 - Access or exit the timer recording menu.
- ③ **SYSTEM-MENU**
 - Access or exit the system menu.

- ④ : Cursor buttons for moving to the left or right.
 : Cursor buttons for moving up/down or going to the next/previous channel.
- ⑤ **SELECT**
 - Select a function.
 - Toggle between upper and lower case characters while using the alphanumeric keypad.
- ⑥ **REC**
 - Start recording the current TV channel or the current video input source.
- ⑦
 - Skip to the previous or next Chapter/Track.
 - Holding down the button for fast reverse or fast forward function.
- ⑧ **RETURN**
 - Return to the previous menu on a video CD (VCD) or some DVDs.
- ⑨ **Colour coded buttons**
 - A number of functions are available via the colour coded button. These functions are displayed in the bottom of the on-screen menu wherever applicable.
- ⑩ **TUNER**
 - Switch between the internal tuner mode (TV programmes, external channels).
- ⑪ **REC MODE**
 - Select a recording speed : M1, M2, M2x, M3, M4, M6 or M8. This determines the quality of the recording and the amount/length of time you can record on a DVD+R(W).
- ⑫ **TV/DVD**
 - Switch between playback from the additional devices (connected via EXT 2 AUX-I/O socket) and playback from the DVD recorder.

Remote Control (cont'd)

- ⑬ **Alphanumeric keypad**
 - Enter numbers or letters in appropriate entry fields.
 - Select a chapter/track number to play.
 - Select a TV channel while in internal tuner mode.
- ⑭ **BROWSER**
 - Display the on-screen Media Browser that allows you to browse through and manage the contents stored in the currently loaded disc.
- ⑮ **DISC-MENU**
 - Access to DVD's disc menu or Index Picture screen of a DVD+R(W).
- ⑯ **OK**
 - Store or confirm an entry.
- ⑰ **EDIT**
 - Access or exit the edit menu.
- ⑱ **STOP ■**
 - Stop playback/recording.
 - Holding down the button will open or close the disc tray.
- ⑲ **PLAY ►**
 - Play a disc.
- ⑳ **PAUSE II**
 - Pause the playback or recording.
 - Press repeatedly to advance a paused picture one frame at a time.
- ㉑ **T/C (Title/Chapter)**
 - Select a 'T'(title)/'C'(chapter) directly on the menu bar.
- ㉒ **TVVOL + / -**
 - Adjust the volume of the TV set (for Philips TV with RC5 code only).
- ㉓ **DVD MODE**
 - Switch to DVD source mode. After that, you cannot use the buttons on the remote control to operate your Philips TV.

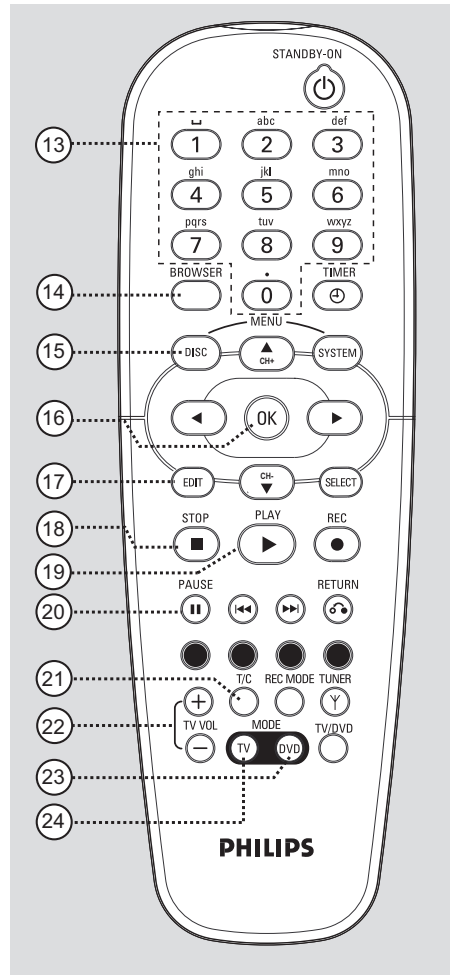

- ㉔ **TV MODE**
 - Switch to TV source mode. After that, you may use the following buttons to control most of the Philips TV set:
 - **STANDBY** : Turn off the TV set.
 - **0-9**: Press to select a TV channel at the TV.
 - **▲ ▼**: Press to change TV channels at the TV.

Remote Control (cont'd)

Inserting Batteries

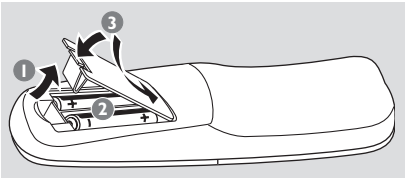

- 1 Open the battery compartment.
- 2 Insert two batteries type R06 or AA, following the indications (+-) inside the compartment.
- 3 Close the cover.

Caution!

- Remove batteries if they are exhausted or if the remote control is not to be used for a long time.
- Do not mix batteries (old and new or carbon and alkaline, etc.).
- Batteries contain chemical substances, so they should be disposed of properly.

Using the remote control to operate the system

- 1 Aim the remote control directly at the remote sensor (iR) on the front panel.
- 2 Select the source you wish to control by pressing one of the source select buttons on the remote control (for example TV-MODE, DVD-MODE).
- 3 Then select the desired function (for example \lll , \ggg).

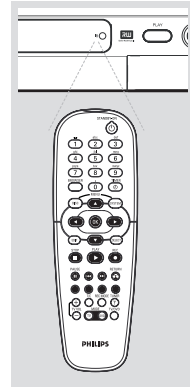

Using the alphanumeric keypad to enter the characters

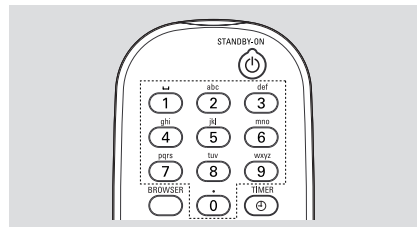

- Press a number button as often as the required character or the number appears.
- To enter language-dependent characters, press \lll or \ggg on the corresponding character.
- To enter a space, press button {1}.

Installing the DVD Recorder

First Installation

The First Installation menu will appear the very first time you turn on the DVD recorder. These settings will help you set up the basic DVD recorder features easily, including TV channels and language options.

IMPORTANT!

- You have to turn on your TV and select the correct Video In channel to see the First Installation menu.
- You have to complete the First Installation before start operating the DVD recorder.

- 1 Press **STANDBY-ON**  to turn on the DVD recorder.
→ The { **Language and Country** } menu appears on the TV.

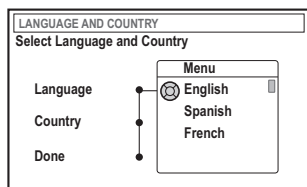

- 2 Select { **Language** } and press **▶**.
- 3 Press **▲▼** to select the desired language for the on-screen display (OSD) menu, then press **◀** to confirm.
- 4 Press **▼** to select { **Country** } and press **▶** to enter the selection field.
- 5 Press **▲▼** to select the country of your residence, then press **◀** to confirm.

- 6 Press **▼** to select { **Done** } and press **OK** to confirm.
→ The { **TV Format** } menu appears on the TV.

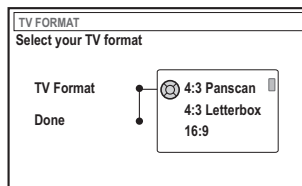

- 7 Select { **TV Format** } and press **▶**.



16:9



4:3 Letterbox

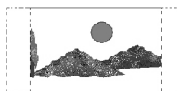

4:3 Panscan

- 8 Press **▲▼** to select the desired TV screen format, then press **◀** to confirm.
→ The format you selected will only be used if you insert a DVD that contains the same format.
- 9 Press **▼** to select { **Done** } and press **OK** to confirm.
→ The { **Channel Search** } menu appears on the TV.

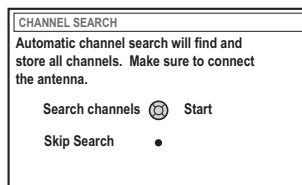

TIPS: Press **OK** to exit the first installation menu.
Press **RETURN** to go back to previous menu item.

Installing the DVD Recorder (cont'd)

Note: Make sure you have successfully made all the required connections to the DVD recorder, the TV and Satellite Receiver/Cable Box (if any) and switched them on. The automatic channel search will detect the signals and save all the available programme channels.

- 10 Press **OK** again to start automatic TV channel search.
→ The automatic search may take 15 minutes.
- 11 When TV channel search complete, press **OK** to continue.
→ The { **Time and Date** } menu appears on the TV.

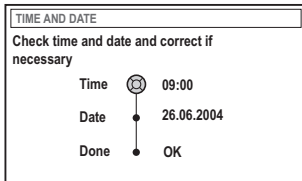

- 12 Check if the information on the menu is correct.
→ If required changes, follow steps 4~8 of "Setting the time and date" on page 27.
- 13 Press **▼** to select { **Done** } and press **OK** to save the changes.
→ The first installation is now complete.
→ The first tuned TV channel appears.

The DVD recorder is ready for use!

Helpful Hints:

- If the DVD recorder cannot find any TV stations, select programme number {1} on the TV set or check the cable connection from the antenna socket to the DVD recorder and TV set.
- If the sound or picture is distorted on any of the stored TV channels, see pages 23~27 "TV channel programming" for manual TV search or fine-tuning.

TIPS: Press **OK** to exit the initial installation menu.
Press **RETURN** to go back to previous menu item.

Installing the DVD Recorder (cont'd)

TV channel programming

Although the DVD recorder selects available TV channels during first installation, you may want to repeat the process later if more channels become available in your area or if you are reinstalling the DVD recorder.

Automatic TV channel search

This will erase and replace all previously stored TV channels.

- 1 Press **SYSTEM-MENU** on the remote control.
→ The system menu appears on the TV.
- 2 Press **▼** repeatedly to select { **Set-up** }.
- 3 Press **▶** repeatedly to select { **Analogue Ch.** }.

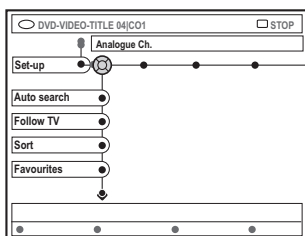

- 4 Press **▼** to select { **Auto search** } and press **▶** to confirm.
→ The automatic TV channel search starts. This allows the DVD recorder to save all available TV channels.
→ This process may take several minutes. Once complete, the total number of channels found appears on the TV.

Sorting TV channels according to TV sequence

This feature is only available if you have connected the DVD recorder to your TV using the scart socket (EXT 1 TO TV-I/O socket,) see page 11.

When the automatic TV channel search function is activated, the TV channels are stored in a specific order. This may differ from the order in which the TV channels appear on your TV. This function changes the order of the TV channels stored in your DVD recorder to match the order on the TV.

- 1 Press **SYSTEM-MENU**.
→ The system menu appears on the TV.
- 2 Press **▼** repeatedly to select { **Set-up** }.
- 3 Press **▶** repeatedly to select { **Analogue Ch.** }.
- 4 Press **▼** repeatedly to select { **Follow TV** } and press **▶** to start sorting.
- 5 Press **OK** to confirm the message on the TV.
→ 'TV 01' will appear on the display panel.
- 6 **Use the TV's remote control** to select programme number {1} on your TV set. Then, press **OK** on the DVD recorder's remote control.
→ If the DVD recorder finds the same TV channel as on the TV set, it stores it as 'P01'.
→ 'TV 02' will then appear on the display panel.

TIPS: Press **◀** to go back to previous menu item. Press **SYSTEM-MENU** to exit the menu.

Installing the DVD Recorder (cont'd)

- 7 Use the TV's remote control to select programme number {2} on the TV set. Then, press **OK** on the DVD recorder's remote control.
- 8 Repeat the above steps again until you have assigned all the TV channels.

Helpful Hints:

- If you cannot turn on your TV set to programme number {1}, and you have connected additional devices to the EXT 2 AUX-I/O socket, please disconnect these devices. Other connected devices may have switched the TV set to the programme number of the scart socket.
- If no video signal is received from the TV set, "NO TV" will appear.

Sorting the TV channels

You may not agree with the sequence in which the individual TV channels have been allocated to the programme numbers. You can use this function to rearrange all the stored TV channels.

- 1 Press **SYSTEM-MENU**.
→ The system menu appears on the TV.
- 2 Press **▼** repeatedly to select { **Set-up** }.
- 3 Press **▶** repeatedly to select { **Analogue Ch.** }.
- 4 Press **▼** repeatedly to select { **Sort** } and press **▶** to confirm.
→ A list of TV channel programmes appears.
- 5 Press **▲▼** to select the TV channel that you want to change, then press **OK** to select.

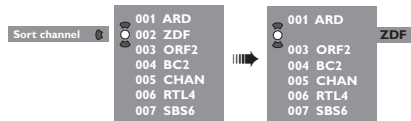

- 6 Press **▲▼** to shift the TV channel to the desired position and press **OK** to confirm.
→ The TV channel will be inserted after the current position.

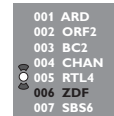

- 7 Repeat steps 5~6 until you have sorted/deleted all the TV channels you want.

TIPS: Press **◀** to go back to previous menu item. Press **SYSTEM-MENU** to exit the menu.

Installing the DVD Recorder (cont'd)

Setting favourite TV channels

You can set your favourite TV channels for quick access by using the channel up/down button on the remote control.

- 1 Press **SYSTEM-MENU**.
→ The system menu appears on the TV.
- 2 Press **▼** repeatedly to select { **Set-up** }.
- 3 Press **▶** repeatedly to select { **Analogue Ch.** }.
- 4 Press **▼** repeatedly to select { **Favourites** } and press **▶** to confirm.
→ A list of TV channel programmes appears.

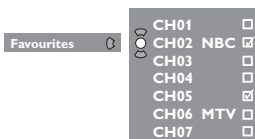

- 5 Press **▲▼** to select the TV channel, then press **OK** to choose either delete from or add to the list.
→ The 'add' channels are 'marked'.
You can access these channels by pressing **▲▼** on the remote control.
→ The 'delete' channels are 'unmarked'.
You can only access these channels by pressing the corresponding number button on the remote control.

Manual TV channel search

In some cases, not all of the available TV channels may have been found and stored during first installation. In this case, you will need to search for and store the missing or coded TV channels manually.

- 1 Press **SYSTEM-MENU**.
→ The system menu appears on the TV.
- 2 Press **▼** repeatedly to select { **Set-up** }.
- 3 Press **▶** repeatedly to select { **Analogue Ch.** }.

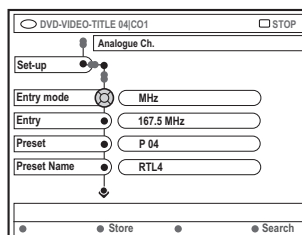

- 4 Press **▼** repeatedly to select { **Entry mode** } and press **▶** to confirm.
- 5 Press **▲▼** to select manual search based on channel allocation or frequency, and press **◀** to confirm.
 - { **MHz** } (Frequency)
 - { **CH** } (Channel)
 - { **S-CH** } (Special Channel)
- 6 Press **▼** to select { **Entry** } and press **▶** to confirm.
Use the **alphanumeric keypad 0-9** to enter the frequency or channel of the TV station, then press **OK** and followed by the matching colour coded button to select { **Store** }.
OR
 - Press the matching colour coded button on the remote control to select { **Search** }.
→ The search always goes by increasing frequency or channel number.

TIPS: Press **◀** to go back to previous menu item. Press **SYSTEM-MENU** to exit the menu.

Installing the DVD Recorder (cont'd)

- 7 Press ▼ to select { **Preset** } and press ► to confirm.
Use the **alphanumeric keypad 0-9** to enter the preset number for the channel to store (e.g., '01'), then press the matching colour coded button to select { **Store** }.
- 8 Press ▼ to select { **Preset name** } and press ► to confirm.
Use the **alphanumeric keypad 0-9** to enter the preset name for the found channel or preset, then press the matching colour coded button to select { **Store** }.
→ Maximum four characters for preset name.
- 9 Repeat steps 6~8 to search for other TV channels.
- 10 Press ▼ to select { **TV system** } and press ► to confirm.
Use ▲ ▼ to select the TV system that produces the least distortion of picture and sound, then press ◀ to confirm.
→ The available TV system broadcast format for selection : { PAL-BG, PAL-I, PAL-DK, SECAM-BG, SECAM-DK, SECAM-LL }. See pages 70~71 for more information.

Allocating a decoder

Some TV channels send coded TV signals that can only be viewed properly with a purchased or rented decoder. You can connect such a decoder (descrambler) to your DVD recorder (see page 14).

The following function automatically activates the connected decoder for the TV channel you want to watch.

- 1 Press **SYSTEM-MENU**.
→ The system menu appears on the TV.
- 2 Press ▼ repeatedly to select { **Set-up** }.
- 3 Press ► repeatedly to select { **Analogue Ch.** }.

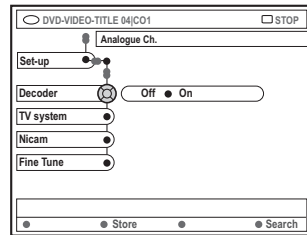

- 4 Press ▼ repeatedly to select { **Decoder** } and press ► to confirm.
- 5 Press ► to select { **On** } and press **OK** to confirm.
→ Your decoder has now been allocated to this TV channel.
- To turn off the decoder, press ► to select { **Off** }.

TIPS: Press ◀ to go back to previous menu item. Press **SYSTEM-MENU** to exit the menu.

Installing the DVD Recorder (cont'd)

Fine tuning the TV channels

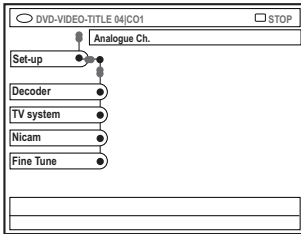

To improve the sound transmission of the TV channel

NICAM is a digital sound transmission system. Using NICAM, you can transmit either one stereo channel or two separate mono channels. However, if reception is poor and the sound distorted, you can turn off NICAM.

- 1 Move to { **NICAM** } and press ► to select { **On** } or { **Off** }.
- 2 Press ◀ to confirm.

To finetune the TV channels

- 1 Move to { **Finetune** } and press ►.
- 2 Press ◀► to fine-tune the TV channel manually, then press the matching colour coded button on the remote control to select { **Store** }.

Setting the time and date

If the DVD recorder does not set the time and date correctly, you can set the clock manually by following the steps below.

- 1 Press **SYSTEM-MENU** on the remote control.
→ The system menu appears on the TV.
- 2 Press ▼ repeatedly to select { **Set-up** }.
- 3 Press ► repeatedly to select { **Time-date** }.

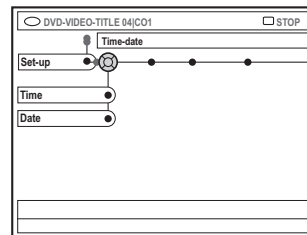

- 4 Press ▼ to select { **Time** } and press ► to enter the time field.
→ { **00 : 00** } (hours : minutes)
- 5 Press ▲ ▼ to change the first digit and press ► to go to the next digit field.
- 6 Repeat step 5 until the time is entered correctly, then press **OK** to confirm.
- 7 Press ▼ to select { **Date** } and press ► to enter the date field.
→ { **00 : 00 : 0000** } (day : month : year).
- 8 Repeat step 5 until the date is entered correctly, then press **OK** to confirm.

TIPS: Press ◀ to go back to previous menu item. Press **SYSTEM-MENU** to exit the menu.

Installing the DVD Recorder (cont'd)

Setting the language

You can select the language for subtitles and audio for DVD playback. For some DVDs, the subtitle/audio language can only be changed via the DVD disc menu. If the selected language is not available on the disc, the disc's default setting language will be used instead.

The menu language (on-screen display) for the system will remain as you set it.

- 1 Press **SYSTEM-MENU** on the remote control.
→ The system menu appears on the TV.
- 2 Press **▼** repeatedly to select { **Set-up** }.
- 3 Press **▶** repeatedly to select { **Language** }.

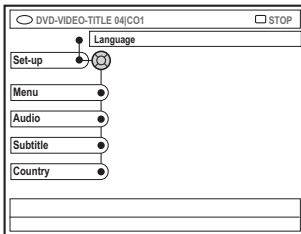

- 4 Press **▲ ▼** to select one of the options below at a time, then press **▶**.
 - { **Menu** }; language of the OSD menu
 - { **Audio** }; playback audio language
 - { **Subtitle** }; subtitle language
 - { **Country** }; location
- 5 Press **▲ ▼** to select a desired language and press **◀** to confirm.
- 6 Repeat steps 4~5 for other settings.

TIPS: Press **◀** to go back to previous menu item. Press **SYSTEM-MENU** to exit the menu.

Playable discs

Using this DVD Recorder, you can play and record on the following discs:

Recording and Playback

DVD+RW (DVD 'plus' Rewritable); can be recorded on over and over.



DVD+R (DVD 'plus' Recordable); can be recorded only once.



Playback only:

DVD Video (Digital Versatile Disc)



DVD-R (DVD 'minus' Recordable); can only be played back when the recording was made in 'video mode' and the recording was finalised.



DVD-RW (DVD 'minus' Rewritable); can only be played back when the recording was made in 'video mode'.



Audio CD (Compact Disc Digital Audio)



MP3-CD



Video CD
(Formats 1.0, 1.1, 2.0)



Super Video CD



CD-R (CD-Recordable) Audio/MP3 contents



CD-RW (CD-Rewritable) Audio/MP3 contents



IMPORTANT!

- If the inhibit icon (XError) appears on the TV screen when a button is pressed, it means the function is not available on the current disc or at the current time.
- DVD discs and players are designed with regional restrictions. Before playing a disc, make sure the disc is for the same zone as your player.
- Do not push on the disc tray or put any objects other than discs on the disc tray. It may cause the disc player to malfunction.

Inserting a disc

- 1 Press **STANDBY-ON** to turn on the DVD recorder.
- 2 Press **OPEN/CLOSE** on the front of the DVD recorder.
→ The disc tray opens.
- 3 You can also hold down the **STOP** button on the remote control to open and close the disc tray.
- 3 Carefully place the disc into the tray with the label facing up, then press **OPEN/CLOSE** .
→ Make sure the disc label is facing up. For double-sided discs, load the side which you want to play facing up.
- 4 Turn on the TV power. Select the correct Video In channel at the TV.
- 5 Playback will start automatically or a dialogue will appear on the TV (see next page).

TIPS: Some discs cannot be played on this DVD recorder due to the configuration and characteristics of the disc, or due to the condition of recording and authoring software that was used.

Playback (cont'd)

Starting disc playback

- If a dialogue appears on the TV showing :
{ **Do you want to access the disc content ?** }.
→ Select { **Yes** } to show the disc content menu (see page 50 "Browsing the discs").
→ Select { **No** } to switch to the last active mode.
→ If you want to remove this dialogue, you have to enable the { **Auto play** } function (see page 55).
- If the pin code entry dialogue appears on the TV, this means that the child lock/ parental control was activated for the inserted disc (see pages 59~60).
→ Use the alphanumeric keypad 0-9 on the remote control to enter your pin code (password).
- For more playback features, see pages 32~35 "Additional Playback Features".

Playing a DVD video disc

Normally the DVD disc contains a disc menu. You may have to make your selection (e.g., subtitle or audio language) within the disc menu.

- 1 Insert a DVD.
To access the disc menu
- Press **DISC-MENU** on the remote control. Use **alphanumeric keypad 0-9** to input your selection or use ▲ ▼ to select a play option and press **OK** to confirm.
To select the previous or next chapter/title marker
- During playback, press **T/C** on the remote to select 'Title' or 'Chapter', then press ◀▶ / ▶▶.
- 2 To stop playback, press **STOP ■**.

Playing a (Super) Video CDs

(Super) Video CDs may feature 'PBC' (Play Back Control). This allows you to play the video CDs interactively, following the menu on the display.

- 1 Insert a (Super) Video CD.
If the 'PBC' is on, the disc index menu will appear on the TV
- 2 Use **alphanumeric keypad 0-9** to input your selection or use ▲ ▼ to select a play option and press **OK** to confirm.
- Press **RETURN** on the remote control will return to the previous menu.
- 3 To stop playback, press **STOP ■**.

Helpful Hint:

– 'PBC' mode is turned off by default. If you want to view the disc index menu, you have to turn on the 'PBC' mode (see page 57).

Playing an audio CD

- 1 Insert an audio CD.
→ Playback starts automatically.
- 2 To stop playback, press **STOP ■**.
→ The track number and total play time appear on the display panel.

Helpful Hint:

– If the TV is turned on, the Audio CD display will appear on the screen. During playback, the number of the current track will be shown on the screen and display.

TIPS: Some discs cannot be played on this DVD recorder due to the configuration and characteristics of the disc, or due to the condition of recording and authoring software that was used.

Playing a DVD+R(W) disc

- 1 Insert a DVD+RW or DVD+R disc.
If the disc content menu appears on the TV
- 2 Use ◀▶ ▲▼ to navigate within the menu and select a title to play, then press **PLAY ▶**.
- 3 To stop playback, press **STOP ■**.

Helpful Hint:

– If the message 'EMPTY DISC' appears on the display panel, this means that there are no recordings on this disc.

Playing an MP3 CD

- 1 Insert an MP3 CD.
If the disc content menu appears on the TV
- 2 Use ◀▶ ▲▼ to navigate within the menu and select the album and track to play, then press **PLAY ▶**.
- 3 During playback, you can press ◀◀ / ▶▶ to select the next/previous track.
- 4 To stop playback, press **STOP ■**.
→ The number of albums appears on the display.

Helpful Hints:

– Only the first session of a multi-session CD will be played back.
– Further information on the album, track and artist will also be displayed on the TV if included in the ID tag.

Playing a picture disc (slide show)

You can display JPEG pictures in the selected roll automatically one after the other at adjustable intervals.

- 1 Insert a JPEG picture disc (CD, DVD+RW, DVD+R).
If the picture overview appears on the TV
- 2 Use ◀▶ ▲▼ to navigate within the menu and select a photo roll folder to play.
- 3 Press **PLAY ▶** to start the slide show playback.
OR
- Press **OK** to show 12 thumbnail pictures. You can use ◀▶ ▲▼ to select a picture file, then press **PLAY ▶** to begin playback.
- 4 During playback, you can select to zoom, flip or rotate the picture. Press **EDIT** and followed by the corresponds colour coded button on the remote control.
- 5 To stop playback, press **STOP ■**.
→ The picture overview appears.

Supported JPEG picture formats

This DVD recorder can read JPEG pictures stored on a CD-ROM, Picture CD, or DVD.

File format:

- The file extension has to be '*.JPG' and not '*.JPEG'.
- It can only display DCF-standard still pictures or JPEG pictures e.g. TIFF. It cannot play back moving pictures, Motion JPEG, progressive JPEG and other formats, or pictures in formats other than JPEG, or pictures associated with sound e.g. AVI-files.
- It may require longer time for the DVD recorder to display the disc content on the TV due to the large number of songs/pictures compiled into one disc.

TIPS: Some discs cannot be played on this DVD recorder due to the configuration and characteristics of the disc, or due to the condition of recording and authoring software that was used.

Additional Playback Features

Using Toolbar options

- 1 Press **SYSTEM-MENU** on the remote control.
→ The system menu appears on the TV.
- 2 At { **Toolbar** }, press ► to select { **Options** }.

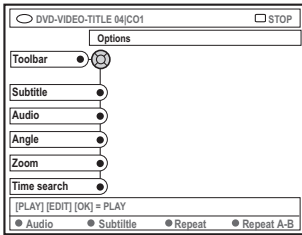

- 3 Press ▲ ▼ to select the setting you want to adjust.
→ If the selection in the menu is greyed out, that means the feature is not available or not possible to change at the current state.
→ Instructions for adjusting the settings are provided in the following pages.
- 4 To exit, press **SYSTEM-MENU**.

Changing subtitle language

This operation works only on DVDs with multiple subtitle languages, you can change the language you want while playing DVD.

This function can also be accessed via the **Green** button on the remote control.

- 1 Press ▼ to select { **Subtitle** } and press ► to enter its options.
- 2 Press ▼ repeatedly until the language you want is selected, then press ◀ to confirm.
→ The languages may be numbered or abbreviated, such as “En” for English.
→ If the language selected is not available on the disc, the disc’s default setting language will be used instead.

Helpful Hint:

– Some DVDs discs allow subtitle language changes only via the DVD disc menu. To access the disc menu, press **DISC-MENU**.

TIPS: The operating features described here might not be possible for certain discs. Always refer to the instructions supplied with the discs.

Additional Playback Features (cont'd)

Changing audio soundtrack language

This operation works only on DVDs with multiple soundtrack language or VCDs with multiple audio channel.

This function can also be accessed via the **Red** button on the remote control.

- 1 Press **▼** to select { **Audio** } and press **▶** to enter its options.
- 2 Press **▼** repeatedly until the audio language you want is selected, then press **◀** to confirm.
→ The languages may be numbered or abbreviated, such as “En” for English.
→ If the language selected is not available on the disc, the disc’s default setting language will be used instead.

Helpful Hint:

– Some DVDs allow soundtrack language changes only via the DVD disc menu. To access the Disc Menu, press **DISC-MENU**.

Switching camera angles

This option is only available with DVDs that contain sequences recorded from different camera angles. This allows you to view the picture from different angles.

- 1 Press **▼** to select { **Angle** } and press **▶** to enter its options.
→ The camera angles available for selection appears.
- 2 Press **▲▼** to select the camera angle you want to switch to, then press **◀** to confirm.

Zooming in

This option allows you to enlarge the picture on the TV screen and to pan through the enlarged picture.

- 1 Press **▼** to select { **Zoom** } and press **▶** to enter zoom in mode.
→ The zoom status bar appears and displays the zoom factor.

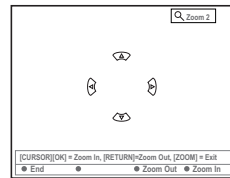

- 2 Press **OK** on the remote to zoom in or **RETURN** to zoom out.
- 3 Use **◀▶▲▼** to pan through the zoomed picture.
- 4 To exit zoom mode, press **SYSTEM-MENU**

Time search

This option allows you to skip to a specific point in the current disc.

- 1 Press **▼** to select { **Time search** } and press **▶** to enter the time field.
→ The time shows the elapsed playing time of the current disc (hours : minutes).
- 2 Press **▲▼** to change the digit and press **▶** to go to the next digit field.
- You may also use the **alphanumeric keypad 0-9** to enter the correct digit directly.
- 3 Press **OK** to confirm.
→ Playback skips to the selected time.

TIPS: The operating features described here might not be possible for certain discs. Always refer to the instructions supplied with the discs.

Additional Playback Features (cont'd)

Changing to another title/ chapter/track

When a disc contains more than one track, title or chapter, you can change to a different track, title or chapter as follows.

During playback,

- Press **▶▶** to go to the next title/chapter/track.
 - Press **◀◀** to return to the start of the current title/chapter/track. Pressing **◀◀** twice can return to the start of the previous title/chapter/track.
- OR
- Use the **alphanumeric keypad 0-9** to input the title/chapter/track number.
- OR
- Press **T/C** on the remote control to select "T" (title) or "C" (chapter).
- OR
- Press **BROWSER** on the remote control to display the titles list. Then press **▲ ▼** to select a title and press **OK** to start playback.

Searching forwards/ backwards

You can fast forward or fast reverse a disc at four, eight or thirty two times normal playback speed.

- 1 During playback, hold down **◀◀** (reverse) or **▶▶** (forward) to switch to the search function.
 - The Search status bar appears. It displays the Search speed (-32x, -8x, -4x, 4x, 8x or 32x).
 - The sound will be mute.
- 2 Press the **◀◀** (reverse) or **▶▶** (forward) button to cycle through the search speeds.
- 3 To resume normal playback, press **PLAY ▶**.

Pausing playback / slow motion play

- 1 During playback, press **PAUSE II** to pause playback and display a still picture.
- 2 Hold down **◀◀** (reverse) or **▶▶** (forward) to start reverse or forward slow motion playback.
 - Pressing **◀◀** or **▶▶** repeatedly to switch between different slow motion speed (-1/2, -1/4, -1/8, 1/2, 1/4 or 1/8).
- 3 To resume normal playback, press **PLAY ▶**.

TIPS: The operating features described here might not be possible for certain discs. Always refer to the instructions supplied with the discs.

Additional Playback Features (cont'd)

Selecting various play mode

Repeat play

You can select a Chapter, Track, Title or the entire disc for repeat playback.

- 1 Press **Yellow** button { REPEAT } repeatedly on the remote control to select one of the repeat options.
 - Repeat chapter (DVD, DVD+R(W) only)
 - Repeat track/title
 - Repeat album/playlist (if applicable)
 - Repeat entire disc (video CD, audio CD, DVD+R[W] only)
 - Repeat off
- 2 To cancel repeat playback, press the **Yellow** button repeatedly until the repeat mode is off or press **STOP** ■.

Repeating a specific segment (A-B)

You can repeat the playback of a specific segment within a title/chapter/track. To do this, you must mark the start and end of the segment you want.

- 1 During playback, press **Blue** button { REPEAT A-B } on the remote control.
 - This indicates that the start point has been marked.
- 2 Press **Blue** button (REPEAT A-B) on the remote control again to mark the end of the segment.
 - A visual marker is placed on the programme bar.
 - Playback skips to the start of the marked segment. The segment is repeated until the repeat mode is cancelled.
- 3 To cancel repeat playback, press **Blue** button again.

Shuffle play

Select shuffle play mode to allow the DVD recorder to randomly select and play tracks on the disc (MP3 and audio CDs only).

- 1 Press **Green** button { SHUFFLE } on the remote control.
 - It will start playback of all the chapters within the title in a random order.
- 2 To cancel shuffle playback, press **Green** button again.

Scan disc

This function allows you to preview the first 10 seconds of each track (CD, VCD DVD+RW only) on the disc.

- 1 During playback, press **Red** button { SCAN } on the remote control.
 - The DVD recorder skips to the next track after 10 seconds of playback.
- 2 To exit Scan disc mode, press **Red** button again.
 - Normal playback resumes at the current track.

TIPS: The operating features described here might not be possible for certain discs. Always refer to the instructions supplied with the discs.

Recording

Discs for recording

Two different formats of DVD recordable discs can be used with this DVD recorder:



DVD+RW (DVD 'plus' Rewritable)

– Discs are re-writable can be used for multiple recordings once existing data is erased.



DVD+R (DVD 'plus' Recordable)

- It can only be recorded once. After you have finalised a DVD+R, you cannot record on it or edit it any more.
- Each new recording is always added at the end of all previous recordings as existing recordings cannot be overwritten.
- Editing can be made on DVD+R discs as long as they have not been finalised. It is also possible to create additional chapter markings.
- You can also delete unwanted recordings. However, the disc space occupied by the deleted recordings cannot be recovered for further recording.
- To play a DVD+R disc on other DVD player, it must be finalised (see page 46 "Finalising disc (DVD+R)"). After this is done, no more data can be added to the disc.

IMPORTANT!

Unrecordable pictures

Television programmes, films, video tapes, discs, and other materials may be copyrighted, it cannot be recorded on this recorder.

Recording settings

Before recording, you may have to set up the recording mode or select the settings that best suit your needs and requirements.

- 1 Press **SYSTEM-MENU** on the remote control.
→ The system menu appears on TV.
- 2 Press ▼ to select { **Preferences** }.
- 3 Press ► to select { **Recording** }.

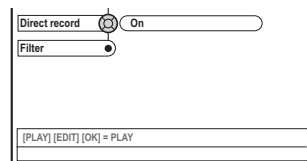
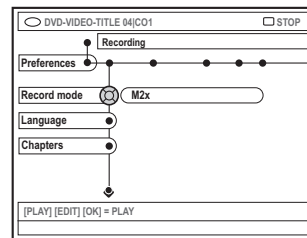

- 4 Press ▲▼ to select the setting for recording.
→ Instructions for adjusting the settings are provided in the following pages.
- 5 To exit, press **SYSTEM-MENU**.

TIPS: Underlined option is the factory default setting.
Press ◀ to go back to previous menu item. Press **SYSTEM-MENU** to exit the menu.

Recording mode

The recording mode defines the picture quality of recordings and the maximum recording time for a disc. During playback, the correct picture quality will automatically be selected.

This function can also be accessed via the **REC MODE** button on the remote control.

- 1 Press ▼ to select { **Record mode** } and press ► to enter its options.
- 2 Press ▲ ▼ to select one of the following record modes.

Record Mode	Picture Quality	Maximum Recording Time per Disc
M1	High quality (HQ)	1 hour
M2	DVD quality-Standard Play (SP)	2 hours
M2x	DVD quality-Standard Play Plus (SP+)	2.5 hours
M3	S-VHS quality-Long Play (LP)	3 hours
M4	VHS quality-Extended Play (EP)	4 hours
M6	VHS quality-Super Long Play (SLP)	6 hours
M8	VHS quality-Super Extended Play (SEP)	8 hours

- 3 Press ◀ to confirm.

Helpful Hint:

– {M1} record mode only available for model DVDR615 and DVDR616 only.

Recording language

Some TV programmes broadcast additional audio language (2-channel sound). For example, if a programme is available in English and Spanish, with Spanish being the second language option. You can select the language you want as the default setting for recording. This setting will only active if a TV programme is transmitted in 2-channel sound.

When you play the recording, you can play only in the audio you recorded.

- 1 Press ▼ to select { **Language** } and press ► to enter its options.
- 2 Press ► to select one of the options.
→ { **Lang. I** } : Original broadcast language.
→ { **Lang. II** } : Additional audio language (2-channel sound).
- 3 Press ◀ to confirm.

Inserting chapter markers

You can insert a chapter markers within a title during recording. This lets you access specific points on the recorded disc as you would choose a chapter on a DVD.

- 1 Press ▼ to select { **Chapters** } and press ► to enter its options.
- 2 Press ▲ ▼ to select one of the options.
→ { **Off** } : Disable this feature.
→ { **Standard** } : A chapter marker will be automatically inserted during recording, the interval will depend on the recording mode selected.
- 3 Press ◀ to confirm.

TIPS: Underlined option is the factory default setting.
Press ◀ to go back to previous menu item. Press **SYSTEM-MENU** to exit the menu.

Recording (cont'd)

Direct record function

To enable direct recording from your TV set, make sure that the direct record mode is turned on. See page 40 "Direct Recording" for more information.

- 1 Press ▼ to select { **Direct record** } and press ► to enter its options.
- 2 Press ► to select one of the options.
 - { **On** } : Enable recording directly from the TV display.
 - { **Off** } : Disable direct record function.
- 3 Press ◀ to confirm.

Filter mode

For long play or extended play recording, you can select a suitable filter mode to optimise the video recording. The setting does not influence high quality or standard play recording mode.

- 1 Press ▼ to select { **Filter** } and press ► to enter its options.
- 2 Press ► to select one of the options.
 - { **Standard** } : Recording quality is as the recording mode selected.
 - { **Sport** } : Improve recording of images that move quickly. Optimise the picture quality in record mode M3~M8.
- 3 Press ◀ to confirm.

Manual recording

Use the 'Manual recording' function to start recording immediately (e.g., to record a TV show already in progress).

- 1 Turn on the TV power. Select the correct Video In channel at the TV.
- 2 Insert a DVD+R(W).
 - If a DVD+RW was inserted that already contains recordings, press ▲ ▼ to select the location where the recording should be started.
- 3 Press **TUNER** on the remote control to see the TV programmes, then press ▲ ▼ to select the programme number you wish to record.
- To record from additional device, press button {0} on the remote control and followed by ▼ to select the correct input channel that matches the socket to which you connected to the DVD recorder.
 - { CAM 2 } : DV IN socket at the front
 - { CAM 1 } : S-VIDEO or VIDEO and AUDIO L/R sockets at the front
 - { EXT 2 } : EXT 2 AUX-I/O Scart socket at the back
 - { EXT 1 } : EXT 1 TO TV-I/O Scart socket at the back
- 4 Press **REC** ● to start recording.
- 5 For recording from external device, you have to start play on the external device.
- While recording in progress, you can press **OK** to insert a chapter marker wherever necessary.

TIPS: Underlined option is the factory default setting.
Press ◀ to go back to previous menu item. Press **SYSTEM-MENU** to exit the menu.

- 6 To stop the recording, press **STOP ■**.
→ 'MENU UPDATE' or 'CREATE MENU' appears on the display panel to indicate that the DVD recorder is writing the list of contents. Wait until the message disappears before removing the DVD+R(W).
- If the end of a disc is reached during recording, recording will stop and the DVD recorder will turn off automatically.

Pausing a recording

- 1 During recording, press **PAUSE II**.
→ You can use this function to avoid recording commercials.
- 2 To continue recording, press **REC ●**.

Helpful Hints:

- If you insert recordings between existing recordings, check the lengths of the old and new recordings. If the new recording is too long the subsequent recording (title/chapter) will be overwritten.
- The length of recording available depends on the current recording mode and the amount of time available on the disc.

Manual recording with automatic turn-off (One Touch Recording)

- 1 Follow the steps 1~3 of "Manual Recording" on page 38.
- 2 Press **REC ●** on the remote control twice to start 30 minutes recording. Each time you press **REC ●** you will add 30 minutes to the recording time.
→ The recorder will stop recording at the designated end time and turn off automatically.
- If you wish to delete the recording, press **STOP ■** while the display showing the recording time.
- To check the remaining recording time while recording in progress, press **SYSTEM-MENU**.

TIPS: To play a DVD+R on other DVD players, see "Finalising disc (DVD+R)".

Recording (cont'd)

Direct recording

The Direct Record function allows you to record the TV programme which you are currently watching when the DVD recorder is turned off.

- 1 Turn on the { **Direct record** } mode in the recording setting (see page 38).
- 2 On the TV, select the programme number you want to record.
- 3 With the DVD recorder turned off, press **REC ●**.
→ The system will compare the selected TV channel on the TV set with its stored TV channels. If the same TV channel is found, it switches the DVD recorder to the corresponding programme number and starts recording.
- 4 To stop recording, press **STOP ■**.

Helpful Hint:

– Do not change channels during the search, this could affect the tuning of the DVD recorder.

Deleting a recording

You can delete a specific recording from the DVD+R(W).

- 1 Insert a recorded DVD+RW or an unfinalised DVD+R.
→ The Index Picture screen or disc content menu appears on the TV.
- 2 Use ◀▶▶▲▼ to select an entry in the menu.
- 3 Press the matching colour coded button on the remote control to select { **Delete** }.
→ The current recording will be deleted.
→ For DVD+RW only, a new recording can now be made here.
- To delete all the recordings, see pages 54~55 “Accessing to the Preferences options - Disc” and select { **Delete all** }.

TIPS: To play a DVD+R on other DVD players, see “Finalising disc (DVD+R)”.

Timer Recording

Introduction

Use 'Timer Recording' to automatically start and stop a recording at a later date/ time. The DVD recorder will tune to the right programme number and begin recording at the specified time.

With this DVD recorder, you can pre-programme up to **six recordings** within a period of 15 days.

To make a programmed recording, your DVD recorder needs to know:

- The date you want to make the recording.
- The programme number of the TV channel.
- The start and stop time of the recording.
- The recording mode (M1/M2/M2x/M3/M4/M6/M8), see page 37.

About 'VPS/PDC'

'VPS' (Video Programming System)/'PDC' (Programme Delivery Control) are used to control the start and duration of TV channel recordings. If a TV programme starts earlier or ends later than was scheduled, the DVD recorder will then turn on and off at the correct time.

If you want to program a time that is different from the VPS/PDC time, you must turn off VPS/PDC.

Programming recordings

- 1 Turn on the TV power. Select the correct Video In channel at the TV.
- 2 Press **TIMER** on the remote control.
→ The timer overview appears.
- If the time has not set yet, the { **Time and Date** } menu will appear on the screen, see page 27.
- 3 Press the matching colour coded button on the remote control to select { **New Timer** }.
→ The timer entry screen appears.

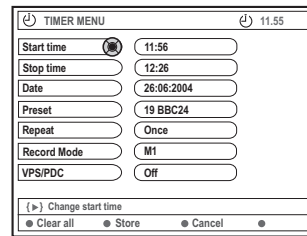

- 4 Press ▲ ▼ to select an entry in the menu and press ► to confirm.
- 5 Press ▲ ▼ to select an option or make an entry (character/number).
→ Press ◀ ▶ to move to the previous or next entry field if necessary.

{ Start time }

- Enter the start recording time and press **OK** to confirm.

{ Stop time }

- Enter the stop recording time and press **OK** to confirm.

{ Date }

- Enter the date for recording (Day/Month/Year) and press **OK** to confirm.

{ Preset }

- Select the preset channel and press **OK** to confirm.

TIPS: To play a DVD+R on other DVD players, see "Finalising disc (DVD+R)".
During timer recording, press **STANDBY-ON** will stop recording.

Timer Recording (cont'd)

{ Repeat }

– Select {Weekly}, {Once} or {Mon-Fri} (Monday to Friday) recordings and press **OK** to confirm.

{ Record mode }

– Select a record mode and press **OK** to confirm. See pages 36~37 “Recording settings - Recording mode”).

{ VPS/PDC }

– Select to turn on or off VPS/PDC mode. For information on VPS/PDC, see page 41.

- To clear the timer entries, press the matching colour coded button on the remote control to select { **Clear all** }.
→ All the settings in the timer menu are cleared.
- To cancel the timer programming, press the matching colour coded button on the remote control to select { **Cancel** }.
→ The timer overview appears.
- ⑥ Press the matching colour coded button on the remote control to select { **Store** }.
→ The system will store the timer entry and return to the timer overview screen.
- ⑦ To exit, press **TIMER**.
- ⑧ Insert a DVD+R(W).
- ⑨ Press **STANDBY-ON** to turn off the DVD recorder.
→ The DVD recorder must be in standby mode in order for the timer recording to occur. If not, a warning message will appear ten minutes before the recording starts.
→ If you ignore the warning message, the DVD recorder will switch to standby mode automatically before the programmed recording begins.
→ The '**TIMER**' icon will light up on the display panel if a timer recording is set.

Helpful Hints:

- Set the timer recording one minute ahead of the programme's start time. This helps ensure the entire programme is recorded as the disc requires about 30 seconds to prepare for recording.
- Programme timer recording from {CAM2} external input source is not possible.

Programming recording from a Cable Box

If you have a Cable Box connected to the DVD recorder's Scart connection 'EXT 2 AUX-I/O' (see page 14), follow the steps described below to program the recordings.

- ① Select the channel you want to record at the Cable Box.
- ② Programme the recording with the required information. Follow the steps ①~⑨ of “Programming Recording” on pages 41~42.

{ Preset }

– Select { EXT2 } as the input channel and press **OK** to confirm.

- ③ Leave the Cable Box on for the recording.

TIPS: To play a DVD+R on other DVD players, see “Finalising disc (DVD+R)”.
During timer recording, press **STANDBY-ON** will stop recording.

Timer Recording (cont'd)

Programming recordings with the ShowView® System

With this programming system, you only need to enter the ShowView® programme number as all the information needed by the DVD recorder for programming is contained in the programming number.

- 1 Turn on the TV power. Select the correct Video In channel at the TV.
- 2 Press **TIMER** on the remote control.
→ The timer overview appears.

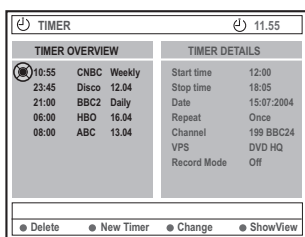

- 3 Press the matching colour coded button on the remote control to select { **ShowView** }.
→ The ShowView® entry screen appears.

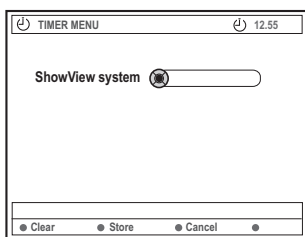

- 4 Use the **alphanumeric keypad 0-9** to enter the ShowView® code. (e.g.,: 5-312-4 or 5,312 4, key in '53124').
→ This number is up to 9 digits long and can be found next to the start time of the TV programme in your TV listings magazine.

- To clear the ShowView® entry, press the matching colour coded button on the remote control to select { **Clear** }.
- To cancel the ShowView® programming, press the matching colour coded button on the remote control to select { **Cancel** }.
→ The timer overview appears.
- 5 Press **OK** to confirm, then press the matching colour coded button on the remote control to select { **Store** }.
→ The system will store the timer entry and return to the timer overview screen.
- If the information is missing or not available, you may be asked to enter more information. Follow the instructions on the TV.
- If you want to make changes, use ▲▼◀▶ to select the appropriate entry field. If required, make changes using ▲▼ or the **alphanumeric keypad 0-9**.
- 6 To exit, press **TIMER**.
- 7 Insert a DVD+R(W).
- 8 Press **STANDBY-ON** to switch off the DVD recorder.
→ The DVD recorder must be in standby mode in order for the timer recording to occur. If not, a warning message will appear ten minutes before the recording starts.
→ If you ignore the warning message, the DVD recorder will switch to standby mode automatically before the programmed recording begins.
→ The 'TIMER' icon will light up on the display panel if a timer recording is set.

TIPS: To play a DVD+R on other DVD players, see “Finalising disc (DVD+R)”.
During timer recording, press **STANDBY-ON** will stop recording.

Timer Recording (cont'd)

Changing a programmed recording

- 1 Turn on the TV power. Select the correct Video In channel at the TV.
- 2 Press **TIMER** on the remote control.
→ The timer overview appears.

TIMER OVERVIEW		TIMER DETAILS	
19:55	CNBC Weekly	Start time	12:00
23:45	Disco 12.04	Stop time	18:05
21:00	BBC2 Daily	Date	15-07-2004
06:00	HBO 16.04	Repeat	Once
08:00	ABC 13.04	Channel	199 BBC24
		VPS	DVD HQ
		Record Mode	Off

● Delete ● New Timer ● Change ● ShowView

- 3 Press **▲▼** to select a timer programme which you want to change.
- 4 Press the matching colour coded button on the remote control to select { **Change** }.
→ The timer entry screen of the current selected timer programme appears.
- 5 Follow the steps 4~9 of "Programming recordings" on pages 41~42 to make the necessary changes.

Deleting a programmed recording

- 1 Turn on the TV power. Select the correct Video In channel at the TV.
- 2 Press **TIMER** on the remote control.
→ The timer overview appears.
- 3 Press **▲▼** to select a timer programme which you want to delete.
- 4 Press the matching colour coded button on the remote control to select { **Delete** }.
→ The current selected timer programme is deleted from the list.

TIPS: To play a DVD+R on other DVD players, see "Finalising disc (DVD+R)".
During timer recording, press **STANDBY-ON** will stop recording.

Editing/Finalising Recording

About editing

You can change disc contents and settings for a recorded DVD+RW or unfinalised DVD+R from the edit menu screen. Photo editing is limited to edit the information on a roll or album. These editing changes are available for the DVD recorder, but may not be accessible when you play the disc on other DVD player.

The edit menu contains the following editable items :

- Disc name of a DVD+R(W)
- Make DVD compatible (DVD+RW only)
- Finalise disc (DVD+R only)
- Title name of a title on a DVD+R(W)
- Video editing

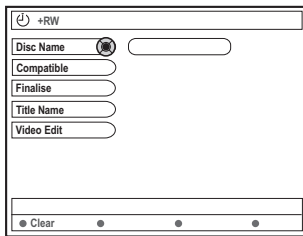

Colour coded buttons functions

In the edit mode, a number of functions are available via the colour coded buttons on the remote control.

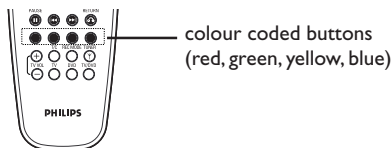

These functions are displayed in the bottom of the menu wherever applicable.

{ Clear }

- Press this button to clear the entry on the currently selected menu item.

Index Picture screens

The Index Picture screen shows your recordings on a DVD+RW or DVD+R.

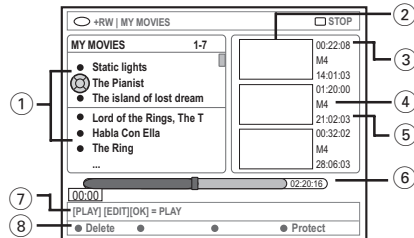

An Index Picture screen represents each recording information saved :

- ① Name of recording (or channel number and time).
- ② Title's index picture
- ③ Length of recording
- ④ Recording mode
- ⑤ Date of the recording
- ⑥ Disc bar (represents the recordings, erased titles, protected title and blank space at the end of the disc)
- ⑦ Support function guidance
- ⑧ Four colour coded buttons supported functions.

TIPS: No further recording and editing can be carried out on a finalised DVD+R. Press **RETURN** to go back to previous menu item. Press **EDIT** to exit the menu.

Editing/Finalising Recording (cont'd)

Changing the disc/title name

- 1 Insert a recorded DVD+RW or an unfinalised DVD+R.
→ The Index Picture screen or disc content menu appears on the TV.
- 2 Press **EDIT** on the remote control.
→ The edit menu appears.
- 3 Press **▲ ▼** to select { **Disc name** } or { **Title name** } in the menu.
- 4 Press **▲ ▼** to change the character/number or make an entry by using the **alphanumeric keypad 0-9**.
→ Press **◀ ▶** to move to the previous or next field.
- 5 Press **OK** to confirm the changes.
→ The info panel is now updated.

Making the editing compatible (DVD+RW)

This function allows you to make an edited version DVD+RW compatible. This is required to enable the edited information to be seen on other DVD players.

- 1 Insert a recorded DVD+RW.
→ The Index Picture screen or disc content menu appears on the TV.
- 2 Press **EDIT** on the remote control.
→ The edit menu appears.
- 3 Press **▲ ▼** to select { **Compatible** } in the menu and press **OK** to confirm.

Helpful Hint:

– If the {Compatible} not available for selection, it means that the disc is already compatible.

Finalising disc (DVD+R)

This function is necessary for a DVD+R in order to be played back on a DVD player. Otherwise, the DVD+R will play only on this DVD recorder.

After finalised, no further recordings or editings can be made to the disc. Make sure that you have complete all the recordings and editing before finalising it. Unfinalise a DVD+R is not possible.

- 1 Insert an unfinalised DVD+R.
→ The Index Picture screen or disc content menu appears on the TV.
- 2 Press **EDIT** on the remote control.
→ The edit menu appears.
- 3 Press **▲ ▼** to select { **Finalise** } in the menu and press **OK** to confirm.
→ A dialogue will appear showing the required process time.
→ Once complete, the Index Picture screen appears.

TIPS: No further recording and editing can be carried out on a finalised DVD+R. Press **RETURN** to go back to previous menu item. Press **EDIT** to exit the menu.

Editing/Finalising Recording (cont'd)

Video editing

In the edit video mode, the entire recording will be played back regardless of whether they are hidden or not.

- 1 Insert a recorded DVD+RW or an unfinalised DVD+R.
→ The Index Picture screen appears on the TV.
- 2 Press **▲ ▼** to select a recording.
- 3 Press **EDIT** on the remote control.
→ The edit menu appears.
- 4 Press **▲ ▼** to select { **Video edit** } in the menu and press **OK** to confirm.
→ The video edit menu appears.
OR
- While playing the recorded DVD+R(W), you can press **EDIT** to direct access to the video edit menu.

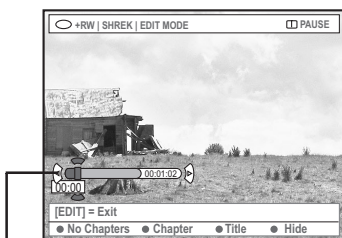

Disc bar

About disc bar

In the disc bar, the record playback head represents the actual position of the playback on the disc.

Hiding unwanted chapter

You can choose to hide certain scene for playback (e.g. commercial skipping) or make them visible again.

- 1 Follow the steps 1~4 of "Video editing" on page 47.
- 2 Press **PLAY ►** or **◀◀ / ▶▶** to search for the beginning of the chapter you want to hide.
→ The selection of chapters can only be done within a title, make sure that you do not jump into the next title.
- 3 Press the matching colour coded button on the remote control to select { **Hide** }.
→ It will set the chapter for hide.
→ The hiding chapters will only reflect after exit video editing mode.

To cancel the hidden chapters

- 4 Press **◀◀** or **▶▶** to search for the beginning of the chapter you want to unhide.
- 5 Press the matching colour coded button on the remote control to select { **Show** }.
→ It will set the chapter for unhide.

TIPS: No further recording and editing can be carried out on a finalised DVD+R. Press **RETURN** to go back to previous menu item. Press **EDIT** to exit the menu.

Editing/Finalising Recording (cont'd)

Editing chapter (merge/split/hide)

- 1 Start playback a recorded DVD+RW or an unfinalised DVD+R.
- 2 Press **EDIT** on the remote control.
- 3 Press the matching colour coded button on the remote control to select { **Chapter** }.
→ The chapter editing menu appears.

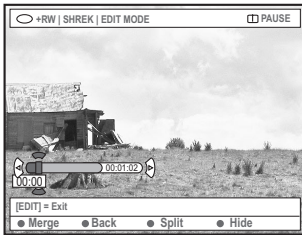

- 4 Press the matching colour coded button on the remote control to make your editing.

{ Merge }

- Select this to merge the current chapter with the chapter before it.

If the two chapters were hidden, then the joined chapter will also be hidden. If only one of the chapters is hidden, then the joined chapter will not be hidden.

{ Back }

- Select this to return to the previous screen.

{ Split }

- Select this to insert a chapter marker, it will cut the current chapter to two. When the playback is in a chapter which is marked for hiding, then both new chapters will be hidden.

{ Hide }

- Select this to hide the current chapter.

Editing title (divide/append/Index picture)

- 1 Start playback a recorded DVD+RW or an unfinalised DVD+R.
- 2 Press **EDIT** on the remote control.
- 3 Press the matching colour coded button on the remote control to select { **Title** }.
→ The title editing menu appears.



- 4 Once you have found the scene that you want to use for title editing, press the matching colour coded button on the remote control to make your editing.

{ Divide } - for DVD+RW only

- Select this to divide the current title into two new titles. Each of these titles is characterised by its own index picture.

Warning! Once a title is divided, it cannot be reversed.

{ Back }

- Select this to return to the previous screen.

{ Index Pic. }

- Select this to use the current scene as the title's index picture.

Note: In the Index Picture screen, normally the first frame of a recording is shown as the title's index picture.

TIPS: No further recording and editing can be carried out on a finalised DVD+R. Press **RETURN** to go back to previous menu item. Press **EDIT** to exit the menu.

Editing/Finalising Recording (cont'd)

- { **Append** } - for DVD+RW only
– Select this to append record to the existing recording from the position of the playback. Continue steps 5~7.

For append recording only:

- 5 Press **▲ ▼** to select the input channel to append : { preset programme number }, { EXT1 }, { EXT 2 } or { CAM1 }.
- 6 Press **REC ●** to start append recording.
Warning! Once the recording started, any prior recording from the point of the playback onwards will be overwritten.
- 7 To stop append recording, press **STOP ■**.

Deleting chapter markers

You can choose to delete all the chapter markers in the current recording.

- 1 Follow the steps 1~3 of “Video editing” on page 47.
- 2 Press the matching colour coded button on the remote control to select { **No Chapters** }.

Photo editing

The Photo (JPEG picture) recordings on a DVD+R(W) are limited to edit the information.

The editable information items are :

- Title of the currently selected item
- Album edit name
- Photo edit date

- 1 Insert a recorded DVD+RW or an unfinalised DVD+R.
- 2 Use **◀ ▶ ▲ ▼** to select an entry in the menu.
- 3 Press **EDIT** on the remote control.
→ The edit menu appears.
- 4 Press **▲ ▼** to change the character/ number or make an entry by using the **alphanumeric keypad 0-9**.
→ Press **◀ ▶** to move to the previous or next entry field.
- 5 Press **OK** to confirm the changes.
→ The info panel is now updated.

During photo (JPEG picture) playback, you can change the photo display. However, the changes cannot be stored in the disc.

- 1 During playback, press **EDIT**.
- 2 Press **▶** to select { **Photo options** } on the screen, then press **▼** to select { **Filter** } or { **Colour Adjust** }.
- 3 Press **▶** to access to the menu, then press **▲ ▼** to select the available setting.

Helpful Hint:

- *Editing of the audio content is not possible.*

For information on organising the JPEG pictures, see pages 51~53 “Browsing the picture disc”.

TIPS: No further recording and editing can be carried out on a finalised DVD+R. Press **RETURN** to go back to previous menu item. Press **EDIT** to exit the menu.

Using the Browser

Browsing the disc

You can view and manage possible contents within your discs by using an on-screen console called the Media Browser.

- 1 Insert a disc into the DVD recorder.
→ The Index Picture screen or disc content menu appears on the TV.

(example of an DVD) (example of an DVD+RW)

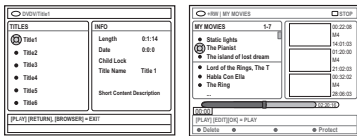

- 2 Alternatively, you can press **BROWSER** on the remote control to access the disc content menu.
- 3 Press **▶** to move to the previous/next level of information in the menu (e.g. SOURCE, ALBUM, TRACK).

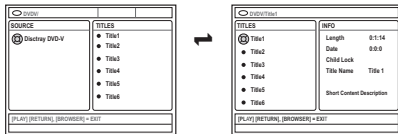

- 4 Press **▲▼** to view the detailed overview of the selected title/chapter.
→ The content is displayed within two panels, left panel displays the titles of the media and right panel displays the information of the current title.
- 5 To start playback of the current title, press **PLAY ▶**.
- 6 To change the disc content information, press **EDIT** (see page 46 "Changing the disc/title name").

Helpful Hint:

– The information showed on the display panel varies for different types of media.

Colour coded buttons functions

In the Media Browser mode, a number of functions are available via the colour coded buttons on the remote control.

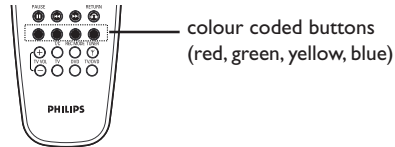

These functions are displayed in the bottom of the menu wherever applicable.

- { **Delete** }
- Delete the currently selected menu item.
- { **Protect** } / { **Unprotect** }
- Protect/unprotect the selected title in the DVD+RW. Overwrite or edit the recorded title is not possible if protected.
- { **To Album** }
- Add photo(s) to album.
- { **Select** }
- Add to the selection.
- { **Select All** }
- Add all items to the selection.
- { **Move** }
- Move photos within photo album.
- { **Remove** }
- Remove the selected item in the list.
- { **Rotate** }
- Rotate the selected photo in 90 degree clockwise increments.
- { **Zoom** }
- Activate zoom mode.
- { **Cancel** }
- Cancel the operation.

TIPS: Press **RETURN** to go back to previous menu item. Press **BROWSER** to exit the menu.

Using the Browser (cont'd)

Browsing the picture disc

The Media Browser allows you to view the JPEG pictures discs or playback as a slide show or store them in an album.

JPEG Photo can handle up to a maximum of 100 photos in one album on a DVD+RW or DVD+R from this DVD recorder; depends on the JPEG file parameters.

The supported functions are shown at the bottom of the disc content menu via the colour coded buttons on the remote control.

Adding pictures to an album

Photo roll is a folder for storing original JPEG pictures and they are protected. It is comparable with a conventional 35mm film for cameras. Rolls will be created automatically from the digital cameras.

Photo album contains different pictures on the rolls. You can delete an album without deleting the pictures of the rolls.

- 1 Press **BROWSER** on the remote control.
→ The disc content menu appears.
- 2 Press ◀▶ to select photo roll menu and press ▲▼ to select a desired photo roll folder.

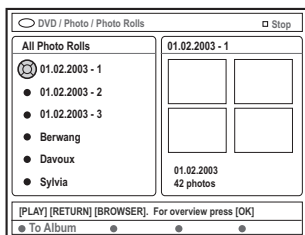

- 3 Press **OK** to display the picture overview.
→ The 12 roll thumbnails picture screen appears.

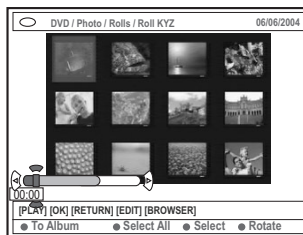

- 4 Use ◀▶▲▼ to select the photo which you wish to add to the album.
→ To make a multiple selection, press the matching colour button on the remote control to select { **Select** } to confirm each selected photo.
→ Select { **Select All** } to add all photos to the selection.
→ Select { **Rotate** } to rotate the selected photo in 90 degree clockwise increments.
- 5 Press the matching colour button on the remote control to select { **To Album** }.
→ The 'Add to Photo Album' menu appears.
- 6 Press ▲▼ to select an album or create a new album folder which you want to add photo(s) to it, then press **OK** to confirm.
→ The selected photo(s) is/are now stored in the album.

Helpful Hint:

– Do not pay attention to the order of the pictures. You can change it later in the album.

TIPS: Press **RETURN** to go back to previous menu item. Press **BROWSER** to exit the menu.

Using the Browser (cont'd)

Changing the picture order within an album

You can re-arrange the picture position in the album in order to create the desired order of the slide show. The order of the pictures in the photo roll remains unchanged.

- 1 Press **BROWSER** on the remote control.
→ The disc content menu appears.
- 2 Press ◀▶ to select photo album menu and press ▲▼ to select a desired photo album folder.

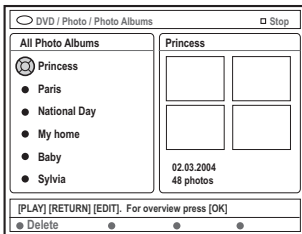

- 3 Press **OK** to display the picture overview.
→ The 12 roll thumbnails picture screen appears.

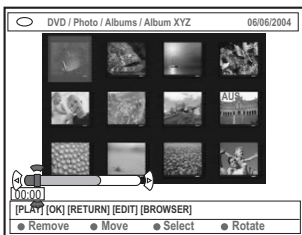

- 4 Use ◀▶▲▼ to select the photo which you wish to move to a different position.
→ To make a multiple selection, press the matching colour button on the remote control to select { **Select** } to confirm each selected photo.
→ Select { **Rotate** } to rotate the selected photo in 90 degree clockwise increments.

- 5 Press the matching colour button on the remote control to select { **Move** }.
→ A 'navigator' will appear on the menu enable you to select the position between the photos.
- 6 Use ◀▶▲▼ to move the 'navigator' around the menu and press **OK** to confirm the position where you want to insert the photo(s).
→ To cancel the move operation and return to the original entry point, press the matching colour button on the remote control to select { **Cancel** }.

Deleting an album

- 1 Press **BROWSER** on the remote control.
→ The disc content menu appears.
- 2 Press ◀▶ to select photo album menu and press ▲▼ to select the photo album folder to delete.
- 3 Press the matching colour button on the remote control to select { **Delete** }.

Deleting picture in an album

- 1 Follow steps 1~3 of "Changing the picture order within an album" on page 52.
- 2 Use ◀▶▲▼ to select the photo which you wish to delete.
→ To make a multiple selection, press the matching colour button on the remote control to select { **Select** } to confirm each selected photo.
- 3 Press the matching colour button on the remote control to select { **Remove** }.

TIPS: Press **RETURN** to go back to previous menu item. Press **BROWSER** to exit the menu.

Using the Browser (cont'd)

Changing the slide show settings

You can adjust the various slide show settings to your individual needs.

- 1 Press **BROWSER** on the remote control.
→ The disc content menu appears.
- 2 Press ◀▶ to select photo roll/album menu and press ▲▼ to select a desired photo roll/album folder.
- 3 Press **PLAY** ▶ to start slide show play.



{ Zoom }

- Select this to activate zoom mode.

In zoom mode,

- Use ◀▶ ▲▼ to pan through the zoomed image.
- Press the matching colour buttons { **Zoom Out** } or { **Zoom In** } repeatedly to select the desired zoom ratio (2x, 4x, 8x).
- Select { **End** } to exit zoom mode.

{ Repeat }

- Select this to toggle between repeat on and off.

{ Speed Down } / { Speed Up }

- Select this to change the slide show speed :

- { **SLOW** } – 10 seconds interval
- { **MEDIUM** } – 5 seconds interval
- { **FAST** } – 3 seconds interval

Protecting the recorded title (DVD+RW)

You can choose to protect the recorded title on an DVD+RW in order to prevent accidental loss of recordings.

- 1 Insert a recorded DVD+RW
- 2 Press **BROWSER** on the remote control.
→ The disc content menu appears.
- 3 Press ▲▼ to select a recorded title.
- 4 Press the matching colour coded button on the remote control to select { **Protect** }.
- If you want to overwrite or edit the protected title, press the matching colour coded button to select { **Unprotect** }.

TIPS: Press **RETURN** to go back to previous menu item. Press **BROWSER** to exit the menu.

System Menu - Preferences

Accessing to the Preferences options

- Switch on the TV set. Select the correct Video In channel at the TV.
- Press **SYSTEM-MENU** on the remote control.
→ The system menu appears on TV.
- Press ▼ to select { **Preferences** }.

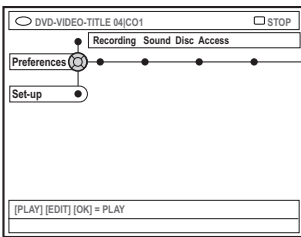

- Press ► repeatedly to select one of the options from { Preferences } and press ▼ to select a setting you want to adjust.
→ Instructions for adjusting the settings are provided in the following pages.
- Press ► to enter its options and use ◀▶▲▼ to make your selection.
→ If the selection in the menu is greyed out, that means the feature is not available or not possible to change at the current state.
- Press ◀ to confirm.
- To exit, press **SYSTEM-MENU**.

Recording

For more information on this menu, please see pages 36~38 "Recording settings".

Sound

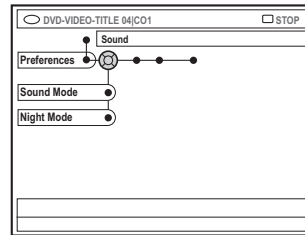

{ Sound mode }

You can select from the following settings how sound will be played back by devices connected to the analogue outputs (L/R AUDIO OUT).

- { **Stereo** } : To hear sound from the left and right audio channels. Use this setting when the DVD recorder is connected to a stereo TV.
- { **Surround** } : For audio device that is compatible with Dolby Surround. Dolby Digital and MPEG-2 multi-channel are mixed to a Dolby Surround-compatible two-channel output signal.

{ Night mode }

Allows you to optimise the sound dynamics at low volume. This causes less disturbance in quiet environments. This setting only functions with Dolby Digital Audio on DVDs.

- { **On** } : Select this to level out the volume. High volume outputs will be softened and low volume outputs are brought upward to an audible level.
- { **Off** } : Select this when you want to enjoy the surround sound with its full dynamic range.

TIPS: Underlined option is the factory default setting.
Press ◀ to go back to previous menu item. Press **SYSTEM-MENU** to exit the menu.

System Menu - Preferences (cont'd)

Disc

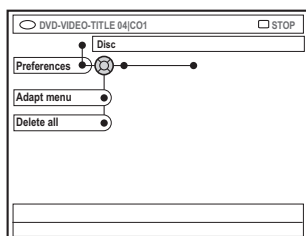

{ Adapt menu }

If a DVD+RW has been recorded in a computer drive or in another DVD recorder, the Picture Index screen may not be displayed correctly. This feature allows you to change the format of the disc to 'Philips' type.

- Select { Adapt menu } and press **OK**.
A message to confirm your action will appear on the TV, press **OK** again to proceed. Otherwise, press **◀** to exit.

{ Delete all }

Allows you to delete all the recordings from the current DVD+RW or DVD+R.

- Select { Delete all } and press **OK**.
A message to confirm your action will appear on the TV, press **OK** again to proceed. Otherwise, press **◀** to exit.

Access

For more information on this menu, please see pages 59~60 "Setting Access Control".

Features

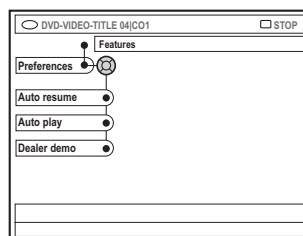

{ Auto resume }

Auto resume affects the last 20 DVDs and Video CDs you played.

- { **On** } : Play resumes where you last stopped playing the disc.
- { **Off** } : Play starts at the beginning of the disc..

{ Auto play }

When auto play is active, the system will start playback once you insert the disc.

- { **On** } : Play starts automatically once you insert the disc.
- { **Off** } : A dialogue appears on the TV once you insert the disc.

{ Dealer demo }

Allows you to display your demo according to the following options:

- { **Off** } : Turn off dealer mode.
- { **On** } : The DVD recorder's display panel will show various features offered by the system while in standby mode.

TIPS: Underlined option is the factory default setting.
Press **◀** to go back to previous menu item. Press **SYSTEM-MENU** to exit the menu.

System Menu - Setup

Accessing to the Setup options

- 1 Turn on the TV set. Select the correct Video In channel at the TV.
- 2 Press **SYSTEM-MENU** on the remote control.
→ The system menu appears on TV.
- 3 Press **▼** repeatedly to select { **Set-up** }.
→ Playback will pause.

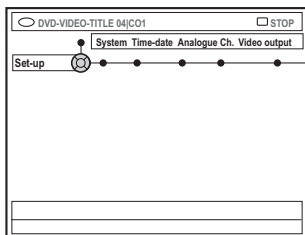

- 4 Press **▶** repeatedly to select one of the options from { Set-up } and press **▼** to select a setting you want to adjust.
→ Instructions for adjusting the settings are provided in the following pages.
- 5 Press **▶** to enter its options and use **◀▶▲▼** to make your selection.
→ If the selection in the menu is greyed out, that means the feature is not available or not possible to change at the current state.
- 6 Press **◀** to confirm.
- 7 To exit, press **SYSTEM-MENU**.

System

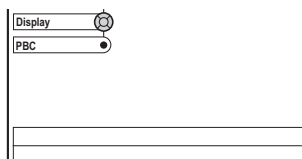
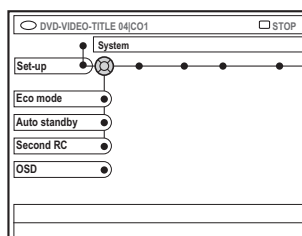

{ Eco Mode }

When switching the DVD recorder to standby mode, the display panel will turn blank to save power.

- { **On** } : Turn on Eco mode.
- { **Off** } : Turn off Eco mode.

{ Auto standby }

The system will automatically turn on to standby mode if you do not press any buttons within 15 minutes after a disc has stopped playing or in Browser mode. This is a power-saving feature.

- { **On** } : Turn on Auto standby mode.
- { **Off** } : Turn off Auto standby mode.

{ Second RC }

Allows you to control the DVD recorder with a second remote control (not supplied).

- { **On** } : Enable second RC control.
- { **Off** } : Disable second RC control.

TIPS: Underlined option is the factory default setting.
Press **◀** to go back to previous menu item. Press **SYSTEM-MENU** to exit the menu.

System Menu - Setup (cont'd)

{ OSD }

Select the level of On-screen display information.

- { **Full** } : Complete information always display during use.
- { **Reduced** } : The help text and colour button bar will remove from the display.
- { **Normal** } : The help-text will remove from the menu.

{ Display }

Allows you to change the brightness of the DVD recorder display panel.

- { **Bright** } : Normal brightness.
- { **Dimmed** } : Medium brightness.
- { **Off** } : Turn off the display.

{ PBC } - for VCD only

Play Back Control allows you to play Video CDs (2.0) interactively, following the menu on the display.

- { **On** } : The index menu (if available) will appear on the TV once you insert a VCD.
- { **Off** } : The VCD will skip the index menu and playback directly from the beginning.

{ Version Info }

It provides the software version information for online upgrade.

Time-date

For more information on this menu, please see page 27 "Setting the Time and Date".

Analogue channels

For more information on this menu, please see pages 23~27 "TV Channel Programming".

Video output

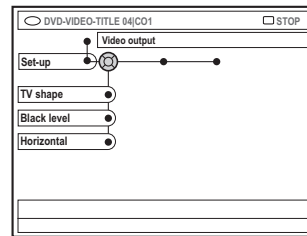

{ TV shape }

The picture shape can be adjusted to fit your TV.

- { **4:3 letterbox** } :
For a 'wide-screen' display with black bars on the top and bottom.
- { **4:3 panscan** } :
For a full-height picture with the sides trimmed.
- { **16:9** } : For wide-screen TV (frame ratio 16:9).

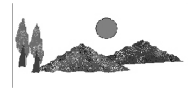

{ Black level }

Adapts the colour dynamic for NTSC disc.

- { **Normal** } : Normal colour contrast.
- { **Enhance** } : Improve the colour contrast and brighten the picture of NTSC-compatible DVD.

{ Horizontal }

Allows you to adjust the horizontal position of the picture on your TV screen.

- Press ◀ ▶ to scroll the slider to the left or right. When you are satisfied with the position of the picture, press ▼.

TIPS: Underlined option is the factory default setting.
Press ◀ to go back to previous menu item. To exit, press **SYSTEM-MENU**.

System Menu - Setup (cont'd)

{ Video output }

Choose the type of video output that matches the video connection between the DVD recorder and your TV.

- { **RGB•CVBS** } : For RGB or CVBS connection.
- { **S-Video** } : For S-Video connection.
- { **Automatic** } : The output setting will automatically follow the video signal received.

Language

For more information on this menu, please see page 28 "Setting the language".

Audio output

After connecting the DVD recorder to your TV and other devices, you may need to change the digital output setting. Adjust the Digital Output only if you used the DVD recorder's COAXIAL socket.

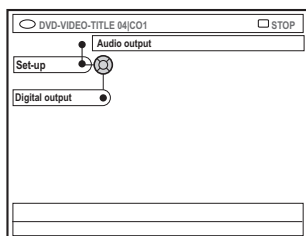

{ Digital output }

- { **All** } : Select this if you use the COAXIAL socket to connect the DVD recorder to a stereo receiver that has a built-in Multi-Channel decoder.
- { **PCM** } : Select this if the connected audio equipment is not capable of decoding multichannel audio. Dolby Digital and MPEG-2 multi-channel signals are converted to PCM (Pulse Code Modulation).
- { **Off** } : Select this to deactivate the digital audio output. For example, if you use the AUDIO OUT sockets to connect the DVD recorder to a TV or Stereo system.

TIPS: Underlined option is the factory default setting.
Press ◀ to go back to previous menu item. Press **SYSTEM-MENU** to exit the menu.

Setting Access Control

About Access Control

Access Control limits viewing of discs that exceed the limits you set. Philips cannot guarantee the availability of Access Control with all discs, and therefore denies any liability associated with unintended watching of discs.

Setting or changing the pin code

Enter your four-digit password to play a prohibited disc or if prompted for a pin code.

- 1 Press **SYSTEM-MENU** on the remote control.
→ The system menu appears on the TV.
- 2 Press ▼ to select { **Preferences** }.
- 3 Press ► repeatedly to select { **Access** } and press ▼ to confirm.
- 4 Use the **alphanumeric keypad 0-9** to enter your four-digit pin code.
→ When doing this for the first time, enter any four-digit you prefer. You must enter the same pin code a second time to confirm it.
→ If you forgot your four-digit pin code, use the **Alphanumeric keypad 0-9** on the remote control to key in '1504' and followed by **OK** button. Then, enter any four-digit you prefer.
- 5 Press ▼ repeatedly to select { **Change pin** } and press ► to confirm.

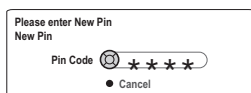

- 6 Use the **alphanumeric keypad 0-9** to enter your new four-digit pin code. You must enter the same pin code a second time to confirm it.
→ To cancel your change, press ▼ to select { **Cancel** } and press **OK** to confirm.

Activating/Deactivating the child lock

This function can prevent children from viewing discs. This DVD recorder can memorise settings for 50 discs. When in use, a four-digit pin code must be entered in order to play a disc.

- 1 Press **SYSTEM-MENU** on the remote control.
→ The system menu appears on the TV.
- 2 Press ▼ to select { **Preferences** }.
- 3 Press ► repeatedly to select { **Access** } and press ▼ to confirm.
- 4 Use the **alphanumeric keypad 0-9** to enter your four-digit pin code (see page 59 "Setting or changing the pin code").
- 5 Press ▼ to select { **Child lock** }.

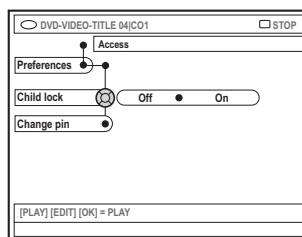

- 6 Press ► to select { **On** } or { **Off** } setting and press ◀ to confirm.
→ If you turn on the child lock feature, you will need to enter the four-digit pin code in order to play locked discs.

TIPS: Press ◀ to go back to previous menu item. Press **SYSTEM-MENU** to exit the menu.

Setting Access Control (cont'd)

Alternatively, we can lock the disc while in browser mode;

- 1 Press the **BROWSER** on the remote control.
→ The disc content menu appears.
- 2 Press the matching colour coded button on the remote control to select { **ChildLock** }.
→ The disc is now locked. You must enter the four-digit pin code the next time when you insert the disc.

Helpful Hint:

– Two-sided DVDs and multi-volume discs may have a different ID for each side/volume. To completely unlock these discs, you must authorise each side/volume separately.

Authorising discs

You can enable playback of a locked disc by entering the four-digit pin code, however, it will only allow play once.

- 1 Insert the disc.
→ If the disc has been locked (child lock on,) the pin code entry menu will appear on the TV.
- 2 Use the **alphanumeric keypad 0-9** to enter your four-digit pin code (see page 59 “Setting or changing the pin code”).
→ Playback will begin.

If you later decide to unlock the disc and allow play always;

- Follow the steps described in “Activating/ Deactivating the child lock” and select { **Off** } in the menu.

TIPS: Press ◀ to go back to previous menu item. Press **SYSTEM-MENU** to exit the menu.

WARNING

Under no circumstances should you try to repair the system yourself, as this will invalidate the warranty. Do not open the system as there is a risk of electric shock.

If a fault occurs, first check the points listed below before taking the system for repair. If you are unable to remedy a problem by following these hints, consult your dealer or Philips for help.

Problem	Solution
<p>No power.</p>	<ul style="list-style-type: none"> - Press STANDBY-ON button on the front of the DVD recorder to turn on the system. - Make sure the AC outlet has power.
<p>The message "IS THE TV ON?" appears on the display panel.</p>	<ul style="list-style-type: none"> - The DVD recorder will not operate until you complete the first installation. Read chapter "Installing the DVD Recorder - First Installation" for details.
<p>The buttons on the DVD recorder do not work.</p>	<ul style="list-style-type: none"> - The DVD recorder may be in Dealer mode, all buttons on the front of the DVD recorder are locked. To deactivate the dealer mode : <ol style="list-style-type: none"> 1) Disconnect the power cord from the power outlet. 2) Press and hold STOP button and OPEN/CLOSE on the front of the recorder while you reconnect the power cord to the power supply. 3) As soon as the time or '00:00' appears on the display (within 6-10 seconds), release the buttons. - There is a technical problem. Disconnect the DVD recorder from the power outlet for 30 seconds, then connect again. If the DVD recorder still will not operate, then reset it to the default factory settings : <ol style="list-style-type: none"> 1) Disconnect the DVD recorder from the power outlet. 2) Press and hold down STANDBY-ON button on the front of the recorder while reconnecting to the power outlet. 3) Release STANDBY-ON button when "IS THE TV ON?" appears on the display. All the information stored in the memory (programmes, time) will be cleared. Complete the first installation again and reset any items you have adjusted during your use of the recorder.
<p>Remote control does not work.</p>	<ul style="list-style-type: none"> - Aim the remote control directly at the sensor on the front of the DVD recorder (not towards TV). If the DVD recorder receives a signal from the remote control, icon  will appear on the display. - Remove any obstacles between DVD recorder and the remote control. - Batteries are weak, replace the batteries. - Press DVD-MODE on the remote control.

Troubleshooting (cont'd)

Problem	Solution
Disc will not play.	<ul style="list-style-type: none">– Insert the disc with the label facing up.– The child lock is on. Read chapter “Setting Access Control - Activating/Deactivating the child lock” for details.– Wrong region code. The DVD must be coded for ALL regions or Region 2 in order to play on this DVD recorder.– There is no recording on the disc or wrong disc type. Read chapter “Playback - Playable discs” for details.– Make sure the disc is not scratched or warped. Clean the disc or replace a new one.– Check if the disc is defective by trying another disc.
No picture.	<ul style="list-style-type: none">– Turn on your TV and set to the correct Video In channel. Change the TV channel until you see the DVD screen. Read chapter “Connecting to TV - General” for details.– Check the video connection between the DVD recorder and the TV.
The picture is distorted or black and white during playback.	<ul style="list-style-type: none">– The disc does not match with the TV colour system standard (PAL/NTSC).– The disc is dirty, clean the disc.– Sometimes a small amount of picture distortion may appear. This is not a malfunction.– If you set the Record Mode to a low-quality speed, change to a higher-quality speed after you finish recording. Leaving the DVD recorder set to a low-quality speed may affect the picture quality when playing DVDs later. Read chapter “Recording - Recording settings” for details.– The recording can be made in colour only when the TV channels or the connected additional device sends a colour signal. In some situations, programmes that are broadcast in black and white cannot be recorded.
There is picture or sound interference with the TV reception.	<ul style="list-style-type: none">– Have your antenna or cable TV signal checked.– Fine-tune your TV channel. Read chapter “Installing the DVD Recorder - Fine tuning the TV channels” for details.
Distorted sound coming from a connected hi-fi amplifier.	<ul style="list-style-type: none">– Do not connect any cables from the DVD recorder to the 'Phono' input of your amplifier.– Do not connect the DVD recorder's Coaxial DIGITAL AUDIO OUT socket to an analogue socket (red/white) on the connecting devices.
No sound.	<ul style="list-style-type: none">– Check the audio connections, the red and white sockets. Read chapters “Connecting to TV” or “Connecting to Additional Devices” for details.– You cannot hear MP3 playback if you are using the Coaxial DIGITAL AUDIO OUT socket for sound from the DVD recorder.– Set the Analogue output or Digital output correctly, based on the equipment you connected to the DVD recorder. Read chapter “System Menu - Setup” for details.

Troubleshooting (cont'd)

Problem	Solution
<p>Recordings are not occurring as scheduled. New recordings cannot be made.</p>	<ul style="list-style-type: none">- The TV channel you want to record is not stored or you selected the wrong programme number. Check TV channels stored.- If you adjust the clock after you set a timer recording, reset the timer recording.- If the DVD recorder cannot read the disc, you cannot record.- You cannot use the DVD recorder to duplicate copyrighted materials (DVDs or videotapes) onto a DVD+RW/+R, "COPY PROTECT" will be displayed.- A finalised DVD+R has been inserted. Change disc.
<p>The wrong TV channel was decoded (recorded) after you programmed a recording using the ShowView system.</p>	<ul style="list-style-type: none">- 'VPS/PDC' is turned on but 'VPS/PDC time' is wrong. Enter the exact 'VPS/PDC time'.<ol style="list-style-type: none">1) Enter the ShowView programming number of the desired TV channel.2) Press OK to confirm.3) Check the channel number in the {Ch.} input field. If this does not correspond to the desired TV channel, select this entry field and change the channel number.4) Press OK to confirm.
<p>A DVD+RW or DVD+R recorded on this DVD recorder will not play on a DVD player.</p>	<ul style="list-style-type: none">- If a recording is too short, it is possible that a DVD player cannot detect it. Please observe the following 'minimum recording times'. Recording mode : {M1} – 5 minutes, {M2}– 10 minutes, {M2x} – 13 minutes, {M3} – 15 minutes, {M4} – 20 minutes, {M6} – 30 minutes, {M8} - 30 minutes.- Some DVD players cannot playback DVD+RW recordings. You can solve this problem by using a special function :<ol style="list-style-type: none">1) Press OPEN/CLOSE on the DVD recorder to open the disc tray.2) Insert the disc but do not close the tray.3) Hold down the number button {2} on the remote control until the tray closes. The disc is modified.4) If this fails to produce the desired result, repeat the procedure using the number button {3} on the remote control.5) You can restore the disc to its original condition by pressing and holding number button {1}.<p>Warning! There is a risk that you can no longer play the disc on other DVD players after the following procedure. Therefore, apply this function with particular care.</p>

Troubleshooting (cont'd)

Problem	Solution
The message 'Disc contains unknown data' appears.	<ul style="list-style-type: none">- This message may appear if you insert a disc that was not finalised. DVD+R's that have not been finalised are very sensitive to fingerprints, dust, or dirt. This may cause problems during recording. To use the disc again, do the following :<ol style="list-style-type: none">1) Make sure that the surface of the disc is clean.2) Press OPEN/CLOSE on the DVD recorder to open the disc tray.3) Insert the disc but do not close the tray.4) Hold down button number {5} on the remote control until the tray closes. The DVD recorder will start the repair process.5) If the disc is recovered, the Picture Index screen will appear. <p>Please observe the following:</p> <ul style="list-style-type: none">- Error during recording : The title may be missing.- Error while changing the title/index picture : The original title/index picture may be visible.- Error while finalising : The disc appears not to have been finalised.
The index screen flickers when a DVD+R is inserted.	<ul style="list-style-type: none">- You can finalise the disc using the following function:<ol style="list-style-type: none">1) Press OPEN/CLOSE on the DVD recorder to open the disc tray.2) Insert the disc but do not close the tray.3) Hold down button number {4} on the remote control until the tray closes. 'FINALISING' appears on the display panel.4) If finalising has been successful, the Picture Index screen will appear.
Picture is fuzzy and brightness varies when copying DVD Video discs or prerecorded video cassettes.	<ul style="list-style-type: none">- This happens if you try to copy DVDs or video cassettes that have been copy-protected. Even though the picture on the TV is fine, but the recording on a DVD+R(W) is faulty. This interference is unavoidable with copy-protected DVDs or video cassettes.- The DVD+R(W) has recording lifetime, please change a new disc for recording.
The message 'NO SIGNAL' appears.	<ul style="list-style-type: none">- Check that the cable is plugged in firmly.- If a recording is made from a video recorder, change the tracking on the video recorder.- The DVD recorder may not be able to recognise the video input signal if this signal is poor or does not comply with relevant standards.



Troubleshooting (cont'd)

Problem	Solution
The message 'Recording of <XX> will start within 1 minute' appears.	<ul style="list-style-type: none">- Select { Switch now } to switch the DVD recorder to standby mode. A programmed timer recording will only start recording if the DVD recorder is in standby mode.- Select { Suspend } will suspend the timer recording.- Select { Cancel recording } will cancel the timer recording.
The message 'Insert recordable disc' appears.	<ul style="list-style-type: none">- Either no disc was inserted or a disc was inserted that cannot be used for recordings. Insert a disc that can be recorded upon. Locate on the disc the right position for the recording. Press STOP button. Turn off the DVD recorder by pressing STANDBY-ON button.
The message 'Maximum number of timers reached' appears.	<ul style="list-style-type: none">- It has reached the maximum programmed, no more recordings are allowed. Press TIMER button, select the programmed recording (TIMER block) you want to check or clear using ▲ ▼ button.
The message 'Collision' appears.	<ul style="list-style-type: none">- The timer recording overlaps with another timer recording.- If you ignore this warning, the programmed recording with the early start time will start first. The second recording will then lack the beginning.- Change the information for one of the two recordings.- Delete one of the two recordings.

Display panel symbols/messages

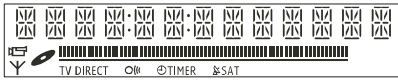
The following symbols/messages may appear on your DVD recorder display:



- **00:00**
Multifunction display/text line
 - Title/track number
 - Total/elapsed/remaining title/track time
 - Disc/title name
 - Error or warning messages
 - Additional information regarding the disc
 - TV channel number or source of video
 - Clock (This is displayed in Standby mode).
 - TV programme title
- 
– **Disc bar:** Displays the current position on the disc.
- **Play/Record:** The single flashing segment represents the current position of the disc pointer.
- **Pause:** Indicated by the flashing segment on both sides of the current position.
- **Stop:** Indicated by the flashing segment at the current position.
- 
Tuner is selected as visible source.
- 
Disc is the current active source.
- **TV**
Modulator is turned off. The antenna signal (RF signal) is only connected to the TV when the modulator is turned off.
- **O(t)**
Remote control command for the DVD recorder has been received.
- **⏰ TIMER**
A timer recording has been programmed or is active.
- **📡 SAT**
The DVD recorder is prepared for satellite recording.
- **BLOCKED**
The disc tray cannot be opened or closed due to some mechanical obstruction.
- **COMPATIBLE**
The DVD Recorder is busy making changes to make the disc DVD-compatible.
- **CLOSING**
Disc tray is closing.
- **COPY PROT**
The DVD/video cassette you are trying to copy is copy-protected.
- **DISC ERR**
An error occurred when writing the title. If this happens often, please clean the disc or use a new one.
- **DISC FULL**
Disc is full. There is no room for new recordings.
- **DISC UPDATE**
 - Updating of disc is done after the editing is complete.
 - Entire disc is being erased.
- **DISC WARN**
An error occurred when writing the title. The recording will continue, but the error will be skipped.
- **EMPTY DISC**
Inserted disc is new or has been completely erased (no recordings present).
- **DISC UPDATE**
Entire disc is being erased.
- **FINALISE**
The DVD+R disc is being finalised. The progress bar on the LED shows the status of the finalisation process.
- **EMPTY TITLE**
An empty title was selected.
- **INFO DVD**
Information on the inserted DVD is displayed on the screen.
- **CREATE MENU**
After the first recording has been successfully complete on a new disc, the menu structure is created.

Display panel symbols/messages (cont'd)

- *IS THE TV ON?*
The DVD Recorder is currently in the first installation mode. Turn on your TV and read the section, 'First installation', in the chapter 'Installing the DVD Recorder'.
- *MAX TITLE*
The maximum number of titles has been reached for the disc. Each disc can have a maximum of 49 titles.
- *MAX CHAP*
The maximum number of chapters per title/disc has been reached. The maximum number of chapters per title is 99, and 255 per disc.
- *SYS MENU*
The on-screen menu display is on.
- *MENU UPDATE*
After a successful recording, the list of disc contents is updated.
- *NO DISC*
No disc has been inserted. If a disc has been inserted, then it is possible that the disc cannot be read.
- *NO SIGNAL*
No signal or poor signal strength.
- *NTSC DISC*
A disc with NTSC recordings has been inserted and an attempt was made to record a PAL signal. Insert a new disc or use a disc containing PAL recordings.
- *OPENING*
Disc tray is opening.
- *PAL DISC*
A disc with PAL recordings has been inserted and an attempt was made to record an NTSC signal. Insert a new disc or use a disc containing NTSC recordings.
- *PHILIPS*
The DVD recorder has been turned on.
- *PHOTO MMM/NNN*
Number of the current photo (for Photo mode). MMM represents the order of the current photo, NNN represents the total number of photos in the album. If the number exceeds 999, '999' will be displayed instead.
- *POST FORMAT*
The disc is being prepared after the menu structure has been created.
- *PROTECTED*
Title is copy-protected and cannot be recorded.
- *READING*
Disc is being recognised by the DVD recorder.
- *RECORDING*
A recording is currently in progress.
- *INSTALL*
After the automatic channel search, the menu for setting the time/date appears on the screen.
- *STANDBY*
The DVD recorder has been turned off.
- *TRAY OPEN*
Disc tray is open.
- *VCD*
AVCD has been loaded into the DVD recorder.
- *WAIT*
Please wait until this message disappears. The DVD Recorder is busy processing an operation.

Specifications

Disc types

Recording : DVD+RW/+R
Playing: DVD-Video, Video CD,
SuperVCD, Audio CD, MP3 CD, Picture CD,
CD-R/RW, DVD-R, DVD-RW

Record modes

recording time / picture quality

M1: 60 minutes / high quality
M2: 120 minutes / DVD quality
M2x: 150 minutes / DVD quality
M3: 180 minutes / S-VHS quality
M4: 240 minutes / VHS quality
M6: 360 minutes / VHS quality
M8: 480 minutes / VHS quality

TV systems

Playback: PAL/NTSC
Recording: PAL/NTSC
Internal tuner: PAL/SECAM

Video Performance

DA Converter 10 bit, 54 MHz
DA Converter 10 bit, 54 MHz

Audio

Recording Dolby Digital
2-channel
Playback Dolby Digital, DTS.
MPEG2 Multichannel,
MPEG1 layer 3 (MP3), PCM

Audio Performance

DA Converter 24 bit, 192 kHz
AD Converter 24 bit, 96 kHz
Signal / Noise (1kHz) 105 dB
Dynamic range (1kHz) 90 dB
Cross-talk (1kHz) 105 dB
Distortion / Noise (1kHz) 90 dB

Rear Connections

- Scart 1 (cvbs, S-video/rgb out)
- Scart 2 (cvbs, S-video/rgb in, decoder)
- S-video out
- Video out (cvbs)
- Audio left/right out
- Digital audio out (coaxial)
- RF antenna in
- RF TV out
- Mains

Front Connections

- i.LINK DV in (IEEE 1394 4-pin)
(DVDR615 and DVDR616)
- S-video in
- Video in
- Audio left/right in

Timer Recording

- 1-month timer programming, 6 events
- daily/weekly repeat recording
- ShowView /Video Plus+ programming
- VPS/PDC recording control

Interoperability

- i.LINK DV camcorder control (DVDR615
and DVDR616)
- FollowTV
- Direct Record

Video Editing Functions

- Automatic/Manual Chapter Marker
insertion
- Append
- Divide

Digital Photo Manager

- Create albums
- Zoom, Rotate, Flip

Power Supply

- 220-230V, ~50 Hz
- 27 W power consumption (operation)
- 3 W power consumption (eco standby)

Cabinet

Dimensions (wxhxd) : 435 x 71 x 298 mm
Net Weight : 3.5 kg

Analogue: Sound that has not been turned into numbers. Analogue sound varies, while digital sound has specific numerical values. These jacks send audio through two channels, the left and right.

Aspect ratio: The ratio of vertical and horizontal sizes of a displayed image. The horizontal vs. vertical ratio of conventional TVs. is 4:3, and that of wide-screens is 16:9.

AUDIO OUT Jacks: Red and white jacks on the back of the system that send audio to another system (TV, Stereo, etc.).

Chapter: Sections of a picture or a music piece on a DVD that are smaller than titles. A title is composed of several chapters. Each chapter is assigned a chapter number enabling you to locate the chapter you want.

Digital: Sound that has been converted into numerical values. Digital sound is available when you use the DIGITAL AUDIO OUT COAXIAL or OPTICAL jacks. These jacks send audio through multiple channels, instead of just two channels as analogue does.

Disc menu: A screen display prepared for allowing selection of images, sounds, subtitles, multi-angles, etc recorded on a DVD.

Dolby Digital: A surround sound system developed by Dolby Laboratories containing up to six channels of digital audio (front left and right, surround left and right, centre and subwoofer).

DTS: Digital Theatre Systems. This is a surround sound system, but it is different from Dolby Digital. The formats were developed by different companies.

Index Picture Screen: A screen that gives an overview of a DVD+RW or DVD+R. An Index Picture represents each recording.

JPEG: A very common digital still picture format. A still-picture data compression system proposed by the Joint Photographic Expert Group, which features small decrease in image quality in spite of its high compression ratio.

MP3: A file format with a sound data compression system. "MP3" is the abbreviation of Motion Picture Experts Group 1 (or MPEG-1) Audio Layer 3. By using the MP3 format, one CD-R or CD-RW can contain about 10 times more data than a regular CD.

MPEG: Motion Picture Experts Group. A collection of compression systems for digital audio and video.

Multichannel: DVDs are formatted to have each sound track constitute one sound field. Multichannel refers to a structure of sound tracks having three or more channels.

PBC: Playback Control. Refers to the signal recorded on video CDs or SVCDs for controlling playback. By using menu screens recorded on a Video CD or SVCD that supports PBC, you can enjoy interactive playback and searching.

PCM: Pulse Code Modulation. A digital audio encoding system.

Region code: A system allowing discs to be played only in the region designated. This unit will only play discs that have compatible region codes. You can find the region code of your unit by looking on the product label. Some discs are compatible with more than one region (or ALL regions).

S-Video: Produces a clear picture by sending separate signals for the luminance and the colour. You can use S-Video only if your TV has an S-Video In jack.

Surround: A system for creating realistic three-dimensional sound fields full of realism by arranging multiple speakers around the listener.

Title: The longest section of a movie or music feature on DVD. Each title is assigned a title number, enabling you to locate the title you want.

VIDEO OUT jack: Yellow jack on the back of the DVD system that sends the DVD picture video to a TV.

TV System Guide

COUNTRY	VHF	UHF	DVD REGIONS
AFGHANISTAN	PAL/SECAM B		5
ALBANIA	PAL B	PAL G	2
ALGERIA	PAL B	PAL G	5
ANGOLA	PAL I		5
ARGENTINA	PAL N	PAL N	4
AUSTRALIA	PAL B	PAL H	4
AUSTRIA	PAL B	PAL G	2
AZORES	PAL B		
BAHAMAS	NTSC M		4
BAHRAIN	PAL B	PAL G	2
BANGLADESH	PAL B		5
BARBADOS	NTSC M		4
BELGIUM	PAL B	PAL H	2
BERMUDA	NTSC M		
BOLIVIA	NTSC M	NTSC M	4
BOTSWANA	PAL I		5
BRAZIL	PAL M	PAL M	4
BRUNEI	PAL B	PAL B	
BULGARIA	SECAM D	SECAM K	2
BURKINA FASO	SECAM K1		5
BURMA	NTSC M		
BURUNDI	SECAM K1		5
CAMBODIA	NTSC M		3
CAMEROON	PAL B	PAL G	5
CANADA	NTSC M	NTSC M	1
CANARY ISLANDS	PAL B		2
CHAD	SECAM K1		5
CHILE	NTSC M	NTSC M	4
CHINA	PAL D		6
COLOMBIA	NTSC M	NTSC M	4
COSTA RICA	NTSC M	NTSC M	4
CROATIA	PAL B	PAL G	2
CUBA	NTSC M	NTSC M	4
CYPRUS	PAL B	PAL G	
CZECH REPUBLIC	PAL D	PAL K	2
DAHOMY	SECAM K1		
DENMARK	PAL B	PAL G	2
DJIBOUTI	SECAM B	SECAM G	5
DOMINICAN REP	NTSC M	NTSC M	4
ECUADOR	NTSC M	NTSC M	4
EGYPT	SECAM B/PAL B	SECAM G/PAL G	2
EL SALVADOR	NTSC M	NTSC M	4
EQUAT. GUINEA	PAL B		5
ESTONIA	PAL B (was SECAM)	PAL D	5
ETHIOPIA	PAL B	PAL G	5
FIJI	PAL B		
FINLAND	PAL B	PAL G	2
FRANCE	SECAM L	SECAM L	2
FRENCH POLYNESIA	SECAM K1		
GABON	SECAM K1		5
GAMBIA	PAL I		5
GERMANY	PAL B	PAL G	2
GHANA	PAL B	PAL G	5
GIBRALTAR	PAL B	PAL H	2
GREECE	PAL B (was SECAM)	PAL G	2
GREENLAND	NTSC/PAL B		2
GUADELOUPE	SECAM K1		
GUAM	NTSC M		1
GUATEMALA	NTSC M	NTSC M	4
GUINEA	PAL K		5
GUYANA (FRENCH)	SECAM K1		4
HONDURAS	NTSC M	NTSC M	4

TV System Guide (cont'd)

COUNTRY	VHF	UHF	DVD REGIONS
LIBYA	SECAM B	SECAM G	5
LITHUANIA	PAL D (was SECAM)	PAL K	5
LUXEMBOURG	PAL B/SECAM L	PAL G/SEC L	2
MADAGASCAR	SECAM K1		5
MADEIRA	PAL B		
MALAGASY	SECAM K1		
MALAWI	PAL B	PAL G	5
MALAYSIA	PAL B		3
MALI	SECAM K1		5
MALTA	PAL B	PAL H	2
MARTINIQUE	SECAM K1		
MAURITANIA	SECAM B		5
MAURITIUS	SECAM B		5
MEXICO	NTSC M	NTSC M	4
MONACO	SECAM L		2
MONGOLIA	SECAM D		5
MOROCCO	SECAM B		5
MOZAMBIQUE	PAL B		5
NAMIBIA	PAL I		5
NEPAL	PAL B		
NETHERLANDS	PAL B	PAL G	2
NETH. ANTILLES	NTSC M	NTSC M	
NEW CALEDONIA	SECAM K1		
NEW GUINEA	PAL B	PAL G	4
NEW ZEALAND	PAL B	PAL G	4
NICARAGUA	NTSC M	NTSC M	4
NIGER	SECAM K1		5
NIGERIA	PAL B	PAL G	5
NORWAY	PAL B	PAL G	2
OMAN	PAL B	PAL G	2
PAKISTAN	PAL B		5
PANAMA	NTSC M	NTSC M	4
PARAGUAY	PAL N	PAL N	4
PERU	NTSC M	NTSC M	4
PHILIPPINES	NTSC M	NTSC M	3
POLAND	PAL D	PAL K	2
PORTUGAL	PAL B	PAL G	2
PUERTO RICO	NTSC M	NTSC M	1
QATAR	PAL B		2
REUNION	SECAM K1		
RUMANIA	PAL D	PAL K	2
RUSSIA	SECAM D	SECAM K	5
RWANDA	SECAM K1		5
SABAH/SAWARA	PAL B		
ST. KITTS	NTSC M	NTSC M	
SAMOA (US)	NTSC M		1
SAUDI ARABIA	SECAM-B/PAL-B	SECAM G	2
SENEGAL	PAL		5
SEYCHELLES	PAL B	PAL G	5
SIERRA LEONE	PAL B	PAL G	5
SINGAPORE	PAL B	PAL G	
SLOVAK REPUBLIC	PAL	PAL	2
SOMALIA	PAL B	PAL G	5
SOUTH AFRICA	PAL I	PAL I	2
SPAIN	PAL B	PAL G	2
SRI LANKA	PAL B		5
SUDAN	PAL B	PAL G	5
SURINAM	NTSC M	NTSC M	4
SWAZILAND	PAL B	PAL G	
SWEDEN	PAL B	PAL G	2
SWITZERLAND	PAL B	PAL G	2
SYRIA	SECAM B		2

English

Meet Philips at the Internet
<http://www.philips.com>
<http://www.p4c.philips.com>

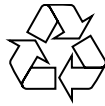

DVDR610
DVDR615
DVDR616



3139 246 13454



SgpJP-0440-00-1

Free Manuals Download Website

<http://myh66.com>

<http://usermanuals.us>

<http://www.somanuals.com>

<http://www.4manuals.cc>

<http://www.manual-lib.com>

<http://www.404manual.com>

<http://www.luxmanual.com>

<http://aubethermostatmanual.com>

Golf course search by state

<http://golfingnear.com>

Email search by domain

<http://emailbydomain.com>

Auto manuals search

<http://auto.somanuals.com>

TV manuals search

<http://tv.somanuals.com>