



SPF3470/G7 • SPF3470X/G7
SPF3480/G7 • SPF3480X/G7
SPF3400/G7 • SPF3400C/G7

Digital PhotoFrame

User Manual

www.philips.com/welcome

PHILIPS

Copyright

No part of this publication may be reproduced, transmitted, transcribed, stored in a retrieval system or translated into any language or computer language, in any form or by any means, electronic, mechanical, magnetic, optical, chemical, manual or otherwise, without the prior written permission of the company.

Disclaimer

The company makes no representations or warranties, either expressed or implied, with respect to the contents hereof and specifically disclaims any warranties, merchantability or fitness for any particular purpose. Further, the company reserves the right to revise this publication and to make changes from time to time in the contents hereof without obligation to notify any person of such revision or changes.

Safety instructions

Before operating the PhotoFrame, carefully read and follow the instructions below.

- Retain this User Manual for future reference.
- Read the safety and operating instructions carefully before using the product. All warnings on the product and in the operating instructions should be observed.
- Do not place this product under direct sunlight or near heat sources, such as in a closed car under sunlight or near a stove. The outer casing of this product may become deformed and the sophisticated sensors inside may become damaged due to excessive heat.
- Do not use this product near water, in the rain or allow any liquid to get inside this product. Water and moisture may cause short-circuit to the electronic components and lead to malfunctions.

- Do not use this product near strong electromagnetic sources, such as a microwave oven. The electromagnetic interference may cause this product to malfunction.
- Do not drop or apply shock/vibration to this product. Strong impacts may damage the components inside.
- Do not insert objects other than compatible memory cards into the memory card slots of this product. The metal contacts inside the slots can easily become damaged by foreign objects.
- Do not use an unknown power adapter other than the one supplied with the PhotoFrame. Connecting this product to an unknown power adapter is very dangerous and may lead to fire or explosion.
- Do not cut, bend, modify, place heavy objects, or step on the power adapter cord. Otherwise the external insulation may be damaged and result in short-circuit or fire.
- If there are strange odors or heat emitting from this product or any signs of malfunction, disconnect the PhotoFrame from the power immediately and contact your dealer for inspection or service.
- Use a smooth, soft cloth to clean the surface of the screen. Do not use liquid cleaners or glass cleaners.
- If a foreign substance or water gets in this product, turn the power off immediately and disconnect the power adapter. Next, remove the foreign substance or water, and then send the product to your nearest service center.
- Do not attempt to disassemble or modify this product. There are no user serviceable parts inside this product, and any unauthorized modifications will void the warranty.
- Although the LCD panel is made with high-precision technology and has effective pixels of 99.99% or more, black dots or bright points of light (red, blue or green) may appear constantly on the LCD panel. This is a structural property of the LCD panel and is not a malfunction.

Table of contents

Key features	1
What's in the box	2
Overview	3
Right view	3
Rear view	5
Operating the PhotoFrame	6
Using the control buttons	7
Using the remote control (These models only: SPF3480/G7, SPF3480X/G7, SPF3400/G7 and SPF3400C/G7)	8
Replacing the remote control battery	10
Getting started	12
Step 1: Using the adjustable back stand	12
Step 2: Connecting to power	14
Step 3: First usage	15
Step 4: Basic setup	15
Selecting a language	15
Setting the date and time	16
Step 5: Inserting a memory card/USB flash drive	17
Compatible memory card formats	18
Step 6: Copying photos to internal memory	19
Step 7: Connecting the PhotoFrame to a computer	20
Step 8: Replacing the paper mat	21
Using the main menu	23
Managing photos	25
Manually copying photos to the internal memory	25
Tagging photos to an album	27
Removing photos from an album	30
Managing photos by using the TIMELINE album	31
Creating a new album	32
Modifying an album	33
Deleting an album	34

Using other options in the PHOTO ALBUMS menu	34
Deleting photos.	34
Rotating photos	35
Applying photo effects	36
Viewing photos	37
Running a slideshow by using the TIMELINE album	39
Using Smart Energy Saver™	40
Using CLOCK (EZ Access button)	42
Selecting a clock skin	42
Switching between Clock view and Slideshow view	43
Using SCRAPBOOK	44
Using SETTINGS	45
Date and Time page	46
General Settings page	47
Information page	48
Frequently asked questions	49
Regulation and compliance	51
Recycling	51
Appendix	52
Specifications	52
For SPF3470X/G7, SPF3480X/G7 and SPF3400C/G7 only	52
For SPF3470/G7, SPF3480/G7 and SPF3400/G7 only	54
List of compatible memory cards	56

Dear Customer:

Thank you for bringing our Philips Digital PhotoFrame into your home. Now you will be able to view your growing digital picture library in stunning clarity and share great memories with friends and family.

To get the most out of your new Philips product, please read through this entire User Manual before use.

Key features

This PhotoFrame is equipped with the following features:

- Clear and bright display.
- Enables you to display photos that are stored in the internal memory, a memory card or a USB flash drive.
- Allows you to select a preferred power-saving option for the PhotoFrame using the Smart Energy Saver™ feature.
- Allows you to use albums to manage and sort your photos easily.
- Allows you to display photos in slideshow using various kinds of templates available in SCRAPBOOK.
- Multi-language On-Screen Display (OSD) menus.
- Clock and Calendar functions.

What's in the box

Carefully open the packing box and ensure that you have the following items.

1. Digital PhotoFrame x 1
2. AC power adapter x 1
3. Magnetic remote control (with CR2025 lithium battery) x 1
(These models only: SPF3480/G7, SPF3480X/G7, SPF3400/G7 and SPF3400C/G7)
4. Quick Start Guide x 1
5. User Manual x 1
6. Registration Card x 1
7. Warranty Card x 1

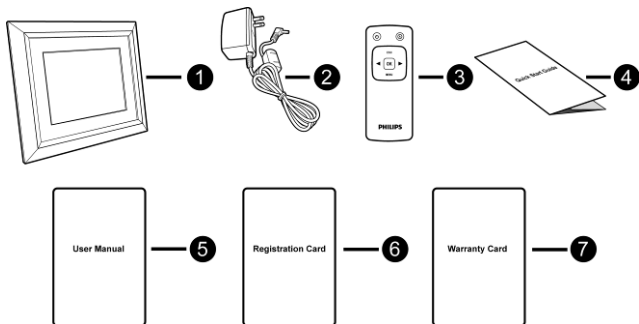

- Actual product appearance may vary from the illustrations shown in this User Manual.
- Available accessories may vary depending on the area where you purchased the PhotoFrame.
- The remote control is not included in the SPF3470/G7 and SPF3470X/G7 models.

Overview

Right view

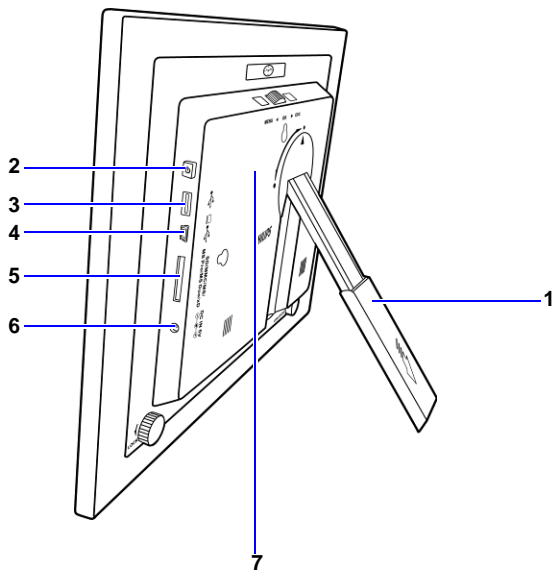

No.	Description
1	Adjustable back stand See " Step 1: Using the adjustable back stand " on page 12 for details.
2	Power button Press the Power button to turn on/off the PhotoFrame. See " Step 2: Connecting to power " on page 14 for details.

No.	Description
3	USB port Allows for a USB flash drive. <ul style="list-style-type: none">• Play back photos stored in the inserted drive.• Copy photos from the inserted drive to the PhotoFrame. See "Step 6: Copying photos to internal memory" on page 19 for details.
4	Mini USB port Allows you to connect the PhotoFrame to a computer to manage the files in the internal memory of the PhotoFrame. See " Step 7: Connecting the PhotoFrame to a computer " on page 20 for details.
5	Memory card slot Allows for an SD™/SDHC™, MultiMediaCard™ (MMC), Memory Stick™ (MS), Memory Stick PRO™ (MS PRO), Memory Stick Duo™ (MS Duo) and xD-Picture Card™ (xD) memory card. <ul style="list-style-type: none">• Play back photos stored in the inserted card.• Copy photos from the inserted card to the PhotoFrame. See "Step 6: Copying photos to internal memory" on page 19 for details.
6	Power jack Connect one end of the AC power adapter into the power jack and the other end into a power outlet.
7	Remote control storage (These models only: SPF3480/G7, SPF3480X/G7, SPF3400/G7 and SPF3400C/G7) Magnetic area for placing remote control.

Rear view

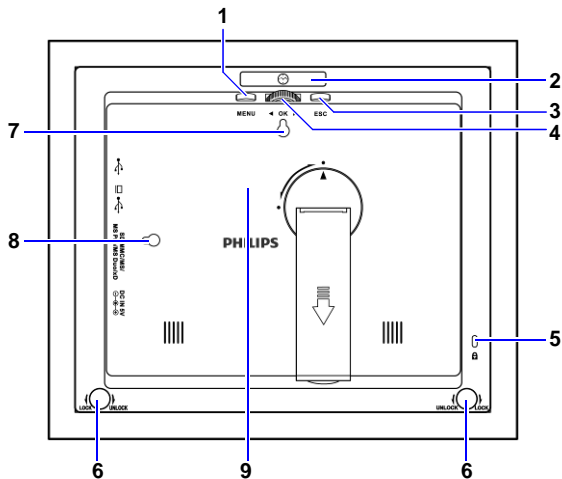

No.	Description
1	MENU button See "Using the control buttons" on page 7 for details.
2	EZ Access button See "Using the control buttons" on page 7 for details.
3	ESC button (ESCAPE button) See "Using the control buttons" on page 7 for details.
4	Scroll wheel/OK button See "Using the control buttons" on page 7 for details.
5	Kensington® security slot You can attach an anti-theft Kensington® lock and cable to this slot to help prevent possible theft.

No.	Description
6	EZ Lock System You can use the EZ Lock Screws to lock or unlock the wooden frame.
7	Wall mount hole (for landscape wall mounting) Allows you to hang the PhotoFrame horizontally on a wall.
8	Wall mount hole (for portrait wall mounting) Allows you to hang the PhotoFrame vertically on a wall.
9	Remote control storage (These models only: SPF3480/G7, SPF3480X/G7, SPF3400/G7 and SPF3400C/G7) Magnetic area for placing remote control.

Operating the PhotoFrame

You can use the control buttons on the back or the supplied remote control to operate the PhotoFrame.

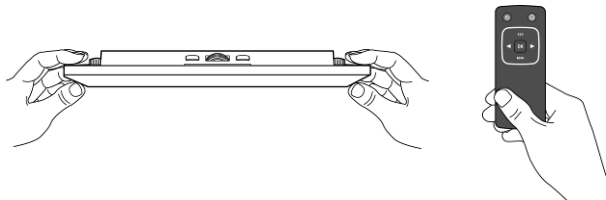

- ☞ In this User Manual, instructions or examples provided are based upon operation with the remote control. To know how to use the control buttons, refer to **"Using the control buttons" on page 7** for details.
- The remote control is supplied with the SPF3480/G7, SPF3480X/G7, SPF3400/G7 and SPF3400C/G7 models only.

Using the control buttons

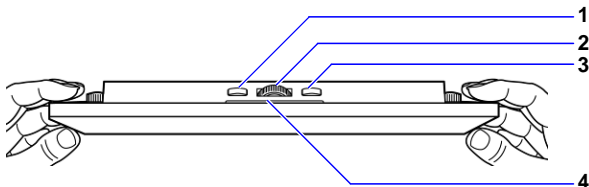

No.	Icon	Description
1	ESC	ESC button (ESCAPE button) Cancels current operation and/or returns to the previous page.
2	◀ OK ▶	Scroll wheel/OK button <ul style="list-style-type: none"> • Press this button to enter or confirm your operation/selection. • Scroll this button to the left to select the previous item. • Scroll this button to the right to select the next item.
3	MENU	MENU button Displays the pop-up menu.
4		EZ Access button Switches between Clock view and Slideshow view.

Using the remote control (These models only: SPF3480/G7, SPF3480X/G7, SPF3400/G7 and SPF3400C/G7)

The supplied remote control is magnetic. With its magnetic backing, you can stow away the remote securely in the designated area shown below.

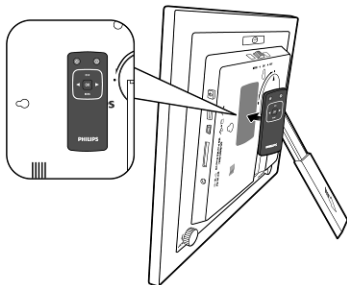



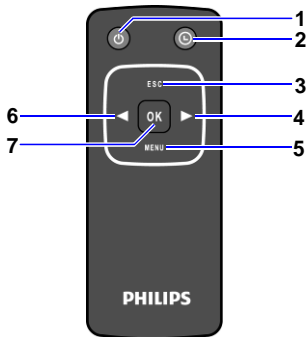
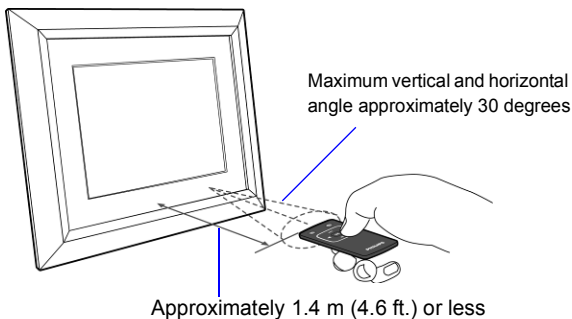



The PhotoFrame has a built-in remote control sensor behind the paper matting.



- Please remove the plastic strip under the battery before using the remote control for the first time.
- The remote control is supplied with the SPF3480/G7, SPF3480X/G7, SPF3400/G7 and SPF3400C/G7 models only.

No.	Icon	Description
1		ON/OFF Turns unit on/off.

No.	Icon	Description
2		EZ Access button Switches between Clock view and Slideshow view.
3		ESC (Escape) Returns to the previous page and/or access menu page.
4		RIGHT Moves right or moves to the next item.
5		MENU Displays the pop-up menu.
6		LEFT Moves to the left or moves to the previous item.
7		OK Confirms your selection.

Replacing the remote control battery

1. On the back of the remote control, press the locking tab to the right.

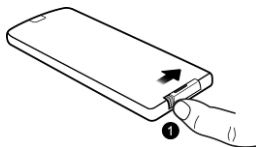

2. Pull out the battery holder.

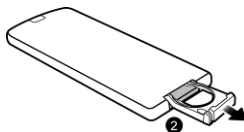

3. Insert the new battery into the holder. The battery must be placed with the positive charge facing upwards, as shown in the illustration below.

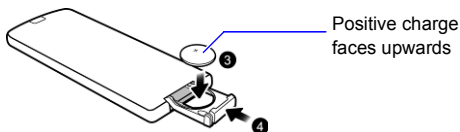

4. Slide the battery holder into the remote control.



- **Failure to replace the battery in the correct manner may damage the battery.**
- **Use only the specified battery type.**
- **Recycle or dispose used batteries properly according to local guidelines and regulations.**
- **The batteries are highly flammable, keep away from excessive heat or moisture.**
- **If the battery is completely drained or not in use for extended period of time, remove the battery to prevent leakage.**

Getting started

Step 1: Using the adjustable back stand

1. Gently pop out the back stand as shown below.

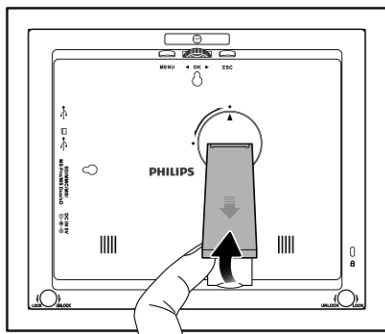

- To place the PhotoFrame horizontally or vertically, you can rotate the back stand by aligning the triangle mark with the rounded points (1 or 2).

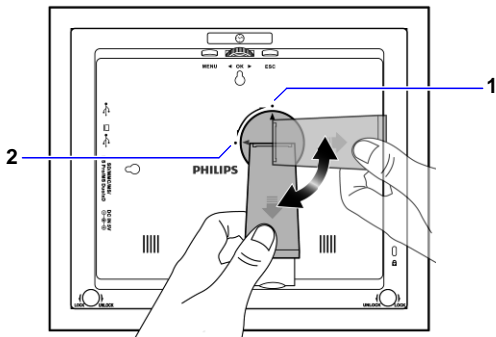

- Pull out the back stand and adjust accordingly to the preferred viewing angle.

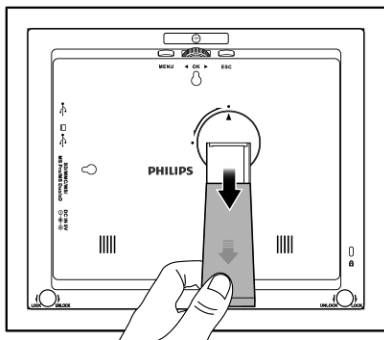

- It is recommended to place the PhotoFrame horizontally, because this direction provides the best viewing and operating experience.
- By using the wall mount holes, you can hang the PhotoFrame horizontally or vertically on the wall.

Step 2: Connecting to power

1. Place the PhotoFrame on a flat surface.
2. Connect the power adapter as below (1), and press the Power button to turn on the PhotoFrame (2).

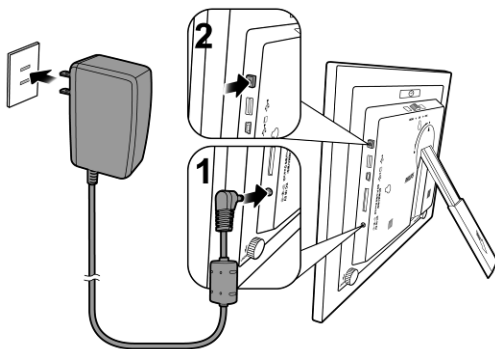

- Power systems and plug types may vary depending on your country/region.
- To turn off the PhotoFrame, press the Power button.

Step 3: First usage

To help you get the most out of your PhotoFrame, we installed a video tutorial that automatically starts playing when you first turn on your unit. To cancel the looping video and start playing your own photos, press any of the buttons on the back. Follow the five-step process to familiarize yourself with how the control buttons work. This simple process is automatically disabled after the first use. You can turn on the tutorial by going into **SETTINGS**.





Step 4: Basic setup

Select a language and set the date and time during the first use of the PhotoFrame.







Selecting a language

1. In the main menu, press  or  to select **SETTINGS**















, and then press .

2. Press .

The **General Settings** page appears.

3. Press , press  to go to **Language**, and then press  again.
4. Press  or  to select a language you wish to use, and then press .
5. Press  to exit.

Setting the date and time

1. In the main menu, press  or  to select **SETTINGS** , and then press .
- The **Date and Time** page appears.
2. Press  to highlight the Year field, press  or  to select a year, and then press  to confirm the setting.
 3. Press  to move to the Month field, press  to highlight the Month field, press  or  to select a month, and then press  to confirm the setting.
 4. Repeat Step 3 for the remaining fields, including Date, Hour, Minute, Mode, Current Time Zone and Second Time Zone.
 5. Press  to exit.

Step 5: Inserting a memory card/ USB flash drive

You can turn on the PhotoFrame and play back the pre-installed photos in the internal memory with no memory card/USB flash drive inserted.

To play back your own files, insert a compatible memory card or USB flash drive that contains supported files into the corresponding slot on the PhotoFrame as illustrated below.



SD/SDHC



MultiMediaCard

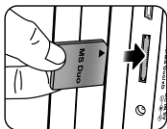
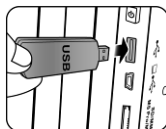

Memory Stick

Memory Stick
PROMemory Stick
DuoxD-Picture
Card

USB flash drive



For more information about the supported file formats, refer to ["Specifications" on page 52.](#)

Compatible memory card formats

Memory card formats	Maximum capacity
SD/SDHC	32GB
MultiMediaCard (MMC)	1GB
Memory Stick (MS)	4GB
Memory Stick PRO (MS PRO)	2GB
Memory Stick Duo (MS Duo)	2GB
xD-Picture Card (xD)	2GB
USB flash drive	16GB



- **Maximum capacity specifications listed above are subject to change without prior notice.**
- **The memory card slot supports hot-swap function. In other words, you can change or remove the memory card when the power of the PhotoFrame is either turned on or turned off.**
- **The PhotoFrame supports both Windows and MAC operating systems. However, when formatting your memory cards, use FAT16 and FAT32 file systems in Windows only. Formatting memory cards with NTFS or MAC is not supported.**
- **To use a microSD, a miniSD or a Memory Stick Micro (M2) card, a card adapter is required.**





Step 6: Copying photos to internal memory

When inserting a memory card or a USB flash drive, you will be asked to copy all photos to the internal memory.

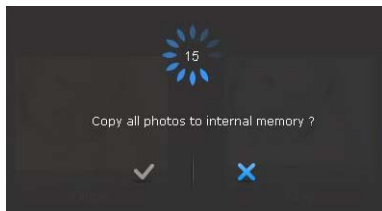

If “Smart Copy” is set to “Resize” under “General Settings”, photos will be resized to the screen resolution when copied to the internal memory to optimize the storage capacity. Please keep a copy of the original photos on your memory card or USB flash drive.



- To copy all photos contained in the inserted memory card (or USB flash drive), select the check mark  and press  to proceed.
- To view photos without copying them to the PhotoFrame, select the cross mark  and press . The PhotoFrame will start playing back the photos automatically from the inserted memory card or USB flash drive.



- **Do not remove the memory card/USB flash drive before the copy process is completed.**
- **If the files you wish to copy from the memory card/USB flash drive already exists in the internal memory of the PhotoFrame, the files will be overwritten when you select  to proceed.**

Step 7: Connecting the PhotoFrame to a computer

You can connect the PhotoFrame to a computer using a mini USB cable (to be purchased separately) to easily manage the files in the internal memory of the PhotoFrame.

1. Start the computer and turn on the PhotoFrame.
2. Connect the smaller end of the USB cable to the mini USB port of the PhotoFrame.
3. Connect the other end of the USB cable to a USB port on the computer, making sure the connectors are fully inserted.
4. Once connected, the PhotoFrame will enter PC transfer mode automatically.
5. When the computer has detected the PhotoFrame, the PhotoFrame will appear in "My Computer" as "removable disk".

Now you can freely transfer the files in the PhotoFrame as you would on other disk drive.

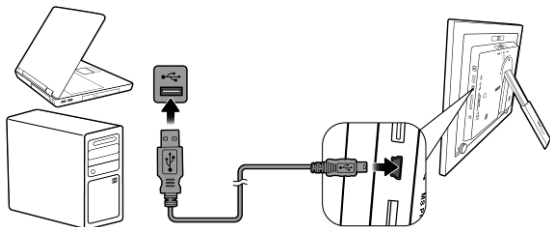

- You can copy photos from the computer to the PhotoFrame, and vice versa.
- The files in the memory cards and USB flash drive cannot be viewed/edited via USB connection.

Step 8: Replacing the paper mat

Your PhotoFrame may come with one or more bonus paper mats depending on your purchased model. You can replace the existing paper mat with the one supplied (if available). Follow the instructions below to replace the supplied paper mat.

1. On a flat table, place the PhotoFrame facing down on top of a soft towel. Be careful not to scratch the unit.
2. Twist the EZ Lock Screws on the back of the PhotoFrame to the "UNLOCK" position, then carefully lift up the core unit from the wood frame.

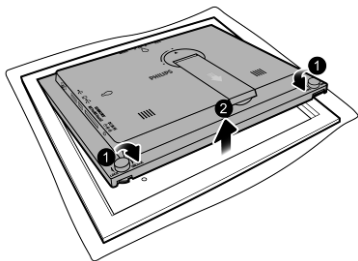

3. Remove the existing paper mat.

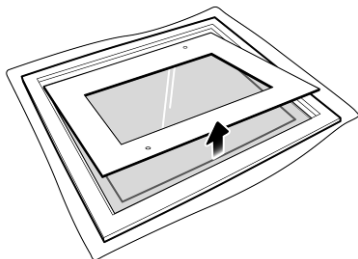

SPF3480X/G7 and SPF3400C/G7 have bonus mats.

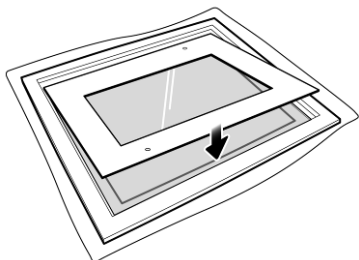

4. Install the supplied bonus paper mat.

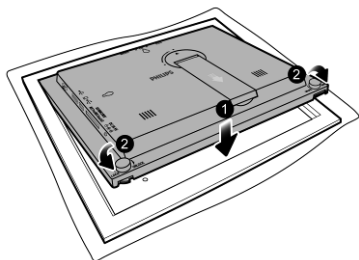

5. Install the PhotoFrame to the wooden frame, and secure the PhotoFrame by tightening the EZ Lock Screws to the "LOCK" position.



Using the main menu

When you turn on the PhotoFrame, the main menu below appears. You can press  or  to select the desired menu, and then press  to enter the selected menu.



No.	Description
1	Smart Energy Saver™ Allows you to select a power-saving option for the PhotoFrame. See "Using Smart Energy Saver™" on page 40 for details.
2	CLOCK & CALENDAR Allows you to set your favorite clock skins. See "Using CLOCK (EZ Access button)" on page 42 for details.
3	SCRAPBOOK Allows you to display photos in slideshow with various preloaded templates. See "Using SCRAPBOOK" on page 44 for details.

No.	Description
4	SLIDESHOW Allows you to display photos in slideshow. See " Viewing photos " on page 37 for details.
5	PHOTO ALBUMS Allows you to manage your photos and sort them by using different albums. See " Managing photos " on page 25 for details.
6	SETTINGS Allows you to configure the settings of the PhotoFrame. See " Using SETTINGS " on page 45 for details.



Managing photos



You can use the **PHOTO ALBUMS** menu to manage photos in the internal memory, memory card or USB flash drive.

Manually copying photos to the internal memory

In addition to the automatic “Smart Copy” feature (see [page 19](#)), you can manually copy photos from external storage devices to the internal memory and tag photos to an album.

The example below demonstrates how to copy photos from a memory card to the internal memory and tag photos into an album.







1. Insert a compatible memory card to the memory card slot.

2. In the main menu, press  or  to select **PHOTO ALBUMS**, and then press .

3. Select **Memory Card**, and then press .



The screen shows the photos contained in your memory card.





4. If there are more than one page, you can press  or  to go to the previous or next page to browse photos. (If not, skip this step.)
5. Press  to enable the selection mark, showing in orange.
6. Press  or  to move to the photo you wish to select, and then press  to confirm the selection.

The selected photo will have a blue selection mark.

 **Repeat Step 6 to select more photos as desired.**



If you wish to select all the photos shown on the current page, select "Select All" in the pop-up menu and press , then continue with Step 7.



7. Press .
8. From the pop-up menu, press  or  to select **Tag It**, and then press .

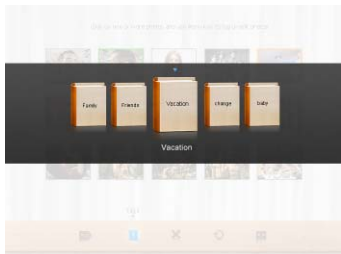

9. Select a default target album to copy and sort the photos into this specified album.





Tagging photos to an album

1. In the main menu, press  or  to select **PHOTO ALBUMS**, and then press .







The screen shows:

- the file source, including **USB**, **Memory Card** and **Internal Memory**.
 - the default albums in the internal memory, including **TIMELINE**, **Pre-installed Library**, **Uncategorize**, **Family**, **Friends** and **Vacation**.
-  • The “USB” and “Memory Card” file sources will only appear when a USB flash drive and a memory card have been inserted to the PhotoFrame.
- For details about the “TIMELINE” album, see ["Managing photos by using the TIMELINE album" on page 31](#).

2. Press  or  to select the source of your photos, such as the **Internal Memory** album, and then press . (You can also select **USB or Memory Card**, if available.)



The screen shows all the photos that are available in the internal memory.

3. If there are more than one page, you can press  or  to go to the previous or next page to browse photos. (If not, skip this step.)
4. Press  to enable the selection mark, showing in orange.
5. Press  or  to move to the photo you wish to select, and then press  to confirm the selection.



The selected photo will have a blue selection mark.

 **Repeat Step 5 to select more photos as desired.**

6. Press .



If you wish to select all the photos shown on the current page, select "Select All" in the pop-up menu and press . Then proceed to Step 7.



7. From the pop-up menu, press  or  to select **Tag It**, then press .



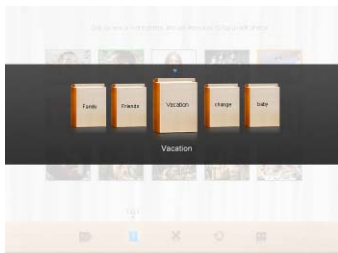



8. Select the destination album for the photos to be stored.



Removing photos from an album

1. In the **PHOTO ALBUMS** menu, press  or  to select an album from which you want to remove the photos, and then press .

The screen shows the photos in the album.

2. Press  to enable the selection mark, showing in orange.
3. Press  or  to move to the photo you wish to select, and then press  to confirm the selection.

The selected photo will have a blue selection mark.







Repeat Step 3 to select more photos as desired.

4. Press .



If you wish to select all the photos shown on the current page, select







“Select All” in the pop-up menu and press . Then proceed to Step 5.

5. From the pop-up menu, press  or  to select **Uncategorize**, and then press .

The photos will be removed from the album, but will not be deleted from the internal memory.

Managing photos by using the **TIMELINE** album

In **PHOTO ALBUMS**, you can use the **TIMELINE** album to search for photos in the internal memory according to the time span specified.



1. In the **PHOTO ALBUMS** menu, press  or  to select **TIMELINE**, and then press .
2. Press . When the < > marks appear, press  or  to adjust the settings in the **Year** field, and then press  again.

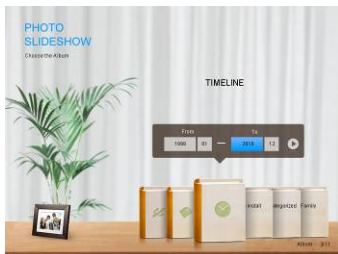

In this step, you can also search for photos taken in a specific period of time under the **TIMELINE** album by pressing  and selecting the time frame.





3. Press  to move to the **Month** field, and repeat Step 2 to adjust the settings.

4. Press  to move to , and then press  to start playback.

The photos taken in the time span you specified above will appear on the screen.





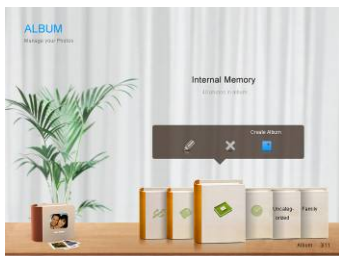







Creating a new album

1. In the **PHOTO ALBUMS** menu, press  to display the pop-up menu, and then press  to select **Create Album**.



2. In the **Album Name** field that appears, use the on-screen keyboard to enter a desired name.







- Press  or  to select a letter, and then press  to enter the letter.
- Press  to toggle between letters and numbers.
- To add a space, press  or  to move to **Space**, and then press .
- To delete your last input, press  or  to move to **Back**, and then press .
- To complete your input, press  or  to move to **Done**, and then press .

3. Now the new album is created.







The PhotoFrame allows you to create up to 12 custom albums.

Modifying an album

1. In the **PHOTO ALBUMS** menu, press  or  to select an album for which you wish to modify the album name, and then press .
2. Select **Edit Name**, and then press .
3. In the **Album Name** field that appears, use the on-screen keyboard to enter a desired name.
4. Once you have finished editing the album name, press  to exit.

Deleting an album







1. In the **PHOTO ALBUMS** menu, press  or  to select an album that you wish to delete, then press .
2. Select **Delete Album**, and then press .



Default albums including TIMELINE, Pre-installed Library, Uncategorize, Family, Friends and Vacation cannot be deleted.

Using other options in the PHOTO ALBUMS menu

Deleting photos

1. In the **PHOTO ALBUMS** menu, press  or  to select an album, and then press .
2. Press  to enable the selection mark, showing in orange.
3. Press  or  to move to the photo you wish to select, and then press  to confirm the selection.

The selected photo will have a blue selection mark.



Repeat Step 3 to select more photos as desired.







4. Press .



If you wish to select all the photos shown on the current page, select "Select All" in the pop-up menu and press . Then proceed to Step 5.

- From the pop-up menu, press  or  to select **Delete**, and then press .

Rotating photos

- In the **PHOTO ALBUMS** menu, press  or  to select an album, and then press .
- Press  to enable the selection mark, showing in orange.
- Press  or  to move to the photo you wish to select, and then press .

The selected photo will have a blue selection mark.



Repeat Step 3 to select more photos as desired.

- Press .









If you wish to select all the photos shown on the current page, select "Select All" in the pop-up menu and press . Then proceed to Step 5.

- From the pop-up menu, press  or  to select **Rotate**, and then press .

The photo will be rotated 90 degrees clockwise.

- Repeat Step 5 if you wish to rotate the photo into other angles.

Applying photo effects

1. In the **PHOTO ALBUMS** menu, press  or  to select an album, and then press .
2. Press  to enable the selection mark, showing in orange.
3. Press  or  to move to the photo you wish to select, and then press .

The selected photo will have a blue selection mark.









Repeat Step 3 to select more photos as desired.

4. Press .



If you wish to select all the photos shown on the current page, select "Select All" in the pop-up menu and press . Then proceed to Step 5.

5. From the pop-up menu, press  or  to select **Photo Effects**, and then press .
6. Press  or  to select the effect you wish to apply to the selected photo, including **SEPIA**, **ORIGINAL** and **BLACK & WHITE**, and then press .

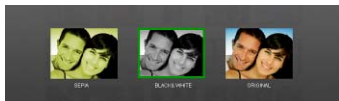







Viewing photos



1. In the main menu, press  or  to select

SLIDESHOW, and then press .

 The “USB” and “Memory Card” albums only appear when a USB flash drive and a memory card have been inserted to the PhotoFrame.

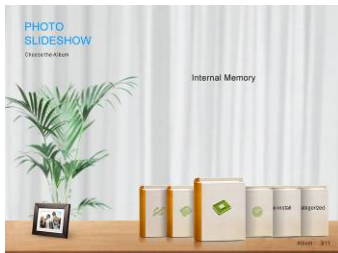
2. Press  or  to select the album that contains the photos you wish to display in slideshow, and then press .



 If you wish to pause the slideshow, press .

3. To configure slideshow settings, press **MENU** to display the pop-up menu. You can adjust the settings below.





- **Transition Effect:** selects the transition effect you wish to apply to the slideshow.
- **Slideshow Interval:** selects the slideshow interval between photos.



The default transition effect “Pan & Zoom” does not allow customized interval settings.

- **Brightness:** selects the level of screen brightness.
- **Contrast:** selects the level of contrast.
- **Saturation:** selects the level of saturation.

Running a slideshow by using the **TIMELINE** album

1. In the **SLIDESHOW** menu, press  or  to select **TIMELINE**, and then press .
2. In the pop-up screen, specify a time span to include the photos you wish to display in slideshow.



In this step, you can also search for photos taken in a specific period of time under the **TIMELINE** album by pressing  and selecting the time frame.

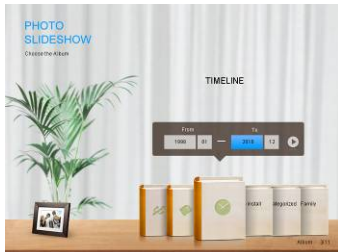

3. Select , and then press  to start playback.









The TIMELINE feature only applies to photos stored in the memory card from the card reader. Please copy any photos on the USB drive to the inserted memory card if you wish to access this feature.



Using Smart Energy Saver™

The Smart Energy Saver™ menu provides various pre-defined power-saving options.

1. In the main menu, press  or  to select **Smart Energy Saver™**, and then press .
2. Press  or  to select a desired option, and confirm with .

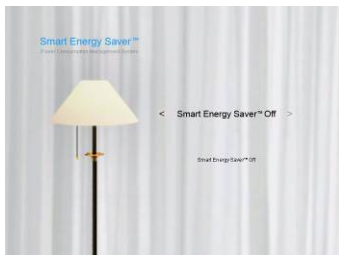

For details about the power-saving options, refer to the table below.

Option	Description
Off	Turns off Smart Energy Saver™.
Auto 50%	Saves 50% on power consumption during nighttime and automatically resumes normal power consumption during daytime.

Option	Description
Auto 100%	Puts the PhotoFrame into sleep mode during nighttime and automatically resume normal power consumption during daytime.
Save 20%	Always saves 20% on power consumption.
Save 50%	Always saves 50% on power consumption.







- **Nighttime is defined as hours from 9:00 p.m. to 7:00 a.m..**
- **Daytime is defined as hours from 7:00 a.m. to 9:00 p.m..**
- **Using Smart Energy Saver™ does not affect the photo quality.**



Using CLOCK (EZ Access button)

Selecting a clock skin

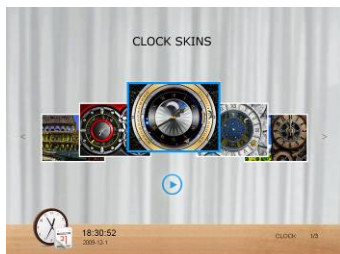

The PhotoFrame provides various preloaded clock and calendar skins. To set a default clock skin to be displayed in Clock view, follow the steps below.

1. In the main menu, press  or  to select **CLOCK & CALENDAR**, and then press  .
2. Press  or  to select a desired skin.





3. Press **MENU** and select **Default**.



4. Press **OK** to set the selected clock skin as default. The default clock skin will be displayed when  (or ) is pressed.

Switching between Clock view and Slideshow view







You can press  to toggle between Clock view and Slideshow view.

-  • When switching from Clock view to Slideshow view, the PhotoFrame starts the slideshow that was running previously.
- If the last slideshow was playing from memory card or USB and is no longer available, the PhotoFrame will start a slideshow from the Internal Memory.



Using SCRAPBOOK

Philips SCRAPBOOK feature provides a brand new user experience in enjoying photo slideshows.

1. In the main menu, press  or  to select **SCRAPBOOK**, and then press  .
2. Press  or  to select a template, and then press  .

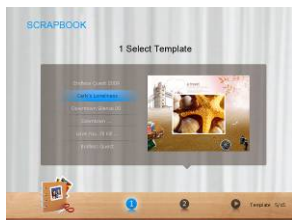

3. Select an album that contains the photos you wish to display in slideshow, and then press  .



The PhotoFrame will start to display the photos in slideshow using the selected template.





Using SETTINGS

The **SETTINGS** menu allows you to configure the settings of the PhotoFrame.

1. In the main menu, press  or  to select **SETTINGS**, and then press .

The **Date and Time** page appears.

2. Press  or  to toggle among **Date and Time**, **General Settings** and **Information** pages.

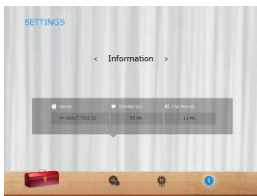
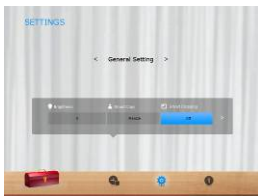

3. Press  to enter a page, and the first option in that page will be highlighted.

4. Press **OK** again. When the < > marks appear in the field, press **◀** or **▶** to adjust the settings.

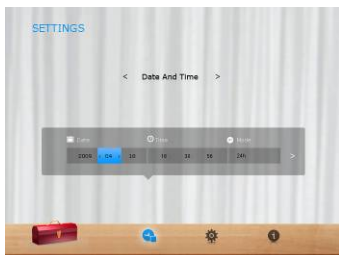

5. Press **ESC** to exit.

Date and Time page

Item	Option	Description
Date	-	Allows you to set the date.
Time	-	Allows you to set the time.
Mode	-	Allows you to select a time format (12-hour clock or 24-hour clock).
Current Time Zone	-	Allows you to select the time zone that matches your current geographic location.
Second Time Zone	-	Allows you to set a second time zone additionally.

General Settings page

Item	Option	Description
Brightness	1	Allows you to select the level of screen brightness.
	2	
	3	
	4	
	5	
Smart Copy	Determines how photos are copied from the external storage devices to the internal memory when using the Smart Copy feature.	
	Resize	Resizes the photos to save memory space.
	Normal	Keeps the original file size.
Smart Cropping	Full-screen	Selects to display photos in original size or full screen.
	Original	
Language	English	Sets up the On-Screen Display (OSD) language.
	French	
	Spanish	
Reset	Yes	Returns all the settings back to system default.
	No	
FW Upgrade	Yes	Upgrades the firmware of the PhotoFrame.
	No	
Product Intro	On	The start-up video tutorial for major features and functions.
	Off	

Information page

Item	Option	Description
Version	-	Shows the current firmware version.
Total Memory	-	Shows the total capacity of the internal memory.
Free Memory	-	Shows the remaining capacity of the internal memory.

Frequently asked questions

❓ What memory card formats are compatible with the PhotoFrame?

👉 SD/SDHC, MMC, MS, MS PRO, MS Duo and xD are compatible with the PhotoFrame. For details, refer to ["Compatible memory card formats" on page 18](#).

❓ Why do some photos load faster than others?

👉 Higher resolution photos load slower. Using a lower resolution when taking photos will speed up loading time. Smart Copy™ can be used to resize selected images to decrease loading time.

❓ How does auto rotation work?

👉 The PhotoFrame will display in a landscape mode if placed on its long side (as shown on your product box). To display your photos in a portrait mode, rotate the PhotoFrame on its right side.

❓ Why are my photos appearing upside down?

👉 The PhotoFrame is placed upside down. Please rotate the frame.

❓ What types of image files can I view on my PhotoFrame?

👉 The PhotoFrame supports playback of JPEG, BMP, JPEG Progressive and EXIF images.

❓ Can I connect my PhotoFrame directly to my computer?

👉 You can connect the PhotoFrame directly to your computer via a mini USB cable.

❓ Will the tagged photos be reset if I pull out the SD card?

👉 No. The Digital PhotoFrame (DPF) will write information into the MetaData of tagged photos. So the DPF will remember the photo's album categorization the next time the SD card is re-inserted to the unit.

❓ The frame slows down significantly on certain photos. What can I do?

👉 This is mainly due to extra processing time needed to decode very large size high resolution files. The DPF's Smart Cropping (ON by default) feature will automatically resize the file based on the unit's screen resolution and will significantly reduce the size of the photo and eliminate this issue. However, please always keep a copy of the original photos on the computer.

❓ The frame froze and will not respond, what can I do?

👉 If the frame freezes, it is easy to restart by unplugging from power, then press power button again.

❓ Why isn't the TIMELINE feature accessible for photos on my USB drive?

👉 The TIMELINE feature only applies to photos stored in the memory card from the card reader. Please copy any photos on the USB drive to the inserted memory card if you wish to access this feature.

❓ Why can't I tag my photos in my SD card to any albums?

👉 Please check that your SD card is not locked because the DPF will need to be able write information onto the files in order to tag to Album.

Regulation and compliance

Federal Communications Commission (FCC) Notice

This equipment has been tested and found to comply with the limits for a Class B digital device, pursuant to Part 15 of the FCC Rules. These limits are designed to provide reasonable protection against interference in a residential installation. This equipment can radiate radio frequency energy and, if not installed and used in accordance with the instructions, may cause interference to radio communications.

However, there is no guarantee that interference will not occur in a particular installation. If this equipment does cause interference to radio or television reception, which can be determined by turning the equipment off and on, the user is encouraged to try to correct the interference by one of the following measures:

- Reorient or relocate the receiving antenna.
- Increase the separation between the equipment and receiver.
- Connect the equipment into an outlet on a circuit different from that to which the receiver is connected.
- Consult the dealer or an experienced radio/TV technician for help.

Recycling

- To minimize harm to the environment, the batteries supplied with the PhotoFrame do not contain mercury or nickel cadmium. If possible, when disposing of batteries, use recycling means available in your area.
- The PhotoFrame uses materials that can be recycled. To minimize the amount of waste in the environment, check your area for companies that will recover used televisions for dismantling and collection of reusable materials, or contact your dealer for recycling tips.
- Please dispose of the carton and packing material through the proper waste disposal management in your area.

Appendix

Specifications

 Specifications are subject to change without prior notice.

For SPF3470X/G7, SPF3480X/G7 and SPF3400C/G7 only

Model	SPF3470X/G7	SPF3480X/G7	SPF3400C/G7
LCD type	7" Digital LCD	8" Digital LCD	10.4" Digital LCD
Backlight type	LED	LED	LED
Aspect ratio	16:9	4:3	4:3
Screen resolution	800 x 480 pixels	800 x 600 pixels	800 x 600 pixels
Brightness	200nits	250nits	300nits
Built-in internal memory (for data storage)	Approximately 128MB	Approximately 128MB	Approximately 2GB
Supported memory card formats	SD, MMC, MS, MS PRO, MS Duo and xD	SD, MMC, MS, MS PRO, MS Duo and xD	SD, MMC, MS, MS PRO, MS Duo and xD
Supported flash drive	USB flash drive (using the USB port)	USB flash drive (using the USB port)	USB flash drive (using the USB port)
Supported image file format	JPEG, BMP, JPEG Progressive and EXIF	JPEG, BMP, JPEG Progressive and EXIF	JPEG, BMP, JPEG Progressive and EXIF

Model	SPF3470X/G7	SPF3480X/G7	SPF3400C/G7
USB port	USB Host (Type-A) x 1, HS 2.0	USB Host (Type-A) x 1, HS 2.0	USB Host (Type-A) x 1, HS 2.0
Mini USB port	USB Device (Mini-B) x 1, HS 2.0	USB Device (Mini-B) x 1, HS 2.0	USB Device (Mini-B) x 1, HS 2.0
Memory card slots	6-in-1 card slot	6-in-1 card slot	6-in-1 card slot
IR receiver	No	Yes	Yes
Input power	AC100-220V	AC100-220V	AC100-220V
Output power	DC5V 1A	DC5V 1A	DC5V 2A
Auto picture rotation/angle switch	Yes	Yes	Yes
Clock/Calendar	Yes	Yes	Yes
Back stand	Yes, foldable	Yes, foldable	Yes, foldable
Language support	English, French and Spanish	English, French and Spanish	English, French and Spanish
Plug & Play compatibility	Windows 7/XP/Vista/2000, Mac OS X	Windows 7/XP/Vista/2000, Mac OS X	Windows 7/XP/Vista/2000, Mac OS X
Remote control	No	Yes	Yes
Interchangeable Frame Capability	Yes	Yes	Yes
Paper mat	Yes	Yes	Yes
Bonus mat	No	Yes	Yes

For SPF3470/G7, SPF3480/G7 and SPF3400/G7 only

Model	SPF3470/G7	SPF3480/G7	SPF3400/G7
LCD type	7" Digital LCD	8" Digital LCD	10.4" Digital LCD
Backlight type	LED	LED	LED
Aspect ratio	16:9	4:3	4:3
Screen resolution	800 x 480 pixels	800 x 600 pixels	800 x 600 pixels
Brightness	200nits	250nits	300nits
Built-in internal memory (for data storage)	Approximately 128MB	Approximately 128MB	Approximately 128MB
Supported memory card formats	SD, MMC, MS, MS PRO, MS Duo and xD	SD, MMC, MS, MS PRO, MS Duo and xD	SD, MMC, MS, MS PRO, MS Duo and xD
Supported flash drive	USB flash drive (using the USB port)	USB flash drive (using the USB port)	USB flash drive (using the USB port)
Supported image file format	JPEG, BMP, JPEG Progressive and EXIF	JPEG, BMP, JPEG Progressive and EXIF	JPEG, BMP, JPEG Progressive and EXIF
USB port	USB Host (Type-A) x 1, HS 2.0	USB Host (Type-A) x 1, HS 2.0	USB Host (Type-A) x 1, HS 2.0
Mini USB port	USB Device (Mini-B) x 1, HS 2.0	USB Device (Mini-B) x 1, HS 2.0	USB Device (Mini-B) x 1, HS 2.0
Memory card slots	6-in-1 card slot	6-in-1 card slot	6-in-1 card slot

Model	SPF3470/G7	SPF3480/G7	SPF3400/G7
IR receiver	No	Yes	Yes
Input power	AC100-220V	AC100-220V	AC100-220V
Output power	DC5V 1A	DC5V 1A	DC5V 2A
Auto picture rotation/angle switch	Yes	Yes	Yes
Clock/Calendar	Yes	Yes	Yes
Back stand	Yes, foldable	Yes, foldable	Yes, foldable
Language support	English, French and Spanish	English, French and Spanish	English, French and Spanish
Plug & Play compatibility	Windows 7/XP/Vista/2000, Mac OS X	Windows 7/XP/Vista/2000, Mac OS X	Windows 7/XP/Vista/2000, Mac OS X
Remote control	No	Yes	Yes
Interchangeable Frame Capability	Yes	Yes	Yes
Paper mat	Yes	Yes	Yes
Bonus mat	No	No	No

List of compatible memory cards

 Not all supported memory cards are included in the table below. For technical support, contact your nearest service center for assistance.

Capacity	Memory card formats					
	SD	miniSD	microSD	MMC	MS	xD
8MB	TOSHIBA					
32MB	Kodak					
	Canon					
64MB					LEXAR	
					SanDisk (MS Pro Duo)	
					SONY (MS Pro Duo)	
128MB	Panasonic				SanDisk (M2)	
256MB			SanDisk	RIDATA		OLYMPUS (M)
512MB	TwinMOS		SanDisk	Transcend		FUJIFILM
	TOSHIBA		Transcend			Kodak (H)
	PQI					
1GB	Kingston	Panasonic	SanDisk	Transcend		FUJIFILM
	SanDisk		SanDisk (Ultra II)			
	Transcend		Transcend			
	A-DATA (80X)		TOSHIBA			
	RIDATA (66X)		A-DATA			
	APACER (60X)		Kingston			
	Panasonic (SDHC Class 4)		Adapter			

Capacity	Memory card formats					
	SD	miniSD	microSD	MMC	MS	xD
2GB	Panasonic (SDHC Class 4)	Stargem	Silicon Power			OLYMPUS (M+)
	Panasonic (SDHC Class 2)		Kingston			OLYMPUS (M)
	SanDisk		Transcend			FUJIFILM (H)
	Transcend		A-DATA			
	TOSHIBA		PQI			
	A-DATA	Panasonic	SanDisk			
	APACER (60X)					
	SanDisk					
	Silicon Power (Ultima II 80X)					
4GB	Kingston (SDHC Class 6)	Transcend	SanDisk		SanDisk (MS Pro HG Duo)	
	A-DATA (SDHC Class 6)				SONY (MS Pro Duo)	
	Silicon Power (SDHC Class 6)				ScanDisk (MS Pro Duo)	
	TOSHIBA (SDHC Class 4)					
	RIDATA (SDHC Class 6)					

Capacity	Memory card formats					
	SD	miniSD	microSD	MMC	MS	xD
8GB	A-DATA (SDHC Class 6)		Kingston			
	Transcend (SDHC Class 6)		SanDisk			
	Kingston (SDHC Class 6)					
16GB	Transcend (SDHC Class 6)		TOSHIBA		SanDisk (MS Pro Duo)	
32GB					SONY (MS Pro Duo Mark2)	
					SONY (MS Pro Duo)	



*Philips and Philips Shield are used under license of
Koninklijke Philips Electronics NV.*

© 2010 GiiNii International
All rights reserved.

P/N:

Free Manuals Download Website

<http://myh66.com>

<http://usermanuals.us>

<http://www.somanuals.com>

<http://www.4manuals.cc>

<http://www.manual-lib.com>

<http://www.404manual.com>

<http://www.luxmanual.com>

<http://aubethermostatmanual.com>

Golf course search by state

<http://golfingnear.com>

Email search by domain

<http://emailbydomain.com>

Auto manuals search

<http://auto.somanuals.com>

TV manuals search

<http://tv.somanuals.com>