

# Bluetooth QuickStart Kit User's Guide

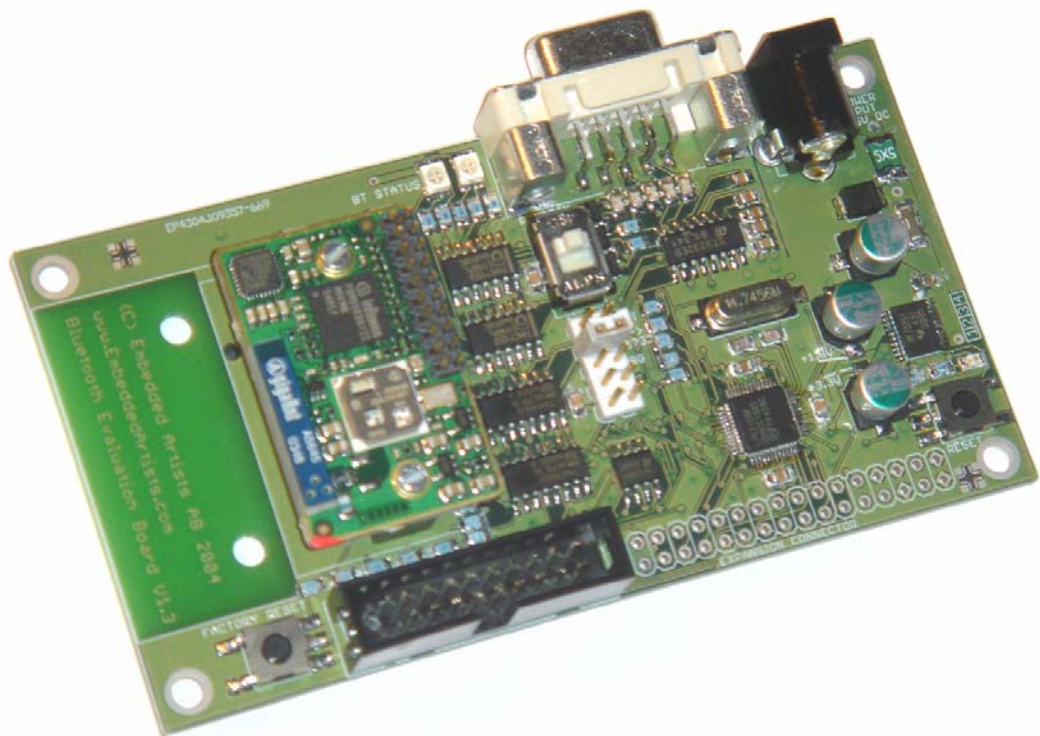

*A Quick Way to Start Using and Integrate  
Bluetooth in YOUR Application...*



*Builds on InfraBed™ technology*



## Embedded Artists AB

Friisgatan 33  
SE-214 21 Malmö  
Sweden

[info@EmbeddedArtists.com](mailto:info@EmbeddedArtists.com)  
<http://www.EmbeddedArtists.com>

### **Copyright 2004-2005 © Embedded Artists AB. All rights reserved.**

No part of this publication may be reproduced, transmitted, transcribed, stored in a retrieval system, or translated into any language or computer language, in any form or by any means, electronic, mechanical, magnetic, optical, chemical, manual or otherwise, without the prior written permission of Embedded Artists AB.

### **Disclaimer**

Embedded Artists AB makes no representation or warranties with respect to the contents hereof and specifically disclaim any implied warranties or merchantability or fitness for any particular purpose. Information in this publication is subject to change without notice and does not represent a commitment on the part of Embedded Artists AB.

### **Feedback**

We appreciate any feedback you may have for improvements on this document. Please send your comments to [support@EmbeddedArtists.com](mailto:support@EmbeddedArtists.com).

### **Trademarks**

InfraBed and ESIC are trademarks of Embedded Artists AB. All other brand and product names mentioned herein are trademarks, services marks, registered trademarks, or registered service marks of their respective owners and should be treated as such.

# Table of Contents

<b>1.1</b>	<b>Contents .....</b>	<b>4</b>
<b>1.2</b>	<b>Using <i>Bluetooth QuickStart Kit</i> in Products .....</b>	<b>4</b>
1.2.1	Design and Production Services .....	5
<b>1.3</b>	<b>Software License .....</b>	<b>5</b>
<b>1.4</b>	<b>Product Registration .....</b>	<b>5</b>
<b>1.5</b>	<b>Other QuickStart Boards and Kits .....</b>	<b>5</b>
<b>2.1</b>	<b>Software Platform .....</b>	<b>6</b>
<b>2.2</b>	<b>Features .....</b>	<b>6</b>
<b>2.3</b>	<b>Typical Usage .....</b>	<b>7</b>
<b>3.1</b>	<b>Typical Industrial Bluetooth Use-Cases .....</b>	<b>10</b>
<b>3.2</b>	<b>Remote Access .....</b>	<b>10</b>
<b>3.3</b>	<b>Remote Control .....</b>	<b>11</b>
<b>3.4</b>	<b>Remote Diagnostics .....</b>	<b>11</b>
<b>3.5</b>	<b>Local Service .....</b>	<b>12</b>
<b>3.6</b>	<b>Bluetooth Profiles .....</b>	<b>13</b>
3.6.1	Serial Port Profile .....	13
3.6.2	LAN Access Profile .....	13
<b>3.7</b>	<b>connectBlue's Modules .....</b>	<b>14</b>
<b>4.1</b>	<b>File Structure .....</b>	<b>15</b>
<b>4.2</b>	<b>Program Development .....</b>	<b>16</b>
4.2.1	InfraBed .....	17
4.2.2	IAR Embedded Workbench .....	17
4.2.3	Keil uVision .....	17
<b>4.3</b>	<b>Program Download .....</b>	<b>17</b>
4.3.1	Philips LPC2000 Flash Utility .....	18
4.3.2	LPC21ISP .....	18
<b>5.1</b>	<b>Schematic .....</b>	<b>20</b>
<b>5.2</b>	<b>Board Interfaces .....</b>	<b>22</b>
<b>5.3</b>	<b>Bluetooth Modules .....</b>	<b>24</b>
<b>5.4</b>	<b>Board Jumpers .....</b>	<b>25</b>
<b>5.5</b>	<b>Board Measurements .....</b>	<b>27</b>

# 1 Introduction

Thank you for buying Embedded Artists' *Bluetooth QuickStart Kit* based on the LPC2106 ARM7™ microcontroller from Philips and cb-OEMSPA-13i industrial Bluetooth module from connectBlue.

The *Bluetooth QuickStart Kit* contains a pre-designed platform, both hardware and software, with all necessary infrastructure functionality for using Bluetooth in industrial applications. The kit allows you to quickly evaluate the applicability of Bluetooth in YOUR application. Extensive documentation is included in order to lower the threshold of start using the kit even further. You can start to develop and include your own application on day 1.

The LPC2106 microcontroller from Philips is used on the board. It is part of Philips new ARM7TDMI-based family of high-performance microcontrollers.

This document is a User's Guide that describes the *Bluetooth Quickstart Kit* with accompanying software and program development tools. Amongst other, the document contains information about the included software and a description on how to develop and add your own application. Also, electrical and mechanical information about the board is included.

## 1.1 Contents

The box received when ordering the *Bluetooth QuickStart Kit* contains the following:

- One *Bluetooth QuickStart Board* including one cb-OEMSPA-13i Bluetooth module from connectBlue.
- One 64 Mbyte (or larger) SD memory card.
- One CD-ROM which includes all necessary software to start developing your application program. It contains complete as well as evaluation versions of different development environments along with a lot of sample applications.
- One DC power supply, 5 volt 300 mA. Observe that the *Bluetooth QuickStart Board* does not contain any reverse polarity protection. If voltage is applied with wrong polarity, the board will likely be damaged. Also observe that 6.0 volt is the absolute maximum voltage that can be applied without damaging the on-board voltage regulator (TPS70251). Consult the TPS70251 datasheet for exact details. Always use the included DC power supply to avoid possible damages.
- One serial extension cable, DB9-male to DB9-female (DB9M-DM9F), for connecting the *Bluetooth QuickStart Board* to a PC.

In addition, you may want the following in order to start developing applications with the *Bluetooth QuickStart Board*:

- An optional JTAG interface, for program development debugging.

Observe that a JTAG interface is not needed for downloading new programs into the *Bluetooth QuickStart Board*. This can be done through the serial channel, but a JTAG interface enables better control over the processor and better debug support.

## 1.2 Using *Bluetooth QuickStart Kit* in Products

The *Bluetooth Quickstart Board* is not primarily designed for use in volume productions. It has been designed as a reference platform that illustrates how Bluetooth can be used and as an experimentation platform. The board can be used for low-volume production. Low-cost bulk packages (10, or more boards) exist. Contact Embedded Artists for OEM pricing issues.

Modifications to the design for OEM production can easily be done. Contact Embedded Artists for further information about design and production services.

### 1.2.1 Design and Production Services

Embedded Artists provide design services for custom designs, either completely new or modification to existing boards. Specific peripherals and/or I/O can easily be added to the different designs, for example communication interfaces, specific analogue or digital I/O, and power supplies. Embedded Artists has extensive experience in designing industrial electronics in general, and specifically with Philips LPC2xxx microcontroller family.

- Prototype and low-volume production takes place in Sweden for best flexibility and short lead times.
- High-volume production takes place in China for lowest possible cost.

## 1.3 Software License

The software platform is provided as a library. This library may only be used in conjunction with the *Bluetooth QuickStart Board*, i.e., it may only run on a *Bluetooth QuickStart Board*. Embedded Artists sells commercial licenses for the software platform (including source code) that can run on any custom hardware. Please contact Embedded Artists for pricing information about commercial licenses of the software platform.

## 1.4 Product Registration

The accompanying CD-ROM contains a lot of information and programs that will QuickStart your program development. Observe that there may be newer versions of different documents and programs available than the ones on the CD-ROM.

By registering as a customer of Embedded Artists and as a *Bluetooth QuickStart Kit* user you will always have access to the latest information and new material (e.g., new sample applications).

Registering is easy and done quickly.

- 1) Go to <http://www.EmbeddedArtists.com>, select *Support* and then *Register*.
- 2) Type in the products serial number (can be found on the *Bluetooth QuickStart Board* or on the package carrying the board) along with your personal information.

## 1.5 Other QuickStart Boards and Kits

Visit Embedded Artists' home page, [www.EmbeddedArtists.com](http://www.EmbeddedArtists.com), for information about other *QuickStart* boards / kits or contact your local distributor.

## 2 Bluetooth QuickStart Kit

This chapter provides a description of the *Bluetooth QuickStart Kit*; the platform (software and hardware aspects), features, and typical usage.

### 2.1 Software Platform

The *Bluetooth QuickStart Kit* includes a pre-designed software platform that integrates a mayor part of the needed infrastructure for advanced Bluetooth applications. By using the platform you avoid the long and narrow “do-it-yourself” way when start using new technology with all these typical activities:

- Researching (RTOS, Compiler/IDE, TCP/IP Stack, PPP Stack, Web Server, File System)
- Hardware design (this is of course not part of the software platform, but an activity that is typically also required if you don't buy an off-the-shelf hardware board).
- Configuration (RTOS, Compiler/IDE, TCP/IP Stack, PPP Stack, Web Server, File System, Board Support Package)
- Testing (hardware, each individual software component, integrating the platform)

Figure 1 below illustrates both the software and hardware side of the *Bluetooth QuickStart Kit* platform. Many sample applications are included in the kit just to lower the threshold of start using the kit and to quickly get you up-and-running. The green parts in the picture illustrate the mayor software infrastructure functions.

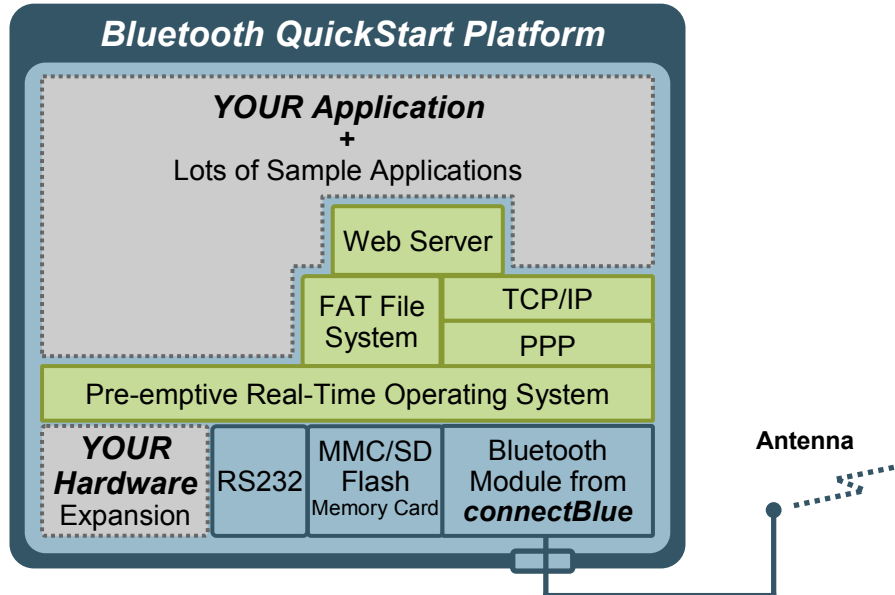

Figure 1 – Bluetooth QuickStart Platform

### 2.2 Features

The *software features* of Embedded Artists' *Bluetooth QuickStart Kit* are:

- Contains a pre-designed software platform with all necessary infrastructure:
  - RTOS, TCP/IP Stack, PPP Stack, Web Server, FAT File System, Registry
- Code delivered as a binary library
  - Source code package also available as separate purchase.

- Software platform code base is easily ported and extended to other hardware, including other processor families.
- Many sample applications included in order to lower the threshold to get you started.
- Complete development environment is included (compiler, linker, make, editor, etc.)
  - Based on GCC.
  - Other compilers also supported, like Keil and IAR.
- The user can easily add own applications and experiment with the technology.
  - About 30 kbytes of FLASH available and about 10 kbyte of SRAM

The **hardware features** of Embedded Artists' *Bluetooth QuickStart Kit* are:

- Built around the new LPC2106 from Philips (ARM7TDMI).
  - 128 Kbyte program Flash and 64 Kbyte SRAM
  - Processor pins available on an expansion connector for user hardware expansion.
- cB-OEMSPA13i Bluetooth module from connectBlue included in kit.
  - Also works with cB-OEMSPA13x (external antenna) and cB-OEMSPA33i/x (100 meter version).
  - Works with connectBlue's Serial Port Adapter Wizard program
- Connector for MMC/SD memory card
- ESD/EMI protected RS232 channel available for connection with other systems or debug printouts.
  - Support for automatic program download over the serial channel.
- 32 kByte non-volatile parameter memory (256 Kbit I<sup>2</sup>C E<sup>2</sup>PROM)
- Standard 20 pos. ARM JTAG connector available for debug.
- Size: 108 x 58 mm
  - Four mounting holes are 100 x 50 mm apart
- Power: 5VDC, <150mA

### 2.3 Typical Usage

The *Bluetooth QuickStart Kit* can be used to easily create advanced MMI (Man-Machine-Interfaces) based on Internet technologies:

- Use the web server to expose information and parameters that can be controlled.
- Use the file system to store HTML files and picture files.
- Use the serial channel to communicate (expose information or control parameters) with ANY System.
- Access the system directly via a PDA, a laptop, or a Bluetooth LAN access point.

*Figure 2* below illustrates how the *Bluetooth QuickStart Board* can be connected to any embedded system and expose internal variables in this system, or alternatively controls

internal parameters in the system. Communication with the (arbitrary) embedded system can be done via the RS232 serial channel.

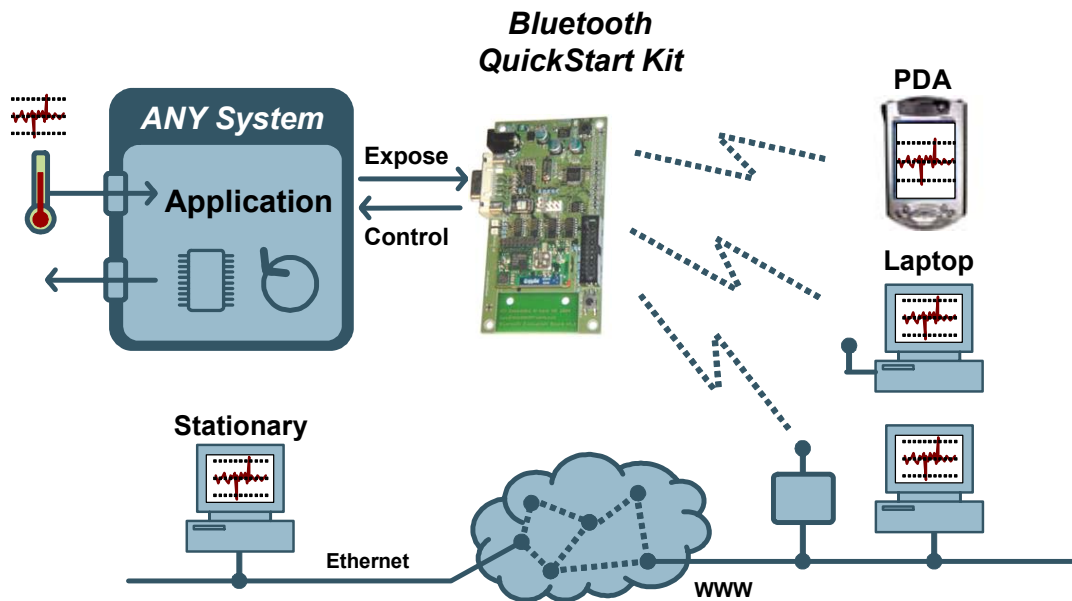

Figure 2 – Typical Bluetooth QuickStart Application Scenario

In the scenario above, the *Bluetooth QuickStart Board* is used to create an advanced user interface to the embedded system. It is also possible to embed a complete application into the *Bluetooth QuickStart Board*. Relatively large applications can be added to the pre-designed software platform and the hardware can be expanded with necessary I/O. *Figure 3* below illustrates this scenario.

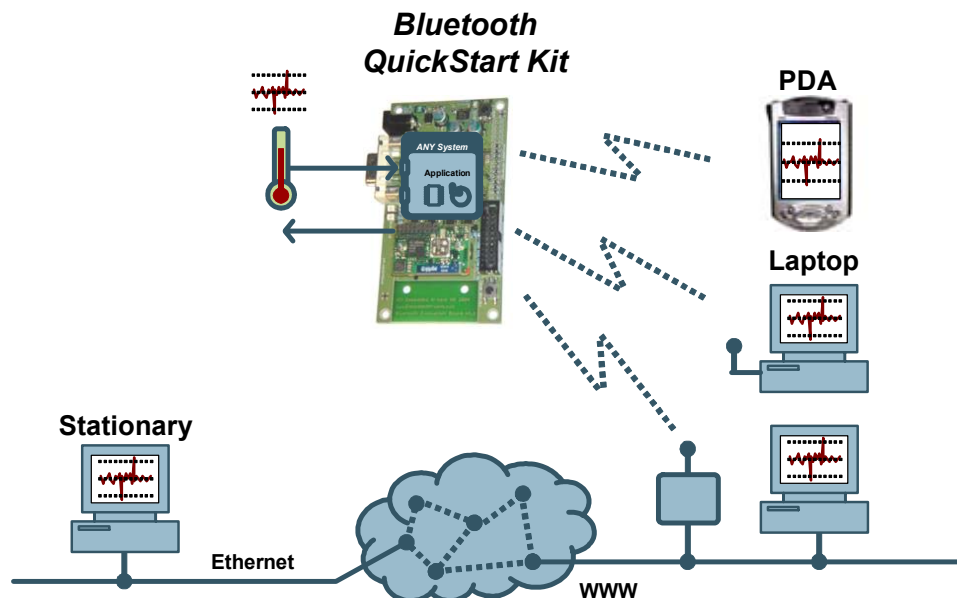

Figure 3 – Integrating a Complete Application into the Bluetooth QuickStart Board

There is a trend towards more integrated system solutions, especially in industrial applications. Driving factors are more cost effective solutions (in many cases also increased performance) and better possibilities for surveillance, diagnostics, and maintenance. There



are many interesting business possibilities when integrating diagnostic functions in a system, like better maintenance and a profitable after market. Remote administration and remote control gives the prerequisites of lower working expenses, lower total system costs, and a profitable after market.

**The *Bluetooth QuickStart Kit* allows you to experiment and develop these kinds of applications.**

## 3 Bluetooth Use-Cases

This chapter provides a description of typical use-cases when using Bluetooth in industrial applications.

### 3.1 Typical Industrial Bluetooth Use-Cases

There are basically two different use-cases for industrial Bluetooth applications:

- **User Interface**  
In this case, Bluetooth is used to access a system wirelessly in order to control different parameters and/or to retrieve information. A web server is used to create the user interface and a standard web browser can be used to access the system.
- **Machine-to-Machine Communication (M2M)**  
In this case, Bluetooth is used for communication between different (industrial) systems. Standard TCP/IP communication is used to transfer information. Alternatively, Bluetooth is used to create a simple serial cable replacement. The Bluetooth modules from connectBlue have this feature built-in from start (i.e., the serial cable replacement). The *Bluetooth QuickStart Kit* is used to create more advanced applications based on TCP/IP communication.

A user interface can be viewed as the manual version of the automatic M2M communication. An operator can basically perform all the operations manually that would otherwise take place automatically.

The following sections will describe a couple of typical advanced industrial Bluetooth use-cases, all of which can be built by using the *Bluetooth QuickStart Kit*. Motor applications are used to illustrate the industrial function, but can of course be any industrial building component.

### 3.2 Remote Access

Remote access of a system has many benefits:

- A more up-to-date view of the system is possible, even though the different parts of the system may be far apart. Bluetooth support distances up to 100 meters. If a longer distance is needed, some systems may connect directly to an Ethernet network.
- General cost reduction since information can be accessed without physical presence near the system.

Examples of remote access systems are different meter systems, like power meters and water meters. The information is produced locally (at a remote location) and is more valuable in a central place. *Figure 4* below illustrates the remote access use-case.

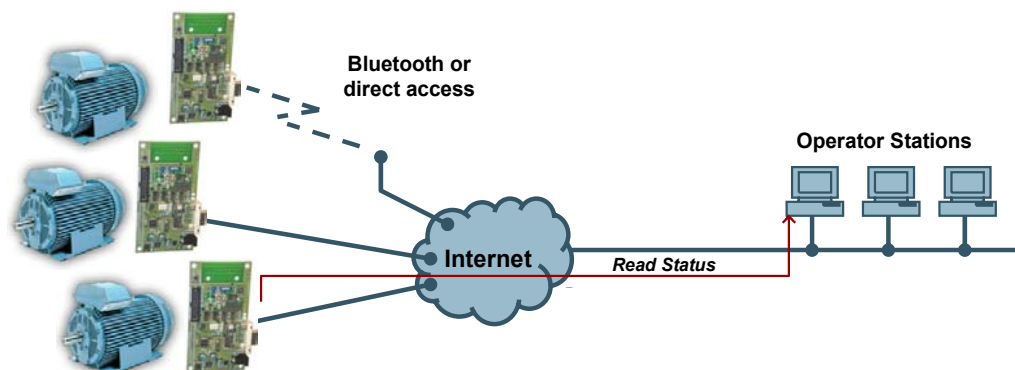

Figure 4 – Remote Access Use-Case

### 3.3 Remote Control

Remote control is almost the same as remote access. The only difference is the direction of the information. In remote access the information mainly flows from the remote system to (typically) a central place. In remote control the information direction is the opposite; from the central place to the remote system. A number of (typical) example applications are:

- **Motor control**, which can for example be a softstarter, power control (on/off), adding remote I/O capabilities, and simple PLC functionality.
- **Pumps**, which is basically a motor system that must be controlled.
- **Conveyors**, which is also a motor system with many parameters to set.
- **Ventilation systems**, which can be advanced control systems with many parameters to set and control.
- **Device configuration**, which is the general case of controlling a remote system.

Figure 5 below illustrates remote control of a motor, either via direct cabling or direct Bluetooth access via a PDA or laptop.

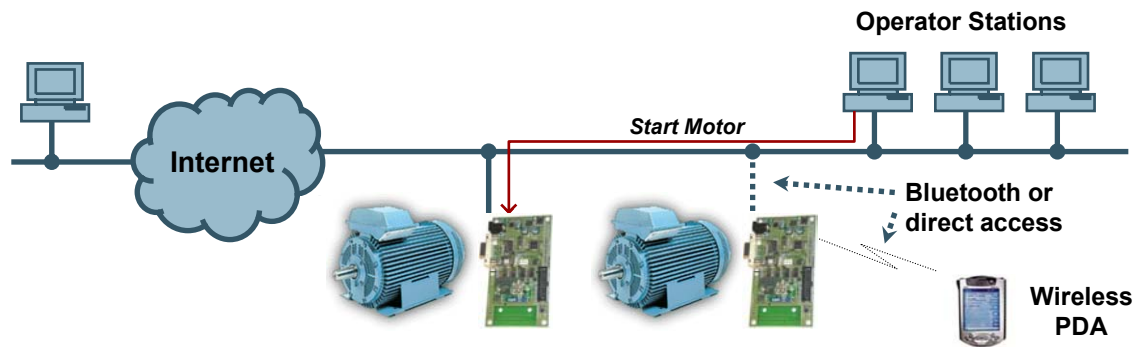

Figure 5 – Remote Control Use-Case

There are many benefits when creating remote control systems:

- Of course, the ability to control remote control systems at remote locations
- Wireless control, sometimes as simple as serial cable replacement, but also more advanced forms of communication.
- The possibility to control hazardous applications, which can for example be dangerous to be physically close to the system (i.e., rotating or high-voltage).

### 3.4 Remote Diagnostics

Remote diagnostics is an important application of remote access. An example application is motor diagnostics that will serve as a reference application in this description. Examples of analyses are:

- Bearing vibration analysis
- Voltage and current measurement
- Temperature measurement
- Counting number of start and stops

The information can either be locally analyzed or sent to a central location for further processing. Decisions, like immediately stopping the motor, can be taken locally if the

decisions must be made quickly. Trends can be discovered when analyzing the data, for example that a bearing is about to break down but will hold for another two months. Maintenance can in such cases be planned in advance to minimize the operation costs. *Figure 6* below illustrates a typical system with motor diagnostics.

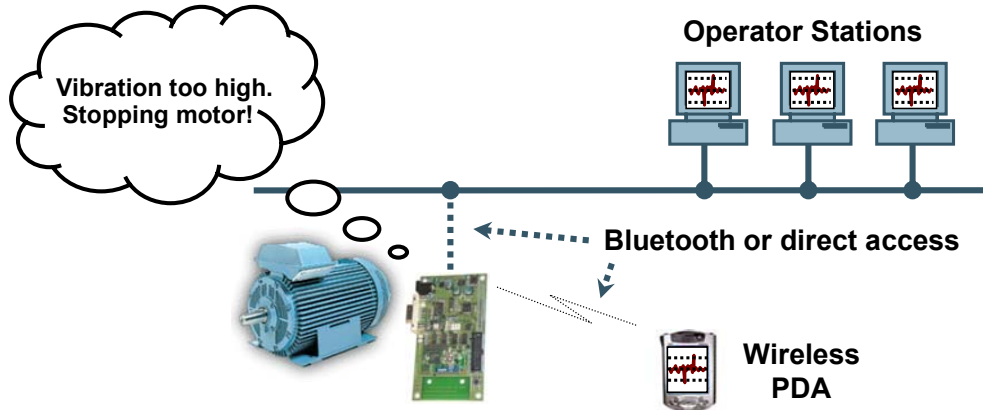

Figure 6 – Remote Diagnostics Use-Case

The benefits of remote diagnostics are numerous:

- Lower maintenance cost
- Fewer unexpected system failures since maintenance can be planned in advance
- The prerequisite for Service Level Agreements (SLAs)
- The possibility for remote data logging

### 3.5 Local Service

Local service is a good example of how the web server functionality in the *Bluetooth QuickStart Board* can be used. The system stores a number of relevant documents, such as:

- Service Logs
- Blueprints
- Datasheets
- User's Manuals

The system can of course also be configured via the web server user interface. *Figure 7* below illustrates the local service use-case.

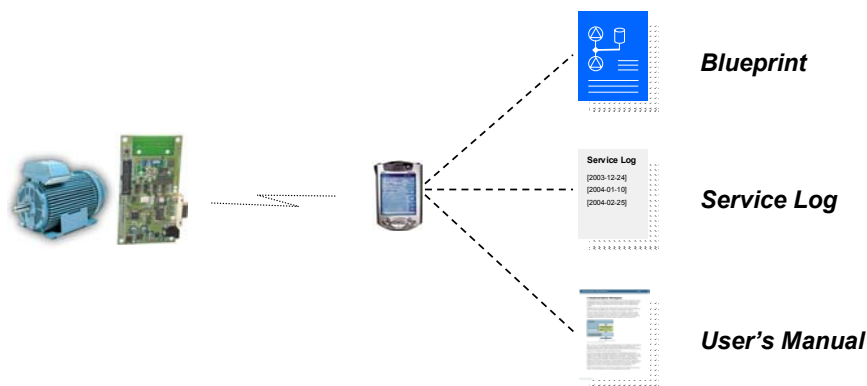

Figure 7 – Local Service Use-Case

A field engineer, or similar, can then easily access all relevant documents directly on site. The system becomes more self-contained since all relevant documents “follow” the system.

The benefits are also in this case numerous:

- Easy local access to the system
- No need to physically connect to the system
- Manuals and logs are always available on the system

### 3.6 Bluetooth Profiles

What is a Bluetooth profile?

Well, it is basically the result of genuine engineering work. The profile concept is used to minimize (perhaps not completely eliminate) the risk of interoperability problems between different manufacturers' Bluetooth products. A number of user models describe different user scenarios and roles, where Bluetooth performs the radio transmission. Different profiles have been developed based in these use cases. A profile describes how to implement a specific group of use cases. It also defines options in each protocol (in the Bluetooth protocol stack) that are mandatory for the profile, as well as parameter ranges for each included protocol.

The profile protocols can be viewed as protocols placed on top of the basic Bluetooth protocol stack. A profile can be described as a vertical slice through the protocol stack. Many profiles build on each other. For example, the LAN Access profile requires the Serial Port profile, as do the Dial-up Networking profile.

Every Bluetooth unit must support the Generic Access Profile, or GAP for short. It defines many of the basic Bluetooth functions, such as device discovery, security, and name discovery.

#### 3.6.1 Serial Port Profile

There are a lot of profiles that have absolutely no use in industrial applications but rather targeted for specific consumer applications, such as transferring pictures from a digital camera, transferring data to a printer, and sending/receiving faxes. These profiles will not be covered, but two profiles are worth mentioning. The first of them is the Serial Port Profile, or SPP for short. It emulates a serial cable connection between two peer devices, or simply put, transparently transfers a stream of byte from point A to point B and vice versa.

SPP has defined the roles DevA and DevB. DevA is the initiator of a connection, and DevB is hence the recipient of a connection request. In order for a device to enable incoming connections, the DevB role must be enabled in that specific device. It is possible to have several parallel connections in a device, i.e. several instances of DevA and/or DevB. *Figure 8* below illustrates the different SPP roles.

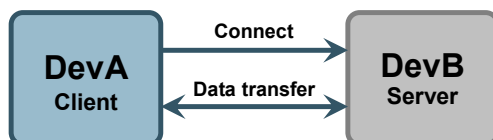

Figure 8 – Serial Port Profile Roles

#### 3.6.2 LAN Access Profile

The second profile what we will have a closer look into is the LAN Access Profile, or LAP for short. It allows a device to access a LAN (typically an Internet network) through a gateway (actually a server). LAP has defined the roles LAN Access Point (LAP) and Data Terminal (DT). The LAP acts like a gateway and provides the actual LAN access, and the DT device uses the services provided by LAP. *Figure 9* illustrates the roles. To enable

incoming connection requests to the LAN Access Profile, the LAP role must be enabled in that specific device. It is possible to enable several instances of the LAP role in order to allow several parallel connections through the LAP. A device must take the DT role in order to connect to other devices supporting the LAP role.

The data transfer takes place over PPP and TCP/IP, which encapsulate the actual user data. The LAN Access profile only provides a transparent serial channel, much like SPP. Only PPP is dictated by the profile, but TCP/IP is almost always used on top of PPP.

Also observe that the LAN must not be an actual LAN (like Ethernet). It can also be a simulated LAN, which is very application specific.

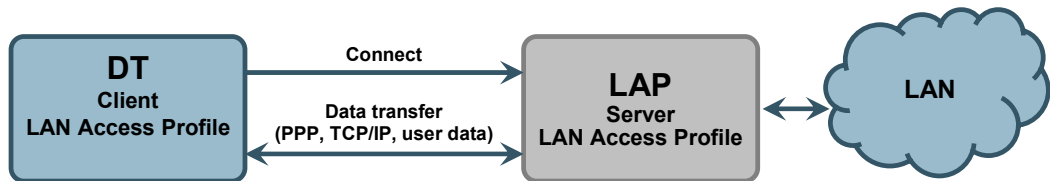

Figure 9 – LAN Access Profile Roles

### 3.7 connectBlue's Modules

The Bluetooth module (cB-OEMSPA-13i) from connectBlue that is used in the *Bluetooth QuickStart Kit* can operate in one of several different profile modes:

- **SPP server**  
The module waits for SPP clients to connect and establish transparent serial channels. This mode is not used in the *Bluetooth QuickStart Kit*.
- **SPP clients**  
The module tries to connect to SPP servers, in order to establish a transparent serial channel. This mode is not used in the *Bluetooth QuickStart Kit*.
- **LAN Access Server**  
This is the normal operating mode when using the *Bluetooth QuickStart Kit*. The board behaves as a web server that can be accessed from LAN clients that connect to the LAN server. The system waits for clients (i.e., web browsers) to connect. There is no actual LAN that is accessed. Instead the TCP/IP stack and web server on the board are accessed.
- **LAN Access Client**  
This is an alternative operating mode when using the *Bluetooth QuickStart Kit*. In this case, the system initiate connection requests (i.e., it is a client) to other LAN access servers. These servers can be only web servers without any actual LAN behind when, or they can be LAN access points. In the latter case, the servers act as gateways between the Bluetooth world and (typically) a wired Ethernet world.

## 4 Compiling and Running Application Programs

This chapter provides a description of how to develop, compile, and download applications into the *Bluetooth QuickStart Board*.

### 4.1 File Structure

The pre-designed software platform is delivered as a library along with a number of header files that declare the different API:s. See *BApplication Program Interface (API)* for a detailed API description. The platform contains the following main infrastructure functions:

- Pre-emptive Real-Time Operating System (RTOS)
- TCP/IP protocol stack
- PPP protocol stack
- Web server
- File system, supporting MMC/SD memory cards. Supports FAT16.
- Registry, for non-volatile storage of parameters

The platform is placed in a directory called **QSPPlatform**. This directory contains two important files; **quickstart\_vXYZ.a** (which is the library of the platform) and **quickstart\_vXYZ.h** (which is the API definition). **\_vXYZ** indicate the version of the platform, and can for example be **\_v102** (meaning version 1.0.2). See *Figure 10* below for an illustration of the file structure.

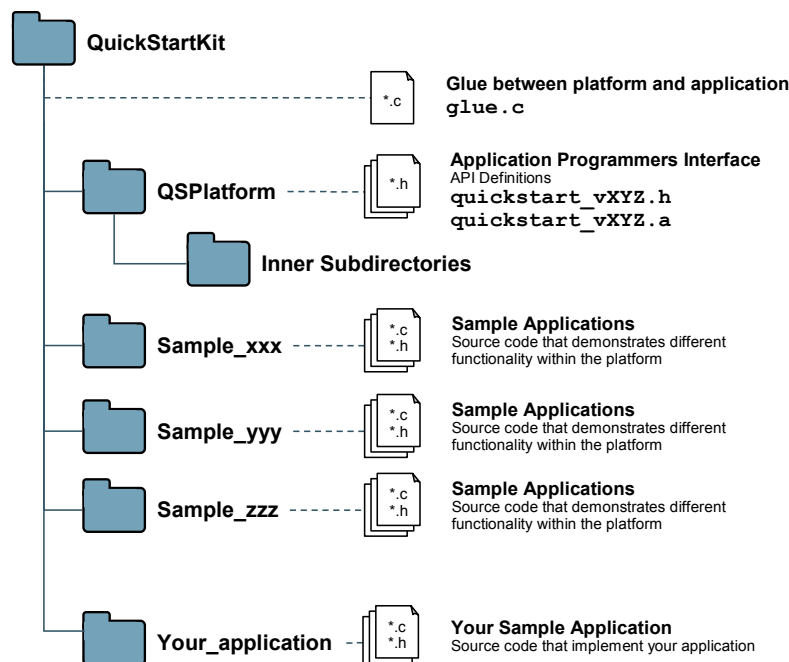

Figure 10 – Bluetooth QuickStart Kit File Structure

A number of sample applications are included in the *Bluetooth QuickStart Kit*. These are placed in the different **sample\_xxx** subdirectories. It is recommended to study these examples for a better understanding of the platform and how to create custom applications. Each sample application typically contains one, or more, C-files implementing the

application and a makefile. The makefile contains directives of how to compile and link the complete application. A typical makefile is listed in *Figure 11* below.

```

/*
 * Example makefile that creates a program called 'mySampleApp'
 */

# name of the program
NAME = mySampleApp

PROJECT_ROOT = .

# Link program to RAM or ROM (possible values for RAMROM is RAM or ROM,
# if not specified = ROM)
RAMROM = ROM

# ELF-file contains debug information, or not
# (possible values for DEBUG are 0 or 1)
DEBUG = 1

# Optimization setting
# (-Os for small code size, -O2 for speed)
DBFLAGS = -Os

#Extra flags
EFLAGS = -mthumb-interwork

# Processes run in ARM or THUMB mode
# OBS. Do not change this setting. Instead, re-generate the operating system
TASK = THUMB

# subdirectories to recursively invoke make in
SUBDIRS =

# additional libraries to merge into this library
LIBS = ../quickstart/quickstart_vXYZ.a

# c-code files
CSRCS = ../glue.c \
        mySampleApp.c

include program.mk

```

Figure 11 includes three callouts:

- A callout pointing to `NAME = mySampleApp` with the text: "Name of final program."
- A callout pointing to `LIBS = ../quickstart/quickstart_vXYZ.a` with the text: "Include the platform library: quickstart.a"
- A callout pointing to the `CSRCS` list with the text: "Always include glue.c Also include all application files, in this case: mySampleApp.c"

Figure 11 – Example Makefile

A typical application (**mySampleApp.c**, in this case) includes the file **glue.c** (under the file root) and includes **quickstart\_vXYZ.h** whenever the platform API must be used. The file **glue.c** contains a number of initialization functions and program hooks (can be used for extending the functionality of the platform). Also, the library **quickstart\_vXYZ.a** is included in the final link stage.

## 4.2 Program Development

Three different application program development environments are supported:

- InfraBed from Embedded Artists**  
 Embedded Artists unique configurable software generator contains a complete GCC build environment for very easy program development. The current version of GCC is 3.4.3. By installing InfraBed you will automatically also get a complete setup of the build environment. This is the preferred way of developing and compiling application programs.
- IAR Embedded Workbench**  
 A complete development environment from IAR Systems, including an editor, project manager, a complete compiler build environment, and a debugger. This development environment must be bought separately from IAR.



- **Keil uVision (DKARM version)**

This is another complete development environment, but from Keil. It includes an editor, project manager, a complete compiler build environment, and a debugger. An evaluation version can be downloaded from Keils homepage. The DKARM-version is based on the GCC compiler (currently version 3.3.1 of GCC). It is this version of the compiler that can be used for application development.

#### 4.2.1 InfraBed

Along with InfraBed, a complete build environment and program download exist for GCC. The build environment is built around a bash script. This script sets up all necessary paths. When installing InfraBed you will automatically get shortcuts to this bash script. A practical feature is that there can be different scripts for different hardware platforms, for controlling different hardware specific details of the platforms. There can also be many different compilers (including different versions of the same compiler) without conflicting with each other.

To build the application program, start a command prompt (the bash script) and type: **make**. Depending on the make file content, either an executable program or a library will be created. To also download the executable program, type: **deploy** instead of **make**. A description about program downloading can be found in *Section 4.3*.

A final note about the make file; **make clean** will erase all object file.

#### 4.2.2 IAR Embedded Workbench

Consult the IAR Embedded Workbench documentation (after installation) for details about how to get started.

#### 4.2.3 Keil uVision

Consult the Keil uVision documentation (after installation) for details about how to get started.

### 4.3 Program Download

When the application program has been written, compiled, and linked with the platform it is time to download the program into the *Bluetooth QuickStart Board*. It is assumed that there exists a HEX-file that represents the binary image of the complete program.

There are basically two ways of downloading a program into the LPC2106 microcontroller:

- **ISP – In-System Programming**

The LPC2106 microcontroller provides on-chip bootloader software that allows programming of the internal flash memory over the serial channel. The bootloader is activated by pulling port pin P0.14 low during reset of the microcontroller. The *Bluetooth QuickStart Board* contains circuits for automatically controlling pin P0.14 and the reset signal over the RS232 channel. This allows the program download to be fully automated.

- Philips provides a utility program for In-System Flash (ISP) programming called *LPC2000 Flash Utility*.
- Alternatively, there is a program called LPC211ISP that can be used. Source code is available. This program also provides a terminal functionality, which can be very helpful when developing your application program. The same serial channel that is used to download the program is typically also used for printing out information from the running program. The program immediately switch to terminal mode after program download and will hence not miss any characters sent on the serial channel directly after program start.

The installation files for both programs can be found on the accompanying CD-ROM.

- JTAG  
For specific information about program download (i.e., Flash programming) with a JTAG interface, consult the manual for the specific JTAG interface that is used (e.g., J-link from Segger, Ulink from Keil, or Wiggler from MacRaigor).

Set switch SW2 in the position that enables the automatic program download feature. After program download, switch SW2 can be left in the “enable automatic bootloader” position or changed into the “disable automatic bootloader” position, if needed. If, for example, the system that is connected to the RS232 channel controls the RS232 signals DTR and/or RTS during normal program execution, then it might be required that SW2 is placed in the “disable automatic bootloader” position. Else the automatic bootloader may be unintentionally activated.

#### 4.3.1 Philips LPC2000 Flash Utility

Philips LPC2000 Flash Utility program looks like *Figure 12* below.

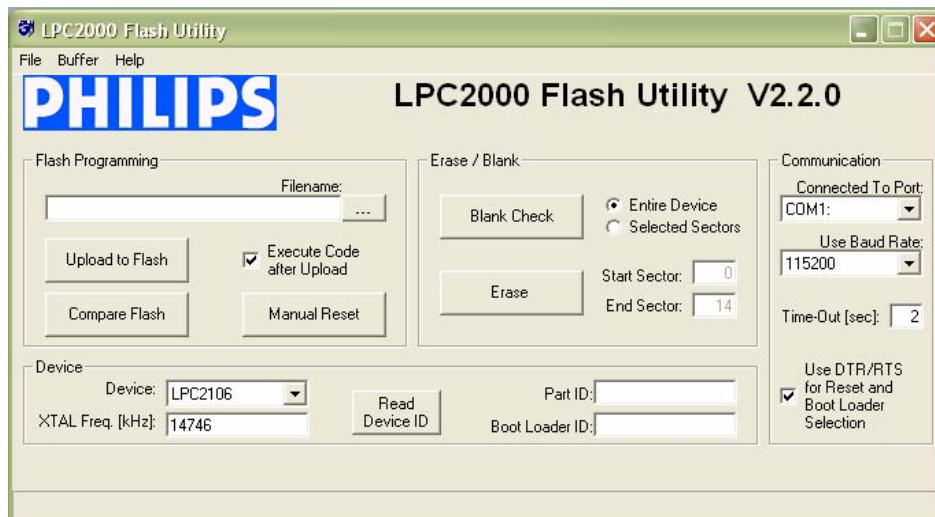

Figure 12 – Philips LPC2000 Flash Utility Screenshot

Configure the dialog as shown above. The program will control the RS232 signals DTR and RTS if the appropriate checkbox is checked, and hence provide fully automated program download.

Test connection with the *Bluetooth QuickStart Board* by pressing the *Read Device ID* button. The text fields for *Part ID* and *Boot Loader ID* will then contain uploaded information from the microcontroller. Observe that the XTAL Freq. must be set to appropriate value. The default mounted crystal frequency on the *Bluetooth QuickStart Board* is 14.7456 MHz. In this case the value 14746 shall be written in the text box. If no connection can be established test with a low *Baud Rate*, for example 1200 bps. Also verify that the correct COM-port has been selected (under *Connected to Port*).

Select the HEX file to be downloaded and then press the *Upload to Flash* button.

The downloaded program will immediately start after the download (i.e. the *Upload to Flash* operation is ready) is the option *Execute Code after Upload* is checked.

#### 4.3.2 LPC21ISP

The LPC21ISP program is made publicly available by Martin Maurer. Source code is also available at: <http://engelschall.com/~martin/lpc21xx/isp/index.html>. *Figure 13* below shows the command syntax for the program.

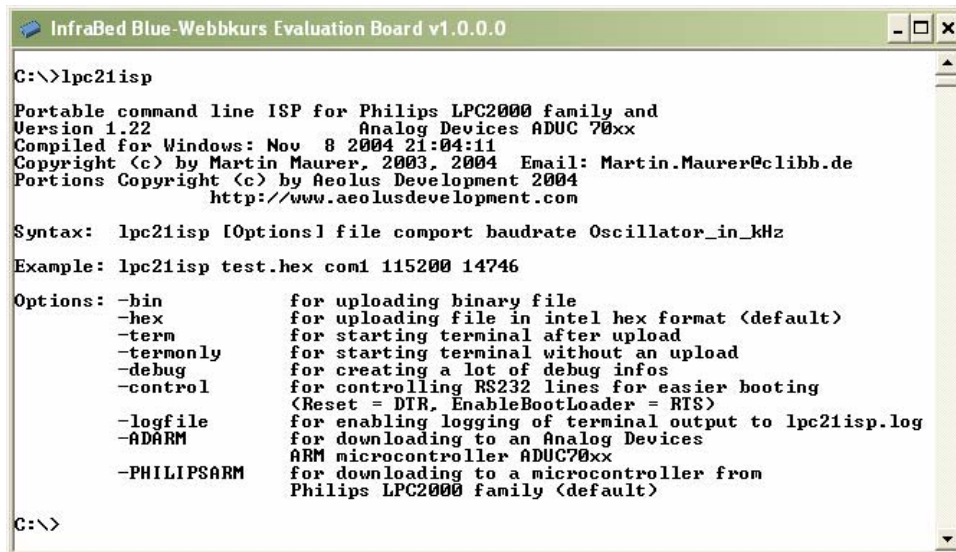

```

C:\>lpc21isp
Portable command line ISP for Philips LPC2000 family and
Version 1.22          Analog Devices ADUC 70xx
Compiled for Windows: Nov  8 2004 21:04:11
Copyright (c) by Martin Maurer, 2003, 2004  Email: Martin.Maurer@cplib.de
Portions Copyright (c) by Aeolus Development 2004
                    http://www.aeolusdevelopment.com

Syntax: lpc21isp [Options] file comport baudrate Oscillator_in_kHz
Example: lpc21isp test.hex com1 115200 14746

Options: -bin          for uploading binary file
         -hex          for uploading file in intel hex format (default)
         -term        for starting terminal after upload
         -termonly    for starting terminal without an upload
         -debug       for creating a lot of debug infos
         -control     for controlling RS232 lines for easier booting
                    (Reset = DTR, EnableBootLoader = RTS)
         -logfile     for enabling logging of terminal output to lpc21isp.log
         -ADARM       for downloading to an Analog Devices
                    ARM microcontroller ADUC70xx
         -PHILIPSARM for downloading to a microcontroller from
                    Philips LPC2000 family (default)

C:\>

```

Figure 13 – LPC21ISP Portable Command Line ISP Screenshot

A typical program download sequence may look like in *Figure 14* below. As seen, the first part is the actual program download phase. Then this is done, the program switches to being a terminal (the second part) and the messages from the application program are displayed. It also sends anything typed on the keyboard back to the *Bluetooth QuickStart Board*. As seen the program ends when ESC is pressed.

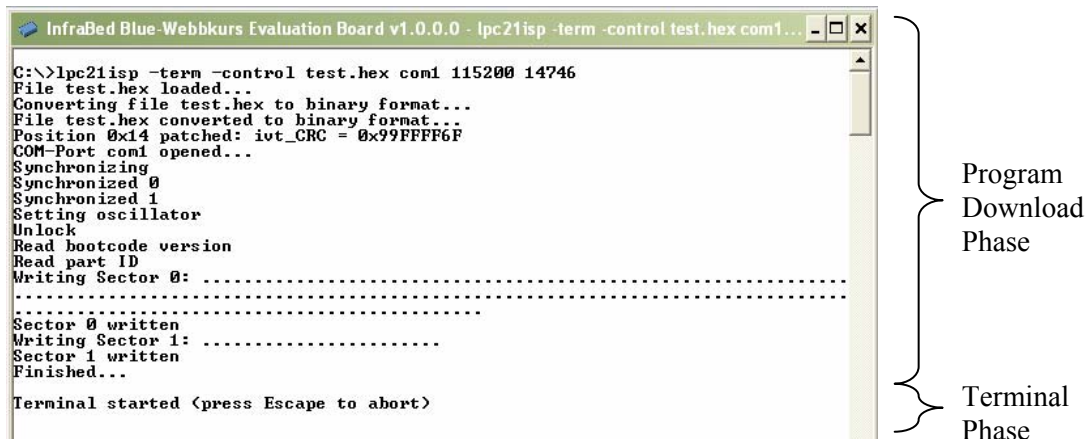

```

C:\>lpc21isp -term -control test.hex com1 115200 14746
File test.hex loaded...
Converting file test.hex to binary format...
File test.hex converted to binary format...
Position 0x14 patched: ivt_CRC = 0x99FFFF6F
COM-Port com1 opened...
Synchronizing
Synchronized 0
Synchronized 1
Setting oscillator
Unlock
Read bootcode version
Read part ID
Writing Sector 0: .....
.....
Sector 0 written
Writing Sector 1: .....
Sector 1 written
Finished...

Terminal started (press Escape to abort)

```

} Program  
} Download  
} Phase

} Terminal  
} Phase

Figure 14 – LPC21ISP Portable Command Line ISP Download Screenshot

Observe that the binary version 1.22 of the program will not work directly without a change in the reset timeout (when the program tries to synchronize to the *Bluetooth QuickStart Board*). The timeout must be increased to at least 200 ms.

LPC21ISP is automatically invoked when **deploy** is typed in the command prompt (the bash script from InfraBed).

# 5 Schematic and Measurements

The chapter describes the *Bluetooth QuickStart Kit* board schematic and measurements.

## 5.1 Schematic

The *Bluetooth QuickStart Kit* board schematic is drawn in *Figure 15* and *Figure 16* below.

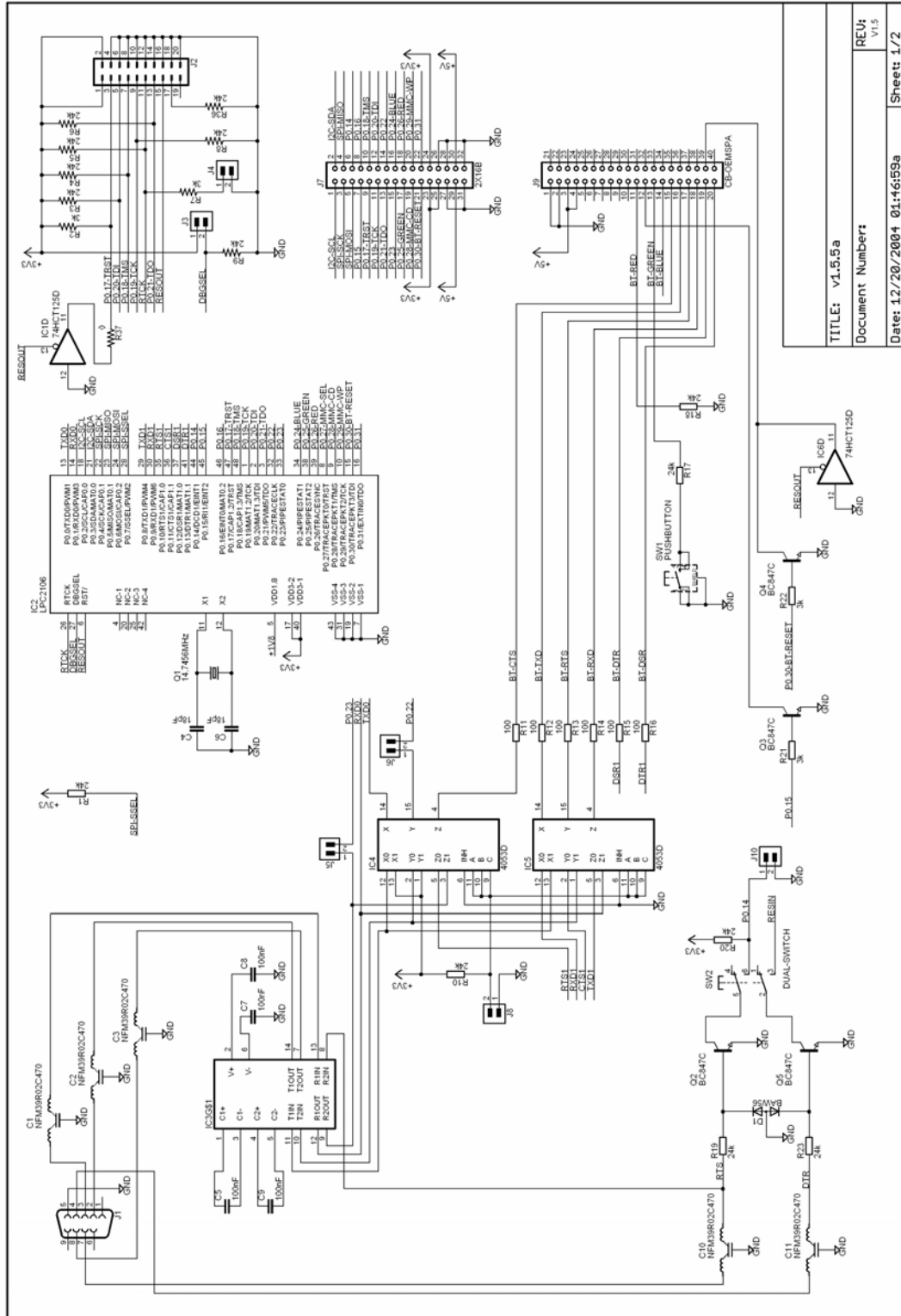
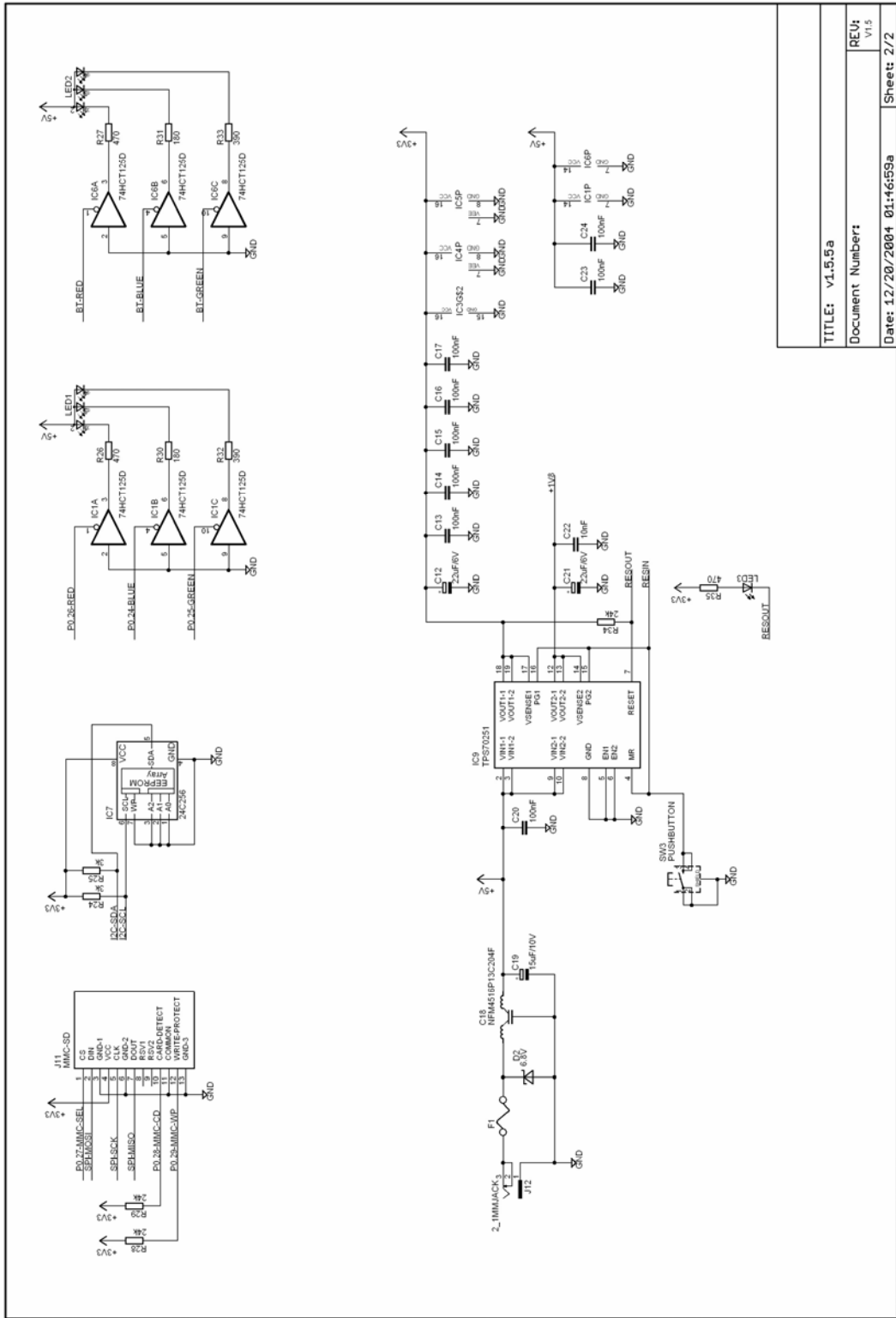

Figure 15 – Bluetooth QuickStart Board Schematic Drawing Page 1



TITLE: v1.5.5a	REV: v1.5
Document Number:	Sheet 2/2

Figure 16 – Bluetooth QuickStart Board Schematic Drawing Page 2

## 5.2 Board Interfaces

The *Bluetooth QuickStart Kit* board has a number of external interfaces as illustrated in *Figure 17* below.

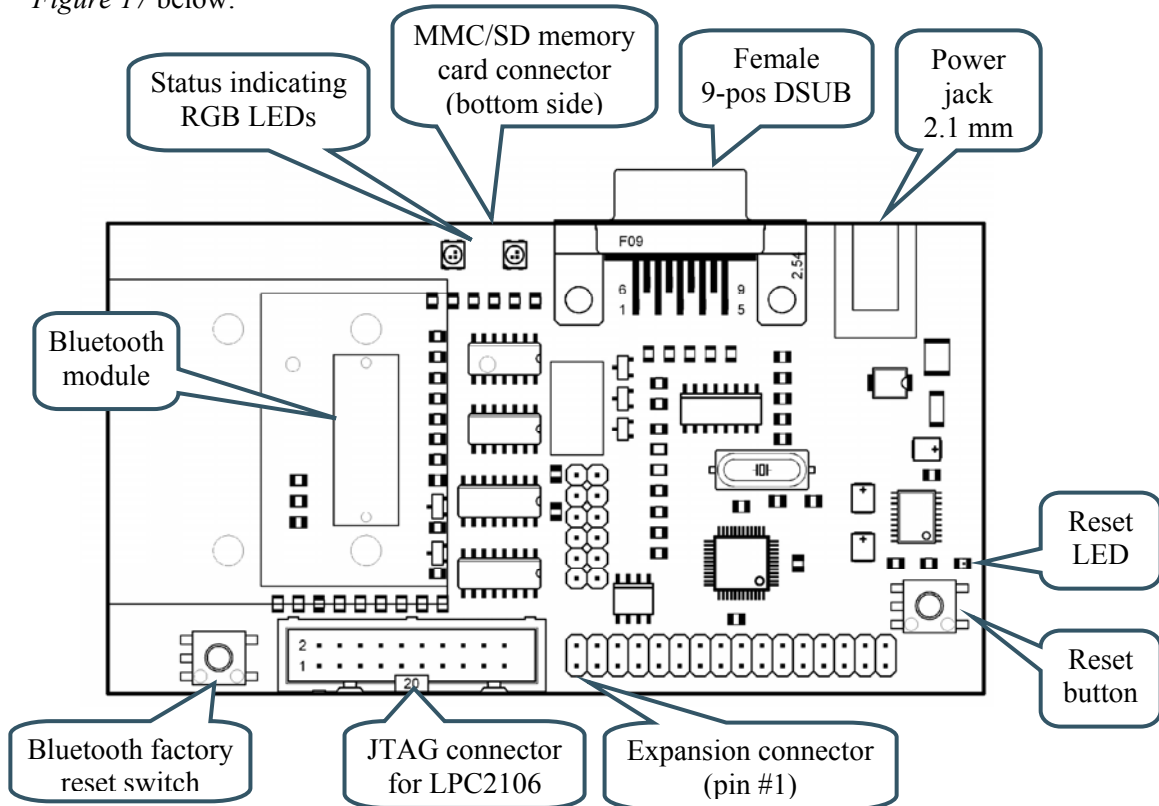

Figure 17 – Bluetooth QuickStart Board Interface Description

Table 1 below explains each board interface in more detail.

### Female 9-pos DSUB

A standard RS232 channel with ESD/EMI protection. Normally connected to a PC or an embedded system.

Connector is used for:

1. Program download
2. Terminal printouts for application program development debugging
3. Connection with ANY embedded system, in order to transfer data between the system and the *Bluetooth QuickStart Board*.

Pin 2 = transmit data (output)

Pin 3 = receive data (input)

Pin 4 = DTR (input) for controlling automatic program download

Pin 5 = ground

Pin 7 = RTS (input) for controlling automatic program download

Pin 8 = CTS (output)

**Power jack**

4-6 V DC, at least 150 mA.

The power input is protected against reverse polarity, but the board may still be damaged if reverse polarity is applied. Also, never exceed +6V DC because the on-board voltage regulator will then be damaged.

Always use the power supply that comes with the *Bluetooth QuickStart Kit*.

Center pin = Ground

Outer shield = +4-6V DC

**Reset LED**

Reset is typically active 120 mS.

The LED lights when reset is active, i.e., the reset signal is low.

**Reset button**

Manual reset button that will generate a 120 mS reset pulse.

**Expansion connector**

All processor pins are available at the expansion connector. Many pins are used by the *Bluetooth QuickStart Kit* platform, but some are still available. Consult the LPC2106 datasheet for detailed signal description.

See schematic (*Figure 15* and *Figure 16*) for signal positions.

**JTAG connector**

JTAG connector for program download and program debugging. Consult the LPC2106 datasheet and ARM JTAG description for details about all signals and functionality.

Standard 20 pos. ARM JTAG connector.

How the connector is connected to the LPC2106 processor pins is shown in the schematic, see *Figure 15*.

**Bluetooth module**

This is the Bluetooth module from connectBlue. Consult the modules datasheet for detailed functional and signal description.

See cB-OEMSPA-13i datasheet for signal description

**Bluetooth factory reset switch**

This push-button is connected directly to the Bluetooth module and is part of the factory reset functionality. Consult the cB-

OEMSPA-13i datasheet for details about functionality.

This push-button should normally never be used, and it is only active during power-up of the Bluetooth module.

### RGB LED #1

This RGB LED is controlled from the Bluetooth module and indicates current status.

Green =	Module is OK
Orange =	Module is in AT-command mode
Blue =	A connection is active
Flashing Blue =	Data is transferred over the active connection
Red =	Reset or illegal AT-commands received

### RGB LED #2

This RGB LED is controlled by the application program and can be used for program debugging or showing application status.

Table 1 – Board Interfaces

## 5.3 Bluetooth Modules

The Bluetooth connector (J9 in the schematic) supports four different versions in the OEM Serial Port Adapter family from connectBlue, as listed in *Table 2* below.

Name	Size	Bluetooth Data
OEMSPA13i	23 x 36 mm	Class 2 / 0 dBm with internal antenna It is this Bluetooth module that the <i>Bluetooth QuickStart Kit</i> is shipped with.
OEMSPA13x	23 x 36 mm	Class 2 / 0 dBm with external antenna
OEMSPA33i	40 x 42 mm	Class 1 / 20 dBm with internal antenna
OEMSPA33x	40 x 42 mm	Class 1 / 20 dBm with external antenna

Table 2 – OEM Serial Port Adapters



## 5.4 Board Jumpers

There are six jumpers and one switch on the board. These are illustrated in *Figure 18* and explained in *Table 3* below.

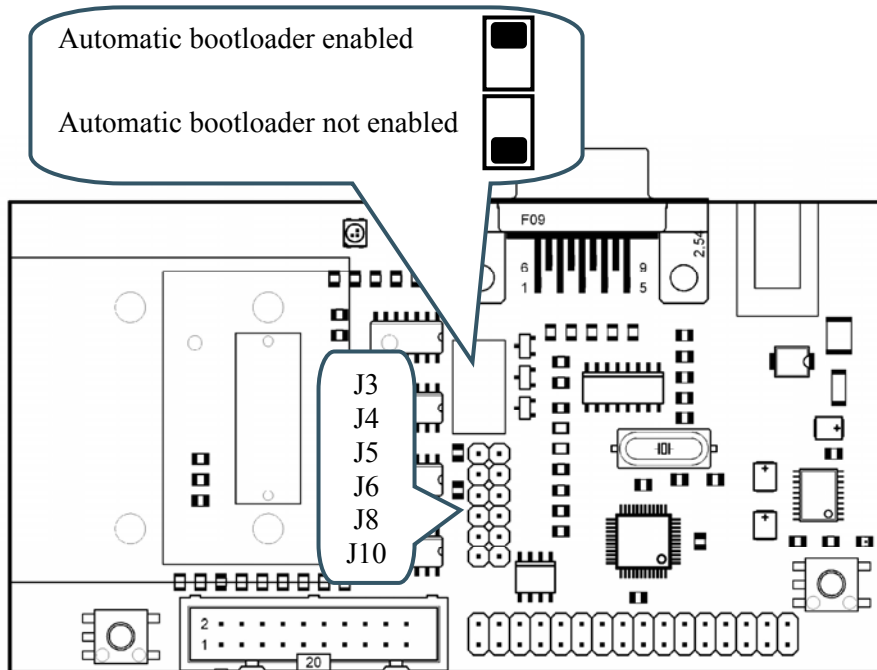

Figure 18 – Jumper Description

The table below explains the different jumpers.

### J3 – DBGSEL

Enable or disable the LPC2106 JTAG interface

Jumper shorted = Enable JTAG

Jumper open = JTAG not enabled (**default position**)

### J4 – RTCK

Some JTAG interfaces require the JTAG signal RTCK to be grounded. Please consult your JTAG interface manual for details.

Jumper shorted = JTAG signal RTCK grounded

Jumper open = JTAG signal RTCK is left untouched (**default position**)

### J5 – RTS

The application program has the option of controlling the RTS/CTS signals on the RS232 serial channel, if needed.

Jumper shorted = Pin P0.23 act as RS232-RTS signal. P0.23 must be an input.

Jumper open = Pin P0.23 is free to be used for other tasks (**default position**)

If used, signal P0.23 is the RTS signal and P0.23 must be an input.

**J6 – CTS**

The application program has the option of controlling the RTS/CTS signals on the RS232 serial channel, if needed.

If used, signal P0.22 is the CTS signal and P0.22 must be an output.

Jumper shorted = Pin P0.22 act as RS232-CTS signal. P0.22 must be an output.

Jumper open = Pin P0.22 is free to be used for other tasks (*default position*)

**J8 – Serial Channel Select**

The serial channel of the Bluetooth module can be connected either to the LPC2106 microcontroller or the RS232 serial channel.

Jumper shorted = LPC2106 communicate with Bluetooth module (*default position*)

Jumper open = Bluetooth module is connected directly to the RS232 serial channel. Use this position when connectBlue's Serial Port Adapter Wizard is used.

**J10 – Manual Bootloader**

If signal P0.14 is sampled low after reset, the internal bootloader in the LPC2106 microcontroller is activated.

Jumper shorted = Signal P0.14 grounded

Jumper open = Signal P0.14 left untouched, i.e., not pulled low (*default position*)

**SW2 – Automatic Bootloader**

By using the automatic bootloader feature, the RTS/DTR signals in the RS232 serial channel can control the reset and bootloader activation signal.

Position up = Active automatic bootloader (switch is "to" the DSUB-9 connector)

Position down = Disable the automatic bootloader (switch is "from" the DSUB-9 connector)

Table 3 – Board Jumpers and Switch

## 5.5 Board Measurements

The board is 108 x 58 mm and *Figure 19* below illustrates the mounting hole positions. The four mounting holes are 3.5 mm wide and 50 x 100 mm apart.

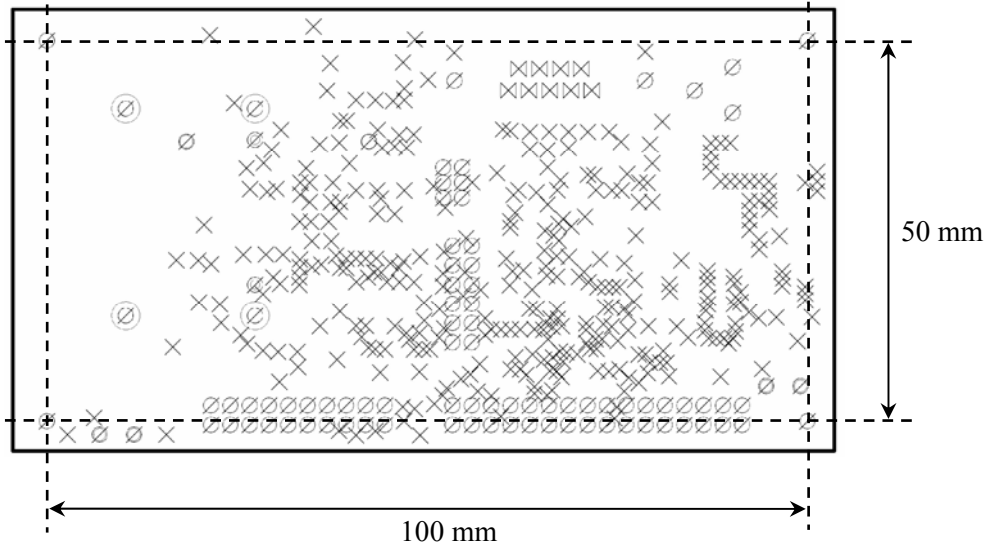

Figure 19 – Mounting Hole Positions

## 6 Further Information

The Bluetooth module from connectBlue and the LPC2106 microcontroller from Philips are complex products and there exist a number of document with a lot of information. The following documents are recommended as a complement to this document.

- [1] connectBlue Serial Port Adapter, 2nd Generation, User Manual  
[http://www.connectblue.com/files/spa2\\_documentation/cb\\_serial\\_port\\_adapter\\_gen2\\_user\\_manual\\_2\\_11.pdf](http://www.connectblue.com/files/spa2_documentation/cb_serial_port_adapter_gen2_user_manual_2_11.pdf)
- [2] connectBlue Serial Port Adapter, 2nd Generation, AT Commands  
[http://www.connectblue.com/files/spa2\\_documentation/cb\\_serial\\_port\\_adapter\\_gen2\\_at\\_commands\\_specification\\_5.pdf](http://www.connectblue.com/files/spa2_documentation/cb_serial_port_adapter_gen2_at_commands_specification_5.pdf)
- [3] connectBlue OEM Serial Port Adapter, 2nd Generation, Electrical & Mechanical Datasheet  
[http://www.connectblue.com/files/spa2\\_documentation/cb\\_oem\\_serial\\_port\\_adapter\\_gen2\\_e\\_m\\_datasheet\\_1\\_5.pdf](http://www.connectblue.com/files/spa2_documentation/cb_oem_serial_port_adapter_gen2_e_m_datasheet_1_5.pdf)
- [4] connectBlue Serial Port Adapter, 2nd Generation, Use Cases and Features 1.0  
[http://www.connectblue.com/files/spa2\\_documentation/cb\\_serial\\_port\\_adapter\\_gen2\\_application\\_scenarios\\_1\\_0.pdf](http://www.connectblue.com/files/spa2_documentation/cb_serial_port_adapter_gen2_application_scenarios_1_0.pdf)
- [5] Philips LPC2106 Datasheet  
[http://www.semiconductors.philips.com/acrobat/datasheets/LPC2104\\_2105\\_2106-05.pdf](http://www.semiconductors.philips.com/acrobat/datasheets/LPC2104_2105_2106-05.pdf)
- [6] Philips LPC2106 User's Manual  
[http://www.semiconductors.philips.com/acrobat/usermanuals/UM\\_LPC2106\\_2105\\_2104\\_1.pdf](http://www.semiconductors.philips.com/acrobat/usermanuals/UM_LPC2106_2105_2104_1.pdf)
- [7] Philips LPC2106 Errata Sheet  
<http://www.semiconductors.philips.com/acrobat/erratasheets/2106.pdf>
- [8] ARM7TDMI Technical Reference Manual. Document identity: DDI0029G  
[http://www.arm.com/pdfs/DDI0029G\\_7TDMI\\_R3\\_trm.pdf](http://www.arm.com/pdfs/DDI0029G_7TDMI_R3_trm.pdf)
- [9] ARM Architecture Reference Manual. Document identity: DDI0100E  
Book, Second Edition, edited by David Seal, Addison-Wesley: ISBN 0-201-73719-1  
Also available in PDF form on the ARM Technical Publications CD
- [10] ARM System Developer's Guide – Designing and Optimizing System Software, by A.N. Sloss, D Symes, C. Wright. Elsevier: ISBN 1-55860-874-5
- [11] Embedded System Design on a Shoestring, by Lewin Edwards.  
Newnes: ISBN 0750676094.
- [12] GNU Manuals  
<http://www.gnu.org/manual/>
- [13] GNU ARM tool chain for CygWin  
<http://www.gnuarm.com>
- [14] An Introduction to the GNU Compiler and Linker, by Bill Gatliff  
<http://www.billgatliff.com>
- [15] LPC2000 Yahoo Group. A discussion forum dedicated entirely to the Philips LPC2xxx series of microcontrollers.  
<http://groups.yahoo.com/group/lpc2000/>
- [16] Embedded Artists' Reference Documentation: Pre-Emptive Operating System  
[http://www.embeddedartists.com/download/pdf/refDoc\\_rtos.pdf](http://www.embeddedartists.com/download/pdf/refDoc_rtos.pdf)

[17] Embedded Artists' Reference Documentation: TCP/IP Protocol Stack  
[http://www.embeddedartists.com/download/pdf/refDoc\\_tcpip.pdf](http://www.embeddedartists.com/download/pdf/refDoc_tcpip.pdf)

[18] Embedded Artists' Reference Documentation: Embedded Web Server  
[http://www.embeddedartists.com/download/pdf/refDoc\\_web.pdf](http://www.embeddedartists.com/download/pdf/refDoc_web.pdf)

Especially observe document [7]. There exist a number of bugs in the processor that is important to be aware of.

Observe that there can be newer versions of the documents than the ones linked to here. Always check for the latest information / version.

## A connectBlue's Serial Port Adapter Wizard

The *Bluetooth QuickStart Board* is designed to work with connectBlue's *Serial Port Adapter Wizard* program – a program that helps you to configure the Bluetooth module for your specific needs.

Normally the Bluetooth module communicates over a serial channel with the LPC2106 microcontroller. By removing jumper J8, the serial channel of the Bluetooth module is directly connected to the serial interface of the *Bluetooth QuickStart Board*. This way, a PC application (like connectBlue's *Serial Port Adapter Wizard* program) can directly communicate with the Bluetooth module over the serial interface, and without removing the module from the *Bluetooth QuickStart Board*.

See *Figure 18* on page 25 for a description about where to find jumper J8. As written, this jumper must be removed (is normally shorted) when connectBlue's *Serial Port Adapter Wizard* program is used. Also observe that the Bootloader switch must be placed in position: "automatic bootloader not enabled".

Observe that the *Bluetooth QuickStart Kit* assumes that the Bluetooth module is configured with the following parameters:

- 115200 bps, 8N1, no hardware handshake signals
- LAN Access Server

You can change the parameters while using the *Serial Port Adapter Wizard*, but you must change the parameters back to above when using the *QuickStart library*.

## B Application Program Interface (API)

This appendix describes the *QuickStart library* API in detail. The description is divided into functional sections. Please refer to *appendix C* for sample applications that illustrate how the API can be used in practical applications.

### B.1 Preemptive Real-Time Operating System API

#### B.1.1 Error Codes

- OS\_OK (0x00) - Operation completed successfully
- OS\_ERROR\_NULL (0x01) - A NULL pointer was supplied as an argument that is not allowed to be NULL.
- OS\_ERROR\_ISR (0x02) - The operation is not allowed inside an interrupt service routine.
- OS\_ERROR\_SEM\_OVERRUN (0x03) - The semaphore cannot be given since the semaphore limit is already reached.
- OS\_ERROR\_PID (0x04) - An illegal pid was supplied to the function.
- OS\_ERROR\_ALLOCATE (0x05) - Out of process control blocks
- OS\_ERROR\_STATE (0x06) - Trying to resume a process that is not suspended.
- OS\_ERROR\_QUEUE\_FULL (0x07) - The queue is full.
- OS\_ERROR\_TIMEOUT (0x08) - The operation returned due to a timeout.
- OS\_ERROR\_PRIO (0x09) - The priority level is out of range.

#### B.1.2 osSemInit

```
void osSemInit( tCntSem* pSem, tU8 initial )
```

This function initializes a counting semaphore and must be called before any other function is used on the semaphore.

**Parameters:**

**[in]** pSem – A pointer to an allocated counting semaphore structure.

**[in]** initial – The initial counter value.

#### B.1.3 osSemTake

```
tBool osSemTake( tCntSem* pSem, tU32 timeout )
```

This function takes a counting semaphore, i.e. decreasing the semaphore counting. If the semaphore counter is zero the function will block until another process or an ISR gives the semaphore or a timeout occurs.

**Parameters:**

**[in]** pSem - A pointer to an initialized semaphore structure.

**[in]** timeout - After timeout ticks the operation will timeout. A timeout of zero means no timeout at all.

**Returns:**

TRUE if semaphore was taken and FALSE if timeout or error.

**Possible error situations (what can be identified in an error code):**

OS\_OK - The function completed successfully.  
OS\_ERROR\_ISR - The function was called from an interrupt service routine.  
OS\_ERROR\_NULL - A NULL pointer was supplied to the function where it was not allowed.

### B.1.4 osSemGive

```
void osSemGive( tCntSem* pSem )
```

This function gives a counting semaphore, i.e. increases the semaphore counter. If there are one or more processes waiting for the semaphore the process with highest priority is made ready to run.

**Parameters:**

[in] pSem - A pointer to an initialized semaphore structure.

**Possible error situations (what can be identified in an error code):**

OS\_OK - The function completed successfully.  
OS\_ERROR\_NULL - A NULL pointer was supplied to the function where it was not allowed.

### B.1.5 osSemTryTake

```
tU8 osSemTryTake( tCntSem* pSem )
```

This function tries to take a counting semaphore. If the semaphore cannot be taken the function immediately returns instead of blocking. This function can be used from an ISR (interrupt service routine).

**Parameters:**

[in] pSem - A pointer to an initialized semaphore structure.

**Returns:**

0 if the semaphore was taken, else 1.

**Possible error situations (what can be identified in an error code):**

OS\_OK - The function completed successfully.  
OS\_ERROR\_NULL - A NULL pointer was supplied to the function where it was not allowed.

### B.1.6 osSleep

```
void osSleep( tU32 ticks )
```

This function puts a process to sleep for the specified number of ticks.

**Parameters:**

[in] ticks - The number of ticks to put the process to sleep.



### B.1.7 osPid

```
tU8 osPid( void )
```

This function returns the process identification descriptor for the running process.

**Returns:**

The process identification descriptor of the currently running process.

**Possible error situations (what can be identified in an error code):**

OS\_OK - The function completed successfully.

OS\_ERROR\_ISR - The function was called from an interrupt service routine.

### B.1.8 osISREnter

```
void osISREnter( void )
```

This function is used to notify the operating system that the application has entered an interrupt service routine (ISR). This is important if the ISR is using services from the operating system, since some services need to know if they are executed from an ISR or not. The function osISRExit should be used before the ISR returns to notify the operating system about the ISR exit.

### B.1.9 osISRExit

```
void osISRExit( void )
```

This function is used to notify the operating system that the currently serviced interrupt is about to exit. The function is always used in conjunction with the function osISREnter, which should always be called before osISRExit. It is important to notify the OS about ISRs (Interrupt Service Routines) if they are using services from the operating system (since some services need to know if they are executed from an ISR or not).

### B.1.10 osDeleteProcess

```
void osDeleteProcess( void )
```

This function deletes the currently running process. The process control block used by the process will be freed and is therefore available for new processes.

### B.1.11 osCreateProcess

```
void osCreateProcess( void (*pProc)(void), tU8* pStk, tU16  
stkSize, tU8* pPid, tU8 prio )
```

This function creates a new process. The process is not automatically started. To start the process the osStartProcess function must be called. A new process can only be created if there is a free process control block available. The number of process control blocks is specified during operating system configuration (maximum number of processes).

**Parameters:**

**[in]** pProc - The process entry function.

**[in]** pStk - A pointer to the stack area to use. The stack area must be allocated before the process is created.

**[in]** stkSize - The size of the stack area in bytes.

**[out]** pPid - The returned process identification descriptor (pid).

**[in]** prio - The priority of the process. The priority is a number between 0 and NUM\_PRIO-1, where NUM\_PRIO is specified during operating system configuration (maximum number of priorities). 0 is the highest priority level and NUM\_PRIO-1 is the lowest priority level. The operating system will always run the process that has the highest priority and is ready to run, i.e. is not sleeping, suspended or waiting for synchronization primitive. If several processes are run on the same priority level they are scheduled in a round-robin fashion.

**Possible error situations (what can be identified in an error code):**

OS\_OK - The function completed successfully.

OS\_ERROR\_PRIO - The supplied priority is not correct.

OS\_ERROR\_ALLOCATE - The process could not be created since there is no free process control blocks available. The number of process control blocks is specified during operating system configuration (maximum number of processes).

### B.1.12 osStartProcess

```
void osStartProcess( tU8 pid )
```

This function is used to start a process. The process must previously have been created by a call to osCreateProcess.

**Parameters:**

**[in]** pid - The process identification descriptor (pid) of the process to start. The pid is returned by osCreateProcess.

**Possible error situations (what can be identified in an error code):**

OS\_OK - The function completed successfully.

OS\_ERROR\_PID - The supplied pid is not correct.

### B.1.13 osGetOverrunCounter

```
tU32 osGetOverrunCounter( tBool reset )
```

This function is applicable to cyclic processes. A cyclic process is said to overrun if it runs longer than the specified cycle-time. A process that overruns is restarted as soon as it returns. This function should only be called from a cyclic process.

**Parameters:**

**[in]** reset - If TRUE the overrun counter is reset after the read out, else it keeps its old value.

**Returns:**

The number of times the process has overrun.

### B.1.14 osSuspend

```
void osSuspend( void )
```

This function suspends the currently running process. Another process can resume it by a call to osResume.

### B.1.15 osResume

```
void osResume( tU8 pid )
```

This function resumes a suspended process. It is valid to do resume on a process that has not been suspended.

**Parameters:**

**[in]** pid - The process to resume.

**Possible error situations (what can be identified in an error code):**

OS\_OK - The function completed successfully.

OS\_ERROR\_PID - The supplied pid is not correct.

### B.1.16 osStackUsage

```
tU8 osStackUsage( tU8 pid )
```

This function returns the stack usage. The stack usage is based on the maximum size used so far, i.e. from the application start to the point where this function is called.

**Parameters:**

**[in]** pid - The pid of the process to check.

**Returns:**

The used fraction of the stack area specified in percent.

### B.1.17 osBinSemInit

```
void osBinSemInit( tBinSem* pSem, tBool free )
```

This function is used to initialize a binary semaphore and must be called before any other operations are called on a binary semaphore.

**Parameters:**

**[in]** pSem - A pointer to an allocated binary semaphore structure.

**[in]** free - The initial value of the binary semaphore. A binary semaphore has two states free or occupied. A free binary semaphore can be taken without blocking the process. If an occupied semaphore is taken the process has to wait until another process gives the semaphore.

### B.1.18 osBinSemTake

```
tBool osBinSemTake( tBinSem* pSem, tU32 timeout )
```

This function takes a binary semaphore. If the binary semaphore is already taken the function will block until the semaphore is given by another process or the specified timeout expires.

**Parameters:**

**[in]** pSem - A pointer to an initialized semaphore structure.

**[in]** timeout - After timeout ticks the operation will timeout. If a timeout of zero is specified the function will never timeout.

**Returns:**

TRUE if semaphore was taken and FALSE if timeout or error.

**Possible error situations (what can be identified in an error code):**

OS\_OK - The function completed successfully.

OS\_ERROR\_ISR - The function was called from an interrupt service routine.

OS\_ERROR\_NULL - A NULL pointer was supplied to the function where it was not allowed.

**B.1.19 osBinSemGive**

```
void osBinSemGive( tBinSem* pSem )
```

This function gives (releases) a binary semaphore. If another process is waiting for the semaphore it is inserted into the ready list. If more than one process is waiting for the semaphore the one with the highest priority is inserted.

**Parameters:**

**[in]** pSem - A pointer to an initialized semaphore structure.

**Possible error situations (what can be identified in an error code):**

OS\_OK - The function completed successfully.

OS\_ERROR\_SEM\_OVERRUN - The semaphore is already given.

OS\_ERROR\_NULL - A NULL pointer was supplied to the function where it was not allowed.

**B.1.20 osBinSemTryTake**

```
tU8 osBinSemTryTake( tBinSem* pSem )
```

This function tries to take a binary semaphore. If the semaphore cannot be taken the function immediately returns without blocking. This function can be used from an ISR (interrupt service routine).

**Parameters:**

**[in]** pSem - A pointer to an initialized semaphore structure.

**Returns:**

0 if the semaphore was taken, else 1.

**Possible error situations (what can be identified in an error code):**

OS\_ERROR\_NULL - A NULL pointer was supplied to the function where it was not allowed.

**B.1.21 m\_os\_ena\_int**

```
void m_os_ena_int( void )
```

This macro enables interrupts.

#### B.1.22 m\_os\_dis\_int

```
void m_os_dis_int( void )
```

This macro disables interrupts.

## B.2 TCP/IP API

### B.2.1 m\_buf\_get\_data

The macro `m_buf_get_data` is defined as:

```
#define m_buf_get_data( pBuf ) func( pBuf )
```

Where `func` is a function with the following prototype:

```
void* func( tBuf* pBuf )
```

This is a macro that retrieves a pointer to the data within the buffer. What actually happens is that the `pData` pointer in the buffer structure is returned.

**Parameters:**

**[in]** `pBuf` - buffer that contains received data.

**Returns:**

A pointer to the actual data that resides within the buffer.

### B.2.2 tcpNewTcb

```
tTcpTcb* tcpNewTcb( void )
```

This function allocates a new control block. Returns NULL if there are no more control blocks available.

**Returns:**

An allocated TCB or NULL if none available.

### B.2.3 tcpBind

```
ts8 tcpBind( tTcpTcb* pTcb, tIPAddr* pIPAddr, tU16 port )
```

Bind a TCB to a port. E.g. port 80 if the application is a web server.

**Parameters:**

**[in]** `pTcb` - an allocated TCB that will be bound to a specific port.

**[in]** `pIPAddr` – the IP address to bind to. This parameter may be set to NULL if the TCB should be bound to all interfaces.

**[in]** `port` - the port number to use or 0 (zero) if the stack should choose a port number.

**Returns:**

One of the error codes specified below.

**Possible error situations (what can be identified in an error code):**

TCP\_OK - no errors

TCP\_NULL\_POINTER - parameter `pTcb` was NULL.

TCP\_PORT\_IN\_USE - port number is already assigned to a connection.

### B.2.4 tcpListen

```
tS8 tcpListen( tTcpTcb* pTcb )
```

Set the control block in listen mode (i.e. server)

**Parameters:**

[in] pTcb - an allocated and bound TCB

**Returns:**

One of the error codes specified below.

**Possible error situations (what can be identified in an error code):**

TCP\_OK - no error

TCP\_LISTEN\_ERROR - This error is returned if the control block wasn't in CLOSED state when tcpListen was called

### B.2.5 tcpAccept

```
void tcpAccept( tTcpTcb* pTcb, void (*pAcc)(tTcpTcb* pTcb) )
```

Registers an accept callback function. When a client attempts to connect to a TCB in listen mode (a server socket) the accept callback function will be called. Supplied with this accept call is the new control block for the established connection. It is this new control block that should be used when sending and receiving data through the connection.

Limitations to the number of accepted connections have to be controlled by the application. The example below specifies how this can be done.

```
if(nbrOfConnections++ >= MAX_NBR_CONNECTIONS)
    tcpClose(pTcb);
else
    ...
```

**Parameters:**

[in] pTcb - an allocated, bound TCB in LISTEN mode.

[in] pAcc - function pointer for the accept callback.

**Parameters to (\*pAcc):**

[in] pTcb - control block for the established connection.

### B.2.6 tcpReceive

```
void tcpReceive( tTcpTcb* pTcb, void (*pRecv)(tTcpTcb* pTcb,
tBuf* pBuf, tU16 len, tS8 err) )
```

This function registers a receive callback. The callback will be called whenever there is received data on the established connection. Parameters to the callback function are the control block for the connection, a pointer to the buffer containing the data, length of the data and an error code.

**Parameters:**

[in] pTcb - a control block for an established connection.

[in] pRecv - function pointer to the receive callback.

**Parameters to (\*pRecv):**

**[in]** pTcb - control block for the connection.

**[in]** pBuf - pointer to the buffer containing data. A pointer to the actual data can be retrieved by using the `m_buf_get_data` function.

**[in]** len - length of data in bytes.

**[in]** err - TCP\_OK, TCP\_REMOTE\_CLOSE, TCP\_ERROR.

**B.2.7 tcpBufProcessed**

```
void tcpBufProcessed( tTcpTcb* pTcb, tBuf* pBuf )
```

This function must be called when received data has been processed. If this function is not called the received buffer will not be de-allocated and the TCP receive window will never increase (sliding window protocol), i.e. in the end no more data will be sent to the receiving host.

NOTE: It is assumed that the data is processed in the same order as it is received.

**Parameters:**

**[in]** pTcb - control block for an established connection

**[in]** pBuf - processed buffer

**B.2.8 tcpConnect**

```
void tcpConnect( tTcpTcb* pTcb, tU8* pDestIP, tU16 destPort,
void (*pConn)(tTcpTcb* pTcb, tS8 err) )
```

This function tries to connect to a remote host. A callback function is register with this call. When the connect attempt succeeds the callback function will be called.

**Parameters:**

**[in]** pTcb - an allocated and bound control block.

**[in]** pDestIP - destination IP address, e.g. {192, 168, 0, 45}.

**[in]** destPort - destination port number.

**[in]** pConn - function pointer to the connect callback. This function will be called when the connect attempt succeeds. Supplied with this call is a control block for the established connection and an error code.

**Parameters to (\*pConn):**

**[in]** pTcb - control block for the connection.

**[in]** err - error code (TCP\_OK or TCP\_CONN\_REFUSED)

**B.2.9 tcpSend**

```
tS8 tcpSend( tTcpTcb* pTcb, tU8* pData, tU32 len )
```

This function sends data through an established connection. A callback function has to be registered if the application needs to know when the data has been sent and acknowledged, i.e. when the sent data can be de-allocated. This callback is registered via a call to `tcpRegSentCallb`.



**Parameters:**

- [in] pTcb - control block for an established connection.
- [in] pData - data to send
- [in] len - length of data

**Returns:**

One of the following error codes:

**Possible error situations (what can be identified in an error code):**

- TCP\_OK - no errors
- TCP\_NULL\_POINTER - pTcb or pData is NULL.
- TCP\_NOT\_CONNECTED - connection is not established.
- TCP\_OUT\_OF\_BUF - the stack is out of buffers.
- TCP\_LEN\_ZERO - the specified length parameter is zero.

**B.2.10 tcpRegSentCallb**

```
void tcpRegSentCallb( tTcpTcb* pTcb, void (*pSent)(tTcpTcb*
pTcb, void* p) )
```

Registers a callback function that will be called when sent data has been acknowledged. It is now safe to deallocate the sent data if it was dynamically allocated. Supplied with the callback is the control block for the connection through which the data was sent and a pointer to the sent data. This is the same pointer as was supplied with the tcpSend call (pData).

**Parameters:**

- [in] pTcb - an allocated control block
- [in] pSent - function pointer to the sent callback

**Parameters to (\*pSent):**

- [in] pTcb - the control block
- [in] p - pointer to the data that was supplied with the send call.

**B.2.11 tcpClose**

```
void tcpClose( tTcpTcb* pTcb )
```

Close down a connection. If it is an established connection that is closed, the control block will not be de-allocated immediately. According to the TCP protocol it can take up several minutes.

**Parameters:**

- [in] pTcb - control block for the connection to close.

**B.2.12 udpNewTcb**

```
tUdpTcb* udpNewTcb( void )
```

This function allocates a new control block. Returns NULL if there are no more control blocks available.

**Returns:**

An allocated TCB or NULL if none available.

### B.2.13 udpBind

```
tS8 udpBind( tUdpTcb* pTcb, tIPAddr* pIPAddr, tU16 port )
```

Bind a TCB to a port.

**Parameters:**

**[in]** pTcb - an allocated TCB that will be bound to a specific port.

**[in]** pIPAddr – the IP address to bind to. This parameter may be set to NULL if the TCB should be bound to all interfaces.

**[in]** port - the port number to use or 0 (zero) if the stack should choose a port number.

**Returns:**

One of the following error codes:

**Possible error situations (what can be identified in an error code):**

UDP\_OK - no errors

UDP\_NULL\_POINTER - parameter pTcb was NULL.

UDP\_PORT\_IN\_USE - port number is already assigned to a connection.

### B.2.14 udpReceive

```
void udpReceive( tUdpTcb* pTcb, void (*pRecv)(tUdpTcb* pTcb, tBuf* pBuf, tU16 len) )
```

This function registers a receive callback. The callback will be called whenever there is data to receive on the connection. Parameters to the callback function are the control block for the connection, a pointer to the buffer containing the data and length of the data.

**Parameters:**

**[in]** pTcb - a bound control block

**[in]** pRecv - function pointer to the receive callback.

**Parameters to (\*pRecv):**

**[in]** pTcb - control block for the connection.

**[in]** pBuf - pointer to the buffer containing data. A pointer to the actual data can be retrieved by using the m\_buf\_get\_data macro.

**[in]** len - length of data in bytes.

### B.2.15 udpBufProcessed

```
void udpBufProcessed( tUdpTcb* pTcb, tBuf* pBuf )
```

This function must be called when received data has been processed. If this function is not called the received buffer will not be de-allocated.

**Parameters:**

[in] pTcb - control block for an established connection.

[in] pBuf - processed buffer.

## B.2.16 udpSend

```
tS8 udpSend( tUdpTcb* pTcb, tIPAddr* pDestIP, tU16 destPort,  
tU8* pData, tU16 len, void (*pBufSent)(void* pData) )
```

This function sends data through a connection.

A callback function (pBufSent) must be registered if the application needs to know when the data has been sent from the stack, i.e. when the sent data can be deallocated.

**Parameters:**

[in] pTcb - bound control block for the connection.

[in] pDestIP - destination IP address.

[in] destPort - destination port number

[in] pData - data to send

[in] len - length of data

[in] pBufSent - function pointer to a buffer sent callback. Supplied with the callback is a pointer to the sent data. This callback will be called when the data has been sent from the stack. It will then be safe to de-allocate any allocated memory.

**Parameters to (\*pBufSent):**

[in] pData - Pointer to data supplied with the send call.

**Returns:**

One of the following error codes:

**Possible error situations (what can be identified in an error code):**

UDP\_OK - no errors

UDP\_OUT\_OF\_BUF - out of buffers

## B.2.17 udpClose

```
void udpClose( tUdpTcb* pTcb )
```

Close down a connection. The control block is de-allocated in this function.

**Parameters:**

[in] pTcb - control block for the connection.

## B.3 Web Server API

### B.3.1 m\_get\_request\_method

The macro `m_get_request_method` is defined as:

```
#define m_get_request_method( pConn ) func( pConn )
```

Where `func` is a function with the following prototype:

```
tU8* func( tConnect* pConn )
```

Get the request method (e.g. "GET") for a specific connection and request.

**Parameters:**

[in] `pConn` - control block for the connection.

**Returns:**

The request method or NULL if none available.

### B.3.2 m\_get\_server\_protocol

The macro `m_get_server_protocol` is defined as:

```
#define m_get_server_protocol( pConn ) func( pConn )
```

Where `func` is a function with the following prototype:

```
tU8* func( tConnect* pConn )
```

Get the server protocol (e.g. "HTTP/1.0") used for a specific connection and request.

**Parameters:**

[in] `pConn` - control block for the connection.

**Returns:**

The server protocol or NULL if none available.

### B.3.3 m\_get\_document\_uri

The macro `m_get_document_uri` is defined as:

```
#define m_get_document_uri( pConn ) func( pConn )
```

Where `func` is a function with the following prototype:

```
tU8* func( tConnect* pConn )
```

Get the document URI (e.g. "/page.html") for a specific connection and request.

**Parameters:**

[in] `pConn` - control block for the connection.

**Returns:**

The document URI or NULL if none available.

### B.3.4 m\_get\_query\_string

The macro `m_get_query_string` is defined as:

```
#define m_get_query_string( pConn ) func( pConn )
```

Where `func` is a function with the following prototype:

```
tU8* func( tConnect* pConn )
```

Get the query string (e.g. "x=10&y=34") for a specific connection and request.

**Parameters:**

[in] `pConn` - control block for the connection.

**Returns:**

The query string or NULL if none available.

### B.3.5 `m_conn_isused`

The macro `m_conn_isused` is defined as:

```
#define m_conn_isused( pConn ) func( pConn )
```

Where `func` is a function with the following prototype:

```
tU8* func( tConnect* pConn )
```

Check if a control block is in use or not.

**Parameters:**

[in] `pConn` - control block for the connection.

**Returns:**

TRUE if the connection is used; otherwise FALSE.

### B.3.6 `m_get_content_length`

The macro `m_get_content_length` is defined as:

```
#define m_get_content_length( pConn ) func( pConn )
```

Where `func` is a function with the following prototype:

```
tU8* func( tConnect* pConn )
```

Get the content length header from a specific connection and request.

**Parameters:**

[in] `pConn` - control block for the connection.

**Returns:**

The content length or NULL if none available.

### B.3.7 `m_get_egi_state`

The macro `m_get_egi_state` is defined as:

```
#define m_get_egi_state( pConn ) func( pConn )
```

Where `func` is a function with the following prototype:

```
tU8* func( tConnect* pConn )
```

Get the egi state. This variable is not manipulated by the Web Server, but can be used to implement a state machine in an EGI function.

**Parameters:**

[in] pConn - control block for the connection.

**Returns:**

The EGI state.

### B.3.8 m\_set\_egi\_state

The macro `m_set_egi_state` is defined as:

```
#define m_set_egi_state( pConn ) func( pConn )
```

Where `func` is a function with the following prototype:

```
void func( tConnect* pConn )
```

Set the `egi` state. This variable is not manipulated by the Web Server, but can be used to implement a state machine in an EGI function.

**Parameters:**

[in] pConn - control block for the connection.

### B.3.9 comPrintString

```
tBool comPrintString( tConnect* pConn, tU8* pStr )
```

Print a string to the output buffer.

**Parameters:**

[in] pConn - Control block for the connection.

[in] pStr - The string to print

**Returns:**

TRUE if the string was copied to the output buffer; otherwise FALSE.

### B.3.10 comPrintUInt

```
tBool comPrintUInt( tConnect* pConn, tU32 intVal, tBool hex )
```

Print an unsigned integer to the output buffer

**Parameters:**

[in] pConn - Control block for the connection.

[in] intVal - Integer to print

[in] hex - TRUE if the integer value should be printed as a hexadecimal value.

**Returns:**

TRUE if the string version of the integer was copied to the output buffer; otherwise FALSE.

### B.3.11 comPrintSInt

```
tBool comPrintSInt( tConnect* pConn, tS32 intVal )
```

Print a signed integer to the output buffer.

**Parameters:**

[in] pConn - Control block for the connection.

[in] intVal - Integer value to print.

**Returns:**

TRUE if the string version of the integer could be copied to the output buffer; otherwise FALSE.

### B.3.12 comPrintChar

```
tBool comPrintChar( tConnect* pConn, tU8 ch )
```

Print a character to the output buffer.

**Parameters:**

[in] pConn - Control block for the connection.

[in] ch - The character to print.

**Returns:**

TRUE if the character could be copied to the output buffer; otherwise FALSE.

### B.3.13 comWrite

```
tU16 comWrite( tConnect* pConn, tU8* pData, tU16 dataLen )
```

Write data to the output buffer. This function will return the number of bytes that could be sent.

**Parameters:**

[in] pConn - Control block for the connection.

[in] pData - Data to send.

[in] dataLen - Length of the data to send.

**Returns:**

Number of bytes that were written

### B.3.14 comHeader

```
tBool comHeader( tConnect* pConn, tU8* pHeaderStr, tU8*  
pValue, tU32 value )
```

Function to use for sending headers to an open client connection, i.e. as a response to a client request.

**Parameters:**

[in] pConn - Control block for the connection.

[in] pHeaderStr - Either both header and value or just header. If the entire header is specified in this string it must end with "\r\n", i.e. CRLF. If only the header is specified in this string it must end with ": ", i.e. a colon and a space.

[in] pValue - A string header value or NULL.

[in] value - An integer header value. This parameter is only used when pHeaderStr does not end with CRLF and pValue == NULL.

**Returns:**

TRUE if the headers was sent; otherwise FALSE

### B.3.15 comEndHeaders

```
void comEndHeaders( tConnect* pConn )
```

End the headers section of a response to the client. This function must be called in order to end the headers section correctly. When this function has been called it is no longer possible to add more headers to the response via the comHeader function.

**Parameters:**

[in] pConn - Control block for the connection.

### B.3.16 comRead

```
tU16 comRead( tConnect* pConn, tU8* pBuf, tU16 len )
```

Copy data from a client socket into a user-provided buffer. This function may be useful if the client has sent a POST request and attached a message body.

**Parameters:**

[in] pConn - Control block for the connection.

[out] pBuf - Output buffer (data will be copied here)

[in] len - Length of output buffer.

**Returns:**

Number of read bytes.

### B.3.17 httpGet

```
void httpGet( tConnect* pConn, tU8* pURI )
```

Handle a HTTP GET request. This function will translate the resource name, pointed to by pURI into the name of a file, which will be sent to the client.

**Parameters:**

[in] pConn - Control block for the connection.

[in] pURI - The requested resource.

### B.3.18 registerEGI

```
tBool registerEGI( tU8* pPath, tU8 (*pHandler)(tConnect* pConn) )
```

Register an EGI function, which may be invoked by client requests. This function should only be called after webInit has been called. Since all EGI functions are called with a NULL pointer during initialization, they must be prepared to handle this case. EGI functions should send the appropriate HTTP headers and may return either EGI\_DONE, EGI\_ERROR or EGI\_SUSPEND.



**Parameters:**

**[in]** pPath - The directory path to the command hook.

**[in]** pHandler - The EGI function.

**Parameters to (\*pHandler):**

**[in]** pConn - Control block for the connection.

**Return value of (\*pHandler):**

EGI\_DONE, EGI\_ERROR or EGI\_SUSPEND.

**Returns:**

TRUE if the function could be registered properly; otherwise FALSE.

**B.3.19 symLocal**

```
tSymTable* symLocal( tConnect* pConn )
```

Return a handle to the local symbol table. Local symbols are stored for each active client connection and usually contains only connection-specific information, such as the content length of posted data or a reference to the query string may be attached to the requested URI.

**Parameters:**

**[in]** pConn - Control block for the connection.

**Returns:**

A reference to the local symbol table.

**B.3.20 symDecl**

```
tBool symDecl( tSymTable* pTable, tU8* pName, void
(*pFreeName)(void* pName), void* pAddr, void
(*pFreeAddr)(void* pAddr), void (*pAccess)(tU8* pName, void*
pAddr), tSymType type )
```

Declare a named variable. Name and address of data is passed by reference and are NOT being copied by this function. This means that references to automatic variables should not be used. The declared variable may later be looked up by referring to the given name.

**Parameters:**

**[in]** pTable - The symbol table.

**[in]** pName - The variable name to use.

**[in]** pFreeName - Function to release memory occupied by the name. This parameter may be NULL if the name does not need to be released.

**[in]** pAddr - The address to the variable.

**[in]** pFreeAddr - Function to release memory occupied by the variable. This parameter may be NULL if the variable does not need to be released.

**[in]** pAccess - Function that will be called just before this variable is read (via the symGet function). This parameter may be NULL.

**[in]** type - The type of this variable.

**Parameters to (\*pFreeName):**

[in] pName - Memory to release.

**Parameters to (\*pFreeAddr):**

[in] pAddr - Memory to release.

**Parameters to (\*pAccess):**

[in] pName - Name of the variable

[in] pAddr - Address of the variable.

**Returns:**

TRUE if the variable could be allocated. The parameters will be de-allocated if allocation failed and de-allocation routines are defined.

### B.3.21 symGet

```
tBool symGet( tSymTable* pTable, tU8* pName, void* ppAddr,
tSymType* pType )
```

Get a variable registered in the symbol table.

**Parameters:**

[in] pTable - The symbol table

[in] pName - Name of the variable to get.

[out] ppAddr - Address of variable data (pointer to pointer).

[in] pType - Type of this variable.

**Returns:**

TRUE if the variable could be found. FALSE otherwise.

### B.3.22 symRemove

```
tBool symRemove( tSymTable* pTable, tU8* pSym )
```

Remove a named symbol

**Parameters:**

[in] pTable - The symbol table to use.

[in] pSym - The symbol name.

**Returns:**

TRUE if the symbol could be removed; otherwise FALSE.

### B.3.23 symFirst

```
tBool symFirst( tSymTable* pTable, tU8** ppSym, void* ppAddr,
tSymType* pType, tSymState* pState )
```

Get the first symbol in a symbol table.

**Parameters:**

[in] pTable - The symbol table to use.

**[out]** ppSym - The symbol name.

**[out]** ppAddr - The address of the symbol value (pointer to pointer).

**[out]** pType - The type of the symbol

**[out]** pState - The current state identifier.

**Returns:**

TRUE if there was a symbol in the table; otherwise FALSE.

### B.3.24 symNext

```
tBool symNext( tU8** ppSym, void* ppAddr, tSymType* pType,  
tSymState* pState )
```

Get the next symbol in a symbol table.

**Parameters:**

**[out]** ppSym - The symbol name

**[out]** ppAddr - The address of the symbol value (pointer to pointer).

**[in]** pType - The type of the symbol.

**[in]** pState - The current state identifier.

**Returns:**

TRUE if there was a symbol in the table; otherwise FALSE.

### B.3.25 symSend

```
tBool symSend( tConnect* pConn, tSymTable* pTable, tU8* pSym,  
tBool* pSent )
```

Send the text representation of the symbol value to a client.

**Parameters:**

**[in]** pConn - Control block for the connection.

**[in]** pTable - Symbol table to use.

**[in]** pSym - The name of the symbol to send

**[out]** pSent - TRUE if the symbol was sent; otherwise FALSE.

**Returns:**

TRUE if the symbol could be found; otherwise FALSE.

## B.4 File System API

### B.4.1 fatOpen

```
tFatResult fatOpen( const tU8* pPath, const tU8* pMode,
tFatHandle* pHandle )
```

This function attempts to open the file with the specified absolute path. If successful, the pHandle will hold the handle to the opened file. Note that pHandle must only be used if FAT\_OK is returned.

#### Parameters:

- [in]** pPath - The absolute path of the file to open.
- [in]** pMode - Specifies how the file will be used:
  - "r" = Read only
  - "w" = Write only, existing file will be cleared
  - "a" = Write only, new data will be appended to existing
  - "r+" = Read and Write, new data will be appended to existing
  - "w+" = Same as "r+"
  - "a+" = Same as "r+"
- [out]** pHandle - A handle to the file.

#### Returns:

FAT\_OK if the file was opened, otherwise one of the error codes

#### Possible error situations (what can be identified in an error code):

- FAT\_OK - The function completed successfully.
- FAT\_ERROR\_A\_FOLDER - If pPath points to a folder and not a file
- FAT\_ERROR\_TOO\_MANY\_OPEN - No more free handles
- FAT\_ERROR\_INV\_MODE - Not a valid pMode
- FAT\_ERROR\_READ\_ONLY - If mode is 'w' or 'a' and writing is not allowed by m\_fat\_media\_allow\_write()
- FAT\_ERROR\_FS\_NOT\_INITIALIZED - The fatInit() function has not been called

### B.4.2 fatFileSize

```
tFatResult fatFileSize( const tFatHandle handle, tU32* pSize )
```

Returns the size of the specified file.

#### Parameters:

- [in]** handle – A handle to the file.
- [out]** pSize – The size of the file.

#### Returns:

FAT\_OK if the file size could be determined, otherwise an error code

#### Possible error situations (what can be identified in an error code):

- FAT\_OK - The function completed successfully.
- FAT\_ERROR\_A\_FOLDER - The handle points to a folder, not a file
- FAT\_ERROR\_INV\_HAND - The handle is invalid

### B.4.3 fatIsDir

```
tFatResult fatIsDir( const tFatHandle handle, tBool* pIsDir )
```

Tests if the specified handle represents a file or folder.

**Parameters:**

**[in]** handle – A handle to the file.

**[out]** pIsDir – TRUE if the entry is a directory, otherwise FALSE

**Returns:**

FAT\_OK if the test could be determined, otherwise an error code

**Possible error situations (what can be identified in an error code):**

FAT\_OK - The function completed successfully.

FAT\_ERROR\_INV\_HAND - The handle is invalid

### B.4.4 fatRead

```
tFatResult fatRead( const tFatHandle handle, tU32 size, tU8*
pBuf, tU32 pNumRead )
```

This function attempts to read up to size bytes from the file pointed to by the pFile handle. The offset from where the bytes will be read is specified in the handle and the offset will be updated with the number of bytes that are read. The number of bytes actually read may be smaller than the wanted number for a number of reasons, e.g., if the end of file is reached, or the block size used by the device driver is smaller than the requested size.

**Parameters:**

**[in]** handle – A handle to the file.

**[in]** size – The number of bytes to read

**[in/out]** pBuf – The buffer to store read data in

**[out]** pNumRead – The number of bytes that were actually read

**Returns:**

FAT\_OK if at least one byte could be read, otherwise an error code

**Possible error situations (what can be identified in an error code):**

FAT\_OK - The function completed successfully.

FAT\_ERROR\_INV\_HAND - The handle is invalid

FAT\_ERROR\_A\_FOLDER - The handle points to a folder, not a file

FAT\_ERROR\_EOF - File position was EOF before the call to fatRead

FAT\_ERROR\_READ - Read from media failed

### B.4.5 fatWrite

```
tFatResult fatWrite( const tFatHandle handle, tU8* pBuf, tU32
size )
```

This function attempts to write size bytes to the file pointed to by the handle. The offset to where the bytes will be written is specified in the handle and the offset will be updated with the number of bytes that are written.

**Parameters:**

- [in] handle – A handle to the file.
- [in] pBuf – The buffer with the data to write
- [in] size – The number of bytes to write

**Returns:**

FAT\_OK if exactly size bytes were written, otherwise an error code

**Possible error situations (what can be identified in an error code):**

- FAT\_OK - The function completed successfully.
- FAT\_ERROR\_INV\_HAND - The handle is invalid
- FAT\_ERROR\_A\_FOLDER - The handle points to a folder, not a file
- FAT\_ERROR\_WRITE - Writing to the media failed
- FAT\_ERROR\_READ\_ONLY - If m\_fat\_media\_allow\_write() does not allow write operations

#### B.4.6 fatClose

```
tFatResult fatClose( tFatHandle* pHandle )
```

This function closes the specified file/folder and releases all used resources. The actual structure must be freed by the caller.

**Parameters:**

- [in/out] pHandle – A handle to the file or folder to close

**Returns:**

FAT\_OK if the file/folder could be closed, otherwise an error code

**Possible error situations (what can be identified in an error code):**

- FAT\_OK - The function completed successfully.
- FAT\_ERROR\_INV\_HAND - The handle is invalid

#### B.4.7 fatRemoveFile

```
tFatResult fatRemoveFile( const tU8* pPath )
```

This function deletes the specified file.

**Parameters:**

- [in] pPath – An absolute path to the file to remove.

**Returns:**

FAT\_OK if the file existed and was removed, otherwise an error code

**Possible error situations (what can be identified in an error code):**

- FAT\_OK - The function completed successfully.
- FAT\_ERROR\_NOT\_EXIST – The file did not exist

FAT\_ERROR\_A\_FOLDER – The path points to a folder and not a file  
 FAT\_ERROR\_FS\_NOT\_INITIALIZED – The file system has not been initialized  
 FAT\_ERROR\_READ\_ONLY – The file system is read-only

#### B.4.8 fatReadDirEntry

```
tFatResult fatReadDirEntry( const tFatHandle handle,
tFatDirEntry* pFatDirEntry )
```

This function opens the next entry in the specified folder. The pDir parameter will be updated. The pFatDirEntry structure will be filled with information about the new entry. This function will skip past the "." and ".." directory entries.

##### Parameters:

[in] handle – A handle to the folder to look in  
 [in/out] pFatDirEntry – A pointer to a pre-allocated structure

##### Returns:

FAT\_OK if a new entry was found, otherwise an error code

##### Possible error situations (what can be identified in an error code):

FAT\_OK - The function completed successfully.  
 FAT\_ERROR\_INV\_HAND – The handle is invalid

#### B.4.9 fatGetEntryIsDir

```
tFatResult fatGetEntryIsDir( tFatDirEntry* pFatDirEntry,
tBool* pIsDir )
```

Tests whether the specified entry is a file or folder.

##### Parameters:

[in] pFatDirEntry – The entry to test  
 [out] pIsDir – TRUE if the entry is a folder, FALSE if it is a file.

##### Returns:

FAT\_OK if a entry was valid, otherwise an error code

##### Possible error situations (what can be identified in an error code):

FAT\_OK - The function completed successfully.

#### B.4.10 fatGetEntrySize

```
tFatResult fatGetEntrySize( tFatDirEntry* pFatDirEntry, tU32*
pSize )
```

Returns the size of the specified file.

##### Parameters:

[in] pFatDirEntry – The entry pointing to a file  
 [out] pSize – The size of the file

##### Returns:

FAT\_OK if a entry was valid, otherwise an error code

**Possible error situations (what can be identified in an error code):**

FAT\_OK - The function completed successfully.

FAT\_ERROR\_A\_FOLDER – The entry did not point to a file.

**B.4.11 fatGetEntryName**

```
tFatResult fatGetEntryName( tFatDirEntry* pFatDirEntry, tU8**
ppFilename )
```

Returns the name of the specified entry. The name will be encoded in Unicode (two bytes per character).

Note: The returned ppFilename must NOT be modified or freed.

**Parameters:**

**[in]** pFatDirEntry – The entry to extract the name from

**[out]** ppFilename – Will contain the filename

**Returns:**

FAT\_OK if a entry was valid, otherwise an error code

**Possible error situations (what can be identified in an error code):**

FAT\_OK - The function completed successfully.

**B.4.12 fatCreateDir**

```
tFatResult fatCreateDir( const tU8* pPath )
```

This function creates a new directory with the specified absolute path. This operation can fail for a number of reasons. E.g. if a file or folder with that name already exists.

**Parameters:**

**[in]** pPath – An absolute path to the new directory.

**Returns:**

FAT\_OK the directory was created, otherwise an error code

**Possible error situations (what can be identified in an error code):**

FAT\_OK - The function completed successfully.

FAT\_ERROR\_EXISTS - There is already a folder matching the pPath

FAT\_ERROR\_A\_FILE - There is a file matching the pPath

FAT\_ERROR\_FS\_NOT\_INITIALIZED – The file system has not been initialized.

FAT\_ERROR\_READ\_ONLY - The file system is read-only

**B.4.13 fatDeleteDir**

```
tFatResult fatDeleteDir( const tU8* pPath )
```

This function deletes the specified directory if and only if it is empty.

**Parameters:**

**[in]** pPath – An absolute path to the directory to remove.

**Returns:**

FAT\_OK the directory was removed, otherwise an error code



**Possible error situations (what can be identified in an error code):**

FAT\_OK - The function completed successfully.

FAT\_ERROR\_NOT\_EXISTS - There is no folder matching the pPath

FAT\_ERROR\_A\_FILE - There is a file matching the pPath

FAT\_ERROR\_FS\_NOT\_INITIALIZED - The file system has not been initialized.

FAT\_ERROR\_READ\_ONLY - The file system is read-only

## B.5 PPP API

### B.5.1 Link Layer (with script engine)

The link layer is used between PPP and the hardware device driver (e.g. a UART). This layer includes a script engine that can be used to control the link. Command strings (init, start and close) are assigned to the link. These strings are then parsed and executed at different times in the PPP state machine.

A command in a command string always begins with the character '@' followed by a command character. The following commands can be used in a command string:

- @r TIME STRING@ - wait maximum TIME milliseconds for the string STRING. If TIME is omitted or set to 0 this is the same as wait forever. This command ends with the character '@'.
- @w TIME - wait TIME milliseconds
- @@ - send the character '@'

To send control characters in a string the character '^' is used before the character representing the control character. ^A is the same as 0x01, ^B is the same as 0x02 and so on.

A CR is ^M and a LF is ^J.

Examples:

1. @rCLIENT@CLIENTSERVER
2. @w1000CLIENTw300CLIENT@r1000CLIENTSERVER
3. @w5000atdt020123456^M^J@rCONNECT@

- 1) Wait forever for the string CLIENT and when it is received send CLIENTSERVER
- 2) Wait 1 second (1000 ms) and then send the string CLIENT. Wait another 300 ms and then send CLIENT again. Wait maximum 1 second to receive the string CLIENTSERVER. If the the string CLIENTSERVER is not received within 1 second the command string will be re-executed.
- 3) Wait 5 seconds and then send atdt020123456CRLF and then wait forever for the string CONNECT.

### B.5.2 linkSetInit

```
void linkSetInit( tPppDev* pDev, tU8* pInitStr )
```

Assign the init command string to the device. This command string is executed only when the 'linkInit' function is called. The linkInit function is never called directly by PPP, it must be called from the application code if the init command string must be executed.

#### Parameters:

- [in]** pDev - device structure
- [in]** pInitStr - init command string

### B.5.3 linkSetStart

```
void linkSetStart( tPppDev* pDev, tU8* pStartStr )
```

Assign the start command string to the device. This command string will be executed when the 'linkStart' function is called. The 'linkStart' function will be called from LCP when the this-layer-started event is triggered in LCP.

**Parameters:**

[in] pDev - device structure

[in] pStartStr - start command string

#### B.5.4 linkSetClose

```
void linkSetClose( tPppDev* pDev, tU8* pCloseStr )
```

Assign the close command string to the device. This command string will be executed when the 'linkClose' function is called. The 'linkClose' function will be called from LCP when the this-layer-finished event is triggered in LCP.

**Parameters:**

[in] pDev - device structure

[in] pCloseStr - close command string

#### B.5.5 linkInit

```
tBool linkInit( tPppDev* pDev )
```

Execute the init command string. If the init command string contains timeouts (@w or @r) this function will return before the command string has been completely processed.

**Parameters:**

[in] pDev - device structure

**Returns:**

TRUE if the processing started; FALSE if a command string is already being processed.

#### B.5.6 linkStart

```
tBool linkStart( tPppDev* pDev )
```

Execute the start command string. If the start command string contains timeouts (@w or @r) this function will return before the command string has been completely processed. This function will be called by LCP when the this-layer-started event is triggered in LCP.

**Parameters:**

[in] pDev - device structure

**Returns:**

TRUE if the processing started; FALSE if a command string is already being processed.

#### B.5.7 linkClose

```
tBool linkClose( tPppDev* pDev )
```

Execute the close command string. If the close command string contains timeouts (@w or @r) this function will return before the command string has been completely processed. This function will be called by LCP when the this-layer-finished event is triggered in LCP.

**Parameters:**

[in] pDev - device structure

**Returns:**

TRUE if the processing started; FALSE if a command string is already being processed.

### B.5.8 linkDisconnect

```
void linkDisconnect( tPppDev* pDev )
```

This function should be called when the link is disconnected. The LCP layer will be notified about the disconnection.

**Parameters:**

[in] pDev - device structure

### B.5.9 pppLocalUser

```
void pppLocalUser( tPppDev* pDev, tU8* pUser, tU8* pPass )
```

Register a local user/password. Only one user can be registered per PPP connection. This user/password information is used if we need to authenticate ourself when connecting to a peer.

**Parameters:**

[in] pDev - device structure. Contains the PPP control block.

[in] pUser - null-terminated string specifying a user ID.

[in] pPass - null-terminated string specifying a user password.

### B.5.10 pppRemoteUser

```
tBool pppRemoteUser( tU8* pUser, tU8* pPass )
```

Register a remote user/password. More than one user/password may be registered. This function returns FALSE if no more users can be registered. Registered users will be used when a peer tries to authenticate itself.

**Parameters:**

[in] pUser - null-terminated string specifying a user ID.

[in] pPass - null-terminated string specifying a user password.

**Returns:**

TRUE if the user was registered; FALSE if no more users can be registered. Maximum number of users are specified by MAX\_NUM\_USERS.

### B.5.11 pppReqAuth

```
void pppReqAuth( tPppDev* pDev, tBool on )
```

Enable/disable request authentication. It is disabled by default. A request for authentication is normally done by a server. A client must send a valid user ID and password in order for PPP to establish a connection. The function 'pppRemoteUser' is used to register user IDs and passwords that clients can use to authenticate themselves.

**Parameters:**

**[in]** pDev - device structure

**[in]** on - TRUE if authentication should be requested; otherwise FALSE.

### B.5.12 pppOpen

```
pppOpen( tPppDev* pDev, tBool restart )
```

Open/start PPP. If all layers (IPCP, PAP, LCP) are in the INITIAL state, i.e. open has not been called before or PPP has been completely closed down, the start command string for the link will be parsed and executed. The start command string is specified and assigned to a PPP device by calling the 'linkSetStart' function.

**Parameters:**

**[in]** pDev - device structure

**[in]** restart - set this to TRUE if PPP should automatically restart itself if it was closed down due to failed peer authentication. If we request authentication from a peer but the peer fails in authenticating itself, PPP will be closed down. If restart is set to TRUE, PPP will restart after PPP\_RESTART\_TO ms by first calling pppClose and then pppOpen.

### B.5.13 pppClose

```
void pppClose( tPppDev* pDev )
```

Close PPP. All layers will be closed down, terminate-request will be sent and the close command string for the link will be parsed and executed. The close command string is specified and assigned to a PPP device by calling the 'linkSetClose' function.

**Parameters:**

**[in]** pDev - device structure

## B.6 UART API

### B.6.1 uartPppBlock

```
void uartPppBlock( void )
```

This function will block PPP from accessing the UART connected to the Bluetooth module. Before PPP is blocked pppClose will be called.

The default behaviour is to have PPP monitoring the UART, connected to the Bluetooth module, in order to receive data from the Bluetooth link.

### B.6.2 uartPppUnblock

```
void uartPppUnblock( void )
```

This function will allow PPP to access the UART connected to the Bluetooth module again. If uartPppBlock has not been called this function will have no effect.

Note: you have to call pppOpen after this function has been called in order to have PPP open/connect.

### B.6.3 uartReadByte

```
tBool uartReadByte( tU8* pCh )
```

Read a byte of data from the UART connected to the Bluetooth module. This function must not be called before PPP has been blocked out of access to the UART. PPP is blocked out by calling the uartPppBlock function.

**Parameters:**

**[out]** pCh – the read byte is stored here (if there were data to read)

**Returns:**

TRUE if there was data to read; otherwise FALSE

### B.6.4 uartSendByte

```
void uartSendByte( tU8 ch )
```

Write a byte of data to the UART connected to the Bluetooth module. This function must not be called before PPP has been blocked out of access to the UART. PPP is blocked out by calling the uartPppBlock function.

**Parameters:**

**[in]** ch – the data to send to the UART

## B.7 Registry API

### B.7.1 regErase

```
void regErase( void )
```

Erase the entire registry.

### B.7.2 regSetValue

```
tRegResult regSetValue( tU8* pKey, tU8 keyLen, tU8* pValue,  
tU16 valueLen )
```

Set a value in the registry. This function is used when a new value is added to the registry or when an old value is updated.

**Parameters:**

- [in] pKey – the registry key associated with the value. This must be a unique value.
- [in] keyLen – the length of the key in bytes.
- [in] pValue – the value to set
- [in] valueLen – length of the value in bytes.

**Returns:**

REG\_RESULT\_OK if the value was successfully added (or updated).

**Possible error situations (what can be identified in an error code):**

- REG\_RESULT\_OK - The function completed successfully.
- REG\_RESULT\_KEY\_LEN – The length of the key is too large.
- REG\_RESULT\_FULL – The registry is full.
- REG\_RESULT\_VAL\_TRUNC – There was not enough space for the complete value. It has been truncated.

### B.7.3 regGetValue

```
tRegResult regGetValue( tU8* pKey, tU8 keyLen, tU8* pBuf, tU16  
bufLen, tU16* pValueLen )
```

Get a value from the registry.

**Parameters:**

- [in] pKey – the registry key associated with the value.
- [in] keyLen – the length of the key in bytes.
- [in] pBuf – the value is copied to this buffer
- [in] bufLen – length of the buffer in bytes
- [out] pValueLen – the actual length of the value is returned in this parameter.

**Returns:**

REG\_RESULT\_OK if the value was successfully retrieved.

**Possible error situations (what can be identified in an error code):**

- REG\_RESULT\_OK - The function completed successfully.
- REG\_RESULT\_NO\_KEY – The key did not exist in the registry.

REG\_RESULT\_VAL\_TRUNC – There was not enough space in the output buffer for the complete value. It has been truncated.

#### B.7.4 regRemove

```
tRegResult regRemove( tU8* pKey, tU8 keyLen )
```

Remove a symbol from the registry. Both key and value will be removed.

**Parameters:**

[in] pKey – the registry key to be removed  
[in] keyLen – the length of the key in bytes.

**Returns:**

REG\_RESULT\_OK if the key was successfully removed.

**Possible error situations (what can be identified in an error code):**

REG\_RESULT\_OK - The function completed successfully.  
REG\_RESULT\_NO\_KEY – The key did not exist in the registry.

#### B.7.5 regNextKey

```
tRegResult regNextKey( tU8* pKey, tU8 keyLen, tU8* pLen, tS32* pState )
```

This function is used to iterate over all available keys in the registry. The first time this function is called \*pState must be equal to REG\_ITERATOR\_START.

**Parameters:**

[in] pKey – the key is copied to this buffer  
[in] keyLen – the length of the key buffer in bytes.  
[in] pLen – number of bytes copied to the key buffer.  
[in/out] pState – keeps state information. When the first key should be found this parameter must be set to REG\_ITERATOR\_START.

**Returns:**

REG\_RESULT\_OK if the key was successfully found.

**Possible error situations (what can be identified in an error code):**

REG\_RESULT\_OK - The function completed successfully.  
REG\_RESULT\_NO\_KEY – When no more keys are found.



## B.8 I<sup>2</sup>C API

### B.8.1 i2cCheckStatus

```
tS8 i2cCheckStatus( void )
```

Checks the I2C status.

**Returns:**

- 00h Bus error
- 08h START condition transmitted
- 10h Repeated START condition transmitted
- 18h SLA + W transmitted, ACK received
- 20h SLA + W transmitted, ACK not received
- 28h Data byte transmitted, ACK received
- 30h Data byte transmitted, ACK not received
- 38h Arbitration lost
- 40h SLA + R transmitted, ACK received
- 48h SLA + R transmitted, ACK not received
- 50h Data byte received in master mode, ACK transmitted
- 58h Data byte received in master mode, ACK not transmitted
- 60h SLA + W received, ACK transmitted
- 68h Arbitration lost, SLA + W received, ACK transmitted
- 70h General call address received, ACK transmitted
- 78h Arbitration lost, general call addr received, ACK transmitted
- 80h Data byte received with own SLA, ACK transmitted
- 88h Data byte received with own SLA, ACK not transmitted
- 90h Data byte received after general call, ACK transmitted
- 98h Data byte received after general call, ACK not transmitted
- A0h STOP or repeated START condition received in slave mode
- A8h SLA + R received, ACK transmitted
- B0h Arbitration lost, SLA + R received, ACK transmitted
- B8h Data byte transmitted in slave mode, ACK received
- C0h Data byte transmitted in slave mode, ACK not received
- C8h Last byte transmitted in slave mode, ACK received
- F8h No relevant status information, SI=0
- FFh Channel error

### B.8.2 i2cStart

```
tS8 i2cStart( void )
```

Generates a start condition on I2C when bus is free. Master mode will also automatically be entered.

Note: After a stop condition, you may need a bus free time before you can generate a new start condition.

**Returns:**

I2C\_CODE\_OK or I2C status code (see i2cCheckStatus)

### B.8.3 i2cRepeatStart

```
tS8 i2cRepeatStart( void )
```

Generates a start condition on I2C when bus is free. Master mode will also automatically be entered.

Note: After a stop condition, you may need a bus free time before you can generate a new start condition.

**Returns:**

I2C\_CODE\_OK or I2C status code (see i2cCheckStatus)

#### B.8.4 i2cPutChar

```
tS8 i2cPutChar( tU8 data )
```

Sends a character on the I2C network

**Parameters:**

**[in]** data – the character to send

**Returns:**

I2C\_CODE\_OK – The function completed successfully

I2C\_CODE\_BUSY – data register is not ready -> byte was not sent

#### B.8.5 i2cGetChar

```
tS8 i2cGetChar( tU8 mode, tU8* pData )
```

Read a character. I2C master mode is used. This function is also used to prepare if the master shall generate acknowledge or not acknowledge.

**Parameters:**

**[in]** mode – I2C\_MODE\_ACK0 Set ACK=0. Slave sends next byte

I2C\_MODE\_ACK1 Set ACK=1. Slave sends last byte

I2C\_MODE\_READ Read data from data register

**[out]** pData – a pointer to where the data shall be saved

**Returns:**

I2C\_CODE\_OK – The function completed successfully

I2C\_CODE\_EMPTY – no data is available

#### B.8.6 i2cWrite

```
tS8 i2cWrite( tU8 addr, tU8* pData, tU16 len )
```

Sends data on the I2C network

Note: After this function is run, you may need a bus free time before a new data transfer can be initiated.

**Parameters:**

**[in]** addr – the address to write to

**[in]** pData – the data to transmit

**[in]** len – number of bytes to transmit

**Returns:**

I2C\_CODE\_OK – The function completed successfully  
I2C\_CODE\_ERROR – an error occurred

### B.8.7 i2cWaitTransmit

```
tS8 i2cWaitTransmit( void )
```

Wait until data has been transmitted.

**Parameters:**

[in] addr – the address to write to  
[in] pData – the data to transmit  
[in] len – number of bytes to transmit

**Returns:**

I2C\_CODE\_OK – The function completed successfully  
I2C\_CODE\_ERROR – an error occurred

### B.8.8 i2cWriteWithWait

```
tS8 i2cWriteWithWait( tU8 data )
```

Send a character on the I2C network and wait until it has been transmitted.

**Parameters:**

[in] data – the data to transmit

**Returns:**

I2C\_CODE\_OK – The function completed successfully  
I2C\_CODE\_BUSY – data register is not ready -> byte was not sent

### B.8.9 i2cRead

```
tS8 i2cRead( tU8 addr, tU8* pBuf, tU16 len )
```

Read a specified number of bytes from the I2C network.

Note: After this function is run, you may need a bus free time before a new data transfer can be initiated.

**Parameters:**

[in] addr – the address to read from  
[in] pBuf – the read data is stored in this buffer  
[in] len – number of bytes to read

**Returns:**

I2C\_CODE\_OK or I2C status code (see i2cCheckStatus)

## B.9 EEPROM API

### B.9.1 eepromPageRead

```
tS8 eepromPageRead( tU16 addr, tU8* pBuf, tU16 len )
```

Read data from the eeprom.

**Parameters:**

- [in]** addr – the address to read from
- [in]** pBuf – the read data is stored in this buffer
- [in]** len – number of bytes to read

**Returns:**

- I2C\_CODE\_OK – the function completed successfully
- I2C\_CODE\_ERROR – an error occurred

### B.9.2 eepromWrite

```
tS8 eepromWrite( tU16 addr, tU8* pData, tU16 len )
```

Read data from the eeprom.

**Parameters:**

- [in]** addr – the address to write to
- [in]** pData – the data to write
- [in]** len – number of bytes to write

**Returns:**

- I2C\_CODE\_OK – the function completed successfully
- I2C\_CODE\_ERROR – an error occurred

### B.9.3 eepromPoll

```
tS8 eepromPoll( void )
```

Waits till I2C returns ACK (after BURN cycle)

**Returns:**

- I2C\_CODE\_OK – the function completed successfully
- I2C\_CODE\_ERROR – an error occurred

## B.10 Time API

### B.10.1 clockMs

```
tU32 clockMs ( void )
```

Returns number of milliseconds since start-up

**Returns:**

Number of milliseconds since start-up.

## C Getting Started

This appendix contains information about how to quickly get up and running with your application development and describes the many sample applications that are included.

The Bluetooth QuickStart Kit comes shipped with a demo application pre-installed.

### C.1 Program Installation

To quickly get up and running with your program development, perform the following actions:

- 1) Install GNUARM (GCC v3.4.3) (program included on the CD-ROM).
- 2) Install LPC2xxx-gcc-newlib.exe (program included on the CD-ROM).
- 3) Register on Embedded Artists homepage.
- 4) Download the *QuickStart library* along with sample applications. Unpack the zip archive at an appropriate folder on your harddisk.  
You will always have access to the latest version of the QuickStart library and the latest sample applications.
- 5) Test the sample applications and learn the platform API by studying the examples. To compile and download a sample application;
  - a. Open the LPC2xxx-gcc-newlib link (under Programs->Embedded Artists ->LPC2xxx-gcc-newlib).
  - b. Change working directory to where you unzipped the *QuickStart library*. Change working directory to the specific sample application that you want to compile and download.
  - c. Type **make** to compile and link the program.
  - d. Type **deploy** to compile, link, and download the program. Make sure jumper J8 is shorted and the automatic bootloader is enabled (see *Figure 18* on page 25 for details).
- 6) Start developing your own application.

### C.2 Sample Applications

There are currently seven sample applications (plus the pre-loaded demo application). These sample applications are described below.

#### C.2.1 Applet

This sample application illustrates how to create a simple applet that communicates with a server application on the embedded system.

The sample applet contains three panels:

- The first panel contains a temperature gauge and two buttons. The buttons will start or stop the process, on the embedded system, that send back (simulated) temperature data to the applet
- The second panel contains 8 buttons, which control the RGB Led. Each button will enable a color on the Led.
- The third panel contains a slider which just sends a data value to the embedded system. The data value is printed onto the console.

## Files

- `sample_applet/led.c` – this file contains code that controls the LED
- `sample_applet/led.h` – header file with prototypes and constants needed to control the LED.
- `sample_applet/sample.c` – this file contains the server code that interacts with the applet.
- `sample_applet/www/applet.html` – this is the HTML file that will be downloaded from the web server to start the applet.
- `sample_applet/www/FlexiGauge.java` – This is a Java class that implements a graphical item that is part of the applet.
- `sample_applet/www/myApplet.jar` – This is a Java archive that contains the compiled applet.
- `sample_applet/www/myApplet.java` – This is the actual applet code.
- `sample_applet/www/VTextIcon.java` – This is a Java class that implements a graphical item that is part of the applet.

## How-To

1. Store the `myApplet.jar` and `applet.html` files in the web server directory on the memory card.
2. Use a web browser to do download the `applet.html` file from the web browser. The applet will now be started (given that you have Java runtime environment installed on your computer).

## C.2.2 Bluetooth

This sample application illustrates how to create an application that communicates with the Bluetooth module. This specific example will request the Bluetooth module to search for Bluetooth devices.

Any device found will have its address and name printed onto the console.

### Files

- `sample_bluetooth/sample.c` – this file contains the code for the sample application.

## C.2.3 File System

This sample application illustrates how to use the File System API. The application shows how to create directories, create and write data to files, read data from files and list the content in a directory.

### Files

- `sample_filesys/sample.c` – this file contains the code for the sample application.

### C.2.4 Registry

This sample application illustrates how to use the Registry, that is, persistent storage in the eeprom.

The example will start by trying to read a specified key from the registry. If the key is found the value associated with this key will be printed onto the console. If the key isn't found a new default value will be written to the registry.

The example also illustrates how to iterate through all keys that are stored in the registry.

#### Files

- `sample_registry/sample.c` – this file contains the code for the sample application.

### C.2.5 TCP Client

This sample application illustrates how to create a TCP client, that is, a client that will try to connect to a TCP server. The example also illustrates how to create and start OS processes.

The client will try to connect to the server until it succeeds. In the console it will print the following information:

- `Trying to connect...error` – if an error occurred while trying to connect. The error could, for example, be that there is no established Bluetooth connection.
- `Trying to connect...refused` – if there is no server listening on the IP address specified by the client.
- `Trying to connect...connected` – when the connection is established.

#### How-To

In order to test the client functionality a TCP server is needed. The file `TCPServer.jar` contains a TCP server implemented in Java. Start the server by typing `java -jar TCPServer.jar <port>` in a command prompt, where `<port>` is the port number the server should listen to (the default port used by the client is 2020).

#### Files

- `sample_tcpclient/sample.c` – this file contains the code for the sample application.
- `sample_tcpclient/TCPServer.jar` – this file contains a TCP server implemented in Java.

### C.2.6 TCP Server

This sample application illustrates how to create a TCP server. The server listens to the port 2020 and will print received data onto the console.

#### How-To



The functionality can be tested by using, for example, a Telnet client to connect to the server.

1. In Windows, open a command prompt and type `telnet <IP-address> <port>`, where `<IP-address>` could be, e.g., 192.168.2.230 and `<port>` could be, e.g., 2020.
2. Everything written to the telnet client will be sent to the TCP server and displayed in the console.

### Files

- `sample_tcpserver/sample.c` – this file contains the code for the sample application.

## C.2.7 Web Server

This sample application illustrates how to create EGIs and how to use SSIs. The following EGIs are implemented:

- `counter.egi` – increases a counter and sends the value to the client
- `formget.egi` – outputs the data sent to the EGI from a HTML form through a GET request.
- `formpost.egi` – outputs the data sent to the EGI from a HTML form through a POST request.
- `setled.egi` – controls the RGB LED.
- `listreg.egi` – lists all the keys and associated values in the registry
- `addreg.egi` – adds a value to the registry
- `remreg.egi` – removes a key from the registry
- `dirlist.egi` – lists the content of a directory in the file system

### How-To

Copy all files from the `sample_web/www` directory to the web server directory on the memory card and access them through a web browser.

### Files

- `sample_web/led.c` – this file contains code that controls the LED
- `sample_web/led.h` – header file with prototypes and constants needed to control the LED.
- `sample_web/sample.c` – this file contains the code for the sample application.
- `sample_web/www/filesys.shtml` – this file calls the `dirlist.egi`.
- `sample_web/www/get.html` – this file calls the `formget.egi`.
- `sample_web/www/led.html` – this file calls the `setled.egi`.

- `sample_web/www/post.html` – this file calls the `formpost.egi`.
- `sample_web/www/registry.shtml` – this file interacts with the `listreg.egi`, `addreg.egi` and the `remreg.egi`.
- `sample_web/www/ssi.shtml` – this file illustrates how SSIs can be used. It also calls the `counter.egi`.

### C.3 Stack Size Tips

Setting stack sizes to correct values can be difficult. It is important to have them as small as possible in order to save RAM. However, if a stack is too small the program is likely to crash. The normal process is as follows:

1. Set the stack sizes to a relatively large value.
2. Run the application for a suitable amount of time.
3. Use the “stack usage” feature in the operating system. This will give the number of bytes used in the stack for different processes in the system.
4. Adjust (i.e., decrease) the stack sizes according to these values.

Do not forget that `printf()` typically requires quite a lot of bytes from the stack. Avoid using full-scale `printf()`-implementation if possible in order to save valuable stack space.

The stack sizes must normally not be very large. Below is a short list of recommendation to minimize stack requirements in the code:

- Avoid excessive use of local variables in functions since these will be placed on the stack. If they are needed, declare them as **static**, if possible (since this will not place them on the stack). The drawback with declaring variables as static is that functions are no longer reentrant.
- Avoid functions that take a large number in input parameters (more than 6) or structures. If possible, send a pointer to a structure with input values instead.

Observe that the sample applications have not been optimized for low stack usage. These stack sizes have intentionally been set to very large values since **printf()** calls are used in the code. There is a large potential to decrease stack sizes in these sample programs.

## Free Manuals Download Website

<http://myh66.com>

<http://usermanuals.us>

<http://www.somanuals.com>

<http://www.4manuals.cc>

<http://www.manual-lib.com>

<http://www.404manual.com>

<http://www.luxmanual.com>

<http://aubethermostatmanual.com>

Golf course search by state

<http://golfingnear.com>

Email search by domain

<http://emailbydomain.com>

Auto manuals search

<http://auto.somanuals.com>

TV manuals search

<http://tv.somanuals.com>