

PHILIPS MAGNAVOX

RD0525C 5" Color Television INSTRUCTION MANUAL

1

Return Your Owner's Registration Card Within 10 Days.

Registering your purchase is an essential step to guarantee you'll receive all of the benefits you're entitled to as a PHILIPS MAGNAVOX product owner. Complete and mail your Owner's Registration Card today to ensure your right to warranty verification, owner confirmation, model registration, plus a wide variety of special services and savings.

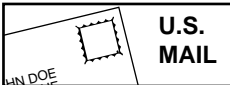

2

Know These Safety Symbols.

 This "bolt of lightning" indicates uninsulated material within your unit which may cause an electrical shock. For the safety of everyone in your household, please do not remove the product covering.

 The "exclamation point" calls attention to features for which you should read the enclosed literature closely to prevent operating and maintenance problems.



3

Read Operating Instructions Carefully.

The information in this manual can help you take full advantage of your product's many features, and ensure years of safe, reliable operation. So don't miss out. Read the enclosed instructions, safety tips, and warranty information today.



INTRODUCTION

Congratulations on the purchase of your new Color TV. The best way to familiarize yourself with your set is to read the operating instructions carefully. They will explain the operations and features of your set, the warranty, and safety procedures.

Positioning the TV

To obtain a picture with good contrast, position your TV in such a way that no direct sunlight strikes the screen.

Ventilation

To prevent overheating, do not cover the ventilation holes on the TV. Never place your TV close to a heat source.

The Model and Serial Numbers are on the back of this TV. Please record these numbers and the purchase date in the spaces below. Refer to them whenever you ask your dealer about this TV.

Model No. _____ Purchase Date _____

Serial No. _____



CAUTION

RISK OF ELECTRIC SHOCK
DO NOT OPEN



ATTENTION : RISQUE DE CHOC ELECTRIQUE-NE PAS OUVRIR

CAUTION: TO REDUCE THE RISK OF ELECTRIC SHOCK, DO NOT REMOVE COVER (OR BACK). NO USER-SERVICEABLE PARTS INSIDE. REFER SERVICING TO QUALIFIED SERVICE PERSONNEL.



The lightning flash with arrowhead symbol, within an equilateral triangle, is intended to alert the user to the presence of uninsulated "dangerous voltage" within the product's enclosure that may be of sufficient magnitude to constitute a risk of electric shock to persons.

The exclamation point within an equilateral triangle is intended to alert the user to the presence of important operating and maintenance (servicing) instructions in the literature accompanying the appliance.

WARNING: TO REDUCE THE RISK OF FIRE OR ELECTRIC SHOCK, DO NOT EXPOSE THIS APPLIANCE TO RAIN OR MOISTURE.

CONTROLS

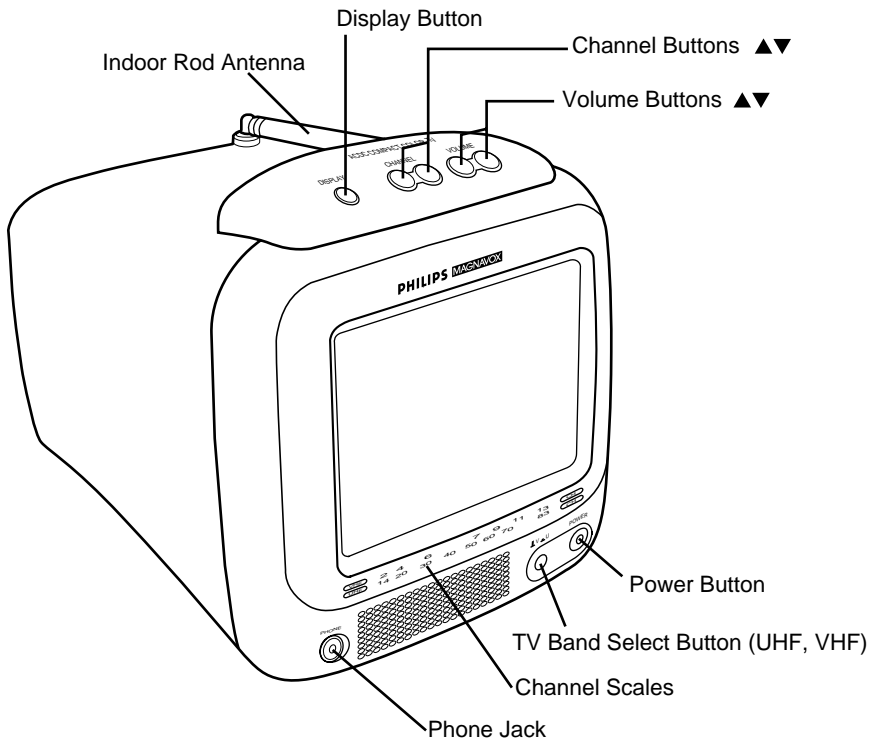

REAR

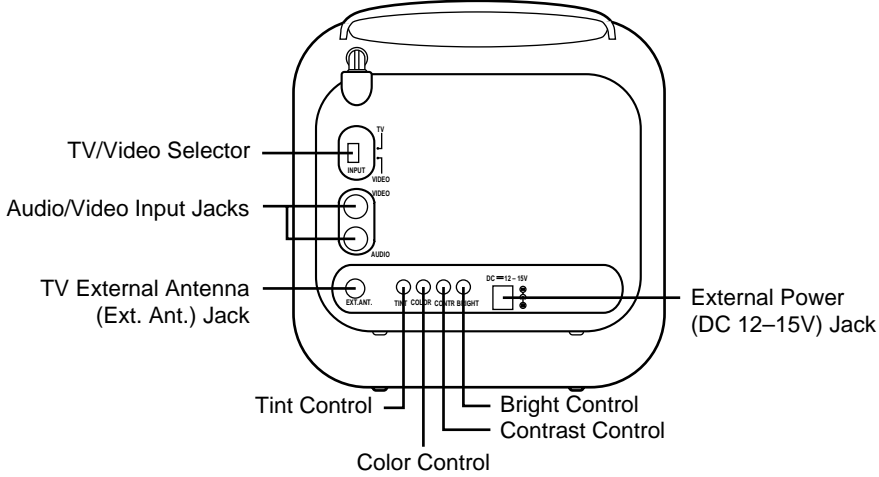

TV ANTENNA

Indoor Antenna Hookup

Your TV has a rod antenna.

1. Extend the antenna and rotate it until you get the best TV picture.

VHF/UHF Outdoor Antenna Hookup

- * Shorten the rod antenna, then lower the rod antenna into place on top of the TV.
1. If the outdoor antenna has flat twin lead (300 ohm) wire, connect the ends of this wire to the two screws on the adaptor (supplied). Push the plug of this adaptor into the TV external antenna (EXT. ANT.) jack.
 2. If the outdoor antenna has two twin lead wires or one round (coaxial) cable, purchase an appropriate adaptor from your dealer. Connect the antenna wires and/or cable to the adaptor, then plug the adaptor into the TV external antenna (EXT. ANT.) jack.

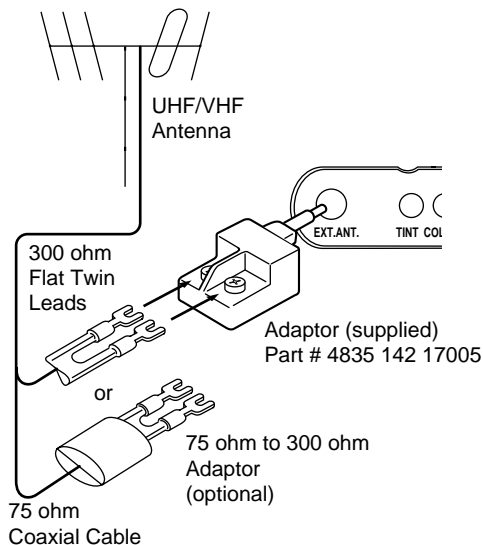

To order any optional accessories call Philips Service Solutions Group at 1-800-851-8885.

POWER SUPPLY

AC Adaptor

1. Insert the barrel plug **1** of the supplied AC Adaptor (Part # 4835 272 17023) into the external power (DC 12–15V) jack.
2. Plug the other end **2** of the AC Adaptor into an electrical outlet. For safety, this plug has one blade wider than the other. If you cannot insert the plug fully into the outlet, try reversing the plug.
3. Turn the TV power on by pressing the Power Button.

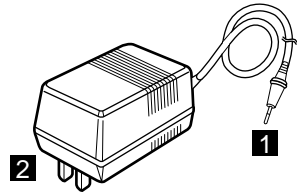

How to Use the Supplied Car Power Cord

Connect the barrel plug **1** of the Car Power Cord (Part # 4835 015 57024) to the external power (DC 12–15V) jack. Plug the other end **2** into the car cigarette lighter socket. See Figure 1.

CAUTION!

Do not let the metal tip of the power cord touch any metal part of the car while the cord is plugged into the cigarette lighter socket. It might blow a fuse or damage the cord.

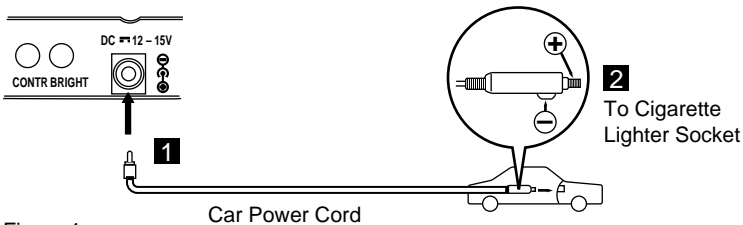
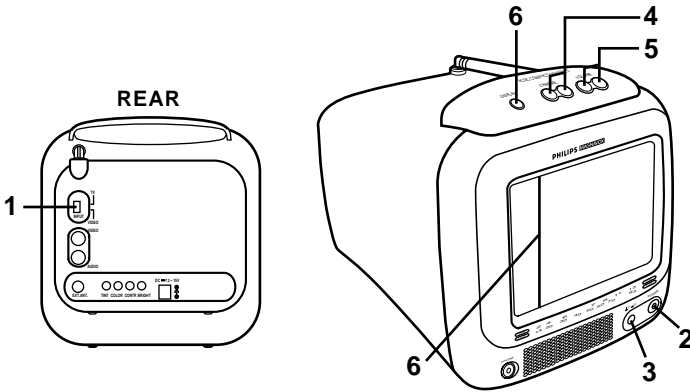

Figure 1

HOW TO WORK YOUR TV

HOW TO USE THE TV



1. Slide the TV/Video Selector to TV position.
2. Press the Power Button to turn on the TV.
3. Press the TV Band Select Button to select the desired channel band VHF (channels 2 – 13) or UHF (channels 14 – 83).
4. Press the Channel ▲ ▼ Buttons until the desired TV channel is reached.
 - When you press the Channel ▲ or ▼ Button, the CH Indicator Line will appear on the screen above the Channel scales. The CH Indicator Line will move across the screen to indicate the selected TV channel. After the desired TV channel is reached, the CH Indicator Line will disappear from the TV screen.

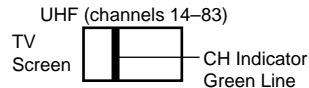
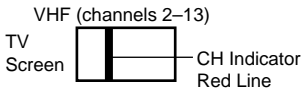

- Holding down the Channel ▲ or ▼ Button will scan through all of the available channels (in the selected band).
- The CH Indicator Line will be at the left side of the screen each time the TV is turned on. Just press the Channel ▲ Button to select the desired channel.
- The CH Indicator Line may not stop at a channel if the signal is weak. In this case, adjust the Indoor Rod Antenna and try to select the channel again by pressing the Channel ▲ ▼ Buttons.

-
5. Press the Volume ▲ ▼ Buttons to set the desired sound level.
 6. To check which channel is selected, press or press and hold the Display Button. The channel is indicated by the CH Indicator Line which appears on the screen above the Channel scales. When the Display Button is released, the CH Indicator Line will disappear.

HOW TO ADJUST THE COLOR FOR THE BEST PICTURE

Occasionally, you may want to adjust the color to your satisfaction by using the following controls:

- Bright** : Rotate to adjust the brightness of the picture. Adjust until the darkest parts of the picture are as bright as you prefer.
- Contrast** : Rotate to adjust the contrast between the black and white tones of the picture.
- Color** : Rotate to adjust the amount of color to your satisfaction.
- Tint** : Rotate to adjust natural skin tones, or to adjust color tones to your preference.

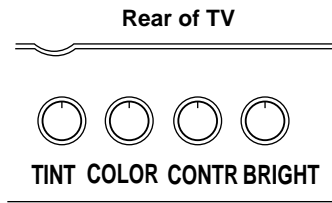

PHONE JACK

Plug an optional earphone plug into the Phone jack for private listening. The internal speaker is automatically disconnected.

AUDIO AND VIDEO INPUT JACKS

Video Operation

You can use your TV to play programs directly from a VCR or video camera. Audio and Video Input jacks are provided for direct hookup to your video equipment.

1. Connect Audio and Video cables from the Audio and Video output jacks of a VCR or video camera to the Audio and Video Input jacks on the TV.
2. Set the TV/Video Selector to Video position. You can now view what is being played on the VCR or video camera.*

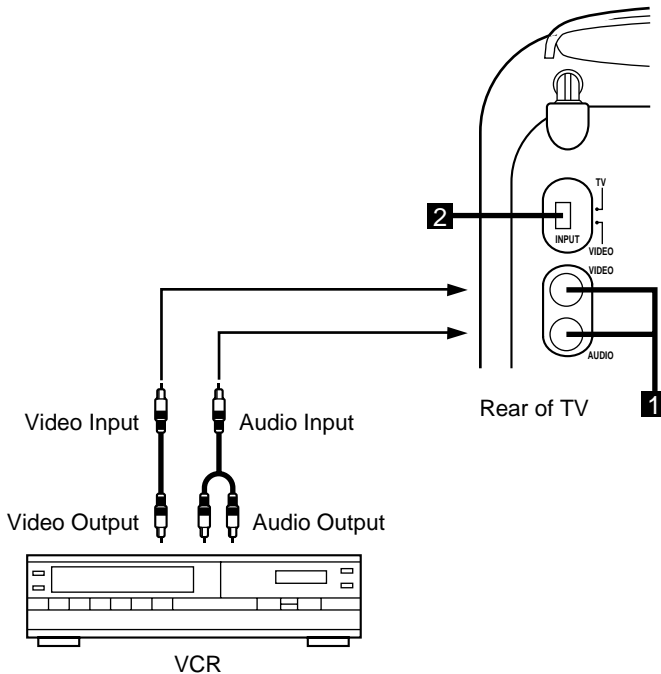

NOTE: When you set the TV/Video Selector to the Video position, you will be unable to watch normal TV broadcasts.

After enjoying the VCR or video camera playback, set the TV/Video Selector to the TV position in order to resume normal TV viewing.

* Refer to VCR or video camera instruction manuals for playback instructions.

Video Monitor Operation

If this TV is connected to either a VCR with a tuner or a video camera, you can use the TV as a recording monitor.

1. Connect the Audio and Video Output jacks on the VCR or video camera to the Audio and Video Input jacks on the TV.
2. Set the TV/Video Selector to the Video position.
3. Press the Power Button to turn the TV on.
4. Start recording with the VCR or video camera.

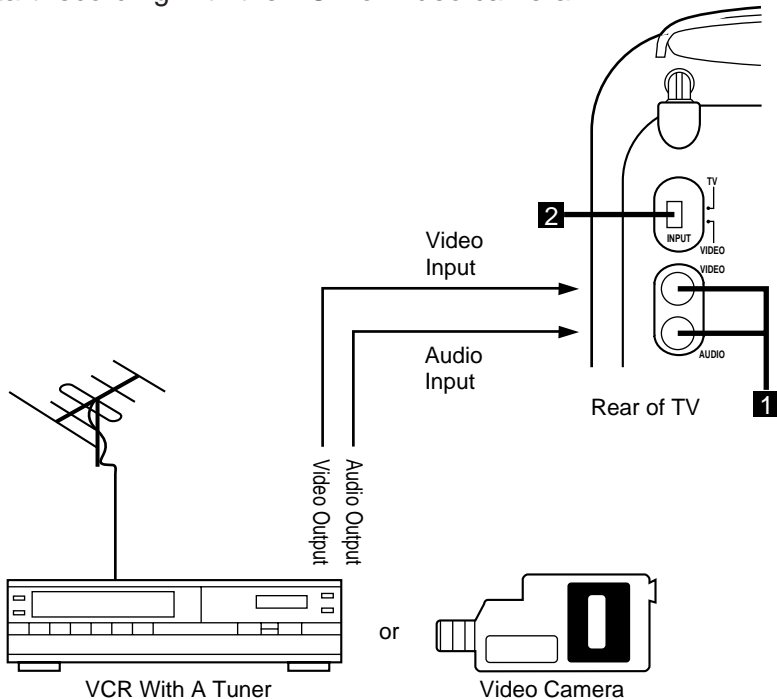

To Watch Other TV Programs While Recording

Set the TV/Video Selector to the TV position, then follow the instructions shown in How To Work Your TV.

Please read the VCR or video camera manuals carefully when connecting the products with other equipment.
Please turn off the power to each piece of equipment before connecting.

MAINTENANCE

Keep your TV away from extreme heat or cold. This may damage the TV. Clean the cabinet with a soft damp cloth. Do not use harsh cleaners, abrasives or strong detergents.

CAUTION!

Do not use your TV with video games or computers for a long period of time. It could damage the picture tube or leave a permanent image on the tube.

Switch the video game or computer OFF when it is not in use.

TO REPLACE THE FUSE OF THE CAR BATTERY CORD

● To remove the fuse

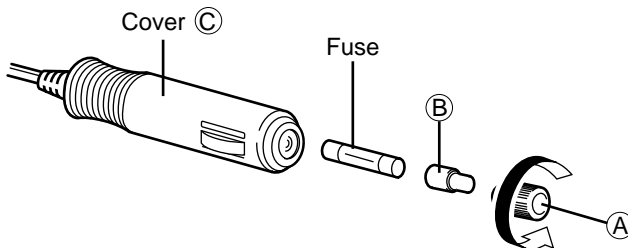

1. Turn part (A) in the direction of the arrow to remove it from the cover (C).
2. Replace the fuse (4A-125V or 4A-250V).

● To install the fuse

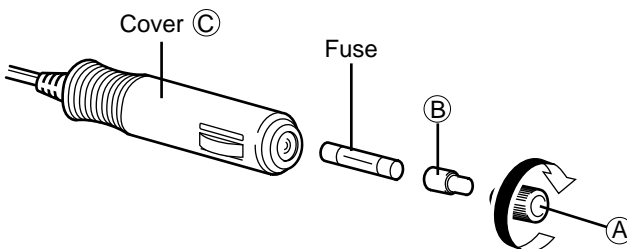

Insert the new fuse and part (B) into the cover (C), then turn part (A) in the direction of the arrow to fix it firmly.

BEFORE CALLING FOR SERVICE

Remember! Charges for TV installation, adjustment of customer controls, or repair of antenna systems outside the TV are not covered under your warranty. Be sure to make these simple checks before calling for service. These tips can save you time and money.

Problem	Action
No Power	<ul style="list-style-type: none">• Unplug the AC Adaptor from the wall outlet and wait 60 seconds. Reconnect the AC Adaptor and switch the TV ON.• Try another outlet.• Be sure the AC Adaptor plug is firmly connected to the external power (DC 12–15V) jack on the TV.
No Picture	<ul style="list-style-type: none">• Check that the antenna is properly connected to the TV.• Check connections on the antenna.• Check the TV/Video selector (set to TV position).
No Sound	<ul style="list-style-type: none">• Adjust the Volume.
No Color	<ul style="list-style-type: none">• Check the Color control.• Is station transmitting color?• Try another channel.
Wrong Color	<ul style="list-style-type: none">• Adjust the Color and Tint controls. <p>See HOW TO ADJUST THE COLOR FOR THE BEST PICTURE section.</p>
Picture too light or too dark	<ul style="list-style-type: none">• Adjust the Bright and Contrast controls.
Picture interference	<ul style="list-style-type: none">• Check the antenna for shorted or broken wires.• Reposition the antenna.• Possible station trouble or local interference (electric motors, etc.). Try another channel or adjust the antenna.• Press the Channel Buttons to retune the channel.

LIMITED WARRANTY

COLOR TELEVISION

90 Days Free Labor

One Year Free Replacement of Parts (Two Years Free Replacement on Color Picture Tube)

This product must be carried in for repair.

WHO IS COVERED?

You must have proof of purchase to receive warranty service. A sales receipt or other document showing that you purchased the product is considered proof of purchase.

WHAT IS COVERED?

Warranty coverage begins the day you buy your product. For 90 days thereafter, all parts will be repaired or replaced free, and labor is free. From 90 days to one year from the day of purchase, all parts will be repaired or replaced free, but you pay for all labor charges. From one to two years from the day of purchase, you pay for the replacement or repair of all parts except the picture tube, and for all labor charges. After two years from the day of purchase, you pay for the replacement or repair of all parts, and for all labor charges.

All parts, including repaired and replaced parts, are covered only for the original warranty period. When the warranty on the product expires, the warranty on all replaced and repaired parts also expires.

WHAT IS EXCLUDED?

Your warranty does not cover:

- labor charges for installation or setup of the product, adjustment of customer controls on the product, and installation or repair of antenna systems outside of the product.
- product repair and/or part replacement because of misuse, accident, unauthorized repair, or other cause not within the control of Philips Consumer Electronics Company.
- reception problems caused by signal conditions or cable or antenna systems outside the unit.
- a product that requires modification or adaptation to enable it to operate in any country other than the country for which it was designed, manufactured, approved, and/or authorized, or repair of products damaged by these modifications.
- incidental or consequential damages resulting from the product. (Some states do not allow the exclusion of incidental or consequential damages, so the above exclusion may not apply to you. This includes, but is not limited to, prerecorded material, whether copyrighted or not copyrighted.)
- a product used for commercial or institutional purposes.

WHERE IS SERVICE AVAILABLE?

Warranty service is available in all countries where the product is officially distributed by Philips Consumer Electronics Company. In countries where Philips Consumer Electronics Company does not distribute the product, the local Philips service organization will attempt to provide service (although there may be a delay if the appropriate spare parts and technical manual(s) are not readily available).

MAKE SURE YOU KEEP...

Please keep your sales receipt or other document showing proof of purchase. Attach it to this owner's manual and keep both nearby. Also keep the original box and packing material in case you need to return your product.

BEFORE REQUESTING SERVICE...

Please check your owner's manual before requesting service. Adjustments of the controls discussed there may save you a service call.

TO GET WARRANTY SERVICE IN U.S.A., PUERTO RICO OR U.S. VIRGIN ISLANDS...

Contact a Philips factory service center (see enclosed list) or authorized service center to arrange repair.

(In U.S.A., Puerto Rico and U.S. Virgin Islands, all implied warranties, including implied warranties of merchantability and fitness for a particular purpose, are limited in duration to the duration of this express warranty. But, because some states do not allow limitations on how long an implied warranty may last, this limitation may not apply to you.)

TO GET WARRANTY SERVICE IN CANADA...

Please contact Philips at:

1-800-661-6162 (French Speaking)

1-800-363-7278 (English Speaking)

(In Canada, this warranty is given in lieu of all other warranties. No other warranties are expressed or implied, including any implied warranties of merchantability or fitness for a particular purpose. Philips is not liable under any circumstances for any direct, indirect, special, incidental, or consequential damages, howsoever incurred, even if notified of the possibility of such damages.)

REMEMBER...

Please record the model and serial numbers found on the product below. Also, please fill out and mail your warranty registration card promptly. It will be easier for us to notify you if necessary.

MODEL # _____

SERIAL # _____

Philips Service Solutions Group, P.O. Box 2976, Longview, Texas 75606
(903) 242-4800

1111-2871M180 F9911-1

Free Manuals Download Website

<http://myh66.com>

<http://usermanuals.us>

<http://www.somanuals.com>

<http://www.4manuals.cc>

<http://www.manual-lib.com>

<http://www.404manual.com>

<http://www.luxmanual.com>

<http://aubethermostatmanual.com>

Golf course search by state

<http://golfingnear.com>

Email search by domain

<http://emailbydomain.com>

Auto manuals search

<http://auto.somanuals.com>

TV manuals search

<http://tv.somanuals.com>