



HEARTSTART XLT

INSTRUCTIONS FOR USE

M3500B

Instructions for Use

**M3500B HeartStart XLT
Defibrillator/Monitor**

PHILIPS

Notice

About This Edition

Edition 3
Printed in the USA
Publication number M3500-91900

The information in this guide applies to the M3500B HeartStart XLT, release Main 35 and earlier. This information is subject to change without notice.

Philips Medical Systems shall not be liable for errors contained herein or for incidental or consequential damages in connection with the furnishing, performance, or use of this material.

Edition History

Edition 1, January 3, 2000
Edition 2, May 15, 2000
Edition 3, October 30, 2002

Copyright

Copyright © 2002
Philips Electronics North America Corporation
3000 Minuteman Road
Andover, MA USA 01810-1099
(978) 687-1501

All rights are reserved. Reproduction in whole or in part is prohibited without the prior written consent of the copyright holder.

SMART Biphasic is a registered trademark of Philips Medical Systems.

Use of supplies or accessories other than those recommended by Philips Medical Systems may compromise product performance.

THIS PRODUCT IS NOT INTENDED FOR HOME USE.

IN THE U.S., FEDERAL LAW RESTRICTS THIS DEVICE TO SALE ON OR BY THE ORDER OF A PHYSICIAN.

Medical Device Directive

The M3500B HeartStart XLT Defibrillator/Monitor complies with the requirements of the Medical Device Directive 93/42/EEC and carries the

CE₀₁₂₃ mark accordingly.

Authorized EU-representative:

Philips Medizinsysteme Böblingen GmbH
Hewlett Packard Str. 2
71034 Böblingen
Germany

Canada EMC:ICES-001

Device Tracking

In the USA, the Food and Drug Administration requires defibrillator manufacturers and distributors to track the location of their defibrillators. If your defibrillator has been sold, donated, lost, stolen, exported, or destroyed, or if it was not obtained directly from Philips Medical Systems, please notify Philips Medical Systems at (978) 659-3202.

Conventions

This guide uses the following conventions:

WARNING

Warning statements describe conditions or actions that can result in personal injury or loss of life.

CAUTION

Caution statements describe conditions or actions that can result in damage to the equipment or loss of data.

NOTE

Notes contain additional information on usage.

TEXT represents messages that appear on the display

Softkey

represents softkey labels that appear on the display above or below the button to which they correspond

Introduction

Overview	1-1
Intended Use	1-3
Defibrillation Therapy	1-3
Indications for AED Therapy	1-3
Contraindications for AED Therapy	1-4
Precautions for AED Therapy	1-4
Indications for Manual Defibrillation Therapy	1-4
Contraindications for Manual Defibrillation Therapy	1-5
Precautions for Manual Defibrillation Therapy	1-5
Noninvasive Pacing Therapy	1-5
Indications	1-5
Contraindications	1-5
SpO2 Monitoring	1-6
Indications	1-6
Contraindications	1-6
Learning to Use the HeartStart XLT	1-7
Safety Considerations	1-7

Getting Started

Getting Acquainted	2-1
Basic Orientation	2-2
Manual Mode Controls	2-4
LCD Backlight	2-8
Connecting to Power	2-9
Inserting the Battery	2-9
Removing the Battery	2-10
Low Battery Warning	2-10
Using a Data Card	2-11
Inserting a Data Card	2-12
Removing a Data Card	2-13

Defibrillating in AED Mode

Overview	3-3
Defibrillation (with the default configuration)	3-3
Defibrillation (with a modified configuration)	3-4
Preparation	3-5
Defibrillating	3-6
Automatic Re-analysis On	3-11
Automatic Re-analysis Off	3-11
Pausing for CPR	3-12
Monitoring Rhythm	3-14
ERC Protocol	3-16
Troubleshooting	3-18

Monitoring the ECG

Applying Monitoring Electrodes	4-2
Electrode Placement	4-3
Selecting the Lead	4-5
Setting the Heart Rate Alarm	4-6
Disabling the HR Alarm	4-7
Adjusting the ECG Size	4-7
Troubleshooting	4-7

Monitoring SpO2

Understanding Pulse Oximetry	5-2
Selecting a Sensor	5-3
Reusable Sensors	5-4
Disposable Sensors	5-4
Semi-disposable Sensors	5-4
Applying the Sensor	5-5
Connecting the Sensor Cable	5-6
Monitoring	5-7
Setting Alarms	5-8
Responding to an Alarm	5-8

Discontinuing SpO2 Monitoring	5-9
Caring for Sensors	5-9
Troubleshooting	5-10

Defibrillating in Manual Mode

Enabling Manual Mode	6-2
Preparation	6-3
Defibrillating	6-4
Returning to AED Mode	6-6

Performing Synchronized Cardioversion

Preparing for Synchronized Cardioversion	7-2
Delivering a Synchronized Shock	7-2
Delivering Additional Synchronized Shocks	7-4
Disabling Sync Mode	7-4

Pacing

Demand Mode Versus Fixed Mode	8-2
Monitoring During Pacing	8-2
Preparing for Pacing	8-3
Pacing	8-4
Changing Pacing Modes	8-6
Defibrillating During Pacing	8-6
Troubleshooting	8-7

Storing, Retrieving & Printing

Overview	9-1
Marking Events	9-2
Events Recorded	9-3
Creating a Patient Record	9-5
Printing the Internal Event Summary	9-6
Printing Events	9-8

Setting Up and Configuring the HeartStart XLT

Connecting/Disconnecting Patient Cables	10-1
This section describes how to connect and disconnect the:	10-1
Connecting the Pads Patient Cable	10-2
Disconnecting the Pads Patient Cable	10-3
Connecting the ECG Patient Cable	10-4
Disconnecting the ECG Patient Cable	10-4
Connecting the SpO2 Patient Cable	10-5
Disconnecting the SpO2 Patient Cable	10-5
Arranging Accessories in the Carrying Case	10-6
Configuring the HeartStart XLT	10-7
Accessing the Configuration Menu	10-7
Configurable Parameters	10-8
Setting the Manual Mode Password	10-13
Modifying the Configuration	10-15
Returning to the Default Configuration	10-15
Saving Settings to a Data Card	10-16
Loading Settings from a Data Card	10-16
Printing Settings	10-16

Maintaining the HeartStart XLT

Operational Checks	11-2
Before You Begin	11-2
Every Shift	11-3
Every Month	11-3
Every Three Months	11-3
Shift/System Check	11-4
Battery Capacity Test (CT)	11-7
Battery Maintenance	11-8
Charging Batteries	11-8
Battery Capacity	11-9
Battery Life-Expectancy	11-9
Storing Batteries	11-9
Discarding Batteries	11-9

Loading Printer Paper	11-10
Cleaning Instructions	11-12
Cleaning the HeartStart XLT	11-12
Cleaning the Carrying Case	11-12
Cleaning the Printer Printhead	11-13
Cleaning the Power Modules	11-13
Cleaning Pads, Electrodes & Cables	11-14
Removing & Replacing the Carrying Case	11-15
Putting On the Manual Door	11-17
Supplies & Accessories	11-18
Disposing of the HeartStart XLT	11-22

Troubleshooting

System Messages	12-2
Momentary Messages	12-5
Troubleshooting Tips	12-7
Calling for Service	12-9
United States of America	12-9
Latin America	12-9
Canada	12-9
Other International Areas	12-10

Specifications & Safety

Specifications	13-2
Defibrillator	13-2
Manual Mode	13-2
AED Mode	13-3
ECG Monitoring	13-4
Display	13-5
Thermal Array Printer	13-5
Thermal Array Printer (cont.)	13-6
Battery and Battery Power Module	13-6
Noninvasive Pacing	13-7
SpO2/Pulse Oximetry	13-7
Event Storage	13-8
General	13-8
Environmental	13-9
Symbol Definitions	13-10
Clinical Performance Summary - Defibrillation	13-14
Methods	13-14
Results	13-14
Conclusion	13-15
Clinical Performance Summary - Cardioversion	13-16
Methods	13-16
Results	13-16
Conclusion	13-18
Safety Considerations	13-19
Electromagnetic Compatibility	13-22
Reducing Electromagnetic Interference	13-22
Restrictions for Use	13-23
Immunity Level	13-23

1 Introduction

The M3500B HeartStart XLT Defibrillator/Monitor is designed to meet your resuscitation and monitoring needs. This guide provides instructions for safe and proper operation, set-up, configuration, and care of your HeartStart XLT.

In this chapter, you'll find general information that you should become familiar with before using the defibrillator/monitor.

Overview

The HeartStart XLT is a lightweight, portable, semi-automatic external defibrillator. It offers two modes of operation for defibrillation:

- Semi-Automatic External Defibrillation (AED) Mode
- Manual Mode

Both modes incorporate a low energy SMART Biphasic waveform for defibrillation.

In AED Mode, the HeartStart XLT analyzes the patient's ECG and advises you whether or not to deliver a shock. Voice prompts guide you through the defibrillation process by providing instructions and patient information. The voice prompts are reinforced by messages that appear on the display.

In Manual Mode, the HeartStart XLT turns control of the defibrillation process over to you. You assess the patient's ECG, decide if defibrillation is advised, and select the energy setting for defibrillation. Manual Mode also allows you to perform synchronized cardioversion and offers optional noninvasive pacing.

Defibrillation is performed through multifunction defib electrode pads. In addition, both AED and Manual Mode offer monitoring through pads, 3-lead ECG monitoring electrodes, or optional 5-lead ECG monitoring electrodes. Optional pulse oximetry (SpO₂) monitoring is available in both modes, as well. While monitoring ECG or SpO₂, you may set heart rate and/or SpO₂ alarms to alert you when these parameters are outside the limits defined.

The HeartStart XLT automatically stores critical events, such as shocks and alarm violations, in its internal memory. Additional events of interest to you may be marked for storage, as well. Events may be printed as they occur or an Event Summary may be printed at any time. The HeartStart XLT also allows you to store data and events on a Data Card for downloading to HeartStart Event Review Data Management systems.

The versatile HeartStart XLT is highly configurable to better meet the needs of diverse users. The messages and softkeys vary, depending on how the HeartStart XLT is configured. Be sure to familiarize yourself with your configuration before using the HeartStart XLT (see “Configuring the HeartStart XLT” on page 10-7).

The HeartStart XLT is powered by a rechargeable sealed lead acid (SLA) battery that allows the defibrillator to charge to 200 joules in less than three seconds. Proper care of your batteries will ensure that they have the energy required to operate the HeartStart XLT and to deliver the appropriate therapy. (See “Battery Maintenance” on page 11-8.) Similarly, following the specified operational checks will ensure that the HeartStart XLT is functioning and ready for use. (See “Operational Checks” on page 11-2.)

Intended Use

The M3500B HeartStart XLT Defibrillator/Monitor is for use by emergency personnel trained in the operation of the device and qualified by training in basic life support, advanced cardiac life support, defibrillation, or other physician-authorized emergency medical response. It must be used by or on the order of a physician.

When operating as a semi-automatic external defibrillator in AED Mode, the HeartStart XLT is suitable for use by health care professionals trained in basic life support that includes the use of an AED.

When operating as a defibrillator/monitor in Manual Mode, the HeartStart XLT is suitable for use by health care professionals trained in advanced cardiac life support.

Defibrillation Therapy

Defibrillation therapy is the definitive method for termination of a variety of potentially fatal arrhythmias. The HeartStart XLT provides this therapy through the application of a brief biphasic pulse of electricity to the cardiac muscle. This electrical energy is transferred through disposable multifunction defib electrode pads applied to the patient's bare chest.

NOTE

Successful resuscitation is dependent on many variables specific to the patient's physiological state and the circumstances surrounding the patient event. Failure to have a successful patient outcome is not a reliable indicator of defibrillator/monitor performance. The presence or absence of a muscular response to the transfer of energy during electrical therapy is not a reliable indicator of energy delivery or device performance.

Indications for AED Therapy

An AED is to be used in the presence of a suspected cardiac arrest on patients that are:

- Unresponsive
- Not breathing
- Pulseless

Contraindications for AED Therapy

An AED is not to be used on patients that exhibit one or any combination of the following:

- Responsiveness
- Spontaneous breathing
- Palpable pulse

Precautions for AED Therapy

The AED algorithm is not designed to handle erratic spiking problems caused by a properly or improperly functioning pacemaker. In patients with cardiac pacemakers, the HeartStart XLT may have reduced sensitivity and not detect all shockable rhythms.

NOTE

AED mode is not intended for use on children less than 8 years of age. For children older than 8 years, the American Heart Association recommends that standard operating procedures for AEDs be followed. American Heart Association *Guidelines 2000 for Cardiopulmonary Resuscitation and Emergency Cardiovascular Care*. Dallas, Texas; AHA; 2000"

Indications for Manual Defibrillation Therapy

Asynchronous defibrillation is the initial treatment for ventricular fibrillation and ventricular tachycardia, in patients who are pulseless and unresponsive.

Synchronous defibrillation is indicated for termination of atrial fibrillation. The SMART Biphasic waveform utilized in the HeartStart XLT Defibrillator/Monitor has undergone clinical testing demonstrating its effectiveness for cardioversion of atrial fibrillation.

The SMART Biphasic waveform utilized in the HeartStart XLT has undergone clinical testing in adults. These trials support the waveform's effectiveness for defibrillation of ventricular tachyarrhythmias at 150J.

In manual mode operation, the HeartStart XLT incorporates some user selectable lower energy levels that were not used in the clinical trials.

Contraindications for Manual Defibrillation Therapy

Asynchronous defibrillation therapy is contraindicated in patients that exhibit one or any combination of the following:

- Responsiveness
- Spontaneous breathing
- Palpable pulse

Precautions for Manual Defibrillation Therapy

Defibrillating asystole can inhibit the recovery of natural pacemakers in the heart and completely eliminate any chance of recovery. Asystole should not be routinely shocked.

Noninvasive Pacing Therapy

The HeartStart XLT provides noninvasive transcutaneous pacing by delivering a monophasic, electrical stimulus to the heart. This stimulus is intended to cause cardiac depolarization and myocardial contraction. The emergency care provider selects the stimulus current and rate settings. The energy is delivered through multifunction defib electrode pads applied to the patient's bare chest.

Indications

Noninvasive pacing is one method of treating patients with symptomatic bradycardia. It can also be helpful in patients with asystole, if performed early.

Contraindications

Noninvasive pacing is contraindicated in the treatment of ventricular fibrillation. Noninvasive pacing in the presence of severe hypothermia may be contraindicated.

SpO₂ Monitoring

A pulse oximeter is a noninvasive device that indicates the oxygen saturation (SpO₂) of arterial blood. This measurement is obtained through a probe that directs red and near infrared light through arterial beds. Hemoglobin absorbs these lights differently when it is bound with oxygen. Pulse oximetry measures this difference and translates the measurement into a saturation percentage that is displayed as an SpO₂ reading.

Indications

SpO₂ monitoring is indicated for use when it is beneficial to assess a patient's oxygen saturation level.

Contraindications

None known.

NOTE

Readings should be carefully considered in the presence of certain circumstances. Inaccuracies may result from the use of pulse oximeters in the presence of certain circumstances, such as hemoglobin saturated with compounds other than oxygen (such as carbon monoxide), hypothermia, hypovolemia, patient movement, nail polish and excessive ambient light.

Learning to Use the HeartStart XLT

The HeartStart XLT comes with:

- *Using the HeartStart XLT Defibrillator/Monitor*, a videotape, and
- *About Sealed Lead Acid Batteries*, an application note on battery maintenance.

For additional training materials, please visit our website at:

www.medical.philips.com/cms.

Safety Considerations

General warnings and cautions that apply to use of the HeartStart XLT are provided in Chapter 13. Additional warnings and cautions specific to a particular feature are provided in the appropriate section of this guide.

2 Getting Started

Your HeartStart XLT is shipped to you in its carrying case with most of the accessories in their compartments. All you need to do before getting started is:

- connect cables,
- connect to power, and
- insert the Data Card (if desired).

This chapter will acquaint you with the HeartStart XLT and then guide you through these activities.

NOTE

To connect cables to the HeartStart XLT or to arrange accessories in the carrying case, refer to “Setting Up and Configuring the HeartStart XLT” in Chapter 10.

Getting Acquainted

This section shows the HeartStart XLT controls/buttons, connections, and display layout. An overview of control functions is also provided.

NOTE

If your HeartStart XLT does not have the SpO₂ or Pacing option, disregard these controls and the related information described in this section.

Basic Orientation

The figure below shows the general layout of the controls, where the patient cables connect, and where to insert the battery and Data Card.

Figure 2-1 Basic Orientation

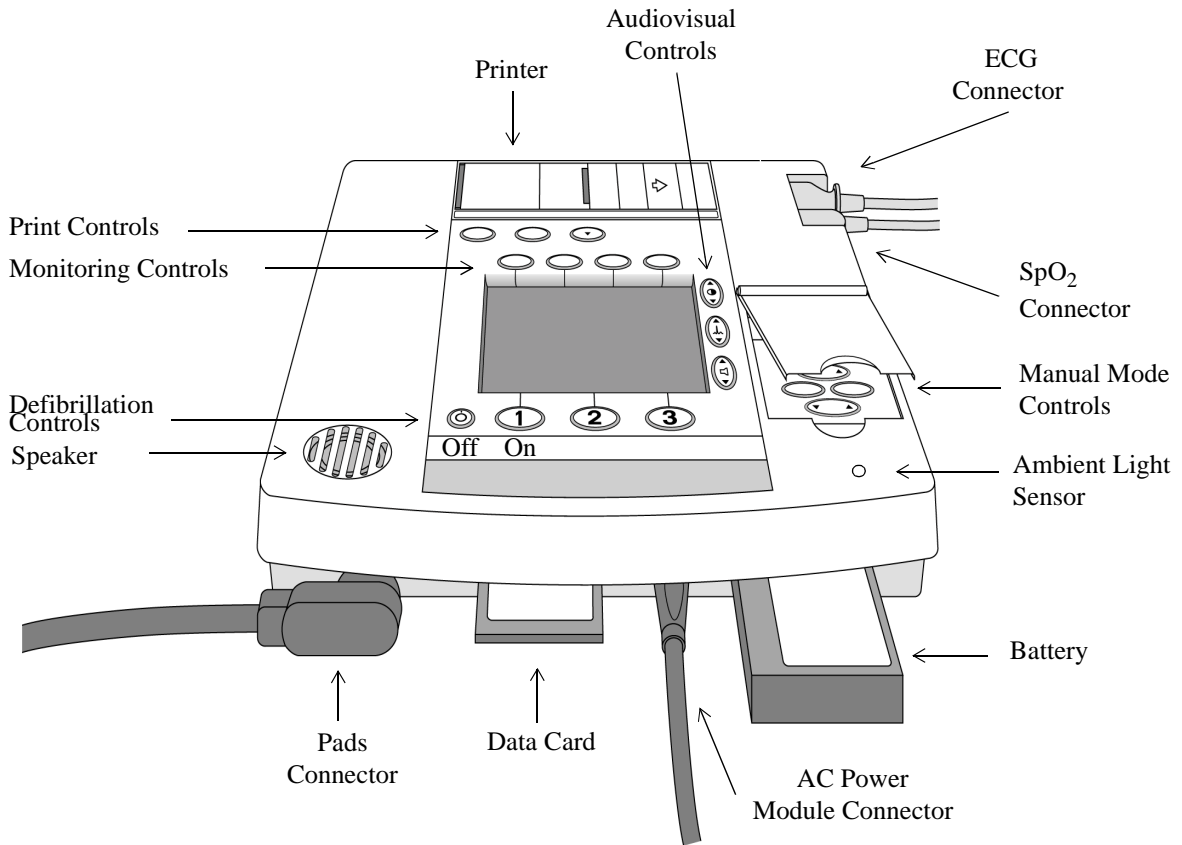

 - Powers on the HeartStart XLT.

 - Powers off the HeartStart XLT.

Defibrillation Controls - softkeys that perform the defibrillation function displayed in the softkey label above each button; control both AED and Manual Mode defibrillation.

Manual Mode Controls - provide access to Manual Mode and control of synchronized cardioversion and pacing (if the option is present).

Audiovisual Controls:

 Adjusts the display contrast.

 Adjusts the size of the ECG waveform displayed, printed, and stored. Pressing ▲ and ▼ simultaneously generates a 1 mV calibration pulse.

 Adjusts the volume of voice prompts and the QRS beeper.

Monitoring Controls - softkeys that perform the monitoring function displayed in the softkey label below each button; control heart rate and SpO₂ alarms and select the ECG source to monitor.

Print Controls - perform the function shown above each button. The print controls from left to right are:

Print Strip Prints ECG data, defibrillation events, and marked events real-time or with a 6 second delay (as configured). Press to start printing; press again to stop printing.

Print Summary Prints the Event Summary. (See “Storing, Retrieving & Printing” for more information.) Printing may be stopped by pressing the **Print Summary** or **Print Strip** button.

Mark Event Inserts a time-stamped annotation in the Event Summary. May be configured to print an annotated ECG strip when pressed.

Manual Mode Controls

The figure below shows the Manual Mode controls. These controls are accessed by lifting the door labeled "Manual."

Figure 2-2 Manual Mode Controls

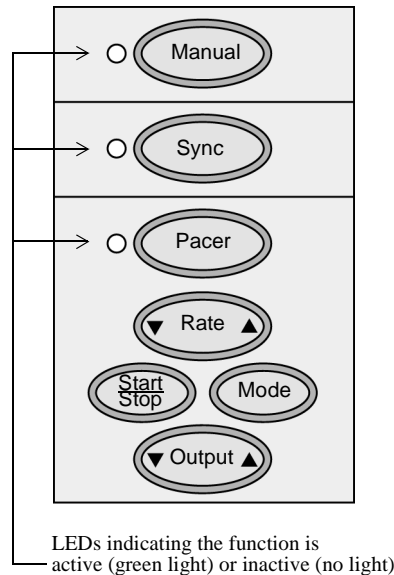



NOTE

Synchronized cardioversion and pacing controls only function when Manual Mode is enabled.

 Toggles between Manual Mode and AED Mode. Manual Mode is enabled when the green LED next to the key is lit. A password may be required for Manual Mode entry.

 Enables synchronized cardioversion when first pressed, as indicated by the green LED; disables synchronized cardioversion when pressed again.

 Activates the pacing function buttons (as indicated by the green LED), allowing you to use the buttons below to define pacing rate, mode, and current output. Also turns off the Pacer when pressed a second time.

 Adjusts the pacing rate.

 Delivers pacer pulses when first pressed; stops pacing when pressed again.

 Selects Demand or Fixed Mode for pacing.

 Adjusts the current output for pacing.

Display Layout

The following figures show the layout of the display in:

- AED Mode, with ECG and SpO₂ monitoring capabilities disabled.
- AED Mode, with ECG and SpO₂ monitoring capabilities enabled.
- Manual Mode.

NOTE

ECG and SpO₂ monitoring capabilities for AED Mode may be enabled and disabled independently in the configuration.

Figure 2-3 AED Mode Display Layout (ECG and SpO₂ disabled)

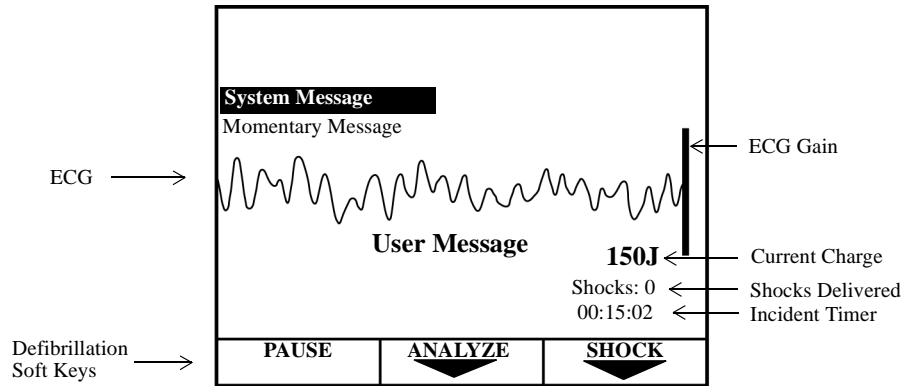

NOTE

In its default configuration, the HeartStart XLT powers on in AED Mode where voice prompts and user messages are active.

The Incident Timer shows the elapsed time since the HeartStart XLT was turned on. If the HeartStart XLT is powered on after being off for less than two minutes, the Incident Timer resumes where it left off. If power is off for more than two minutes, the Incident Timer resets to zero (00:00:00).

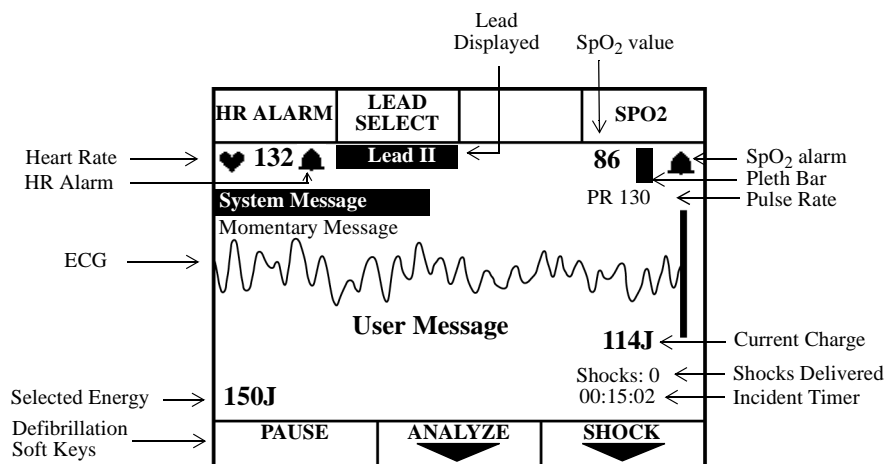
Figure 2-4 AED Mode Display Layout (ECG and SpO₂ Enabled)

User messages accompany voice prompts to guide you through the defibrillation process.

System and Momentary Messages:

- alert you to conditions that may require you to take action,
- provide status information, or
- offer recommendations.

A System Message remains on the display until the condition that generated the message no longer exists. A Momentary Message is temporary and appears on the display for only a few seconds. A list of messages is provided in Chapter 12.

Figure 2-5 Manual Mode Display Layout

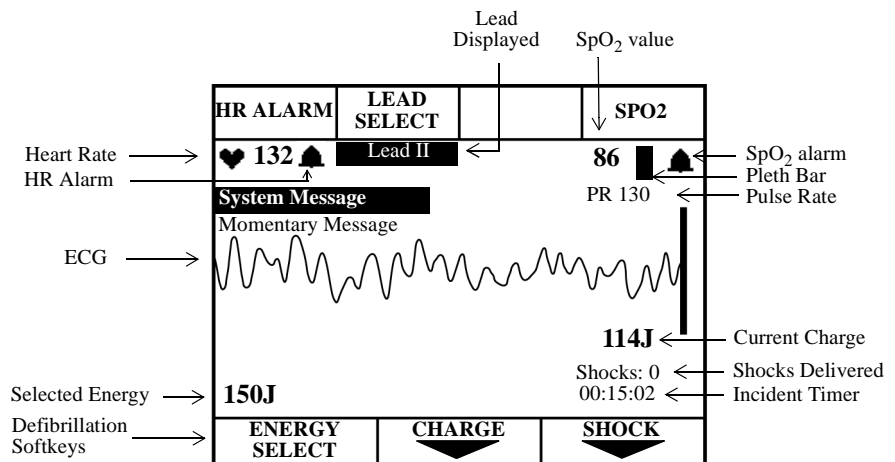

LCD Backlight

Under normal operation, the HeartStart XLT reads the ambient light and turns on the LCD back light when low light conditions exist. To turn on the back light at other times, press ▲ and ▼ on  simultaneously. To return to normal operation, press the same keys again. The back light also returns to normal operation each time you turn the HeartStart XLT on.

Connecting to Power

The HeartStart XLT is powered by the M3516A battery. Prior to inserting the battery, make sure that the battery is charged and has been properly maintained (See “Battery Maintenance” on page 11-8). A fully charged battery will last for about two hours. A second spare charged battery should be kept in the carrying case at all times.

The HeartStart XLT can also be powered by the M3517A AC Power Module or the M3518A DC Power Module. However the defibrillator will take longer to charge when powered by a power module, with the battery absent. The recommended practice when using a power module is to use the module in conjunction with a battery. For information on using the power modules, see the documentation supplied with the modules.

NOTE

To save battery capacity, the HeartStart XLT shuts itself off if a patient is not being monitored and no one has interacted with the device for 10 minutes.

Inserting the Battery

To insert the battery, slide it into the battery receptacle as shown in Figure 2-6. Then push the battery in until you hear an audible click.

Figure 2-6 Inserting the Battery

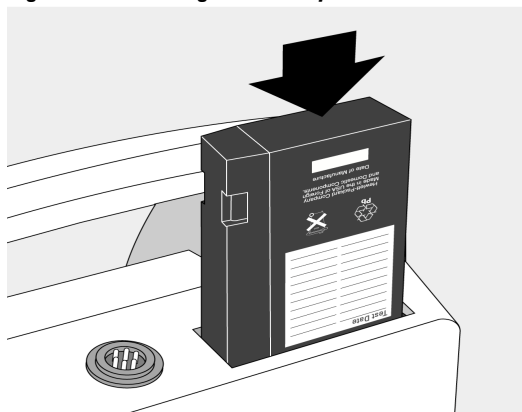

Removing the Battery

Before removing the battery, make sure the HeartStart XLT is powered off. Then, to remove the battery, press the black battery eject button and pull the battery out, as shown in Figure 2-7.

Figure 2-7 Removing the Battery

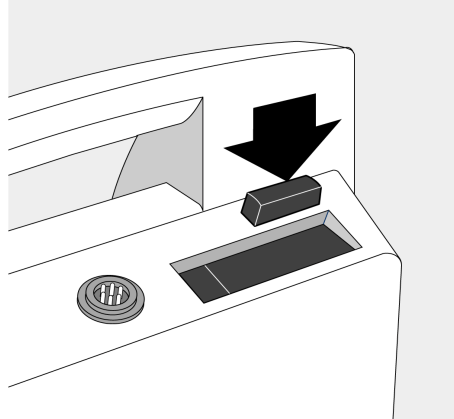

Low Battery Warning

The message **Low Battery** is displayed on the HeartStart XLT when the battery is low and needs recharging. This message indicates that the battery has sufficient remaining capacity to provide only about ten minutes of monitoring time and six shocks before the HeartStart XLT shuts off. Replace the battery as soon as possible.

If the power is off for less than 2 minutes, while you change the battery, the HeartStart XLT assumes that you are continuing to treat the same patient. It continues to store data on the Data Card and append events to the existing Event Summary. Alarms set prior to the power loss remain active.

If power remains off for more than 2 minutes, the HeartStart XLT assumes you are treating a different patient and assigns a new incident number. A new Event Summary begins with the next event.

Using a Data Card

Use of a Data Card is optional; the defibrillator will power up without a Data Card inserted. If you would like to collect patient information on a Data Card, the card must be inserted into the HeartStart XLT *before* the device is turned on.

CAUTION

Inserting or removing the data card while the defibrillator is on can corrupt the Data Card and prevent the unit from powering on again. If this occurs, see Table 12-3, Troubleshooting Tips.

The recommended practice is to use one Data Card per patient. Once a Data Card fills, recording stops; a second Data Card may not be inserted for the current incident, because the device will only allow the use of one Data Card per incident. Data Cards hold up to two hours of patient information.

Multiple incidents can be recorded on a single Data Card. Each incident is assigned a unique incident number.

Patient data from a Philips M3510A Data Card may be downloaded to a HeartStart Event Review Data Management system. HeartStart Event Review also allows you to erase patient data from a Data Card, allowing the card to be reused for another patient.

It's recommended that you use a designated Data Card to configure one or more defibrillators/monitors.

CAUTION

Use only the M3510A Data Card. These cards are specifically formatted to work with your Philips defibrillator. Generic cards, or other types of cards (such as modems) will not work, and may cause the defibrillator to malfunction.

Inserting a Data Card

To insert a Data Card:

1. Make sure the HeartStart XLT is powered off.
2. Press up on the release latch to open the door to the Data Card compartment.
3. If a Data Card is already in the compartment, press the black button inside the compartment to eject the card (see Figure 2-8). Then pull the card out.
4. With the yellow label facing up and the ▲ pointing towards the HeartStart XLT, slide the Data Card into the compartment.
5. Close the Data Card compartment door. Make sure that you hear a click, indicating that the door is latched shut.

Figure 2-8 Inserting a Data Card

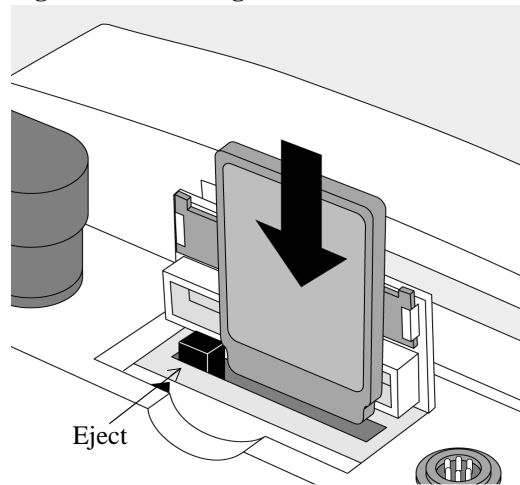

Removing a Data Card

To remove the Data Card:

1. Make sure the HeartStart XLT is powered off, (wait 2 seconds).
2. Press the black eject button (see Figure 2-8).
3. Pull the Data Card from the compartment.

3 Defibrillating in AED Mode

The HeartStart XLT's AED Mode is designed to guide you through standard treatment algorithms for cardiac arrest, including those provided by the American Heart Association and the European Resuscitation Council. Configuration choices allow you to customize AED Mode to better follow a specific treatment algorithm and to meet the unique needs of your life-saving team.

This chapter describes how to use the HeartStart XLT to defibrillate in AED Mode. It explains the prompts that guide you through the defibrillation process and describes how prompts vary depending upon the condition of the patient and the configuration of your device.

For information on printing, storing, and retrieving patient information acquired in AED Mode, see Chapter 9.

Figure 3-1 AED Mode Overview

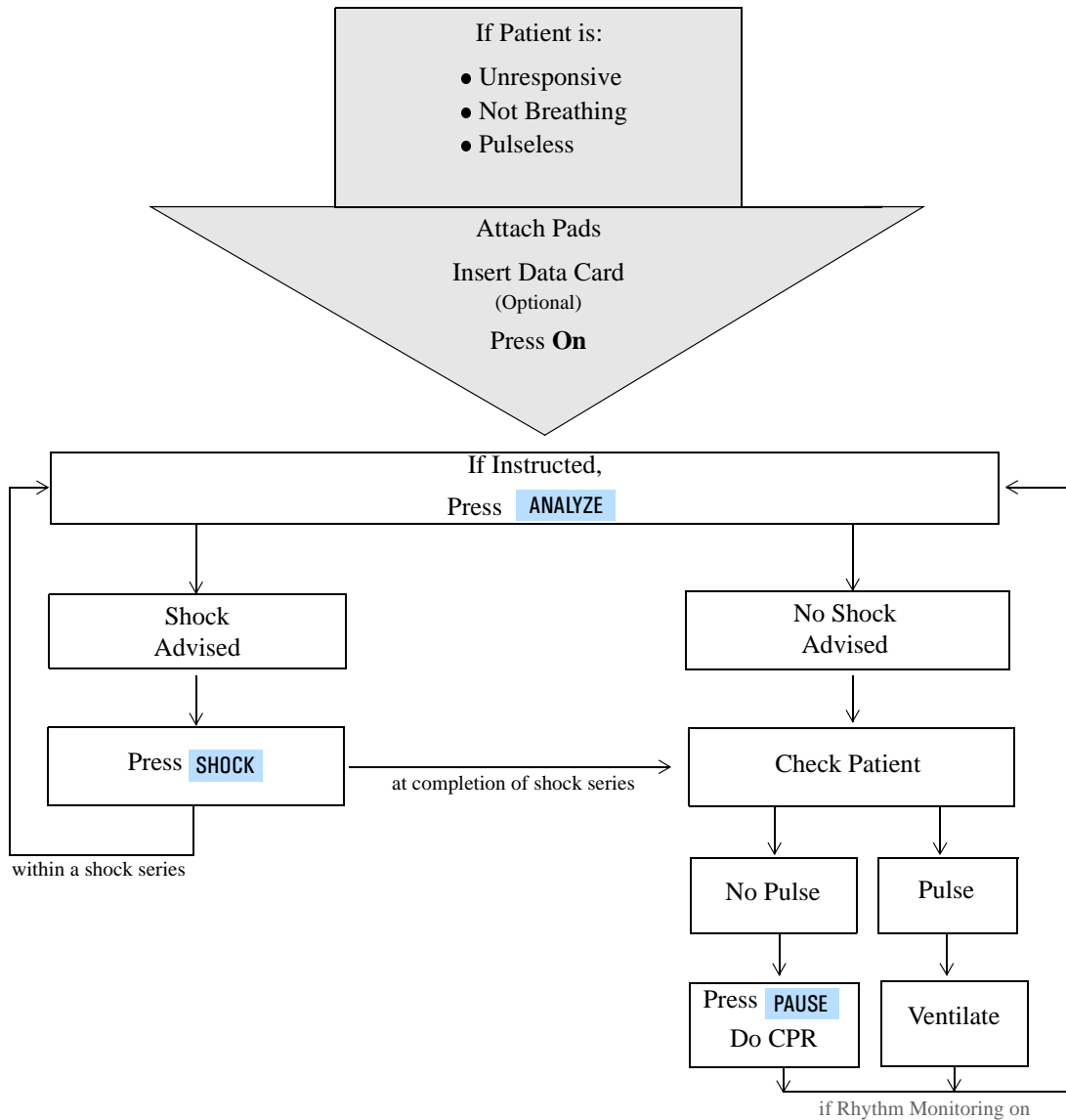

Overview

An overview of the AED Mode defibrillation process is shown in Figure 3-1.

The process begins only after you have:

- assessed that the patient is unresponsive, not breathing, and pulseless, and
- prepared for defibrillation by attaching pads and inserting a Data Card (if desired).

Then you are ready to turn the HeartStart XLT on. The defibrillation process is dependent upon the configuration of your HeartStart XLT, as described in the following paragraphs.

Defibrillation (with the default configuration)

In its default configuration, the defibrillation process is:

1 Press the **On** button.

The HeartStart XLT checks to see if the pads patient cable and multi-function defib electrode pads are properly connected. If either connection is compromised, you are prompted to fix the problem.

2 Analysis begins automatically - there is no need to press **ANALYZE**.

Once analysis is complete, the HeartStart XLT tells you **Shock Advised** or **No Shock Advised**.

3 If a shock is advised, press **SHOCK**.

After the first shock is delivered, the HeartStart XLT automatically begins analyzing the ECG and the process repeats until a shock series is complete or no shock is advised. At this point, you are prompted to check the patient.

Defibrillation (with a modified configuration)

Chapter 10 describes, in detail, the configurable parameters for AED Mode. Three parameters significantly impact the defibrillation process. They are:

Device Initiated Analysis - initiates ECG analysis when the HeartStart XLT is first turned on. The default configuration setting is **On**. If you choose to set this parameter to **Off**, you need to press **ANALYZE** to initiate analysis in step 2 of the defibrillation process.

Automatic Re-analysis - initiates ECG analysis in between shocks within a shock series. The default configuration setting is **On**. If you choose to set this parameter to **Off**, you need to press **ANALYZE** to initiate analysis in between shocks within a shock series (i.e. after the first and second shock of a three shock series).

Rhythm Monitoring - monitors the ECG for potentially shockable rhythms when the HeartStart XLT is not analyzing, defibrillating, or paused. The default setting is **On**. If you choose to set this parameter to **Off**, the HeartStart XLT will not look for potentially shockable rhythms during these idle times. Idle times also include:

- power on, when Device Initiated Analysis is off.
- in between shocks within a shock series, when Auto Re-analysis is off.

If Rhythm Monitoring is off, you need to observe the patient during idle times and determine when to press **ANALYZE**.

The following sections describe the defibrillation process in detail. They also describe what happens at the completion of a shock series and if a shockable rhythm is not detected.

Preparation

If the patient is:

- unresponsive
- not breathing
- pulseless

Then:

1. Apply multifunction defib electrode pads to the patient, as directed on the package. Use the anterior-anterior electrode placement.
2. Connect the pads to the pads patient cable, as shown in Figure 3-2.
3. If needed, insert a Data Card (as described in “Using a Data Card” on 2-11).

Figure 3-2 Connecting Pads to the Patient Cable

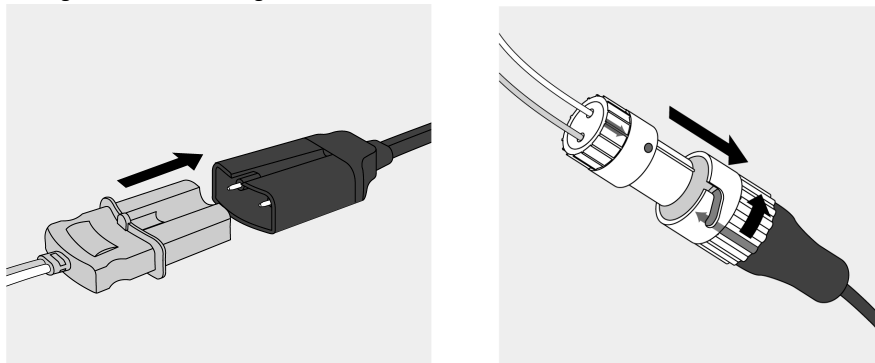

Defibrillating

Follow the voice and screen prompts as they guide you through the following steps:

1. Press On.

In this first step of the defibrillation process, the HeartStart XLT checks to see if the pads patient cable and the pads are connected. If they are, it proceeds to step 2.

If the pads patient cable is not properly attached, you are prompted to **Connect Pads Cable**.

Figure 3-3 Connect Pads Cable Display

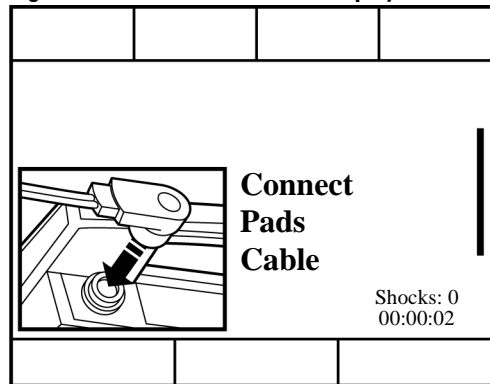

Once the cable is connected, the HeartStart XLT checks to make sure the pads are making good contact with the patient's skin. It does this by monitoring the electrical impedance between the two pads.

If the pads have not been applied or are not making proper contact with the patient, you are prompted to **Apply Pads** and **Check Connections**.

Figure 3-4 Apply Pads Display

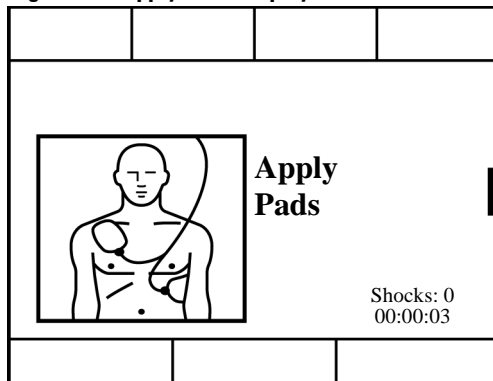

2. If instructed, press **ANALYZE.**

If device-initiated analysis is off, the HeartStart XLT monitors the rhythm (provided Rhythm Monitoring is on) and prompts you to press **ANALYZE** if a potentially shockable rhythm is detected.

Figure 3-5 Press ANALYZE Display

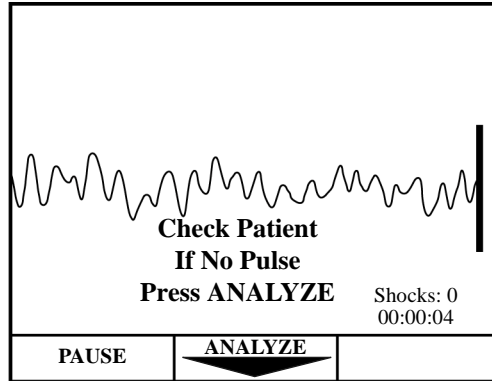

NOTE

If monitoring capabilities are enabled on your HeartStart XLT, your display will contain monitoring information not shown in the graphics in this section.

NOTE

ECG Analysis is always performed through multifunction defib electrode pads. Analysis can not be performed through monitoring electrodes.

If device initiated analysis is on, you do not need to press **ANALYZE**; ECG analysis begins automatically.

Figure 3-6 Analyzing Display

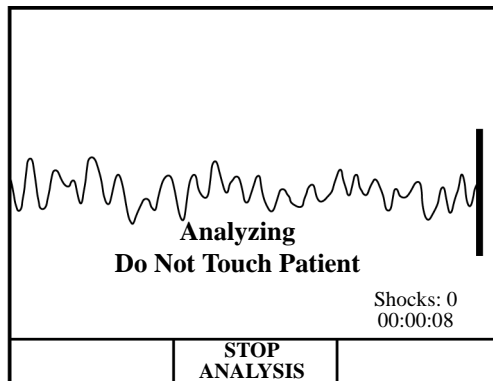

WARNING

Handling or transporting the patient during ECG analysis can cause incorrect or delayed diagnosis.

If a shockable rhythm is detected, as indicated by the message **Shock Advised**, analysis stops and the XLT automatically charges to 150J. Charging is accompanied by an intermittent charge tone.

Figure 3-7 Charging Display

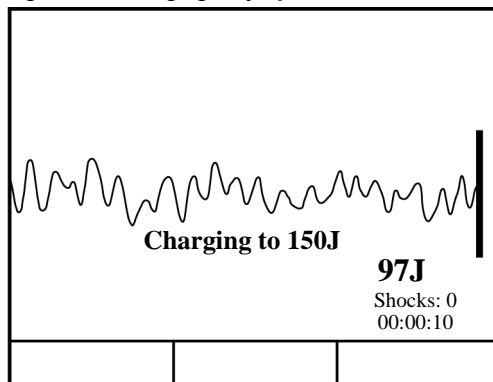

3. If shock advised, press **SHOCK**.

Once charging is complete, the charge tone becomes continuous. Make sure no one is touching the patient or anything connected to the patient. Call out "Clear." Then press **SHOCK** to deliver a shock to the patient.

Figure 3-8 Press SHOCK Display

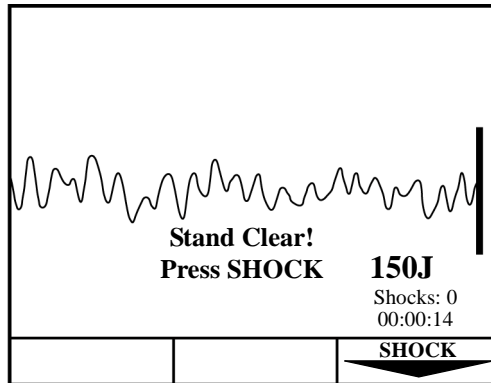

WARNING

Defibrillation current can cause operator or bystander injury. Do not touch the patient, or equipment connected to the patient, during defibrillation.

The defibrillator automatically disarms if you do not press **SHOCK** in 30 seconds.

Delivery of the shock is confirmed by the message **Shock Delivered** and the shock counter is updated.

Figure 3-9 Shock Delivered Display

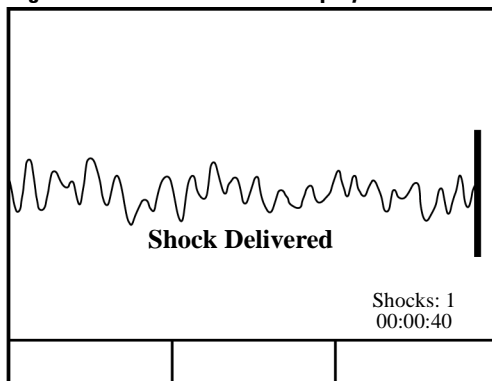

Automatic Re-analysis On

If Automatic Re-analysis is on, the HeartStart XLT analyzes the ECG following delivery of the shock. You are prompted to press **SHOCK**, if an additional shock is advised. This cycle repeats until the rhythm converts or a shock series is complete. (A shock series may be configured to 2, 3, or 4 shocks.)

Automatic Re-analysis Off

If Automatic Re-analysis is off, the HeartStart XLT monitors the ECG for potentially shockable rhythms (provided Rhythm Monitoring is on) and prompts you to press **ANALYZE** if one is detected. You can initiate analysis, without being prompted, by pressing **ANALYZE**.

Pausing for CPR

At the completion of a shock series or when no shock is advised, the Heart-Start XLT prompts you to **Check Patient, Check Pulse***. It allows eight seconds for you to check the pulse, then prompts you as follows:

Figure 3-10 Press Pause Display

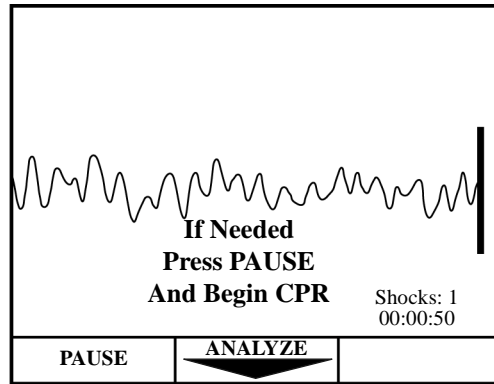

If CPR is needed, press **PAUSE**. While paused, the Pause Timer indicates the elapsed time and the total duration of the Pause state, in seconds. The Pause Timer is configurable to meet your local CPR protocol needs. Rhythm, SpO₂ and heart rate monitoring alarms are suspended for the duration of the pause.

NOTE

* This section describes how the Pause state functions using the default configuration. If your HeartStart XLT is configured to support the European Resuscitation Council Guidelines for Resuscitation, refer to the “ERC Protocol” section on page 3-16 for details.

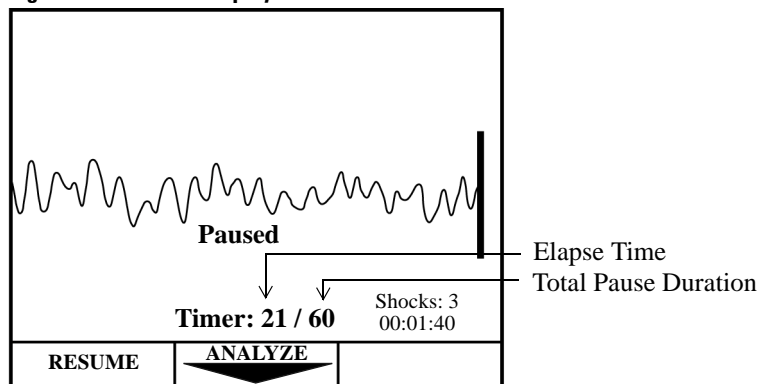
Figure 3-11 Pause Display

The pause state ends when the Pause Timer reaches the preconfigured Pause state duration, or if you press **RESUME** or **ANALYZE**. At the completion of the pause state, the defibrillation process begins again. If instructed, press **ANALYZE**.

If you do not press **PAUSE**, the HeartStart XLT begins monitoring the ECG rhythm (provided Rhythm Monitoring is on).

You may initiate ECG analysis at any time by pressing **ANALYZE**.

Monitoring Rhythm

When the HeartStart XLT is not analyzing, defibrillating, or paused, Rhythm Monitoring alerts you to potentially shockable rhythms (provided Rhythm Monitoring is set to the default configuration, **On**). The message **Monitoring Rhythm** appears on the display to let you know this feature is active and remains on the display for the duration of the monitoring.

Figure 3-12 Monitoring Rhythm Display

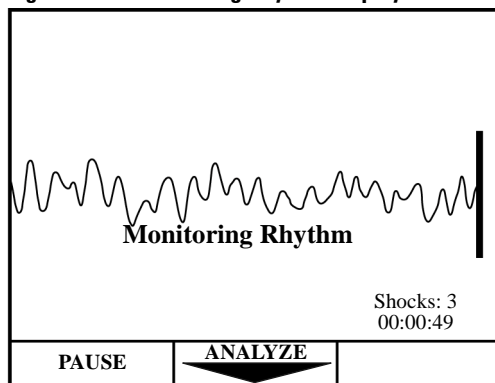

WARNING

The recommended configuration setting for Rhythm Monitoring is On. If Rhythm Monitoring is off, you are not alerted when a patient's rhythm changes from non-shockable to shockable (as in refrillation or an initially nonshockable rhythm that converts to a shockable rhythm).

If Rhythm Monitoring detects a shockable rhythm, you are prompted as follows:

Figure 3-13 Shockable Rhythm

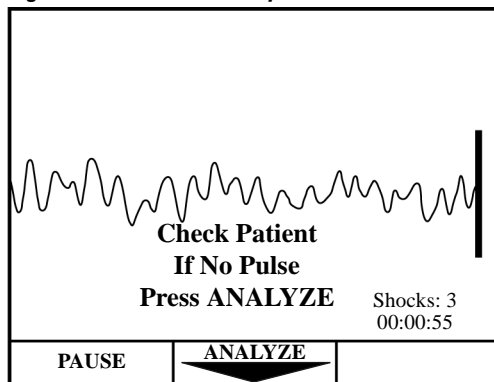

This prompt is repeated periodically, as configured, until **ANALYZE** or **PAUSE** is pressed. If you press **ANALYZE**, the defibrillation process starts again.

If you press **PAUSE**, rhythm monitoring is suspended for the duration of the pause. **PAUSE** is used when administering CPR, as noted earlier. It may also be useful when performing medical procedures or encountering artifact during patient transport. Active SpO₂ and heart rate alarms are suspended during the pause duration, as well.

Press **RESUME** to restore rhythm monitoring. Active SpO₂ and heart rate alarms are also restored.

ERC Protocol

The HeartStart XLT can be configured to support the European Resuscitation Council (ERC) Guidelines for Resuscitation (1998). If **European Protocol** is configured to **On**, the defibrillation process described in this chapter is the same, with the exception of how the Pause state functions (see “Pausing for CPR” on 3-12).

As described, you can enter a Pause state:

- at the completion of a shock series, or
- when no shock is advised

When either of these events occurs, the ERC protocol prompts you to Check Patient. Then it prompts you as follows:

Figure 3-14

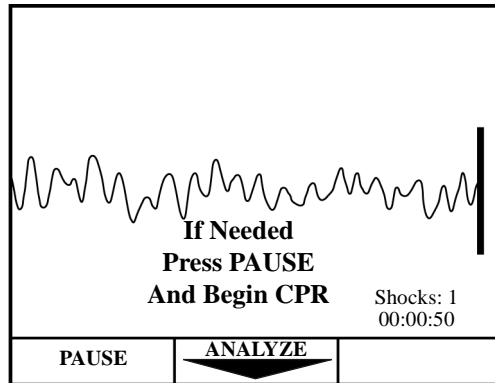

NOTE

Using the ERC protocol, you are not prompted to (or given time to) check the patient’s pulse.

If CPR is needed, press **PAUSE**. While paused, a timer indicates the elapsed time and the total duration of the Pause state, as shown:

Figure 3-15

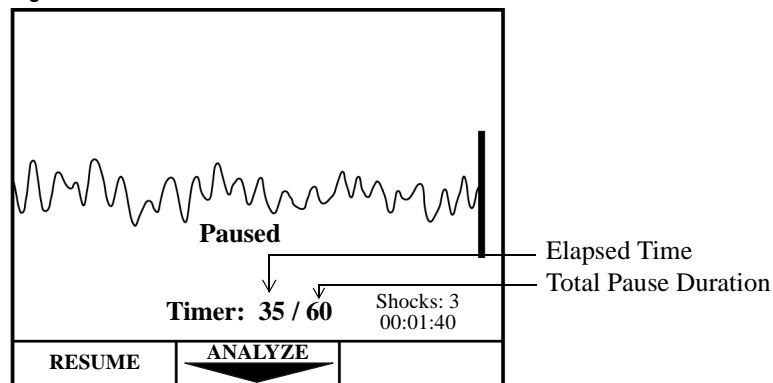

The total pause duration depends on the event preceding the Pause state. If you entered the Pause state:

- at the completion of a shock series or shortly after a shock is delivered, the duration is equal to the **Post Shock CPR Timer** configuration setting (the default setting is 60 seconds).
- when no shock was advised, the duration is equal to the "NSA" Timer configuration setting, where NSA is an acronym for No Shock Advised (the default setting is 180 seconds).

Troubleshooting

When the HeartStart XLT detects a problem, it provides display and/or voice prompts to guide you to resolution. The table below lists the prompts you may encounter in AED Mode, the cause, and the suggested corrective action. Prompts related to the battery and Data Card are discussed in Chapter 12.

Table 3-1 AED Mode Prompts

Prompt	Possible Cause	Corrective Action
Pads Off	The multifunction defib electrode pads are not properly applied to the patient.	Check that the pads are applied to the patient, as directed on the pads' package. Replace the pads if the prompt continues.
Pads Cable Off	The pads cable is not connected to the defibrillator.	Check that the defibrillation pads connector is locked in place.
Artifact Detected	<ul style="list-style-type: none"> • Patient motion interferes with analysis. • Electrical sources are causing interference. 	<ul style="list-style-type: none"> • Attempt to eliminate patient motion. Avoid analyzing during transport or while performing CPR. • Move hand-held communication devices or other suspected devices away from the defibrillator, when possible.
Shock Cancelled	Shock key not pressed within 30 seconds.	Press within 30 seconds of prompt.
No Shock Delivered	Pads are not properly connected to the patient.	Check pads connection.
Key Inactive	<ul style="list-style-type: none"> • The key pressed only functions in Manual Mode. • The key pressed does not function during analysis or charging. • The key pressed does not function while in a pause state. 	<ul style="list-style-type: none"> • Access manual mode prior to pressing the key. • Wait for analysis or charging to complete prior to pressing the key. • Press RESUME prior to pressing the key.

4 Monitoring the ECG

The HeartStart XLT can be used for short or long-term ECG monitoring. The ECG monitoring function allows you to monitor through:

- multifunction defib electrode pads, or
- 3- or 5-lead ECG monitoring electrodes, as configured.

When the HeartStart XLT is turned on, the ECG acquired through pads is shown on the display. ECG monitoring allows you to continue to monitor through the pads or to select a lead from an alternate ECG source (3- or 5-lead). ECG monitoring also displays the heart rate (HR) and allows you to set HR alarms.

ECG monitoring is always active in Manual Mode. In AED Mode, ECG monitoring is only active if **Lead Select** is configured to on (the default is off).

A fully charged battery provides approximately 2.7 hours of continuous monitoring.

This chapter describes how to apply monitoring electrodes, select the lead to monitor, and set a heart rate (HR) alarm. To apply multifunction defib electrode pads, follow the directions on the pads packaging. For information on printing, storing, and retrieving patient information acquired while monitoring, see Chapter 9.

NOTE

If you need to connect the ECG cable to the HeartStart XLT or configure the HeartStart XLT to use the optional 5-lead monitoring cable, see Chapter 10.

Applying Monitoring Electrodes

Proper application and placement of electrodes is essential for reliable monitoring. Good contact between the electrode and the skin reduces the effects of motion artifact and signal interference.

To apply electrodes:

1. Identify the appropriate electrode sites. (See Figure 4-1.)
2. Shave the electrode sites or clip hair, if necessary.
3. Clean and abrade the skin at the electrode sites.
4. Dry the skin at the electrode sites.
5. Open a new package of M2202A Radio-Translucent Monitoring Electrodes; verify that the "Use Before" date has not passed.
6. Snap the lead wires onto the electrodes.
7. Apply the electrodes by peeling them, one at a time, from the protective backing and sticking them firmly to the patient's skin. Press around the entire edge of each electrode to ensure that they are secure. Make sure the lead wires do not pull on the electrodes.

WARNING

Be sure that the electrodes do not come in contact with other conductive materials, especially when connecting or disconnecting the electrodes to/from the patient.

NOTE

If monitoring for long periods of time, new monitoring electrodes and multifunction defib electrode pads may need to be applied periodically. Refer to the manufacturer's documentation for how often to replace the monitoring electrodes or defib pads.

Electrode Placement

Figure 4-1 shows typical electrode placement for the limb leads of a 3- or 5-lead patient cable. The V/C lead of the 5-lead cable can be placed in any of the precordial lead positions (V1/C1 through V6/C6) shown in Figure 4-2.

Figure 4-1 Limb Lead Electrode Placement

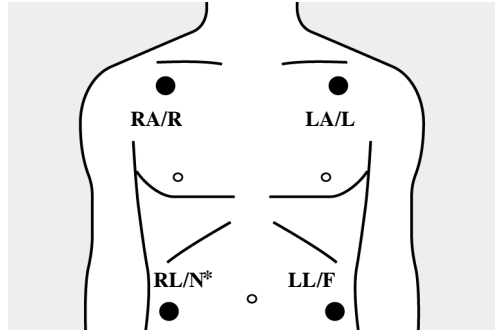

AHA Labels	IEC Labels
RA Right Arm	R Right
LA Left Arm	L Left
RL Right Leg*	N Negative*
LL Left Leg	F Foot

* Not used for 3-lead.

Table 4-1 3-Lead ECG Lead Formation

Lead	+	-	Reference
I	LA	RA	LL
II	LL	RA	LA
III	LL	LA	RA

Figure 4-2 Precordial Lead Electrode Placement

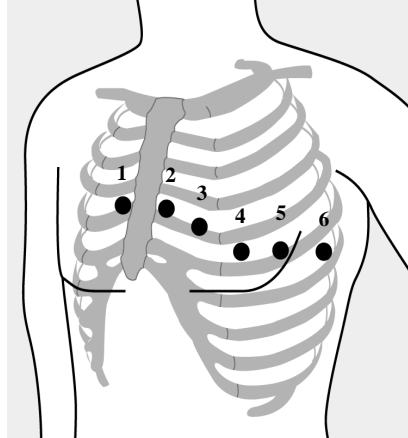

Electrode		Location
V1	C1	fourth intercostal space, at right sternal margin
V2	C2	fourth intercostal space, at left sternal margin
V3	C3	midway between V2/C2 and V4/C4
V4	C4	fifth intercostal space, at left midclavicular line
V5	C5	same level as V4/C4, on anterior axillary line
V6	C6	same level as V4/C4, at left mid axillary line

Table 4-2 5-Lead ECG Lead Formation

Lead	Lead Formation
I	LA - RA
II	LL - RA
III	LL - LA
aVR	$RA - \frac{LA + LL}{2}$
aVF	$LL - \frac{RA + LA}{2}$
aVL	$LA - \frac{RA + LL}{2}$
V _x (or C _x) where x = 1-6	$V/C - \frac{RA + LA + LL}{3}$

Selecting the Lead

Available monitoring leads are dependent upon your device configuration:

Table 4-3 Lead Select Choices

Lead Select Choices are:	If Configured for a:
Pads, Lead I, Lead II, Lead III	3-lead ECG cable
Pads, Lead I, Lead II, Lead III, aVR, aVL, aVF, V lead.	5-lead ECG cable

To select a lead to monitor, cycle through the choices by pressing **LEAD SELECT** until the desired lead is displayed.

NOTE

When V lead is selected, change to a different V lead by moving the electrode to a new location rather than by pressing the **LEAD SELECT** softkey.

Figure 4-3 ECG Monitoring Display

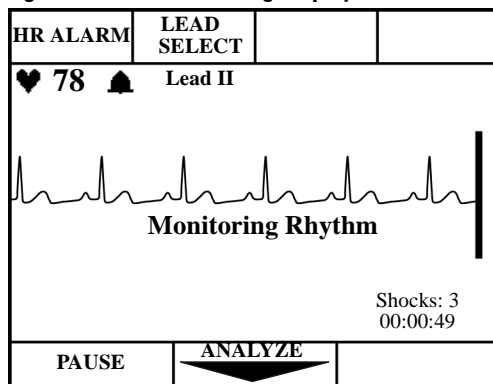

If the desired lead is not connected or the electrodes are not making proper contact with the patient, the message **Leads Off** is displayed in the System Message Area and accompanied by a beep to alert you. A dashed line on the display indicates that there is no ECG signal.



Setting the Heart Rate Alarm

The computed heart rate (number of detected QRS complexes per minute) is displayed below the **HR ALARM** sofkey, next to the . The heart rate represents the number of QRS complexes detected in a minute. A QRS beeper, if configured to on, indicates each QRS complex detected.

If desired, a HR alarm may be set to alert you when the heart rate is outside the specified limits. Limit choices are listed in Table 4-4.

Table 4-4 HR Alarm Limit Choices

Alarm If Over:	Or under:
100	30
140	60
160	90
200	120

To set a HR alarm, cycle through the limit choices by pressing **HR ALARM** until the desired limits are shown. The  then appears next to the heart rate value to indicate that the HR alarm is set.

WARNING

Heart rate alarms are temporarily suspended in AED Mode during ECG analysis or when **PAUSE is pressed (for the duration of the paused period). Heart rate alarms are also suspended while charging for defibrillation and delivering a shock.**

WARNING

Heart rate displays and alarms function with internal and external pacemakers, but they can be unreliable. Observe the patient closely if pacemakers are used.

Disabling the HR Alarm

If the heart rate is outside the HR alarm limits, an alarm sounds. To disable the alarm, press **HR ALARM**.  appears to indicate that the alarm is disabled.

Adjusting the ECG Size

To increase or decrease the size of the ECG, press **▲** or **▼** on the gain control, .

Troubleshooting

Table 4-5 provides troubleshooting tips for ECG Monitoring.

Table 4-5 Troubleshooting Tips

Situation	Cause	Solution
Leads Off message or dashed line (-----)	<ul style="list-style-type: none"> The monitoring electrodes are not applied or are not making proper contact with the patient. The monitoring cable is not connected. 	<ul style="list-style-type: none"> Check that the monitoring electrodes are properly applied. Check that the monitoring cable is properly connected.
Pads Off message	<ul style="list-style-type: none"> The pads are not making proper contact with the patient. 	<ul style="list-style-type: none"> Check that the pads are properly applied.

Table 4-5 Troubleshooting Tips (Continued)

Situation	Cause	Solution
<p>Poor ECG signal quality</p>	<ul style="list-style-type: none"> ● The monitoring electrodes are not making proper contact with the patient. ● The monitoring electrodes are outdated or dried-out. ● Radio frequency interference (RFI) is causing artifact. 	<ul style="list-style-type: none"> ● Check that the monitoring electrodes are properly applied. If necessary, prepare the patient's skin and apply new electrodes. ● Check the date code on the electrodes. Do not open the electrode package until immediately prior to use. ● Relocate or turn off equipment that may be causing RFI.
<p>QRS beeper inaudible or beeps do not occur with each QRS complex.</p>	<ul style="list-style-type: none"> ● The QRS beeper is configured to Off. ● The amplitude of the QRS complex is too small to detect. 	<ul style="list-style-type: none"> ● Check that the QRS beeper is configured to On. ● Adjust the volume. ● Adjust the size of the ECG.

5 Monitoring SpO₂

Pulse oximetry is a noninvasive method of continuously measuring oxygen saturation (SpO₂) in arterial blood. The resultant SpO₂ reading indicates the percentage of hemoglobin molecules in the arterial blood which are saturated with oxygen. SpO₂ monitoring is one of the tools available to assist in assessing a patient's cardiac and respiratory systems. This chapter explains how pulse oximetry works and describes how to use the HeartStart XLT to monitor SpO₂.

SpO₂ monitoring is always available in Manual Mode (if the option is purchased). In AED Mode, SpO₂ monitoring is only available if SpO₂ is configured to On.

For information on printing, storing, and retrieving patient information acquired while monitoring, see Chapter 9.

WARNING

Do not rely solely on SpO₂ readings; assess the patient at all times. SpO₂ readings may be inaccurate in the presence of significant levels of carboxyhemoglobin or methemoglobin, in patients with restricted blood flow to the extremities (such as those in severe shock or hypothermia), or in the presence of excessive motion.

Understanding Pulse Oximetry

A pulse oximetry sensor sends light through patient tissue to a receiver on the other side of the sensor. As Figure 5-1 shows, light emitting diodes transmit red and infrared light through peripheral areas of the body, such as a finger.

Figure 5-1 Pulse Oximetry Sensor

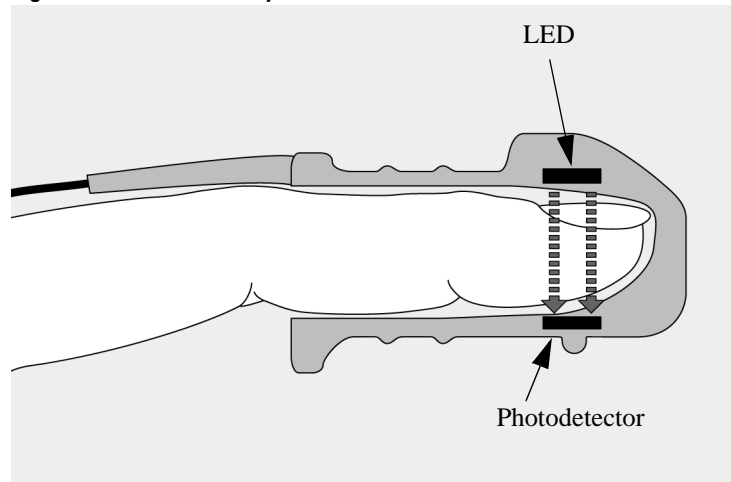

A photodetector positioned opposite the light emitting diodes compares light absorption before and after pulsation. The amount of light getting through reflects the blood flow in the arterioles. This measurement of light absorption during pulsation is translated into an oxygen saturation percentage and an SpO₂ value is displayed.

For accurate SpO₂ measurements, the following conditions must apply:

- The patient must have perfusion in that extremity.
- The light emitter and the photodetector must be directly opposite each other.
- All of the light from the emitter must pass through the patient's tissue.
- The sensor site should be free of vibration and excessive motion.
- Power cables should be kept away from the sensor cable and connector.

Selecting a Sensor

Table 5-1 shows the SpO₂ sensors that may be used with the HeartStart XLT.

Table 5-1 Approved Sensors

Sensor	Type	Patient	Patient Size	Ideal Site
M1191A	Reusable	Adult	> 50 kg	Finger
M1192A	Reusable	Small adult Pediatric	15-50 kg	Finger
M1194A	Reusable	Pediatric Adult	> 40 kg	Fleshy part of ear
M1903A/B (Nellcor D-20)	Disposable	Pediatric	10-50 kg	Toe/Finger
M1904A/B (Nellcor D-25)	Disposable	Adult	> 30 kg	Finger
M1906A (Nellcor P/I)	Semi-reus- able	Pediatric Infant	3-40 kg	Finger/Toe
M1907A (Nellcor A/N)	Semi-reus- able	Neonate	< 3 kg	Foot/Hand
		Adult	> 40 kg	Finger

NOTE

To use Nellcor sensors, you must connect the M1943A Nellcor Adaptor patient cable to the HeartStart XLT. (See “Connecting the SpO₂ Patient Cable” on page 10-5.)

The most important factor when selecting a sensor is the position of the light emitting diodes in relation to the photodetector; when a sensor is applied, the diodes and the photodetector must be opposite each other. Sensors are designed for patients within a specific weight range and for specific sites. Be sure to:

- Select a sensor appropriate for the patient's weight.
- Select a sensor site with adequate perfusion.
- Avoid application to sites with edematous tissue.

Reusable Sensors

Reusable sensors may be reused on different patients after they have been cleaned and disinfected (see the manufacturer's instructions supplied with the sensor).

Disposable Sensors

Disposable sensors should be used only once and then discarded. They can be relocated to a different application site on the patient if the first location does not give the desired results. Disposable sensors must not be reused on different patients.

Semi-disposable Sensors

Semi-disposable sensors can be reused, but the adhesive wrap must be discarded after each use. Semi-disposable sensors are recommended for single-patient use only.

Applying the Sensor

Follow the manufacturer's directions for applying and using the sensor, making sure to observe any warnings or cautions. For the best results:

- Make sure the sensor is dry.
- If the patient is moving, secure the sensor cable loosely to the patient.
- Avoid excessive pressure at the sensor site; ensure that circulation is not obstructed.
- Keep power cables away from the sensor cable and connection.
- Avoid placing the sensor in an environment with bright lights (if necessary, cover the sensor with opaque material).
- Avoid placing the sensor on any extremity with an arterial catheter, blood pressure cuff, or intravascular venous infusion line.

WARNING

Failure to apply the sensor properly may reduce the accuracy of the SpO₂ measurement.

WARNING

Inspect the sensor application site at least every two hours for changes in skin quality, correct optical alignment, and proper sensor application. If skin quality is compromised, change the sensor site. More frequent checking may be required due to an individual patient's condition.

Connecting the Sensor Cable

To connect a sensor cable:

1. Hold the connector with the flat side up so that the part number is visible.
2. Insert the connector into the receptacle and push until the blue portion of the connector is no longer visible.

Figure 5-2 Connecting the Sensor Cable

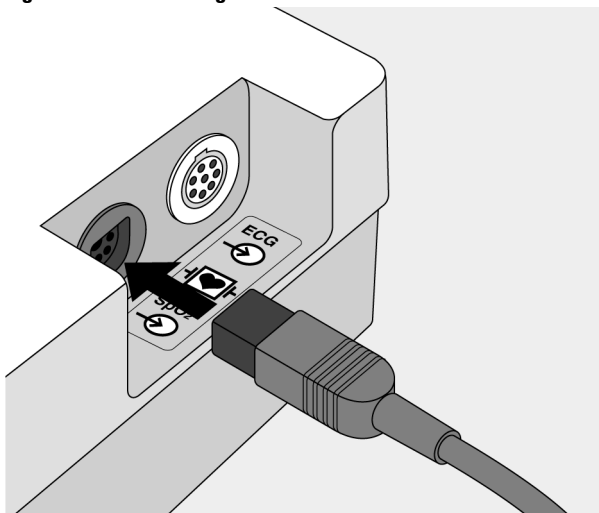

Monitoring

To monitor SpO₂:

1. If the HeartStart XLT is not on, press **On**.
2. Apply the appropriate sensor to the patient.
3. Make sure the sensor cable is connected to the HeartStart XLT.
4. Press **SpO₂** to turn on SpO₂ monitoring.

A dashed line (---) is displayed under **SpO₂**, while the oxygen saturation is measured and an SpO₂ value is calculated. In a few seconds the SpO₂ value is displayed in place of the dashed line. As the patient's oxygen saturation changes, the SpO₂ value is updated continuously.

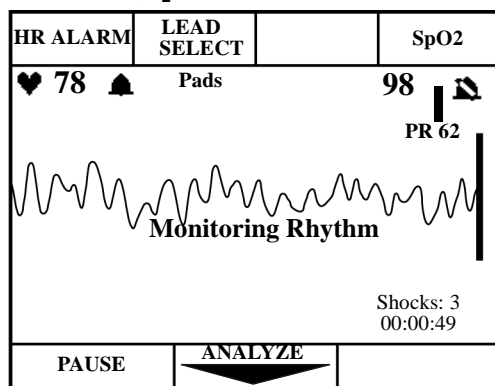

Figure 5-3 SpO₂ Monitoring Display



To the right of the SpO₂ value, a pleth bar and SpO₂ alarm indicator are displayed. The pleth bar should be observed for fluctuation. It is an indication of pulsation detected by the sensor. The pleth bar should not be used as the sole indicator of pulsation because it can be influenced by movement and artifact. The  symbol indicates no alarm is set.

Below the SpO₂ value is the pulse rate derived from the pulse oximetry.

Setting Alarms

An alarm may be set to alert you if the SpO₂ value falls below a specified lower limit. Lower limit alarm choices are  (no alarm), 90, 85, or 80. Press **SpO₂** repeatedly to cycle through the choices. Stop when the desired choice is displayed. A  appears in three seconds, indicating that the selected alarm is active. To review the alarm limit, press **SpO₂**.

WARNING

SpO₂ alarms are temporarily suspended in AED Mode during ECG analysis or when PAUSE is pressed (for the duration of the paused period). SpO₂ alarms are also suspended while charging for defibrillation and delivering a shock.

Responding to an Alarm

When the SpO₂ value falls below the alarm limit, a continuous tone alerts you and the SpO₂ value is displayed in inverse video.

Figure 5-4 SpO₂ Alarm Triggered

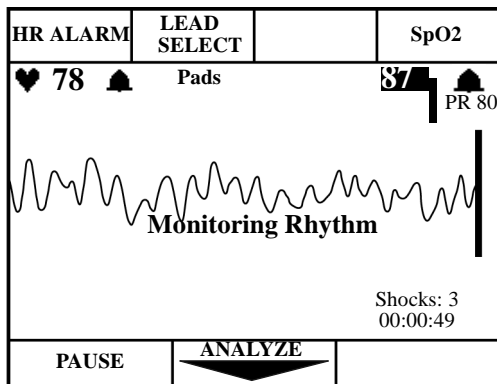

Press **SpO₂** to turn off the alarm. Refer to “Setting Alarms” if subsequent alarms are desired.

Discontinuing SpO₂ Monitoring

To shut off SpO₂ monitoring, press **SpO₂** repeatedly until nothing appears below the **SpO₂** softkey.

Figure 5-5 SpO₂ Monitoring Off

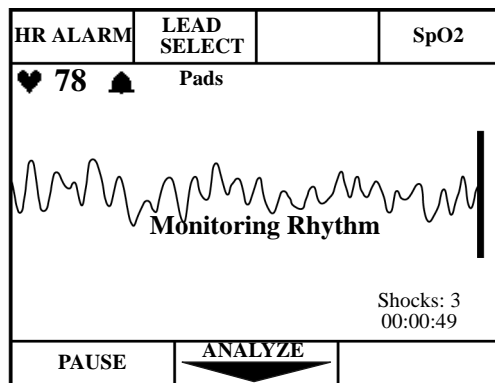

Caring for Sensors

Refer to the manufacturers instructions for care and cleaning of sensors. To get the best results from your SpO₂ reusable sensors, always handle the sensor and cable with care and protect them from sharp objects. The sensor sleeve houses a sensitive electronic device that can be damaged. Harsh treatment of sensors will drastically reduce their lifetime.

WARNING

Do not use a damaged sensor or one with exposed electrical circuits.

Troubleshooting

The table below lists system messages that you may encounter when monitoring SpO₂.

Table 5-2 System Messages

Problem or Message	Possible Cause	Corrective Action
SpO ₂ Non Pulsatile	<ul style="list-style-type: none"> ● Pulse absent or too weak to be detected. 	<ul style="list-style-type: none"> ● Check the sensor is applied properly. ● Make sure the sensor site has a pulse. ● Relocate the sensor to a site with improved circulation. ● Try another sensor type.
SpO ₂ Low Signal	<ul style="list-style-type: none"> ● SpO₂ signal is too low to give an accurate reading. 	<ul style="list-style-type: none"> ● Check the sensor is applied properly. ● Try another sensor type.
SpO ₂ Noisy Signal	<ul style="list-style-type: none"> ● Excessive patient movement, electrical interference, or optical interference. 	<ul style="list-style-type: none"> ● Minimize patient motion or apply sensor to site with less movement. ● Secure the sensor cable loosely to the patient. ● Reduce sources of electrical or optical interference.
SpO ₂ Light Interf	<ul style="list-style-type: none"> ● The level of ambient light is so high that the sensor cannot obtain an SpO₂ reading. ● Sensor or cable is damaged. 	<ul style="list-style-type: none"> ● Cover sensor with an opaque material. ● Check sensor for damage; try another sensor.

Table 5-2 System Messages (Continued)

Problem or Message	Possible Cause	Corrective Action
SpO2Cable Off	<ul style="list-style-type: none"> • The SpO₂ cable is not connected to the device. 	<ul style="list-style-type: none"> • Attach the cable to the HeartStart XLT.
SpO2 Sensor Fail	<ul style="list-style-type: none"> • The transducer is broken. 	<ul style="list-style-type: none"> • Apply a new transducer.
SpO2Failure	<ul style="list-style-type: none"> • There is a hardware failure in the SpO₂ sub-system. 	<ul style="list-style-type: none"> • Remove device from active use and call for service.

6 Defibrillating in Manual Mode

In Manual Mode you assess the ECG, decide if defibrillation is indicated, select the discharge energy level, and deliver the shock. The defibrillation process is under your control. There are no voice prompts, however, system and momentary messages provide relevant information throughout the process. It is important to be attentive to these messages.

This chapter describes how to access Manual Mode and use it for defibrillation. For Manual Mode features such as synchronized cardioversion and pacing, see the “Performing Synchronized Cardioversion” and “Pacing” chapters. For information on printing, storing, and retrieving patient information acquired in Manual Mode, see Chapter 9.

Enabling Manual Mode

From AED Mode, press **Manual** to enable Manual Mode. If prompted, use the softkeys above the display to enter the password.

Figure 6-1: Manual Password Display

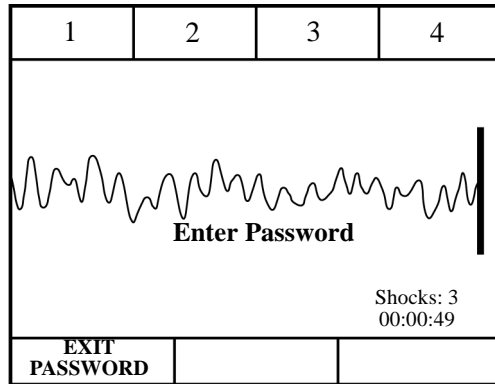

To return to AED Mode, without entering a password, press **EXIT PASSWORD**.

Once Manual Mode is enabled, the green LED next to **Manual** is lit.

In its default configuration, the HeartStart XLT powers on into AED Mode. If you prefer, you can configure it to power on into Manual Mode. You have the option to require users to enter a password in order to enable Manual Mode from AED Mode. (See “Configuring the HeartStart XLT” on page 10-7.

WARNING

Use of a password for Manual Mode is recommended as a safety measure to deter untrained personnel from entering Manual Mode.

Preparation

In preparation for defibrillation:

1. Apply multifunction defib electrode pads as directed on the package. Use either the anterior-anterior or anterior-posterior electrode placement, as appropriate.
2. Connect the pads to the pads patient cable, as shown in Figure 6-2.
3. If needed, insert a Data Card (as described in “Using a Data Card” on 2-11).
4. Press **On**.
5. Enter Manual Mode, if AED Mode is active.

Figure 6-2 Connecting Pads to the Patient Cable

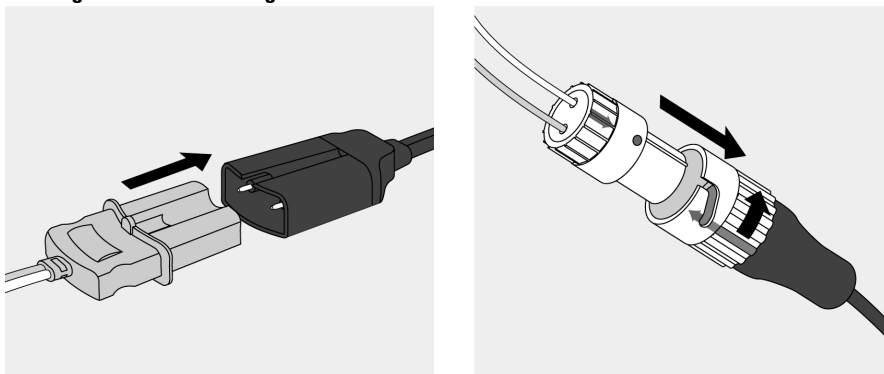

NOTE

Defibrillation is always performed through pads. However, during defibrillation, you may choose to monitor ECG using an alternate ECG source (3- or 5-lead monitoring electrodes).

Defibrillating

The defibrillation process is as follows:

1. Select Energy

The default energy setting is 150 joules. To change the energy setting, press **ENERGY SELECT** repeatedly to cycle through the energy level choices. Stop when the desired energy is displayed. The choices are 5, 10, 25, 50, 70, 100, 150, or 200 joules.

Figure 6-3 Energy Select Display

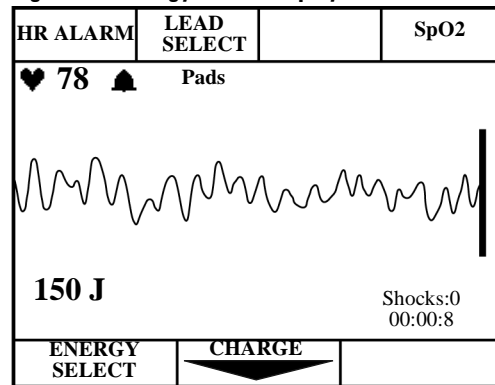

2. Charge

Press **CHARGE**.

As the defibrillator charges, the current charge is displayed above the shock counter. A charging tone beeps until the desired energy level is reached, at which point you'll hear a continuous charge tone.

Figure 6-4 Charging Display

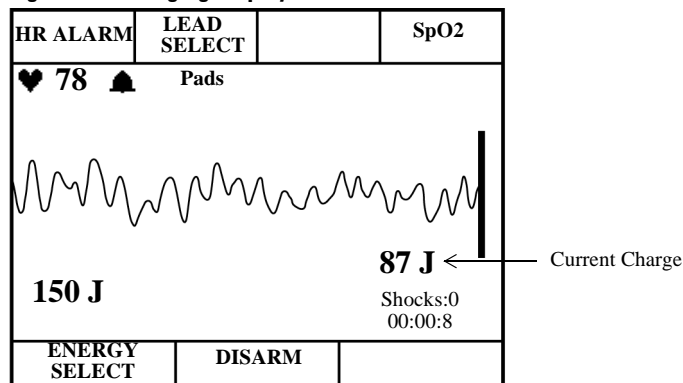

If desired, you may increase or decrease the selected energy level after pressing the **CHARGE** button. To do so, press **ENERGY SELECT** repeatedly until the desired energy level is displayed. The defibrillator charges to the selected energy automatically. Wait until the current charge reaches the selected energy level before proceeding.

3. Shock

Confirm that a shock is still indicated. Make sure no one is touching the patient or anything connected to the patient. Call out “Clear.” Then press **SHOCK** to deliver a shock to the patient.

To disarm the defibrillator, press **DISARM**. If **SHOCK** is not pressed in 30 seconds, the defibrillator disarms automatically.

If additional shocks are indicated, repeat the defibrillation process

WARNING

Defibrillation current can cause operator or bystander injury. Do not touch the patient, or equipment connected to the patient, during defibrillation.

Returning to AED Mode

To enable AED Mode, from Manual Mode, press **Manual**. The green LED next to **Manual** goes out, indicating Manual Mode is no longer active. If ECG and/or SpO₂ monitoring are enabled in AED Mode, alarms set in Manual Mode remain active when you switch to AED Mode.

7 Performing Synchronized Cardioversion

Synchronized cardioversion is a Manual Mode function that allows you to synchronize the defibrillator shock with the R-wave of the ECG being monitored.

During synchronized cardioversion, the ECG being monitored is shown on the display and may be derived from:

- the multifunction defib electrode pads, or
- the 3- or 5-lead monitoring electrodes.

When selecting a lead, choose the best lead that displays a large QRS complex. The synchronized shock is delivered through the multifunction defib electrode pads, regardless of the lead being monitored.

This chapter describes how to perform synchronized cardioversion with the HeartStart XLT.

NOTE

See Chapter 4, “Monitoring the ECG” for information on how to apply electrodes and select a lead.

Preparing for Synchronized Cardioversion

In preparation for synchronized cardioversion:

1. Apply multifunction defib electrode pads as directed on the package. Use either the anterior-anterior or anterior-posterior placement, as appropriate.
2. Connect the pads to the patient cable. (See Figure 6-2.)
3. Apply monitoring electrodes, if desired. (See “Applying Monitoring Electrodes” on page 4-2.)
4. If needed, insert a Data Card (as described in “Using a Data Card” on 2-11).
5. Press **On**.
6. Enable Manual Mode. (See “Enabling Manual Mode” on page 6-2.)
7. Use **LEAD SELECT** to select the best lead that displays a large QRS complex. (See “Selecting the Lead” on page 4-5.)

Delivering a Synchronized Shock

To perform synchronized cardioversion:

1. Press **Sync** to enable Sync Mode. The green LED next to **Sync** lights up and the message **SYNC** appears on the display.
2. Use the gain control, , to adjust the ECG size so that the marker dot appears only once with each R-wave.
3. If necessary, change the energy setting (the default setting is 150 joules), by pressing **ENERGY SELECT** repeatedly until the desired energy level is displayed. The choices are 5, 10, 25, 50, 70, 100, 150, or 200 joules.
4. Press **CHARGE**. Wait until the current charge has reached the energy level selected and you hear a continuous charge done tone.

Figure 7-1: Charging in Sync Mode



If desired, you may increase or decrease the selected energy level after pressing **CHARGE**, by pressing **ENERGY SELECT** repeatedly until the desired energy level is displayed. The defibrillator charges to the modified energy level automatically. Wait until the current charge reaches the selected energy level before proceeding.

5. Make sure no one is touching the patient or anything connected to the patient. Call out “Clear.” Then press **SHOCK** and continue to hold **SHOCK** down until the shock is delivered.

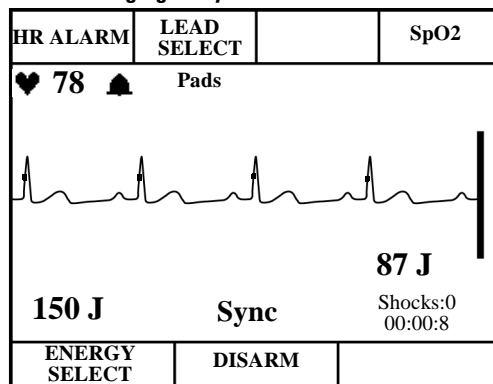
The defibrillator shocks with the next detected R-wave.

WARNING

Defibrillation current can cause operator or bystander injury. Do not touch the patient, or equipment connected to the patient, during defibrillation.



Delivering Additional Synchronized Shocks

If additional synchronized shocks are indicated, make sure Sync Mode is still enabled and repeat steps 2-5. In its default configuration, the HeartStart XLT remains in Sync Mode after a shock is delivered, as indicated by the message

Sync on the display and the lighted green LED next to .

The HeartStart XLT can be configured to exit Sync Mode after each shock is delivered.

Disabling Sync Mode

To disable Sync Mode, press . The green LED next to  goes out and the message Sync is no longer displayed. Sync Mode is also disabled when you exit Manual Mode.

8 Pacing

Noninvasive transcutaneous pacing is a Manual Mode function that is used to deliver paced pulses to the heart. Paced pulses are delivered through multi-function defib electrode pads applied to the patient's bare chest.

This chapter explains the pacing options and describes how to perform pacing.

Demand Mode Versus Fixed Mode

The HeartStart XLT can deliver paced pulses in either demand or fixed mode.

In **demand mode**, the pacer only delivers paced pulses when the patient's heart rate is lower than the selected pacing rate.

In **fixed mode**, the pacer delivers paced pulses at the selected rate.

Monitoring During Pacing

Multifunction defib electrodes pads can not be used to monitor the ECG and deliver paced pulses simultaneously. The HeartStart XLT always uses the 3- or 5-lead ECG cable and monitoring electrodes as the source of ECG during pacing.

In **demand mode**, ECG electrodes must be used, because the HeartStart XLT uses the R-wave detection from this monitoring source to determine if a paced pulse should be delivered.

In **fixed mode**, ECG electrodes may or may not be used; however, an ECG will only be displayed if ECG monitoring electrodes are used.

WARNING

Use demand mode pacing whenever possible. Use fixed mode pacing when motion artifact or other ECG noise makes R-wave detection unreliable.

WARNING

Heart rate displays and alarms function during pacing, but they can be unreliable. Observe the patient closely while pacing. Do not rely on heart rate alarms or the indicated heart rate as a measure of the patient's perfusion status.

Preparing for Pacing

In preparation for pacing:

1. Apply multifunction defib electrode pads as directed on the package. Use either the anterior-anterior or anterior-posterior placement, as appropriate.
2. Connect the pads to the patient cable. (See Figure 6-2.)
3. If needed, insert a Data Card (as described in “Using a Data Card” on 2-11).
4. Press **On**.
5. Enable Manual Mode. (See “Enabling Manual Mode” on page 6-2.)

In addition, for **demand mode** pacing:

1. Apply monitoring electrodes. (See “Applying Monitoring Electrodes” on page 4-2.)
2. Use **LEAD SELECT** to select the best lead with an easily detectable R-wave (See “Selecting the Lead” on page 4-5.) If you do not select a lead (i.e. pads is the selected ECG source), **Lead I** is automatically selected when the pacing function is turned on.

NOTE

If pacing for long periods of time, new monitoring electrodes and multifunction defib electrode pads may need to be applied periodically. Refer to the manufacturer’s documentation for how often to change monitoring electrodes or defib pads.

Pacing

To perform pacing:

1. Press **Pacer**. The green LED next to **Pacer** lights up and the dialogue box appears.

Figure 8-1 Pacing Display

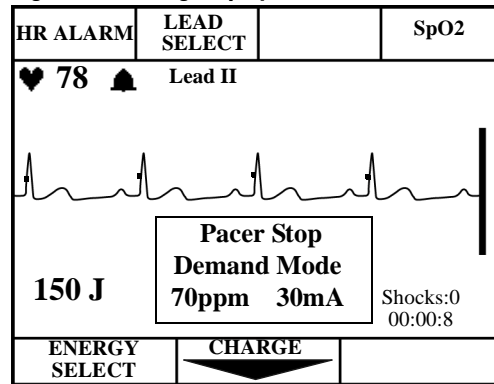

The message **Stop** indicates that the pacing function is on but paced pulses are not being delivered. The pacer turns on in the mode last used.

2. Verify that the dot markers appears near the middle of the QRS complexes of the ECG.

If the dot markers do not appear, or are in the wrong location, adjust the ECG size or select another lead. (See “Monitoring the ECG” in Chapter 4.)

The ECG will only appear if the 3- or 5-lead monitoring cable and electrodes are used.

3. Press **Mode** to change to fixed mode, if R-wave detection is unreliable.

The pacing dialogue box displays the current mode. To switch back to demand mode, press **Mode** again.

4. Adjust the rate to the desired number of paced pulses per minute (ppm).
Press up, ▲, or down, ▼, on **Rate** to increase or decrease the number of paced pulses per minute.
5. Press **Start/Stop** to start pacing.

The message **Pacing** indicates that paced pulses are being delivered in the selected mode at the rate and output level displayed.

Figure 8-2: Pacing Display

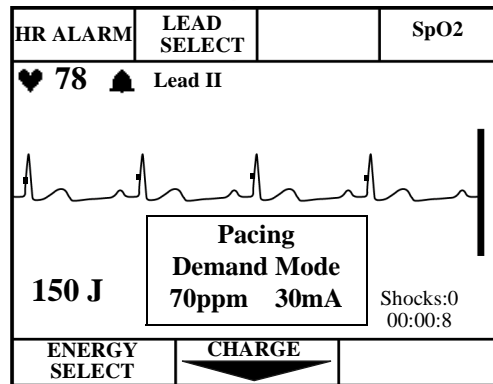

NOTE

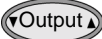

Pacing will not start if there is a problem with the multifunction defib electrode pads connections or, in demand mode, a problem with the ECG monitoring electrodes connections. Should a problem exist, a system message is displayed. Be attentive to system messages.

6. Increase the output until cardiac capture occurs.

Press up ▲ on  to increase the output in increments of 10 mA.



7. Decrease the output to the lowest level that still maintains capture.

Press ▼ on  to decrease the output in increments of 5 mA.

Press  to stop pacing. Press  to exit the pacing function. The green LED next to the button goes out, indicating pacing is no longer active.

Changing Pacing Modes

If paced pulses are being delivered, you must stop pacing before changing the pacing mode:

1. Press  to stop pacing.
 2. Press  to change the mode.
 3. Adjust the rate, if needed.
 4. Press  to resume pacing.
 5. Adjust the output, as needed to obtain capture.
-

Defibrillating During Pacing

If the patient must be defibrillated during pacing, follow the procedure for defibrillating in Manual Mode on page 6-4.

Pacing is automatically turned off when you charge the defibrillator and the pacing dialogue box is removed from the display. After a shock, pacing remains off.

To resume pacing, refer to “Pacing” on page 8-4. When you resume, the rate, mode, and output settings start at the settings selected prior to defibrillation.

Troubleshooting

The table below lists the pacing-related system and momentary messages that you may encounter during pacing.

Table 8-1 Pacing System Messages

Message	Possible Cause	Corrective Action
Leads Off	<ul style="list-style-type: none"> The selected monitoring lead is not making proper contact with the patient. Pacing was attempted in demand mode without monitoring electrodes attached. 	<ul style="list-style-type: none"> Check that the monitoring electrodes are properly applied. Check that the monitoring cable and electrodes are properly connected.
Pacer Failure	The pacing system is not functioning.	Remove the device from active use and call for service.
Pacer Output Low	High patient impedance is resulting in the delivery of less current to the patient than specified in the output current setting.	Check that the pads are applied properly.
Stop Pacer	Mode is pressed while paced pulses are being delivered.	Stop pacing before changing the pacing mode.
Key Inactive	Pacer , or one of the other pacing function keys, is pressed when Manual Mode is not active.	Make sure Manual Mode is active before pressing Pacer or one of the other pacing function keys.

9 Storing, Retrieving & Printing

This chapter describes how the HeartStart XLT creates a patient record, called an Event Summary, for later retrieval and printing. It covers how to mark events for storage in the Event Summary, as well as how to print individual events as they occur.

Overview

The HeartStart XLT automatically creates an Event Summary for each patient. The Event Summary is stored in the HeartStart XLT's internal memory and on a Data Card (if one is used).

The internal Event Summary stores up to 300 pieces of critical information, called events, and 50 ECG strips (11 seconds each). Events include things such as charging, shocks, and alarm violations. In addition, you trigger an event each time you press **Mark Event** or **Print Strip**.

Storage on a Data Card is limited only by available space on the card. In addition to storing all of the events that occur, a continuous copy of the displayed ECG and Patient Contact Impedance is also stored.

You can print the internal Event Summary at any time. You can also configure the HeartStart XLT to print individual events automatically as they occur and, of course, you can activate printing of individual events and patient information, at any time, by pressing **Print Summary**.

To print the Event Summary stored on the Data Card, the information must first be downloaded to the HeartStart Event Review Data Management system. Refer to the *HeartStart Event Review Instructions for Use* for instructions.

Marking Events

The **Mark Event** button allows you to annotate the ECG strip at the point in time the button is pressed. In AED Mode, when monitoring is disabled, the event is marked with a ▲. In Manual Mode, or when monitoring is enabled in AED Mode, you use the softkeys to select the annotation from the choices displayed (See Figure 9-1)*. If no selection is made, the event is marked with a ▲.

Figure 9-1 Annotations

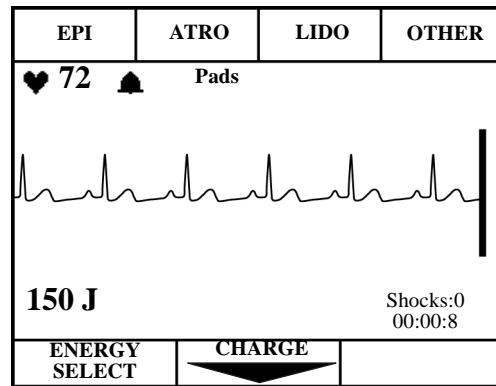

NOTE

*In Australia and the U.K., EPI is replaced by ADRN (adrenaline).

The marked event is stored in the Event Summary. If the printer is configured to **Print on Mark**, an ECG strip prints when **Mark Event** is pressed. If the printer is configured to **6 second delay**, the strip is 9 seconds and includes 6 seconds preceding the event and 3 seconds following the event. If **No Delay** is configured, a 3 second ECG strip prints in real time. To stop printing before the entire strip is printed, press **Print Strip**.

Events Recorded

The following events and related information are stored in the Event Summary:

Table 9-1 Event Information

Event	Related Information Stored
Power Change	Power on, Power off, Continued use, Battery low.
Pads Change	Pads on, Pads off.
AED Mode Analysis	Analyzing, Analysis Stopped, Artifact Detected, Cannot Analyze, Shock Advised, No Shock Advised.
Mode Change	AED Mode or Manual Mode.
Rhythm Monitoring	Check Patient, Pause, Resume.
Charging	ECG waveform, Energy charged to.
Shock	ECG waveform, Shock#, Delivered energy, Peak current, and Patient impedance.
Shock Failed	No Shock Delivered.
Disarm	ECG waveform.
ECG Monitoring	Leads on, Leads off, Lead change, Gain change.
Heart Rate Alarm Violation	Lead, Heart Rate, and Heart Rate alarm limits.

Table 9-1 Event Information (Continued)

Event	Related Information Stored
SpO ₂ Violation	SpO ₂ value and SpO ₂ alarm limit.
Mark	ECG waveform with annotation (▲, Epi, Atro, Lido, or Other).
Print Strip	ECG waveform.
Sync	Sync on, Sync off, Sync marker.
Pacing	Pacer start, Pacer stop, Pacer settings.

Creating a Patient Record

The HeartStart XLT creates an Event Summary patient record for each new patient. Each record is assigned a unique incident number. The HeartStart XLT keeps the Event Summary in its internal memory until you begin caring for a new patient. It assumes that:

Table 9-2 Patient Record Summary

If:	Then:
Power is off for more than 2 minutes and a new event is recorded	You are caring for a new patient. The last internal Event Summary is deleted; a new Event Summary is started and a new incident record is created on the Data Card.
Power is off less than 2 minutes	You are continuing to care for the same patient. Additional events are appended to the Event Summary; the annotation "Continued Use" is printed on the Event Summary.

The Continued Use feature allows you to change batteries or shut the HeartStart XLT off briefly (for 2 minutes), while preserving the current patient record. Events recorded after the power interruption are appended to the patient record. Continued use also preserves alarm settings.

Printing the Internal Event Summary

To print the internal Event Summary, press **Print Summary**. To stop printing before the complete summary is printed, press **Print Summary** again or press **Print Strip**.

The Event Summary includes the following information, in the order listed:

- a header with a place for you to write in the patient's name and the operator's name.
- a directory list of events that occurred during the incident and the time of their occurrence.
- ECG strips of the events in the directory list, where relevant.

Figure 9-2 shows the beginning of an Event Summary.

Figure 9-2 Event Summary

Patient _____						Device On					12:41:00
						AED Mode					12:41:00
Operator _____						Pads On					12:41:01
						Leads On					12:41:03
Device On	03	Jan	00	12:41:00		Analyzing					12:41:03
						Shock Advised					12:41:11
Last Event	03	Jan	00	01:09:04		Shock #1					12:41:17
						Analyzing					12:41:24
Total Shocks	2					Shock Advised					12:41:31
Incident:	0000045					Shock #2					12:41:38
Serial Number	123456789					Manual Mode					12:41:42

The Event Summary also includes waveforms and the appropriate annotation for each of the following events:

Table 9-3 Event Waveform Information

Event	Waveform Description
Shock Advised	11 seconds of ECG just prior to the message Shock Advised .
No Shock Advised	11 seconds of ECG just prior to the message No Shock Advised .
Cannot Analyze	11 seconds of ECG just prior to the message Cannot Analyze .
Shock Delivered	11 seconds; 3 seconds prior to the shock, plus 8 seconds after the shock.
Print Strip	11 seconds; 3 seconds prior to Print Strip being pressed, plus 8 seconds after Print Strip is pressed.
Mark Event	11 seconds; 3 seconds prior to Mark Event being pressed, plus 8 seconds after Mark Event is pressed.
ECG or SpO ₂ Alarm	11 seconds; 3 seconds prior to the alarm, plus 8 seconds after the alarm.

Printing Events

The HeartStart XLT can be configured to print automatically when certain events occur. The table below lists these events and the length of the strip printed, depending on whether the printer is configured to print real-time or with a 6-second delay.

Table 9-4 Printing Events

Event	Real-Time Strip Length	Delayed Strip Length
Defibrillator charges	continuous	6 seconds just prior to charging, plus continuous printing throughout the charge duration.
Shock Delivered	12 seconds	6 seconds just prior to shock, plus 12 seconds after shock.
Shock Failed	6 seconds	6 seconds just prior to the message No Shock Delivered , plus 6 seconds after the message.
Defibrillator disarmed	6 seconds	6 seconds just prior to shock, plus 6 seconds after shock.
Alarm Violation	6 seconds	6 seconds just prior to alarm violation, plus 6 seconds after alarm violation.
Mark Event pressed	6 seconds	6 seconds just prior to marking, plus 6 seconds after button pressed.

Printing is configured independently for each of these events. You can stop the printing before it has printed the entire strip by pressing **Print Strip**.

To print additional events that you observe in the course of caring for your patient, press **Print Strip**. An ECG strip will print continuously until you press **Print Strip** a second time to stop printing. If the printer is configured to have a 6-second delay, the printout contains an additional 6 seconds of the ECG that occurred just prior to pressing **Print Strip**.

10 Setting Up and Configuring the HeartStart XLT

This chapter describes how to set-up and configure your HeartStart XLT. It covers:

- Connecting Patient Cables
- Arranging Accessories in the Carrying Case
- Configuring the HeartStart XLT

Connecting/Disconnecting Patient Cables

This section describes how to connect and disconnect the:

- Pads Patient Cable
- ECG Patient Cable (3- or 5-lead)
- SpO₂ Patient Cable

Connecting the Pads Patient Cable

To connect the pads patient cable to the defibrillator:

1. Align the white pointer on the pads patient cable with the white arrow on the defibrillator's pads connector, as shown in Figure 10-1.
2. Insert the patient cable into the pads connector. Push until you hear it click in place.

Figure 10-1 Pads Patient Cable Connector

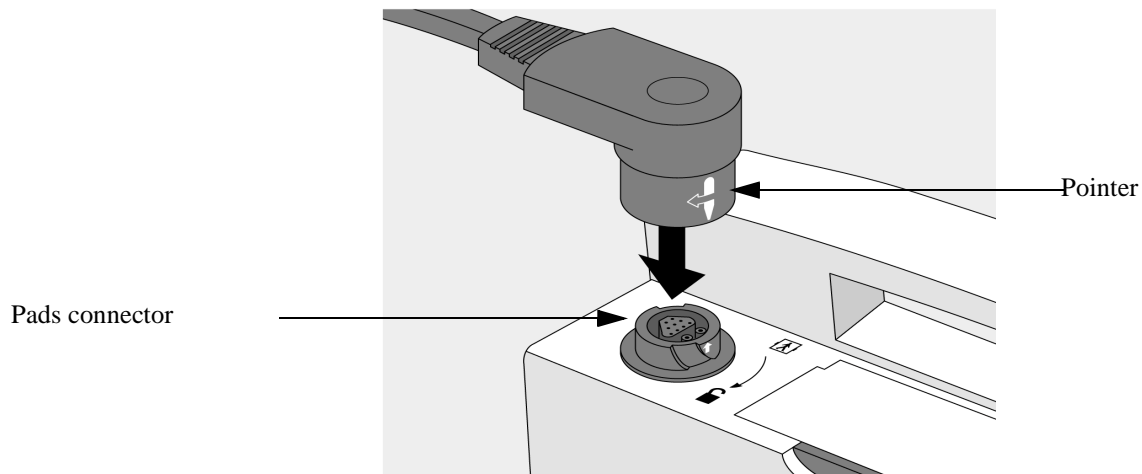

Disconnecting the Pads Patient Cable

To disconnect the pads patient cable:

1. Rotate the green locking mechanism on the patient cable in the direction (clockwise), of the blue arrow on the defibrillator until it stops (as shown in Figure 10-2).
2. Hold the locking mechanism in this position as you pull the patient cable away from the defibrillator.

Figure 10-2 Disconnecting the Pads Patient Cable

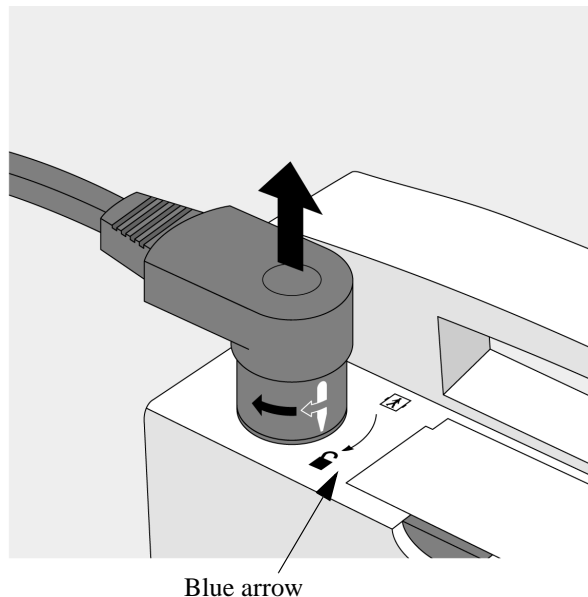

Connecting the ECG Patient Cable

To connect a 3- or 5-lead ECG patient cable:

1. Align the keyed patient cable plug with the slot on the ECG connector, as shown in Figure 10-3.
2. Push the patient cable firmly into the ECG connector, until the white portion is no longer visible.

Figure 10-3 ECG Patient Cable Connector

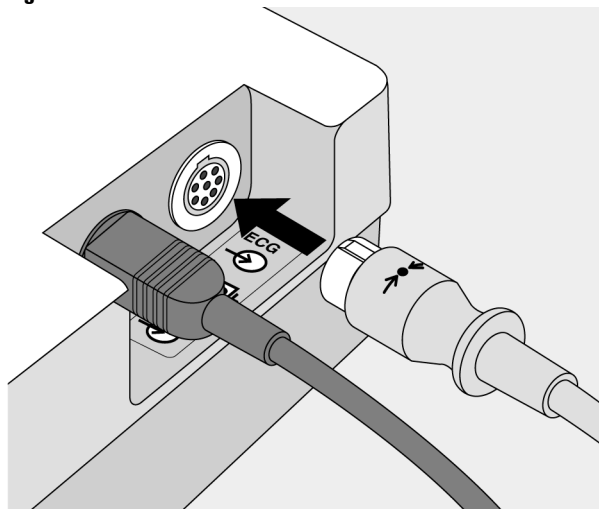

Disconnecting the ECG Patient Cable

To disconnect the ECG patient cable, gently pull the white patient cable plug out of the ECG connector, as shown in Figure 10-3.

Connecting the SpO₂ Patient Cable

To connect the SpO₂ patient cable:

1. Hold the connector with the flat side up, as shown in Figure 10-4.
2. Insert the connector into the receptacle and push until the blue portion of the connector is no longer visible.

Figure 10-4 Connecting the SpO₂ Patient Cable

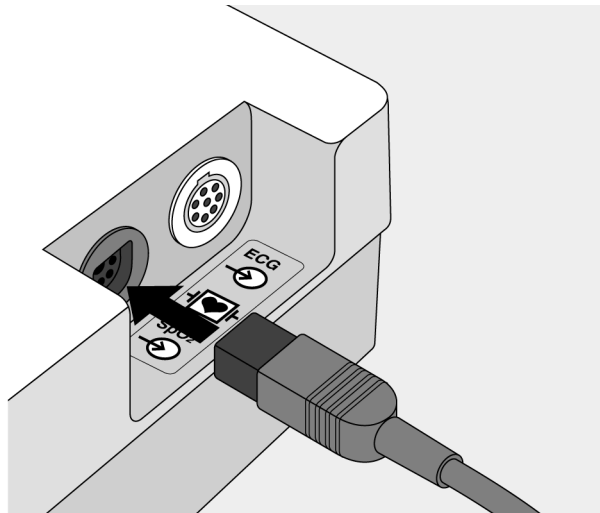

Disconnecting the SpO₂ Patient Cable

To disconnect the SpO₂ patient cable, gently pull it out of the SpO₂ connector.

Arranging Accessories in the Carrying Case

The HeartStart XLT carrying case is designed to hold your essential defibrillation and monitoring accessories. Figure 10-5 shows the recommended placement for each of these accessories.

Figure 10-5 Recommended Accessory Placement

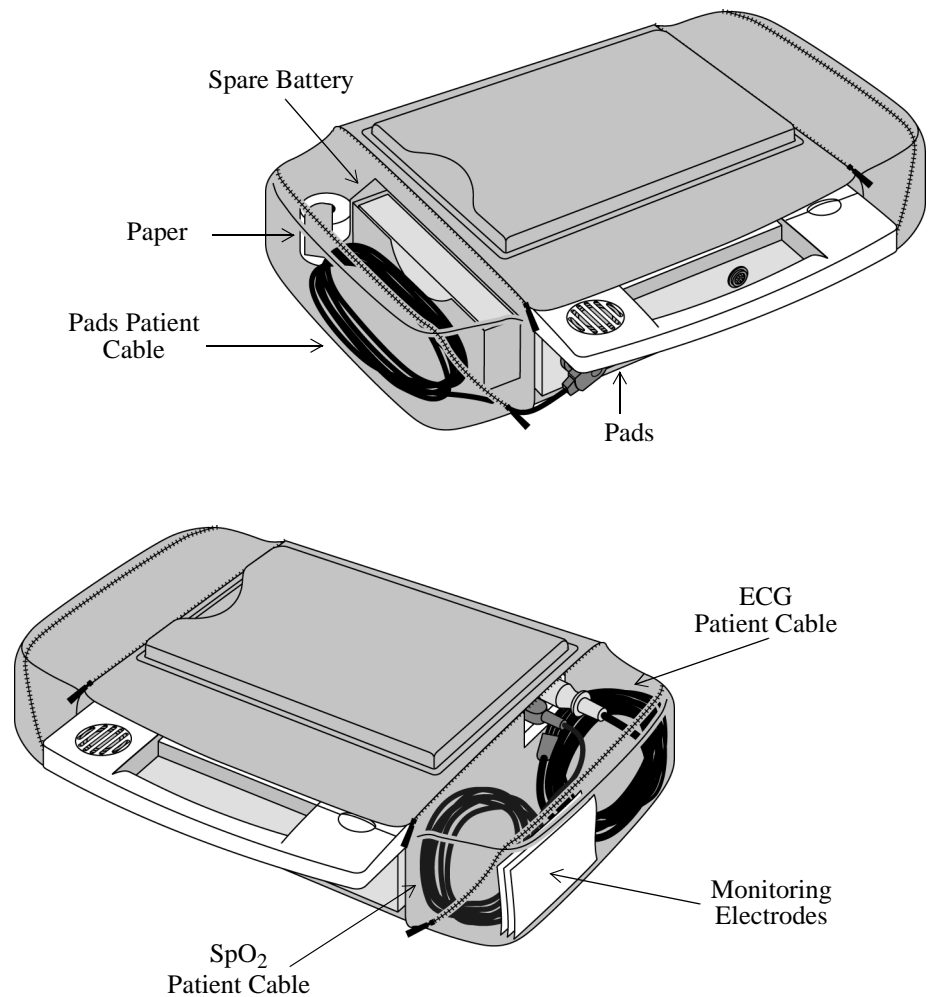

Configuring the HeartStart XLT

Configuration options allow you to customize the HeartStart XLT to best meet your needs. This section describes:

- How to access the configuration menu.
- Configurable items and their setting options.
- How to change the configuration.
- How to save the configuration to a Data Card.
- How to load the configuration from a Data Card.
- How to print the configuration.

Accessing the Configuration Menu

There is a special combination of softkeys that, when pressed simultaneously, turn the HeartStart XLT on in Configuration Mode. For the purposes of executing this procedure, softkeys are assigned numbers as shown in Figure 10-6.

Figure 10-6 Softkey Numbers

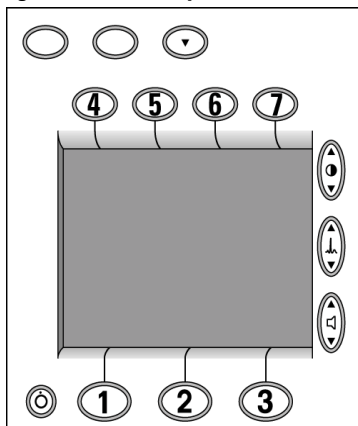

To turn the HeartStart XLT on in Configuration Mode:

1. If the device is already on, press **Off**.
2. While holding down softkeys 4 & 5, press 1.

The configuration menu appears as shown in Figure 10-7. The menu lists the categories of settings that may be configured.

Figure 10-7 Configuration Menu

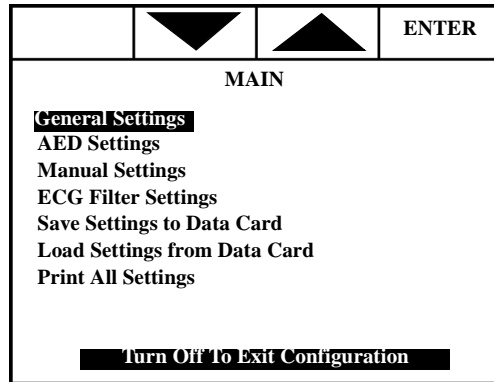

Configurable Parameters

The following tables show the configurable parameters for each category of settings. A description of each parameter is provided, along with the possible choices. Default settings are in bold.

Table 10-1 General Settings

Parameter	Description	Setting Choices
Date (dd mmm yyyy)	Current date, where dd is the day, mmm is the month, and yyyy is the year.	any valid date
Time (hh:mm)	Current time, where hh is the hour and mm is the minutes. Time is based on a 24 hour clock.	any valid time
Print on Mark	Prints a 3 second strip when Mark Event is pressed.	On / Off
Print on Charge	Prints a continuous strip during charging. Printing continues until a shock is delivered, the device is disarmed, or Print Strip is pressed.	On / Off
Print on Shock	Prints a 12 second strip when a shock is delivered.	On / Off
Print on Alarm	Prints a 6 second strip during alarms.	On / Off

Table 10-1 General Settings (Continued)

Parameter	Description	Setting Choices
Printer Delay	Captures what you just saw. All printed strips, including those generated by an event (mark, charge, shock or alarm), include an additional 6 seconds of information - the 6 seconds of information that occurred just prior to printing being initiated.	6 Sec Delay / No Delay
Pace Pulse Markers	Shows pace pulse markers on the ECG displayed, if an internal pacemaker is detected.	Leads & Pads / Leads Only
ECG Lead Cable	Selects the monitoring electrodes source.	3-lead / 5-lead
Power on Mode	Defines the operating mode when the device is turned on. Applies to a new use, not to a continued use.	AED / Manual
QRS Beeper	Provides an audible beep with each QRS complex detected.	Manual / AED & Manual / Off

Table 10-2 AED Settings:

Parameter	Description	Setting Choices
AED Shock Series	Defines the maximum number of shocks to deliver before prompting Check Patient, Check Pulse, If Needed Begin CPR .	2, 3, 4
Shock Series Timer	Defines the number of seconds that must pass before the next shock is considered the first shock of a new shock series, rather than the next shock of the current shock series.	30, 60, 90, 120, 150, 180, 210, Off
Device Initiated Analysis	Initiates ECG analysis when the HeartStart XLT is turned on in AED Mode.	On, Off
Automatic Re-Analysis	Initiates ECG analysis in between shocks within a shock series.	On, Off
Rhythm Monitoring	Monitors the ECG for potentially shockable rhythms when the HeartStart XLT is not analyzing, defibrillating, or paused.	On, Off
"Check Patient" Timer	Defines how often (in seconds) the Check Patient prompt is repeated when Rhythm Monitoring detects a potentially shockable rhythm.	30, 45, 60, 90, Off
European Protocol	Modifies Pause state prompts and replaces the Pause Timer with either the Post Shock CPR Timer or the "NSA" Timer, depending on the event preceding the Pause state.	Off/On
If European protocol is set to On , the following two configuration choices appear:		
Post Shock CPR Timer*	Defines the duration of the Pause time (in seconds) when PAUSE is pressed and the time since the last shock is less than or equal to the Shock Series Timer setting - typically at the completion of a shock series.	30, 60, 120, 180

Table 10-2 AED Settings: (Continued)

Parameter	Description	Setting Choices
"NSA" Timer*	Defines the duration of the Pause time (in seconds) when PAUSE is pressed and the time since the last shock is greater than the Shock Series Timer setting - typically when No Shock Advised .	30, 60, 120, 180
If European Protocol is set to Off , the following configuration choice appears:		
"Pause" Timer*	Defines the duration of the pause time (in seconds), when PAUSE is pressed (when European Protocol is set to Off).	30, 60 , 120, 180
The following two configuration choices are always available regardless of the European Protocol setting.		
Lead Select	Turns on ECG monitoring.	On, Off
SpO2	Turns on SpO ₂ monitoring. Only listed as a configurable item if the SpO ₂ option was purchased.	On, Off

NOTE

* If **European Protocol** is set to **Off**, the **Pause Timer** is used during the **Pause** state and appears as a configurable parameter. If **European Protocol** is set to **On**, either the **Post Shock CPR Timer** or the **"NSA" Timer** are used during the **Pause** state and appear as configurable parameters in place of **Pause Timer**.

NOTE

If **European Protocol** is set to **On**, the setting for the **Shock Series Timer** must be \leq **Post Shock CPR Timer** \leq **NSA Timer**. Also, the **Shock Series Timer** can not be configured to either **Off** or **210**.

Table 10-3 Manual Settings

Parameter	Description	Choices
Manual Mode Security	Requires entry of a password to access Manual Mode.	On, Off
Sync After Shock	Determines if the Sync function stays on after a synchronized shock is delivered.	On, Off

Setting the Manual Mode Password

When Manual Mode Security is set to On (see “Modifying the Configuration” on page 10-15), the password entry screen is displayed. Use the softkeys on the top of the display to enter a four digit password.

Figure 10-8 Password Entry Screen

1	2	3	4
<p>Enter Password</p> <p>— — — —</p>			
CANCEL			

Table 10-4 ECG Filter Settings

Item	Description	Setting Choices
AC Line Filter	Selects the setting used to filter out AC line noise.	60 Hz, 50 Hz
Pads ECG for Display	Selects the display filter frequency for the pads ECG.	Monitor (.15-40Hz), EMS (1-30 Hz)
Pads ECG for Printer	Selects the printer filter frequency for the pads ECG.	Monitor (.15-40Hz), EMS (1-30 Hz)
Leads ECG for Display	Selects the display filter frequency for the monitoring electrodes ECG.	Monitor (.15-40Hz), EMS (1-30 Hz)
Leads ECG for Printer	Selects the printer filter frequency for the monitoring electrodes ECG.	Diag (.05 - 150 Hz), EMS (1 - 30 Hz), Monitor (.15 - 40 Hz)

Modifying the Configuration

To modify the configuration, from the main menu:

1. Use ▲ and ▼ to highlight the desired category of settings.
2. Press **ENTER**.
3. Use ▲ and ▼ to highlight the item you want to change.
4. Press **CHANGE**.
5. Use the softkeys (**NEXT**, ▲, or ▼,) to select the desired setting. To select the default setting, press **SET DEFAULT**.
6. Press **SAVE** to save the change. To exit without making the change, press **CANCEL**.
7. Press **MAIN** to return to the main menu.

To make additional changes, repeat steps 1-7.

Returning to the Default Configuration

Press ▲ and ▼ on  simultaneously, while in the main configuration menu, to return all settings to their default settings. Although there is no visible change in the display, default settings are restored.

Saving Settings to a Data Card

Configuration settings may be saved to a Data Card and used to load the same configuration into other HeartStart XLTs or to restore the configuration, if necessary.

To save the configuration:

1. Make sure a Data Card is in the HeartStart XLT before turning the unit on.
2. Select **Save Settings to Data Card** from the main configuration menu.
3. Press **SAVE** in response to the question **Save Settings to Data Card?**

The HeartStart XLT saves the configuration settings to the Data Card and returns to the main configuration menu.

Loading Settings from a Data Card

To load configuration settings:

1. Make sure a Data Card is in the HeartStart XLT.
2. Select **Load Settings from Data Card** from the main configuration menu.
3. Press **LOAD** in response to the question **Load Settings from Data Card?**

The HeartStart XLT loads the configuration settings from the Data Card and returns to the main configuration menu.

Printing Settings

To print the configuration settings, select **Print All Settings** from the main configuration menu.

11 Maintaining the HeartStart XLT

This chapter describes how to care for your HeartStart XLT Defibrillator/Monitor and its accessories. It provides:

- Operational checks,
- Battery maintenance procedures,
- Instructions on loading printer paper,
- Cleaning instructions,
- Instructions for removing and replacing the carrying case,
- A list of approved supplies and accessories, and
- Instructions for disposal of the device.

The operational checks described must be performed at the specified intervals in order to help prevent and detect electrical and mechanical problems. The battery maintenance procedures specified must be adhered to in order to ensure that your batteries have the energy required to operate the defibrillator and deliver the appropriate therapy.

Operational Checks

The following operational checks are intended to quickly verify the proper operation of the HeartStart XLT. Perform these checks regularly, at the intervals specified, along with visual inspection of the device and all cables, controls, accessories and supplies. Also regularly check expiration dates of all supplies, such as multifunction defib electrode pads and monitoring electrodes.

Before You Begin

Before you run the Shift/System Check, be aware of the following conditions:

- Do *not* touch any of the controls on the HeartStart XLT while the Shift/System Check is running.
- If a **Failure** or **Service Unit** message is displayed, or if an unexpected **Not Tested** result is displayed, check that the test is set up correctly. Make sure that:
 - the paper is in the printer
 - the test load is attached
 - a Data Card with enough space is inserted into the HeartStart XLT
 - a charged battery is inserted into the HeartStart XLT

Run the Shift/System Check again, ensuring that no one touches any of the controls on the defibrillator unless prompted to do so.

- If the Data Card is full, the message **Service Unit** appears at the bottom of the screen and the message **Data Card Full** appears at the top of the screen. Replace the Data Card and perform the Shift/System Check again. If the message **Service Unit** continues to appear, do not use the device and call for service.

Every Shift

Perform a “Shift/System Check” every shift (see “Shift/System Check” on page 11-4) to verify that the HeartStart XLT is functioning properly and to ensure that necessary supplies and accessories are present and ready for use.

Every Month

Check expiration dates on multifunction defib electrode pads and monitoring electrodes every month. Replace them if the expiration date has passed.

Every Three Months

Perform a "Battery Capacity Test" on each battery, every three months, to ensure that your batteries meet the specifications for safe and effective use.

Shift/System Check

To perform the Shift/System Check:

1. Turn the HeartStart XLT off.
2. Connect a 50 ohm test load to the pads patient cable (instead of pads).
3. If a Data Card is routinely used, insert a Data Card into the HeartStart XLT.
4. If a power module is used, unplug the power module.
5. Insert a charged battery.
6. While pressing **Print Strip**, press **On** to start the test.
7. Follow the prompts on the display to proceed with the test. If the message **Service Unit** appears, check the information in Table 12-2 and Table 12-3 . If the message continues to appear, do not use the device, and call for service.

The test takes less than a minute to complete. When it is done, a report is printed, as shown in Figure 11-1. Test results are listed as Pass or Fail, with the exception of the Data Card Test. For the Data Card Test, the results indicate either the amount of storage time remaining on the data card or that no data card is present.

Figure 11-1 Shift/System Check Report

Shift/System Check	8 Jan 1999 13:52:17	SN:US00000001
Current Tests:		Qty/Check List:
General System Test	Pass	___ Defibrillator Inspection
ECG Test	Pass	___ Cables/Connectors
Backup Power Test	Pass	___ Defibrillation Pads
SpO2 Test:	Pass	___ Monitoring Electrodes
Data Card Test	2:00	___ Charged Batteries
Defib Test	Pass	___ AC/DC Power Module
Pacer Test	Pass	___ Printer Paper
		___ Data Card
		___ Ancillary Supplies
		___ SpO2 Sensor

The report also lists additional checks that you should do. Perform each of these checks and record the results. The guidelines for completing the checks are as follows:

- **Defibrillator Inspection** - make sure the HeartStart XLT is clean, clear of objects on top and has no visible signs of damage.
- **Cables/Connectors** - make sure there are no cracks, broken wires, or other visible signs of damage. Make sure the connectors engage securely.
- **Supplies** - make sure the carrying case has:
 - two sets of multifunction defib electrode pads in sealed packages, within the expiration date
 - an adequate supply of monitoring electrodes, within the expiration date
 - alcohol wipes
 - hand towel
 - scissors
 - a razor
 - an extra roll of printer paper
 - a spare charged battery
 - a Data Card
 - SpO₂ sensors (if monitoring SpO₂)

— **Power Supply**

Battery - make sure:

- a charged battery is in the HeartStart XLT
- another battery is charged or being charged
- the batteries have no visible signs of damage

AC/Power Module

1. Make sure a battery is in the HeartStart XLT.
2. Plug the power module into a power outlet and connect it to the HeartStart XLT.
3. Verify that the power and charging indicators on the power module are lit.
4. Remove the battery from the HeartStart XLT and verify that the charging indicator on the power module is no longer lit. Replace the battery.

— **Printer** - make sure the printer:

- has sufficient paper
- prints properly

Battery Capacity Test (CT)

To perform a Battery Capacity Test:

1. Turn the HeartStart XLT off.
2. Place a "Test in Progress" label on the HeartStart XLT to indicate to others that it may not be used.
3. Insert a charged battery.
4. If an AC power module is connected, unplug the power module from the HeartStart XLT. While pressing **Mark Event**, press **On** to start the test.
5. Allow the test to proceed to completion. The test takes approximately three hours and is complete when test results print out and the device turns itself off.
6. Review the test results and take the appropriate action, as follows:

Table 11-1 Battery Capacity Test Results

If	Then...
Elapsed Time > 2.5 hours <u>and</u> Low Battery Time > 10 minutes	<ol style="list-style-type: none"> 1. The battery passed the test. 2. Record "pass CT" and the date on the bottom of the battery. 3. Recharge the battery before use.
Elapsed Time < 2.5 hours <u>or</u> Low Battery Time < 10 minutes	<ol style="list-style-type: none"> 1. The battery failed the test. 2. Record "fail CT" and the date on the bottom of the battery. 3. Discard the battery appropriately.

Battery Maintenance

The HeartStart XLT uses the M3516A Battery Pack. It is a rechargeable sealed lead acid battery. Battery maintenance begins when you receive a new battery and continues throughout the life of the battery. Detailed information on battery care is provided in the application note “*About Sealed Lead Acid Batteries,*” that came with your HeartStart XLT.

Table 11-2 lists battery maintenance activities and when they should be performed.

Table 11-2 Battery Maintenance Activities

Activity:	When to Perform:
Perform a visual inspection	Daily, as part of the Shift/System Check.
Charge the battery	Upon receipt, after each use, and when the message Low Battery is displayed.
Perform a Battery Capacity Test	Every three months.
Store the battery appropriately	When not in use.

Charging Batteries

You may charge batteries while they are in either the HeartStart XLT or the M3506A Battery Charger Adapter, by connecting the device with the battery to the M3517A AC Power Module.

Refer to the charging procedures provided in the operating instructions for the power module(s) you use. Batteries charge to 90% of their capacity in about 2.5 hours. It then takes about 12 more hours to reach a fully charged state.

Batteries should be charged at temperature between 10°C (50°F) and 30°C (86°F) for maximum battery life.

Battery Capacity

A fully charged M3516A battery, operating at room temperature, provides greater than 2.7 hours of monitoring or more than 50, 200-joule charge-shock cycles.

Battery Life-Expectancy

Life-expectancy of a battery depends on the frequency and duration of use. When properly maintained and stored, the life-expectancy of a battery is about 2 years. For more aggressive use models, life-expectancy may be less.

Storing Batteries

Batteries should be used regularly and rotated to distribute the use evenly. When storing batteries, make sure that the battery terminals do not come in contact with metallic objects.

Batteries should not be stored without charging for more than one month, if installed in the defibrillator, or more than three months, if not installed in the defibrillator. Storage at temperatures between 15°C (59°F) and 30°C (86°F) is recommended to maximize life-expectancy.

CAUTION

Storing at temperatures above 35°C (95°F) for extended periods of time will significantly reduce a battery's life-expectancy.

Discarding Batteries

Batteries should be discarded two years after the first Test Date (as written on the battery's back label), or sooner, if there are visual signs of damage or if they fail the Battery Capacity Test. Batteries should be discarded in an environmentally safe manner. Properly dispose of batteries according to local regulations.

WARNING

Do not disassemble, puncture, or incinerate batteries. Be careful not to short the battery terminals because this could result in a fire hazard.

Loading Printer Paper

To load printer paper:

1. Slide the printer door to the right until the paper roller pops up.
2. If there is an empty or low paper roll in the printer, pull up on the plastic removal tab to remove the roll.

Figure 11-2 Opening the Printer

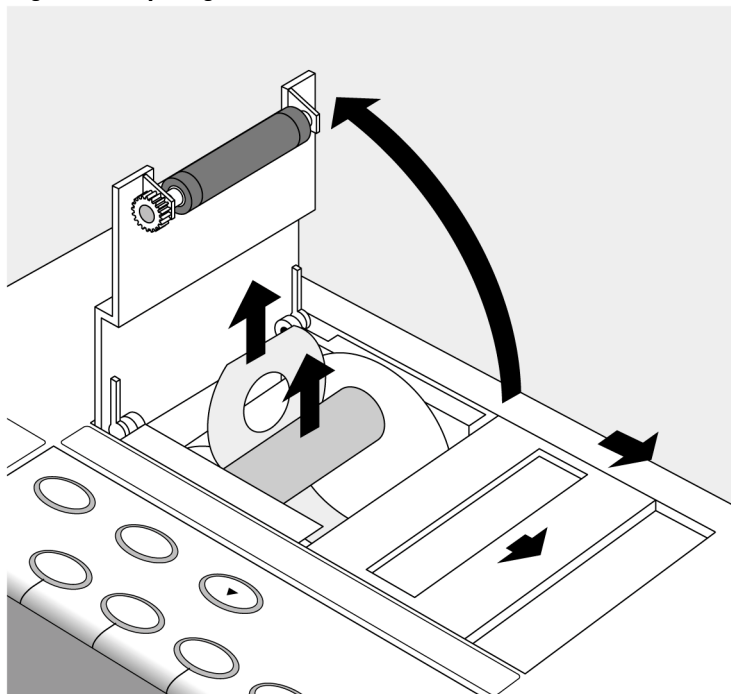

3. Place a new roll of printer paper (40457C/D) into the printer paper well, positioning the roll so that the end of the roll is on the top and the grid faces down. Be sure to push the roll down so that it is firmly seated in the paper well.
4. Pull the end of the paper past the paper roll.
5. Slide the printer door to the right and hold it open. Press the roller down over the paper and release the door.

Figure 11-3 Loading Paper

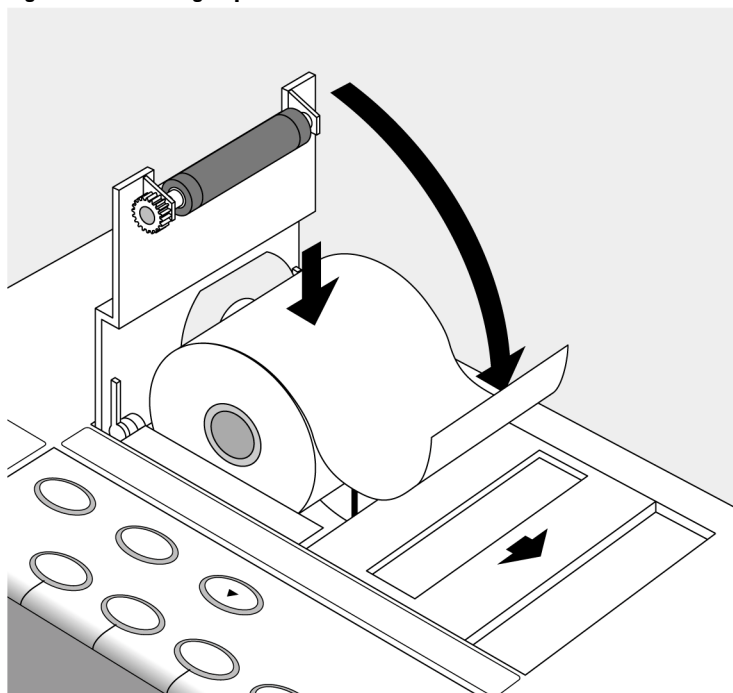

Cleaning Instructions

Following are recommendations for cleaning the HeartStart XLT and its associated case, cables, etc.

Cleaning the HeartStart XLT

The following cleaning products may be used to clean the exterior surfaces of the HeartStart XLT, as well as the battery and data card:

- Isopropyl alcohol (70% in water)
- Mild soap and water
- Chlorine bleach (3% in water)
- Quaternary ammonium compounds, such as Lysol (10% in water)

When cleaning, be sure to avoid pouring fluids on the device and do not allow fluids to penetrate the exterior surfaces of the device. Use of a soft cloth is recommended for cleaning the display, to prevent scratching.

CAUTION

The HeartStart XLT may not be autoclaved, ultrasonically cleaned, or immersed. Do not use abrasive cleaners or strong solvents such as acetone or acetone-based cleaners.

Cleaning the Carrying Case

Clean the carrying case by hand, using a mild soap and water. A brush may be used on stubborn spots and a fabric cleaner may be used to remove grease spots. Air dry the carrying case when cleaning is complete.

If it is necessary to remove the carrying case for cleaning, refer to directions on page 11-15.

Cleaning the Printer Printhead

If the printout has light or varying density printing, clean the printhead to remove any buildup of paper residue.

To clean the printhead:

1. Slide the printer door to the right until the paper roller pops up.
2. Pull up on the plastic removal tab to remove the roll of paper.
3. Clean the printhead surface (above the brush) with a cotton swab dipped in rubbing alcohol.
4. Replace the roll of paper (see “Loading Printer Paper” on page 11-10).

Cleaning the Power Modules

The following cleaning products may be used to clean the exterior surfaces of the AC power modules:

- Isopropyl alcohol (70% in water)
- Mild soap and water
- Chlorine bleach (3% in water)
- Quaternary ammonium compounds, such as Lysol (10% in water)

When cleaning:

- Avoid pouring fluids on the module. Do not allow fluids to penetrate the exterior surfaces of the module.
- Do not use abrasive cleaners or strong solvents such as acetone or acetone-based compounds.

Cleaning Pads, Electrodes & Cables

Defibrillation pads and monitoring electrodes are single use and do not require cleaning.

The pads cable may be cleaned with:

- Alcohol-free hand soap
- 2% gluteraldehyde solution (such as Cidex)
- Sodium hypochlorite (chlorine bleach) solution 10% in water
- Quaternary ammonium compounds (such as Lysol)
- Isopropyl alcohol

The ECG cable may be cleaned by wiping it with any of the following:

- 2% gluteraldehyde solution (such as Cidex®)
- Alcohol-free hand soap
- Chlorine bleach (100ml/l)

CAUTION

Do not ultrasonically clean, immerse, autoclave or steam sterilize the pads or ECG cable.

Do not clean the ECG cable with alcohol. Alcohol can cause the plastic to become brittle and may cause the cable to fail prematurely.

To clean the SpO₂ sensor and cable, follow the manufacturer's instructions.

Removing & Replacing the Carrying Case

To remove the carrying case from the HeartStart XLT, follow steps 1 through 7 in Figure 11-4.

After loosening the screws (step 6), lay the unit flat and lift the defib up off the metal mounting plates to disengage it from the two metal pins at the rear of the case. Then slide the defib out of the case as shown in step 7.

Figure 11-4 Removing the Carrying Case

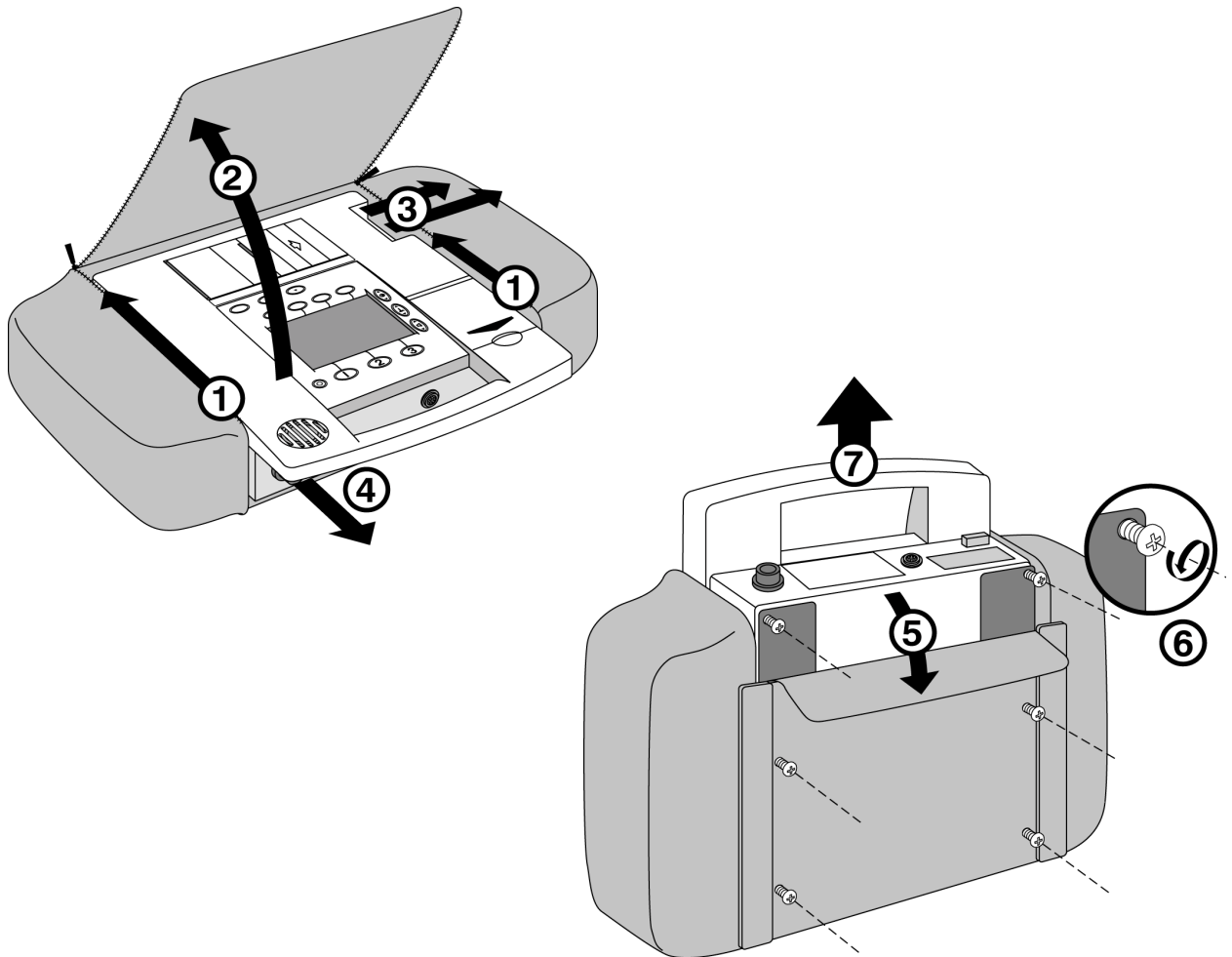

To put the carrying case on the HeartStart XLT, follow the steps 1 through 7 in Figure 11-5.

Slide the unit into the case as shown in step 1, then lower it onto the two metal pins at the rear of the case before tightening the screws (step 2).

Figure 11-5 Putting the Carrying Case On

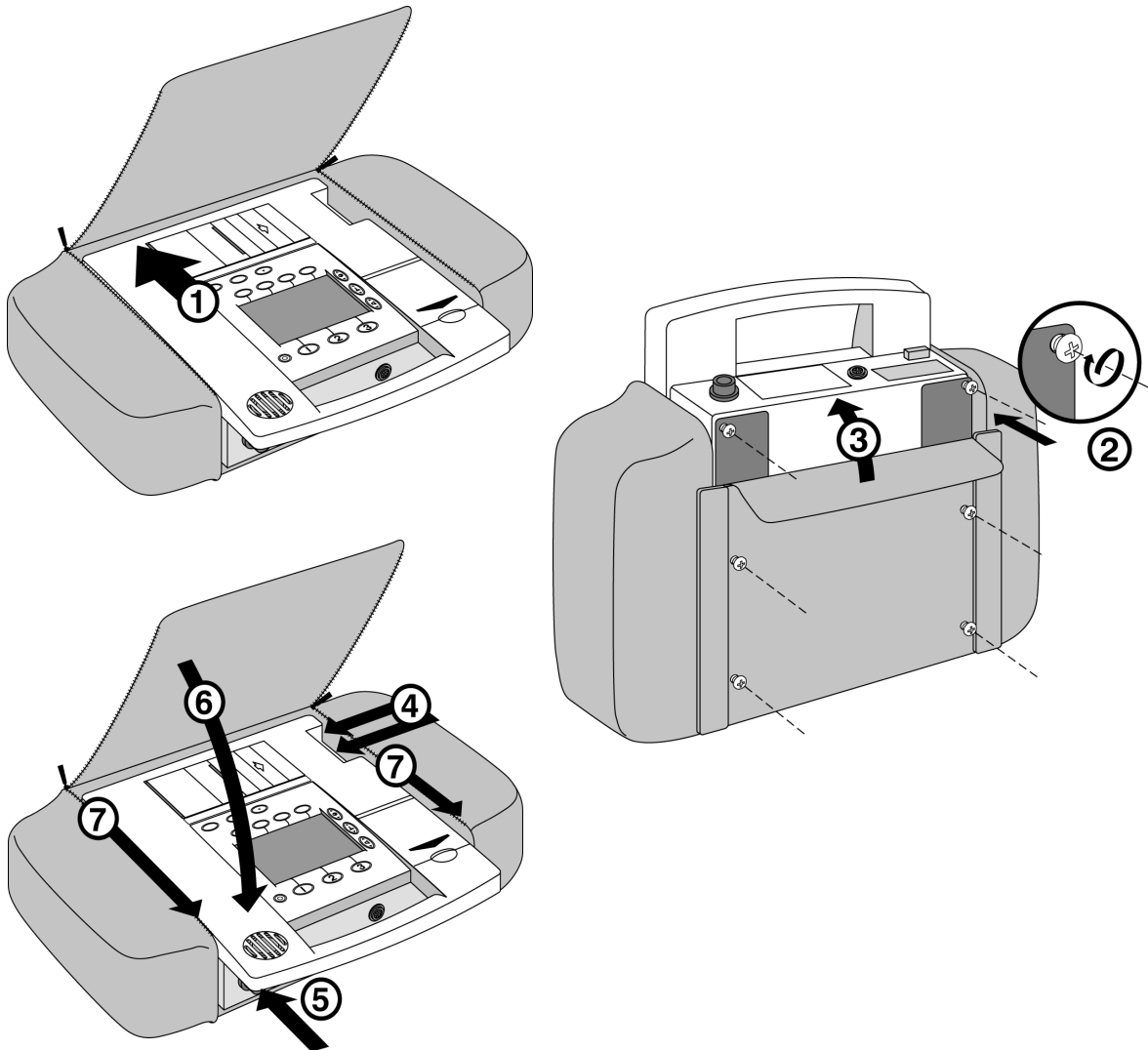

Putting On the Manual Door

To put on the manual door, align the door with the door hinges as shown in Figure 11-6. Then push, as shown in Figure 11-7, until the door snaps in place.

Figure 11-6 Aligning the Manual Door

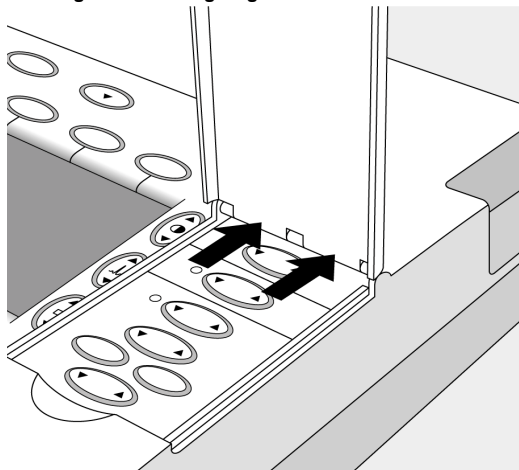
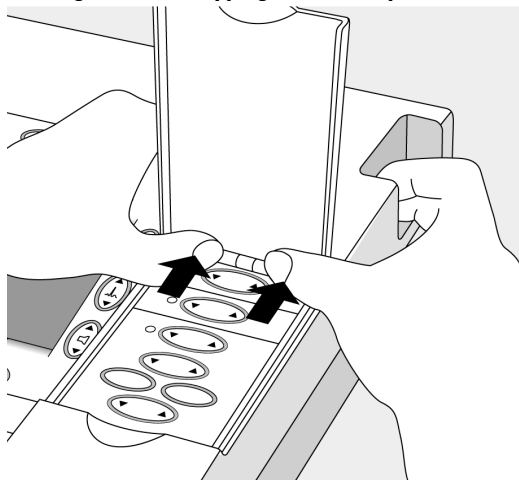

Figure 11-7 Snapping the door in place



Supplies & Accessories

Approved supplies and accessories for the HeartStart XLT are listed in Table 11-3 . To order:

- In the USA, call 1-800-225-0230 (electrodes, cables, paper, etc.) or 1-800-934-7372 (HeartStart Pads adapters only).
- Outside the USA, contact your local Philips Medical Systems Sales Office, your authorized Philips Medical Systems Dealer or Distributor, or visit our online store at www.medical.philips.com/cms and follow the Supplies link.

Table 11-3 Supplies and Accessories

Part Number	Description
Paper	
40457C	50 mm Strip Chart Thermal Paper - 1 box (10 rolls)
40457D	50 mm Strip Chart Thermal Paper - 1 box (80 rolls)
Defibrillation Pads, Pads Cables and Test Load (white twist lock connector)	
	
M3501A	Multifunction Adult defib pads, AAMI.
M3502A	Multifunction Adult defib pads, IEC.
M3503A	Multifunction Pediatric defib pads, IEC.
M3504A	Multifunction Pediatric defib pads, AAMI.
M3507A	Defib pads cable, barrel connector.
M1781A	50 ohm defibrillator test load, barrel connector.
05-10200	HeartStart Pads Adapter, barrel connector. Connects to M3507A pads connector cable.

Table 11-3 Supplies and Accessories (Continued)

Part Number	Description
Defibrillation Pads, Pads Cables, Adapters and Test Load (gray flat connector)	
M3713A	Multifunction Adult Plus Pads - Adult Plus multifunction defib pads (general use).
M3716A	Multifunction Adult Radiolucent Pads - Adult Radiolucent multifunction defib pads (special purpose - for X-ray and special procedures).
M3717A	Multifunction Pediatric Plus Pads - Pediatric multifunction defib pads (general use).
M3718A	Multifunction Adult Radiotransparent/Reduced Skin Irritation Pads - Adult Radiotransparent/Reduced Skin Irritation multifunction defib pads (special purpose - for X-ray and special procedures).
M3719A	Multifunction Pediatric Radiotransparent/Reduced Skin Irritation Pads - Pediatric Radiotransparent/Reduced Skin Irritation multifunction defib pads (special purpose - for X-ray and special procedures).
M3508A	Defibrillator pads cable, plug connector.
M3725A	50 ohm defibrillator test load, plug connector.

Table 11-3 Supplies and Accessories (Continued)

Part Number	Description
ECG Cables	
M1733A	3-lead ECG Trunk cable, AAMI (8-pin).
M1734A	5-lead ECG Trunk cable, AAMI (8-pin).
M1735A	3-lead ECG Trunk cable, IEC (8-pin).
M1736A	5-lead ECG Trunk cable, IEC (8-pin).
M1580A	3-lead ECG Trunk cable, AAMI (8-pin)
M1600A	5-Lead ECG Trunk Cable, AAMI ((8-pin)
M1590A	3-lead ECG Trunk Cable, IEC (8-pin)
M1610A	5-Lead ECG Trunk Cable, IEC (8-pin)
Monitoring Electrodes	
M2202A	High-Tack Foam ECG Electrodes - 5 electrodes/pouch (300 electrodes/case)
SpO₂ Cable/Sensors	
M1191A	Adult Reusable SpO ₂ sensor.
M1192A	Pediatric Reusable SpO ₂ sensor.
M1194A	Adult/Pediatric Ear Clip, Reusable SpO ₂ sensor
M1941A	SpO ₂ extension cable (2 m).
M1943A	Nellcor SpO ₂ Sensor adapter cable.
Data Card	
M3510A	Data Card.

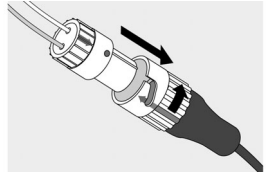
Table 11-3 Supplies and Accessories (Continued)

Part Number	Description
Battery/Power Modules/ Adapter	
M3516A	Sealed Lead Acid Battery.
M3517A	AC power module.
M3518A	DC Power Module
M3506A	Battery charger adapter.
Extension Cable	
M4748A	Adapter extension cable
Carrying Case	
M3509A	Carrying case. (If a new Quick Reference Card is needed for the carrying case, it must be ordered separately.)

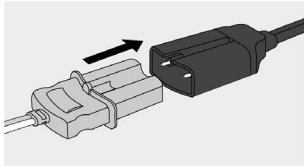
Disposing of the HeartStart XLT

Prior to disposing of the HeartStart XLT, remove the battery. Then dispose of the device and its accessories in accordance with local standards.

WARNING

Disposal of the device with the battery inserted presents a potential shock hazard.

12 Troubleshooting

If the HeartStart XLT detects an error or potential problem during use, it displays a system or momentary message. In AED Mode, these messages are often accompanied by a voice prompt. This chapter describes the messages and what you should do in response. In addition, this chapter provides general troubleshooting tips and information on calling for service.

NOTE

For instructions for repair, or for further technical information, refer to the service manual, part number M3500-90900.

System Messages

System messages remain on the display until the specified action is taken or no longer relevant. Each message is accompanied by a three second beep to alert you. Table 12-1 lists system messages.

Table 12-1 System Messages

Message	Description	Corrective Action
Attach Pads Cable	The pads cable is not properly attached to the device.	Check the cable connection.
Configuration Lost	The configuration is reset to the default settings.	<ul style="list-style-type: none"> • Reconfigure the HeartStart XLT. • If the message persists, call for service.
Data Card Disabled	The PC card is not in use because it is full, incompatible, absent, or inserted after the HeartStart XLT was turned on.	If possible, turn the HeartStart XLT off for more than 2 minutes, insert an empty, compatible Data Card, and turn the device on.
ECG Fault	The ECG data acquisition system failed and data is unavailable from the 3- or 5-lead monitoring electrodes.	Remove the device from active use and call for service.
Low Battery	The battery has sufficient capacity remaining to provide only about ten minutes of monitoring time and six shocks before the HeartStart XLT shuts off.	Replace the battery with a fully charged battery.
Leads Off	<ul style="list-style-type: none"> • The monitoring electrodes are not applied. • The monitoring electrodes are not making proper contact with the patient. • The monitoring cable is not connected. 	<ul style="list-style-type: none"> • Check the monitoring electrodes are properly applied. • Check the monitoring cable is properly connected.

Table 12-1 System Messages (Continued)

Message	Description	Corrective Action
No Pads	The multifunction defib electrode pads are not properly connected to the Heart-Start XLT.	Check the pads cable connection.
Pads Cable Off	The pads cable is not connected to the defibrillator.	Check pads connector is locked in place.
Pads Off	The pads are not making proper contact with the patient.	Make sure the pads are properly applied to the patient.
Pacer Failure	The pacing system is not functioning.	Remove the device from active use and call for service.
Pacer Output Low	High patient impedance is resulting in the pacer delivering less current to the patient than specified in the output current setting.	Check the pads are applied properly.
Service Unit	Appears during a Shift/System Check. May indicate that the Data Card is full. OR There is a system failure.	<ul style="list-style-type: none"> • Replace the Data Card. • Perform a Shift/System Check • If Service Unit continues to appear, do not use the device and call for service.
System Failure Cycle Power	An internal error occurred.	<p>If this occurs during actual use:</p> <ul style="list-style-type: none"> • Substitute another defib, if possible. Remove this unit from clinical use and call for service. • If no other defib is available, turn power off, then on. If unit turns on normally, use for this one incident. After this incident, remove from clinical use and call for service. • If unit does not turn on normally, it cannot be used. <p>If this occurs during routine testing: Remove this unit from clinical use and call for service.</p>

Table 12-1 System Messages (Continued)

Message	Description	Corrective Action
SpO ₂ Cable Off	The SpO ₂ cable is not connected to the device.	Attach the SpO ₂ cable to the HeartStart XLT.
SPO ₂ Failure	A failure has occurred in the SPO ₂ circuitry.	Remove the device from active use and call for service.
SpO ₂ Light Interf	The level of ambient light is so high that the sensor cannot obtain an SpO ₂ reading or the sensor or cable is damaged.	<ul style="list-style-type: none"> • Cover the sensor with an opaque material. • Check the sensor for damage; try another sensor.
SpO ₂ Non Pulsatile	The patient's pulse is absent or too weak to be detected.	<ul style="list-style-type: none"> • Check that the sensor is applied properly. • Make sure the sensor site has a pulse. • Relocate the sensor to a site with improved circulation. • Try another sensor.
SpO ₂ Low Signal	SpO ₂ signal is too low to give an accurate reading.	<ul style="list-style-type: none"> • Check the sensor is applied properly. • Try another sensor type.
SpO ₂ Noisy Signal	Excessive patient movement, electrical interference, or optical interference is present.	<ul style="list-style-type: none"> • Minimize patient movement or apply the sensor to a site with less movement. • Secure the sensor cable loosely to the patient. • Reduce sources of electrical or optical interference.
SpO ₂ Sensor Fail	The SpO ₂ transducer is broken.	Try another sensor.



Momentary Messages

Momentary messages are temporary and only appear on the display for a few seconds. Each message is accompanied by a three second beep to alert you. Table 12-2 lists momentary messages.

Table 12-2 Momentary Messages

Message	Possible Cause	Corrective Action
Attach Pads	The multifunction defib electrode pads are not making proper contact with the patient.	<ul style="list-style-type: none"> • Check the pads are applied to the patient, as directed on the pads' package. • Replace the pads if the prompt continues.
Attach Leads	An attempt was made to begin pacing in Demand Mode without ECG leads attached to the patient.	Attach leads to patient.
Defib Disarmed	<ul style="list-style-type: none"> • The pads connection is compromised. • The mode is changed from Manual to AED while the defibrillator is charged. • SHOCK is not pressed within 30 seconds of the defibrillator being charged. • DISARM is pressed. 	<ul style="list-style-type: none"> • Check the pads are applied to the patient properly. • If a shock is indicated, deliver the shock before changing modes. • To deliver a shock, press SHOCK within 30 seconds of the defibrillator being charged.
No Shock Delivered	Patient impedance is too high.	<ul style="list-style-type: none"> • Make sure the pads are applied properly. • Replace the pads, if necessary
Check Printer	Printer paper is absent or jammed; the printer door is not closed properly.	<ul style="list-style-type: none"> • Reload printer paper. • Make sure the door is closed properly.

Table 12-2 Momentary Messages (Continued)

Message	Possible Cause	Corrective Action
Data Card Full	<ul style="list-style-type: none"> The incident is more than 2 hours in duration, causing the Data Card to fill. An empty Data Card was not inserted for the incident, causing the Data Card to fill sooner. 	<ul style="list-style-type: none"> None. A new Data Card can not be inserted during an incident. Use one Data Card per incident/patient to decrease the chance of the card filling.
Data Card Interrupted	The Data Card is removed during an incident.	<ul style="list-style-type: none"> None. The Data Card can not be re-inserted during an incident. Do not remove the Data Card during an incident.
Data Card Not In Service	The Data Card is inserted while the HeartStart XLT is on.	None. A Data Card must be inserted prior to turning the HeartStart XLT on for the current patient.
Incompatible Data Card	A Data Card other than the M3510A is inserted.	Use only M3510A Data Cards.
No Data Card Present	A Data Card is not in the HeartStart XLT.	Turn the HeartStart XLT off and insert a Data Card prior to the first event for the patient.
Key Inactive	The key pressed is currently inactive (i.e.  and  are inactive in AED Mode).	Use the appropriate mode for the key.
Stop Pacer	 is pressed while pacing pulses are being delivered.	Stop pacing before changing the pacing mode.

Troubleshooting Tips

Table 12-3 lists some situations that you may encounter, causes, and actions to take.

Table 12-3 Troubleshooting Tips

Situation	Cause	Possible Solution
<p>The HeartStart XLT does not turn on.</p>	<p>There is no power. OR A corrupt Data Card may prevent the unit from powering on. OR Hardware failure.</p>	<ul style="list-style-type: none"> ● Insert a fully charged battery. ● Attach AC Power cord. ● Remove the Data Card ● Insert a new Data Card, if available ● Turn on the device ● Remove this unit from clinical use and call for service.
<p>The display is blank except for “SYSTEM FAILURE CYCLE POWER”.</p>	<p>An internal error occurred.</p>	<p>If this occurs during actual use:</p> <ul style="list-style-type: none"> ● Substitute another defib, if possible. Remove this unit from clinical use and call for service. ● If no other defib is available, turn power off, then on. If unit turns on normally, use for this one incident. After this incident, remove from clinical use and call for service. ● If unit does not turn on normally, it cannot be used. <p>If this occurs during routine testing:</p> <ul style="list-style-type: none"> ● Remove this unit from clinical use and call for service.
<p>The HeartStart XLT appears to be on but the display is blank.</p>	<ul style="list-style-type: none"> ● The contrast needs adjusting. ● The display has overheated. 	<ul style="list-style-type: none"> ● Adjust the contrast. ● Avoid exposing the display to direct sunlight on a hot day.

Table 12-3 Troubleshooting Tips (Continued)

Situation	Cause	Possible Solution
There is a dashed (----) line on the display instead of an ECG.	ECG data is not being acquired.	<ul style="list-style-type: none"> ● Check the patient cable is connected. ● Check the pads or electrodes are properly applied. ● Check that the desired lead is selected.
The HeartStart XLT does not appear to be functioning properly.	<ul style="list-style-type: none"> ● The battery is low. ● There is a system failure. 	<ul style="list-style-type: none"> ● Change the battery. ● Take the device out of use and call for service.
The displayed time is incorrect.	The time was not correctly set in the configuration.	Set the time in the General Settings menu of the Configuration Mode.
The printed date is incorrect.	The date was not correctly set in the configuration.	Set the time in the General Settings menu of the Configuration Mode.

Calling for Service

For telephone assistance, call the Response Center nearest to you, or visit our website at:

www.medical.philips.com/cms and follow the link for service.

United States of America

Medical Response Center	Tel: (800) 548-8833
--------------------------------	---------------------

Latin America

Medical Response Center	Tel: 954-835-2600
--------------------------------	-------------------

Canada

Medical Response Center	Tel: 800-323-2280
--------------------------------	-------------------

Other International Areas

Australia	France
Tel: 131147	Tel: 0803 35 34 33

Germany	Italy
Tel: 0180 5 47 50 00	Tel: 800-825087

Netherlands	United Kingdom
Tel: 31 20 547 2555 Fax: 31 29 547 2949	Tel: 00 44 7002 432584

Belgium (for Dutch)	Belgium (for French)
Tel: 32 2 525 7102 Fax: 32 2 525 71 91	Tel: 32 2 525 710 3 Fax: 32 2 525 71 91

Spain	Poland
Tel: 34 902 30 40 50 Fax: 34 91 326 39 66	Tel: 48 22 5710499

Austria	Finland
Tel: 43 1 60101 820	Tel: 09 6158 0400

Switzerland	Russia
Tel: 0800 80 10 23	Tel: 7 095 933 0339 Fax: 7 095 933 0338

13 Specifications & Safety

This section provides:

- Specifications for the HeartStart XLT,
- Symbol definitions for symbols appearing on the HeartStart XLT,
- A clinical performance summary,
- Safety related information, and
- Electromagnetic compatibility information.

Specifications

Defibrillator

Waveform: Biphasic Truncated Exponential. Waveform parameters adjusted as a function of patient impedance.

Shock Delivery: Via multifunction defib electrode pads.

Charge Time: Less than 3 seconds to 200 Joules with a new, fully charged M3516A SLA battery pack at 25°C. Less than 15 seconds to 200 Joules when powered by a M3517A or M3518A power module with no battery installed.

Patient Impedance Range: 25 to 180 Ohm.

Manual Mode

Manual Output Energy (Delivered): 5, 10, 25, 50, 70, 100, 150, 200 Joules.

Controls: On/Energy Select, Off, Charge/Disarm, Shock, ECG Lead Select, SpO₂, HR Alarms, Manual Mode, Sync, Pacer, Pacer Start/Stop, Pacer Rate, Pacer Current, Pacer Mode, Display Contrast, ECG Gain, Volume, Print Strip, Print Summary, Annotated Mark Event.

Indicators: LCD display for ECG waveform and text prompts, Audio alerts, QRS Beeper, Charging Tone, Charge Done Tone, Manual Mode LED, Sync LED, Pacer LED, Printer.

Armed Indicators: Charge done tone and available energy indicated on display.

Energy Selection: Front Panel "1" key.

Charge Control: Front Panel "2" key.

Shock Control: Front Panel "3" key.

Synchronizer: SYNC message appears on the monitor and is annotated on the printer (if printing while in Sync Mode). An audible beep sounds with each detected R-wave, while a tick mark on the monitor and printed strip indicate the discharge points. Synchronizer delay is less than 60 msec from peak R-wave to peak current of the defibrillation discharge.

Defibrillator (cont.)

AED Mode

AED Energy Protocol: Fixed Energy (150 Joules).

AED Shock Series: 2, 3, or 4.

Shock Series Timer: off, 30, 60, 90, 120, 150, 180, or 210 seconds.

Text and Voice Prompts: Extensive text audible messages guide user through protocol.

Protocol: Follows pre-configured settings. Can be configured to meet American Heart Association and European Resuscitation Council guidelines.

AED Controls: On, Off, Pause/Resume, Analyze/Stop Analysis, Shock, Lead Select, SpO₂, HR Alarms, Display Contrast, ECG Gain, Volume, Print Strip, Print Summary, Annotated Mark Event, Manual Mode Entry.

Indicators: LCD Display for ECG waveform and text prompts, Audio Alerts, Voice Prompts, QRS Beeper, Charging Tone, Charge Done Tone, Printer.

Armed Indicators: Charge Done Tone, Available Energy indicated on display, Voice Message.

Patient Analysis: Per protocol, evaluates patient ECG and signal quality to determine if a shock is appropriate and evaluates connection impedance for proper defibrillation pad contact.

Shockable Rhythms: Ventricular fibrillation with amplitude > 100 uV and wide complex ventricular tachycardia with rates greater than 150 bpm.

Sensitivity and Specificity: Meets AAMI guidelines.

ECG Monitoring

Inputs: Single channel ECG may be viewed on display and printed. PADS ECG is obtained through two multifunction defibrillation electrode pads. Lead I, II, or III is obtained through the 3-lead ECG cable and separate monitoring electrodes. With a 5-lead cable, lead aVR, aVL, aVF, or V can also be obtained.

Lead Fault: LEADS OFF message and dashed line appear on the monitor if a lead electrode or wire becomes disconnected.

Pad Fault: PADS OFF message and dashed line appear on the monitor if a pad becomes disconnected.

Heart Rate Display: Digital readout on display from 15 to 300 bpm, with an accuracy of $\pm 10\%$.

Heart Rate Alarms: Configurable pairs of low and high heart rate alarm limits: 30 to 100, 60 to 140, 90 to 160, and 120 to 200 bpm.

Defibrillation Patient Cable Length: 7 ft (2.13 m).

ECG Cable Length: 10 ft (3.05 m).

Common Mode Rejection: Greater than 90 dB measured per AAMI standards for cardiac monitors (EC 13).

ECG Size: 2.5, 5, 10, 20, 40 mm/mV.

Frequency Response:

AC Line Filter: 60 Hz/50Hz.

Pads ECG for Display: Monitor (.15-40 Hz)/EMS (1-30 Hz).

Pads ECG for Printer: Monitor (.15-40 Hz)/EMS (1-30 Hz).

Leads ECG for Display: Monitor (.15-40 Hz)/EMS (1-30 Hz).

Leads ECG for Printer: Diag (.05-150 Hz)/EMS (1-30 Hz)/
Monitor (.15-40 Hz).

Patient Isolation (defibrillation proof):

ECG: Type CF

SpO₂: Type CF

Defib: Type BF (multi-function defib electrode pads)

Display

Display Size: 96 mm x 72 mm.

Display Type: Transflective active matrix LCD with LED backlight.

Display Resolution: 320 x 240 pixels.

Sweep Speed: 25 mm/s nominal (stationary trace; sweeping erase bar).

Viewing Time: 4 seconds.

Thermal Array Printer

Continuous Real Time Strip: User starts and stops the print strip. The Print Strip prints the selected ECG lead with the following data:

HEADER 1: Date, Time, Heart Rate, the SpO₂ Value (if available), and the text "Delayed" if the recording has been configured for Delayed Mode. Prints every 12 seconds.

HEADER 2: Current mode (AED/Manual) the current Lead, the current Gain, filter setting, the text "Sync" if Sync has been enabled, and the Pacer Settings (consisting of the Pacer Mode, Rate, and Current (if currently pacing the patient)). Prints every 12 seconds, with Header 1.

HEADER 3: Changes in Mode, Gain, Lead, Sync, and Pacer Settings.

FOOTER: Drug Annotations, HR/SpO₂ limits on a Limit Alarm, the Results of an Analysis in AED Mode (No Shock Advised, Shock Advised, or Cannot Analyze), Charging to xxxJ, Shock Delivered, No Shock Delivered, Disarm, Battery Low, Battery Critical.

SYMBOLS: Mark Triangle (for presses of the Mark key), an Alarm Bell (Alarm Limit Violations), Lightning Bolt (Shock Delivered), Vertical stripe Boundries/Pacer/Sync Tick Marks).

Event Printing: Mark Event key automatically documents events and ECG during defibrillation episodes. The Mark Event key can annotate the event with one of the following labels: Epinephrine, Atropine, Lidocaine, and Other.

Thermal Array Printer (cont.)

Auto Printing: The printer can be configured to automatically print on Mark, Charge, Shock and Alarm.

Delayed Printing: The printer can be configured to run real time or with a six second delay.

Reports: The following can be printed: Event Summary, Configuration, Extended Self Test, System Log.

Speed: 25 mm/s with an accuracy of $\pm 5\%$.

Amplitude Accuracy: $\pm 10\%$ or ± 50 uV, whichever is greater.

Paper Size: 50 mm by 30 m (100 ft).

Battery and Battery Power Module

Battery Type: 2 Ah, 12V, rechargeable, Sealed Lead Acid.

Battery Dimensions: 2.4" (H) x 0.94" (W) x 7.2" (D).
61.7 mm (H) x 23.9 mm(W) x 182 mm (D).

Weight: 1.4 lb (0.65 kg).

Charge Time:

Approximately 14.5 hours to 100%, indicated by LED on power module.

Approximately 2.5 hours to 90%, indicated by LED on power module.

Capacity: 2.7 hours ECG monitoring or 50 full-energy discharges or 2.1 hours ECG monitoring while pacing (with a new, fully charged battery and temperature above 20°C).

Battery Indicators: LOW BATTERY message appears on monitor when at least 10 minutes of monitoring time and 6 maximum-energy discharges remain (with a new battery and temperature above 20°C).

Battery Storage: Should not be stored above 40°C for extended periods of time.

Charger Output: Unit can be operated using Class I AC power module alone with no battery installed.

Noninvasive Pacing

Waveform: Monophasic Truncated Exponential.

Current Pulse Amplitude: 10 mA to 200 mA (5 mA resolution); accuracy 10 mA - 50 mA \pm 5 mA, 50 mA - 200 mA \pm 10%.

Pulse Width: 20 ms with accuracy +0, -5 ms.

Rate: 30 ppm to 180 ppm (10 ppm increments); accuracy \pm 1.5%.

Modes: Demand or Fixed Rate.

Refractory Period: 340 msec (40 to 80 ppm); 240 msec (90 to 180 ppm).

SpO₂/Pulse Oximetry

Accuracy with:

M1191A sensor - 1 standard deviation 70% to 100%, \pm 2.5%.

M1192A sensor - 1 standard deviation 70% to 100%, \pm 2.5%.

M1194A sensor - 1 standard deviation 70% to 100%, \pm 4.0%.

NELLCOR sensors - 1 standard deviation 80% to 100% \pm 3.0%.

Resolution: 1%.

SpO₂ Alarm Limits: Three preset low alarm limits: 90, 85, and 80%, default is off.

INOP Alerts: Triggered by disconnected sensor, noisy signal, light interference or low signal (non-pulsatile).

Event Storage

Internal Event Summary:

The internal Event Summary stores up to 300 events and up to 50 waveforms. Events can be marked with a Mark Event symbol and, if configured for drug annotation, the following labels can be added: Epinephrine, Atropine, Lidocaine, or Other.

The Print Summary key on the front panel is used to print the internal Event Summary.

Data Card Event Summary:

One Data Card can store approximately 2 hours of continuous ECG waveforms and events.

General

Dimensions: 4.05" (H) x 11.25" (W) x 13.65" (D).
103 mm x 286 mm x 347 mm.

Weight: Standard Configuration weighs approximately 10 lbs (4.55 kg) including battery, full roll of paper, defibrillator patient cable, 1 set of pads, and without the carrying case.

Environmental

Temperature: 0° to 50°C operating, -20° to 70°C storage.

- Thermal paper may darken above 55°C.
- Charging the battery at temperatures above 35°C may degrade battery life.
- Storing the battery for extended periods at temperatures above 40°C will reduce battery capacity and degrade battery life.
- Operating and storage specifications for electrodes may vary. Refer to the manufacturer's specifications for details.

Humidity:

Up to 95% Relative Humidity

- Printer paper may jam if paper is wet.
- Thermal printer may be damaged if wet paper is allowed to dry while in contact with printer elements.

Altitude:

Operating: up to 15,000 ft.

Shipping: up to 20,000 ft.

Shock (drops onto concrete): Unit survives 39" (1 m) drops onto all surfaces (faces, corners, and edges) enclosed in carrying case. Exposed handle surfaces survive 24" drops.

Vibration: Mil Std 810E 514.4 Category 6 Helicopter, General Storage, UH60.

Water Resistance: IPX4, splash proof per IEC 60529, with Data Card door closed.

EMC: Meets EN 60601-1-2. This ISM device complies with Canadian ICES-001.

Other Considerations: Equipment not suitable for use in the presence of a flammable anesthetic mixture with air, oxygen, or nitrous oxide.

Mode of Operation: Continuous.

Symbol Definitions

The following table lists the meaning of each symbol shown on the HeartStart XLT and the M3516A battery.

Table 13-1 Defibrillator and Battery Symbols













Symbol	Definition
	On.
	Off.
	Shock hazard.
	Attention - See operating instructions in user's guide.
	Power module input.
	Input

Table 13-1 Defibrillator and Battery Symbols (Continued)

Symbol	Definition
	Meets IEC type BF leakage current requirements and is defibrillator protected (Patient Applied Part is isolated and defib-proof suitable for direct patient contact except the heart or major arteries.)
	Meets IEC type CF leakage current requirements and is defibrillator protected (Patient Applied Part is isolated and defib-proof suitable for direct patient contact including the heart and major arteries).
	Alarms are active.
	Alarms are inactive.
	Recyclable material.
	Must be recycled or disposed of properly.
	Unlock.
IPX4	Ingress of fluids classification; protected against splashing water.

The following table lists the symbols that appear on the HeartStart XLT shipping carton.

Table 13-2 Shipping Carton Symbols











Symbol	Definition
	Atmospheric pressure range.
	Temperature range.
	Relative humidity range.
	Recyclable paper product.
	Fragile.
	Right side up.
	Do not get wet.

Table 13-2 Shipping Carton Symbols (Continued)

Symbol	Definition
	Shelf life.
	Long-term storage conditions.
	Short-term transport storage.

Clinical Performance Summary - Defibrillation

An international, multicenter, prospective, randomized, clinical study was conducted to assess the effectiveness of the SMART Biphasic waveform in out-of-hospital sudden cardiac arrests (SCAs), as compared to monophasic waveforms. The primary objective of the study was to compare the percent of patients with ventricular fibrillation (VF) as the initial monitored rhythm that were defibrillated in the first series of three shocks or less.

This section summarizes the methods and results of this study.

Methods

Victims of out-of-hospital SCA were prospectively enrolled in four emergency medical service (EMS) systems. Responders used either 150J SMART Biphasic AEDs or 200-360J monophasic waveform AEDs. A sequence of up to three defibrillation shocks were delivered. For the biphasic AEDs, there was a single energy output of 150J for all shocks. For monophasic AEDs, the shock sequence was 200, 200, 360J. Defibrillation was defined as termination of VF for at least five seconds, without regard to hemodynamic factors.

Results

Randomization to the use of monophasic or SMART Biphasic automatic external defibrillators (AEDs) was done in 338 SCAs from four emergency medical service systems. VF was observed as the first monitored rhythm in 115 patients. The biphasic and monophasic groups for these 115 patients were similar in terms of age, sex, weight, primary structural heart disease, cause or location of arrest, and bystanders witnessing the arrest or performing CPR.

The 150J SMART Biphasic waveform defibrillated 98% of VF patients in the first series of three shocks or less, compared with 69% of patients treated with monophasic waveform shocks. Outcomes are summarized in Table 13-3.

Table 13-3 Clinical Summary - Defibrillation

	Biphasic Patients Number/(Percent)	Monophasic Patients Number/(Percent)	P Value (chi-square)
Defibrillation Efficacy			
Single shock only	52/54 (96%)	36/61 (59%)	<0.0001
≤2 shocks	52/54 (96%)	39/61 (64%)	<0.0001
≤3 shocks	53/54 (98%)	42/61 (69%)	<0.0001
Patients Defibrillated	54/54 (100%)	49/58 (84%)	0.003
Return of Spontaneous Circulation	41/54 (76%)	33/61 (54%)	0.01
Survival to Hospital Admission	33/54 (61%)	31/61 (51%)	0.27
Survival to Hospital Dis- charge	15/54 (28%)	19/61 (31%)	0.69
CPC = 1 (Good)	13/15 (87%)	10/19 (53%)	0.04

Conclusion

The 150J SMART Biphasic waveform defibrillated at higher rates than 200-360J monophasic waveforms, resulting in more patients achieving return of spontaneous circulation (ROSC) (p=0.01). EMS system outcomes of survival discharge were not significantly different statistically. However, patients resuscitated with the lower energy SMART Biphasic waveform were more likely to have good cerebral performance (CPC, cerebral performance category) (p=0.04).

Clinical Performance Summary - Cardioversion

An international, multicenter, prospective, double-blinded, randomized, clinical trial was conducted to assess the effectiveness of the SMART Biphasic waveform in treatment of atrial fibrillation (AF), as compared to monophasic waveforms. The primary objective of the study was to determine the required energy for cardioversion of AF using the SMART Biphasic waveform, as compared with a monophasic damped sine waveform.

This section summarizes the methods and results of this study.

Methods

Patients enrolled for this study were adults scheduled for elective cardioversion of AF at one of 11 clinical sites. Clinicians used both a defibrillator delivering the SMART Biphasic waveform, and one delivering a monophasic waveform. A sequence of up to five shocks was administered: four with the initial defibrillator, and a fifth cross-over shock was delivered with the other defibrillator if necessary. The sequence of energy settings was 100J, 150J, 200J through the first three shocks on either type of defibrillator. A fourth shock, if necessary, was delivered at 200J if the initial defibrillator was biphasic, and at 360J if the initial defibrillator was monophasic. The cross-over shock was 360J monophasic if the initial defibrillator was biphasic, and 200J biphasic if the initial defibrillator was monophasic. Successful cardioversion was defined as the occurrence of two P waves uninterrupted by atrial fibrillation within 30 seconds of the shock.

Results

Randomization to the use of monophasic or SMART Biphasic defibrillators was done in 212 elective cardioversions involving 210 patients at eleven clinical sites in the United States and Europe. Of these, 203 results met the protocol criteria for inclusion in this analysis. The biphasic and monophasic groups were similar in terms of age, sex, weight, current medical history, cause of heart disease, and estimated ejection fraction.

The 150J SMART Biphasic waveform successfully converted far more patients with an initial 100J shock (60% compared with 22% for the monophasic waveform), and successfully converted patients at least as well with a maximum energy of 200J as the monophasic did with its maximum energy of 360J (91% compared to 85% for the monophasic waveform). Overall, the biphasic waveform required fewer shocks (1.7, compared to 2.8 for the monophasic waveform) and lower delivered energy (217J, compared to 548J for the monophasic waveform). Outcomes are summarized in , Table 13-4.

Table 13-4 Clinical Summary - Cardioversion

	Biphasic Patients Number (Percent)	Monophasic Patients Number (Percent)	P Value
Cumulative Cardioversion Efficacy			
Single shock only	58/96 (60%)	24/107 (22%)	<0.0001
≤2 shocks	74/96 (77%)	47/107 (44%)	<0.0001
≤3 shocks	86/96 (90%)	57/107 (53%)	<0.0001
≤4 shocks	87/96 (91%)	91/107 (85%)	.29
Skin "burn"			
None	25/90 (28%)	15/105 (14%)	0.0001
Mild	50/90 (56%)	47/105 (45%)	
Moderate	15/90 (17%)	41/105 (39%)	
Severe	0/90 (0%)	2/105 (2%)	
Number of shocks	1.7 ± 1.0	2.8 ± 1.2	<0.0001
Cumulative delivered energy	217 ± 176J	548 ± 331J	<0.0001
Skin reaction definitions: (Evaluated 24 - 48 hours after procedure)			
Mild - erythema, no tenderness			
Moderate - erythema, tenderness			
Severe - blistering or necrosis, tenderness			

Conclusion

The SMART Biphasic waveform cardioverted at higher rates than the monophasic damped sine waveform at each step of the protocol, although the cumulative biphasic rate after 4 shocks was not significantly different from the monophasic rate. Tissue damage was more pronounced in the monophasic population.

Safety Considerations

The following general warnings and cautions apply to use of the HeartStart XLT. Additional warning and cautions specific to a particular feature are provided in the appropriate section.

WARNING

The HeartStart XLT is not intended to be deployed in settings or situations that promote use by untrained personnel. Operation by untrained personnel can result in injury or death.

WARNING

Remain attentive to the patient during the delivery of therapy. Delay in delivering a shock may result in a rhythm that was analyzed as shockable converting spontaneously to non-shockable and could result in inappropriate delivery of a shock.

WARNING

Use only the multifunction defib electrode pads, battery, and accessories listed in "Supplies & Accessories" on page 11-18. Substitutions may cause the HeartStart XLT to function improperly.

WARNING

Use multifunction defib electrode pads prior to their expiration date. Discard pads after use. Do not reuse pads.

WARNING

In AED Mode, the multifunction defib electrode pads must be in the anterior-anterior position as shown on the packaging. The HeartStart XLT was not designed to assess data acquired from pads in an anterior-posterior position.

WARNING

Do not allow multifunction defib electrode pads to touch each other or to touch other ECG monitoring electrodes, lead wires, dressings, etc. Contact with metal objects may cause electrical arcing and patient skin burns during defibrillation and may divert current away from the heart.

WARNING

During defibrillation, air pockets between the skin and multifunction defib electrode pads may cause patient skin burns. To help prevent air pockets, make sure the pads completely adhere to the skin. Do not use dried out pads; do not open pads package until just prior to use.

WARNING

Never touch the patient or any equipment connected to the patient (including the bed or gurney) during defibrillation.

WARNING

Do not operate the HeartStart XLT in standing water. When using the HeartStart XLT in wet environments, make sure the Data Card door is securely shut.

WARNING

Do not immerse, or pour fluids on, any portion of the HeartStart XLT.

WARNING

Do not use the HeartStart XLT in a flammable or oxygen-rich atmosphere. This can cause an explosion hazard.

WARNING

Avoid connecting the patient to several devices at once. Leakage current limits may be exceeded. Do not use a second defibrillator on the patient while pacing with the HeartStart XLT.

WARNING

Avoid contact between the patient and conductive fluids and/or metal objects, such as the gurney. Contact with metal objects could cause unintentional current pathways.

WARNING

Operating the HeartStart XLT or its accessories in conditions outside the environmental specifications can result in device or accessory malfunction.

WARNING

Avoid exposing the display to direct sunlight on a hot day. Overheating can occur and cause the display to black out, making the HeartStart XLT temporarily unusable.

WARNING

Medical electrical equipment which does not incorporate defibrillator protection should be disconnected during defibrillation.

WARNING

Electric shock hazards exist internally. Do not remove assembly screws. Refer servicing to qualified personnel.

CAUTION

This device has not been evaluated for use with electrosurgery equipment.

Electromagnetic Compatibility

When using the M3500B defibrillator/monitor (with or without the M3517A AC Charger), electromagnetic compatibility with surrounding devices should be assessed.

A medical device can either generate or receive electromagnetic interference. Testing for electromagnetic compatibility (EMC) of the M3500B with and without the appropriate accessories has been performed according to the international standard for EMC for medical devices (IEC 60601-1-2). This IEC standard has been adopted in Europe as the European Norm (EN 60601-1-2).

The EMC standards describe tests for both emitted and received interference. Emission tests deal with interference generated by the device being tested. According to the EMC standards, the M3517A AC Power Module does not generate interference.

WARNING

Radio frequency (RF) interference from nearby transmitting devices may degrade performance of the HeartStart XLT defibrillator/monitor. Electromagnetic compatibility with surrounding devices should be assessed prior to using the defibrillator.

Reducing Electromagnetic Interference

The M3500B defibrillator/monitor and M3517A AC Charger are susceptible to interference from other RF energy sources and continuous, repetitive, power line bursts. Examples of other sources of RF interference are medical devices, cellular products, information technology equipment and radio/television transmission. Should interference be encountered, as demonstrated by artifact on the ECG or dramatic variations in SpO₂ values, attempt to locate the source. Assess:

- Is the interference intermittent or constant?
- Does the interference occur only in certain locations?
- Does the interference occur only when in close proximity to certain medical devices?
- Does the SpO₂ value change dramatically when the M3517A AC Charger is unplugged?

Once the source is located, attempt to attenuate the EMC coupling path by distancing the defibrillator from the source as much as possible. If assistance is needed, call your local service representative.

Restrictions for Use

Artifact on the ECG caused by electromagnetic interference should be evaluated by a physician or physician authorized personnel to determine if it will negatively impact patient diagnosis or treatment.

Immunity Level

The EMC standards state that manufacturers of patient-coupled equipment must specify immunity levels for their systems. It is recognized that the HeartStart XLT defibrillator/monitor is designed to receive and amplify low level signals in the same bandwidth as the interference.

Immunity is defined in the standard as the ability of a system to perform without degradation in the presence of an electromagnetic disturbance. Degradation in ECG quality is a qualitative assessment which can be subjective.

Caution should, therefore, be taken in comparing immunity levels of different devices. The criteria used for degradation is not specified by the standard and may vary with the manufacturer.

NOTE

For additional information about compliance with the EMC standards, please see the Philips Medical web site at <http://www.medical.philips.com/cms> and follow the regulatory link.

- A**
- AC Power Module. See Power modules
 - Accessories
 - arranging 10-6
 - checking 11-5
 - ordering 11-18, 13-19
 - AED Mode 3-1
 - configuring 3-4, 10-10
 - CPR 3-12
 - defibrillation process 3-6
 - display 2-5, 2-7
 - ECG monitoring 4-1
 - enabling from Manual Mode 6-6
 - events recorded 9-3
 - Events Summary 9-2
 - indications for use 1-3
 - overview 1-1, 3-2, 3-3
 - pausing 3-12, 3-15
 - preparation 3-5
 - re-analysis 3-11
 - rhythm monitoring 3-14
 - specifications 13-3
 - SpO2 monitoring 5-1
 - training required 1-3
 - troubleshooting 3-18
 - Alarms
 - heart rate 4-6, 8-2
 - interruption of power 9-5
 - SpO2 monitoring 5-8
 - symbols 13-11
 - Analysis 3-8
 - AED Mode 3-8
 - re-analysis 3-11
 - settings 3-4
 - Artifact Detected message 3-18
 - Asynchronous defibrillation 1-4
 - Asystole 1-5
 - pacing 1-5
 - Attach Pads message 12-5
 - Audiovisual controls 2-2, 2-3
 - Automatic Re-analysis 3-11
 - setting 3-4, 10-11
- B**
- Batteries 1-2, 2-9
 - charging 11-8
 - checking 11-6
 - inserting and removing 2-9
 - maintenance 11-8
 - operational checks 11-3
 - ordering 11-21
 - specifications 11-9, 13-6
 - storing and discarding 11-9
 - symbols 13-10
 - troubleshooting 12-2
 - See also Power supply
 - Battery Capacity Test 11-7
 - Battery charger 11-21
 - Bradycardia 1-5

- C**
- Cables
 - checking 11-5
 - cleaning 11-14
 - connecting 2-2, 3-6
 - ECG 10-4
 - Pads 3-6, 10-2
 - SpO2 5-6, 10-5
 - Cal Pulse 2-3
 - Carrying case
 - arranging accessories in 10-6
 - cleaning 11-12
 - ordering 11-21
 - removing & replacing 11-15
 - Check Patient Timer
 - setting 10-11
 - Check Printer message 12-5
 - Cleaning
 - carrying case 11-12
 - HeartStart XLT 11-12
 - pads, electrodes & cables 11-14
 - power modules 11-13
 - printer printhead 11-13
 - Clinical Performance 13-14, 13-16
 - Configuration 10-7
 - accessing menu 10-7
 - AED Mode 3-4
 - Automatic Re-analysis 3-4
 - default 10-15
 - Device Initiated Analysis 3-4
 - ECG filters 10-14
 - heart rate alarm 4-6
 - list of configurable items 10-8
 - modifying 10-15
 - password 10-13
 - printing settings 10-16
 - Rhythm Monitoring 3-4, 3-14
 - saving and loading from Data Card 10-16
 - Configuration Lost message 12-2
 - Continued Use feature 9-5
 - Controls 2-2
 - CPR 3-12
- D**
- Data Card 2-11
 - downloading and erasing information 9-1
 - inserting and removing 2-12
 - ordering 11-20
 - saving and loading settings 10-16
 - specifications 13-8
 - troubleshooting 12-2, 12-6
 - Date 10-9, 12-8
 - DC Power Module. See Power modules
 - Default settings. See Configuration
 - Defib Disarmed message 12-5
 - Defib electrode pads. See Pads
 - Defibrillation 1-1
 - AED Mode 3-3, 3-6
 - defined 1-3
 - Manual Mode 6-4
 - pacing 8-6
 - Defibrillation controls 2-3
 - Defibrillator. See HeartStart XLT

Device Initiated Analysis
settings 3-4, 10-11

Display

AED Mode 2-7

controls 2-2

layout 2-5

Manual Mode 2-8

specifications 13-5

troubleshooting 12-8

E

ECG analysis. See
Analysis

ECG cables

cleaning 11-14

connecting 10-4

ordering 11-20

See also Cables

ECG electrodes. See
Electrodes

ECG Fault message 12-2

ECG Filter Settings 10-14

ECG monitoring 4-1

controls 2-3

electrodes 4-2, 10-10

events recorded 9-3

heart rate alarm 4-6

leads 4-5

settings 10-10, 10-12,
10-14

signal quality 4-8

size 4-7

specifications 13-4

synchronized

cardioversion 7-1

troubleshooting 4-7

Electrode pads. See Pads

Electrodes

applying 4-2

checking 11-3

cleaning 11-14

ordering 11-20

placing 3-5, 4-3

settings 10-10

Electromagnetic

compatibility (EMC)
13-22

Environmental

specifications 13-9

safety precautions 13-
20, 13-21

Erratic spiking 1-4

European 10-11

European Protocol 10-11

Event Review 2-11

Event Summary 9-1

events recorded 9-3

information included
9-6

interruption of power
9-5

marking events 9-2

printing 9-6, 9-8

specifications 13-8

F

Failure message 8-7

H

Heart rate alarm

disabling 4-7

events recorded 9-3

interruption of power
9-5

pacing 8-2

settings 4-6

specifications 13-4

See also ECG

monitoring

HeartStart Event Review
9-1

HeartStart XLT 1-1
assessment of 1-3
cleaning 11-12
configuring 10-7
controls 2-2
operational checks 11-3, 11-4
safety precautions 13-20
specifications 13-2, 13-8
symbols 13-10
training materials 1-7
training required 1-3
troubleshooting 12-7

HR alarm. See Heart rate alarm

Hypothermia
pacing 1-5
SpO2 monitoring 5-1

I

Incident number. See Event Summary

Incident Timer 2-6

Incompatible Data Card message 12-6

Indications for use
AED mode 1-3
Manual Mode 1-4
pacing 1-5
SpO2 monitoring 1-6

INOP Alerts 13-7

K

Key Inactive message 3-18, 8-7, 12-6

L

Leads
formation 4-3
Lead Select setting 10-12
selecting 4-5, 7-1, 8-3
troubleshooting 4-7, 8-7, 12-2

Leads Off message 4-7, 8-7, 12-2

Loading
printer paper 11-10
settings from Data Card 10-16

Low Battery message 12-2

M

Maintenance
batteries 11-8
carrying case 11-15
cleaning 11-12
operational checks 11-2
supplies and accessories 11-18

Manual Mode 6-1
controls 2-2, 2-4
current charge 6-4
defibrillation process 6-4
delivering shock 6-5
display 2-5, 2-8
ECG monitoring 4-1
enabling 2-5, 6-2
energy setting 6-4
Events Summary 9-2
indications for use 1-4
overview 1-1
password 10-13
preparation 6-3
returning to AED Mode 6-6
settings 10-10
specifications 13-2
SpO2 monitoring 5-1
training required 1-3

Marking events 9-2
See also Event Summary

Messages
defined 2-7
list of 12-2

Momentary messages 2-7
list of 12-5

Monitoring. See ECG monitoring

Monitoring electrodes.
 See Electrodes
 Monitoring Rhythm. See
 Rhythm Monitoring
 Multifunction defib
 electrode pads. See
 Pads

N

Nellcor sensors 5-3
 No Data Card Present
 message 12-6
 No Pads message 12-3
 No Shock Advised Timer
 3-17, 10-12
 No Shock Delivered
 message 3-18, 12-5
 Non Pulsatile message 5-
 10, 5-11
 Noninvasive
 transcutaneous
 pacing. See Pacing

O

Operational checks 11-2
 Output Low message 8-7
 Oxygen saturation. See
 SpO2 monitoring

P

Pace Pulse Markers 10-10

Pacemakers
 AED therapy 1-4
 heart rate alarm 4-6
 Pacing 8-1
 defibrillation 8-6
 defined 1-5, 8-1
 demand v. fixed mode
 8-2, 8-4, 8-6
 ECG monitoring 8-2
 events recorded 9-4
 function buttons 2-5
 indications for use 1-5
 messages 12-3
 preparation 8-3
 procedure 8-4
 selecting leads 8-3, 8-
 7
 specifications 13-7
 system messages 8-7
 troubleshooting 8-5,
 8-7, 12-6

Pads
 applying 3-6, 13-19,
 13-20
 cleaning 11-14
 ECG monitoring 4-1,
 4-7
 events recorded 9-3
 safety precautions 13-
 19
 troubleshooting 3-18,
 12-3, 12-5
 Pads Cable Off message
 3-18, 12-3
 Pads cables
 cleaning 11-14
 connecting 10-2
 See also Cables
 Pads Off message 3-18, 4-
 7, 12-3
 Paper. See Printer paper
 Password 10-13
 exiting 6-2
 Patient information. See
 Data Card
 Pausing
 AED Mode 3-12, 3-15
 settings 10-12
 Post 10-11
 Post Shock CPR Timer 3-
 17, 10-11

Power modules 2-9
 cleaning 11-13
 electromagnetic
 compatibility 13-22
 ordering 11-21
 specifications 13-2
Power supply
 checking 11-6
 events recorded 9-3
 interruption of power 9-5
 overview 2-9
 specifications 13-2
 troubleshooting 12-7
 See also Batteries

Precautions 13-19
 asystole 1-5
 batteries 11-9
 defibrillation current (shock) 3-10
 ECG analysis 3-9
 electrodes 4-2
 electromagnetic
 compatibility 13-22
 heart rate alarms 4-6, 8-2
 pacemakers 1-4, 4-6
 rhythm monitoring 3-14
 safety symbols 13-10
 sensors 5-5, 5-9
 SpO2 alarm 5-8
 SpO2 monitoring 5-1

Print strip
 contents 13-5
 controls 2-2
 events recorded 9-4
 settings 10-9
 See also Event Summary

Printer
 checking 11-6
 cleaning printhead 11-13
 specifications 13-5

Printer paper
 loading 11-10
 ordering 11-18
 specifications 13-9
 troubleshooting 12-5

Printing
 controls 2-3
 Event Summary 9-6
 events automatically 9-8
 settings 10-16
Pulse, checking 3-12, 5-10, 5-11
Pulse oximetry
 defined 1-6, 5-1
 described 5-2
 specifications 13-7
 See also SpO2 monitoring

Q

QRS beeper 4-6
 adjusting 2-2
 settings 10-10
 troubleshooting 4-8

R

Radio frequency (RF) interference 13-22
Re-analysis 3-4, 3-11
Recording events. See Event Summary

RF interference 13-22
 Rhythm Monitoring 3-4,
 3-14
 AED Mode 3-8
 configuring 3-14, 10-
 11
 events recorded 9-3

S

Safety precautions. See
 Precautions
 Saving settings to Data
 Card 10-16
 Security (password) 10-
 13
 Semi-Automatic External
 Defibrillation. See
 AED Mode
 Sensors 5-3
 applying 5-5
 caring for 5-9
 cleaning 11-14
 ordering 11-20
 selecting 5-3
 troubleshooting 12-4
 Service 12-9
 Settings. See
 Configuration
 Shipping carton symbols
 13-12

Shock
 AED Mode 3-9
 events recorded 9-3
 settings 10-11
 troubleshooting 3-18,
 12-5
 Shock Series Timer 10-11
 Softkeys 2-3
 See also Controls
 Specifications
 AED Mode 13-3
 batteries 13-6
 defibrillator 13-2
 display 13-5
 ECG monitoring 13-4
 environmental 13-9
 Event Summary 13-8
 HeartStart XLT 13-8
 Manual Mode 13-2
 pacing 13-7
 power supply 13-2
 printer 13-5
 SpO2 monitoring 13-7
 SpO2 alarm 5-8
 specifications 13-7
 SpO2 cable
 cleaning 11-14
 connecting 10-5
 ordering 11-20
 SpO2 Light Interf
 message 5-10

SpO2 monitoring 5-1
 cable connection 5-6
 controls 2-3
 defined 1-6, 5-1
 discontinuing 5-9
 events recorded 9-4
 inaccuracies 1-6
 indications for use 1-6
 noisy signal 5-10
 procedure 5-7
 process 5-2
 sensors, applying 5-5
 sensors, caring for 5-9,
 11-14
 settings 10-12
 specifications 13-7
 troubleshooting 5-10,
 12-4
 SpO2 Noisy Signal
 message 5-10
 SPO2 Non Pulsatile
 message 12-4
 Stop message 8-7
 Stop Pacer message 12-6
 Strip. See Print strip
 Supplies
 checking 11-5
 ordering 11-18
 Symbols, list of 13-10
 Sync After Shock setting
 10-13

Index

- Sync control 2-5
 - Synchronized
 - cardioversion 7-1
 - delivering shock 7-2
 - disabling Sync Mode 7-4
 - enabling 2-5
 - indications for use 1-4
 - preparation 7-2
 - selecting leads 7-1
 - synchronizer
 - specifications 13-2
 - System Failure Service
 - Unit message 12-3
 - System messages 2-7
 - list of 12-2
 - System tests. See Maintenance
- T**
- Telephone assistance 12-9
 - Thermal Array Printer.
 - See Printer
 - Time 10-9, 12-8
 - Training materials 1-7
 - Training required 1-3, 13-19
- U**
- Troubleshooting 12-1
 - AED Mode 3-18
 - Data Card 12-6
 - display 12-7
 - ECG monitoring 4-7
 - pacing 8-5, 8-7, 12-3, 12-6
 - SpO2 monitoring 5-10, 12-4
 - time and date 12-8
- V**
- User messages 2-7
 - Ventricular fibrillation
 - manual defibrillation 1-4
 - pacing 1-5
 - Ventricular tachycardia 1-4
- W**
- Warnings. See Precautions
 - Web site 12-9

M3500-91900
Edition 3
Copyright © 2002
Philips Electronics
North America Corporation
Printed in the U.S.A. October 2002



Free Manuals Download Website

<http://myh66.com>

<http://usermanuals.us>

<http://www.somanuals.com>

<http://www.4manuals.cc>

<http://www.manual-lib.com>

<http://www.404manual.com>

<http://www.luxmanual.com>

<http://aubethermostatmanual.com>

Golf course search by state

<http://golfingnear.com>

Email search by domain

<http://emailbydomain.com>

Auto manuals search

<http://auto.somanuals.com>

TV manuals search

<http://tv.somanuals.com>