

DVD Video Home Theatre System

MX2500D/78

User manual

Visit us at www.p4c.philips.com for service support



PHILIPS

México



Es necesario que lea cuidadosamente su instructivo de manejo.

	PRECAUCIÓN - ADVERTENCIA No abrir, riesgo de choque eléctrico	
	ATENCIÓN Verifique que el voltaje de alimentación sea el requerido para su aparato	
Para evitar el riesgo de choque eléctrico, no quite la tapa. En caso de requerir servicio, dirijase al personal calificado.		

Descripción: **Reproductor de Disco de Video Digital**
Modelo : **MX2500D/78**
Alimentación: **110-127 / 220-240V~; 50-60 Hz**
Consumo: **120 W**
Importador: **Philips Mexicana, S.A. de C.V.**
Domicilio: **Av. La Palma No. 6**
Col. San Fernando La Herradura
Huixquilucan
Localidad y Tel: **Edo. de México C.P. 52784**
Tel. 52 69 90 00
Exportador: **Philips Electronics HK, Ltd.**
País de Origen: **China**
N° de Serie: _____

**LEA CUIDADOSAMENTE ESTE INSTRUCTIVO
ANTES DE USAR SU APARATO.**

AVISO IMPORTANTE

Philips Mexicana, S.A. de C.V. no se hace responsable por daños o desperfectos causados por:

- *Maltrato, descuido o mal uso, presencia de insectos o roedores (cucarachas, ratones etc.).*
- *Cuando el aparato no haya sido operado de acuerdo con el instructivo del uso, fuera de los valores nominales y tolerancias de las tensiones (voltaje), frecuencia (ciclaje) de alimentación eléctrica y las características que deben reunir las instalaciones auxiliares.*
- *Por fenómenos naturales tales como: temblores, inundaciones, incendios, descargas eléctricas, rayos etc. o delitos causados por terceros (choques asaltos, riñas, etc.).*

CAUTION

Use of controls or adjustments or performance of procedures other than herein may result in hazardous radiation exposure or other unsafe operation.

ATENCIÓN

El uso de mando o ajustes o la ejecución de métodos que no sean los aquí descritos puede ocasionar peligro de exposición a radiación.

English ----- 8

Español ----- 36

Português ----- 68

English

Español

Português

Manufactured under license from Dolby Laboratories. “Dolby”, “Pro Logic” and the double-D symbol are trademarks of Dolby Laboratories. Confidential Unpublished Works. ©1992-2000 Dolby Laboratories, Inc. All right reserved.

IMPORTANT NOTE

Due to the numerous versions of new CD-Audio copy protection or enhanced CD-Audio protection recently available on certain discs, Philips is unable to guarantee that this DVD system is fully compatible with such new discs. Should you have difficulty playing such CD-Audio discs, kindly refer them to your CD-Audio disc retailer.

Environmental information

All unnecessary packaging has been omitted. We have tried to make the packaging easy to separate into three materials: cardboard (box), polystyrene foam (buffer) and polyethylene (bags, protective foam sheet).

Your system consists of materials which can be recycled and reused if disassembled by a specialised company. Please observe the local regulations regarding the disposal of packaging materials, exhausted batteries and old equipment.

‘CONSUMERS SHOULD NOTE THAT NOT ALL HIGH DEFINITION TELEVISION SETS ARE FULLY COMPATIBLE WITH THIS PRODUCT AND MAY CAUSE ARTIFACTS TO BE DISPLAYED IN THE PICTURE. IN CASE OF 525 OR 625 PROGRESSIVE SCAN PICTURE PROBLEMS, IT IS RECOMMENDED THAT THE USER SWITCH THE CONNECTION TO THE ‘STANDARD DEFINITION’ OUTPUT. IF THERE ARE QUESTIONS REGARDING OUR TV SET COMPATIBILITY WITH THIS MODEL 525p AND 625p DVD PLAYER, PLEASE CONTACT OUR CUSTOMER SERVICE CENTRE.’

Contents

General Information

Supplied accessories	5
Care and safety information	5

Connections

Step 1: Placing the speakers and subwoofer ..	6
Step 2: Connecting speakers and subwoofer ..	7
Step 3: Connecting TV	8
Using Composite Video jack	8
Using Component Video jack (Y Pr/Cr Pb/Cb)	8
Using S-Video jack	9
Using an accessory RF modulator	9
Step 4: Connecting FM/MW antennas	10
Step 5: Connecting the power cord	10

Connections (optional)

Connecting a VCR or Cable/Satellite Box ...	11
Viewing and listening to the playback	11
Using the VCR for recording DVD playback	11
Connecting digital audio equipment	11
Digital Recording	11

Functional Overview

Main unit and remote control	12
Control buttons available on the remote only	13

Getting Started

Step 1: Inserting batteries into the remote control	14
Using the remote control to operate the system	14
Step 2: Setting the TV	14
Selecting the colour system that corresponds to your TV	15
Setting the TV shape	15
Step 3: Setting the speakers	16
Test Tone – turning on/off	16
Adjusting the delay time	16
Adjusting the speaker output levels	16
Step 4: Setting language preferences	17
On-screen display (OSD) language	17
Audio, Subtitle and Disc Menu language ..	17

Disc Operations

Playable discs	18
Playing discs	18
Using the Disc Menu	19

Basic playback controls	19
Resuming playback from the last stopped point (DVD/VCD/CD)	19
Selecting various repeat functions	20
Repeat play mode	20
Repeating a section within a chapter/track	20
Programme favourite tracks (audio CDs and VCDs)	20
Clearing the programme	20
Using the menu bar to programme	21
Playing MP3/Picture disc (Kodak, JPEG)	21
JPEG and MP3 simultaneously playback ...	21

DVD Setup Menu Options

Using the menu bar	22
Using the Setup Menu	23
Setting the video output	23
Screen saver – turning on/off	24
Setting the digital output	24
Night mode – turning on/off	25
Restoring the original settings	25
Restricting playback by parental control ..	26
Changing the password	27

Tuner Operations

Tuning to radio stations	28
Presetting radio stations	28
Automatic presetting	28
Manual presetting	28
Selecting a preset radio station	28
Deleting a preset radio station	28
Changing tuning grid	29

Other Functions

Setting the Sleep timer	29
Sound Control	30
Selecting surround sound	30
Selecting digital sound effects	30
Volume Control	30
Dimming system's display screen	30
Using the remote to operate 'Philips' television	30

Specifications

31

Troubleshooting

32–33

Glossary

34–35

Supplied accessories

Composite video cable (yellow)



Audio cable (white, red)

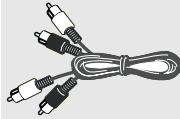

FM wire antenna



MW loop antenna



Remote Control and two AA batteries (12nc: 3139 228 04481)

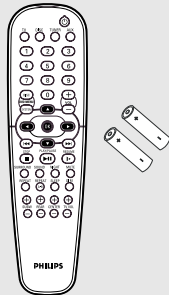

AC power cord

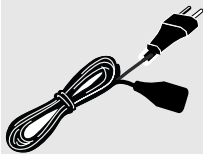

Care and safety information

Avoid high temperatures, moisture, water and dust

– Do not expose the system, batteries or discs to humidity, rain, sand or excessive heat (caused by heating equipment or direct sunlight). Always keep the disc tray closed to avoid getting dust on the lens.

Avoid condensation problem

– The lens may cloud over when the player is suddenly moved from cold to warm surroundings, making it impossible to play a disc. Leave the player in the warm environment until the moisture evaporates.

Do not block the vents

– Do not operate the DVD system in an enclosed cabinet and allow about 10 cm (4 inches) of free space all around the player for adequate ventilation.

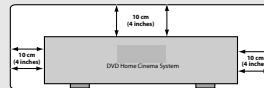

Care of disc

– To clean a CD, wipe it in a straight line from the centre toward the edge using a soft, lint-free cloth. Do not use cleaning agents, as they may damage the disc.



– Write only on the printed side of a CD-R/CD-RW and only with a soft felt-tipped pen.

– Handle the disc by its edge, do not touch the surface.

Care of the cabinet

– Use a soft cloth slightly moistened with a mild detergent solution. Do not use a solution containing alcohol, spirits, ammonia or abrasives.

Finding a suitable location

– Place the player on a flat, hard, stable surface.

Connections

English

Step 1: Placing the speakers and subwoofer

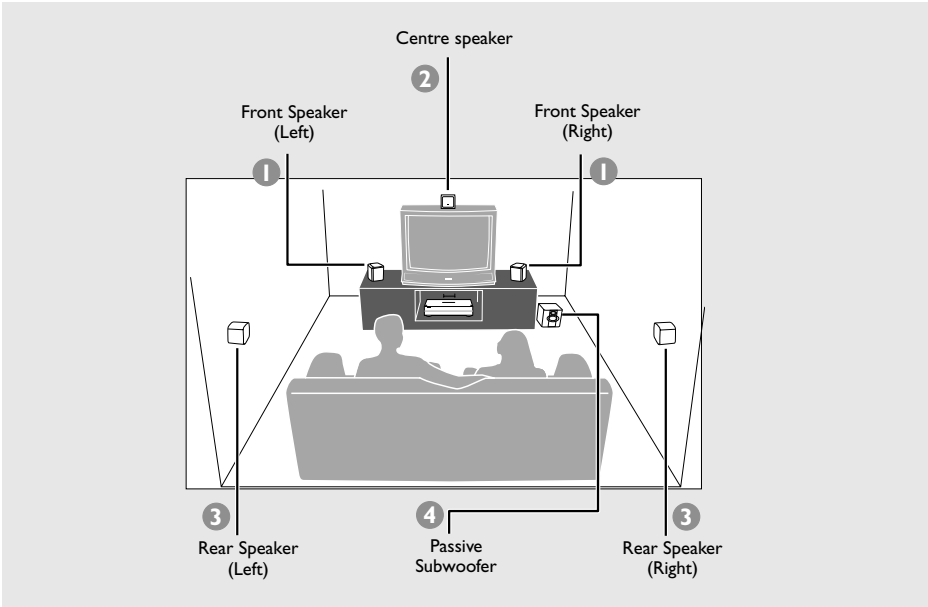

For best possible surround sound, all the speakers (except subwoofer) should be placed at the same distance from the listening position.

- 1 Place the front left and right speakers at equal distances from the TV and at an angle of approximately 45 degrees from the listening position.
- 2 Place the centre speaker above the TV or the DVD system so that the centre channel's sound is localised.
- 3 Place the rear speakers at normal listening ear level facing each other or hang on the wall.
- 4 Place the subwoofer on the floor near the TV.

Helpful Hints:

- To avoid magnetic interference, do not position the front speakers too close to your TV.
- Allow adequate ventilation around the DVD system.

Step 2: Connecting speakers and subwoofer

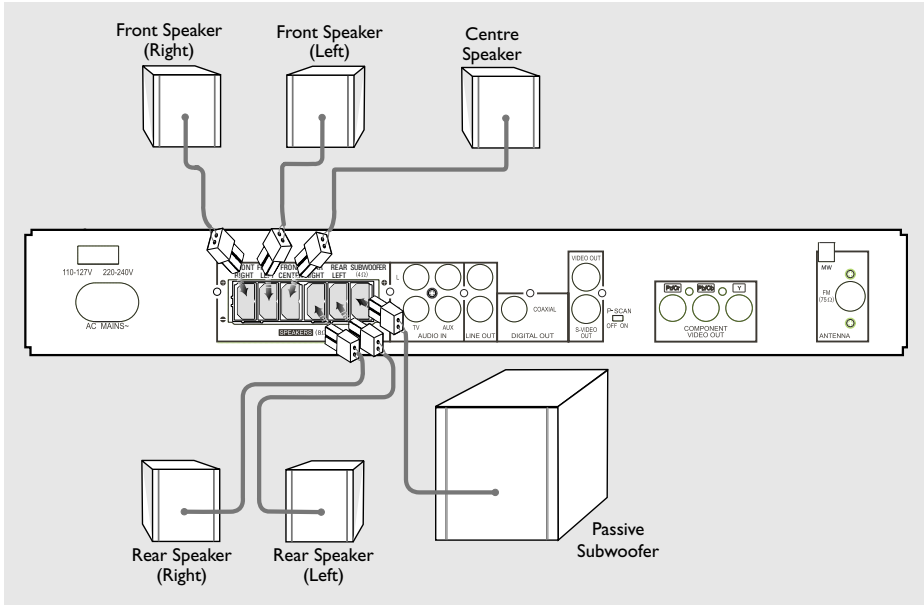

Connect the supplied speaker systems using the fixed speaker cables by matching the colours of the jacks and speaker cables.

Helpful Hint:

– Ensure that the speaker cables are correctly connected. Improper connections may damage the system due to short-circuit.

Connections

Step 3: Connecting TV

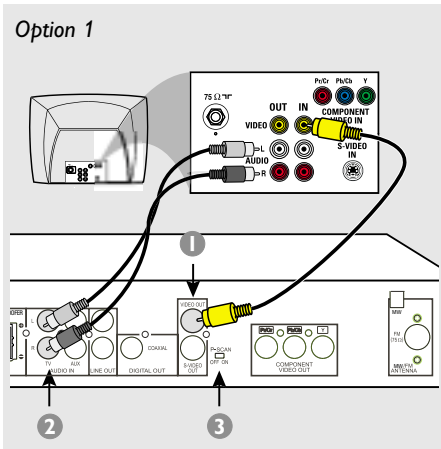

IMPORTANT!

- You only need to make one video connection from the following options, depending on the capabilities of your TV.
- Connect the DVD system directly to the TV.

Using Composite Video jack

- 1 Use the supplied composite video cable (yellow) to connect the DVD system's **VIDEO OUT** jack to the video input jack (or labelled as A/V In, Video In, CVBS, Composite or Baseband) on the TV.
- 2 To hear the TV channels through this DVD system, use the supplied audio cables (white/red) to connect **AUDIO IN-TV** jacks to the corresponding AUDIO OUT jacks on the TV.
- 3 Set the **P-SCAN** switch to **'OFF'**.

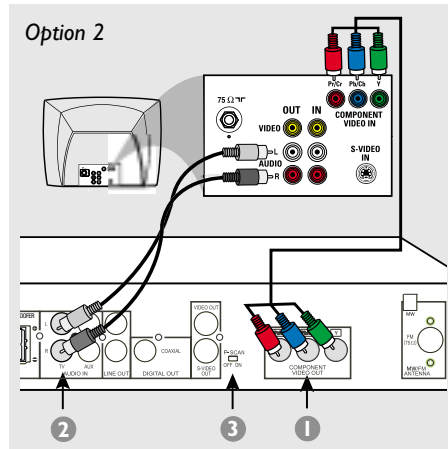

IMPORTANT!

- The progressive scan video quality is only possible when using **Y Pb/Cb Pr/Cr**, and a progressive scan TV is required.

Using Component Video jack (Y Pb/Cb Pr/Cr)

- 1 Use a component video cables (red/blue/green - not supplied) to connect the DVD system's **Y Pb/Cb Pr/Cr** jacks to the corresponding Component video input jacks (or labelled as Pr Pb Y or YUV) on the TV.
- 2 To hear the TV channels through this DVD system, use the supplied audio cables (white/red) to connect **AUDIO IN-TV** jacks to the corresponding AUDIO OUT jacks on the TV.
- 3 If you are using a Progressive Scan TV (TV must indicate Progressive Scan or ProScan capability), set the **P-SCAN** switch to **'ON'**. Otherwise, set it to **'OFF'**.

Helpful Hint:

- You have to power off the DVD system or switch to standby mode before changing the P-SCAN switch setting.

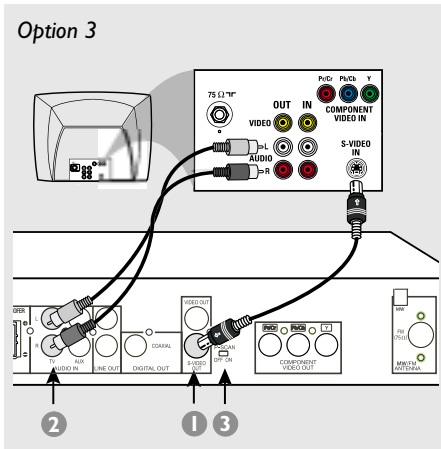

IMPORTANT!

If S-Video is used for DVD playback, the system's **VIDEO OUT** setting will need to be changed accordingly. Details are on page 23.

Using S-Video jack

- 1 Use an S-video cable (not supplied) to connect the DVD system's **S-VIDEO OUT** jack to the S-Video input jack (or labelled as Y/C or S-VHS) on the TV.
- 2 To hear the TV channels through this DVD system, use the supplied audio cables (white/red) to connect **AUDIO IN-TV** jacks to the corresponding AUDIO OUT jacks on the TV.
- 3 Set the **P-SCAN** switch to '**OFF**'.

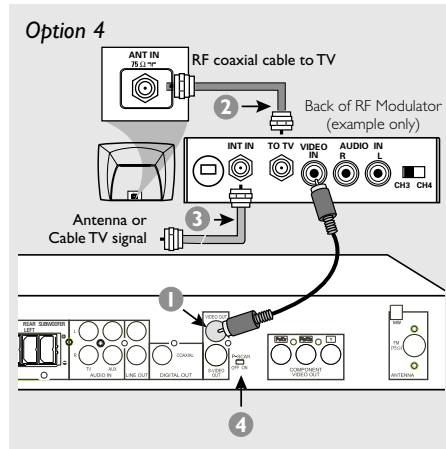

IMPORTANT!

If your TV only has a single Antenna In jack (labelled as 75 ohm or RF In), you will need an RF modulator in order to view DVD playback on the TV. See your electronics retailer or contact Philips for details on RF modulator availability and operations.

Using an accessory RF modulator

- 1 Use the supplied composite video cable (yellow) to connect the DVD system's **VIDEO OUT** jack to the video input jack on the RF modulator.
- 2 Use an RF coaxial cable (not supplied) to connect **ANTENNA OUT** or **TO TV** jack on the RF modulator to the **ANTENNA IN** jack on the TV.
- 3 Connect the Antenna or Cable TV service signal to the **ANTENNA IN** or **RF IN** jack on the RF modulator. (It may have been connected to your TV previously. Disconnect it from the TV).
- 4 Set the **P-SCAN** switch to '**OFF**'.

Connections

English

Step 4: Connecting FM/MW antennas

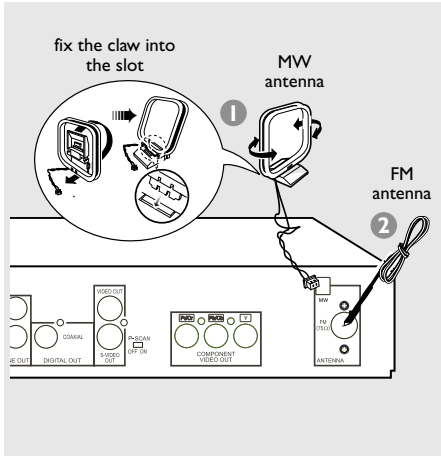

- 1 Connect the supplied MW loop antenna to the **MW** jack. Place the MW loop antenna on a shelf or attach it to a stand or wall.
- 2 Connect the supplied FM antenna to the **FM** (75Ω) jack. Extend the FM antenna and fix its ends to the wall.

For better FM stereo reception, connect an external FM antenna (not supplied).

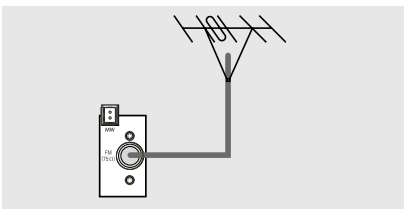

Helpful Hints:

- Adjust the position of the antennas for optimal reception.
- Position the antennas as far as possible from your TV, VCR or other radiation source to prevent unwanted interference.

Step 5: Connecting the power cord

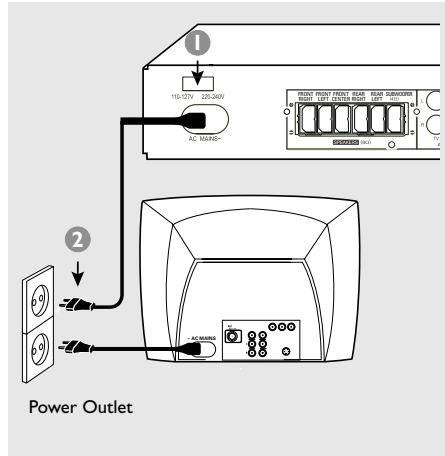

After everything is connected properly,

- 1 Set the **VOLTAGE SELECTOR** to the local power line voltage.
- 2 Plug in the AC power cord to the power outlet.
Never make or change any connections with the power switched on.

Helpful Hint:

- Refer to the type plate on the rear or bottom of the system for identification and supply ratings.

Connections (optional)

Connecting a VCR or Cable/Satellite Box

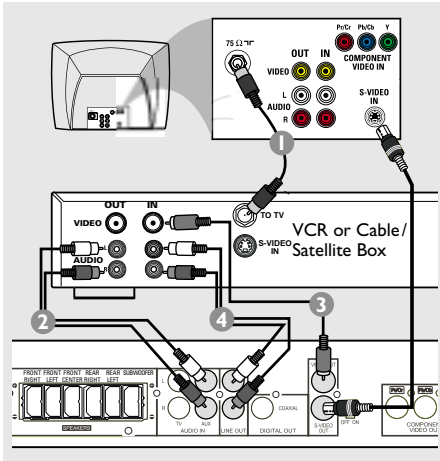

Viewing and listening to the playback

- 1 Connect the VCR or Cable/Satellite Box to the TV as shown.
- 2 Connect the DVD system's **AUDIO IN-AUX** jacks to the AUDIO OUT jacks on the VCR or cable/satellite box.

Before starting operation, press **AUX** on the remote to select "AUX" in order to activate the input source.

Using the VCR for recording DVD playback

- 3 Connect the DVD system's **VIDEO OUT** jack to the VIDEO IN jack on the VCR.
- 4 Connect the DVD system's **LINE OUT** jacks to the AUDIO IN jacks on the VCR. This will allow you to make analogue stereo (two channel, right and left) recordings.

To view DVD playback while recording, you must connect the DVD system to your TV using S-VIDEO (as shown above) or Component (Y Pb/Cb Pr/Cr) video connection.

Connecting digital audio equipment

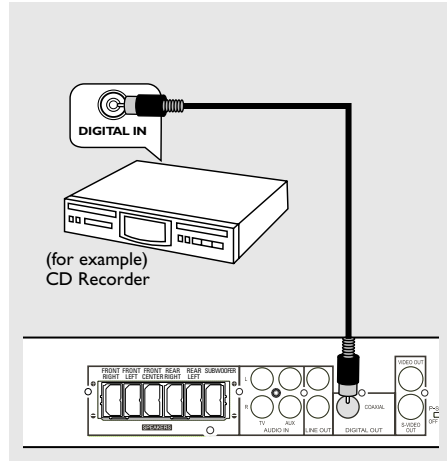

Digital Recording

- 1 Connect the DVD system's **DIGITAL OUT-COAXIAL** jack to the DIGITAL COAXIAL IN jack on a digital recording device (such as Dolby Digital decoder, CD recorder).

Before starting operation, set the DIGITAL OUTPUT according to the audio connection. (See page 24 "Setting the digital output").

Helpful Hints:

- Some DVDs are copy-protected. You cannot record the disc through a VCR or digital recording device.
- Always refer to the owner's manual of the other equipment for complete connection and usage details.

Functional Overview

Main unit and remote control

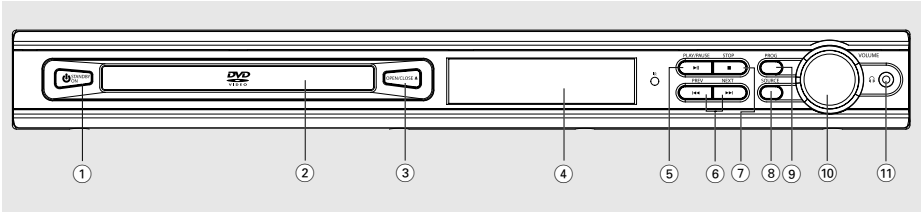

① **STANDBY ON**

- Switches to standby mode or turns on the system.

② **Disc tray**

- ### ③ **OPEN/CLOSE ▲** (DISC mode only)
- Opens / Closes the disc tray.

④ **System display panel**

⑤ **▶ || PLAY/PAUSE**

- DISC: starts/pauses playback.

⑥ **◀◀ PREV / ▶▶ NEXT**

- DISC: *searches backward/forward or selects a track.
- TUNER: tunes the radio frequency up/down.
- TV: selects previous/next channel on Philips TV (on remote only).

⑦ **■ STOP**

- Exits an operation.
- DISC: stops playback or clears a programme.
- TUNER: *erases a preset radio station.

⑧ **SOURCE**

- Selects the relevant active mode : TV, DISC, TUNER (FM/MW) or AUX.

⑨ **PROG**

- DISC: starts programming.
- TUNER: starts manual preset programming.

⑩ **VOLUME (VOL + -)**

- Adjusts the volume level.

⑪ **PHONES**

- Plugging in the headphones jack. The speakers output will be cancelled.

* = Press and hold the button for more than two seconds.

Functional Overview

Control buttons available on the remote only

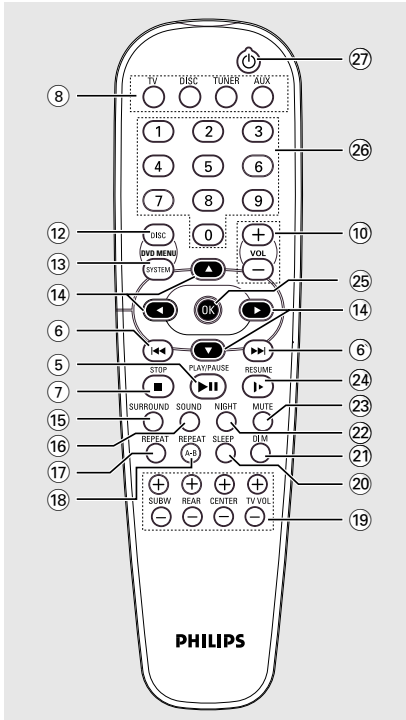

12 DISC MENU

- Enters disc contents menu.

13 SYSTEM MENU (DISC mode only)

- Enters or exits system setup menu.

14 ◀ ▶ ▲ ▼

- Selects movement direction in the menu.
- Use ◀ ▶ to select a preset radio station.

15 SURROUND

- Selects multichannel surround (Dolby Digital, Dolby Pro Logic or Dolby Pro Logic II) or stereo mode.

16 SOUND

- Selects a sound effect.

17 REPEAT

- Selects various repeat modes.

18 REPEAT A-B

- Repeats a specific section on a disc.

19 SUBW + -

- Adjusts subwoofer's sound level.

REAR + -

- Adjusts rear speakers' sound level.

CENTER + -

- Adjusts centre speaker's sound level.

TVVOL + -

- Adjusts TV volume (Philips TV only).

20 SLEEP

- Sets the sleep timer function.

21 DIM

- Selects different levels of brightness for display panel.

22 NIGHT (DVD mode only)

- Optimises the dynamic of the sound output

23 MUTE

- Mutes or restores the volume.

24 RESUME

- Continues disc playback after an interruption.

25 OK

- Confirms a selection.

26 Numeric Keypad (0-9)

- Enters a track/title number of the disc.
- Enters a number of a preset radio station.

27 ⏻

- Switches to standby mode.
- In TV mode, switches Philips TV on/off.

* = Press and hold the button for more than two seconds.

Getting Started

Step 1: Inserting batteries into the remote control

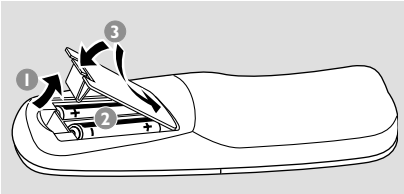

- 1 Open the battery compartment.
- 2 Insert two batteries type R06 or AA, following the indications (+ -) inside the compartment.
- 3 Close the cover.

Using the remote control to operate the system

- 1 Aim the remote control directly at the remote sensor (iR) on the front panel.
- 2 Select the source you wish to control by pressing one of the source select buttons on the remote control (for example TV, TUNER.)
- 3 Then select the desired function (for example ► II, I◀◀, ►►I).

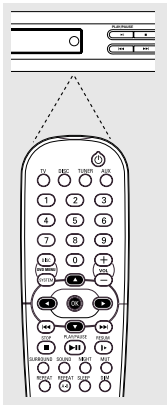

Step 2: Setting the TV

IMPORTANT!

Make sure you have completed all the necessary connections. (See pages 8–9 “Connecting TV”).



- 1 Press **SOURCE** control until “**DISC**” appears on the display panel (or press **DISC** on the remote).
- 2 Turn on the TV and set to the correct video-in channel. You should see the blue DVD background screen on the TV.
→ Usually this channel is between the lowest and highest channels and may be called FRONT, A/V IN, or VIDEO. See your TV manual for more details.
→ Or, you may go to channel 1 on your TV, then press the Channel down button repeatedly until you see the Video In channel.
→ Or, the TV remote control may have a button or switch that chooses different video modes.
→ Or, set the TV to channel 3 or 4 if you are using an RF modulator.

CAUTION!

- Remove batteries if they are exhausted or if the remote is not to be used for a long time.
- Do not use old and new or different types of batteries in combination.
- Batteries contain chemical substances, so they should be disposed of properly.

Selecting the colour system that corresponds to your TV

In order for a DVD to play on this DVD system, the colour system of the DVD, the TV and the DVD player should match. Before changing the TV system, determine the colour system of your TV.

- In disc mode, press **SYSTEM MENU**.
→ Use the ◀▶▲▼ keys on the remote to navigate in the menu.
- Highlight  icon and press ▼.
Move to  and press ▶.
Move to {TV SYSTEM} and press ▶.

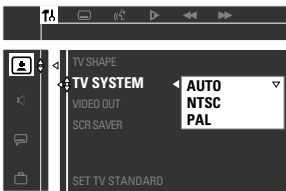

AUTO – Select this if the connected TV is compatible with both NTSC and PAL (multi-system). The output format will be in accordance with the video signal of the disc.



NTSC – Select this if the connected TV has the NTSC system. It will change the video signal of a PAL disc (VCD only) and output it to NTSC format.

PAL – Select this if the connected TV has the PAL system. It will change the video signal of an NTSC disc and output it to PAL format.

- Press ▲▼ to select a setting and press **OK** to confirm.
→ Follow the instructions show on the TV to confirm the selection (if any).
→ If a blank/distorted TV screen appears, wait for 15 seconds for auto recovery.

Setting the TV shape

Set the aspect ratio of the DVD Player according to the TV you have connected. The format you select must be available on the disc. If it is not, the setting for TV display will not affect the picture during playback.

- In disc mode, press **SYSTEM MENU**.
→ Use the ◀▶▲▼ keys on the remote to navigate in the menu.
- Highlight  icon and press ▼.
Move to  and press ▶.
Move to {TV SHAPE} and press ▶.

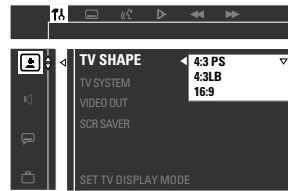

4:3 PS (PanScan) – Select this if you have a conventional TV and want both sides of the picture to be trimmed or formatted to fit your TV screen.



4:3 LB (letterbox) – Select this if you have a conventional TV. In this case, a wide picture with black bands on the upper and lower portions of the TV screen will be displayed.



16:9 – Select this if you have a wide-screen TV.



- Press ▲▼ to select a setting and press **OK** to confirm.

TIPS: To return to the previous menu, press ◀.
To remove the menu, press **SYSTEM MENU**.



Getting Started

Step 3: Setting the speakers

You can adjust the delay time (centre and rear speakers only) and volume level for individual speakers. These adjustments let you optimise the sound according to your surroundings and setup.

Test Tone - Turning on/off

If you have turned on the test tone, the test signal will be automatically generated to help you judge the sound level of each speaker.

- 1 In disc mode, press **SYSTEM MENU**.
→ Use the ◀ ▶ ▲ ▼ keys on the remote to navigate in the menu.
- 2 Highlight  icon and press ▼.
Move to  and press ▶.
Move to {TEST TONE} and press ▶.



- 3 Press ▲ ▼ to select a setting.

Adjusting the delay time

- 4 Press ▲ ▼ to highlight one of the options below at a time, then press ▶.

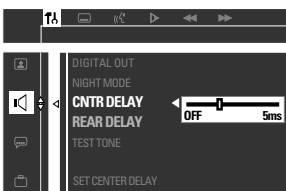

{CNTR DELAY} – Select this to set the delay time in relation to the listening position/distance for the centre speaker (5ms, 3ms, 2ms, 1ms or OFF).

{REAR DELAY} – Select this to set the delay time in relation to the listening position/distance for rear speakers (15ms, 12ms, 9ms, 6ms, 3ms or OFF).

- 5 Press ◀ ▶ to adjust the settings that best suit your surround sound needs.
- 6 Press **OK** to confirm.

Helpful Hint:

– Use longer delay time settings when the rear speakers are closer to the listener than the front speakers.

Adjusting the speaker output levels

You can adjust the rear speakers, centre speaker and subwoofer output levels by comparing the sound from the front speakers.

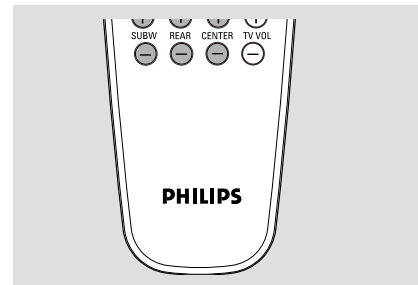

- Press the respective buttons on the remote (**REAR** + −, **CENTER** + − and **SUBW** + −) to adjust the output level between -15dB ~ 10dB.

Helpful Hint:



– If you have selected Stereo mode, adjusting the centre and rear speakers' volume level will have no effect.

TIPS: To return to the previous menu, press ◀.
To remove the menu, press **SYSTEM MENU**.

Step 4: Setting language preferences

You can select your preferred language settings so that this DVD system will automatically switch to the language for you whenever you load a disc. If the language selected is not available on the disc, the disc's default setting language will be used instead. The OSD (on-screen display) language for the system menu will remain as you set it, regardless of various disc languages.

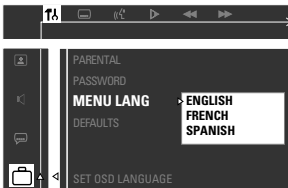

On-screen display (OSD) language

- 1 In disc mode, press **SYSTEM MENU**.
→ Use the ◀▶▲▼ keys on the remote to navigate in the menu.
- 2 Highlight  icon and press ▼.
Move to  and press ▶.
Move to {MENU LANG} and press ▶.



- 3 Press ▲▼ to select a language and press **OK** to confirm.

Audio, Subtitle and Disc menu languages

- 1 In disc mode, stop playback and press **SYSTEM MENU**.
→ Use the ◀▶▲▼ keys on the remote to navigate in the menu.
- 2 Highlight  icon and press ▼.
Move to  and press ▶.
Move to highlight one of the options below at a time, then press ▶.
 - {AUDIO} (disc's soundtrack)
 - {SUBTITLE} (disc's subtitles)
 - {DISC MENU} (disc's menu)

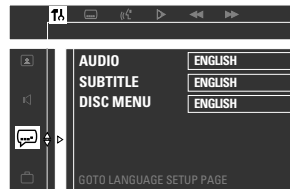

- 3 Press ▲▼ to select a language and press **OK** to confirm.
- 4 Repeat steps 2~3 for other settings.

TIPS: To return to the previous menu, press ◀.
To remove the menu, press **SYSTEM MENU**.

Disc Operations

IMPORTANT!

- If the inhibit icon (or **X**) appears on the TV screen when a button is pressed, it means the function is not available on the current disc or at the current time.
- DVD discs and players are designed with regional restrictions. Before playing a disc, make sure the disc is for the same zone as your player.
- Do not push on the disc tray or put any objects other than discs on the disc tray. Doing so may cause the disc player to malfunction.

Playable discs

Your DVD home cinema system will play:

- Digital Versatile Discs (DVDs)
- Video CDs (VCDs)
- Super Video CDs (SVCDs)
- Audio Compact Discs (CDs)
- MP3 discs, picture (Kodak, JPEG) files on CD-R(W)
 - JPEG/ISO 9660 format
 - Maximum 12 characters display
 - Supported sampling frequencies : 32 kHz, 44.1 kHz, 48 kHz
 - Supported Bit-rates : 32~256 (kbps), variable bit rates

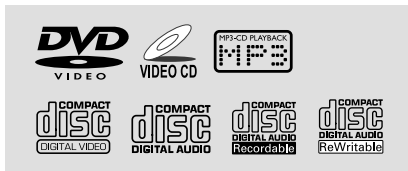

Region Codes

DVDs must be labelled for **ALL** regions or for **Region 4** in order to play on this DVD system. You cannot play discs that are labelled for other regions.



Helpful Hints:

- It may not be possible to play CD-R/RW in all cases due to the type of disc or condition of the recording.
- If you are having trouble playing a certain disc, remove the disc and try a different one. Improperly formatted discs will not play on this DVD system.

Playing discs

- 1 Press **SOURCE** control until “**DISC**” appears on the display panel (or press **DISC** on the remote).
- 2 Turn on the TV power and set to the correct Video In channel. (See page 14 “Setting the TV”).
 - You should see the blue DVD background screen on the TV.
- 3 Press the **OPEN/CLOSE** to open the disc tray and load a disc, then press the button again to close the disc tray.
 - Make sure the disc label is facing up.
 - For double-sided discs, load the side you want to play face up.
- 4 Press **▶ ||** to start playback.
 - If a disc menu shows on the TV, see next page on “Using the Disc Menu”.
 - If the disc is locked by parental control, you must enter your four-digit password (see page 26–27).

TIPS: The operating features described here might not be possible for certain discs. Always refer to the instructions supplied with the discs.

Using the Disc Menu

Depending on the disc, a menu may appear on the TV screen once you load in the disc.

To select a playback feature or item

- Use the ◀▶ ▲▼ keys or **numeric keypad (0-9)** on the remote, then press **OK** to start playback.

To access the menu

- Press **DISC MENU** on the remote.

For VCDs with Playback Control (PBC) feature (version 2.0 only)

- During playback, pressing **DISC MENU** will return to the menu screen (if PBC is on).
→ Use |◀◀ / ▶▶| to select a play option and press **OK** to confirm or use the **numeric keypad (0-9)**.

Basic playback controls

Pausing playback

- Press ▶||.
- To resume normal playback, press ▶|| again.

Selecting another track/chapter

- Press |◀◀ / ▶▶| or use the **numeric keypad (0-9)** to key in a track/chapter number.
→ If repeat mode is active, pressing |◀◀ / ▶▶| will replay the same track/chapter.

Searching backward/forward

- Press and hold |◀◀ / ▶▶|, then press ▶|| to resume normal playback.
→ While searching, pressing and holding |◀◀ / ▶▶| again will increase the search speed.

Stopping playback

- Press ■.

Resuming playback from the last stopped point (DVD/VCD/CD)

- When play is stopped and the disc has not been ejected, press **RESUME**.

To cancel the resume mode

- When play is stopped, press ■ again.

Helpful Hints:

- Open the disc tray or disconnect the DVD system from the power supply will cancel the resume option.
- For VCD disc, pressing **RESUME** button will turn off the PBC mode and playback will start from the beginning.

TIPS: The operating features described here might not be possible for certain discs. Always refer to the instructions supplied with the discs.

Disc Operations

Selecting various repeat functions

Repeat play mode

- While playing a disc, press **REPEAT** to select various repeat mode.
→ "REPEAT" icon will appear on the display, except REPEAT OFF mode.

DVD

CHAPTER REPEAT ON →
TITLE REPEAT ON → REPEAT-OFF

VCD/SVCD/CD

REPEAT-ONE (repeat the current track) → REPEAT-ALL → REPEAT-OFF

MP3

REPEAT-ONE → REPEAT-ALBUM → REPEAT-ALL → REPEAT-OFF

Helpful Hint:

– For VCD, repeat playback is not possible if the PBC mode is switched on.

Repeating a section within a chapter/track (DVD/VCD/CD)

- 1 While playing a disc, press **REPEAT A-B** at the starting point.
- 2 Press **REPEAT A-B** again at the point to end the section.
→ The section A and B can be set only within the same chapter/track.
→ The section will now repeat continuously.
- 3 Press **REPEAT A-B** again to resume normal playback.

Programme favourite tracks (audio CDs and VCDs)

You can play the contents of the disc in the order you want by programming the order of the tracks to be played. Up to 99 tracks can be stored.

- 1 Stop playback, then press **PROG** on the front panel to enter programme mode.
- 2 Use the **numeric keypad (0-9)** to enter a valid track number.
→ "FULL" will appear if you have programmed 99 tracks.
- 3 Press **OK** to store the track.
- 4 Repeat steps 2~3 to select other tracks.
- 5 Press **▶ ||** to start programme playback.
- 6 Press **■** to stop playback or exit programme mode.

Clearing the programme

- Stop playback, then press the **■** again.
→ "PROG CLR" appears.

Helpful Hints:

– If the DVD system is disconnected from the power supply, it will erase the programme.
– For VCD, the programme option is only possible if the PBC mode is turned off.

TIPS: The operating features described here might not be possible for certain discs. Always refer to the instructions supplied with the discs.

Using the menu bar to programme

IMPORTANT!

You have to turn on your TV and set to the correct Video In channel. (See page 14 "Setting the TV").

- 1 Stop playback, then press **SYSTEM MENU**.
→ The menu bar will appear across the top of the TV screen.
- 2 Press ◀▶ to select  and press ▼ to enter the programme menu.



- 3 Use the **numeric keypad (0-9)** to enter the track number to be programmed.
→ "FULL" will appear if you have programmed 99 tracks.
- 4 Press ▶|| to start programme playback.

To clear the programme

- Stop playback, then press ■ again.

Playing MP3/Picture disc (Kodak, JPEG)

IMPORTANT!

You have to turn on your TV and set to the correct Video In channel. (See page 14 "Setting the TV".)

- 1 Load an MP3/Picture (Kodak, JPEG) disc.
→ The disc reading time may exceed 30 seconds due to the complexity of the directory/file configuration.
- 2 Playback will start automatically.
→ The album/picture menu appears on the TV screen. If not, press DISC MENU on the remote.

- 3 Use ◀▶▲▼ keys to select a desired album, then press **OK** to open the folder (for MP3 disc only).

→ The title menu appears on the TV.

- 4 Use ◀▶▲▼ keys to select a desired title, then press **OK** to start playback.

- You can also use the **numeric keypad (0-9)** to enter your choice.

During playback, you can;

- Press |◀◀/▶▶| to select another title/picture in the current folder.

- Use ◀▶▲▼ keys to rotate/flip the picture files.

- Press ▶|| to pause/resume playback.

- 5 To stop playback, press ■.

Helpful Hints:

- Due to the recording nature of Digital Audio MP3 (DAM), only digital audio music will play.
- It is normal to experience an occasional "skip" while listening to your MP3 discs.
- It may not be possible to play certain MP3 or JPEG disc due to the configuration and characteristics of the disc or condition of the recording.
- For multi-session discs with different formats, only the first session will be available.

JPEG and MP3 simultaneously playback

- 1 Select a MP3 track and press **NIGHT**.
→ 'Music Slide show' appears on the TV.

- 2 Press ▲▼ to select a picture file, then press **OK**.
→ The picture will be played back in sequence together with MP3 music.

- 3 To quit simultaneous playback, press ■.
→ The picture and MP3 music playback will stop.

Helpful Hint:

- If the disc menu doesn't appear on the TV screen, press DISC MENU to turn on the disc menu.

TIPS: The operating features described here might not be possible for certain discs. Always refer to the instructions supplied with the discs.

DVD Setup Menu Options

Using the menu bar

You can continue a number of operations directly via the multiple menu bars on the TV screen without interrupting the disc playback. The exception is when you enter **SYSTEM MENU** (SETUP MENU), after which the playback will pause.

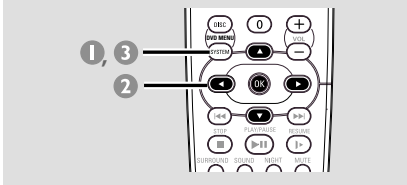

- In disc mode, press **SYSTEM MENU**.
→ The menu bar will appear across the top of the TV screen.

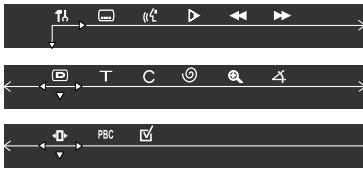

- Use **◀▶▲▼** keys on the remote to navigate in the menu.
→ Press **◀▶** to move through the menu bar.
→ Press **▼** to enter the selection. If there are multiple choices available, press **▼** repeatedly to select.
- Press **SYSTEM MENU** again to remove the menu.

IMPORTANT!

- Some operations may be different or restricted, depending on the disc format. Refer to the jacket or case of the disc you are playing.
- Changing the Subtitle Language and Audio Language from the menu bar will only apply to the current disc, it will not change the default preset.

	SUBTITLE Select a subtitle language available on the DVD.
	AUDIO DVD : Select an audio soundtrack language available on the DVD. VCD : Select audio channels : LEFT VOCAL, RIGHT VOCAL, MONO LEFT, MONO RIGHT or STEREO.
	SLOW MOTION Select a slow playback speed. The volume will be muted. To resume normal playback, press ▶ II . DVD : SF x1/2, SF x1/4, SF x1/8, SR x1/2, SR x1/4, SR x1/8, OFF. VCD : SF x1/1, SF x1/2, SF x1/3, OFF. (SF - Slow Forward, SR- Slow Reverse)
	FAST REVERSE (FR) DVD / MP3 : FR x2, FR x4, FR x6, FR x8, OFF. VCD / CD : FR x1, FR x2, FR x3, FR x4, OFF.
	FAST FORWARD (FF) DVD / MP3 : FF x2, FF x4, FF x6, FF x8, OFF. VCD / CD : FF x1, FF x2, FF x3, FF x4, OFF. Select a search speed (FR - backward, FF - forward). The volume will be muted. To resume normal playback, press ▶ II .
	STATUS Allows viewing of the current status of the disc. The information will vary depending on the disc format.
	<i>Available on DVD only</i> TITLE SEARCH (TITLE XX:YY) Select a Title for playback to begin.
	CHAPTER SEARCH (CHAPTER XX:YY) Select a Chapter for playback to begin. "XX" - current title/chapter number. "YY" - total number of title/chapter. Use the numeric keypad (0-9) to change the "XX" number, then press OK .
	TIME SEARCH (TIME : : :) Use the numeric keypad (0-9) to enter the time (hours, minutes and seconds) at which you want playback to begin (for DVD or VCD with PBC-OFF only).
	ZOOM Select an enlarge picture ratio : x1.5, x2 or x4, then press OK to confirm. You can use ◀▶▲▼ keys to move within the enlarged picture on the TV. To resume normal playback, select 'ZOOM OFF' from the menu.
	ANGLE (for DVD only) Select to view the same scene from different angles if the DVD is recorded with multiple angles.
	STEP FORWARD Select to advance the still picture one frame forward. To resume normal playback, press ▶ II .
	PBC ON/OFF (for VCD 2.0 with PBC feature) Select between PBC On and Off. 'PBC OFF' - the playback will start automatically. 'PBC ON' - the disc menu (if available) will appear on the TV. Use the numeric keypad (0-9) to enter your choice.
	PROGRAM Stop playback, then select this to enter the program menu (see page 21 "Using the menu bar to programme").

DVD Setup Menu Options

Using the Setup Menu

This DVD setup is carried out via the TV, enabling you to customise the DVD system to suit your particular requirements.

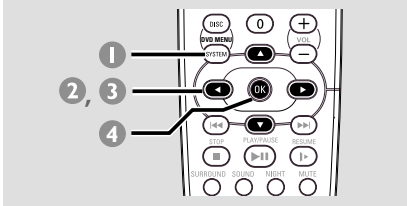

- 1 In disc mode, press **SYSTEM MENU**.
→ Playback will pause.
- 2 Highlight  icon and press **▼** to enter the setup menu. Then press **▲▼** to select one of the setup menu options and press **▶** to enter the menu.

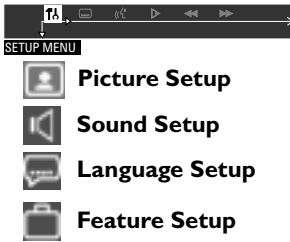

- 3 Use **◀▶▲▼** keys on the remote to navigate in the menu.
- 4 Press **OK** to confirm your selection.

NOTE:
Some of the features in the Setup Menu are described in “Getting Started”.

Setting the video output

Choose the type of video output that matches the video connection between the DVD system and your TV.

Stop playback, then follow the steps of “Using the Setup Menu” and select :

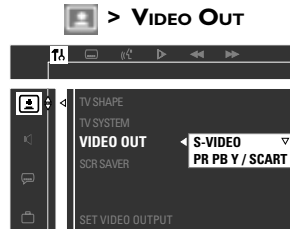

S-VIDEO

Select this if you have connected the DVD system to your TV using the S-Video jack.

PR PB Y / SCART

Select this if you have connected the DVD system to your TV using component video jacks. (SCART – this feature is not available for this model).

Helpful Hint:

– You do not need to adjust the video output setting if you are using CVBS jack (yellow) to connect the DVD system to your TV.

TIPS: To return to the previous menu, press **◀**.
To remove the menu, press **SYSTEM MENU**.

DVD Setup Menu Options

Screen Saver – turning on/off

The screen saver will help to prevent your TV display device from becoming damaged.

Follow the steps of “Using the Setup Menu” and select :

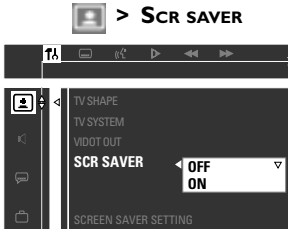

OFF

Select this to disable the screen saver function.

ON

Select this if you wish to turn off the TV screen when play is stopped or paused for more than five (5) minutes.

Setting the digital output

Set Digital Output according to the optional audio equipment you connected.

Follow the steps of “Using the Setup Menu” and select :

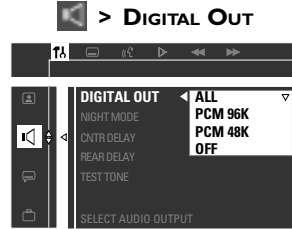

ALL

Select this if you have connected the digital output to an optional piece of audio equipment that has a multichannel decoder.

PCM 96 kHz

Select this if the optional audio equipment is capable of processing digital signal input with sampling rates of 96 kHz. However, if the sound output is distorted or there is no sound, select '48 kHz' instead.

PCM 48 kHz

Select this if the optional audio equipment is incapable of processing 96 kHz digital signal input. The signal will then be converted to a standard signal with sampling rates of 48 kHz.

OFF

Select this to deactivate the digital output.

Helpful Hint:

– Analogue signal will also be available through the digital output.

TIPS: To return to the previous menu, press ◀.
To remove the menu, press **SYSTEM MENU**.

DVD Setup Menu Options

Night mode – turning on/off

When activated the night mode, the high volume outputs will be softened and low volume outputs will be brought upward to an audible level. It is useful for watching your favourite action movie without disturbing others at night. This function can also be accessed via the NIGHT button on the remote.

Follow the steps of “Using the Setup Menu” and select :

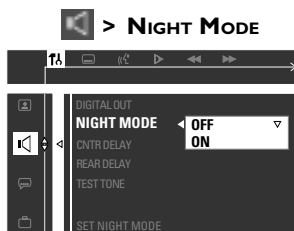

OFF

Select this when you want to enjoy the full dynamic of surround sound.

ON

Select this to level out the volume. This feature is only available for movies with Dolby Digital mode.

Restoring to original settings

Setting the DEFAULT function will reset all options and your personal settings to the factory defaults, except your password for Parental Control.

Follow the steps of “Using the Setup Menu” and select :

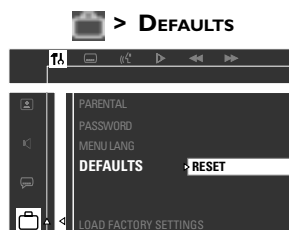

RESET



Pressing ► to select {RESET}, all settings will now reset to factory defaults.

TIPS: To return to the previous menu, press ◀.
To remove the menu, press **SYSTEM MENU**.

DVD Setup Menu Options

Restricting playback by Parental Control

Some DVDs may have a parental level assigned to the complete disc or to certain scenes on the disc. This feature lets you set a playback limitation level. The rating levels are from 1 to 8 and are country dependent. You can prohibit the playing of certain discs that are not suitable for your children or have certain discs played with alternative scenes.

- 1 In disc mode, press **SYSTEM MENU**.
→ Use the ◀▶▲▼ keys on the remote to navigate in the menu.
- 2 Select  icon and press ▼.
Move to  and press ▶.
Move to {PARENTAL} and press ▶.

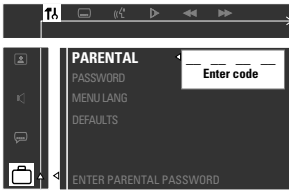

- 3 Use the **numeric keypad (0-9)** to enter '1234' (default password) when you are asked to enter the four-digit password. You will have to enter the same code, exactly, twice.
→ To change the password, see page 27 "Changing the password".
- 4 Select a rating level and press **OK**.
→ DVDs that are rated above the level you selected will not play unless you enter your four-digit password and choose a higher level rating.
→ To disable Parental Controls and have all discs play, choose 'NO PARENTAL'.

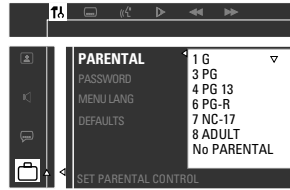

- 5 Press **SYSTEM MENU** again to remove the menu.

Rating explanations

NO PARENTAL – All discs will play.

8 ADULT – Mature material; should be viewed only by adults due to graphic sexual material, violence, or language.

7 NC-17 – No children under age 17; not recommended viewing for children under age 17.

6 PG-R – Parental Guidance - Restricted; recommended that parents restrict children under 17 from viewing or allow to view only when supervised by a parent or adult guardian.

4 PG13 – Material is unsuitable for children under age 13.

3 PG – Parental Guidance suggested.

1 G – General Audience; recommended as acceptable for viewers of all ages.

Helpful Hints:

– VCD, SVCD, CD have no level indication, so parental control has no effect on these type of discs. This also applies to most illegal DVDs.



– Some DVDs are not encoded with a rating though the movie rating may be printed on the Disc cover. The rating level feature does not prohibit play of such Discs.

TIPS: To return to the previous menu, press ◀.
To remove the menu, press **SYSTEM MENU**.

DVD Setup Menu Options

Changing the password

You can change the four-digit password used for Parental Control. Enter your four-digit password to play a prohibited disc or if prompted for a password. The default password is '1234'.

- 1 In disc mode, press **SYSTEM MENU**.
→ Use the ◀▶▲▼ keys on the remote to navigate in the menu.
- 2 Select  icon and press ▼.
Move to  and press ▶.
Move to {PASSWORD} and press ▶.

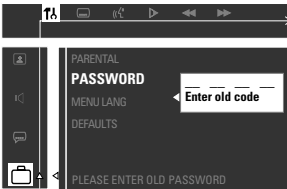

- 3 Use the **numeric keypad (0-9)** to enter your original four-digit password at "Enter old code".
→ If you are asked to enter the code for the first time, key in '1234'.
→ If you forget your password, press  **four times** to restore to the default password (1234).
- 4 Enter your new four-digit password.

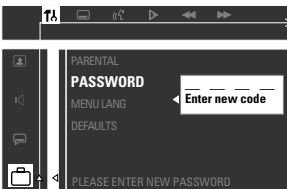

- 5 Enter the same new four-digit password again.



- 6 Press **SYSTEM MENU** again to remove the menu.

TIPS: To return to the previous menu, press ◀.
To remove the menu, press **SYSTEM MENU**.

Tuner Operations

IMPORTANT!

Make sure the **FM** and **MW** antennas are connected.

Tuning to radio stations

- 1 Press **TUNER** on the remote (or press **SOURCE** control on front panel) to select "FM" or "MW".
- 2 Press and hold **◀◀ / ▶▶** on the remote until the frequency indication starts to change, then release.
→ The next radio station will tune automatically.
- 3 To tune a weak station, press **◀◀ / ▶▶** briefly and repeatedly until an optimal reception is found.

Presetting radio stations

You can store up to 40 preset radio stations in the memory, starting from FM and followed by MW bands.

Automatic presetting

You can store all available radio stations automatically.

- In tuner mode, press and hold **PROG** until "AUTO PROG" appears.
→ All the available radio stations with strong transmission signal will be stored.
→ Automatic preset will begin from preset (1) and all your former presets will be overridden.
→ If it has reached 40 presets, "PROG FULL" appears.
→ Once completed, "PROG END" appears.



Manual presetting

You can choose to store only your favourite radio stations.

- 1 Tune to your desired radio station (see "Tuning to a radio station").
- 2 Press **PROG**.
→ "PROGRAM" icon appears.
- 3 Use the **numeric keypad (0-9)** to select a preset number.
→ If "PROGRAM" icon goes off before you select the desired preset number, press **PROG** again.



- 4 Press **PROG** again to store.
- 5 Repeat steps 1~4 to store other radio stations.

Helpful Hints:

- If you attempt to programme more than 40 preset radio stations, "PROG FULL" appears.
- The system will exit presetting mode if no button is pressed within five seconds.

Selecting a preset radio station

- Press **◀ ▶** or use the **numeric keypad (0-9)** to select a preset number.
→ The preset number, radio frequency, and waveband will appear.

Deleting a preset radio station

- Press and hold **■** until "PXX CLR" appears.
→ The current preset radio station will be deleted.

Tuner Operations

Changing tuning grid

(not available for all versions)

In some countries, the frequency step between adjacent channels in the MW band is 9 kHz (10 kHz in some areas). The preset frequency step in the factory is 9 kHz.

IMPORTANT!

Changing the tuning grid will erase all previously stored preset radio stations.

- Press and hold down **PLAY/PAUSE ► II** button on front panel for more than five seconds.
→ The display will show "GRID 9" or "GRID 10".

Helpful Hints:

- GRID 9 and GRID 10 indicate that the tuning grid is in step of 9 kHz and 10 kHz respectively.
- The FM tuning grid also will be changed from 50 kHz to 100 kHz or vice versa.

Other Functions

Setting the Sleep Timer

The sleep timer enables the system to switch to standby mode automatically at a preset time.

- Press **SLEEP** repeatedly until it reaches the desired preset turn-off time.
→ The selections are as follows (time in minutes):
15 → 30 → 45 → 60 → 90 → 120
→ OFF → 15 ...
→ "SLEEP" icon will show on the display, except if "OFF" is selected.

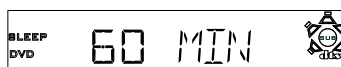

To check or change the setting

- Press **SLEEP** once to show the remaining time before switching off. If you continue pressing the **SLEEP** button, the next Sleep Timer option will appear.

To cancel the sleep timer

- Press **SLEEP** repeatedly until "OFF" appears or press the **STANDBY ON** button.

Other Functions

Sound Control

IMPORTANT!

For proper surround sound, make sure the speakers and subwoofer are connected (see page 7).

Selecting surround sound

- Press **SURROUND** to select multichannel surround or stereo mode.
 - The availability of the various surround sound modes depends on the number of speakers used and the sound available on the disc.
 - The centre and surround speakers operate only in Multi-channel surround mode.
 - The available output modes for multi-channel include: Dolby Digital, Dolby Pro Logic or Dolby Pro Logic II surround sound.
 - Stereo broadcasts or recordings will produce some surround channel effects when played in a surround mode. However, mono (single channel sound) sources will not produce any sound from the rear speakers.

Selecting digital sound effects

Select a preset digital sound effects that matches your disc's content or that optimises the sound of the musical style you are playing.

- Press **SOUND** to select the available sound effect.

When playing movie discs, you can select: **CONCERT, DRAMA, ACTION** or **SCI-FI**.

When playing music discs or while in **TV/AV, TUNER** or **AUX** mode, you can select: **ROCK, DIGITAL, CLASSIC** or **JAZZ**.

Helpful Hint:

– For flat sound output, select **CONCERT** or **CLASSIC**.

Volume control

- Adjust **VOLUME** control (or press **VOL + / -** on the remote) to increase or decrease the volume level.
 - "**VOL XX**" appears. "XX" denotes the volume level.

To listen through the headphones

- Connect the headphones plug to the **PHONES** socket at the front of the DVD system.
 - The speakers will be mute.

To turn off the volume temporarily

- Press **MUTE**.
 - Playback will continue without sound and "**MUTE**" appears.
 - To restore the volume, press **MUTE** again or increase the volume level.

Dimming system's display screen

- In any active mode, press **DIM** to select desired brightness : **HIGH, MID** or **LOW**.

Using the remote to operate 'Philips' television

- 1 Press **TV**.
- 2 Press **◀◀ / ▶▶** or use the **numeric keypad (0-9)** to select the TV's channel.
- 3 Press **TVVOL + / -** to adjust the TV's volume level.
- 4 Press **⏻** to turn off your TV.

Helpful Hint:

– When listening to **TV** or **AUX** programmes, press the respective **TV** or **AUX** button on the remote in order for the sound to be heard.

Specifications

AMPLIFIER SECTION

Output power	3000 W PMPO
- Front	30 W RMS ^① / channel
- Rear	30 W RMS ^① / channel
- Centre	30 W RMS ^①
- Subwoofer	50W RMS
Frequency Response	180 Hz – 14 kHz / ±3 dB
Signal-to-Noise Ratio	> 60 dB (A-weighted)
Input Sensitivity	
- AUX In	400 mV
- TV In	400 mV
① 8ohm, 1 kHz, 10% THD	

TUNER SECTION

Tuning Range	FM 87.5 – 108 MHz (50 kHz/100 kHz) MW 531 – 1602 kHz (9 kHz) MW 530 – 1710 kHz (10 kHz)
26 dB Quieting Sensitivity	FM 20 dBf
26 dB Quieting Sensitivity	MW 5000 μV/m
Image Rejection Ratio	FM 25 dB MW 28 dB
IF Rejection Ratio	FM 60 dB MW 24 dB
Signal-to-Noise Ratio	FM 55 dB MW 40 dB
MW Suppression Ratio	FM 30 dB
Harmonic Distortion	FM Mono 3% FM Stereo 3% MW 5%
Frequency Response	FM 180 Hz – 10 kHz / ±6 dB
Stereo Separation	FM 26 dB (1 kHz)
Stereo Threshold	FM 23.5 dB

DISC SECTION

Laser Type	Semiconductor
Disc Diametre	12cm / 8cm
Video Decoding	MPEG-2 / MPEG-1
Video DAC	10 Bits
Signal System	PAL / NTSC
Video Format	4:3 / 16:9
Video S/N	56 dB (minimum)
Composite Video Output	1.0Vp-p, 75 Ω
S-Video Output	Y - 1.0Vp-p, 75 Ω C - 0.286Vp-p, 75 Ω
Audio DAC	24 Bits / 96 kHz
Frequency Response	4 Hz – 20 kHz (44.1 kHz) 4 Hz – 22 kHz (48 kHz) 4 Hz – 44 kHz (96 kHz)
Digital Output	SPDIF (Sony Philips digital interface) Coaxial
- PCM	IEC 60958
- Dolby Digital	IEC 60958, IEC 61937

MAIN UNIT

Power Supply Rating	110–127 / 220–240V; 50/60 Hz Switchable
Power Consumption	120 W
Dimensions (w x h x d)	435 x 48 x 380 (mm)
Weight	4.07 kg

SPEAKERS

Front/Rear speakers	
System	2-way, Bass Reflex system
Impedance	8 Ω
Speaker drivers	2 x 3" FR, 1 3/4" piezo
Frequency response	120 Hz – 20 kHz
Dimensions (w x h x d)	90 x 90 x 87 (mm)
Weight	0.53 kg each

CENTRE SPEAKER

System	3-way, Bass Reflex system
Impedance	8 Ω
Speaker drivers	2 x 3" FR, 1 3/4" piezo
Frequency response	120 Hz – 20 kHz
Dimensions (w x h x d)	90 x 90 x 87 (mm)
Weight	0.53 kg

PASSIVE SUBWOOFER

Impedance	4 Ω
Speaker drivers	6 1/2" woofer
Frequency response	30 Hz – 120 Hz
Dimensions (w x h x d)	210 x 220 x 350 (mm)
Weight	3.57 kg

Specifications subject to change without prior notice

Troubleshooting

WARNING

Under no circumstances should you try to repair the system yourself, as this will invalidate the warranty. Do not open the system as there is a risk of electric shock.

If a fault occurs, first check the points listed below before taking the system for repair. If you are unable to remedy a problem by following these hints, please consult your dealer or Philips for help.

Problem	Solution
No power.	<ul style="list-style-type: none"> – Check if the AC power cord is properly connected. – Press the STANDBY ON on the front of the DVD system to turn on the power.
No picture.	<ul style="list-style-type: none"> – Refer to your TV's manual for correct Video In channel selection. Change the TV channel until you see the DVD screen. – Press DISC on the remote. – Switch the P-SCAN at the back panel to "OFF" position if you are not using a Progressive Scan TV.
Completely distorted picture or black/white picture.	<ul style="list-style-type: none"> – If this happens when you changing the setting of the 'TV SYSTEM', wait for 15 seconds for auto recovery. – Check the video connection. – Sometimes a small amount of picture distortion may appear. This is not a malfunction. – Clean the disc.
The aspect ratio of the screen cannot be changed even though you have set the TV display.	<ul style="list-style-type: none"> – The aspect ratio is fixed on the DVD disc. – Depending on the TV, it may not be possible to change the aspect ratio.
No sound or distorted sound.	<ul style="list-style-type: none"> – Adjust the volume. – Check the speaker connections and settings. – Disconnect the headphones. – Press the correct source button on the remote (TV or AUX, for example) to choose the equipment that you want to hear through the DVD system.
The DVD system does not work.	<ul style="list-style-type: none"> – Disconnect the power cord from the power outlet for a few minutes. Reconnect the power cord and try to operate again as usual.
The disc tray cannot open and "TRAY LOCKED" is displayed.	<ul style="list-style-type: none"> – Press and hold SOURCE button on the front panel for more than two seconds, then press PLAY button.

Troubleshooting

Problem	Solution
The DVD player does not start playback.	<ul style="list-style-type: none">– Insert a readable disc with the playback side facing down. The DVD+R/CD-R must be finalised.– Check the disc type, colour system and region code.– Check for any scratches or smudges on the disc.– Press SYSTEM SETUP to turn off the setup menu screen.– You may need to enter the password in order to change the parental control rating level or to unlock the disc for playback.– Moisture has condensed inside the system. Remove the disc and leave the system turned on for about an hour.
Cannot activate some features, such as Angles, Subtitles, or multi-language Audio.	<ul style="list-style-type: none">– The features may not be available on the DVD.– Changing the language for the sound or subtitle is prohibited on the DVD.
There is no sound from the centre and rear speakers.	<ul style="list-style-type: none">– Press CENTER + – or REAR + – to adjust the volume level.– Make sure the centre and rear speakers are connected correctly.– Press SURROUND button to select a correct surround sound setting.– Make sure the source you are playing is recorded or broadcast in surround sound (DPL II, Dolby Digital, etc.)
Radio reception is poor.	<ul style="list-style-type: none">– If the signal is too weak, adjust the antenna or connect an external antenna for better reception.– Increase the distance between the system and your TV or VCR.– Tune in to the correct frequency.– Place the antenna farther away from any equipment that may be causing the noise.
The remote control does not function properly.	<ul style="list-style-type: none">– Select the source (DISC or TUNER, for example) before pressing the function button (▶ II, ◀◀, ▶▶).– Reduce the distance between the remote control and the system.– Replace the batteries with new ones.– Point the remote control directly toward the IR sensor.– Check that the batteries are loaded correctly.
The display panel is dark.	<ul style="list-style-type: none">– Press DIM again.
Low hum or buzz sound.	<ul style="list-style-type: none">– Place the DVD system as far away as possible from electrical devices that may be causing interference.

Glossary

Analogue: Sound that has not been turned into numbers. Analogue sound varies, while digital sound has specific numerical values. These jacks send audio through two channels, the left and right.

Aspect ratio: The ratio of vertical and horizontal sizes of a displayed image. The horizontal vs. vertical ratio of conventional TVs is 4:3, and that of wide-screens is 16:9.

AUDIO OUT Jacks: Red and white jacks on the back of the DVD System that send audio to another system (TV, Stereo, etc.)

Bit Rate: The amount of data used to hold a given length of music; measured in kilobits per second, or kbps. Or, the speed at which you record. Generally, the higher the bit rate, or the higher the recording speed, the better the sound quality. However, higher bit rates use more space on a Disc.

Chapter: Sections of a picture or a music piece on a DVD that are smaller than titles. A title is composed of several chapters. Each chapter is assigned a chapter number enabling you to locate the chapter you want.

Component Video Out Jacks: Red, blue, and green jacks on the back of the DVD System that send high-quality video to a TV that has Component Video In jacks (R/G/B, Y/Pb/Pr, YUV, etc.)

Disc menu: A screen display prepared for allowing selection of images, sounds, subtitles, multi-angles, etc recorded on a DVD.

Digital: Sound that has been converted into numerical values. Digital sound is available when you use the DIGITAL AUDIO OUT COAXIAL or OPTICAL jacks. These jacks send audio through multiple channels, instead of just two channels as analogue does.

Dolby Digital: A surround sound system developed by Dolby Laboratories containing up to six channels of digital audio (front left and right, surround left and right, centre and subwoofer).

Dolby Pro Logic II: It creates five full-bandwidth output channels from two-channel sources. Decode only systems that derive 5.1 channels instead of the conventional four channels of Dolby Pro Logic surround sound.

JPEG: A very common digital still picture format. A still-picture data compression system proposed by the Joint Photographic Expert Group, which features small decrease in image quality in spite of its high compression ratio.

MP3: A file format with a sound data compression system. "MP3" is the abbreviation of Motion Picture Experts Group 1 (or MPEG-1) Audio Layer 3. By using the MP3 format. One CD-R or CD-RW can contain about 10 times more data than a regular CD.

Parental control: Limits Disc play according to the age of the users or the limitation level in each country. The limitation varies from disc to disc; when it is activated, playback will be prohibited if the software's level is higher than the user-set level.

PCM (Pulse Code Modulation): A system for converting analogue sound signal to digital signal for later processing, with no data compression used in conversion.

Playback control (PBC): Refers to the signal recorded on video CDs or SVCDs for controlling playback. By using menu screens recorded on a Video CD or SVCD that supports PBC, you can enjoy interactive playback and searching.

Progressive Scan: It displays all the horizontal lines of a picture at one time, as a single frame. This system can convert the interlaced video from DVD into progressive format when the DVD Player is connected to a Progressive Scan TV. It dramatically increases the vertical resolution and provides the best picture.

Region code: A system allowing discs to be played only in the region designated. This unit will only play discs that have compatible region codes. You can find the region code of your unit by looking on the product label. Some discs are compatible with more than one region (or ALL regions).

S-Video: Produces a clear picture by sending separate signals for the luminance and the colour. You can use S-Video only if your TV has an S-Video In jack.

Sampling Frequency: Frequency of sampling data when analogue data is converted to digital data. Sampling frequency numerically represents how many times the original analogue signal is sampled per second.

Surround: A system for creating realistic three-dimensional sound fields full of realism by arranging multiple speakers around the listener.

Title: The longest section of a movie or music feature on DVD. Each title is assigned a title number, enabling you to locate the title you want.

VIDEO OUT jack: Yellow jack on the back of the DVD system that sends the DVD picture video to a TV.

**First connect ...
... then play**
(see next page)

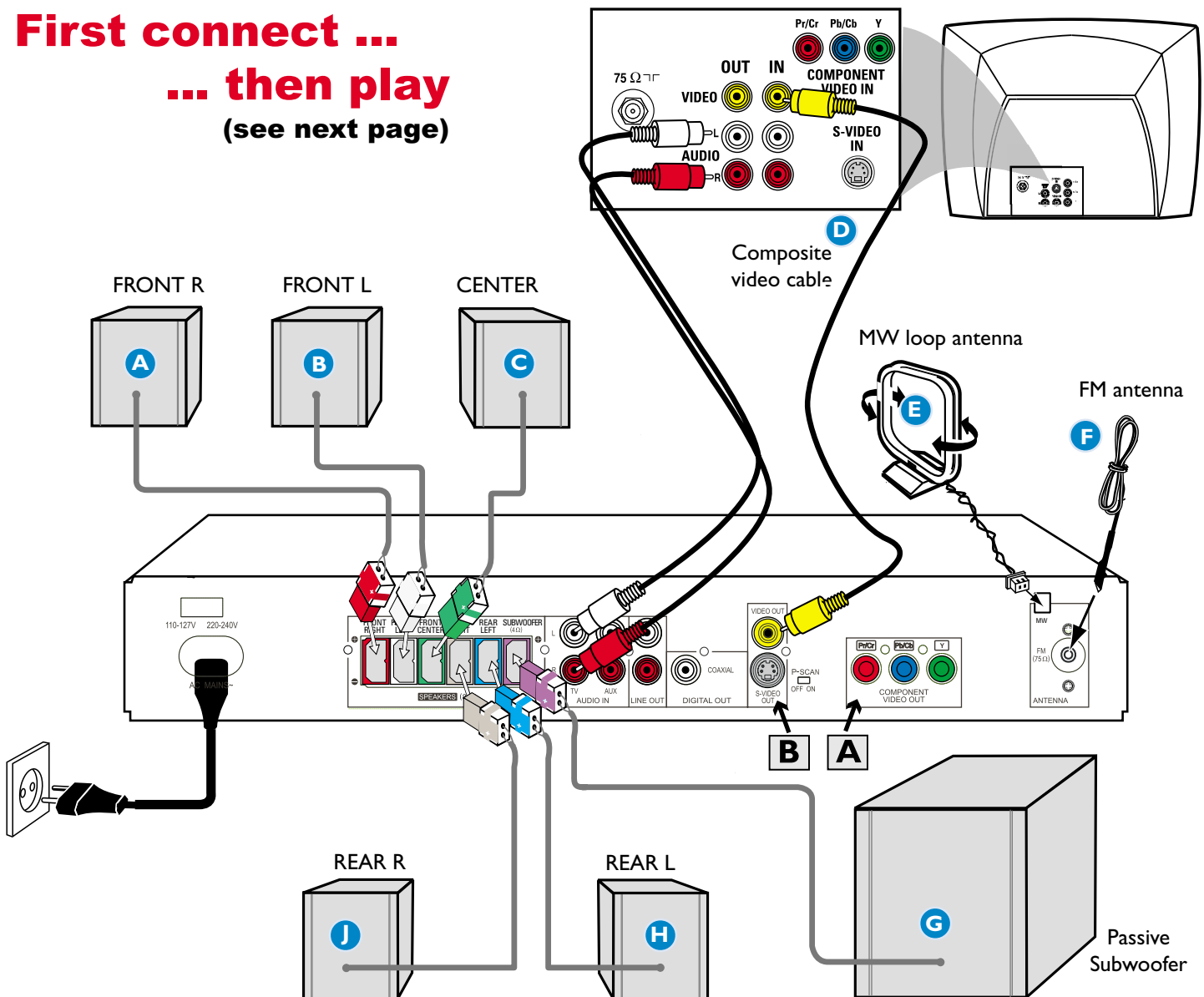

Helpful Hints

To obtain a better picture quality effect, you can choose to connect an extra video connection if your TV has the same input connector: **A** or **B**.

	Use this video cable (not supplied)	If your TV has this video input jack(s)
A		COMPONENT VIDEO IN
B		S-VIDEO IN

75 Ω ANTENNA IN If your TV has only a single Antenna In jack, you will need an accessory RF modulator. The RF modulator converts the video from the DVD system so it can play through the TV's Antenna connector. Refer to your owner's manual for proper connection (refer to page 9 in the owner's manual).

P-SCAN Do not switch the P-SCAN to 'ON' position, unless you have connected the DVD system to a Progressive Scan TV using the Component (Y Pb/Cb Pr/Cr) video jacks.

When listening to TV programmes, press TV button on the remote to set the DVD system to TV mode in order for the sound to be heard.

For connecting to a VCR, see page 11 in the owner's manual for more details.

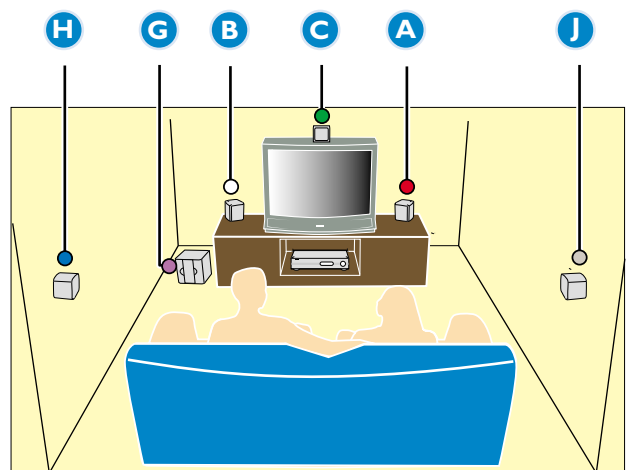

PHILIPS

Playing a disc



Make sure your DVD system and TV are connected and turned on!

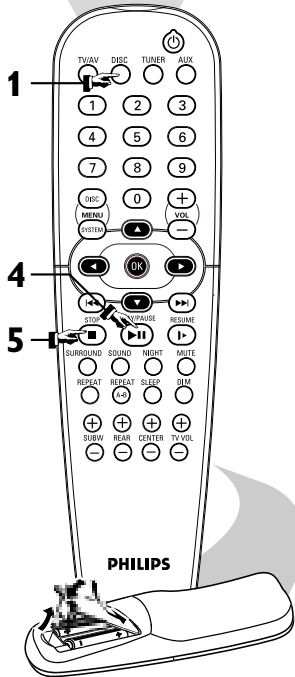

- 1 Press DISC on the remote control.**
You can also press the SOURCE button on the front panel until "DISC" appears on the display panel.
- 2 Turn on the TV and select the correct Video In mode.**
You should see the blue DVD background screen on the TV (if no disc in the DVD system).
- 3 Press OPEN/CLOSE ▲ on the front of the DVD system and load a disc, then press OPEN/CLOSE ▲ again to close the disc tray.**
Make sure the disc label is facing up. For double-sided discs, load the side you want to play face up.
- 4 Press ► II to start playback.**
If a disc menu appears, use ▲▼◀▶ buttons on the remote to make the necessary selection, then press OK to confirm. Or, use the numeric keypad on the remote to select features. Follow the instructions given in the disc menu.
- 5 To stop playback, press STOP ■.**

No picture?

Check the AV (Audio/Video) mode on your TV.

- * Usually this channel is between the lowest and highest channels and may be called FRONT, AV IN, or VIDEO.
- * Or, you may go to channel 1 on your TV, then press the Channel down button repeatedly until you see the Video In channel.
- * Or, your TV remote control may have a button or switch that chooses different video modes.
- * Do not use channel 3 or 4 on the TV unless you are using an RF modulator.
- * See your TV manual for more details.

Using the DVD setup menu

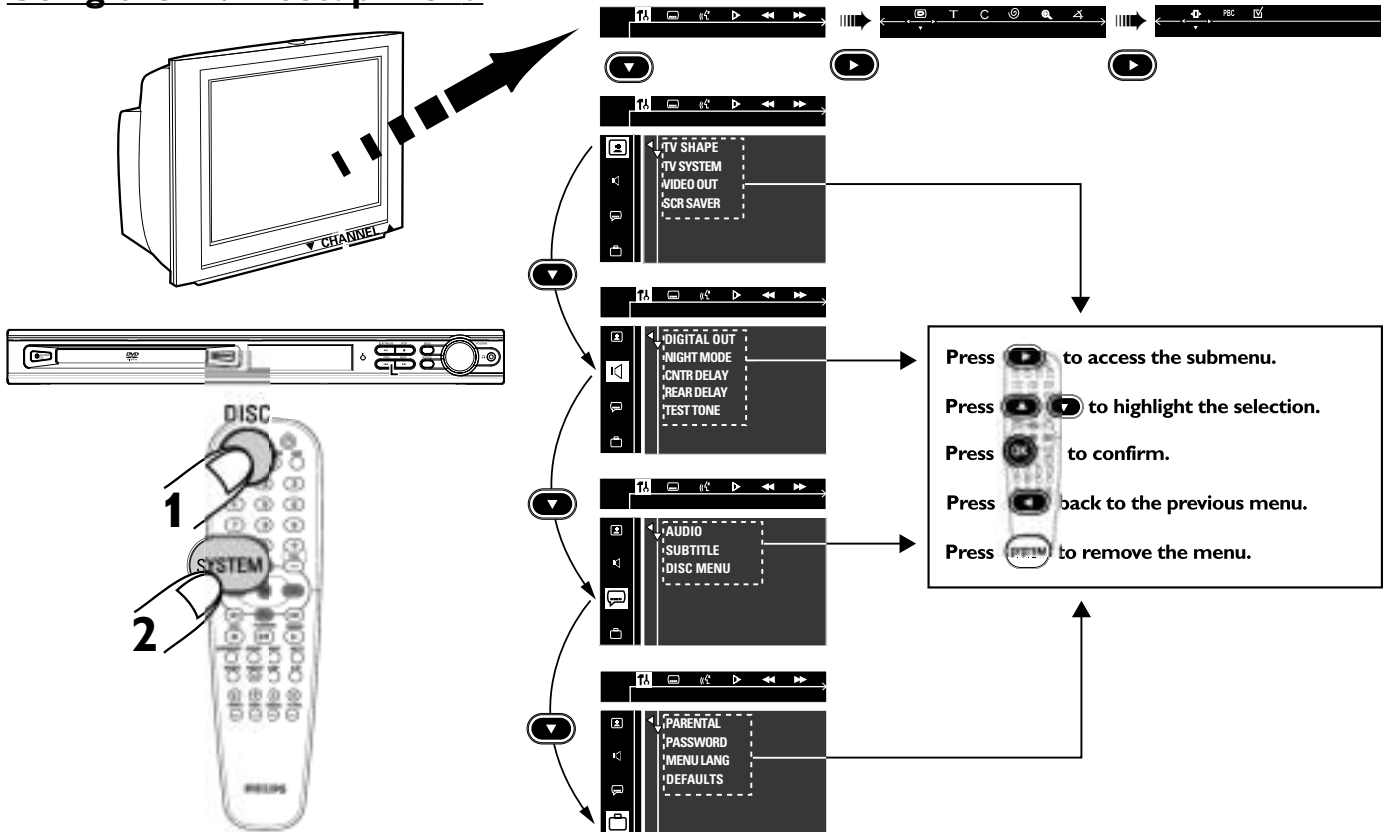

Detailed playback features and additional functions are described in the accompanying owner's manual.

Free Manuals Download Website

<http://myh66.com>

<http://usermanuals.us>

<http://www.somanuals.com>

<http://www.4manuals.cc>

<http://www.manual-lib.com>

<http://www.404manual.com>

<http://www.luxmanual.com>

<http://aubethermostatmanual.com>

Golf course search by state

<http://golfingnear.com>

Email search by domain

<http://emailbydomain.com>

Auto manuals search

<http://auto.somanuals.com>

TV manuals search

<http://tv.somanuals.com>