

EN Print your user manual at www.philips.com/support
 FR Imprimez votre manuel d'utilisation disponible à l'adresse www.philips.com/support
 ES Imprima el manual de usuario en www.philips.com/support
 DE Drucken Sie Ihr Benutzerhandbuch unter www.philips.com/support aus.
 NL Druk uw gebruikershandleiding af via www.philips.com/support
 IT Stampare il manuale dell'utente dal sito www.philips.com/support
 DA Udskriv brugervejledningen på www.philips.com/support
 FI Tulosta käyttöopas osoitteesta www.philips.com/support

SV Skriv ut din användarhandbok på www.philips.com/support
 PT Imprima o seu manual do utilizador em www.philips.com/support
 EL Εκτυπώστε το εγχειρίδιο χρήσης στη διεύθυνση www.philips.com/support
 PL Εκτυπώστε το εγχειρίδιο χρήσης στη διεύθυνση www.philips.com/support
 RU Руководство пользователя можно распечатать на www.philips.com/support
 CS Vytiskněte si uživatelský manuál na webu www.philips.com/support
 SK Vytlačte si svoj návod na používanie na stránke www.philips.com/support
 HU A www.philips.com/support webcímen található felhasználói kézikönyv nyomtatása.

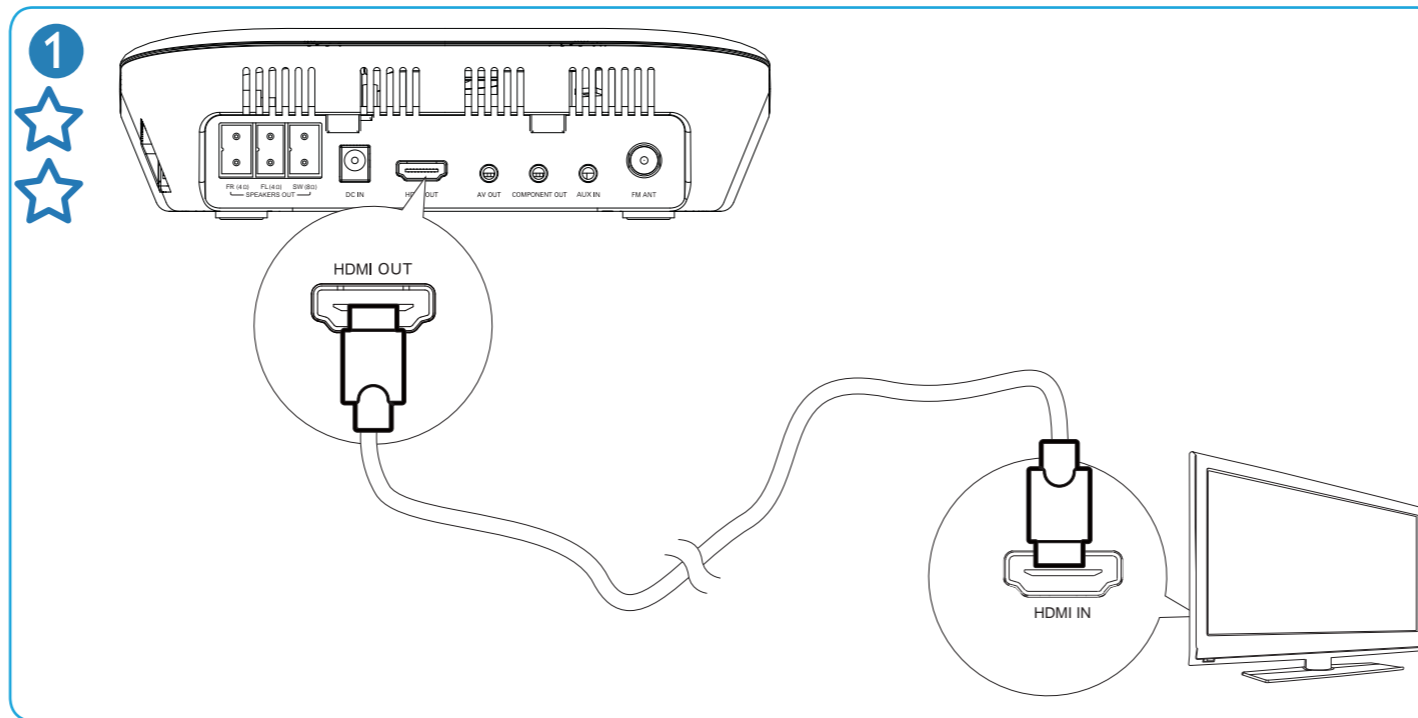

1

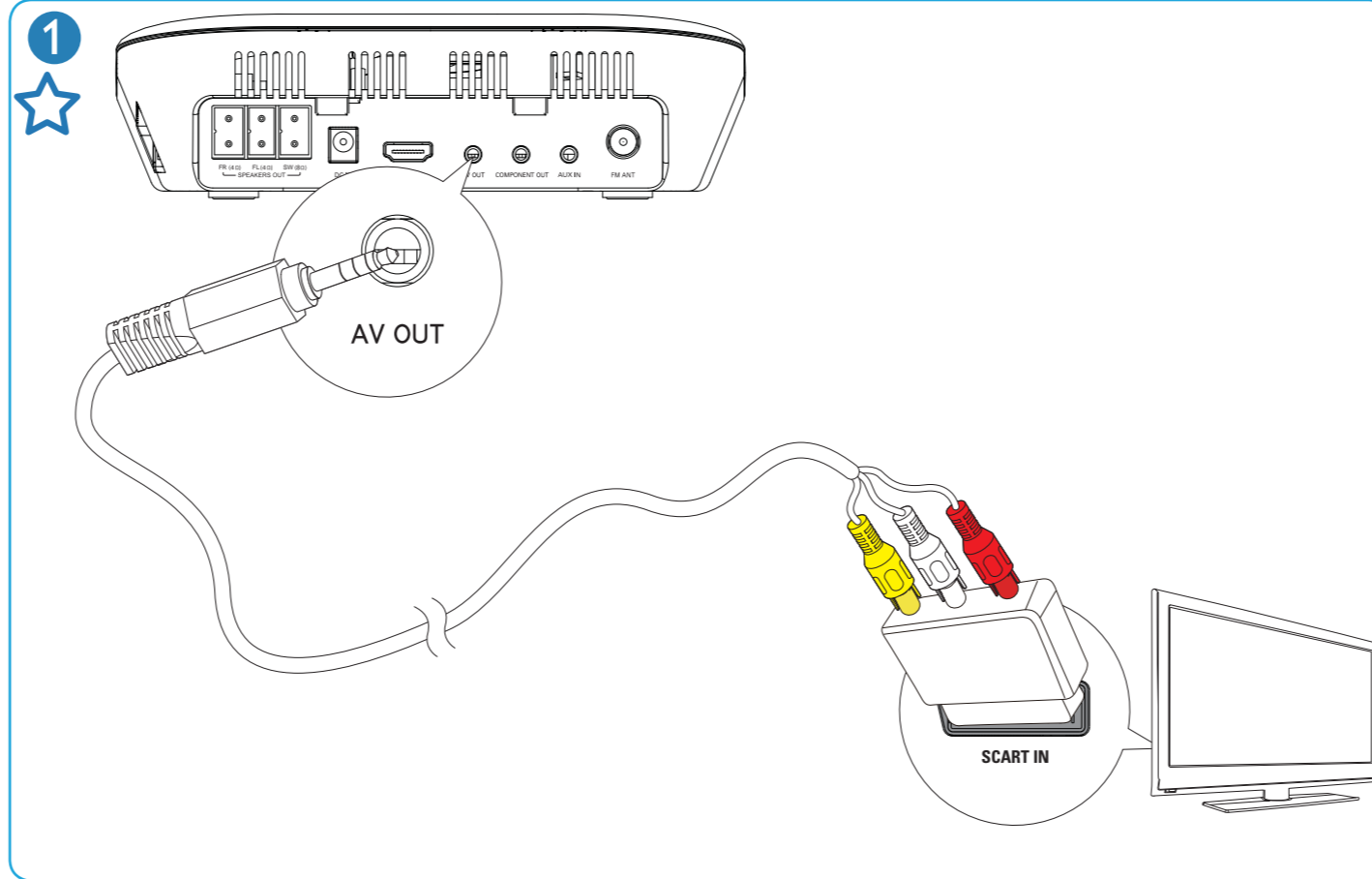

1

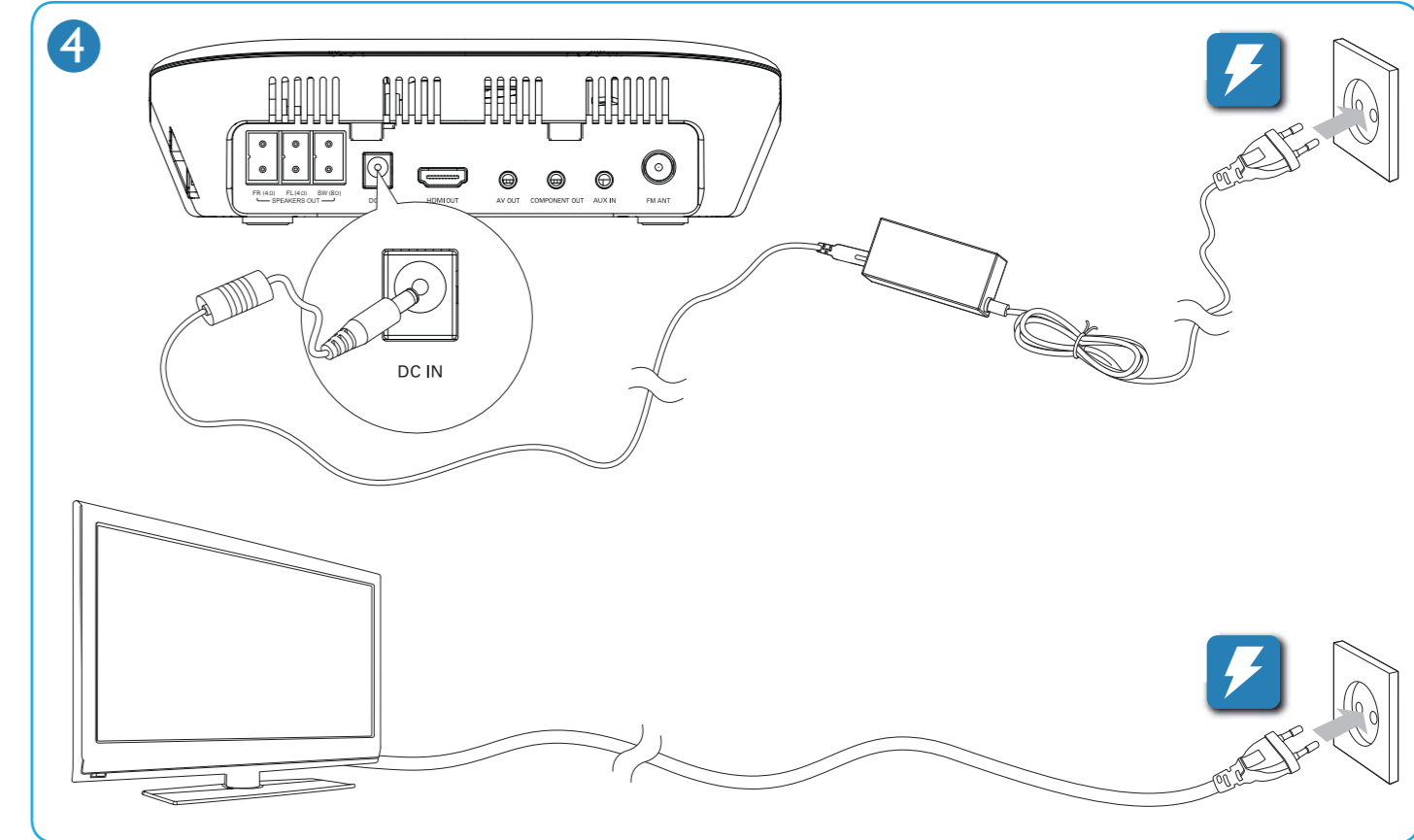
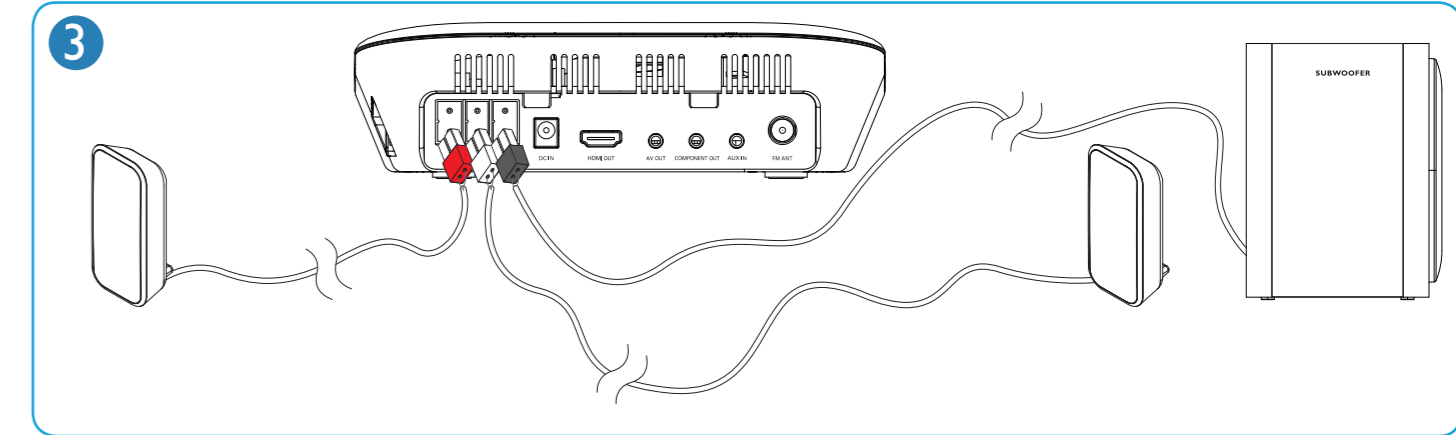
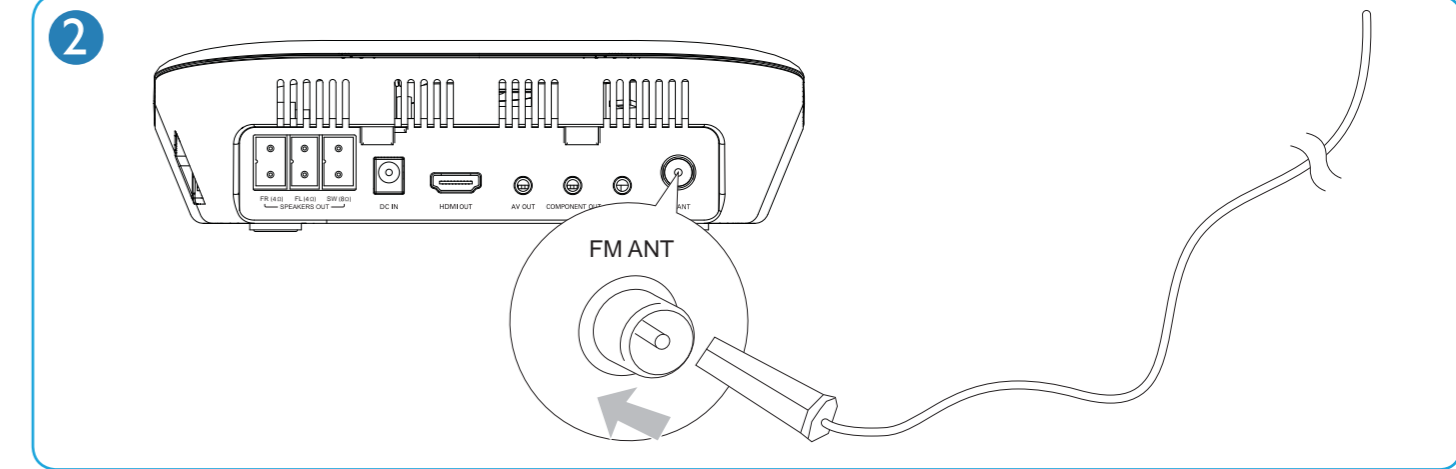

2

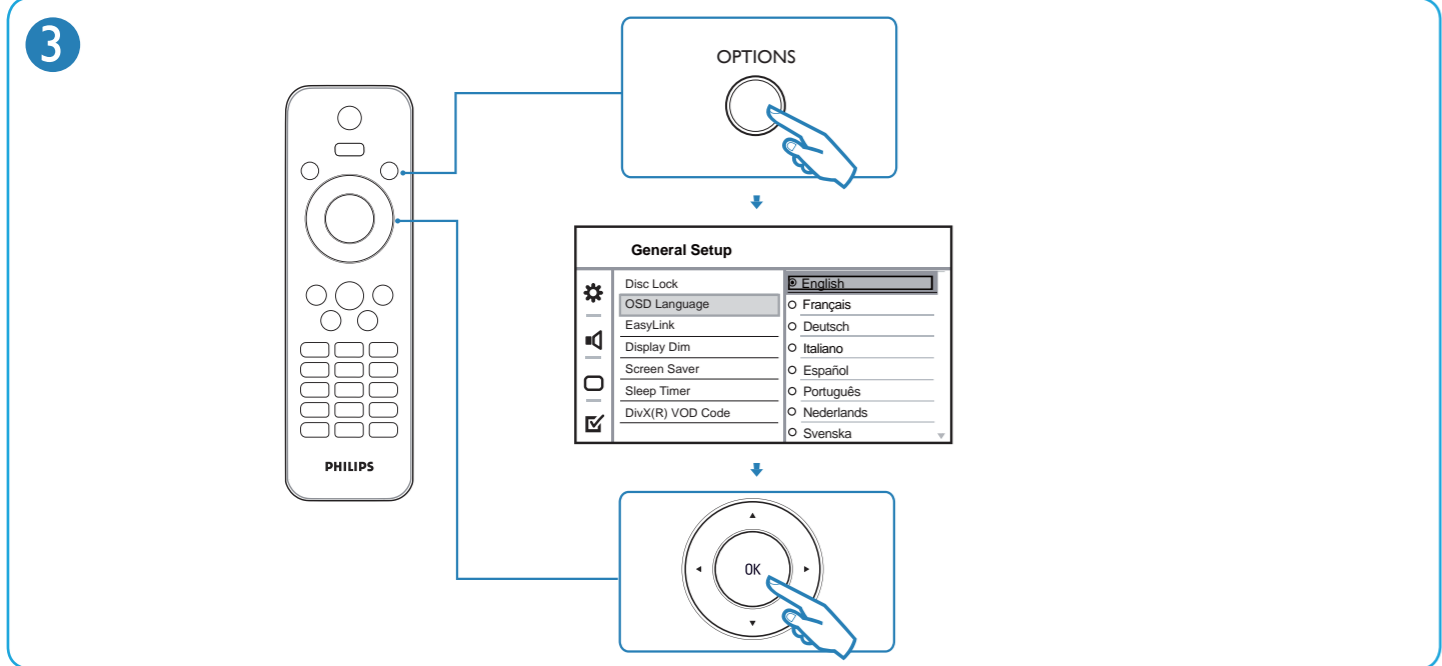
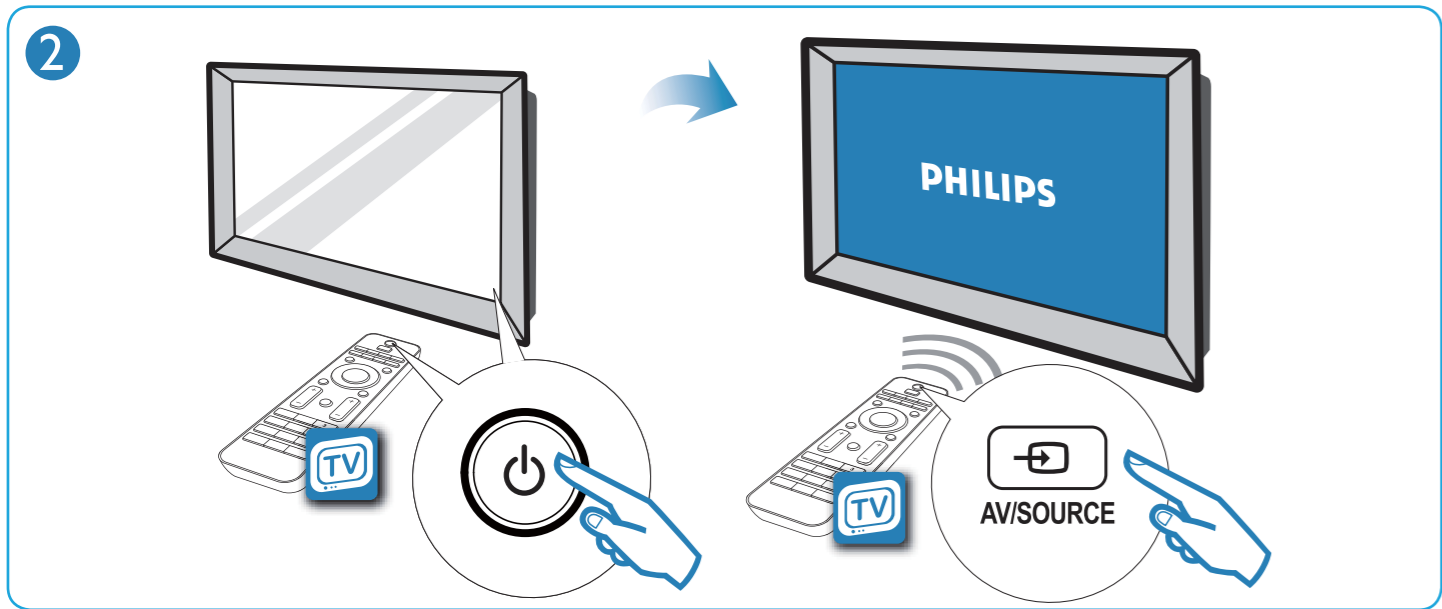
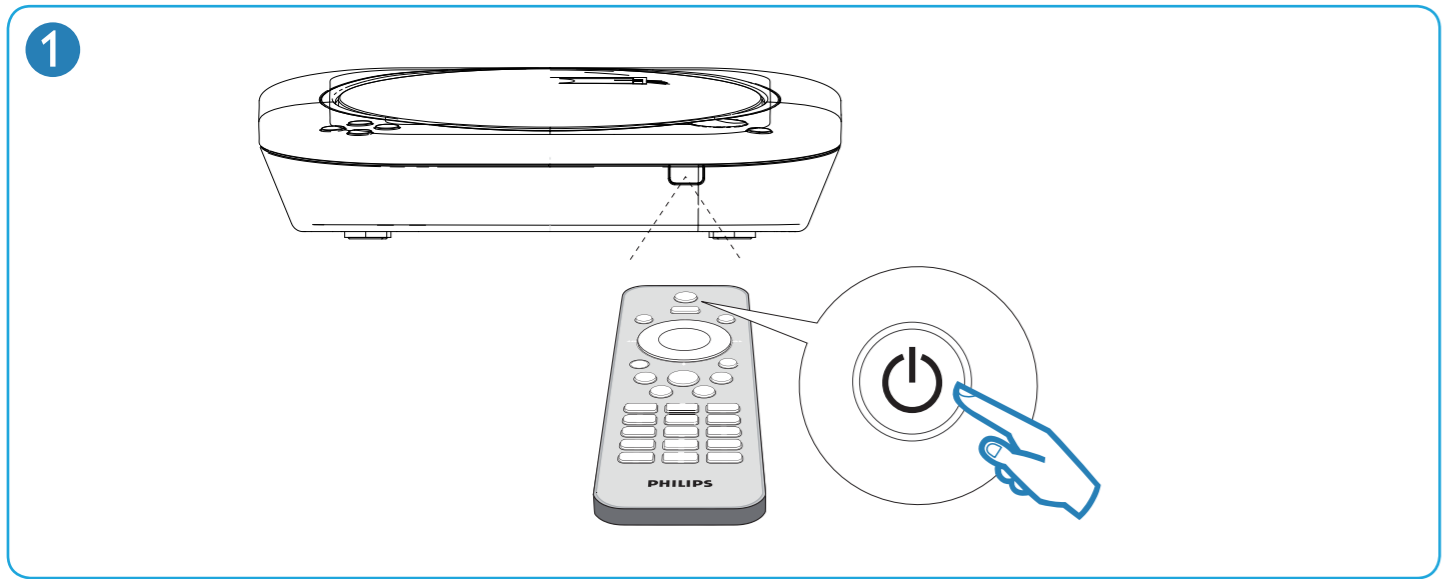

3

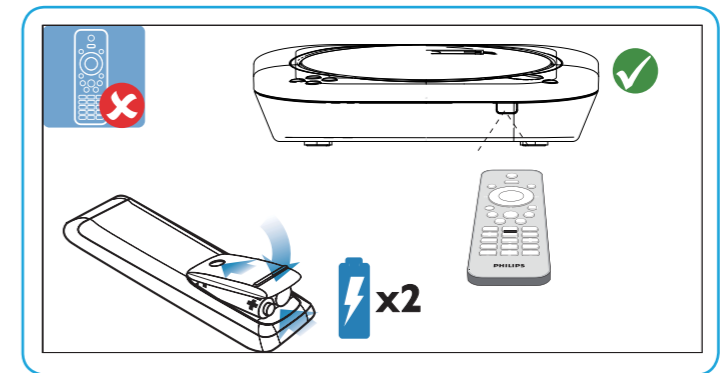
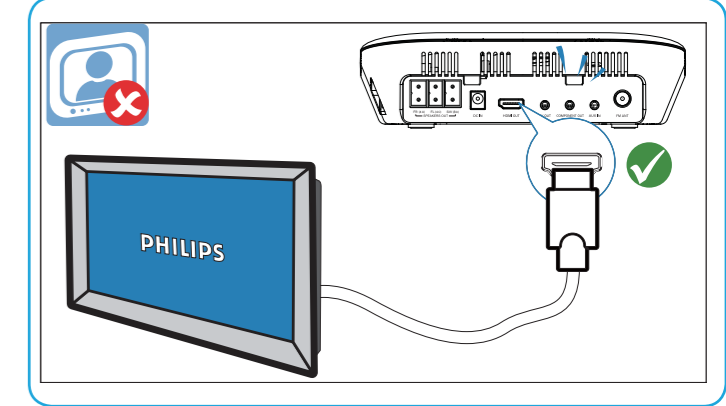
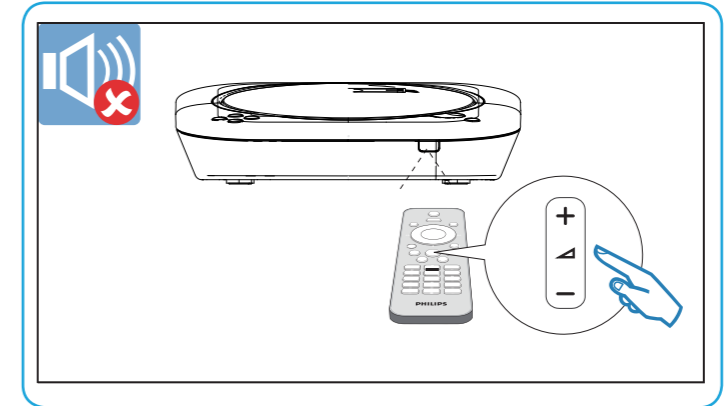
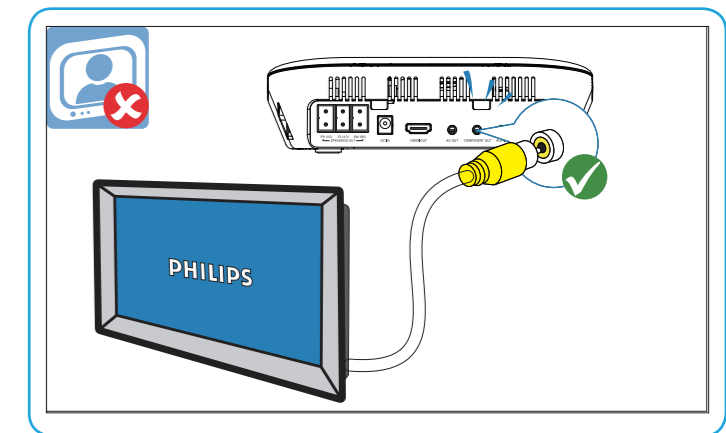
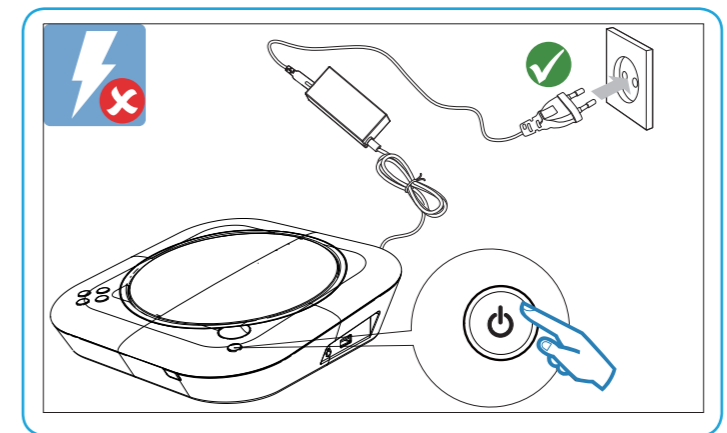
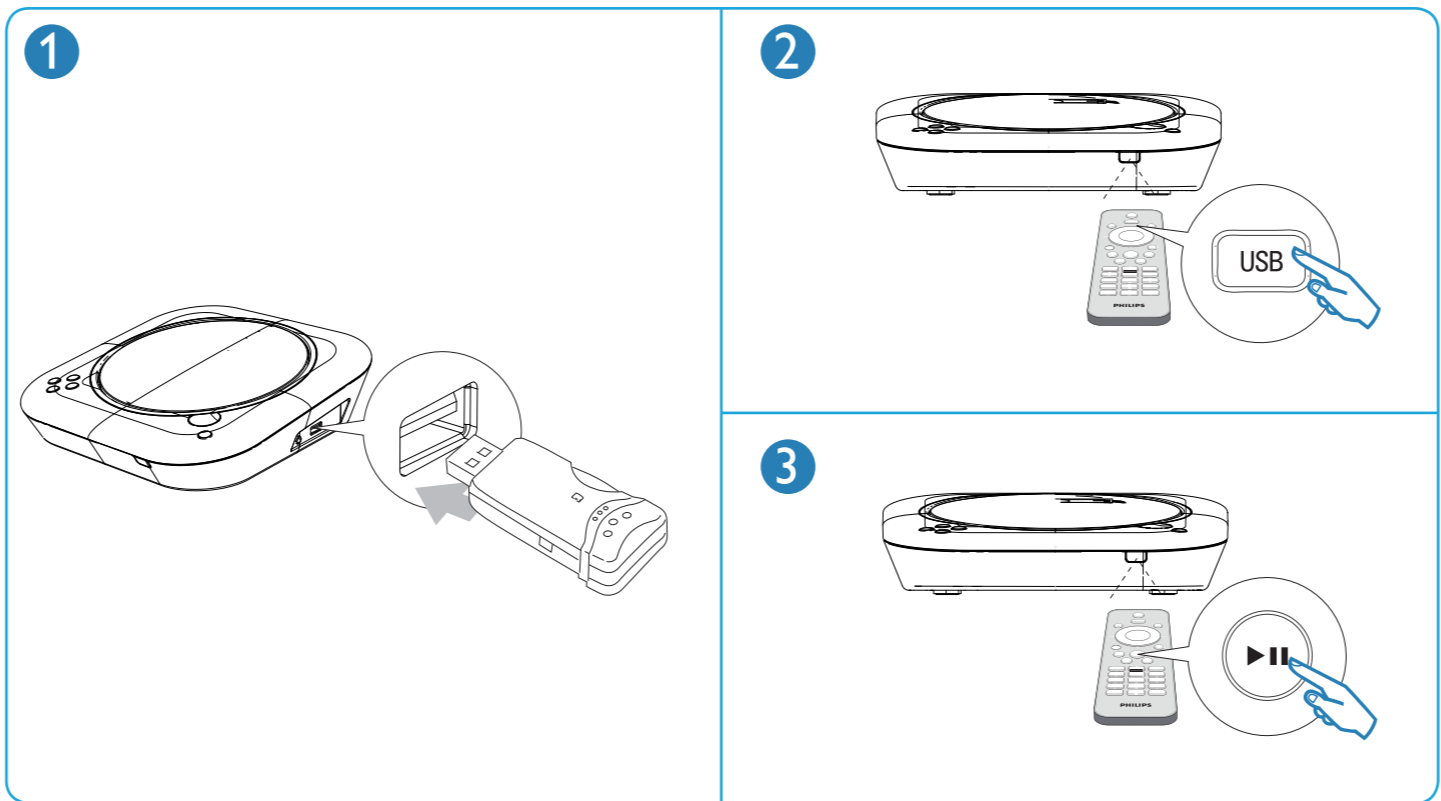
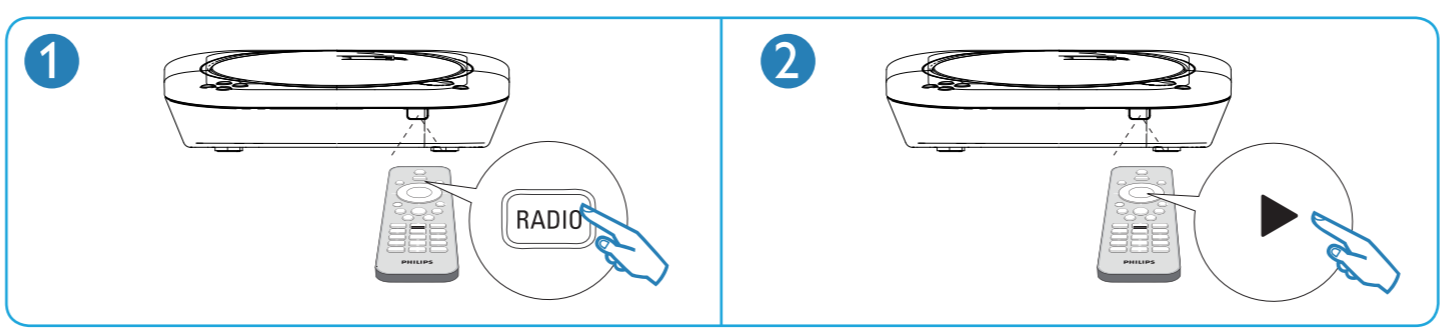
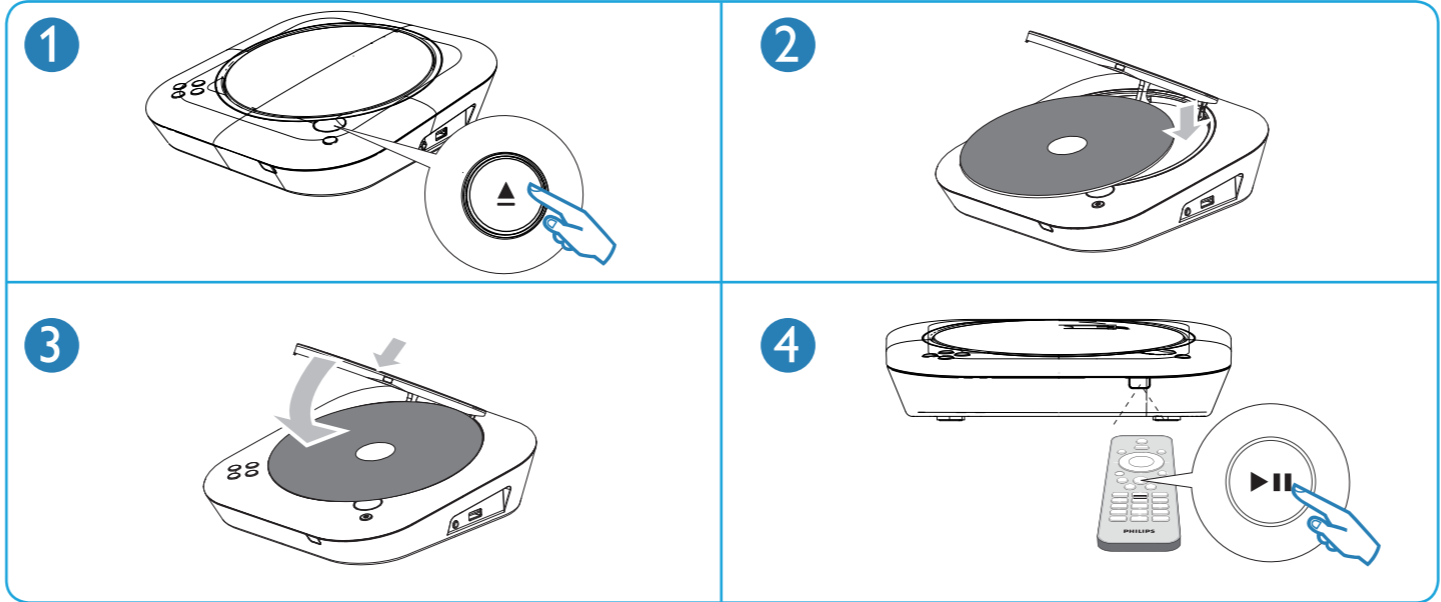

© Royal Philips Consumer Lifestyle N.V. 2009
All rights reserved.
<http://www.philips.com>

Be responsible
Respect copyrights



Free Manuals Download Website

<http://myh66.com>

<http://usermanuals.us>

<http://www.somanuals.com>

<http://www.4manuals.cc>

<http://www.manual-lib.com>

<http://www.404manual.com>

<http://www.luxmanual.com>

<http://aubethermostatmanual.com>

Golf course search by state

<http://golfingnear.com>

Email search by domain

<http://emailbydomain.com>

Auto manuals search

<http://auto.somanuals.com>

TV manuals search

<http://tv.somanuals.com>