

Register your product and get support at
www.philips.com/welcome

DC350/37



Thank you for choosing Philips.

Need help fast?

Read your Quick Start Guide and/or User Manual first for quick tips that make using your Philips product more enjoyable.

If you have read your instructions and still need assistance, you may access our online help at

www.philips.com/welcome
or call

1-888-PHILIPS (744-5477)

while with your product.

(and Model / Serial number)



Philips vous remercie de votre confiance.

Besoin d'une aide rapide?

Le Guide rapide de début et Manuel de l'utilisateur regorgent d'astuces destinées à simplifier l'utilisation de votre produit Philips. Toutefois, si vous ne parvenez pas à résoudre votre problème, vous pouvez accéder à notre aide en ligne à l'adresse

www.philips.com/welcome

ou faites le

1-800-661-6162 (Francophone)

1-888-PHILIPS (744-5477) (English speaking)

Veillez à avoir votre produit à portée de main.

(et model / serial nombre)



Gracias por escoger Philips

Necesita ayuda inmediata?

Lea primero la Guía rápida del comienzo o el Manual del usuario, en donde encontrará consejos que le ayudarán a disfrutar plenamente de su producto Philips.

Si después de leerlo aún necesita ayuda, consulte nuestro servicio de asistencia en línea en

www.philips.com/welcome

o llame al teléfono

1-888-PHILIPS (744-5477)

y tenga a mano el producto.
(y número de model / serial)



EN User manual 3

FR Mode d'emploi 29

ES Manual del usuario 56

PHILIPS

Download from Www.Somanuals.com. All Manuals Search And Download.

Return your Product Registration Card or register online at
www.philips.com/welcome today to get the very most from your purchase.

Registering your model with PHILIPS makes you eligible for all of the valuable benefits listed below, so don't miss out. Complete and return your Product Registration Card at once, or register online at www.philips.com/welcome to ensure:

*Proof of Purchase

Returning the enclosed card guarantees that your date of purchase will be on file, so no additional paperwork will be required from you to obtain warranty service.

*Product Safety Notification

By registering your product, you'll receive notification - directly from the manufacturer - in the rare case of a product recall or safety defect.

*Additional Benefits

Registering your product guarantees that you'll receive all of the privileges to which you're entitled, including special money-saving offers.

PHILIPS

Congratulations on your purchase, and welcome to the "family!"

Dear PHILIPS product owner:

Thank you for your confidence in PHILIPS. You've selected one of the best-built, best-backed products available today. We'll do everything in our power to keep you happy with your purchase for many years to come. As a member of the PHILIPS "family," you're entitled to protection by one of the most comprehensive warranties and outstanding service networks in the industry. What's more, your purchase guarantees you'll receive all the information and special offers for which you qualify, plus easy access to accessories from our convenient home shopping network.

Most importantly, you can count on our uncompromising commitment to your total satisfaction.

All of this is our way of saying welcome - and thanks for investing in a PHILIPS product.

P.S. To get the most from your PHILIPS purchase, be sure to complete and return your Product Registration Card at once, or register online at:

www.philips.com/welcome

Know these

safety symbols



 This "bolt of lightning" indicates un-insulated material within your unit may cause an electrical shock. For the safety of everyone in your household, please do not remove product covering.

 The "exclamation point" calls attention to features for which you should read the enclosed literature closely to prevent operating and maintenance problems.

WARNING: To reduce the risk of fire or electric shock, this apparatus should not be exposed to rain or moisture and objects filled with liquids, such as vases, should not be placed on this apparatus.

CAUTION: To prevent electric shock, match wide blade of plug to wide slot, fully insert.

ATTENTION: Pour éviter les choc électriques, introduire la lame la plus large de la fiche dans la borne correspondante de la prise et pousser jusqu'au fond.

For Customer Use

Enter below the Serial No. which is located on the rear of the cabinet. Retain this information for future reference.

Model No. _____

Serial No. _____

PHILIPS

Visit our World Wide Web Site at <http://www.philips.com/welcome>

PHILIPS LIMITED WARRANTY ONE (1) YEAR

WARRANTY COVERAGE:

PHILIPS warranty obligation is limited to the terms set forth below.

WHO IS COVERED:

Philips warrants the product to the original purchaser or the person receiving the product as a gift against defects in materials and workmanship as based on the date of original purchase ("Warranty Period") from an Authorized Dealer. The original sales receipt showing the product name and the purchase date from an authorized retailer is considered such proof.

WHAT IS COVERED:

The Philips warranty covers new products if a defect in material or workmanship occurs and a valid claim is received by Philips within the Warranty Period. At its option, Philips will either (1) repair the product at no charge, using new or refurbished replacement parts, or (2) exchange the product with a product that is new or which has been manufactured from new, or serviceable used parts and is at least functionally equivalent or most comparable to the original product in Philips current inventory, or (3) refund the original purchase price of the product. Philips warrants replacement products or parts provided under this warranty against defects in materials and workmanship from the date of the replacement or repair for ninety (90) days or for the remaining portion of the original product's warranty, whichever provides longer coverage for you. When a product or part is exchanged, any replacement item becomes your property and the replaced item becomes Philips' property. When a refund is given, your product becomes Philips' property.

Note: Any product sold and identified as refurbished or renewed carries a ninety (90) day limited warranty.

Replacement product can only be sent if all warranty requirements are met. Failure to follow all requirements can result in delay.

WHAT IS NOT COVERED - EXCLUSIONS AND LIMITATIONS:

This Limited Warranty applies only to the new products manufactured by or for Philips that can be identified by the trademark, trade name, or logo affixed to it. This Limited Warranty does not apply to any non-Philips hardware product or any software, even if packaged or sold with the product. Non-Philips manufacturers, suppliers, or publishers may provide a separate warranty for their own products packaged with the bundled product.

Philips is not liable for any damage to or loss of any programs, data, or other information stored on any media contained within the product, or any non-Philips product or part not covered by this warranty. Recovery or reinstallation of programs, data or other information is not covered under this Limited Warranty.

This warranty does not apply (a) to damage caused by accident, abuse, misuse, neglect, misapplication, or non-Philips product, (b) to damage caused by service performed by anyone other than Philips or Philips Authorized Service Location, (c) to a product or a part that has been modified without the written permission of

Philips, or (d) if any Philips serial number has been removed or defaced, or (e) product, accessories or consumables sold "AS IS" without warranty of any kind by including refurbished Philips product sold "AS IS" by some retailers.

This Limited Warranty does not cover:

- Shipping charges to return defective product to Philips.
- Labor charges for installation or setup of the product, adjustment of customer controls on the product, and installation or repair of antenna/signal source systems outside of the product.
- Product repair and/or part replacement because of improper installation or maintenance, connections to improper voltage supply, power line surge, lightning damage, retained images or screen markings resulting from viewing fixed stationary content for extended periods, product cosmetic appearance items due to normal wear and tear, unauthorized repair or other cause not within the control of Philips.
- Damage or claims for products not being available for use, or for lost data or lost software.
- Damage from mishandled shipments or transit accidents when returning product to Philips.
- A product that requires modification or adaptation to enable it to operate in any country other than the country for which it was designed, manufactured, approved and/or authorized, or repair of products damaged by these modifications.
- A product used for commercial or institutional purposes (including but not limited to rental purposes).
- Product lost in shipment and no signature verification receipt can be provided.
- Failure to operate per Owner's Manual.

TO OBTAIN ASSISTANCE IN THE U.S.A., PUERTO RICO, OR U.S. VIRGIN ISLANDS...

Contact Philips Customer Care Center at:
1-888-PHILIPS (1-888-744-5477)

TO OBTAIN ASSISTANCE IN CANADA...

1-800-661-6162 (French Speaking)
1-888-PHILIPS (1-888-744-5477) - (English or Spanish Speaking)

REPAIR OR REPLACEMENT AS PROVIDED UNDER THIS WARRANTY IS THE EXCLUSIVE REMEDY FOR THE CONSUMER. PHILIPS SHALL NOT BE LIABLE FOR ANY INCIDENTAL OR CONSEQUENTIAL DAMAGES FOR BREACH OF ANY EXPRESS OR IMPLIED WARRANTY ON THIS PRODUCT. EXCEPT TO THE EXTENT PROHIBITED BY APPLICABLE LAW, ANY IMPLIED WARRANTY OF MERCHANTABILITY OR FITNESS FOR A PARTICULAR PURPOSE ON THIS PRODUCT IS LIMITED IN DURATION TO THE DURATION OF THIS WARRANTY.

Some states do not allow the exclusions or limitation of incidental or consequential damages, or allow limitations on how long an implied warranty lasts, so the above limitations or exclusions may not apply to you.

This warranty gives you specific legal rights. You may have other rights which vary from state/province to state/province.

Philips, P.O. Box 671539, Marietta, GA. 30006-0026

3121 233 48802



Contents

1	Important	6
	Safety	6
	Notice	7
2	Your Docking Entertainment System	9
	Introduction	9
	What's in the box	9
	Overview of the main unit	9
	Overview of the remote control	12
3	Get started	14
	Prepare the remote control	14
	Connect power	15
	Set clock and date	16
	Turn on	16
4	Play	16
	Play from iPod/iPhone	16
	Play from an external device	18
5	Adjust sound	18
	Adjust volume level	18
	Enhance bass	18
	Select a preset sound effect	18
	Mute sound	19
6	Listen to radio	19
	Tune to a radio station	19
	Program radio stations automatically	19
	Program radio stations manually	19
	Select a preset radio station	20
7	Use Bluetooth devices	20
	Connect with a Bluetooth device	21
	Receive a phone call	22
	Listen to music	23
8	Other features	23
	Set the alarm timer	23
	Set the sleep timer	25
	Adjust display brightness	25
9	Product information	25
	Specifications	25
10	Troubleshooting	27

1 Important

Safety

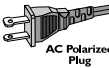
Important Safety Instructions

- ① Read these instructions.
- ② Keep these instructions.
- ③ Heed all warnings.
- ④ Follow all instructions.
- ⑤ Do not use this apparatus near water.
- ⑥ Clean only with dry cloth.
- ⑦ Do not block any ventilation openings. Install in accordance with the manufacturer's instructions.
- ⑧ Do not install near any heat sources such as radiators, heat registers, stoves, or other apparatus (including amplifiers) that produce heat.
- ⑨ Do not defeat the safety purpose of the polarized or grounding-type plug. A polarized plug has two blades with one wider than the other. A grounding type plug has two blades and a third grounding prong. The wide blade or the third prong are provided for your safety. If the provided plug does not fit into your outlet, consult an electrician for replacement of the obsolete outlet.
- ⑩ Protect the power cord from being walked on or pinched, particularly at plugs, convenience receptacles, and the point where they exit from the apparatus.
- ⑪ Only use attachments/accessories specified by the manufacturer.
- ⑫ Use only with the cart, stand, tripod, bracket, or table specified by the manufacturer or sold with the apparatus. When a cart is used, use caution when moving the cart/apparatus combination to avoid injury from tip-over.
- ⑬ Unplug this apparatus during lightning storms or when unused for long periods of time.
- ⑭ Refer all servicing to qualified service personnel. Servicing is required when the apparatus has been damaged in any way, such as power-supply cord or plug is damaged, liquid has been spilled or objects have fallen into the apparatus, the apparatus has been exposed to rain or moisture, does not operate normally, or has been dropped.
- ⑮ Battery usage CAUTION – To prevent battery leakage which may result in bodily injury, property damage, or damage to the unit:
 - Install all batteries correctly, + and - as marked on the unit.

- Do not mix batteries (old and new or carbon and alkaline, etc.).
 - Remove batteries when the unit is not used for a long time.
- ①6 Apparatus shall not be exposed to dripping or splashing.
- ①7 Do not place any sources of danger on the apparatus (e.g. liquid filled objects, lighted candles).
- ①8 This product may contain lead and mercury. Disposal of these materials may be regulated due to environmental considerations. For disposal or recycling information, please contact your local authorities or the Electronic Industries Alliance: www.eiae.org.
- ①9 Where the MAINS plug or an appliance coupler is used as the disconnect device, the disconnect device shall remain readily operable.



Warning

- Never remove the casing of this apparatus.
- Never lubricate any part of this apparatus.
- Never place this apparatus on other electrical equipment.
- Keep this apparatus away from direct sunlight, naked flames or heat.
- Ensure that you always have easy access to the power cord, plug or adaptor to disconnect the apparatus from the power.

Notice

Notice of compliance

The set complies with the FCC Part 15 and with RSS-210. Operation is subject to the following two conditions:

- 1.This device may not cause harmful interference, and
- 2.This device must accept any interference received, including interference that may cause undesired operation.

FCC rules

This equipment has been tested and found to comply with the limits for a Class B digital device, pursuant to Part 15 of the FCC Rules.

These limits are designed to provide reasonable protection against harmful interference in a residential installation. This equipment generates, uses and can radiate radio frequency energy and, if not installed and used in accordance with the instructions, may cause harmful interference to radio communications. However, there is no guarantee that interference will not occur in a particular installation. If this equipment does cause harmful interference to radio or television reception, which can be determined by turning the equipment off and on, the user is encouraged to try to correct the interference by one or more of the following measures:

- Reorient or relocate the receiving antenna.
- Increase the separation between the equipment and receiver.

- Connect the equipment into an outlet on a circuit different from that to which the
 - receiver is connected.
- Consult the dealer or an experienced radio/TV technician for help.

Warning: Changes or modifications made to this equipment not expressly approved by Philips could void the user's authority to operate this equipment.

Model number: PHILIPS DC350/37

Trade Name: Philips

Responsible Party:

Philips Consumer Lifestyle

P.O. Box 671539

Marietta, GA 30006-0026

1-800-PHILIPS (744-5477)

FCC Radiation Exposure Statement

To comply with FCC RF exposure requirements, the device and the antenna for this device must be installed to ensure a minimum separation distance of 20 cm or more from a person's body. Other operating configurations should be avoided.

Canada

This Class B digital apparatus complies with Canadian ICES-003.

Environmental information

All unnecessary packaging has been omitted. We have tried to make the packaging easy to separate into three materials: cardboard (box), polystyrene foam (buffer) and polyethylene (bags, protective foam sheet.)

Your system consists of materials which can be recycled and reused if disassembled by a specialized company. Please observe the local regulations regarding the disposal of packaging materials, exhausted batteries and old equipment.

The Bluetooth® word mark and logos are registered trademarks owned by Bluetooth SIG, Inc. and any use of such marks by Philips is under license.

Windows Media and the Windows logo are trademarks, or registered trademarks of Microsoft Corporation in the United States and/or other countries.



2 Your Docking Entertainment System

Introduction

With this unit, you can enjoy audio from the iPod, iPhone, other audio devices, or the radio. If you own a Bluetooth-enabled device, you can also receive phone calls or listen to audio from the device.

The radio, iPod, or iPhone can be set as the alarm timer. You can set two alarm timers to go off at different times.

For the best sound quality, enrich sound from any source with Digital Sound Control (DSC) and Dynamic Bass Boost.





What's in the box

Check and identify the contents of your package:

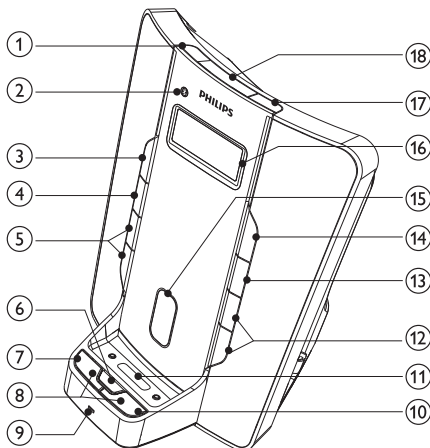
- Main unit
- Remote control
- 1 x AC adaptor
- 1 x MP3 link cable
- 1 x mini USB cable

Overview of the main unit



- ① **ALM 1**
- Set the first alarm timer.
 - View the first alarm time.
 - Turn off the first alarm tone.
- ② **Bluetooth indicator**
- Indicate Bluetooth connection.
- ③ 
- Turn on the unit or switch to standby mode.
 - Turn off an alarm tone.
- ④ **SLEEP**
- Set the sleep timer.
- ⑤ **PRESET +/-**
- Select a preset radio station.
 - Program radio stations.
- ⑥ **MUTE**
- Mute volume.
 - Mute the built-in microphone during a phone call.
- PROG**
- Program radio stations.
- TIME SET**
- Set the clock.
- ⑦ **PAIRING** 
- Pair the unit with a Bluetooth device.
 - Answer an incoming phone call.
 - During a phone call: select to hear the audio from the device or from the unit.
- ⑧ 
- Skip to the previous/next audio file.
 - Search within an audio file.
 - Tune to a radio station.
 - Adjust time.
 - Select 12 hour or 24 hour format.
- ⑨ **MIC**
- Built-in microphone for phone calls.
- ⑩ 
- Reject an incoming phone call.
 - End a phone call.
 - Disconnect a device.
- ⑪ **iPod/iPhone dock**
- Load an iPod/iPhone.
- ⑫ **VOL +/-**
- Adjust volume.

- ⑬ **▶||**
- Start or pause iPod/iPhone play.
- ⑭ **SOURCE**
- Select a source: iPod/iPhone, Bluetooth, tuner or MP3 link.
- ⑮ **Tilt adjustment rod**
- Move forward/backward to adjust the angle at which the iPod/iPhone tilts.
- ⑯ **Display panel**
- Show current status.
- ⑰ **ALM 2**
- Set the second alarm timer.
 - View the second alarm time.
 - Turn off the second alarm tone.
- ⑱ **REPEAT ALARM/BRIGHTNESS CONTROL**
- Repeat an alarm tone at 9-minute intervals.
 - Adjust the display brightness.

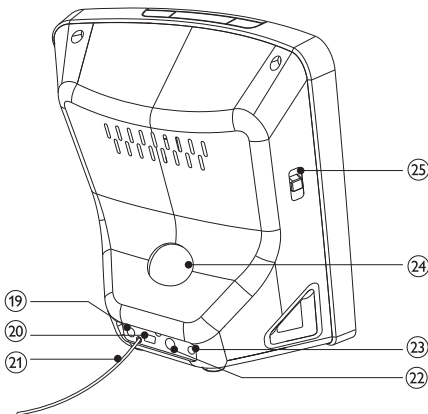

- ⑲ **MP3 LINK**
- Audio input jack for an external audio device.
- ⑳ **TO PC**
- Mini USB jack for synchronization between the iPod/iPhone and a computer.
- ㉑ **Pigtail**
- Improve FM reception.

- 22 **DEMO**
 - Jack for a special device (not supplied) to demonstrate features of the unit.
- 23 **DC IN**
 - Jack for the supplied AC adaptor.
- 24 **Tilt adjustment control**
 - Control the angle at which the iPod/iPhone tilts.
- 25 **iPhone/iPod-RADIO-BUZZER**
 - Select alarm mode.

Overview of the remote control

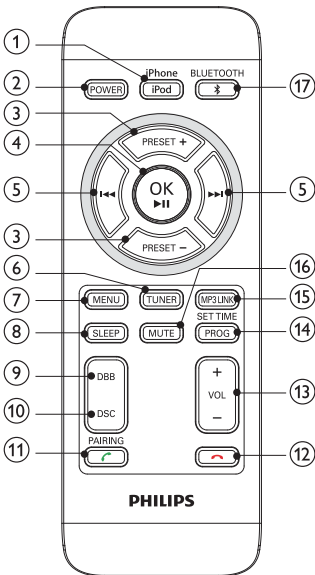

- 1 **iPod/iPhone**
 - Select iPod/iPhone source.
- 2 **POWER**
 - Turn on the unit or switch to standby mode.
 - Turn off an alarm tone.

- ③ **PRESET +/-**
- Select a preset radio station.
 - Program radio stations.
- ④ **▶||/OK**
- Start or pause iPod/iPhone play.
 - Confirm an iPod/iPhone menu selection.
- ⑤ **◀◀▶▶**
- Skip to the previous/next audio file.
 - Search within an audio file.
 - Tune to a radio station.
 - Adjust time.
 - Select 12 hour or 24 hour format.
- ⑥ **TUNER**
- Select tuner source.
- ⑦ **MENU**
- Access iPod/iPhone menu.
- ⑧ **SLEEP**
- Set the sleep timer.
- ⑨ **DBB**
- Turn on or off dynamic bass enhancement.
- ⑩ **DSC**
- Select a preset sound setting: POP, JAZZ, CLASSIC or ROCK.
- ⑪ **PAIRING**
- Pair the unit with a Bluetooth device.
 - Answer an incoming phone call.
 - During a phone call: select to hear the audio from the device or from the unit.
- ⑫ **☾**
- Reject an incoming phone call.
 - End a phone call.
 - Disconnect a device.
- ⑬ **VOL +/-**
- Adjust volume.
- ⑭ **SET TIME/PROG**
- Set the clock.
 - Program radio stations.
- ⑮ **MP3 LINK**
- Audio input jack for an external audio device.
- ⑯ **MUTE**
- Mute volume.
 - Mute the built-in microphone during a phone call.

- ⑰ **BLUETOOTH** ✎
- Select Bluetooth source.

3 Get started



Caution

- Use the controls only as stated in this user manual.

Always follow the instructions in this chapter in sequence.

If you contact Philips, you will be asked for the model and serial number of this apparatus. The model number and serial number are on the bottom of the apparatus.

Write the numbers here:

Model No. _____

Serial No. _____

Prepare the remote control



Caution

- Risk of explosion! Keep batteries away from heat, sunshine or fire. Never discard batteries in fire.
- Perchlorate Material - special handling may apply. See www.dtsc.ca.gov/hazardouswaste/perchlorate.

For first-time use:

- 1 Remove the protective tab to activate the remote control battery.

To replace the remote control battery:

- 1 Open the battery compartment.
- 2 Insert 1 CR2025 battery with correct polarity (+/-) as indicated.
- 3 Close the battery compartment.

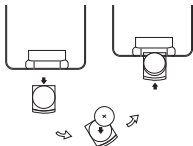



Note

- Before pressing any function button on the remote control, first select the correct source with the remote control instead of the main unit.
- If you are not going to use the remote control for a long time, remove the battery.

Connect power



Caution

- Risk of product damage! Ensure that the power voltage corresponds to the voltage printed on the back or underside of the apparatus.
- Risk of electric shock! When you unplug the AC adaptor, always pull the plug from the socket. Never pull the cord.
- Before connecting the AC adaptor, ensure you have completed all other connections.



Note

- The type plate is located on the bottom of the main unit.

- 1 Prepare the AC power adaptor:



- 2 Connect one end of the AC adaptor to the **DC IN** socket on the main unit.

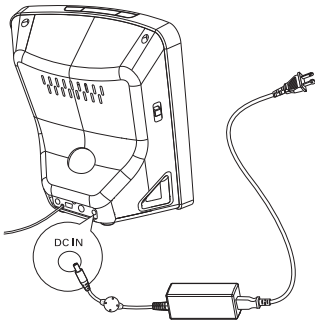

- 3 Connect the other end of the AC adaptor to the wall outlet.

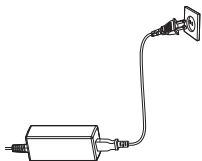

Set clock and date

- 1 Press and hold **SET TIME** for 2 seconds.
↳ The hour digits are displayed and begin to blink.
- 2 Press **⏪⏩** to set the hour.
- 3 Press **SET TIME** to confirm.
↳ The minute digits are displayed and begin to blink.
- 4 Repeat steps 2-3 to set minute, year, month and day.
- 5 Press **⏪⏩** to select 12 hour or 24 hour format.
- 6 Press **SET TIME** to confirm.

Turn on

- 1 Press **POWER**.
↳ The unit switches to the last selected source.

Switch to standby

- 1 Press **POWER** again to switch the unit to standby mode.
↳ The date appears on the display panel.

4 Play

Play from iPod/iPhone

You can enjoy audio from iPod/iPhone through this unit.

Compatible iPod/iPhone

Apple iPod and iPhone models with a 30-pin dock connector:

- iPod classic, iPod touch, iPod nano, iPod 5th generation (video), iPod with color display, iPod mini.
- iPhone, iPhone 3G.

Load the iPod/iPhone

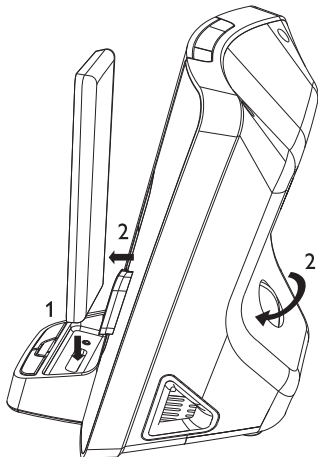

- 1 With the connectors facing each other, place the iPod/iPhone in the dock.
- 2 Turn the tilt adjustment control to adjust the angle at which the iPod/iPhone tilts.
 - ↳ When the unit is connected to power, the docked iPod/iPhone begins to charge.

Remove the iPod/iPhone

- 1 Pull the iPod/iPhone out of the dock.

Listen to the iPod/iPhone

- 1 Ensure that the iPod/iPhone is loaded correctly. (see 'Load the iPod/iPhone' on page 17)
- 2 Press **iPod/iPhone** to select iPod/iPhone source.
 - ↳ The connected iPod/iPhone plays automatically.
 - To pause/resume play, press **▶||**.
 - To skip to a track, press **◀◀▶▶**.
 - To search during play, press and hold **◀◀▶▶**, then release to resume normal play.

- To navigate the menu, press **MENU**, and press **PRESET +/-** to select, then press **▶/||/OK** to confirm.

Connect to a computer

- 1 Load the iPod/iPhone in the dock.
- 2 Press **iPod/iPhone** select the iPod/iPhone source.
- 3 Connect the mini USB cable (supplied) to:
 - the **TO PC** jack (mini USB jack) on the back of the unit.
 - the USB jack on the computer.

↳ If iTunes is installed on the computer, the connected iPod/iPhone begins to synchronize with iTunes. Refer to the device user manual for more details.

Charge the iPod/iPhone

When the unit is connected to power, the docked iPod/iPhone begins to charge.

Play from an external device

You can also listen to an external audio device through this unit.

- 1 Press **MP3 Link** to select MP3 link source.
- 2 Connect the supplied MP3 link cable to:
 - the **MP3 LINK** jack (3.5mm) on the back of the unit.
 - the headphone jack on an external device.
- 3 Start to play the device (see the device user manual).

5 Adjust sound

Adjust volume level

- 1 During play, press **VOL +/-** to increase/decrease the volume level.

Enhance bass

- 1 During play, press **DBB** to turn on or off dynamic bass enhancement.
 - ↳ If DBB is activated, DBB is displayed.

Select a preset sound effect

- 1 During play, press **DSC** repeatedly to select:
 - [POP] (pop)
 - [JAZZ] (jazz)
 - [CLASSIC] (classic)
 - [ROCK] (rock)

Mute sound

- 1 During play, press **MUTE** to mute/unmute sound.

6 Listen to radio



Note

- Only FM radio reception is available on this unit.

Tune to a radio station

- 1 Press **TUNER** to select FM.
- 2 Press and hold **◀◀▶▶** for more than 2 seconds.
 - ↳ [Srch] (search) is displayed.
 - ↳ The radio tunes to a station with strong reception automatically.
- 3 Repeat step 2 to tune to more stations.
 - To tune to a weak station, press **◀◀▶▶** repeatedly until you find optimal reception.

Program radio stations automatically

You can program a maximum of 20 preset radio stations.

- 1 In the tuner mode, press and hold **PROG** for more than 2 seconds to activate automatic program mode.
 - ↳ [AUTO] (auto) is displayed.
 - ↳ All available stations are programmed in the order of waveband reception strength.
 - ↳ The first programmed radio station is broadcast automatically.

Program radio stations manually

You can program a maximum of 20 preset radio stations.

- 1 Press **PRESET +/-** to select a number (1 to 20).
- 2 Press and hold **PRESET +/-** for more than 2 seconds to activate program mode.
 - ↳ "PRXX" is displayed and begins to blink.
- 3 Tune to a radio station. (see 'Tune to a radio station' on page 19)
- 4 Press **▶||** to confirm.
 - ↳ The preset number and the frequency of the preset station are displayed.

- 5 Repeat the above steps to program other stations.



Note

- To overwrite a programmed station, store another station in its place.

Select a preset radio station

- 1 Press **PRESET +/-** to select a preset number.



Tip

- Position the antenna as far as possible from TV,VCR or other radiation source.
- For optimal reception, fully extend and adjust the position of the antenna.

7 Use Bluetooth devices

This unit can wirelessly receive audio from Bluetooth-enabled devices within a range of approximately 10 meters (30 feet).

Supported Bluetooth profiles

This unit supports these Bluetooth profiles:

- Hands-Free Profile (HFP)
- Headset Profile (HSP)
- Advanced Audio Distribution Profile (A2DP)
- Audio Video Remote Control Profile (AVRCP)



Tip

- Before you use a Bluetooth-enabled device with this unit, read the user manual of the device for compatibility.

Connect with a Bluetooth device



Note

- The operational range between this unit and a Bluetooth device is approximately 10 meters (30 feet).
- Before you connect a Bluetooth device to this unit, familiarize yourself with the Bluetooth capabilities of the device.
- Compatibility with all Bluetooth devices is not guaranteed.
- Any obstacle between this unit and a Bluetooth device can reduce the operational range.
- Keep this unit away from any other electronic device that may cause interference.

Connect a device for the first time



Tip

- This unit can memorize the connection information of up to 8 devices.

- 1 Press **BLUETOOTH** to select the Bluetooth source.
- 2 For an iPhone, load it in the dock for automatic re-connection setup.
- 3 Press and hold **PAIRING** for more than 3 seconds.
↳ The Bluetooth indicator blinks.
- 4 On the device, set up the Bluetooth connection:
 - ① **Enable Bluetooth to search for other Bluetooth devices.** (Refer to the device user manual on how to enable the function.)
 - ② **When " PHILIPS DC350" is recognized and displayed, select it to start to connect.**
 - ③ **When prompted for a password, enter "0000".**
- 5 Wait until the Bluetooth indicator turns on.
↳ The connection is complete.

To connect more Bluetooth devices

- 1 Disconnect the currently-connected device. (see 'Disconnect a device' on page 22)
- 2 Repeat the steps 1-5 in "Connect a device".



Tip

- If no connection is made within one minute, [FAILED] (failed) is displayed on the main unit.

Disconnect a device

- 1 Press and hold  for more than 5 seconds
 - To disconnect, you can also turn off the connected device or move it beyond the communication range.
 - The Bluetooth indicator turns off.

Re-connect a previously-connected device



Tip

- For a previously-connected iPhone which Bluetooth function is enabled, once it is docked in this unit, it re-connects automatically.





- 1 Turn on the main unit.
- 2 On the device, set up the Bluetooth connection:
 - ① **Enable Bluetooth to search for other Bluetooth devices.** (Refer to the device user manual on how to enable the function.)
 - ② **When “ PHILIPS DC350” is recognized and displayed, select it to start to connect.**
- 3 Wait until the Bluetooth indicator turns on.
↳ Re-connection is completed.

Receive a phone call



Note

- You can receive phone calls through this unit with devices that support the HFP or HSP profile.

- 1 Connect the Bluetooth device. (see ‘Connect with a Bluetooth device’ on page 21)
- 2 When a call is received, you hear the incoming call alert tone. Press **PAIRING**  to accept the call.
 - To reject the call, press .
- 3 Speak into the **MIC** located on the front panel.
 - To increase or decrease the volume, press **VOL +/-**.
 - To mute the microphone, press **MUTE**. To unmute, press this button again.
 - To select to hear the audio from the device or from the main unit, press **PAIRING** .
- 4 Press  to end the call.



Tip

- To be heard more clearly, speak closer to the microphone.
- If an echo is heard, reduce the volume of the main unit.
- If you observe communication difficulties, position the Bluetooth device closer to the main unit.

Listen to music



Note

- You can listen to audio through this unit from devices that support A2DP or AVRCP.
- As iPhone doesn't support Bluetooth audio streaming, this unit doesn't play audio files from iPhone through Bluetooth connection.

- 1 Connect the Bluetooth device. (see 'Connect with a Bluetooth device' on page 21)
- 2 On the Bluetooth device, start play.
 - ↳ You hear the music through the unit.
 - To pause/resume play, press **▶||**.
 - To skip to a track, press **◀◀▶▶**.

8 Other features

Set the alarm timer

You can set two alarms which go off at different time.

- 1 Ensure that you have set the clock correctly. (see 'Set clock and date' on page 16)
- 2 Press and hold **ALM 1** or **ALM 2** on the main unit for 2 seconds.
 - ↳ Hour digits blink.
 - ↳ [AL 1] (alarm 1) or [AL 2] (alarm 2) is displayed.
- 3 Press **◀◀▶▶** repeatedly to set the hour.
- 4 Press **ALM 1** or **ALM 2** to confirm.
- 5 Press **◀◀▶▶** repeatedly to set the minute.
- 6 Press **ALM 1** or **ALM 2** to confirm.
- 7 Press **VOL +/-** to set a volume level for alarm tone.
 - ↳ The volume level is applied to two alarms.
- 8 Press **ALM 1** or **ALM 2** to confirm.
 - To set the other alarm, repeat the steps 2 -8.



Note

- Only the latest volume setting for alarm tone works.



Tip

- To view alarm time, press **ALM 1** or **ALM 2** repeatedly until alarm time is displayed.

Set alarm mode

- 1 Adjust the **iPhone/iPod-RADIO-BUZZER** control on the main unit to select the source for the alarm.
 - ↳ When the alarm time comes, the selected Phone/iPod, or radio or buzzer turns on.



Tip



- If iPod/iPhone source is selected but no iPod/iPhone is loaded, the buzzer is selected automatically.

Activate and deactivate the alarm timer



Note

- An alarm can sound only in the standby mode.

- 1 Press repeatedly **ALM 1** or **ALM 2** on the main unit to activate or deactivate the timer.
 - ↳ If the timer is activated,  is displayed.
 - ↳ If the timer is deactivated,  disappears.

Turn off the alarm tone

During an alarm tone, you can select one of the following to turn it off.

- Press **POWER**.
 - ↳ The alarm timer remains activated.
- Press **REPEAT ALARM** on the main unit.
 - ↳ The alarm call repeats at 9-minute intervals.
- Press **ALM 1** or **ALM 2** on the main unit.
 - ↳ The alarm timer remains activated.

Set the sleep timer

This unit can switch to standby automatically after a set period of time.

- 1 When the unit is turned on, press **SLEEP** repeatedly to select a set period of time (in minutes).
 - ↳ When the sleep timer is activated, the display shows **zZ**.

To deactivate sleep timer

- 1 Press **SLEEP** repeatedly until [OFF] (off) is displayed.
 - ↳ When the sleep timer is deactivated, **zZ** disappears on the display.

Adjust display brightness

- 1 Press repeatedly **BRIGHTNESS CONTROL** on the main unit to select:
 - Bright.
 - Dim.
 - Off.

9 Product information



Note

- Product information is subject to change without prior notice.

Specifications

Amplifier

Rated Output Power	2X3W RMS
Frequency Response	125Hz - 16kHz, ± 3 dB
Signal to Noise Ratio	>55dB
Aux Input	0.6 V RMS 10kohm

Tuner

Tuning Range	FM: 87.5 - 108MHz
--------------	-------------------

Tuning grid	50KHz
-------------	-------

Sensitivity	
- Mono, 26dB S/N Ratio	<22 dBf
- Stereo, 46dB S/N Ratio	<40 dBf

Search Selectivity	>30 dBf
--------------------	---------

Total Harmonic Distortion	<3%
---------------------------	-----

Signal to Noise Ratio	>40 dB
-----------------------	--------

Speakers

Speaker Impedance	4ohm
-------------------	------

Speaker Driver	2 x 1" full range driver
----------------	--------------------------

Sensitivity	>80dB/m/W
-------------	-----------

Bluetooth

Communication system	Bluetooth Standard version 2.0
----------------------	--------------------------------

Output	Bluetooth Standard Power Class 2
--------	----------------------------------

Maximum communication range	Line of sight approx. 8m
-----------------------------	--------------------------

Frequency band	2.4 GHz band (2.4000 GHz - 2.4835 GHz)
----------------	--

Compatible Bluetooth profiles	Hands-Free Profile (HFP) Handset Profile (HSP) Advanced Audio Distribution Profile (A2DP) Audio Video Remote Control Profile (AVRCP)
-------------------------------	---

Supported codecs	
------------------	--

Receive	SBC (Sub Band Codec)
---------	----------------------

Transmit	SBC (Sub Band Codec)
----------	----------------------

General information

AC power (power adaptor)	Input: 100-240V~, 50-60Hz, 0.55A; Output: 12V $\overline{\text{---}}$ 2A; Brand name: Philips; Model No.: GFP241DA-1220-1
Operation Power Consumption	20W
Standby Power Consumption	<4W
Dimensions - Main Unit (W x H x D)	173 x 185 x 144mm
Weight - Main Unit	0.62 kg

10 Troubleshooting



Caution

- Never remove the casing of this apparatus.

To keep the warranty valid, never try to repair the system yourself. If you encounter problems when using this apparatus, check the following points before requesting service. If the problem remains unsolved, go to the Philips web site (www.philips.com/support). When you contact Philips, ensure that your apparatus is nearby and the model number and serial number are available.

No power

- Ensure that the AC power plug of the unit is connected properly.
- Ensure that there is power at the AC outlet.
- To save power, the unit switches to standby automatically 15 minutes after a play reaches the end and no control is operated.

No sound

- Adjust the volume.

No response from the unit

- Disconnect and reconnect the AC power plug, then turn on the unit again.

Remote control does not work

- Before pressing any function button, first select the correct source with the remote control instead of the main unit.
- Reduce the distance between the remote control and the unit.
- Insert the battery with its polarities (+/- signs) aligned as indicated.

- Replace the battery.
- Aim the remote control directly at the sensor on the front of the unit.

Poor radio reception

- Increase the distance between the unit and your TV or VCR.
- Fully extend the FM antenna.

Clock setting erased

- Power has been interrupted or the power cable has been disconnected.
- Reset the clock.

Sound input to the microphone cannot be heard clearly

- Speak closer to the microphone when talking, or talk louder.
- Reduce or remove background noise.
- Reduce the volume of the unit to remove an echo.

Audio quality is poor after connection with a Bluetooth device

- The Bluetooth reception is poor: Move the device closer to the unit, or remove any obstacle between the device and the unit.

A device cannot connect with the unit

- The device does not support Bluetooth communication, or any of the compatible profiles required for the unit.
- You have not enabled the Bluetooth function of the device. Refer to the user manual of the device on how to enable the function.
- The device is not correctly connected. Connect the device correctly. (see 'Connect with a Bluetooth device' on page 21)
- The unit is already connected with another Bluetooth device. Disconnect the connected device, then try again.

The connected mobile phone connects and disconnects constantly

- The Bluetooth reception is poor: Move the mobile phone closer to the unit, or remove any obstacle between the mobile phone and the unit.
- Some mobile phones may connect and disconnect constantly when you make or end calls. This does not indicate any malfunction of the unit.
- For some mobile phones, the Bluetooth connection can be deactivated automatically to save power. This does not indicate any malfunction of the unit.

Philips Consumer Lifestyle
A Division of Philips Electronics North America Corporation
P.O. BOX 671539, Marietta, GA. 30006-0026

Meet Philips at the Internet
<http://www.philips.com/welcome>



Printed in China

PDCC-JH/ZYL-0902

Free Manuals Download Website

<http://myh66.com>

<http://usermanuals.us>

<http://www.somanuals.com>

<http://www.4manuals.cc>

<http://www.manual-lib.com>

<http://www.404manual.com>

<http://www.luxmanual.com>

<http://aubethermostatmanual.com>

Golf course search by state

<http://golfingnear.com>

Email search by domain

<http://emailbydomain.com>

Auto manuals search

<http://auto.somanuals.com>

TV manuals search

<http://tv.somanuals.com>