

Docking Entertainment System

DC570

Register your product and get support at
www.philips.com/welcome



Thank you for choosing Philips.

Need help fast?

Read your Quick Start Guide and/or User Manual first for quick tips that make using your Philips product more enjoyable.

If you have read your instructions and still need assistance, you may access our online help at

www.philips.com/welcome
or call

1-888-PHILIPS (744-5477)

while with your product.
(and Model / Serial number)



Philips vous remercie de
votre confiance.

Besoin d'une aide rapide?

Le Guide rapide de début et Manuel de l'utilisateur regorgent d'astuces destinées à simplifier l'utilisation de votre produit Philips. Toutefois, si vous ne parvenez pas à résoudre votre problème, vous pouvez accéder à notre aide en ligne à l'adresse

www.philips.com/welcome
ou formez le

1-800-661-6162 (Francophone)

1-888-PHILIPS (744-5477) (English speaking)

**Veillez à avoir votre produit à
portée de main.**

(et model / serial nombre)



Gracias por escoger Philips

Necesita ayuda inmediata?

Lea primero la Guía rápida del comienzo o el Manual del usuario, en donde encontrará consejos que le ayudarán a disfrutar plenamente de su producto Philips.

Si después de leerlo aún necesita ayuda, consulte nuestro servicio de asistencia en línea en

www.philips.com/welcome
o llame al teléfono

1-888-PHILIPS (744-5477)

y tenga a mano el producto.
(y número de model / serial)



PHILIPS

Return your Product Registration Card or register online at
www.philips.com/welcome today to get the very most from your purchase.

Registering your model with PHILIPS makes you eligible for all of the valuable benefits listed below, so don't miss out. Complete and return your Product Registration Card at once, or register online at www.philips.com/welcome to ensure:

***Proof of Purchase**

Returning the enclosed card guarantees that your date of purchase will be on file, so no additional paperwork will be required from you to obtain warranty service.

***Product Safety Notification**

By registering your product, you'll receive notification - directly from the manufacturer - in the rare case of a product recall or safety defect.

***Additional Benefits**

Registering your product guarantees that you'll receive all of the privileges to which you're entitled, including special money-saving offers.

PHILIPS

Congratulations on your purchase, and welcome to the "family!"

Dear PHILIPS product owner:

Thank you for your confidence in PHILIPS. You've selected one of the best-built, best-backed products available today. We'll do everything in our power to keep you happy with your purchase for many years to come.

As a member of the PHILIPS "family," you're entitled to protection by one of the most comprehensive warranties and outstanding service networks in the industry. What's more, your purchase guarantees you'll receive all the information and special offers for which you qualify, plus easy access to accessories from our convenient home shopping network.

Most importantly, you can count on our uncompromising commitment to your total satisfaction.

All of this is our way of saying welcome - and thanks for investing in a PHILIPS product.

P.S. To get the most from your PHILIPS purchase, be sure to complete and return your Product Registration Card at once, or register online at:

www.philips.com/welcome

Know these
safety symbols



 This "bolt of lightning" indicates uninsulated material within your unit may cause an electrical shock. For the safety of everyone in your household, please do not remove product covering.

 The "exclamation point" calls attention to features for which you should read the enclosed literature closely to prevent operating and maintenance problems.

WARNING: To reduce the risk of fire or electric shock, this apparatus should not be exposed to rain or moisture and objects filled with liquids, such as vases, should not be placed on this apparatus.

CAUTION: To prevent electric shock, match wide blade of plug to wide slot, fully insert.

ATTENTION: Pour éviter les choc électriques, introduire la lame la plus large de la fiche dans la borne correspondante de la prise et pousser jusqu'au fond.

For Customer Use

Enter below the Serial No. which is located on the rear of the cabinet. Retain this information for future reference.

Model No. _____
Serial No. _____

PHILIPS

Visit our World Wide Web Site at <http://www.philips.com/welcome>

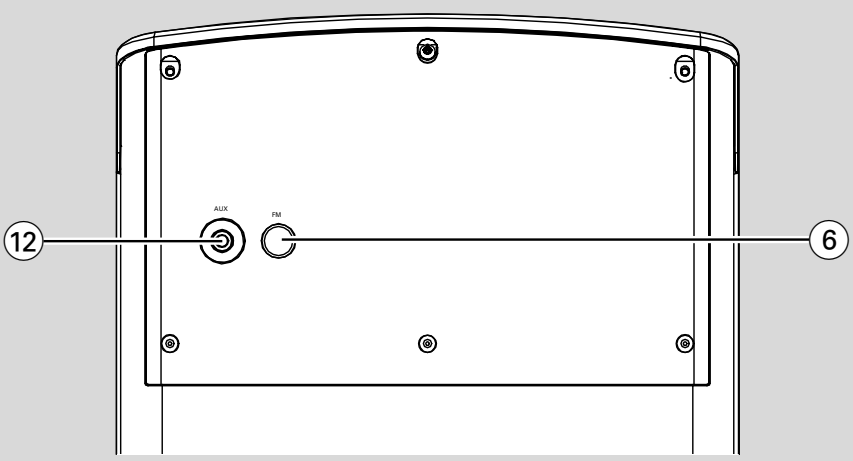
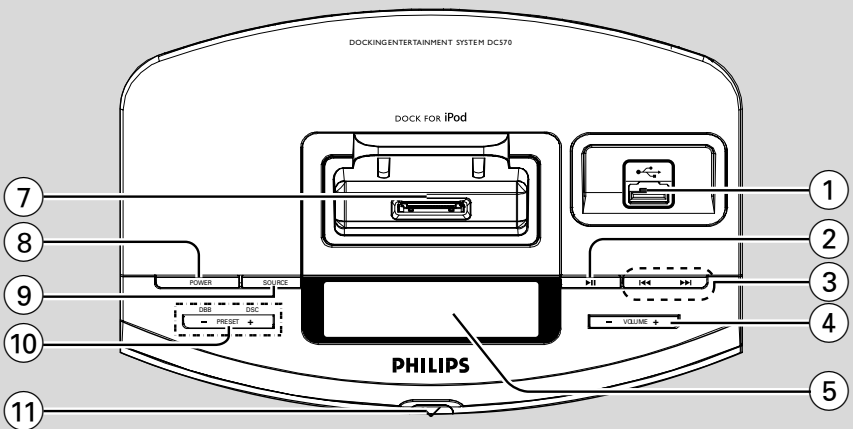

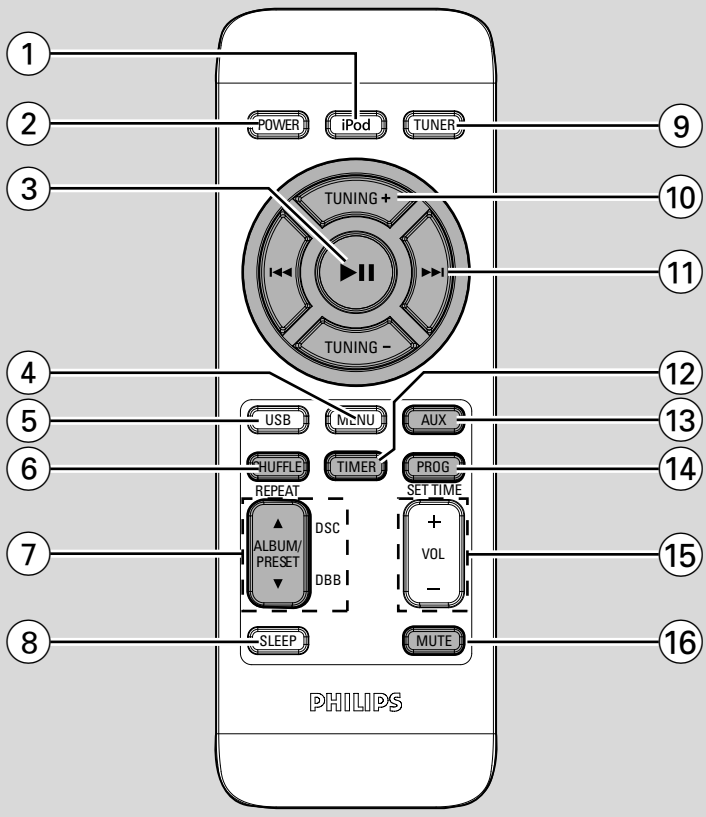

IMPORTANT SAFETY INSTRUCTIONS

1. **Read these instructions.**
2. **Keep these instructions.**
3. **Heed all warnings.**
4. **Follow all instructions.**
5. **Do not use this apparatus near water.**
6. **Clean only with dry cloth.**
7. **Do not block any ventilation openings. Install in accordance with the manufacturer's instructions.**
8. **Do not install near any heat sources**

such as radiators, heat registers, stoves, or other apparatus (including amplifiers) that produce heat.

9. **Do not defeat the safety**

purpose of the polarized or

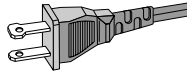

AC Polarized Plug

grounding-type plug. A polarized plug has two blades with one wider than the other. A grounding type plug has two blades and a third grounding prong. The wide blade or the third prong are provided for your safety. If the provided plug does not fit into your outlet, consult an electrician for replacement of the obsolete outlet.

10. **Protect the power cord** from being walked on or pinched, particularly at plugs, convenience receptacles, and the point where they exit from the apparatus.
11. **Only use attachments/accessories** specified by the manufacturer.

12.  **Use only with the cart**, stand, tripod, bracket, or table specified by the manufacturer or sold with the apparatus. When a cart is used, use caution when moving the cart /apparatus combination to avoid injury from tip-over.

13. **Unplug this apparatus** during lightning storms or when unused for long periods of time.
14. **Refer all servicing** to qualified service personnel. Servicing is required when the apparatus has been damaged in any way, such as power-supply cord or plug is damaged, liquid has been spilled or objects have fallen into the apparatus, the apparatus has been exposed to rain or moisture, does not operate normally, or has been dropped.
15. **Where the MAINS plug or an appliance coupler is used as the disconnect device, the disconnect device shall remain readily operable.**

16. **Battery usage CAUTION** – To prevent battery leakage which may result in bodily injury, property damage, or damage to the unit:

Install **all** batteries correctly, **+** and **-** as marked on the unit.

Do not mix batteries (**old** and **new** or **carbon** and **alkaline**, etc.).

Remove batteries when the unit is not used for a long time.

17. **Apparatus shall not be exposed to dripping or splashing.**
18. **Do not place any sources of danger on the apparatus** (e.g. liquid filled objects, lighted candles).
19. This product may contain lead and mercury. Disposal of these materials may be regulated due to environment considerations.
For disposal or recycling information, please contact your local authorities or the Electronic Industries Alliance: www.eiae.org.

EL 6475-S004: 03/12

Class II equipment symbol



This symbol indicates that the unit has a double insulation system

Note : This equipment has been tested and found to comply with the limits for a Class B digital device, pursuant to part 15 of the FCC Rules. These limits are designed to provide reasonable protection against harmful interference in a residential installation. This equipment generates, uses, and can radiate radio frequency energy and, if not installed and used in accordance with the instruction manual, may cause harmful interference to radio communications. However, there is no guarantee that interference will not occur in a particular installation. If this equipment does cause harmful interference to radio or television reception, which can be determined by turning the equipment off and on, the user is encouraged to try to correct the interference by one or more of the following measures :

- Relocate the receiving antenna.
- Increase the separation between the equipment and receiver
- Connect the equipment into an outlet on a circuit different from that to which the receiver is connected.
- Consult the dealer or an experienced radio/TV technician for help.

IMPORTANT !

modifications not authorized by the manufacturer may void users authority to operate this device.

Remarque : Cet équipement a été testé et a été certifié conforme aux limites imposées pour un appareil numérique de Classe B, conformément à la partie 15 des règlements FCC. Ces limites sont définies aux fins d'assurer une protection raisonnable contre les interférences nuisibles dans une installation résidentielle. Cet équipement génère, utilise et émet des fréquences radio qui, en cas d'une mauvaise installation ou d'une utilisation non-conforme aux instructions de ce manuel d'utilisation peuvent causer des interférences nuisibles aux communications radio. Il n'y a toutefois aucune garantie que des interférences nuisibles ne se produiront pas dans une installation donnée. Si cet équipement cause des interférences nuisibles avec votre poste radio ou de télévision, ce que vous pouvez déterminer en éteignant et en rallumant votre équipement, il est conseillé à l'utilisateur d'essayer de pallier à ces interférences nuisibles en prenant l'une ou l'autre des mesures suivantes:

- Changez la position de l'antenne de réception.
- Augmentez la séparation entre l'équipement et le récepteur.
- Branchez l'équipement sur une source d'alimentation différente de celle sur laquelle le récepteur est branché.
- Consultez votre distributeur ou un technicien qualifié en la matière pour assistance.

IMPORTANTE !

las modificaciones no autorizadas por el fabricante pueden anular la autoridad de los usuarios para utilizar este aparato.

Nota : Este aparato ha sido probado y cumple con los límites correspondientes a un aparato digital de Clase B, según la parte 15 de las Normas FCC. Estos límites han sido diseñados para facilitar suficiente protección frente a interferencias perjudiciales en una instalación residencial. Este aparato genera, utiliza y puede emitir energía de frecuencias de radio y, si no se instala y utiliza según el manual de instrucciones, puede provocar interferencias perjudiciales en las comunicaciones de radio. Sin embargo, no existe garantía de que las interferencias no ocurrirán en una instalación particular. Si este aparato provoca interferencias perjudiciales en la recepción de radio o televisión, que se puede identificar encendiendo y apagando el aparato, recomendamos al usuario que intente solucionar las interferencias siguiendo una o más de las siguientes medidas:

- Cambie la posición de la antena receptora.
- Aumente la separación entre el aparato y el receptor.
- Conecte el aparato a una toma de un circuito diferente al que está conectado el receptor.
- Consulte con el distribuidor o un técnico de radio/TV con experiencia para que le ayuden.

¡IMPORTANTE!

modificações não autorizadas pelo fabricante, podem causar danos na operação deste aparelho.

English	8
Français	25
Español	44

Canada

English:

This digital apparatus does not exceed the Class B limits for radio noise emissions from digital apparatus as set out in the Radio Interference Regulations of the Canadian Department of Communications.

Français:

Cet appareil numérique n'émet pas de bruits radioélectriques dépassant les limites applicables aux appareils numériques de Class B prescrites dans le Règlement sur le Brouillage Radioélectrique édicté par le Ministère des Communications du Canada.

CAUTION

Use of controls or adjustments or performance of procedures other than herein may result in hazardous radiation exposure or other unsafe operation.

ATTENTION

L'utilisation des commandes ou réglages ou le non-respect des procédures ci-incluses peuvent se traduire par une exposition dangereuse à l'irradiation.

ATENCIÓN

El uso de mando o ajustes o la ejecución de métodos que no sean los aquí descritos puede ocasionar peligro de exposición a radiación.

General Information

Environmental Information	9
Supplied accessories	9
Safety Information	9

Preparations

Rear connections	10
Connecting a USB device or memory card	11
Connecting other equipment to your system ...	11
Before using the remote control	11
Replacing the remote control battery	11

Controls

Main unit	12
Remote Control	13

Basic Functions

Switching the system on	14
Switching the system to Eco Power standby mode	14
Switching the system to standby mode	14
Power Saving Automatic Standby	14
Adjusting volume and sound	14
Sound control	15

USB playback functions

Different play modes: SHUFFLE and REPEAT	16
Programming track numbers	16
Reviewing programmed tracks	16
Changing programmed tracks	16
Erasing the program	16

Radio Reception

Tuning to radio stations	17
Programming radio stations	17
Automatic programming	17
Manual programming	17
Tuning to preset radio stations	17

External Sources

Using a non-USB device	18
Using a USB mass storage device	18

Clock/Timer/Sleep

Clock setting	20
Setting the Alarm Time	20
Stopping the alarm	20
Sleep timer setting	20

iPod Dock

Compatible iPod players	21
Selecting the correct dock adaptor	21
Using the dock adaptors	21
Playing an iPod portable player	21
Charging iPod battery using the dock	21

Specifications

Troubleshooting

Congratulations on your purchase and welcome to Philips!

To fully benefit from the support that Philips offers, register your product at www.philips.com/welcome.

Environmental Information

All unnecessary packaging has been omitted. We have tried to make the packaging easy to separate into three materials: cardboard (box), polystyrene foam (buffer) and polyethylene (bags, protective foam sheet).

Your system consists of materials which can be recycled and reused if disassembled by a specialized company. Please observe the local regulations regarding the disposal of packaging materials, exhausted batteries and old equipment.

Supplied accessories

- remote control (with battery)
- FM antenna
- 4 X iPod dock adaptors
- 3.5 mm line-in cable

Safety Information

- Before operating the system, check that the operating voltage indicated on the typeplate of your system is identical with the voltage of your local power supply. If not, please consult your dealer.
- Place the system on a flat, hard and stable surface.
- Place the system in a location with adequate ventilation to prevent internal heat build-up in your system. Allow at least 10 cm (4 inches) clearance from the rear and the top of the unit and 5 cm (2 inches) from each side.
- The ventilation should not be impeded by covering the ventilation openings with items, such as newspapers, table-cloths, curtains, etc.
- Do not expose the system, batteries or discs to excessive moisture, rain, sand or heat sources caused by heating equipment or direct sunlight.
- No naked flame sources, such as lighted candles, should be placed on the apparatus.

- No objects filled with liquids, such as vases, shall be placed on the apparatus.
- Install this unit near the AC outlet and where the AC power plug can be reached easily.
- The apparatus shall not be exposed to dripping or splashing.
- **When the system is switched to Standby mode, it is still consuming some power. To disconnect the system from the power supply completely, remove the AC power plug from the wall socket.**

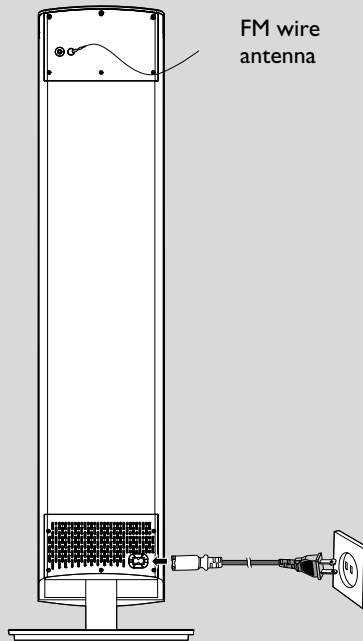

Rear connections

The type plate is located at the rear of the system.

(A) Power

- Before connecting the power cord to the wall outlet, ensure that all other connections have been made.

WARNING!

- **For optimal performance, use only the original power cord.**
- **Never make or change connections with the power switched on.**

To avoid overheating of the system, a safety circuit has been built in. Therefore, your system may switch to Standby mode automatically under extreme conditions. If this happens, let the system cool down before reusing it (not available for all versions).

(B) Antenna Connection

Connect the supplied FM antenna to the FM terminal. Extend and position the FM antenna for optimal reception.

Note:

- **Position the FM antenna away from the speaker wires to avoid electrical interference.**

(C) Optional connections

The optional equipment and connecting cords are not supplied. Refer to the operating instructions of the connected equipment for details.

Connecting a USB device

By connecting a USB mass storage device (including USB flash memory, USB flash players) to the system, you can enjoy the device's stored music through the powerful speakers of system.

Insert the USB device's USB plug into the  socket on the set.

OR

for devices with USB cables:

- 1 Insert one plug of the USB cable (not supplied) to the  socket on the set.
- 2 Insert the other plug of the USB cable to the USB port of the USB device.

Connecting other equipment to your system

Use a line-in-cable to connect AUX IN to the analogue audio out terminals of an external equipment (TV,VCR, Laser Disc player, DVD player or CD Recorder).

Before using the remote control

- 1 Pull out the plastic protective sheet.
- 2 Select the source you wish to control by pressing one of the source select keys on the remote control (for example USB,TUNER).
- 3 Then select the desired function (for example $\pm \approx$).

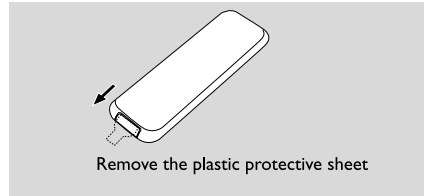

Replacing the remote control battery (lithium CR2025)

- 1 Press the slot on the battery compartment.
- 2 Pull out the battery compartment.
- 3 Replace a new battery and fully insert the battery compartment back to the original position.

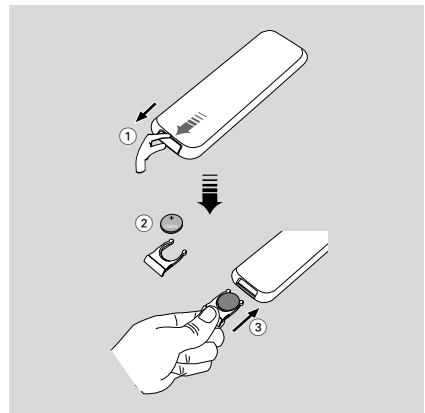

CAUTION!

- Remove battery if it is exhausted or will not be used for a long time.
- Batteries contain chemical substances, so they should be disposed of properly.
- Perchlorate Material-special handling may apply. See www.dtsc.ca.gov/hazardouswaste/perchlorate.

Main unit

① **USB DIRECT**

- jack for the connecting an external USB mass storage device and MP3/ WMA players.

② **▶ II**

- (iPod/USB) starts or interrupts playback.

③ **◀◀▶▶**

- iPod/ USB fast searches back and forward within a track (press and hold).
..... skips to the beginning of a current/previous/next track.
- CLOCK adjusts the minutes for the clock/ alarm function.
- TUNER tunes to lower/ higher FM frequency.

④ **VOLUME -/+**

- adjusts the volume level.

⑤ **Display screen**

- shows the status of the system.

⑥ **FM antenna**

- improves FM reception

⑦ **DOCK for iPod**

- cradle for docking adaptors used to dock your iPod player for playback or recharging through this system.

⑧ **Power**

- switches on the system to the last sound source played.
- switches the system to standby mode.

⑨ **Source**

- to select the respective sound source: USB, iPod, FM, or AUX.

⑩ **PRESET -/+**

- (USB) skips to the beginning of a previous/ subsequent album.
- adjusts the hours for the clock/alarm function.
- selects a preset radio station.

DBB

- enhances the bass

DSC

- selects different sound effects

⑪ **IR**

- remote sensor

⑫ **AUX**

- connect an auxiliary device here.

Remote Control

- ① **iPod**
 - selects the sound source for your iPod player.
- ② **Power**
 - switches the system to standby mode.
- ③ **▶ II**
 - (iPod/USB) starts or interrupts playback.
- ④ **Menu**
 - enters iPod menu
- ⑤ **USB**
 - selects sound source for a USB audio player.
- ⑥ **REPEAT/SHUFF**
 - (USB) toggles track/album playback options e.g. repeat or random order mode.
- ⑦ **ALBUM/PRESET▲ / ▼**
 - (USB) skips to the beginning of a previous/ subsequent album.
 - selects a preset radio station.
- DBB**
 - enhances the bass
- DSC**
 - selects different sound effects
- ⑧ **SLEEP**
 - selects the sleeper time.
- ⑨ **TUNER**
 - selects the sound source for FM radio.
- ⑩ **TUNING -/+**
 - TUNERtunes to lower/ higher FM frequency.
 - CLOCKadjusts the hour for the clock/ alarm function.
- ⑪ **◀◀ / ▶▶**
 - iPod/USB.....fast searches back and forward within a track (press and hold).
 - skips to the beginning of a current/previous/next track.
 - CLOCKadjusts the minute for the clock/ alarm function.

- ⑫ **Timer**
 - activates/deactivates alarm setting mode
 - turns alarm on/off
- ⑬ **AUX**
 - selects sound source for other audio equipment.
- ⑭ **PROG/SET TIME**
 - (TUNER) programs radio stations.
 - sets the clock function.
 - (USB) programs tracks.
- ⑮ **VOLUME -/+**
 - adjusts the volume level.
- ⑯ **MUTE**
 - interrupts and resumes sound production.

Notes for remote control:

- **First select the source you wish to control by pressing one of the source select keys on the remote control (for example USB/AUX).**
- **Then select the desired function (for example ▶ II, ◀◀, ▶▶).**

Basic Functions

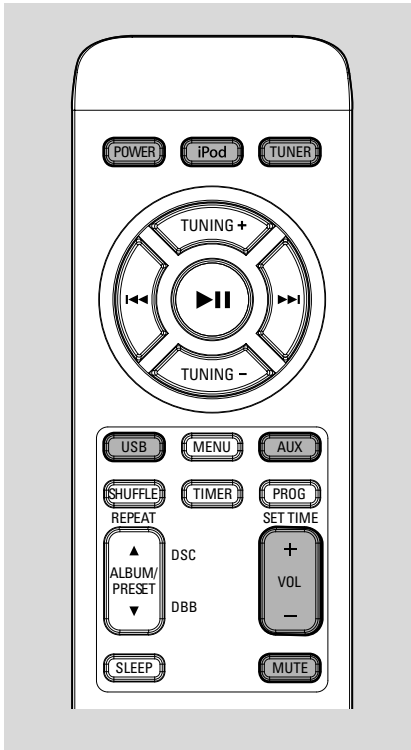

Important!
Before you operate the system, complete the preparation procedures.

Switching the system on

- Press **Power** on the set.
→ The system will switch to the last selected source.
- Press source on the set repeatedly or **USB**, **AUX**, **iPod** or **TUNER** on the remote control.
→ The system will switch to the selected source.

Switching the system to Eco Power Standby mode

- Press and hold **POWER** (or **POWER** on the remote) in the active mode.
→ The system enters Eco power standby mode.
- If the system is normal standby mode, press and hold **POWER** on the front panel for 3 seconds or more to switch to Eco power standby or vice versa.

Switching the system to Standby mode

- Press **Power** (or **Power** on the remote control).
→ The volume level (up to a maximum volume of 12), last selected mode, source and tuner presets will be retained in the system's memory.

Power Saving Automatic Standby

As a power-saving feature, the system automatically switches to standby 15 minutes after a USB connected device has reached the end of the last track and no control is operated.

Adjusting volume and sound

- 1 Press **VOLUME +/-** to decrease or increase the volume.
→ Display shows the volume level VoL and a number 0-32.
 - 2 Press **MUTE** on the remote control to interrupt sound reproduction instantly.
→ Playback will continue without sound and **MUTE** appears.
- To activate sound reproduction you can:
 - press **MUTE** again;
 - adjust the volume controls;
 - change source.

Sound Control

DBB and DSC sound features cannot be activated at the same time.

DBB (Dynamic Bass Boost)

DBB enhances the bass response.

iPod/AUX

- Press **ALBUM/PRESET ▼** on the remote or **PRESET -** on the pane to enable/disable DBB feature.

USB/TUNER

- Press and hold **ALBUM/PRESET ▼** on the remote or **PRESET -** on the panel for more than 2 seconds to enable/disable DBB feature.

DSC (Digital Sound Control)

DSC provides a different type of preset sound equalizer setting.

iPod/AUX

- 1 Press **ALBUM/PRESET ▲** or **PRESET +** on the panel to enter DSC mode.
- 2 Press **PRESET +** repeatedly to select: CLASSIC, JAZZ, POP or ROCK.

USB/TUNER

- 1 Press and hold **ALBUM/PRESET ▲** or **PRESET +** on the panel for more than 2 seconds to enter DSC mode.
- 2 Press **PRESET +** repeatedly to select: CLASSIC, JAZZ, POP or ROCK.

USB playback functions

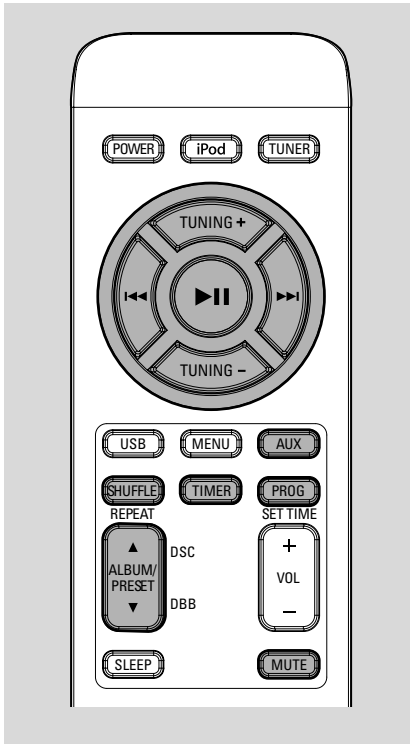

Different play modes: SHUFFLE and REPEAT

You can select and change the various play modes before or during playback. The REPEAT modes can also be combined with PROGRAM.

- 1 To select your play mode, press **REPEAT/SHUFF** before or during playback until the display shows the desired function.
→ If **onE** appears the current track will play repeatedly.
→ If **ALB** appears the current album will play repeatedly.
→ If **ALL** appears all tracks will be played repeatedly.
→ **SHUFF** appears if shuffle playback is activated and disappears if deactivated.
- 2 To return to normal playback, press the **REPEAT/SHUFF** until **oFF** displayed.

Note:

– The Repeat and Shuffle functions cannot be combined.

Programming track numbers

Program in the STOP position to select and store up to 20 tracks in the memory.

- 1 Press **PROG/SET TIME** on the remote control to enter the programming mode.
→ **Pr 01** appears and **PROG** flashes.
- 2 Press **◀◀▶▶** to select your desired track number:
 - For tracks in a different album, press **ALBUM/PRESET ▲/▼** to select a desired album number.
- 3 Press **PROG/SET TIME** to confirm the track number to be stored.
- 4 Repeat steps 2-3 to select and store all desired tracks.
→ **F L L L** appears if you attempt to program more than 20 tracks.
- 5 To start playback of your program, press **▶ II**.

Reviewing programmed tracks

You can review or change the programmed tracks.

- 1 Press **PROG/SET TIME** repeatedly to review each programmed track.

Changing programmed tracks

- 1 Press **PROG/SET TIME** repeatedly to your desired programmed track.
- 2 Press **◀◀▶▶** to select your desired track number:
 - For tracks in a different album, press **ALBUM/PRESET ▲/▼** to select a desired album number.
- 3 Press **PROG/SET TIME** to confirm the track number to be stored.

Erasing programmed tracks

- 1 To erase your program, press and hold **PROG/SET TIME** for more than 2 seconds.
→ **L L R** appears.

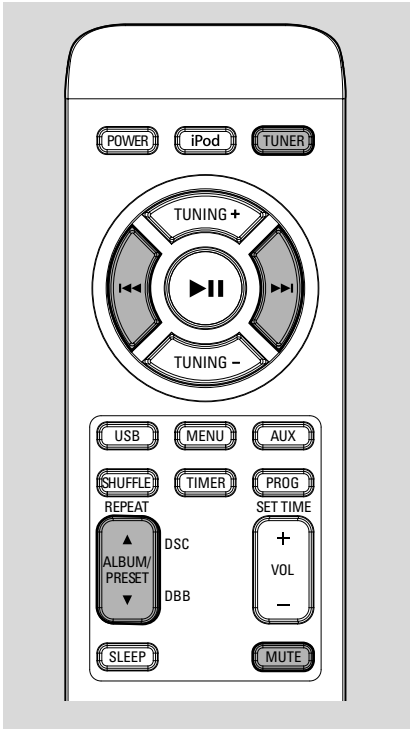

Tuning to radio stations

- 1 Press **TUNER** to select the tuner source.
- 2 Hold **TUNING +/-** (or **◀▶**) on the set) and then release the button.
→ The system will start searching for a radio station with sufficient signal strength.
- 3 Repeat step 2 if necessary until you find the desired station.
- To tune to a weak station, press **TUNING +/-** (or **◀▶**) on the set) briefly and repeatedly.

Programming radio stations

You can store up to a total of 20 radio stations in the memory.

Automatic programming

Automatic programming will start at preset number 1 and all your former presets will be overridden.

- Press **PROG/SET TIME** for more than 3 seconds to activate programming.
→ All available stations are programmed.

Manual programming

- 1 Tune to your desired station (refer to "Tuning to radio stations").
- 2 Press **PROG/SET TIME** to activate programming.
→ **PROG** flashes in the display.
- 3 Press **ALBUM/PRESET ▲ / ▼** to allocate a number from 1 to 20 to this station.
- 4 Press **PROG/SET TIME** again to confirm the setting.
→ **PROG** disappears, the preset number and the frequency of the preset station are shown.
- 5 Repeat the above four steps to store other stations.
- You can override a preset station by storing another frequency in its place.

Tuning to preset radio stations

- Press **ALBUM/PRESET ▲ / ▼** until the desired preset station is displayed.

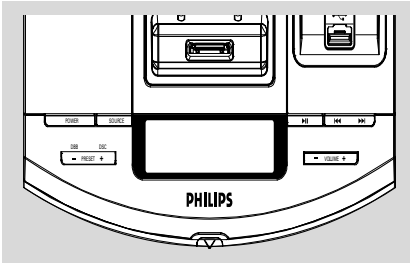

Using a non-USB device

- 1 Connect the audio out terminals of the external equipment (TV,VCR, Laser Disc player; DVD player or CD Recorder) to the AUX socket of your system.
- 2 Press **AUX** to select external equipment.

Note:

ñ Refer to the operating instructions of your connected equipment for details.

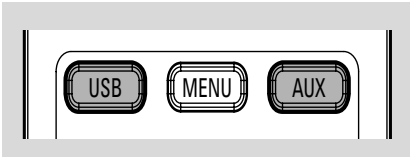

Using a USB mass storage device

By connecting a USB mass storage device to the system, you can enjoy the device's stored music through the system's powerful speakers.

- 1 Check the USB device has been properly connected. (See Installation: Connecting an additional appliance).
- 2 Press **USB** once or more to select USB.
 - **no AUDIO** appears if no audio file is found in the USB device.
- 3 Refer to the Quick Start Guide or the Controls page of this manual for basic playback features.

Playing a USB mass storage device

Compatible USB mass storage devices

You can use:

- USB flash memory (USB 2.0 or USB1.1)
- USB flash players (USB 2.0 or USB1.1)

INFORMATION REGARDING USB DIRECT:

1. Compatibility of the USB connection on this system:

- a) This product supports most USB Mass storage devices (MSD) that are compliant to the USB MSD standards.
 - i) Most common Mass storage class devices are flash drives, memory sticks, jump drives and etc.
 - ii) If you see a "Disc Drive" showing up on your computer after you have plugged the mass storage device into your computer, most likely it is MSD compliant and it will work with this system.
- b) If your Mass storage device requires a battery/ power source please make sure you have a fresh battery inserted or charge the USB device before connecting to the system.

2. Supported Music type:

- a) This device only supports unprotected music with the following file extension:
 - .mp3
 - .wma
 - b) Music bought from on-line music stores are not supported because they are secured by Digital Rights Management protection (DRM).
 - c) File name extensions that end with the following are not supported:
 - .wav; .m4a; .m4p; .mp4; .aac and etc.
3. Playback of audio files through the system's speakers is not possible if you connect directly from your computer to the USB socket.

Supported formats:

- USB or memory file format FAT12, FAT16, FAT32 (sector size: 512-4096 bytes)
- MP3 bit rate (data rate): 32-320 Kbps and variable bit rate
- WMA v9 or earlier
- Directory nesting up to a maximum of 8 levels
- Number of albums/ folders: maximum 99
- Number of tracks/titles: maximum 999
- ID3 tag v2.0 or later
- File name in Unicode UTF8 (maximum length: 128 bytes)

The system will not play or support the following:

- Empty albums: an empty album is an album that does not contain MP3/WMA files, and will not be shown in the display.
- Non-supported file formats are skipped. This means that e.g.: Word documents .doc or MP3 files with extension .dlf are ignored and will not be played.
- AAC, WAV, PCM audio files
- DRM protected WMA files
- WMA files in Lossless format.

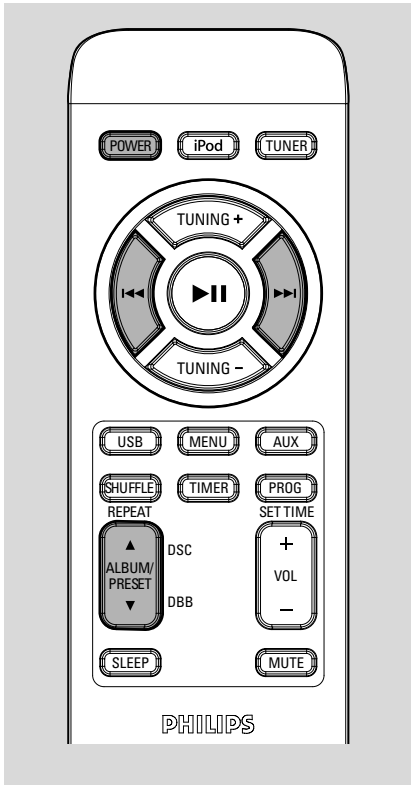

- 1 Press **TIMER** for more than 3 seconds to enter the alarm setting mode.
 - 📌 appears.
 - The alarm clock digits flash.
 - "Err" appears briefly if you have not set the clock time.
- 2 Press **TUNING +/-** to set the hours.
- 3 Press **◀▶▶▶** to set the minutes.
- 4 Press **iPod, TUNER** or **USB** to select the sound source.
- 5 Press **TIMER** to confirm your alarm setting.
 - The display returns to the clock time.

Notes:

The **TUNER** mode is the default source if:

- Your **USB** device contains no **MP3** or **WMA** files.
- You forgot to connect a **USB** device.
- You forgot to dock your **iPod**.

Stopping the alarm

- To cancel the alarm, press **TIMER** in standby or playback mode.
 - 📌 appears if activated, and disappears if deactivated.

Sleep timer setting

The sleep timer enables the system to switch off by itself after a set period of time.

- 1 Press **SLEEP** on the remote control repeatedly to select a preset time.
 - The selections are as follows (time in minutes):
120 → 90 → 60 → 30 → 15 → OFF...
 - **SLEEP** is displayed.
- 2 To review the remaining sleep time, press **SLEEP**.

Note:

- If you press **SLEEP** again, this will change your sleep time period to the next shorter preset option.

To deactivate the sleep timer

- Press **SLEEP** repeatedly until "OFF" is displayed, or press **Power**.

Clock setting

The clock uses the 12-hour mode.

Important!

- To set clock in the Eco Power mode, press and hold **POWER** on the set for 3 seconds or more to switch to normal standby mode first before proceeding with the procedures below.

- 1 In standby mode, press **PROG/SET TIME** for more than two seconds.
 - The clock digits flash.
- 2 Press **◀▶▶▶** to set the minutes.
- 3 Press **TUNING +/-** to set the hours.
- 4 Press **PROG/SET TIME** to confirm the time.

Setting the timer

You can only set timer in standby mode.

Wake up to FM radio or music from your **USB** device or **iPod**. The clock time needs to be set first before the alarm clock can be used.

Compatible iPod players

- The docking entertainment system is compatible with all the existing Apple iPod models with 30-pin connector:

Selecting the correct dock adaptor

- Four adapters are included to fit different iPod models including iPod touch (8GB, 16GB), iPod classic (80GB, 160GB), iPod nano 3rd generation (4GB, 8GB), iPod the 5th generation (30GB, 60GB, 80GB), iPod nano 2nd generation (2GB, 4GB, 8GB) and iPod nano 1st generation (1GB, 2GB, 4GB).

Using the dock adaptors

- Before plugging your player in the dock, snap the suitable dock adapter into the dock to provide a snug fit for the player to be docked

Playing an iPod portable player

- 1 Correctly dock your iPod portable player in the cradle. Make sure the dock adaptor is compatible.
- Make sure that you have powered on your iPod player before selecting iPod source.
- 2 Press **iPod** on the remote control to select iPod source.
→ The iPod dock icon  appears.
- 3 Playback starts automatically. Playback functions play, skip, fast search and, pause are possible using the controls on this system and its remote control.

Charging iPod battery using the dock

- In iPod mode, directly dock your iPod portable player on the cradle for charging.

Note:

–For the purpose of saving power, recharging of your USB device and iPod is Not Supported when the main set is in Eco Power mode.

Specifications

AMPLIFIER

Output power
..... 50W+2 x 25W
Signal-to-noise ratio ≥ 70 dBA
Frequency response 50 Hz – 20 KHz, ± 3 dB
Input sensitivity AUX 0.5 V (max. 2 V)

SUBWOOFER

Frequency response 50 Hz – 1KHz
Impedance 8 Ω
Rated power 50W

TWEETER

Frequency response 160 Hz – 16 KHz
Impedance 4 Ω
Rated power 2 x 25W

TUNER

FM wave range 87.5 – 108 MHz
Sensitivity at 75 Ω

– FM 20dBf
Total harmonic distortion $\leq 1\%$
Frequency response
– FM 63 – 6000 Hz
Signal-to-noise-ratio
– FM ≥ 50 dBA

USB PLAYER

USB 12Mb/s, V1.1
..... support MP3 and WMA files
Number of albums/folders maximum 99
Number of tracks/titles maximum 999

GENERAL INFORMATION

AC Power 120 V / 60 Hz
Dimensions (w x h x d) 300 x 300 x 1024 (mm)
Weight 10.1 kg
Standby power consumption <7 W

Specifications are subject to change without notice.

WARNING

Under no circumstances should you try to repair the system yourself, as this will invalidate the warranty. Do not open the system as there is a risk of electric shock.

If a fault occurs, first check the points listed below before taking the system for repair. If you are unable to remedy a problem by following these hints, consult your dealer or Philips for help.

Problem	Solution
“NO USB” is displayed.	<ul style="list-style-type: none"> ✓ Insert a a USB device.
Radio reception is poor.	<ul style="list-style-type: none"> ✓ If the signal is too weak, adjust the antenna or connect an external antenna for better reception. ✓ Increase the distance between the unit and your TV or VCR. ✓ Position the FM antenna away from the speaker wires to avoid electrical interference.
The system does not react when buttons are pressed.	<ul style="list-style-type: none"> ✓ Remove and reconnect the AC power plug and switch on the system again.
Sound cannot be heard or is of poor quality.	<ul style="list-style-type: none"> ✓ Adjust the volume. ✓ Disconnect the headphone.
The remote control does not function properly.	<ul style="list-style-type: none"> ✓ Select the source (e.g.TUNER) before pressing the function button (▲/▼, ◀◀▶▶▶). ✓ Reduce the distance between the remote control and the system. ✓ Insert the battery with its polarities (+/- signs) aligned as indicated. ✓ Replace the battery. ✓ Point the remote control directly toward IR sensor on the front of the system.
The alarm function is not working.	<ul style="list-style-type: none"> ✓ Set the clock time correctly. ✓ Switch on the alarm.
The Clock setting is erased.	<ul style="list-style-type: none"> ✓ Power has been interrupted or the power cord has been disconnected. Reset the clock.

PHILIPS LIMITED WARRANTY ONE (1) YEAR

WARRANTY COVERAGE:

PHILIPS warranty obligation is limited to the terms set forth below.

WHO IS COVERED:

PHILIPS warrants the product to the original purchaser or the person receiving the product as a gift against defects in materials and workmanship as based on the date of original purchase ("Warranty Period") from an Authorized Dealer. The original sales receipt showing the product name and the purchase date from an authorized retailer is considered such proof.

WHAT IS COVERED:

The Philips warranty covers new products if a defect in material or workmanship occurs and a valid claim is received by Philips within the Warranty Period. At its option, Philips will either (1) repair the product at no charge, using new or refurbished replacement parts, or (2) exchange the product with a product that is new or which has been manufactured from new, or serviceable used parts and is at least functionally equivalent or most comparable to the original product in Philips current inventory, or (3) refund the original purchase price of the product. Philips warrants replacement products or parts provided under this warranty against defects in materials and workmanship from the date of the replacement or repair for ninety (90) days or for the remaining portion of the original product's warranty, whichever provides longer coverage for you. When a product or part is exchanged, any replacement item becomes your property and the replaced item becomes Philips' property. When a refund is given, your product becomes Philips' property.

Note: Any product sold and identified as refurbished or renewed carries a ninety (90) day limited warranty.

Replacement product can only be sent if all warranty requirements are met. Failure to follow all requirements can result in delay.

WHAT IS NOT COVERED - EXCLUSIONS AND LIMITATIONS:

This Limited Warranty applies only to the new products manufactured by or for Philips that can be identified by the trademark, trade name, or logo affixed to it. This Limited Warranty does not apply to any non-Philips hardware product or any software, even if packaged or sold with the product. Non-Philips manufacturers, suppliers, or publishers may provide a separate warranty for their own products packaged with the bundled product.

Philips is not liable for any damage to or loss of any programs, data, or other information stored on any media contained within the product, or any non-Philips product or part not covered by this warranty. Recovery or reinstallation of programs, data or other information is not covered under this Limited Warranty.

This warranty does not apply (a) to damage caused by accident, abuse, misuse, neglect, misapplication, or non-Philips product, (b) to damage caused by service performed by anyone other than Philips or Philips Authorized Service Location, (c) to a product or a part that has been modified without the written permission of

Philips, or (d) if any Philips serial number has been removed or defaced, or (e) product, accessories or consumables sold "AS IS" without warranty of any kind by including refurbished Philips product sold "AS IS" by some retailers.

This Limited Warranty does not cover:

- Shipping charges to return defective product to Philips.
- Labor charges for installation or setup of the product, adjustment of customer controls on the product, and installation or repair of antenna/signal source systems outside of the product.
- Product repair and/or part replacement because of improper installation or maintenance, connections to improper voltage supply, power line surge, lightning damage, retained images or screen markings resulting from viewing fixed stationary content for extended periods, product cosmetic appearance items due to normal wear and tear, unauthorized repair or other cause not within the control of Philips.
- Damage or claims for products not being available for use, or for lost data or lost software.
- Damage from mishandled shipments or transit accidents when returning product to Philips.
- A product that requires modification or adaptation to enable it to operate in any country other than the country for which it was designed, manufactured, approved and/or authorized, or repair of products damaged by these modifications.
- A product used for commercial or institutional purposes (including but not limited to rental purposes).
- Product lost in shipment and no signature verification receipt can be provided.
- Failure to operate per Owner's Manual.

TO OBTAIN ASSISTANCE IN THE U.S.A., PUERTO RICO, OR U.S. VIRGIN ISLANDS...

Contact Philips Customer Care Center at:
1-888-PHILIPS (1-888-744-5477)

TO OBTAIN ASSISTANCE IN CANADA...

1-800-661-6162 (French Speaking)
1-888-PHILIPS (1-888-744-5477) - (English or Spanish Speaking)

REPAIR OR REPLACEMENT AS PROVIDED UNDER THIS WARRANTY IS THE EXCLUSIVE REMEDY FOR THE CONSUMER. PHILIPS SHALL NOT BE LIABLE FOR ANY INCIDENTAL OR CONSEQUENTIAL DAMAGES FOR BREACH OF ANY EXPRESS OR IMPLIED WARRANTY ON THIS PRODUCT, EXCEPT TO THE EXTENT PROHIBITED BY APPLICABLE LAW, ANY IMPLIED WARRANTY OF MERCHANTABILITY OR FITNESS FOR A PARTICULAR PURPOSE ON THIS PRODUCT IS LIMITED IN DURATION TO THE DURATION OF THIS WARRANTY.

Some states do not allow the exclusions or limitation of incidental or consequential damages, or allow limitations on how long an implied warranty lasts, so the above limitations or exclusions may not apply to you.

This warranty gives you specific legal rights. You may have other rights which vary from state/province to state/province.

Philips, P.O. Box 671539, Marietta, GA. 30006-0026

3121 233 48802

Free Manuals Download Website

<http://myh66.com>

<http://usermanuals.us>

<http://www.somanuals.com>

<http://www.4manuals.cc>

<http://www.manual-lib.com>

<http://www.404manual.com>

<http://www.luxmanual.com>

<http://aubethermostatmanual.com>

Golf course search by state

<http://golfingnear.com>

Email search by domain

<http://emailbydomain.com>

Auto manuals search

<http://auto.somanuals.com>

TV manuals search

<http://tv.somanuals.com>