

Clock Radio

AJ210

User manual



PHILIPS

1

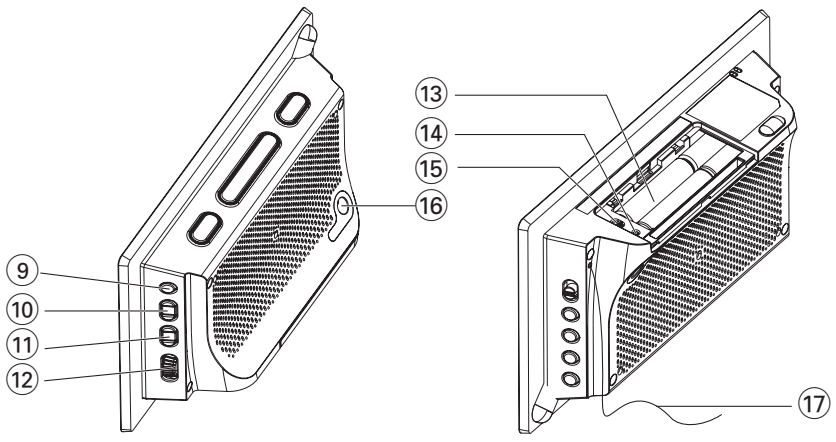
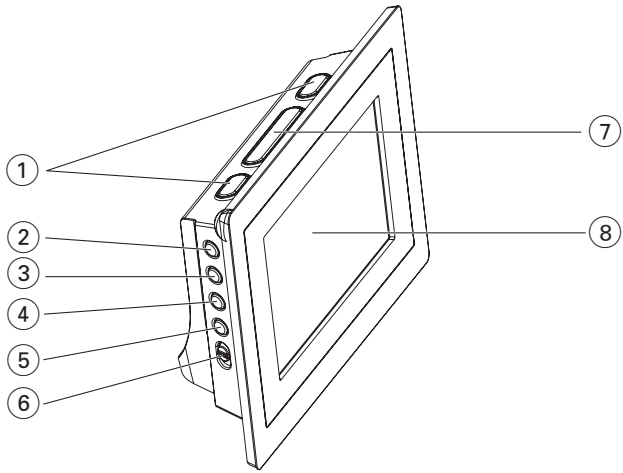

2

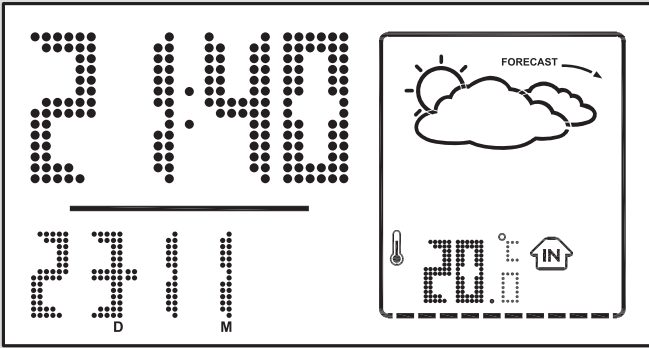

3

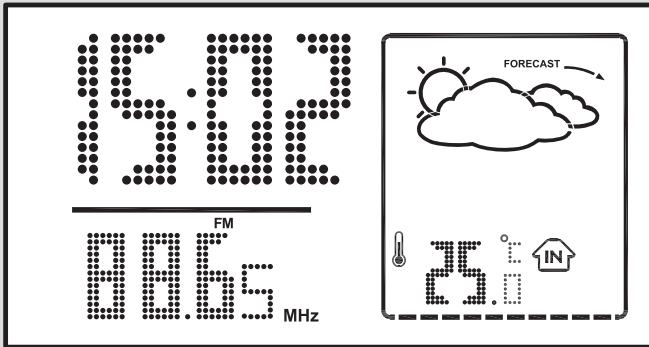

4

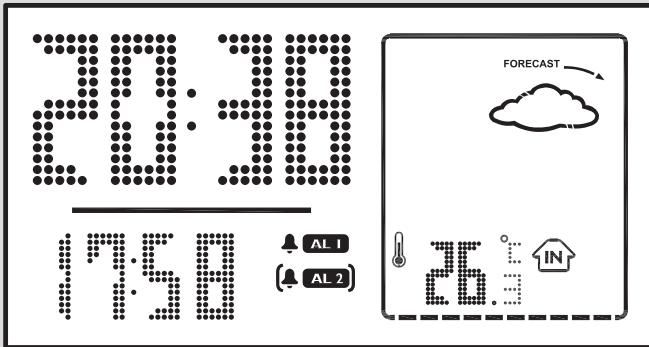

Supplied accessory

- 1 X certified AC 7.5V adapter
(Input: 220-230V ~50Hz 30mA,
Output: 7.5V===250mA)

Controls (see [1])

- ① **ALM 1/ALM 2**
 - activates/confirm ALARM 1 /ALARM 2 time setting
 - switches off the alarm
- ② **RADIO ON/OFF**
 - switches the radio on/off
 - switches the set on or to standby
 - stops the active buzzer or radio alarm for 24 hours
 - switches off the sleep timer
- ③ **TIME SET**
 - activates/confirm clock/date setting
- ④ **AUTO SCAN**
 - programs preset radio stations
- ⑤ **DATE**
 - displays month and day information in standby mode
 - changes display order between month and day during setting time
- ⑥ **RADIO•BUZ**
 - selects alarm mode: radio or buzzer
- ⑦ **REPEAT ALARM/BRIGHTNESS CONTROL**
 - pushes to switch off alarm for a 9-minute period
 - changes the brightness of the display illumination
- ⑧ **LCD Display** – shows the clock/ alarm time or radio and weather forecast information
- ⑨ **SLEEP/ALARM RESET**
 - switches off radio for timer mode
 - adjusts timer options for radio playback
 - stops the active buzzer or radio alarm for 24 hours
- ⑩ **PRESET +/-**
 - selects a preset radion station
- ⑪ **TUNING +/-**
 - tunes to radio stations
 - adjusts clock / alarm time

- ⑫ **VOL**– adjusts sound level
- ⑬ **Battery compartment** – opens to insert 4 x 1.5V **AAA** batteries
- ⑭ **RESET**
 - press if the set / display does not react to operation of any button
- ⑮ **(°C °F) Slide Switch**
 - selects between Centigrade (°C) or Fahrenheit (°F) temperature unit display
- ⑯ **DC 7.5V**
 - socket for AC/DC 7.5V adapter
- ⑰ **Pigtail** – FM antenna to improve FM reception

Power supply

Make sure you remove the plug from the set and wall outlet before inserting batteries.

Batteries (not supplied)

- 1 Open the battery door and insert 4 batteries, typed **AAA** with the correct polarity as indicated by the "+" and "-" symbols inside the compartment.
- 2 Replace the battery door, making sure the batteries are firmly and correctly in place. The set is now ready to operate.

Batteries contain chemical substances, so they should be disposed of properly.

Mains Adapter.

Note: Remove the batteries before you use the AC adapter.

- 1 Connect the mains adapter to the set's DC 7.5V socket and to the power socket.

Helpful hints:

To avoid damage to the set, use only the adapter supplied!

The type plate is located on the bottom of the set.

This set complies with the radio interference requirements of the European Community.

Setting the clock and date (see [2])

The clock uses 24-hour time format.

- 1 Press and hold **TIME SET** for 2 seconds.
→ The digits for year flash.
- 2 Hold down or press **TUNING +/-** repeatedly to adjust the time digits.
 - When it comes to adjust month and day, you may press **DATE** to change the display order between month and day.
- 3 Press **TIME SET** to confirm the setting.
→ The digits for month flashes.
- 4 Repeat **steps 2-3** to complete all the other settings for month, day, hour and minute.

Standby power consumption

(clock mode).....1.5W

Digital tuner

Tuning to radio station

- 1 Press **RADIO ON/OFF** to switch on the radio (FM only).
→ The radio station frequency and the wave-band will be displayed. (See [3]).
 - 2 Press and hold **TUNING +/-** until the frequency in the display starts running.
→ The radio automatically tunes to a station of sufficient reception.
 - 3 Repeat step 2 if necessary until you find the desired station.
- To tune to a weak station, press **TUNING +/-** briefly and repeatedly until you have found optimal reception.

To improve reception:

FM: Extend and adjust the pigtail for optimum reception.

Programming radio stations

You can store up to a total of 10 radio stations in the memory (10 FM), manually or automatically (Auto store).

Manual programming

- 1 Tune to your desired station (see **Tuning to radio stations**).
- 2 Press and hold **PRESET +/-** to activate programming.
→ Display: **PRESET** flashes.
- 3 Press **PRESET +/-** once or more to allocate a number from 1 to 10.
- 4 Repeat steps 1-3 to store other stations.

Helpful hints:

- You can erase a preset station by storing another frequency in its place.

Autostore

Autostore automatically starts programming radio stations from preset 1. Any previous presets e.g. manually programmed will be erased.

- 1 In radio mode, press **AUTO SCAN** until the frequency in the display starts running.
→ Available stations are programmed (FM). After all stations are stored, the first autostore preset station will then automatically play.

To listen to a preset or autostore station

Press the **PRESET +/-** buttons once or more until the desired preset station is displayed.

Using the alarm

AJ210 allows you to simultaneously set two different alarms (ALARM 1 and ALARM 2) which can go off in the radio or buzzer mode. The clock time needs to be set correctly before using alarm.

Setting alarm time

- 1 Press briefly **ALM 1** or **ALM 2** to display AL1 or AL2 icon.
- 2 Press and hold **ALM 1/ ALM 2** for two seconds.
→ The hour digits flash.
- 3 Hold down or press **TUNING +/-** repeatedly to adjust the hours.

Alarm



Sleep

- Press **ALM 1/ALM 2** to confirm the setting.
→ AL1/AL2 icon and the minute digits flash.
- Hold down or press **TUNING +/-** repeatedly to adjust the minutes.
- Press **ALM 1/ALM 2** to confirm the setting.

Helpful hints:

- In standby mode, press **DATE** to display month and day information. In radio mode, to display alarm time, press **ALM 1/ALM 2**.
- The currently displayed alarm time is the time for the bracketed (selected) AL1 or AL2 (See [4]).

Selecting alarm mode (activating)

- Press **RADIO ON/OFF** to switch to standby.
 - Select your choice of alarm mode: either radio, or buzzer by using the **RADIO•BUZ** slider.
 - Press **ALM 1/ALM 2** once or more to display .
→ When alarm is activated,  is displayed. (See [4]).
- At the set alarm time, radio or buzzer will switch on automatically.

Switching off the alarm

There are three ways of switching off the alarm. Unless you choose to cancel the alarm completely, the DAILY ALARM RESET option will be automatically kept activated from the time your alarm first goes off. call at the same time for the following day:

Daily alarm reset

If you want the alarm to be stopped immediately but also wish to repeat the alarm

- During the alarm call, press once **SLEEP/ALARM RESET** or **RADIO ON/OFF**.

Repeat alarm

This will repeat your alarm call at 9-minute intervals.

- During the alarm call, press **REPEAT ALARM/BRIGHTNESS CONTROL**.

Switching off the alarm completely

Press once or more corresponding **ALM 1** or **ALM 2** until  disappears.

Sleep

The clock radio has a built-in sleep timer, which enables the set to be automatically switched off during radio playback after a set period of time.

Setting the sleep time

- During radio playback, set your timer by pressing repeatedly **SLEEP** until the desired timer option appears.
→ Selections are follows (time in minute)
10→20→30→60→90→120→OFF
→ 10
- The set will turn off automatically at the selected time.
- To cancel the timer function**, either press **SLEEP** once or more until "OFF" appears, or press **RADIO ON/OFF** to switch to standby.
→ "SLEEP" disappears when sleep function is cancelled.

Note:

– The sleep function does not affect your alarm time setting(s).

Illumination brightness

Press **REPEAT ALARM / brightness control** once or more.

- The brightness of the display can be adjusted: **High** → **Low** → **Off** → **High** .

Low battery indication







When the batteries of the unit are running low, the low battery icon will be displayed, indicating that the batteries should be replaced soon.

Weather forecast and Indoor thermometer

Weather forecast

The unit is capable of detecting atmospheric pressure changes. Based on the collected data, it can predict the weather in the next 12 to 24 hours. The effective range covers an area of approximately 30 to 50 km.

- Each weather forecast status will be displayed with graphical animation and different lighting colors at the top left hand corner of the unit, see the figure below.

LCD display	Light color 
 Sunny	Amber
 Partly cloudy	Light blue
 Cloudy	Blue
 Rainy	Purple
 Stormy	Red

About color lighting

- Battery operation: The light turns on for 10 seconds after each atmospheric measurement, or after any button pressed.
- AC operation: The light always turns on when the power is switched on. To let the light turn on just like the case of battery operation mentioned above, press and hold **REPEAT ALARM/BRIGHTNESS CONTROL** for about 10 seconds.

Notes:

- The weather forecast based on the atmospheric pressure may vary slightly from the actual weather situation.

– The weather forecasts from this unit are predictions that covers the next 12 to 24 hours. It may not necessarily reflect the current situation.

Indoor thermometer

- The unit can measure and display current indoor temperature in Centigrade (°C) or Fahrenheit (°F). To select between °C or °F reading, use the **(°C °F)** slide switch (located in the battery compartment).

Safety and maintenance

Safety and general maintenance

- If you do not intend to use the clock radio for a long time, withdraw the power cord from the wall outlet.
- Place the set on a hard and flat surface so that the system does not tilt.
- Install the unit near the AC outlet and where the AC power plug can be easily reached.
- The apparatus shall not be exposed to dripping or splashing
- Do not expose the set, batteries, to humidity, rain, sand or excessive heat caused by heating equipment or direct sunlight.
- No objects filled with liquids, such as vases, shall be placed on the apparatus.
- No naked flame sources, such as lighted candles, should be placed on the apparatus.
- Do not cover the set. Adequate ventilation with a minimum gap of 6 inches between the ventilation holes and surrounding surfaces is necessary to prevent heat build-up.
- The mechanical parts of the set contain self-lubricating bearings and must not be oiled or lubricated.
- To clean the set, use a soft dry cloth. Do not use any cleaning agents containing alcohol, ammonia, benzene or abrasives as these may harm the housing.

Disposal of your old product

Your product is designed and manufactured with high quality materials and components, which can be recycled and reused.

When this crossed-out wheeled bin symbol is attached to a product it means the product is covered by the European Directive 2002/96/EC.



Please inform yourself about the local separate collection system for electrical and electronic products.

Please act according to your local rules and do not dispose of your old products with your normal household waste. The correct disposal of your old product will help prevent potential negative consequences for the environment and human health.

Environmental information

All unnecessary packaging material has been omitted. The packaging can be easily separated into three materials: cardboard, polystyrene and plastic.

Your set consists of materials which can be recycled if disassembled by a specialized company. Please observe the local regulations regarding the disposal of packaging, dead batteries and old equipment.

Troubleshooting

If a fault occurs, first check the points listed below before taking the set for repair.

If you are unable to remedy a problem by following these hints, consult your dealer or service center.

WARNING: Do not open the set as there is a risk of electric shock. Under no circumstances should you try to repair the set yourself, as this will invalidate the warranty.

No sound.

- Volume not adjusted.
- Adjust the VOLUME.

Display error / no reaction to any controls.

- Electrical malfunction
- Press RESET hole on the bottom of the set with a ball pen.

Occasional crackling sound during FM broadcast.

- Weak signal.
- Extend the pigtail antenna fully.

The alarm does not function.

- Alarm time not set.
- See section on **Setting alarm time.**
- Alarm mode not selected.
- See section on **Setting alarm mode.**
- Volume too low for radio.
- Increase the volume.

CAUTION

- **High voltage! Do not open.** You run the risk of getting an electric shock. The machine does not contain any user-serviceable parts.
- **Modification of the product could result in hazardous radiation of EMC or other unsafe operation.**

English

Meet Philips at the Internet
<http://www.philips.com>

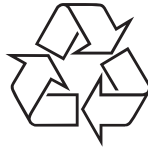

Printed in China

PDCC-JH-0651

Free Manuals Download Website

<http://myh66.com>

<http://usermanuals.us>

<http://www.somanuals.com>

<http://www.4manuals.cc>

<http://www.manual-lib.com>

<http://www.404manual.com>

<http://www.luxmanual.com>

<http://aubethermostatmanual.com>

Golf course search by state

<http://golfingnear.com>

Email search by domain

<http://emailbydomain.com>

Auto manuals search

<http://auto.somanuals.com>

TV manuals search

<http://tv.somanuals.com>