

Register your product and get support at
www.philips.com/welcome

GoGear

SA065104

SA065108



EN User manual

PHILIPS

Contents

1 Important safety information	3
General maintenance	3
Recycling the product	4
2 Your new SA065	6
What's in the box	6
3 Getting started	7
Overview of the controls and connections	7
Overview of the main touchscreen features	7
Connect and charge	8
Connect SA065 to a computer	8
Install the Philips Device Manager software	8
Battery level indication	9
Battery level indication	9
Disconnect SA065 safely	9
Use SA065 to carry files	9
Turn SA065 on and off	9
Automatic standby and shut-down	9
4 Music	10
Listen to music	10
Find your music	10
Delete music tracks	10
Add current track to favorites	10
Add current track to playlist	10
Rate your music	11
5 Video	12
Download and transfer videos	12
Transfer videos to SA065	12
Play videos	12
Delete videos	12
6 Pictures	13
View pictures	13
View slideshow	13
Add pictures to SA065	13
Delete pictures	13
Add current picture to favorites	13
7 Radio	14
Listen to FM radio	14
Manually tune a radio station	14
Auto-tune and listen to preset radio station	14
8 Recordings	15
Record from FM radio	15
Listen to FM recordings	15
Upload your radio recordings to a computer	15
Delete recordings	15
9 View folders and text files	16
Browse / view folders and read text files	16
Delete folders	16
10 Read text files	17
11 Access CMMB subscription channels	18
12 CMMB urgent messages	19
13 CMMB emergency news and urgent messages	20
14 Accessing Micro SD cards and importing files	21
Insert an SD card	21
15 Settings	22
16 Update SA065	23
Manually verify / update firmware	23
17 Troubleshooting	24

18 Technical data	25
Supported music file formats	25
Supported video file formats	25
Supported picture file formats	25

19 Glossary	26
--------------------	----

Need help?

Please visit

www.philips.com/welcome

where you can access a full set of supporting materials such as the user manual, the latest software updates, and answers to frequently asked questions.

1 Important safety information

General maintenance

! Caution

- To avoid damage or malfunction:
- Do not expose the product to excessive heat caused by heating equipment or direct sunlight.
- Do not drop the product or allow objects to fall on your player.
- Do not allow the product to be submerged in water. Do not expose headphone socket or battery compartment to water, as water entering the set may cause major damage.
- Active mobile phones in the vicinity may cause interference.
- Back up your files. Ensure that you retain the original files you have downloaded to your device. Philips is not responsible for any loss of data if the product becomes damaged or not readable / legible.
- Manage (transfer, delete, etc.) your music files only with the supplied music software to avoid problems.
- Do not use any cleaning agents containing alcohol, ammonia, benzene, or abrasives as these may harm the product.

About operating and storage temperatures

- Operate in a place where temperature is always between 0 and 35°C (32 to 95°F)
- Store in a place where temperature is always between -20 and 45°C (-4 to 113°F).
- Battery life may be shortened in low temperature conditions.

Replacement parts/accessories:

Visit www.philips.com/support to order replacement parts/accessories.

Hearing Safety



Listen at a moderate volume:

Using headphones at a high volume can impair your hearing. This product can produce sounds in decibel ranges that may cause hearing loss for a normal person, even for exposure less than a minute. The higher decibel ranges are offered for those that may have already experienced some hearing loss.

Sound can be deceiving. Over time your hearing 'comfort level' adapts to higher volumes of sound. So after prolonged listening, what sounds 'normal' can actually be loud and harmful to your hearing. To guard against this, set your volume to a safe level before your hearing adapts and leave it there.

To establish a safe volume level:

Set your volume control at a low setting.

Slowly increase the sound until you can hear it comfortably and clearly, without distortion.

Listen for reasonable periods of time:

Prolonged exposure to sound, even at normally 'safe' levels, can also cause hearing loss.

Be sure to use your equipment reasonably and take appropriate breaks.

Be sure to observe the following guidelines when using your headphones.

Listen at reasonable volumes for reasonable periods of time.

Be careful not to adjust the volume as your hearing adapts.

Do not turn up the volume so high that you can't hear what's around you.

You should use caution or temporarily discontinue use in potentially hazardous situations.

Do not use headphones while operating a motorized vehicle, cycling, skateboarding, etc.; it may create a traffic hazard and is illegal in many areas.

Modifications

Modifications not authorized by the manufacturer may void user's authority to operate the product.

Copyright information

All other brands and product names are trademarks of their respective companies or organizations.

Unauthorized duplication of any recordings whether downloaded from the Internet or made from audio CDs is a violation of copyright laws and international treaties.

The making of unauthorized copies of copy-protected material, including computer programs, files, broadcasts and sound recordings, may be an infringement of copyrights and constitute a criminal offense. This equipment should not be used for such purposes.

The Windows Media and the Windows logo are registered trademarks of Microsoft Corporation in the United States and/or other countries.

Be responsible! Respect copyrights.



Philips respects the intellectual property of others, and we ask our users to do the same. Multimedia content on the internet may have been created and/or distributed without the original copyright owner's authorization. Copying or distributing unauthorized content may violate copyright laws in various countries including yours.

Compliance with copyright laws remains your responsibility.

The recording and transfer to the portable player of video streams downloaded to your computer is intended only for use with public domain or properly licensed content. You may only use such content for your private, non-commercial use and shall respect eventual copyright instructions provided by the copyright owner of the work. Such instruction may

state that no further copies shall be made. Video streams may include copy protection technology that prohibits further copying. For such situations the recording function will not work and you will be notified with a message.

Data logging

Philips is committed to improving the quality of your product and enhancing the Philips user experience. To understand the usage profile of this device, this device logs some info / data to the non-volatile memory region of the device. These data are used to identify and detect any failures or problems you as a user may experience while using the device. The data stored, for example, will be the duration of playback in music mode, duration of playback in turner mode, how many times battery low was encountered, etc. The data stored do not reveal the content or media used on the device or the source of downloads. The data stored on the device are retrieved and used ONLY if the user returns the device to the Philips service center and ONLY to simplify error detection and prevention. The data stored shall be made available to user on user's first request.

Recycling the product

Your product is designed and manufactured with high quality materials and components, which can be recycled and reused. When you see the crossed-out wheel bin symbol attached to a product, it means the product is covered by the European Directive 2002/96/EC:



Never dispose of your product with other household waste. Please inform yourself about the local rules on the separate collection of electrical and electronic products. The correct disposal of your old product helps prevent potentially negative consequences on the environment and human health.

! Caution

- Removal of the built-in battery invalidates the warranty and may destroy the product. The following instructions are disposal instructions at the end of product life.

Your product contains a built-in rechargeable battery covered by the European Directive 2006/66/EC, which cannot be disposed of with normal household waste.



To safeguard the functionality and safety of your product, take your product to an official collection point or service centre where a professional can remove or replace the battery. Please inform yourself about the local rules on separate collection of batteries. The correct disposal of batteries helps prevent potentially negative consequences on the environment and human health.

2 Your new SA065

SA065 allows you to

- view CMMB* TV
- play WMV and MPEG4 (.avi) video files
- play MP3 and WMA audio files
- display album art
- view pictures
- listen to FM radio
- record from FM radio

≡ Note

- *CMMB TV requires subscription and is available in PR China only.

What's in the box

Check that you have received the following items:

Player



Earphones



USB cable



Stand



Quick start guide



≡ Note

- The images serve as reference only. Philips reserves the right to change color/design without notice.

3 Getting started

Overview of the controls and connections

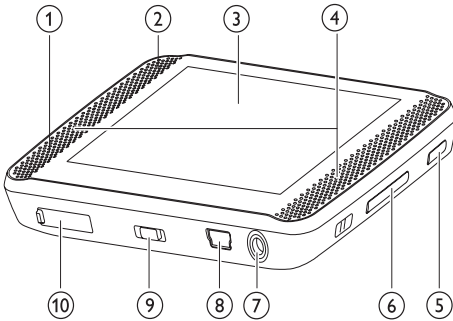

- ① **RESET** press: reset SA065
- ② antenna
- ③ touchscreen display
- ④ loudspeakers
- ⑤ **HOME** back to main menu
- ⑥ **- VOL +** press: increase/decrease the volume
press and hold: increase/decrease fast
- ⑦ headphone jack
- ⑧ USB connection jack
- ⑨ slide and hold: turn SA065 on/off
- slide: lock/unlock all buttons except **- VOL +**
- ⑩ **MICRO SD** micro SD card slot

Overview of the main menu

Menu	Mode	To
	Music	play music tracks
	Video	play videos
	Pictures	view pictures
	Radio	listen to FM radio
	Text Reader	read text files
	Folder View	view folders and files
	Settings	customize the settings of SA065
	CMMB	view CMMB* TV channels listen to CMMB* audio channels

Note

- *CMMB TV requires subscription and is available in PR China only.

Overview of the main touchscreen features

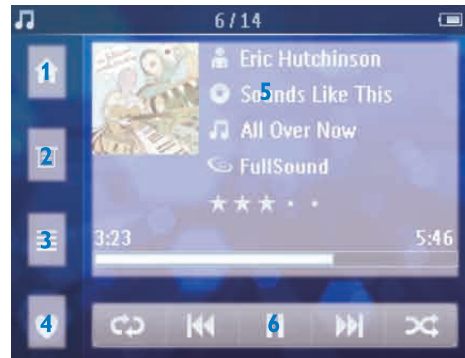

The touchscreen allows navigation and control through direct touch (tap) on the relevant screen area. There are many application-specific features and activities. This is an overview of the basic features:

1	home
2	contextual options
3	main activities of the application
4	application-specific feature / back
5	content area
6	change / process content

Connect and charge

SA065 has a built-in battery that can be charged through the USB port of a computer (USB cable included).

Connect SA065 to a computer

- 1 Connect the USB plug of the supplied USB cable to a spare USB port on your computer.
- 2 Connect the small USB plug of the USB cable to the small USB jack on SA065.
- 3 Turn on your computer.
↳ SA065 charges.

Install the Philips Device Manager software

System requirements:

- Windows® (2000, XP, Vista)
- Pentium III 800 MHz processor or higher
- 128 MB RAM
- 500 MB hard disk space
- Internet connection
- Microsoft® Internet Explorer 6.0 or later
- USB port

- 1 Connect the mini USB plug of the supplied cable to SA065.
- 2 Connect the standard USB plug of the supplied cable to your computer.
↳ A pop-up window appears on the computer.

- 3 From the pop-up window, select **Install Philips Device Manager**.
- 4 Follow the on-screen instructions to complete the installation of the **Philips Device Manager**.

If the pop-up window fails to appear on the computer...

- 1 Select **My Computer** (WindowsXP® / Windows2000®) / **Computer** (WindowsVista®).
- 2 Right click on **Philips GoGear SA065**.
- 3 Select **Install Philips Device Manager**.
- 4 Follow the on-screen instructions to complete the installation of the **Philips Device Manager**.

Cannot find the file on SA065?

- 1 Ensure that your computer is connected to the Internet.
- 2 Select **My Computer** (WindowsXP® / Windows2000®) / **Computer** (WindowsVista®).
- 3 Right click on **Philips GoGear SA065**.
- 4 Select **Install Philips Device Manager from the Internet**.
- 5 Follow the on-screen instructions to complete the installation of the **Philips Device Manager** from the Internet.







Note

- For first-time use, allow SA065 to charge for 3 hours.
- The charging animation stops and the  icon is displayed when the charging process is completed.

Battery level indication

The display indicates the approximate levels of the battery status as follows:

				
100%	75%	50%	25%	0%

- ↳ A flashing battery screen indicates that the battery is low. The player saves all settings and switches off within 60 seconds.

Battery level indication

Note

- Rechargeable batteries have a limited number of charge cycles. Battery life and number of charge cycles vary by use and settings.
- The charging animation stops and the  icon is displayed when the charging process is completed.

Tip

- You can conserve battery power and increase the play time of SA065: Go to the **Settings** menu and set **Backlight** to the shortest time setting.

Disconnect SA065 safely

To avoid data loss, disconnect SA065 from your computer as follows:

- 1 On your computer, exit all applications that are working with SA065.
- 2 Click  in the task tray of your computer.
- 3 Wait for the confirmation that SA065 can be safely removed, then disconnect SA065 from the USB port.

Use SA065 to carry files

SA065 allows you to carry files in **Windows Explorer**.

- 1 With SA065 connected to the USB port of the computer, open **Windows Explorer**.
- 2 Create folders in SA065.
- 3 Use drag and drop actions to sort your files into the folders.

Turn SA065 on and off

- 1 To toggle between modes on and off, slide and hold  for approximately 4 seconds.

Automatic standby and shut-down

SA065 has an automatic standby and shut-down feature that can save battery power. After 10 minutes in idle mode (no music plays, no button is pressed), SA065 turns off.





- 1 Slide and hold  for approximately 4 seconds to turn SA065 on again.

SA065 has a lock switch to prevent accidental operation.



- 1 To lock the buttons when you play, move the slider to position .
 - ↳ All buttons except the volume keys are locked and the display shows a lock icon.
- 2 To unlock the buttons again, move the slider to the center position.







4 Music

Listen to music

- 1 From the main menu, tap  to enter music mode.
- 2 Navigate the sub-menus to select your music.
- 3 Tap music track to highlight.
- 4 Tap music track again to play.
 - Tap  to pause play.
 - Tap  to resume play.
 - To exit and return to the main menu, press **HOME** or tap .

Find your music





- 1 From the main menu, tap  to enter music mode.
- 2 Tap  to see the options menu.
SA065 offers the following view options:

-  - All songs
 - Alphabetically listed tracks
-  - Artists
 - Alphabetically listed artists
 - Alphabetically listed albums
 - Tracks listed in album order
-  - Albums
 - Alphanumerically listed albums
 - Tracks listed in album order
-  Playlists
 -  Favorites
 - Tracks listed in favorites order
 -  Playlist
 - Tracks listed in playlist order

Note



- Alternatively, you can select  from the main menu and find your files in folder view.

Delete music tracks

- 1 From the main menu, tap  to enter music mode.
- 2 Tap  /  to select list item.
- 3 Tap the track you want to delete.
- 4 Tap  to see the options menu.
- 5 Select the delete option to delete the track.

Add current track to favorites

You can bookmark music tracks as favorites.

- 1 While you listen to music, tap  to bookmark the current music track as a favorite.
 - ↳ The current music track is added to the Favorites playlist.
 - ↳ Tap  again to remove the track from the Favorites playlist.

Tip

- You can listen to your Favorites playlist when you select the Favorites playlist from the music options menu.

Add current track to playlist

You can add music tracks to a playlist.

- 1 While you listen to music, tap  to see the options menu.
- 2 Tap a playlist.
 - ↳ The current music track is added to the playlist.

- ↳ Tap the playlist in the options menu again to remove the track from the Favorites playlist.

Rate your music

SA065 enables you to issue star ratings for your music.

- 1** While you listen to music, press ★ to open the ratings menu.
- 2** Tap to rate the current music track. (Ratings range from ★ to ★★★★★).

5 Video

Download and transfer videos

Transfer videos to SA065





- 1 With SA065 connected to the USB port of your PC, open **Windows® Explorer**.
- 2 Use drag and drop actions to transfer your video files to the **Video** folder of the internal storage of SA065.







Tip

- You can create your own folders in SA065 and sort your files into the folders.



Play videos

- 1 From the main menu, select  to enter video mode.
- 2 Navigate the sub-menus to select your video.
- 3 Tap video to highlight.
- 4 Tap video track again to play.
 - Tap  to pause play.
 - Tap  to resume play.
 - To exit and return to the main menu, press **HOME** or tap .

During video play, navigate as follows:

- 1 Tap  or  to skip to next / previous video.
- 2 Tap and hold  or  to scan current video forward / backward.
 - Tap  to resume play.

Delete videos

- 1 From the main menu, select  to enter video mode.
- 2 Navigate the sub-menus to select your video.
- 3 Tap  to play.
- 4 Tap  to see the options menu.
- 5 Select the delete option to delete the video.







Note

- Alternatively, you can select  from the main menu and find your files in folder view.

6 Pictures

View pictures

SA065 supports pictures in JPEG and BMP format.

- 1 From the main menu, select  to enter picture mode.
- 2 Tap  or  to scroll through the list.
- 3 Tap a picture to start full screen view.
- 4 Tap right side of the screen to go to next picture.
- 5 Tap left side of the screen to go to previous picture.
 - To exit and return to the main menu, press **HOME** or tap .

View slideshow



While in  mode, you can view your pictures as a slideshow:

- 1 Tap  to see the options menu.
- 2 Tap the options to
 - customize the slideshow settings
 - start the slideshow

Add pictures to SA065



- 1 With SA065 connected to the USB port of the computer, open **Windows® Explorer**.
- 2 Create folders in SA065.
- 3 Use drag and drop actions to sort your pictures into the folders.

Delete pictures

- 1 From the main menu, select  to enter picture mode.
- 2 Tap to select one or more pictures.
- 3 Tap  to see the options menu.
- 4 Select the delete option to delete all selected pictures.

Add current picture to favorites

You can bookmark pictures as favorites.

- 1 While you view a picture, tap  to bookmark the current picture as a favorite.
 - ↳ The current picture is added to the Favorites list.
 - ↳ Tap  again to remove the picture from the Favorites list.

Tip

- You can view your Favorites list when you select the Favorites list from the pictures options menu.



Note

- Alternatively, you can select  from the main menu and find your files in folder view.





7 Radio

Listen to FM radio

SA065 automatically searches for FM radio stations, then saves the first 20 strongest frequencies under the available presets.





- 1 From the main menu, select  to enter radio mode.
 - ↳ SA065 starts to play the last played preset.
 - ↳ Tap to select any of the preset numbers in the list.
 - ↳ To exit and return to the main menu, press **HOME** or tap .

Manually tune a radio station

- 1 From the main menu, select  to enter radio mode.
- 2 To search for the next stronger signal, tap and hold  / .
- 3 To fine tune the frequency, briefly tap  / .





Auto-tune and listen to preset radio station

You can change the frequencies that are automatically stored under the presets:

- 1 From the main menu, select  to enter radio mode.
- 2 While you listen to a radio preset, tap  or  to manually tune the frequency.
- 3 Tap on **[Save to preset]** to save the new frequency.
 - To exit and return to the main menu, press **HOME** or tap .

8 Recordings

Record from FM radio





- 1 From the main menu, select  to enter radio mode.
- 2 Select radio station (preset).
- 3 Tap  to start recording.
 - Tap  to pause recording.
 - Tap  to resume recording.
- 4 Press **Save** to stop and save the recording.
 - Press **Delete** to stop and delete the recording.
 - The screen prompts you to confirm.
- 5 Tap to select **[Yes]** / **[No]**.
 - ↳ Saved recordings are stored with the following filename format: FM_XX_XX_XX.##, where XX_XX_XX is the recording date and ## is the recording number that is generated automatically.



Tip

- You can find your recordings under main menu  > **Recordings**.

Listen to FM recordings

- 1 From the main menu, tap  to enter folder view.
- 2 Select folder **Recordings**.
- 3 Select a recording.
- 4 Tap  to play.
 - Tap  to pause play.
 - Tap  to resume play.
 - To exit and return to the main menu, press **HOME** or tap .

Upload your radio recordings to a computer

- 1 Connect SA065 to the computer (see section **Connect and charge** in this user manual).
- 2 On the computer, in **Windows® Explorer** select SA065.
- 3 Select **Recordings**.
- 4 Copy and paste the recordings to any location on the computer.

Delete recordings

Use a computer to delete recordings from SA065:





- 1 Connect SA065 to the computer (for instructions see section **Connect**).
- 2 On the computer, in **Windows® Explorer** select SA065.
- 3 Select **Recordings**.
- 4 Select the recordings you want to delete.
- 5 On the computer, press **Delete**.
 - ↳ The selected recordings are deleted.

9 View folders and text files



The folder view feature enables you to:

- browse / view folders and read text files
- delete folders
- delete text files

Browse / view folders and read text files





- 1 Follow the instructions to transfer text files to the player.
- 2 In the main menu, tap  to enter folder view.
- 3 Tap  or  to browse folders or text files.
- 4 Tap folder or text file to open.
 - To exit and return to the main menu, press **HOME** or tap .

Delete folders

- 1 While the cursor is on a folder, tap  to see the options menu.
- 2 Tap the delete option to delete the current folder.
- 3 Tap to confirm deletion.
 - To exit and return to the main menu, press **HOME** or tap .

10 Read text files





You can display and read text files on SA065:

- 1 From the main menu, tap  to enter text reader.
- 2 Tap  or  to select text file from the list.
- 3 Tap text file to view.
 - To exit and return to the main menu, press **HOME** or tap .

11 Access CMMB subscription channels



You can

- watch CMMB* TV channels
- listen to CMMB* audio channels

- 1 From the main menu, tap  to enter CMMB channels.
↳ SA065 reminds you not watch the screen while driving.
- 2 Extend the built-in telescopic antenna and align for best reception.
- 3 Tap  or  to select a service from the list.
- 4 SA065 scans the frequencies for CMMB signals and displays all available channels.
- 5 Tap on a channel to watch or listen.
 - To exit and return to the main menu, press **HOME** or tap .

12 CMMB urgent messages

The CMMB* service includes urgent messages. Incoming messages are indicated with the following icon at the top of the screen: 

- 1 Tap **Emergency news** to see the list of news messages.
 - ↳ Messages are displayed as follows: * = urgent message, n = new message, i = message.
- 2 Tap on a message to open it.
 - Tap  or  to scroll up or down
 - Tap  to see the options menu.
 - Select the option to delete the message.
- 3 Tap **Close** to close window.
 - ↳ The current CMMB broadcast continues after the message is closed.

13 CMMB

emergency news and urgent messages

The CMMB* services include emergency news. Emergency news interrupt the current broadcast with a pop up window. Upon incoming emergency news...

- 1 Tap **More** to read more (if message exceeds single screen size).
 - Tap  to see the options menu.
 - Select the option to delete the message.
- 2 Tap **Close** to close window.
 - ↳ The current CMMB broadcast continues after the message is closed.

14 Accessing Micro SD cards and importing files

SA065 has a slot to accommodate a Micro SD card.

Insert an SD card



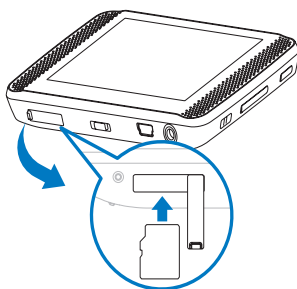

- 1 Turn on SA065.
- 2 Open the dust cover of the slot for Micro SD card.
- 3 Insert Micro SD card:



- ↳ SA065 accesses the content of the Micro SD card and displays the folders and files.

15 Settings

This is how you customize SA065:

- 1 From the main menu, tap  to enter settings menu.
- 2 Tap Press  or  to navigate in a list.
 - Tap  to enter sub menu (when available).
- 3 Tap to confirm a selection and go to the next level (when available).
 - To exit and return to the main menu, press **HOME** or tap .

In the  menu, the following options are available:

Settings	Menu options	Sub menu options
Sleep timer	<ul style="list-style-type: none">• Off• 15 minutes• 30 minutes• 60 minutes	
Display	Skins	<ul style="list-style-type: none">• Skin 1• Skin 2
	Brightness	<ul style="list-style-type: none">• one• two• three• four• five
	Backlight timer	<ul style="list-style-type: none">• 10 seconds• 20 seconds• 30 seconds• Always on
	Screen calibration	<ul style="list-style-type: none">• Yes• No
Information	<ul style="list-style-type: none">• Total memory• Available memory• Firmware version• Subscription ID	<ul style="list-style-type: none">• Model• Support site• US support site
Factory settings	Restore factory settings?	<ul style="list-style-type: none">• Yes• No
Language	<ul style="list-style-type: none">• EN• CN• HK	

16 Update SA065

↳ SA065 restarts after the firmware is updated and is ready for use again.

SA065 is controlled by an internal program called firmware. Newer versions of the firmware may have been released after you have purchased SA065.

The software program called **Philips Device Manager** can use your computer to check for firmware updates that are available on the Internet.

Install **Philips Device Manager** on your computer from SA065 or download the latest version from www.philips.com/support.



Note

- Your music files are not affected by a firmware update.

Manually verify / update firmware

- 1 Ensure that your computer is connected to the Internet.
- 2 Connect SA065 to the computer (see section **Connect and charge** for instructions).
- 3 On your computer, click **Start > Programs > Philips Digital Audio Player > SA065 Device Manager** to launch **Philips Device Manager**.
- 4 Click **Update**
↳ **Philips GoGear SA065 Device Manager** checks for updates and installs new firmware from the Internet, if available.
- 5 When the display shows **Update completed**, click **OK**.
- 6 Disconnect SA065 from the computer.
↳ The display of SA065 shows **Updating firmware**

17 Troubleshooting

If SA065 is not working properly or the display freezes, you can reset it without losing data:

How do I reset SA065?

- Insert a pen tip or other object into the reset hole located at the bottom of SA065. Hold until the player shuts down.
- If the reset option is unsuccessful, follow the steps how to recover SA065 with the **Philips Device Manager**:

- 1** On your computer, select **Start > Programs > Philips Digital Audio Player > SA065 Device Manager > Philips Device Manager** to launch the **Philips Device Manager**.
- 2** Turn off SA065 before you continue.
- 3** Press and hold the volume button **+** while you connect SA065 to your computer.
- 4** Keep holding the key until the **Philips Device Manager** acknowledges SA065 and enters the recovery mode.
- 5** On the computer, click the **Repair** button and follow the instructions of the **Philips Device Manager** to complete the recovery process.
- 6** When the recovery is completed, disconnect SA065 from your computer.
- 7** Restart SA065.

18 Technical data

Power

Power supply: 1250 mAh Li-ion polymer internal rechargeable battery
Play time¹ (music): 30 hours

Sound

Channel separation: 35 dB
Frequency Response: 55 Hz - 15 kHz
Output power (RMS): 2 × 2.4 mW
Signal to noise ratio: > 80 dB

Audio playback

Compression format:
MP3 bit rates: 8 - 320 kps and VBR
MP3 sample rates: 8, 11.025, 16, 22.050, 24, 32, 44.1, 48 kHz
WMA bit rates: 5 - 192 kbps VBR
WMA sample rates: 8, 11.025, 16, 22.050, 24, 32, 44.1, 48 kHz
Flac: 2 channels, sample rate 8 - 48 kHz
Ape: 2 channels, sample rate 8 - 48 kHz, versions up to 3.99
ID3-tag support

Video playback

MPEG4 SP: Up to 640 kbps, 320 × 240 pixels, 30 fps
Real Media Video: up to 2 Mbps, 320 × 240 pixels in .rm / .rmvb
WMV9: Up to 512 kbps, 320 × 240 pixels, 30 fps
Play time¹ (video): 6 hours

Storage media

Built-in memory capacity²:
SA065002 2GB NAND Flash
SA065004 4GB NAND Flash
SA065008 8GB NAND Flash

Video transfer³

Drag and drop in Windows Explorer

Music transfer³

Drag and drop in Windows Explorer

Data transfer³

Drag and drop in Windows Explorer

Display

Color LCD 320 × 240 pixels
262K colors

¹ Rechargeable batteries have a limited number of charge cycles. Battery life and number of charge cycles vary by use and settings.

² 1GB = 1 billion bytes; available storage capacity is less. Full memory capacity may not be available as some memory is reserved for the player. Storage capacity is based on 4 minutes per song and 128 kbps MP3 encoding.

³ Transfer speed depends on operating system and software configuration.

Supported music file formats

SA065 supports the following music formats:

- MP3
- WMA
- Flac
- Ape

Supported video file formats

SA065 supports the following video formats:

- MPEG4
- Real Media Video
- WMV9

Supported picture file formats

SA065 supports the following picture formats:

- JPEG
- BMP

19 Glossary

A

Album art

Album art is a feature that displays the artwork (cover picture) of a music album. This display enables the user to quickly identify a music album. The artwork files for music albums can be downloaded from the Internet.

APE

A lossless audio file compression format by Monkey's Audio that makes bit-for-bit copies without sacrificing quality.

C

CMMB

China Multimedia Mobile Broadcasting (CMMB) is a mobile television and multimedia standard developed and specified in China by the State Administration of Radio, Film, and Television (SARFT). It is based on the satellite and terrestrial interactive multiservice infrastructure (STiMi), developed by TiMiTech, a company formed by the Chinese Academy of Broadcasting Science. CMMB it has been described as being similar to Europe's DVB-SH standard for digital video broadcast from both satellites and terrestrial 'gap fillers' to handheld devices.

Compression

In audio terms, this is a process of temporarily or permanently reducing audio data for more efficient storage or transmission. A temporary reduction in file size is called 'non-lossy' compression, and no information is lost. A permanent reduction in file size (such as with MP3 files) is called 'lossy' compression, and involves discarding unnecessary information which is irretrievably lost.

D

Decibel (dB)

A unit of measure used to express relative difference in power or intensity of sound.

Digital Audio

Digital Audio is a sound signal that has been converted into numerical values. Digital sound can be transmitted through multiple channels. Analog sound can only be transmitted through two channels.

F

FLAC [Free Lossless Audio Codec]

An audio format similar to MP3, but lossless, meaning that audio is compressed in FLAC without loss in quality.

FM (Frequency Modulation)

In radio broadcasting: a method of modulation in which the frequency of the carrier voltage is varied with the frequency of the modulation voltage.

J

JPEG

A very common digital still picture format. A still-picture data compression system proposed by the Joint Photographic Expert Group, which features small decrease in image quality in spite of its high compression ratio. Files are recognized by their file extension 'jpg' or 'jpeg.'

K

Kbps

Kilobits per second. A digital-data-rate measurement system which is often used with highly compressed formats such as AAC, DAB, MP3 etc. The higher the amount, the better the quality generally is.

L

LCD (Liquid Crystal Display)

Probably the most common way to show visual information on non-computer electronic equipment.

M

MHz (Mega Hertz)

One million cycles per second.

MP3

A file format with a sound data compression system. MP3 is the abbreviation of Motion Picture Experts Group 1 (or MPEG-1) Audio Layer 3. With the MP3 format, one CD-R or CD-RW can contain about 10 times more data than a regular CD.

P

PCM (Pulse Code Modulation)

Pioneering form of digital recording.

S

Shuffle

A feature that plays audio files (tracks) in random order.

Stereo

Literally means solid. Usually taken to refer to two channel stereo, though developments in digital audio facilitate multichannel stereo.

T

Thumbnail

A thumbnail is reduced-size versions of a picture that is used to make it easier to recognize an them. Thumbnails serve the same role for images as a normal text index does for words.

V

Volume

Volume is the most common word used to specify the control of relative loudness of sounds. It also pertains to the function on many electronic devices that is used to control the loudness.

W

WAV

A format for sound files developed jointly by Microsoft and IBM. Built into Windows 95 to XP, which made it the de facto standard for sound on PCs. WAV sound files end with a '.wav' extension and works with nearly all Windows applications that support sound.

WMA (Windows Media Audio)

An audio format owned by Microsoft, is a part of Microsoft Windows Media technology. Includes Microsoft Digital Rights Management tools, Windows Media Video encoding technology, and Windows Media Audio encoding technology.

WMV [Windows Media Video]

Refers to a video compression technology developed by Microsoft Corporation. WMV content can be encoded by using Windows Media® Encoder 9 series. Files are recognised by their file extension '.wmv'.



Free Manuals Download Website

<http://myh66.com>

<http://usermanuals.us>

<http://www.somanuals.com>

<http://www.4manuals.cc>

<http://www.manual-lib.com>

<http://www.404manual.com>

<http://www.luxmanual.com>

<http://aubethermostatmanual.com>

Golf course search by state

<http://golfingnear.com>

Email search by domain

<http://emailbydomain.com>

Auto manuals search

<http://auto.somanuals.com>

TV manuals search

<http://tv.somanuals.com>