

Register your product and get support at
www.philips.com/welcome



32PFL5404/12
32PFL5404/60
42PFL5604/60
32PFL5604/60
42PFL5614/60
32PFL5614/60
22PFL5604/60
22PFL5614/60
19PFL5404/60

EN User Manual

PHILIPS



Österreich	0800 180 016	
België/Belgique	80080190	
България	00800 11 544 24	
Hrvatska	01 6403 776	Lokalni poziv
Česká republika	800142840	Bezplatný hovor
Danmark	3525 8759	Lokalt opkald
Estonia	6008600	kohalik kõne tariifi
Suomi	09 2311 3415	paikallispuhelu
France	0805 025 510	numéro sans frais
Deutschland	0800 000 7520	gebührenfreier Anruf
Ελλάδα	0 0800 3122 1280	Κλήση χωρίς χρέωση
Magyarország	0680018189	Ingyenes hívás
Hrvatska	0800 222778	free
Ireland	01 601 1777	
Italia	800 088774	Numero Verde
Қазақстан	+7 727 250 66 17	local
Latvia	52737691	local
Lithuania	67228896	local
Luxemburg/Luxembourg	40 6661 5644	Ortsgespräch/Appel local
Nederland	0800 0230076	Gratis nummer
Norge	22 70 81 11	Lokalsamtale
Polska	00800-311-13-18	Pozosta?e produkty RTV oraz AGD
Portugal	800 780 903	Chamada Grátis
România	0800-894910 0318107125	Apel gratuit Apel local
Россия	(495) 961-1111	0.15 USD/minute
Србија	+381 114 440 841	Lokalni poziv
Slovensko	0800 004537	Bezplatný hovor
Slovenija	00386 12 80 95 00	lokalni klic
España	900 800 655	Teléfono local gratuito solamente para clientes en España
Sverige	08 5792 9100	Lokalsamtal
Suisse/Schweiz/Svizzera	0800 002 050	Schweizer Festnetztarif/ Tarif réseau fixe France
Türkiye	0800 261 3302	Şehiriçi arama
United Kingdom	General No: 0800 331 6015 General National Rate No: 0870 911 0036	free National rate
Україна	0-800-500-697	

Contents

1 Notice	2	7 Connect devices	26
2 Important	4	Back connectors for 19-22 inch TV	26
3 TV overview	7	Back connectors for 26 inch and larger TV	27
Side controls and indicators	7	Side connectors	29
Remote control	7	Connect a computer	30
4 Use your product	9	Use Philips EasyLink	31
Switch your TV on/off or to standby	9	Use a Kensington lock	33
Switch channels	9	8 Product information	34
Watch connected devices	10	Supported display resolutions	34
Adjust TV volume	10	Multimedia	34
Use teletext	10	Tuner/Reception/Transmission	34
5 Use more of your product	11	Remote control	34
Access TV menus	11	Power	34
Remove devices from the home menu	11	Supported TV mounts	35
Change picture and sound settings	11	9 Troubleshooting	36
Use advanced teletext features	14	General TV issues	36
Create and use lists of favourite channels	14	TV channel issues	36
Use timers	15	Picture issues	36
Use TV lock	16	Sound issues	37
Use the TV clock	17	HDMI connection issues	37
Use Scenea	17	Computer connection issues	37
Watch TV in dual view	18	Contact us	37
View photos and play music from a USB storage device	19	10 Index	38
Update the TV software	20		
Change TV preferences	20		
Access decoder channel	20		
Start a TV demo	21		
Reset the TV to factory settings	21		
6 Install channels	22		
Automatically install channels	22		
Manually install channels	23		
Rename channels	24		
Reorder channels	25		

1 Notice

2009 © Koninklijke Philips Electronics N.V. All rights reserved.

Specifications are subject to change without notice. Trademarks are the property of Koninklijke Philips Electronics N.V or their respective owners. Philips reserves the right to change products at any time without being obliged to adjust earlier supplies accordingly. The material in this manual is believed adequate for the intended use of the system. If the product, or its individual modules or procedures, are used for purposes other than those specified herein, confirmation of their validity and suitability must be obtained. Philips warrants that the material itself does not infringe any United States patents. No further warranty is expressed or implied.

Warranty

- Risk of injury, damage to TV or void of warranty! Never attempt to repair the TV yourself.
- Use the TV and accessories only as intended by the manufacturer.
- The caution sign printed on the back of the TV indicates risk of electric shock. Never remove the TV cover. Always contact Philips Customer Support for service or repairs.



Any operation expressly prohibited in this manual, or any adjustments and assembly procedures not recommended or authorised in this manual shall void the warranty.

Pixel characteristics

This LCD product has a high number of colour pixels. Although it has effective pixels of 99.999% or more, black dots or bright points of light (red, green or blue) may appear constantly on the screen. This is a structural property of the display (within common industry standards) and is not a malfunction.

Compliance with EMF

Koninklijke Philips Electronics N.V. manufactures and sells many products targeted at consumers which, like any electronic apparatus, in general have the ability to emit and receive electromagnetic signals. One of Philips' leading Business Principles is to take all necessary health and safety measures for our products, to comply with all applicable legal requirements and to stay well within the EMF standards applicable at the time of producing the products.

Philips is committed to develop, produce and market products that cause no adverse health effects. Philips confirms that if its products are handled properly for their intended use, they are safe to use according to scientific evidence available today.

Philips plays an active role in the development of international EMF and safety standards, enabling Philips to anticipate further developments in standardisation for early integration in its products.

Mains fuse (UK only)

This TV is fitted with an approved moulded plug. Should it become necessary to replace the mains fuse, this must be replaced with a fuse of the same value as indicated on the plug (example 10A).

- 1 Remove fuse cover and fuse.
- 2 The replacement fuse must comply with BS 1362 and have the ASTA approval mark. If the fuse is lost, contact your dealer in order to verify the correct type.
- 3 Refit the fuse cover.

In order to maintain conformity to the EMC directive, the mains plug on this product must not be detached from the mains cord cable.

Copyright



VESA, FDMI and the VESA Mounting Compliant logo are trademarks of the Video Electronics Standards Association.

® Kensington and Micro Saver are registered US trademarks of ACCO World corporation with issued registrations and pending applications in other countries throughout the world.

All other registered and unregistered trademarks are the property of their respective owners.

2 Important

Read and understand all instructions before you use your TV. If damage is caused by failure to follow instructions, the warranty does not apply.

Safety

- Risk of electric shock or fire!
 - Never expose the TV to rain or water. Never place liquid containers, such as vases, near the TV. If liquids are spilt on or into the TV, disconnect the TV from the power outlet immediately. Contact Philips Consumer Care to have the TV checked before use.
 - Never place the TV, remote control or batteries near naked flames or other heat sources, including direct sunlight.
To prevent the spread of fire, keep candles or other flames away from the TV, remote control and batteries at all times.
- 
- Never insert objects into the ventilation slots or other openings on the TV.
 - When the TV is swivelled ensure that no strain is exerted on the power cord. Strain on the power cord can loosen connections and cause arcing.
 - Risk of short circuit or fire!
 - Never expose the remote control or batteries to rain, water or excessive heat.
 - Avoid force coming onto power plugs. Loose power plugs can cause arcing or fire.
 - Risk of injury or damage to the TV!
 - Two people are required to lift and carry a TV that weighs more than 25 kg.
 - When stand mounting the TV, use only the supplied stand. Secure the stand to the TV tightly. Place the TV on a flat, level surface that can support the combined weight of the TV and the stand.
 - When wall mounting the TV, use only a wall mount that can support the weight of the TV. Secure the wall mount to a wall that can support the combined weight of the TV and wall mount. Koninklijke Philips Electronics N.V. bears no responsibility for improper wall mounting that result in accident, injury or damage.
 - Risk of injury to children! Follow these precautions to prevent the TV from toppling over and causing injury to children:
 - Never place the TV on a surface covered by a cloth or other material that can be pulled away.
 - Ensure that no part of the TV hangs over the edge of the surface.
 - Never place the TV on tall furniture (such as a bookcase) without anchoring both the furniture and TV to the wall or a suitable support.
 - Educate children about the dangers of climbing on furniture to reach the TV.
 - Risk of overheating! Never install the TV in a confined space. Always leave a space of at least 4 inches or 10 cm around the TV for ventilation. Ensure curtains or other objects never cover the ventilation slots on the TV.
 - Risk of damage to the TV! Before you connect the TV to the power outlet, ensure that the power voltage matches the value printed on the back of the TV. Never connect the TV to the power outlet if the voltage is different.

- Risk of injury, fire or power cord damage! Never place the TV or any objects on the power cord.
- To disconnect the TV power cord easily from the power outlet, ensure that you have full access to the power cord at all times.
- When you disconnect the power cord, always pull the plug, never the cable.
- Disconnect the TV from the power outlet and antenna before lightning storms. During lightning storms, never touch any part of the TV, power cord or antenna cable.
- Risk of hearing damage! Avoid using earphones or headphones at high volumes or for prolonged periods of time.
- If the TV is transported in temperatures below 5°C, unpack the TV and wait until the TV temperature matches room temperature before connecting the TV to the power outlet.

Screen care

- Avoid stationary images as much as possible. Stationary images are images that remain on-screen for extended periods of time. Examples include: on-screen menus, black bars and time displays. If you must use stationary images, reduce screen contrast and brightness to avoid screen damage.
- Unplug the TV before cleaning.
- Clean the TV and frame with a soft, damp cloth. Never use substances such as alcohol, chemicals or household cleaners on the TV.
- Risk of damage to the TV screen! Never touch, push, rub or strike the screen with any object.
- To avoid deformations and colour fading, wipe off water drops as soon as possible.

Disposal of your old product and batteries



Your product is designed and manufactured with high quality materials and components, which can be recycled and reused.



When this crossed-out wheeled bin symbol is attached to a product it means that the product is covered by the European Directive 2002/96/EC. Please inform yourself about the local separate collection system for electrical and electronic products.

Please act according to your local rules and do not dispose of your old products with your normal household waste.

Correct disposal of your old product helps to prevent potential negative consequences for the environment and human health.



Your product contains batteries covered by the European Directive 2006/66/EC, which cannot be disposed with normal household waste.

Please inform yourself about the local rules on separate collection of batteries because correct disposal helps to prevent negative consequences for the environmental and human health.

ECO-Green



- High energy efficiency
- Low standby power
- Designed to facilitate recycling

Philips continuously focuses on lowering the environmental impact of its innovative consumer products. We aim our efforts towards environmental improvements during manufacturing, reduction of harmful substances, energy-efficient use, end-of-life instructions and product recycling.

Thanks to our environmental effort, this TV has been awarded the European Ecolabel –the flower– www.ecolabel.eu

You can find detailed information on standby energy consumption, warranty policy, spare parts and recycling of this TV on the Philips website for your country at www.philips.com.

This TV has features that contribute to energy-efficient use. This TV was awarded the European Ecolabel for its environmental qualities.

Energy efficiency features

- **Ambient light sensor** (Available in selected models only)
To save energy, the built-in Ambient light sensor lowers the brightness of the TV screen when the surrounding light darkens.
- **Energy saving**
The energy saving setting of the TV combines several TV settings that result in saving energy. See the smart settings in the setup menu.

- **Low standby power consumption**

The class-leading and highly advanced power circuitry brings down the power consumption of the TV to an extremely low level, without losing out on the constant standby functionality.

Power management (Available in selected models only)

The advanced power management of this TV ensures the most efficient use of its energy. You can check how your personal TV settings, the level of brightness in current onscreen pictures and the surrounding light conditions determine the relative power consumption.

End of use

To inform yourself on the correct disposal of the TV and batteries, refer to 'Disposal of your old product and batteries' in the user manual (see 'Disposal of your old product and batteries' on page 5).

3 TV overview

This section gives you an overview of commonly used TV controls and functions.



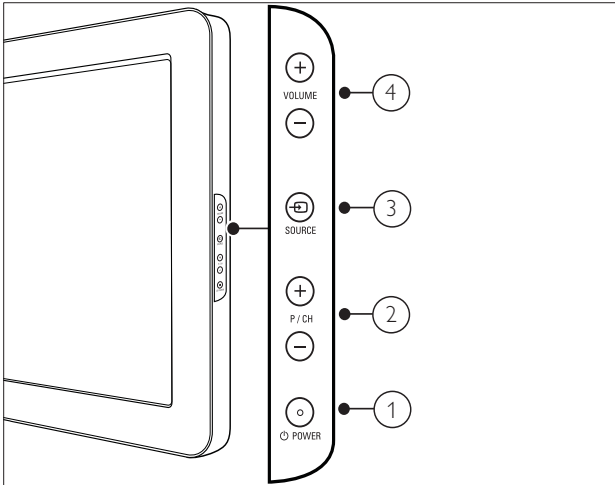





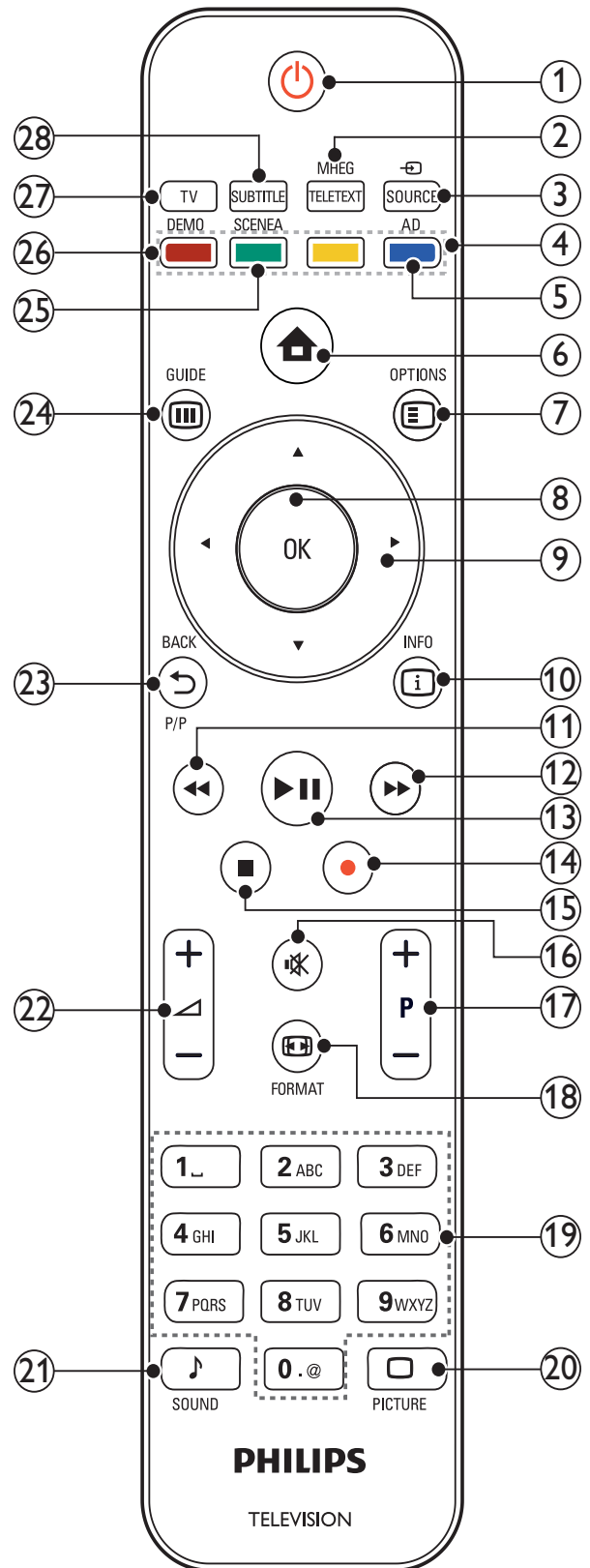









Side controls and indicators



- ① **POWER:** Switches the product on or off. The product is not powered off completely unless it is physically unplugged.
- ② **P/CH +/-:** Switches to the next or previous channel.
- ③ **SOURCE:** Selects connected devices.
- ④ **VOLUME +/-:** Increases or decreases volume.

Remote control



- ①  **(Standby-On)**
 - Switches the TV to standby if it is on.
 - Switches on the TV if it is in standby.
- ② **MHEG/TELETEXT**
Toggles teletext on or off.
- ③  **SOURCE**
Selects connected devices.
- ④ **Colour buttons**
Selects tasks or options.
- ⑤ **AD (Audio Descriptor) (For RF Digital TV only)**
UK only: Enables audio commentary for the visually handicapped.
- ⑥  **(Home)**
Toggles the home menu on or off.
- ⑦  **OPTIONS**
Accesses options relating to the current activity or selection.
- ⑧ **OK**
Confirms an entry or selection and displays the channel grid, when watching TV.
- ⑨  **(Navigation buttons)**
Navigates menus.
- ⑩  **INFO**
Displays program information, when available. If the information spans multiple pages, press **OPTIONS** to go to the next page.
- ⑪  **(Backward)**
Searches backward.
- ⑫  **(Forward)**
Searches forward.
- ⑬  **(Play/Pause)**
Starts, pauses or resumes playback.
- ⑭  **(Record) (only used for Easylink features (see 'Use Philips EasyLink' on page 31))**
Starts or stops video recording.
- ⑮  **(Stop)**
Stops playback.
- ⑯  **(Mute)**
Mutes or restores volume.
- ⑰ **P +/- (Programme +/-)**
Switches to the next or previous channel. When the TV menu is on, this functions as Page Up/Down.
- ⑱  **FORMAT**
Selects a picture format.
- ⑲ **0-9 (Numeric buttons)**
Selects a channel or setting.
- ⑳  **PICTURE**
Launches the picture menu. (Not supported on all models.)
- ㉑  **SOUND**
Launches the sound menu. (Not supported on all models.)
- ㉒  **+/- (Volume +/-)**
Increases or decreases volume.
- ㉓  **BACK/P (Previous channel)**
Returns to a previous channel or menu screen.
- ㉔  **GUIDE**
Switches between channel grid and programme list.
- ㉕ **SCENEA (Wallpaper)**
Displays wallpaper on your TV screen.
- ㉖ **DEMO**
Toggles the demonstration menu on or off.
- ㉗ **TV**
Switches back to the aerial source.
- ㉘ **SUBTITLE (For RF Digital TV only)**
Enables or disables subtitles.

4 Use your product

This section helps you perform basic operations (see 'Use more of your product' on page 11).

Switch your TV on/off or to standby

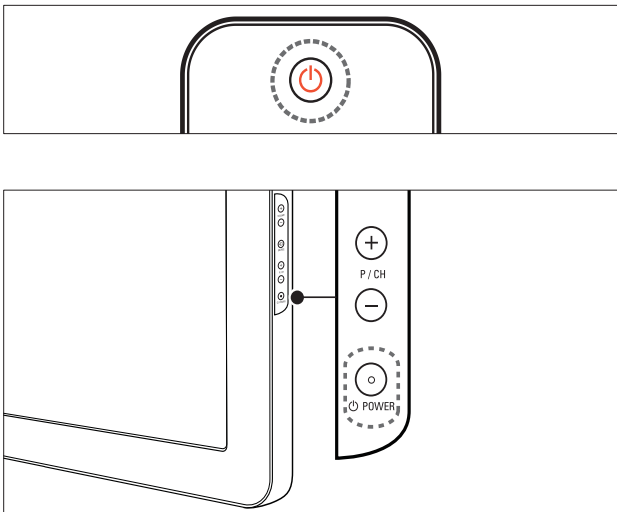

To switch on

- If the standby indicator is off, press **POWER** at the side of the TV.
- If the standby indicator is red, press **(Standby-On)** on the remote control.

To switch to standby

- Press **(Standby-On)** on the remote control.
↳ The standby indicator switches to red.

To switch off

- Press **POWER** at the side of the TV.
↳ The standby indicator switches off.

Tip

- Though your TV consumes very little power when in standby, energy continues to be consumed. When not in use for an extended period of time, disconnect the TV power cable from the power outlet.

Note

- If you cannot locate your remote control and want to switch on the TV from standby, press **P/CH +/-** or **SOURCE** at the side of the TV.

Switch channels

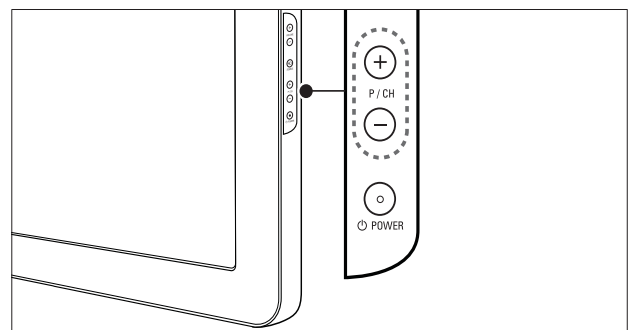
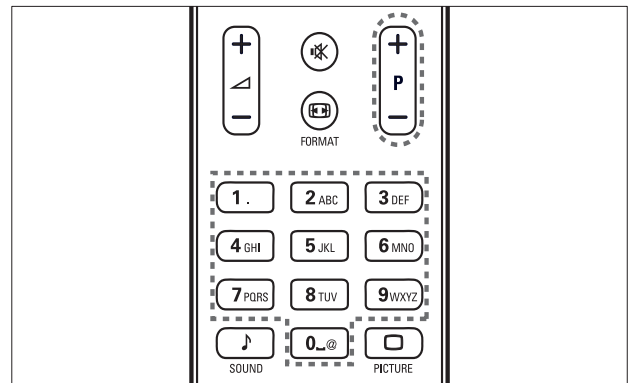

- Press **P +/-** on the remote control or **P/CH +/-** on the side of the TV.
- Enter a channel number using the **Numeric buttons**.
- Use the channel grid (see 'Switch channels with the channel grid' on page 10).

Note

- When you use a favourite list, you can only select those channels in the list.

Switch channels with the channel grid

The channel grid allows you to view all available channels in a grid format.

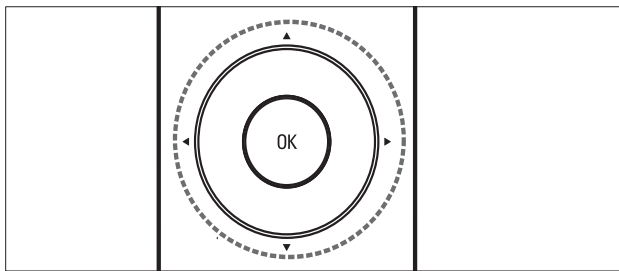

- 1 Press **OK**.
↳ The channel grid appears.
- 2 Press **▲▼◀▶** to browse the channel grid and preview a channel.
↳ The channel content is displayed after a lapse of approximately two seconds.
- 3 When you find a channel of your choice, press **OK** to watch.
↳ The selected channel appears.

Watch connected devices

Note

- Switch on the device before selecting it as a source on the TV.

Use the source button

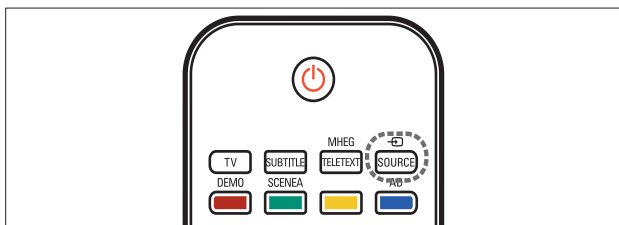

- 1 Press **SOURCE**.
↳ The source list appears.
- 2 Press the **Navigation buttons** to select a device.
- 3 Press **OK** to confirm your choice.
↳ The TV switches to the selected device.

Adjust TV volume

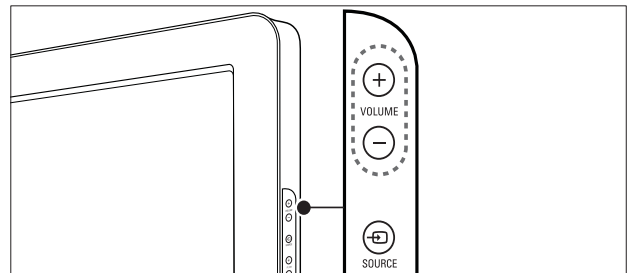
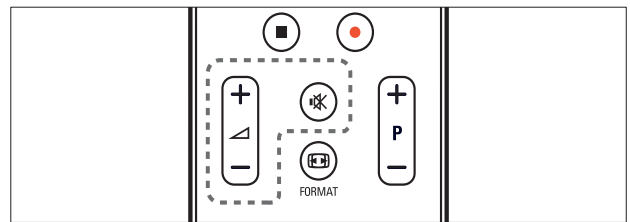

To increase or decrease volume

- Press **+/-**.
- Press **VOLUME +/-** on the side of the TV.

To mute or unmute sound

- Press **MUTE** to mute the sound.
- Press **MUTE** again to restore the sound.

Use teletext

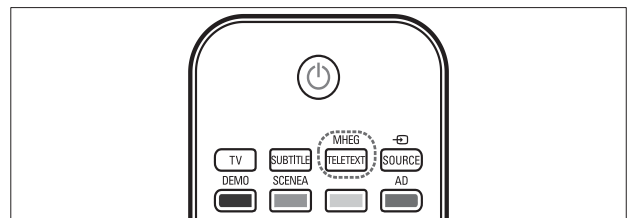

- 1 Press **MHEG/TELETEXT**.
↳ The main index page appears.
- 2 Select a page as follows:
 - Press the **Numeric buttons** to enter a page number
 - Press **P +/-** or **▲▼** to view the next or previous page
 - Press the **Colour buttons** to select a colour coded item
 - Press **BACK** to return to a previously viewed page
- 3 Press **MHEG/TELETEXT** to exit teletext.

5 Use more of your product

Access TV menus

Menus help you to install channels, change picture and sound settings and access other features.

- 1 Press **⬆** (**Home**).
↳ The menu screen appears.

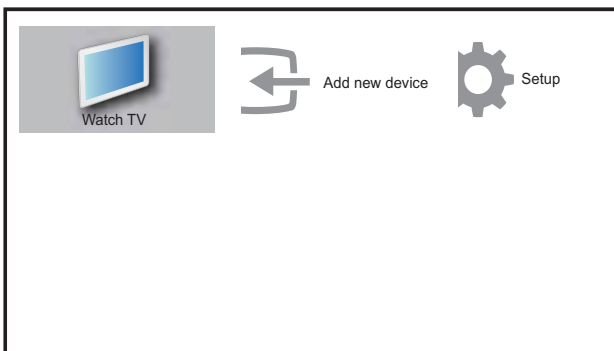

- 2 Press the **▲▼◀▶** to select and navigate through one of the following menus.
 - **[Watch TV]** Switches back to the aerial source if another source is selected.
 - **[Setup]** Accesses menus to change picture, sound and other settings.
 - **[Add new device]** Adds new devices to the home menu.
- 3 Press **OK** to confirm your choice.
- 4 Press **⬆** (**Home**) to exit.



Tip

- After selecting **[Add new device]**, follow the on-screen instructions to select the correct device and connector.

Remove devices from the home menu

If a device is no longer connected to the TV, remove it from the home menu.

- 1 Press **⬆** (**Home**).
- 2 Press **▲▼◀▶** to select a device to remove.
- 3 Press **⌂** **OPTIONS**.
↳ The **[Remove device]** list appears.
- 4 Press **OK** and select **[Remove]** to remove the device.
↳ The selected device is removed from the home menu.

Change picture and sound settings

Change picture and sound settings to suit your preferences. You can apply pre-defined settings or change settings manually.

Use settings assistant

Use the settings assistant to guide you through the picture and sound settings.

- 1 Press **⬆** (**Home**).
- 2 Press **▲▼◀▶** to select **[Setup]** > **[Picture]** > **[Settings assistant]**.
- 3 Press **OK**.
↳ The **[Settings assistant]** menu appears. Follow the on-screen instructions to choose your preferred picture settings.

Use smart picture

Use smart picture to apply pre-defined picture settings.

- 1 Press **PICTURE**.
↳ The **[Smart picture]** menu appears.
- 2 Press **▲▼** to select one of the following smart picture settings.
 - **[Personal]**Lists customised picture settings.
 - **[Vivid]**Applies rich and dynamic settings.
 - **[Standard]**Adjusts picture settings to suit most environments and types of video.
 - **[MOVIE]**Applies settings for movie viewing.
 - **[Game]**Applies settings for games.
 - **[Energy saving]**Applies low-energy settings.
- 3 Press **OK** to confirm your choice.
↳ The selected smart picture setting is applied.

Manually adjust picture settings

- 1 Press **Home**.
- 2 Press **▲▼◀▶** to select **[Setup] > [Picture]**.
↳ The **[Picture]** menu appears.
- 3 Press **▲▼◀▶** to select one of the following picture settings.
 - **[Smart picture]**Accesses pre-defined smart picture settings.
 - **[Contrast]**Adjusts the intensity of bright areas, keeping dark areas unchanged.
 - **[Brightness]**Adjusts the intensity and details of dark areas.
 - **[Colour]**Adjusts colour saturation.
 - **[Hue]**Compensates colour variations in NTSC encoded transmissions.
 - **[Sharpness]**Adjusts sharpness in the image.
 - **[Noise reduction]**Filters and reduces noise in an image.

- **[Tint]**Adjusts the colour balance in an image.
- **[Custom tint]**Customises tint setting.
- **[Pixel Plus HD]**Adjusts picture quality to optimal contrast, colour and sharpness.
 - **[Dynamic contrast]**Enhances contrast. A **[Medium]** setting is recommended.
 - **[Dynamic backlight]**Adjusts brightness of the TV backlight to match lighting conditions.
 - **[Colour enhancement]**Makes colours more vivid and improves the details in bright colours. You can switch this feature on or off.
- **[Light sensor]**Adjusts settings dynamically to match lighting conditions.
- **[PC mode]**Adjusts the picture when a PC is connected to the TV via HDMI or DVI.
- **[Picture format]**Changes the picture format.
- **[Horizontal shift]**Adjusts the picture horizontally for PC-VGA or YPbPr (EXT2 or EXT3).
- **[Vertical shift]**Adjusts the picture vertically for PC-VGA or YPbPr (EXT2 or EXT3).

Change picture format

- 1 Press **FORMAT**.
↳ A picture format bar appears.
- 2 Press **▲▼** to select a picture format.
↳ The selected picture format is activated.
- 3 Press **OK** to confirm your choice.

Summary of picture formats

The following picture settings can be configured.

Note

- Depending on the format of the picture source, some picture settings are not available.

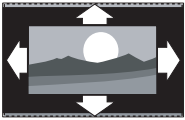

[Auto format](Not for HDMI, YPbPr - EXT2/EXT3 or PC mode.) Enlarges the picture automatically to best fit the screen. The subtitles remain visible.

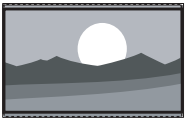

[Super zoom](Not for HD and PC mode.) Removes the black bars on the side of 4:3 broadcasts. There is minimal distortion.

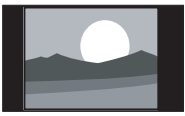

[4:3]Shows the classic 4:3 format.



[Subtitle zoom]Displays 4:3 pictures over the full area of the screen, with sub-titles visible. Part of the top of the picture is clipped off.



[Movie exp.14:9](Not for HD and PC mode.) Scales 4:3 format to 14:9.

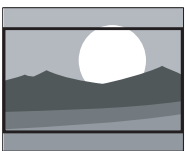

[Movie exp.16:9](Not for HD and PC mode.) Scales 4:3 format to 16:9.

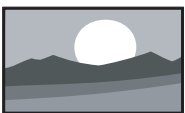

[Wide screen]Scales 4:3 format to 16:9.

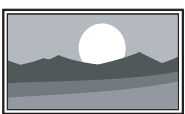

[Unscaled]Available in selected models with PC resolution under 1024 x 768, only. Allows maximum sharpness. Some distortion may be present due to the broadcaster's systems. Set your PC resolution to wide screen mode for best results.

Use smart sound

Use smart sound to apply pre-defined sound settings.

- 1 Press **⏮ SOUND**.
↳ The **[Smart sound]** menu appears.
- 2 Press **▲▼** to select one of the following smart sound settings.
 - **[Standard]**Adjusts sound settings to suit most environments and types of audio.
 - **[NEWS]**Applies settings for spoken audio, such as news.
 - **[MOVIE]**Applies settings for movies.
 - **[Personal]**Applies the settings that were customised in the sound menu.
- 3 Press **OK** to confirm your choice.
↳ The selected smart sound setting is applied.

Manually adjust sound settings

- 1 Press **⏮ (Home)**.
- 2 Press **▲▼◀▶** to select **[Setup] > [Sound]**.
↳ The **[Sound]** menu appears.
- 3 Press **▲▼◀▶** to select one of the following sound settings.
 - **[Smart sound]**Accesses pre-defined smart sound settings.
 - **[Bass]**Adjusts the bass level.
 - **[Treble]**Adjusts the treble level.
 - **[Volume]**Adjusts the volume.
 - **[Balance]**Adjusts the balance of the right and left speakers.
 - **[Dual I-II]**Selects audio languages if dual sound broadcast is available.
 - **[Mono/Stereo]**Selects mono or stereo if stereo broadcast is available.
 - **[TV speakers]**Turns TV speakers on or off. Setting TV speakers to automatic mode turns off the speakers when content from an EasyLink-compliant home theatre system is detected.

- **[Surround]** Enables spatial sound.
- **[Headphone volume]** Adjusts headphone volume.
- **[Auto volume]** Automatically reduces sudden volume changes, for example, when switching channels.
- **[Delta volume]** Levels out volume differences between channels or connected devices. Switch to the connected device before you change the delta volume.

Use advanced teletext features

Access the teletext options menu

Access the teletext features through the teletext options menu.

- 1 Press **MHEG/TELETEXT**.
↳ The teletext screen appears.
- 2 Press **⏏** **OPTIONS**.
↳ The teletext options menu appears.
- 3 Press **▲▼** to select one of the following options.
 - **[Freeze Page]** Freezes the current page.
 - **[Dual/Full screen]** Enables and disables dual screen teletext.
 - **[Reveal]** Hides or reveals hidden information on a page, such as solutions to riddles or puzzles.
 - **[Cycle subpage]** Cycles through subpages automatically if subpages are available.
 - **[Language]** Switches to a different language group to display a language correctly when it uses a different character set.
- 4 Press **OK** to confirm your choice.
- 5 Press **MHEG/TELETEXT** to exit the teletext options menu.

Select teletext subpages

A teletext page can hold several subpages. Subpages are displayed on a bar next to the main page number.

- 1 Press **MHEG/TELETEXT**.
↳ The teletext screen appears.
- 2 Select a teletext page with subpages.
- 3 Press **▶** to enter a subpage.
↳ The subpage appears.
- 4 Press **◆** to switch between subpages.

Select T.O.P. teletext broadcasts

Table Of Pages (T.O.P.) teletext broadcasts allow you to jump from one subject to another without using page numbers. T.O.P. teletext is not broadcast on all TV channels.

- 1 Press **MHEG/TELETEXT**.
↳ The teletext screen appears.
- 2 Press **ⓘ** **INFO**.
↳ The T.O.P. overview appears.
- 3 Press **▲▼◀▶** to select a subject.
- 4 Press **OK** to view the page.

Create and use lists of favourite channels

You can create lists of your preferred TV channels and radio stations so that you can find those channels easily.



Tip

- You can create and store up to four favourite lists on your TV.

Select a favourite list

- 1 When watching TV, press **OK** to display the channel grid.
- 2 Press **⏏** **OPTIONS**.
↳ The channel options menu appears.

- 3 Press **OK** to select **[Show favourite ch.]**.
↳ The favourite lists appear.
- 4 Press **▲▼** to select a favourite list.
- 5 Press **OK**.
↳ Only channels in the favourite list appear in the channel grid.

View all channels

You can exit a favourite list, and view all installed channels.

- 1 When watching TV, press **OK** to display the channel grid.
- 2 Press **☰** **OPTIONS**.
↳ The channel options menu appears.
- 3 Select **[Show favourite ch.] > [All]**.
- 4 Press **OK**.
↳ All channels display in the channel grid.

Note

- All favourite channels are marked by an asterisk in the channel grid.

Add a channel to a favourite list

- 1 When watching TV, switch to the channel you want to add to a favourite list (see 'Switch channels' on page 9).
- 2 Press **▲▼◀▶** to select a channel to add to a favourite list.
- 3 Press **☰** **OPTIONS**.
↳ The channel options menu appears.
- 4 Press **▲▼** to select **[Mark as favourite]**.
- 5 Press **OK**.
↳ The favourite lists appear.
- 6 Press **▲▼** to select a favourite list to add the channel to.
- 7 Press **OK**.
↳ The channel is added to the favourite list.

Tip

- When watching TV, press **☰** **OPTIONS** > **[Mark as favourite]** to save the current channel into a favourite list.

Remove a channel from a favourite list

Note

- Select the favourite list to edit, before removing a channel.

- 1 When watching TV, press **OK** to display the channel grid.
- 2 Press **☰** **OPTIONS**.
↳ The channel options menu appears.
- 3 Press **OK** to enter **[Show favourite ch.]**.
- 4 Press **▲▼** to select a favourite list and press **OK** to confirm the choice.
- 5 Press **▲▼◀▶** to choose the channel that you wish to remove from the list.
- 6 Press **☰** **OPTIONS**.
- 7 Press **▲▼** to select **[Unmark as fav.]**.
- 8 Press **OK**.
↳ The channel is removed from the favourite list.

Use timers

You can set timers to switch the TV to standby at a specified time.

Automatically switch the TV to standby (sleep timer)

Sleep timer switches the TV to standby after a pre-defined period of time.

Tip

- You can switch off your TV earlier or reset the sleep timer during the countdown.

- 1 Press **⬆** (Home).
- 2 Press **▲▼◀▶** to select **[Setup]** > **[Features]** > **[Sleeptimer]**.
↳ The **[Sleeptimer]** menu appears.
- 3 Press **◀▶** to set the sleep time.
↳ The sleeptimer can be up to 180 minutes in steps of five minutes. If set to zero minutes, the sleeptimer is switched off.
- 4 Press **OK** to activate the sleeptimer.
↳ The TV switches to standby after the pre-defined period of time.

Automatically switch the TV on (on timer)

You can switch on the TV from standby to a specific channel at a specified time.

- 1 Press **⬆** (Home).
- 2 Press **▲▼◀▶** to select **[Setup]** > **[Features]** > **[On timer]**.
- 3 Press **▶** to enter the **[On timer]** menu.
- 4 Press **▲▼◀▶** to select **[Activate]** and set a frequency - **[Daily]**, **[Once]**, or **[Off]**.
- 5 Press **OK** to confirm.
- 6 Press **▲▼◀▶** to select **[Time]** and set the starting time.
- 7 Press **[Done]** to confirm.
- 8 Press **▲▼◀▶** to select **[Programme no.]** and set the channel.
- 9 Press **OK** to confirm.
- 10 Press **⬆** (Home) to exit.



Tip

- Select **[On timer]** > **[Activate]** > **[Off]** to disable **[On timer]**.
- When **[On timer]** is **[Off]**, only **[Activate]** can be selected.
- Set the TV clock before activating **[On timer]** feature.

Use TV lock

You can prevent your children from watching certain programs or certain channels by locking the TV controls.

Set or change the TV lock code

- 1 Press **⬆** (Home).
- 2 Press **▲▼◀▶** to select **[Setup]** > **[Features]** > **[Set code]**.
- 3 Press **▶** to enter the code setup.
- 4 Enter your code using the **Numeric buttons**.
- 5 Re-enter the same code in the new dialogue box for confirmation.
↳ If the code is set successfully, the dialogue box will disappear. However, if the code cannot be set, a new dialogue box will prompt you to re-enter the code.
- 6 If you want to change the code, select **[Setup]** > **[Features]** > **[Change code]**.
- 7 Enter your current code using the **Numeric buttons**.
↳ If the code is validated, a new dialogue box will prompt you to enter your new code.
- 8 Enter the new code using the **Numeric buttons**.
↳ A message appears prompting you to enter the new code again for confirmation.



Tip

- If you forget your code, enter '8888' to override any existing codes.

Lock or unlock the TV

Lock the TV to prevent access to all channels and connected devices.

- 1 Press **⬆** (Home).
- 2 Press **▲▼◀▶** to select **[Setup] > [Features] > [TV lock]**.
- 3 Press **▶** to enter the **[TV lock]**.
↳ A screen appears prompting you to enter a code.
- 4 Enter your code using **Numeric buttons**.
- 5 Press **▲▼** to select **[Lock]** or **[Unlock]**.
- 6 Press **OK**.
↳ All channels and connected devices are locked or unlocked.
- 7 Press **⬆** (Home) to exit.

Note

- If you select **[Lock]**, you have to enter your code every time you turn on your TV.

Lock or unlock one or more channels

- 1 When watching TV, press **OK** to display the channel grid.
- 2 Press **▲▼◀▶** to select a channel to lock or unlock.
- 3 Press **☰** **OPTIONS**.
- 4 Press **▲▼** to select **[Lock channel]** or **[Unlock channel]**.
- 5 For each selection, press **OK** to lock or unlock the channel.

Note

- Restart the TV for the change to take effect.

Use the TV clock

You can display a clock on the TV screen.

Set the TV clock

- 1 Press **⬆** (Home).
- 2 Select **[Setup] > [Features] > [Clock]**
↳ The **[Clock]** menu appears.
- 3 Press **▲▼◀▶** or **Numeric buttons** to enter time.
- 4 Press **[Done]** to confirm.
- 5 Press **⬆** (Home) to exit.

Use Scenea

Scenea transforms your TV into a personalised photo frame. With Scenea enabled, you can display a single picture or a slideshow of pictures on your TV — perfect for parties or other social gatherings.

Note

- Use Eco mode to save energy when the Scenea wallpaper or a slideshow is displayed on your TV (see 'Use Eco mode with Scenea wallpaper' on page 18).
- Scenea wallpaper is not available in shop mode (see 'Change TV preferences' on page 20) or MHEG mode (UK only).

Display a single picture with Scenea

- 1 While watching TV, press **SCENEA**.
↳ The default Scenea picture is displayed on your TV.
- 2 Press any key except **⏻** (Standby-On) or **☐** **PICTURE** to return to normal TV viewing.

Personalize the Scenea picture

- 1 While the TV is on, connect the USB storage device containing your pictures (JPEG format only) to the USB connector at the side of your TV.
↳ The home menu appears. If the home menu does not appear, press **⬆** (**Home**).
- 2 Select **[Browse USB]**, then press **OK**.
↳ The USB content browser appears.
- 3 Press **▲▼◀▶** to navigate to the picture of your choice.
- 4 Press **SCENEA**.
↳ Your picture is stored as the default Scenea picture in your TV.
- 5 Disconnect the USB storage device. The device can be disconnected safely while the TV is on.
- 6 Follow the instructions to display your personalised Scenea picture (see 'Display a single picture with Scenea' on page 17).

Note

- The file size of the picture must be less than 1 MB.
- If the TV is reset to factory settings, your personalised Scenea picture is removed from the TV. Repeat these instructions to personalise the Scenea picture again.

Display a slideshow of pictures with Scenea

- 1 While the TV is on, connect the USB storage device containing your pictures (JPEG format only) to the USB connector at the side of your TV.
↳ The home menu appears.
- 2 Press **SCENEA**.
↳ All pictures in your USB storage device are displayed in a slideshow, starting from the default Scenea picture stored in your TV.
- 3 Press any key except **⏻** (**Standby-On**) or **PICTURE** to return to normal TV viewing.

Use sleeptimer with Scenea wallpaper

By default, your TV displays the Scenea picture or slideshow for 120 minutes before entering standby mode. If sleeptimer is enabled, the Scenea picture or slideshow is displayed for the duration of the sleeptimer (see 'Use timers' on page 15).

Use Eco mode with Scenea wallpaper

Using Eco mode with Scenea saves energy by lowering the TV brightness when a Scenea picture or a slideshow is displayed.

- 1 While a Scenea picture or slideshow is displayed, press **PICTURE**.
↳ The **[Eco mode]** menu appears.
- 2 Press **▶** to select **[On]**.
- 3 Press **OK**.
↳ Eco mode with Scenea is enabled.

Watch TV in dual view

You can use the DualView feature to display the TV channels and the input from a device with VGA or DVI connector (such as a computer or a satellite box) simultaneously on your TV.

- 1 Press **⬆** (**Home**).
- 2 Press **▲▼◀▶** to select **[Setup]** > **[Features]** > **[Dual View]**.
- 3 Press **OK** to activate **[Dual View]**.
↳ The main screen displays the input source from DVI or VGA.
↳ The auxiliary screen displays the last viewed TV channel.
- 4 Press **⬆** (**Home**) to exit dual view.

Note

- **[Dual View]** is available only when the TV is connected to a device, such as a PC, via a VGA or DVI connection.
- Connections via DVI or VGA require an additional audio cable (see 'Connect a computer' on page 30).
- When in Dual view mode, press **◀ +/-** to adjust volume in the main screen and press **P +/-** or **Numeric buttons** to switch between the TV channels in the auxiliary screen.

View photos and play music from a USB storage device



Caution

- Philips is not responsible if the USB storage device is not supported, nor is it responsible for damage or loss of data from the device.

Use the USB connector to view photos or listen to music stored on a USB storage device.

- 1 Turn on the TV.
- 2 Connect the USB device to the USB port on the side of your TV.
↳ The home menu appears.

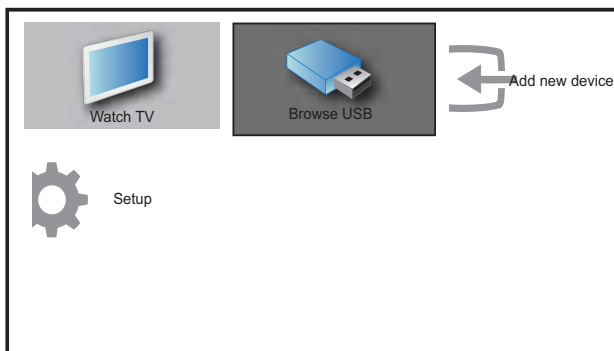

- 3 Press ▲▼◀▶ to select **[Browse USB]**.
- 4 Press **OK** to confirm.
↳ The USB thumbnail browser appears.



Tip

- Press **GUIDE** to switch between thumbnail and file browsing views.

View photos

- 1 In the USB content browser, select **[Picture]** and press ▶ to enter.
- 2 Press **GUIDE** to switch between thumbnail and file browsing views.
- 3 Press ▲▼◀▶ to select a photo or a photo album.
- 4 Press **OK** to view the selected photo in full screen mode.



Tip

- When in full screen mode, press ◀▶ to move between photos.

View a slide show of your photos

- 1 When a full screen image of a photo is displayed, press **OK** or ▶||.
↳ A slide show begins from the selected image.
- 2 Press:
 - **OK** or ▶|| to pause the slide show.
↳ The || icon appears.
 - Press ◀▶ or ▶▶ to move between images.
 - Press **BACK** or ■ to stop the slide show.

Change slide show settings

- 1 When viewing a slide show, press **OPTIONS**.
↳ The slide show options menu appears.
- 2 Press ▲▼ to select one of the following.
 - **[Start/Stop slide.]** Starts or stops a slide show.
 - **[Slideshow trans.]** Sets the transition from one picture to the next.
 - **[Slideshow freq.]** Sets the amount of time that a picture is shown.
 - **[Rotate image]** Rotates a picture.
 - **[Show info]** Displays the picture name, date, size and next picture in the slide show.
- 3 Press **OK** to confirm your setting.



Note

- **[Rotate image]** and **[Show info]** appear only when you press **OK** or ▶|| to pause the slideshow.

Listen to music

- 1 In the USB thumbnail browser view, select **[MUSIC]** and press **▶** to enter.
- 2 Press **▢ GUIDE** to switch between thumbnail and file browsing views.
- 3 Press **▲▼◀▶** to select music or a music album.
- 4 Press **OK** to play the selected music.

Music settings

When listening to music, press **≡ OPTIONS** to access one of the following music settings.

- **[Repeat]**
 - **[Play once]**
 - **[Repeat]**
 - **[Shuffle]**
- **[Show info]**

Disconnect a USB storage device



Caution

- Follow this procedure to avoid damage to your USB storage device.

- 1 Press **↶ BACK** to exit the USB browser.
- 2 Wait for five seconds before you disconnect the USB storage device.

Update the TV software

Philips continuously tries to improve its products and we recommend that you update the TV software when updates are available. Check www.philips.com/support for availability.

Check the current software version

- 1 Press **⬆ (Home)**.
- 2 Press **▲▼◀▶** to select **[Setup] > [Software update] > [Current software]**.
 - ↳ The TV displays the current software information.

Change TV preferences

- 1 Press **⬆ (Home)**.
- 2 Select **[Setup] > [Installation] > [Preferences]**.
- 3 Press **OK** or **▶** to enter **[Preferences]**.
 - **[Location]** Optimises TV settings for your location - home or shop.
 - **[Volume bar]** Displays the volume bar when you adjust the volume.
 - **[EasyLink]** Enables one-touch play and one-touch standby between EasyLink-compliant devices.
 - **[Pixel Plus Link]** Overrides the settings of connected devices and uses the settings of the TV. (Available only when **[EasyLink] > [On]** is selected).
 - **[Colour]** Sets the colour television standard used in your area. Select one of the following: **[SECAM]**, **[NTSC]**, **[AUTO]** or **[PAL]**.
 - **[E-sticker]** For shop mode only. Sets the location of the e-sticker.
- 4 Press **▲▼◀▶** to select your preference.
- 5 Press **OK**.
- 6 Press **⬆ (Home)** to exit.

Access decoder channel

You can map channels provided through a decoder or descrambler to your TV channel selection. In this way, you can select these channels by using the RC of your TV. The decoder or a descrambler must be connected to EXT1.

Set decoder channel

Map channels from a decoder or descrambler

- 1 Press **⬆ (Home)**.
- 2 Select **[Setup] > [Installation] > [Decoder]**.

- 3 Press ► to enter **[Decoder]**.
- 4 Press ► to enter **[Channel]**.
- 5 Press ▲▼ to select channel number to map to the decoder/descrambler channel.
- 6 Press OK.
- 7 Press ▲▼◀▶ to select and enter **[Status]**.
- 8 Press ▲▼ to select the connector used by the decoder/descrambler (**[None]** or **[EXT 1]**).
- 9 Press OK.
- 10 Press ⏠ (**Home**) to exit.

Note

- Select **[None]** if you do not want to map to the decoder/descrambler channel.

Start a TV demo

- 1 Press **DEMO** on the remote control.
- 2 Press ▲▼ to select a demo and press OK to view it.
- 3 Press **DEMO** to exit.

Reset the TV to factory settings

You can restore the default picture and sound settings of your TV. The channel installation settings remain the same.

- 1 Press ⏠ (**Home**).
- 2 Select **[Setup]** > **[Installation]** > **[Factory settings]**.
- 3 Press OK or ► to enter the **[Factory settings]** menu.
↳ **[Reset]** is highlighted.
- 4 Press OK to reset to factory settings.
- 5 Press ⏠ (**Home**) to exit.

6 Install channels

The first time you set up your TV, you are prompted to select a menu language and to install TV and digital radio channels (if available). This chapter provides instructions on how to re-install and fine tune channels.

Automatically install channels

This section describes how to search and store channels automatically.

Step 1 Select your menu language

Note

- Skip this step if your language settings are correct.

- 1 Press **Home**.
- 2 Press **▲▼◀▶** to select **[Setup]** > **[Installation]** > **[Language]** > **[Menu language]**.
- 3 Press **▶** to enter **[Menu language]**.
- 4 Press **▲▼** to select a language setting and then **OK** to confirm.

Picture	Menu language	English
Sound	Channel install.	Česky
Features	Preferences	Български
Installation	Decoder	Dansk
Software update	Factory setting	Deutsch
	Current software	Ελληνικά
		Español
		Français

- 5 Press **Home** to exit.

Step 2 Install Channels

Select your country for proper channel installation.

- 1 Press **Home**.
- 2 Press **▲▼◀▶** to select **[Setup]** > **[Installation]** > **[Channel install.]** > **[Channel assistant]**.

Picture	Menu language	Channel assistant
Sound	Channel install.	Analogue: Manual
Features	Preferences	
Installation	Decoder	
Software update	Factory setting	
	Current software	

- 3 Press **▲▼** to select your country and then **▶** to go to the next step.

Select your country	Austria
	Belgium
	Croatia
	Czech Republic
	Denmark
	Finland
	France
	Germany

- 4 Select **[Start]** and press **OK** to re-install channels.

1	Start automatic installation. This takes a few minutes.	3
	Start?	

↳ As the system searches for channels, you have the option to **[Stop]** the process.

- 5 To stop searching, select **[Stop]** and press **OK**.

↳ A dialogue box appears asking you if you really want to **[Stop]** or **[Continue]** with the process.

- 6 Press ◀▶ to select [Stop] or [Continue].
- 7 Press OK to confirm your choice.
- 8 When done, press ⬆ (Home) to exit.

Manually install channels

This section describes how to search and store analogue TV channels manually.

- 1 Press ⬆ (Home).
- 2 Press ▲▼◀▶ to select [Setup] > [Installation] > [Channel install.] > [Analogue: Manual].
↳ The [Analogue: Manual] menu appears.

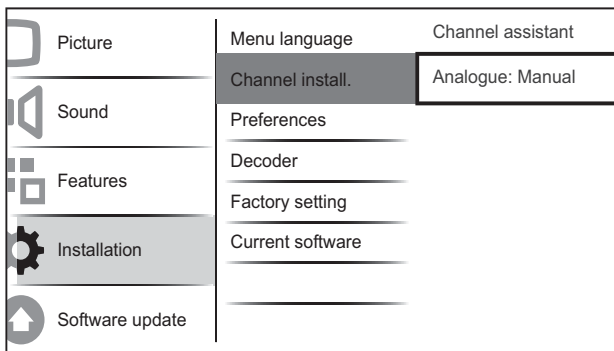

- 3 Press ▲▼ to select the item you want to adjust.
 - [System]
 - [Search]
 - [Channel number]
 - [Fine-tune]
 - [Store cur. chan.]
 - [Store new channel]
 - [Skip channel]

Select your system

Note

- Skip this step if your system settings are correct.

- 1 Press ⬆ (Home).
- 2 Press ▲▼◀▶ to select [Setup] > [Installation] > [Channel install.] > [Analogue: Manual].
↳ The [Analogue: Manual] menu appears.
- 3 Press ▲▼◀▶ to select and enter [System].
- 4 Press ▲▼ to select your country or region.
- 5 Press OK to confirm.
- 6 Press ⬆ (Home) to exit.

Search and store new TV channels

- 1 Press ⬆ (Home).
- 2 Press ▲▼◀▶ to select [Setup] > [Installation] > [Channel install.] > [Analogue: Manual].
↳ The [Analogue: Manual] menu appears.
- 3 Press ▲▼◀▶ to select and enter [Search].
- 4 Press **Numeric buttons** to manually enter the three-digit frequency.
- 5 Press OK to begin search.
↳ If a channel is unavailable at the selected frequency, the system searches for the next available channel.
- 6 Press ↩ BACK when the new channel is found.
- 7 Press ▲▼ to select [Store new channel] to store the new channel under a new channel number.
- 8 Press ▶ to enter [Store new channel].
- 9 Press OK to store the new channel.
- 10 Press ⬆ (Home) to exit.

Change the channel number

- 1 Press **⬆** (Home).
- 2 Press **▲▼◀▶** to select **[Setup]** > **[Installation]** > **[Channel install.]** > **[Analogue: Manual]**.
↳ The **[Analogue: Manual]** menu appears.
- 3 Press **▲▼◀▶** to select and enter **[Channel number]**.
↳ The screen displays the channel that you are watching.
- 4 Press **▲▼** to change the channel number.
- 5 Press **OK** to confirm.
- 6 Press **▲▼** to select **[Store new channel]** to store channel number.
- 7 Press **▶** to enter **[Store new channel]**.
- 8 Press **OK** to store the new channel.
- 9 Press **⬆** (Home) to exit.

Fine-tune analogue channels

- 1 Press **⬆** (Home).
- 2 Press **▲▼◀▶** to select **[Setup]** > **[Installation]** > **[Channel install.]** > **[Analogue: Manual]**.
↳ The **[Analogue: Manual]** menu appears.
- 3 Press **▲▼◀▶** to select and enter **[Fine-tune]**.
- 4 Press **▲▼** to adjust frequency.
- 5 Press **OK** to confirm.
- 6 Press **▲▼** to select **[Store cur. chan.]** to store channel number.
- 7 Press **▶** to enter **[Store cur. chan.]**.
- 8 Press **OK** to store the current channel.
- 9 Press **⬆** (Home) to exit.

Skip channels

- 1 Press **⬆** (Home).
- 2 Press **▲▼◀▶** to select **[Setup]** > **[Installation]** > **[Channel install.]** > **[Analogue: Manual]**.
↳ The **[Analogue: Manual]** menu appears.
- 3 Press **▲▼◀▶** to select and enter **[Skip channel]**.
- 4 Press **◀▶** to select **[Yes]** and press **OK** to skip current channel.
↳ The selected channel is skipped when you press **P +/-** on your remote control or view the channel grid.
- 5 Press **⬆** (Home) to exit.

Note

- You can restore a skipped channel to your channel listing.

Rename channels

You can rename channels. The name appears when you select the channel.

- 1 When watching TV, press **OK** to display the channel grid.
- 2 Select the channel you want to rename.
- 3 Press **☰** **OPTIONS**.
↳ The channel options menu appears.
- 4 Press **▲▼◀▶** to select and enter **[Rename chan.]**.
↳ A text input box appears.
- 5 Press **▲▼◀▶** to select characters.
- 6 Press **OK** to confirm each of the characters.

Tip

- Rename channels - a channel name can be up to six characters long.
- Press **[Aa]** to change an uppercase letter to a lowercase letter and vice versa.

Reorder channels

After you install channels, you can rearrange the order in which they appear:

- 1 When watching TV, press **OK** to display the channel grid.
- 2 Press **⏻** **OPTIONS**.
↳ The channel options menu appears.
- 3 Press **▲▼** to select **[Reorder]**, then press **OK**.
- 4 Select the channel to rearrange, then press **OK**.
↳ The selected channel is highlighted.
- 5 Press **▲▼◀▶** to move the highlighted channel to the desired location, then press **OK**.
- 6 Press **⏻** **OPTIONS**.
↳ **[Done reordering]** appears on the screen.
- 7 Press **OK** to confirm.
- 8 Press **⏪** **BACK** to exit the channel grid.

7 Connect devices

This section describes how to connect devices with different connectors. Examples are provided in the Quick Start.

Note

- You can use different types of connectors to connect a device to your TV.

Back connectors for 19-22 inch TV

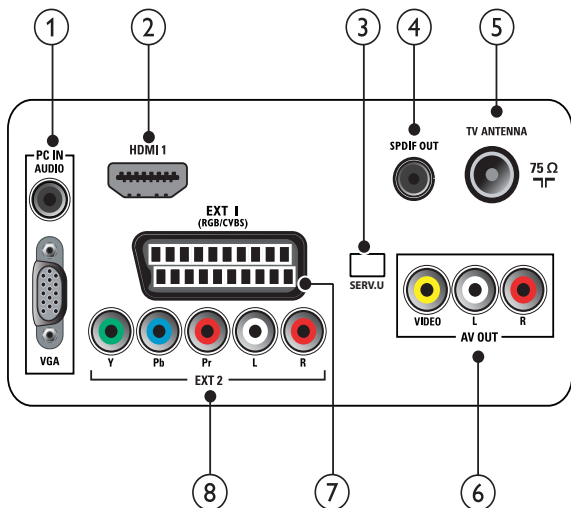

- PC IN (VGA and AUDIO IN)**
Audio and video input from a computer.

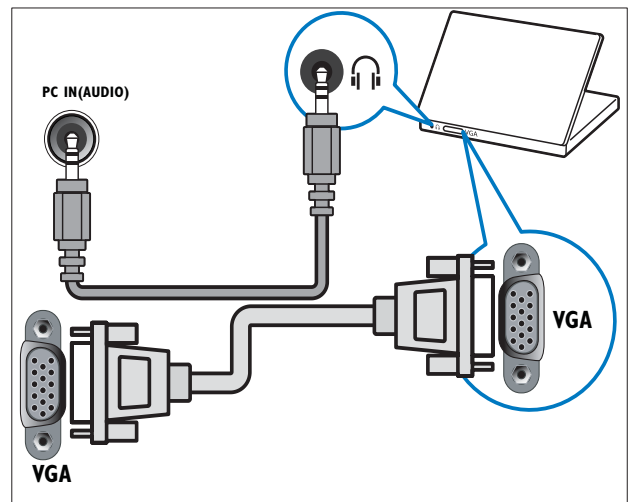

- HDMI 1**
Digital audio and video input from high-definition digital devices such as Blu-ray players.

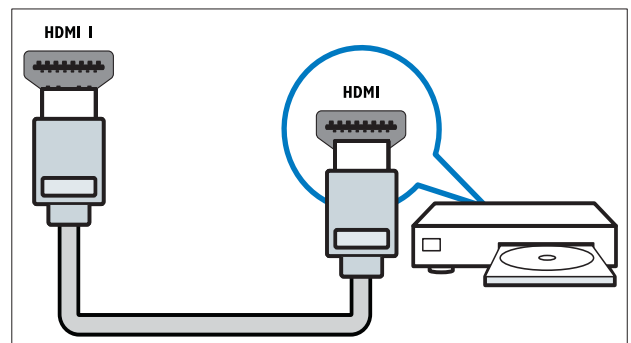

- SERV. U**
For use by service personnel only.
- SPDIF OUT**
Digital audio output to home theatres and other digital audio systems.

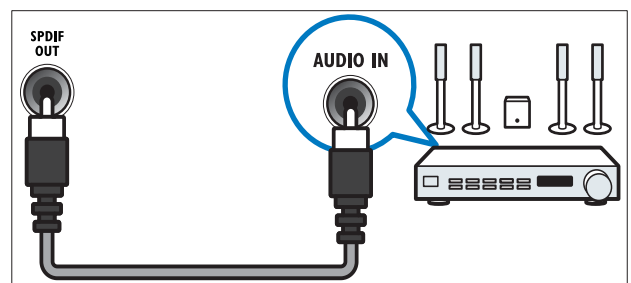

- TV ANTENNA**
Signal input from an antenna, cable or satellite.

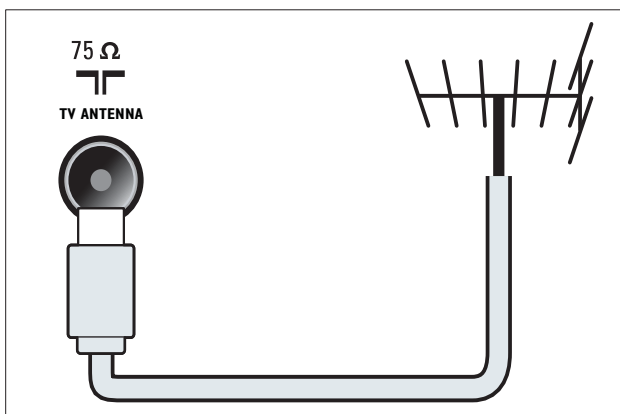

- 6 AV OUT (VIDEO OUT and AUDIO OUT L/R)
Audio and video output to analogue devices such as another TV or a recording device.

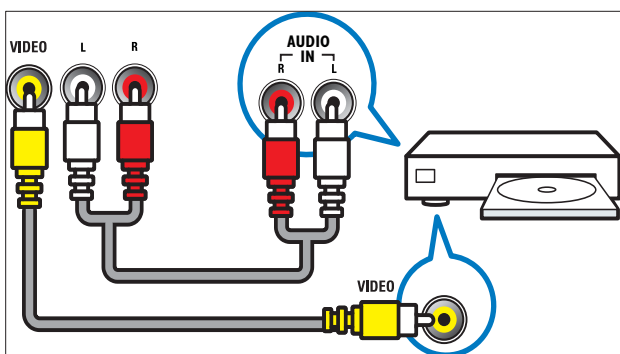

- 7 EXT 1 (RGB and CVBS)
Analogue audio and video input from analogue or digital devices such as DVD players or game consoles.

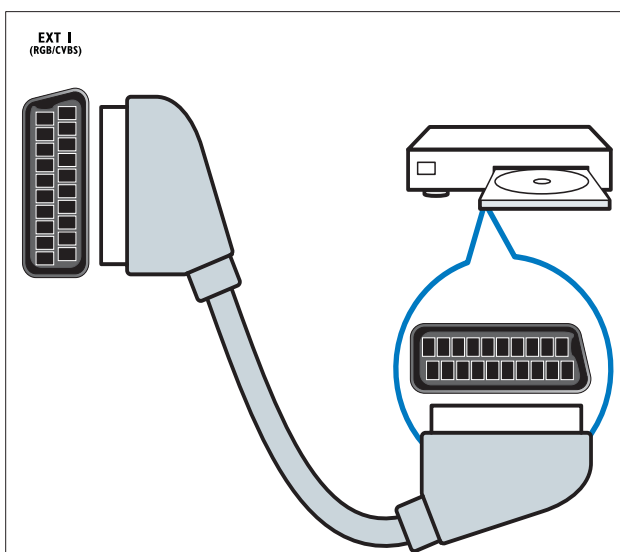

- 8 EXT 2 (Y Pb Pr and AUDIO L/R)
Analogue audio and video input from analogue or digital devices such as DVD players or game consoles.

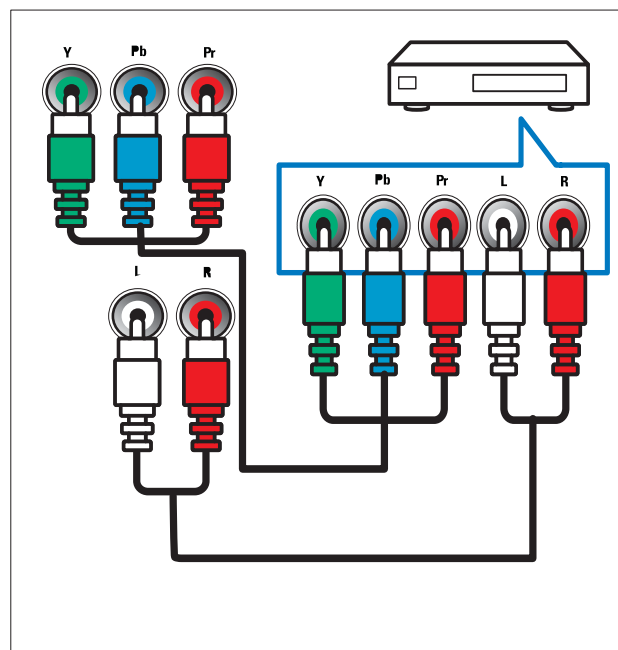

Back connectors for 26 inch and larger TV

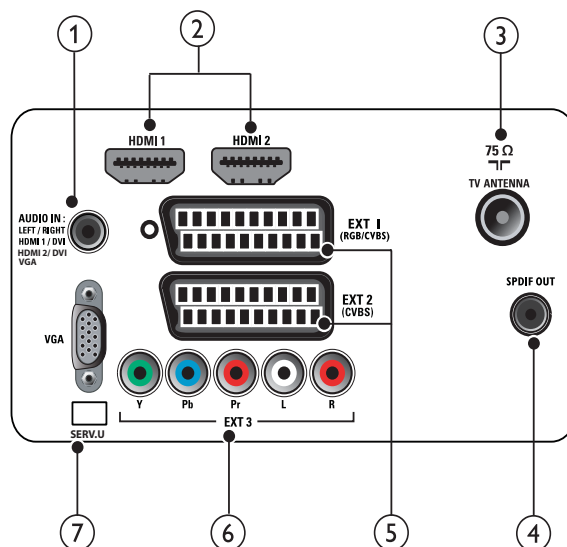

- 1 PC IN (VGA and AUDIO IN)
Audio and video input from a computer.

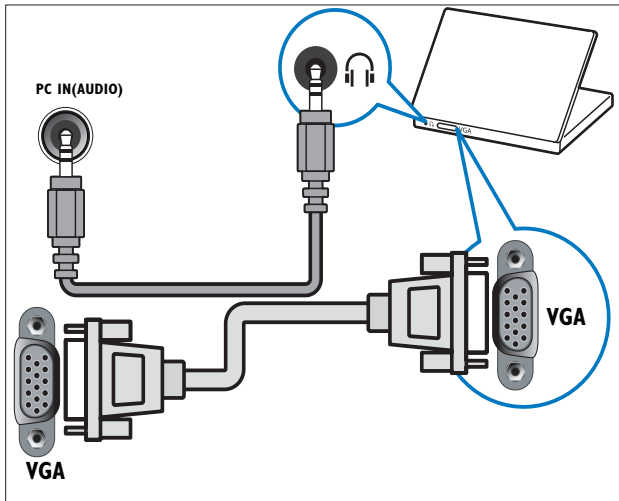

② HDMI 1/2

Digital audio and video input from high-definition digital devices such as Blu-ray players.

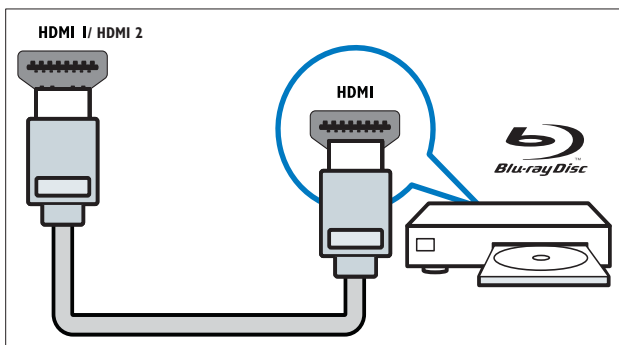

③ TV ANTENNA

Signal input from an antenna, cable or satellite.

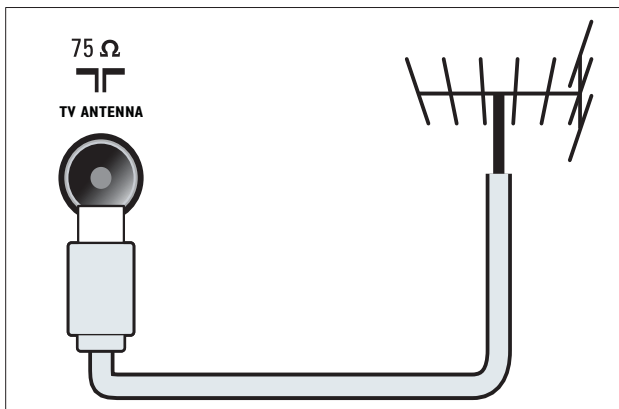

④ SPDIF OUT

Digital audio output to home theatres and other digital audio systems.

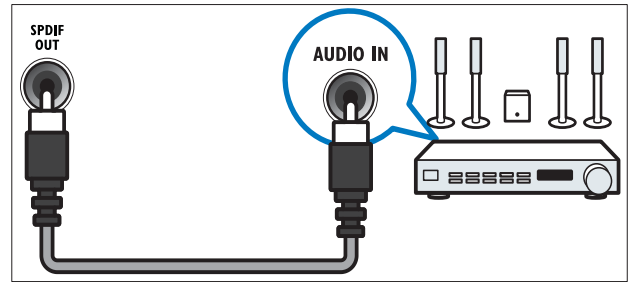

⑤ EXT 1 (RGB and CVBS) / CVBS (EXT 2)

Analogue audio and video input from analogue or digital devices such as DVD players or game consoles. EXT2 supports S-Video.

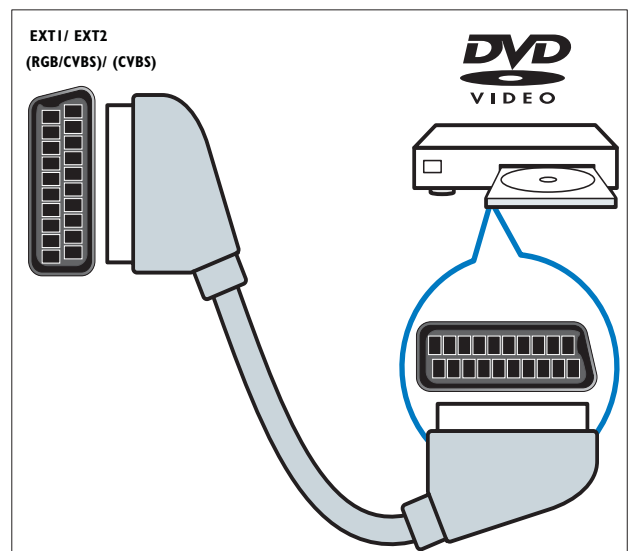

⑥ EXT 3 (Y Pb Pr and AUDIO L/R)

Analogue audio and video input from analogue or digital devices such as DVD players or game consoles.

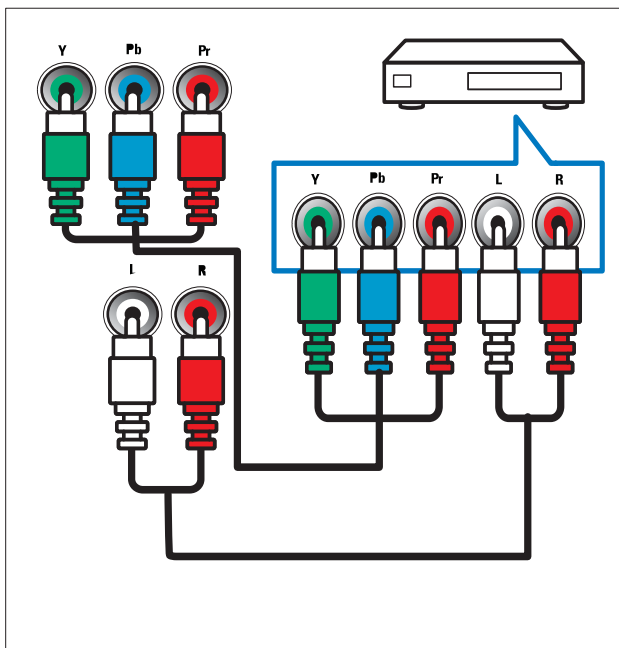

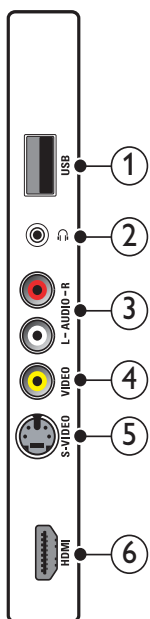

- ⑦ **SERV. U**
For use by service personnel only.

Side connectors

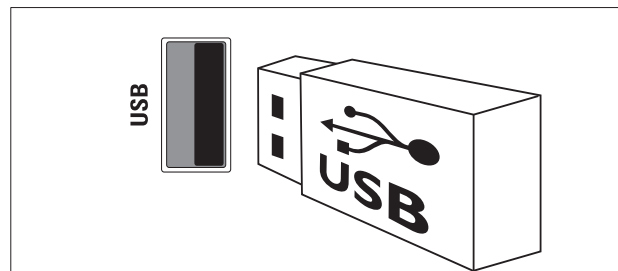

- ① **USB**
Data input from USB storage devices.



- ②  Stereo audio output to headphones or earphones.
- ③ **AUDIO L/R**
Audio input from analogue devices connected to **VIDEO**.

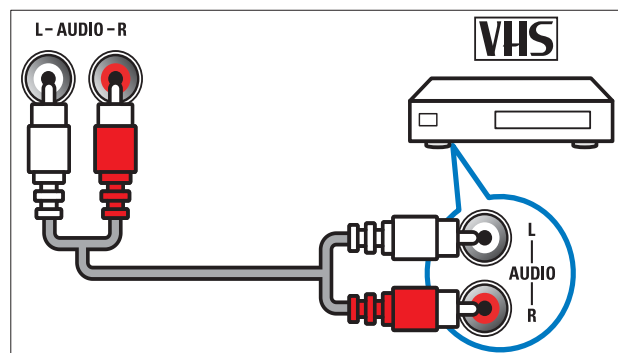

- ④ **VIDEO**
Composite video input from analogue devices such as VCRs.

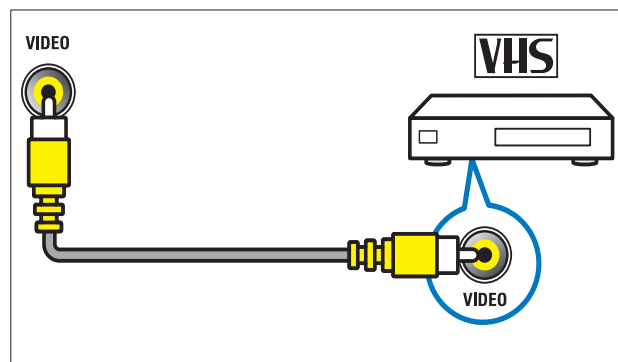

- ⑤ **S-VIDEO**
S-Video (side) to be used with Audio L/R connectors for camcorder, game console, etc. When you use the S-Video (side) for video signals, do not use the Composite video (side) input for video signals.

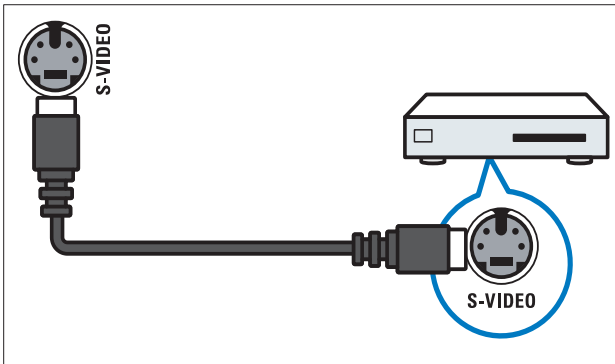

6 HDMI

Digital audio and video input from high-definition digital devices such as Blu-ray players.

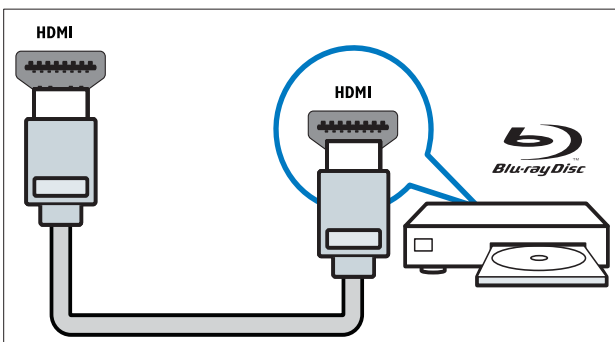

Connect a computer

Before you connect a computer to the TV

- Set the screen refresh rate on your computer to 60Hz.
- Select a supported screen resolution on your computer.

Connect a computer with one of the following connectors:

Note

- Connections via DVI or VGA require an additional audio cable.

- HDMI cable

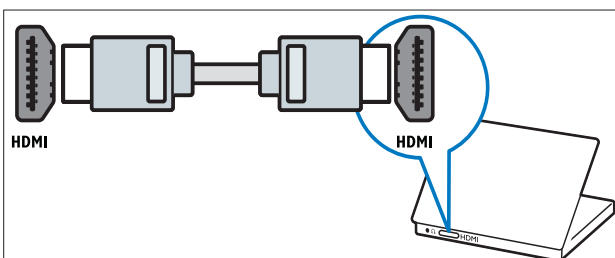

- DVI-HDMI cable

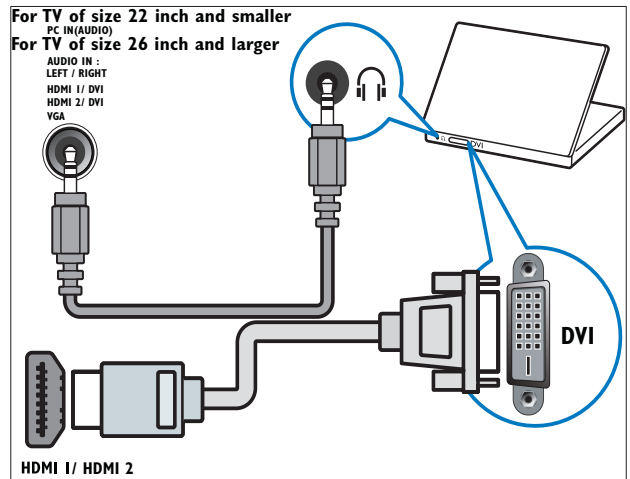

- HDMI cable and HDMI-DVI adaptor

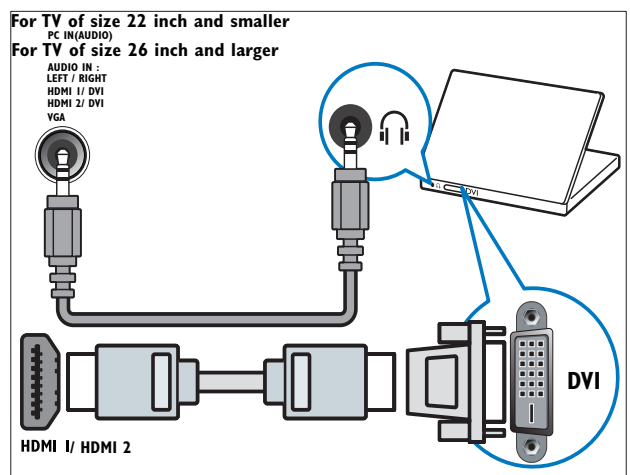

- VGA cable

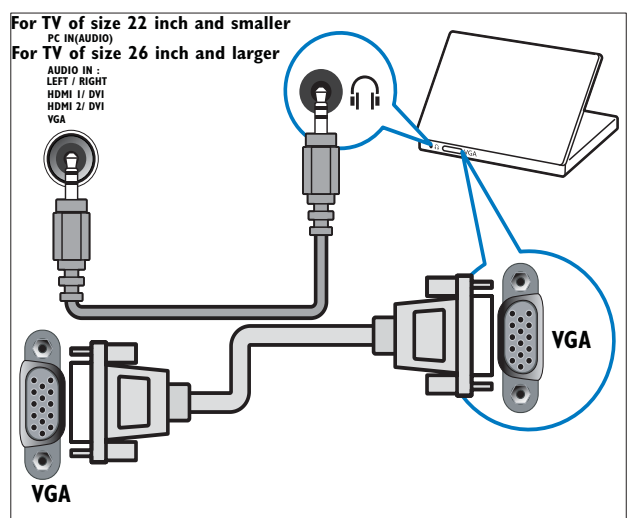

Use Philips EasyLink

Your TV supports Philips EasyLink, which uses the HDMI CEC (Consumer Electronics Control) protocol. EasyLink-compliant devices that are connected through HDMI connectors can be controlled by a single remote control.

Note

- The EasyLink-compliant device must be switched on and selected as the source.
- Philips does not guarantee 100% interoperability with all HDMI CEC devices.

EasyLink features

Your TV supports the following Easylink features :

- **One-touch play:** When you connect your TV to devices that support one-touch play, you can control your TV and the devices with one remote control. For example, when you press 'Play' on your DVD remote control, your TV automatically switches to the correct channel to show the DVD content.
- **One-touch standby:** When you connect your TV to devices that support standby, you can use your TV remote control to put your TV and all connected HDMI devices in standby mode.
- **System audio control (One-touch audio):** When you connect your TV to HDMI CEC compliant amplifier (such as, a Home theatre system or an AV receiver), your TV can switch automatically to play audio from the connected amplifier. To use one-touch audio, you must map the audio input from the connected amplifier to your TV. You can use the remote control of the connected amplifier or your TV to adjust the volume.
- **Remote control pass-through (RC key forwarding):** RC key forwarding allows you to control EasyLink-compliant devices using your TV remote control.
- **Pixel Plus Link:** Overrides the settings of connected devices and uses the settings of the TV.

Enable or disable EasyLink

Note

- Do not enable Philips EasyLink if you do not intend to use it.

- 1 Press **Home**.
- 2 Press **▲▼◀▶** to select **[Setup] > [Installation] > [Preferences] > [EasyLink]**.
- 3 Select **[On]** or **[Off]**.

Use one-touch play

- 1 After enabling EasyLink, press play on your device.
 - ↳ The TV automatically switches to the correct source.

Use one-touch standby

- 1 Press and hold **Standby** on the TV's or device's remote control for at least three seconds.
 - ↳ The TV and all connected HDMI devices switch to standby.

System audio control

When enabled, this feature automatically turns off TV speakers when content from an EasyLink-compliant home theatre system is played. Audio is played only from the amplifier's speakers such as home theatre system's speakers or AV receiver.

Note

- Follow the instructions in the user manual of the connected devices to map the audio input to your TV correctly (see 'Connect an amplifier' on page 32).

- 1 Enable one-touch play and one-touch standby between your Easylink compliant devices by following the instructions in the previous section (see 'Enable or disable EasyLink' on page 31).

- 2 Press **⬆** (Home).
- 3 Press **▲▼◀▶** to select **[Setup] > [Sound] > [TV speakers] > [Auto EasyLink]**.
 ↳ The TV speakers are turned off automatically when content from an Easylink compliant system is detected.
- 4 Press **▲▼◀▶** to select **[Setup] > [Sound] > [TV speakers] > [On]** to disable system audio control and enable the TV speakers.

☰ Note

- If you select **[TV speakers] > [Off]**, the TV speakers are muted.

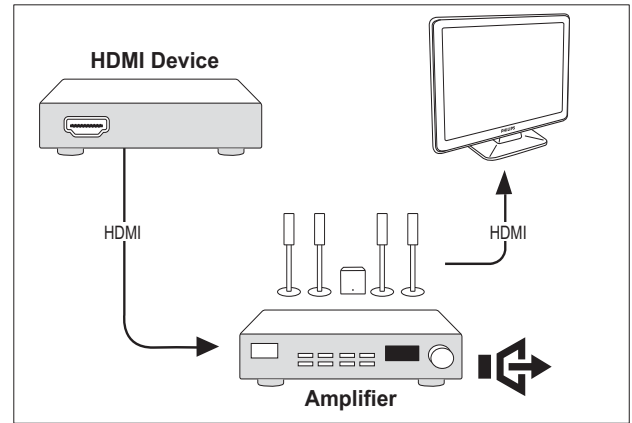

☰ Note

- You must map the audio input from the connected device to your TV in order to use this feature.

Connect an amplifier

An amplifier such as Home theatre System or AV receiver can be used to play audio from an Easylink compliant device connected to your TV.

An amplifier can be connected in the following different ways :

- An amplifier with only one HDMI output. Audio can be played by the amplifier from the device or TV.

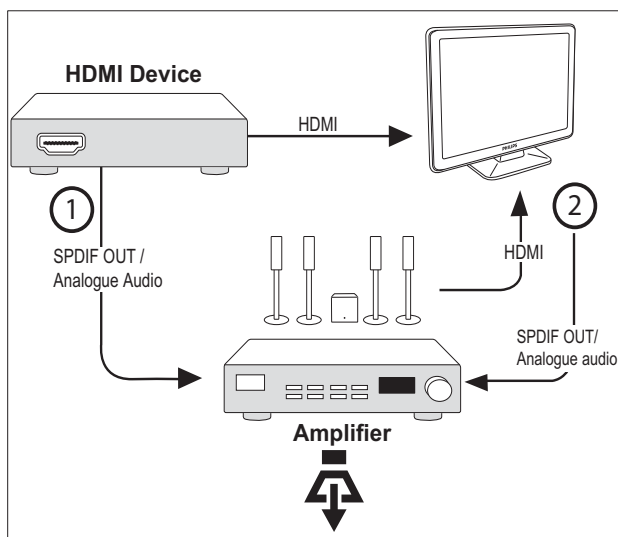

- Amplifier with one HDMI input and several HDMI outputs. Audio can be played by the amplifier via HDMI connector from your device.

Enable remote control pass-through

- 1 Enable one-touch play and one-touch standby between easylink compliant devices by following the instructions in the previous section (see 'Enable or disable EasyLink' on page 31).
- 2 Press **⬆** (Home).
- 3 Press **▲▼◀▶** to select a device with HDMI connector from your home menu.
- 4 Press **☰** **OPTIONS**.
- 5 Press **▲▼** to select **[Enable RC pass]** and press **OK**.
 ↳ RC pass-through is enabled on the selected device.

☰ Note

- Easylink compliant device must be connected to the TV via HDMI connector.

Disable remote control pass-through

- 1 Enable one-touch play and one-touch standby between easylink compliant devices by following the instructions in the previous section (see 'Enable or disable EasyLink' on page 31).
- 2 Press **⬆** (**Home**).
- 3 Press **▲▼◀▶** to select a device with HDMI connector from your home menu.
- 4 Press **☰** **OPTIONS**.
- 5 Press **▲▼** to select **[Disable RC pass]** and press **OK**.
 - ↳ RC pass-through is disabled on the selected device.

Note

- Easylink compliant device must be connected to the TV via HDMI connector.

Access menu after enabling RC pass-through

- 1 Enable remote control pass-through by following the instructions in the previous section.
- 2 Press **▲▼◀▶** to select a device that has been enabled to support RC pass-through and press **OK** to enter.
- 3 Press **☰** **OPTIONS** to access one of the following menus for TV or the active device connected to the TV:
 - **[TV setup]**Accesses menus to change picture, sound and other settings.
 - **[Clock]**Displays the clock on the TV screen.
 - **[TV speakers]**Turns TV speakers on or off. Setting TV speakers to automatic mode turns off the speakers when content from an EasyLink-compliant home theatre system is detected.

- **[Dev. root menu]**Accesses the root menu of the CD/DVD/game disc.
 - **[Device setup menu]**Accesses the main menu of the connected device such as DVD player, HDD recorder, or game console.
 - **[Dev. content menu]**Accesses the content menu of the CD/DVD/game disc.
- 4 Press **OK** to enter or activate your selection.

Use a Kensington lock

There is a Kensington security slot at the back of the TV. Prevent theft by looping a Kensington lock between the slot and a permanent object, such as a heavy table.

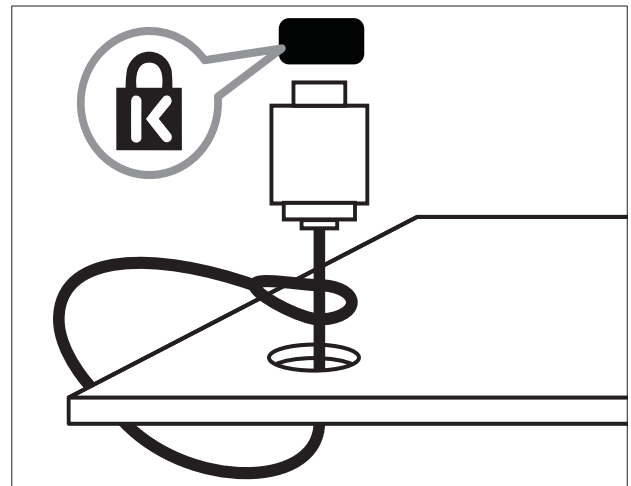

8 Product information

Product information is subject to change without notice. For detailed product information, go to www.philips.com/support.

Supported display resolutions

Computer formats

- Resolution - refresh rate:
 - 640 × 480 - 60Hz
 - 800 × 600 - 60Hz
 - 1024 × 768 - 60Hz
 - 1280 × 720 - 60Hz
 - 1280 × 768 - 60Hz
 - 1280 × 1024 - 60 Hz
 - 1360 × 768 - 60Hz
 - 1440 × 900 - 60Hz
 - 1680 × 1050 - 60Hz
 - Via HDMI/DVI input

Video formats

- Resolution - refresh rate:
 - 480i - 60Hz
 - 480p - 60Hz
 - 576i - 50Hz
 - 576p - 50Hz
 - 720p - 50Hz, 60Hz
 - 1080i - 50Hz, 60Hz
 - 1080p - 24Hz, 25Hz, 30Hz, 50Hz, 60Hz.

Multimedia

- Supported storage device: USB (Only FAT or FAT 32 USB storage devices are supported)
- Supported multimedia file formats:
 - Images: JPEG
 - Audio: MP3



Note

- Multimedia file names must not exceed 32 characters.

Tuner/Reception/Transmission

- Aerial input: 75ohm coaxial (IEC75)
- TV system: PAL I, B/G, D/K; SECAM B/G, D/K, L/L'
- Video playback: NTSC, SECAM, PAL
- Tuner Bands: Hyperband, S-channel, UHF, VHF

Remote control

- Type: PF02E09B
- Batteries: 2 × AAA (LR03 type)

Power

- Mains power: 220-240V, 50Hz
- Standby power: <0.15W
- Ambient temperature: 5 to 40 degrees Celsius

Supported TV mounts

To mount the TV, purchase a Philips TV mount or a VESA-compatible TV mount. To prevent damage to cables and connectors, be sure to leave a clearance of at least 2.2 inches or 5.5cm from the back of the TV.



Warning

- Follow all instructions provided with the TV mount. Koninklijke Philips Electronics N.V. bears no responsibility for improper TV mounting that results in accident, injury or damage.

TV screen size (inches)	Required pitch (mm)	Required mounting bolts
19	75 × 75	4 × M4
22	100 × 100	4 × M4
26	200 × 100	6 × M4
32	200 × 200	4 × M6
42	400 × 400	4 × M6

9 Troubleshooting

This section describes commonly encountered issues and accompanying solutions.

General TV issues

The TV does not switch on:

- Disconnect the power cable from the power outlet. Wait for one minute then reconnect it.
- Check that the power cable is securely connected.

The remote control is not working properly:

- Check that the remote control batteries are correctly inserted according to the +/- orientation.
- Replace the remote control batteries if they are flat or weak.
- Clean the remote control and TV sensor lens.

The standby light on the TV blinks red:

- Disconnect the power cable from the power outlet. Wait until the TV cools down before reconnecting the power cable. If the blinking reoccurs, contact Philips Consumer Care.

You forgot the code to unlock the TV lock feature

- Enter '8888'.

The TV menu is in the wrong language.

- Change the TV menu to your preferred language.

When turning the TV on/off/to standby, you hear a creaking sound from the TV chassis:

- No action is required. The creaking sound is normal expansion and contraction of the TV as it cools down and warms up. This does not impact performance.

TV channel issues

Previously installed channels do not appear in the channel list:

- Check that the correct channel list is selected.

Picture issues

The TV is on, but there is no picture:

- Check that the antenna is properly connected to the TV.
- Check that the correct device is selected as the TV source.

There is sound but no picture:

- Check that the picture settings are correctly set.

There is poor TV reception from an antenna connection:

- Check that the antenna is properly connected to the TV.
- Loudspeakers, unearthed audio devices, neon lights, high buildings and other large objects can influence reception quality. If possible, try to improve the reception quality by changing the antenna direction or moving devices away from the TV.
- If reception on only one channel is poor, fine tune this channel.

There is poor picture quality from connected devices:

- Check that the devices are connected properly.
- Check that the picture settings are correctly set.

The TV did not save your picture settings:

- Check that the TV location is set to the home setting. This mode offers you the flexibility to change and save settings.

The picture does not fit the screen; it is too big or too small:

- Try using a different picture format.

The picture position is incorrect:

- Picture signals from some devices may not fit the screen correctly. Check the signal output of the device.

Sound issues

There is a picture but sound quality is poor:

Note

- If no audio signal is detected, the TV automatically switches the audio output off — this does not indicate malfunction.

- Check that all cables are properly connected.
- Check that the volume is not set to 0.
- Check that the sound is not muted.

There is a picture but the sound quality is poor:

- Check that the sound settings are correctly set.

There is a picture but sound comes from one speaker only:

- Verify that sound balance is set to the centre.

HDMI connection issues

There are problems with HDMI devices:

- Note that HDCP (High-bandwidth Digital Content Protection) support can delay the time taken for a TV to display content from a HDMI device.
- If the TV does not recognize the HDMI device and no picture is displayed, try switching the source from one device to another and back again.
- If there are intermittent sound disruptions, check that output settings from the HDMI device are correct.
- If you use an HDMI-to-DVI adapter or HDMI to DVI cable, check that an additional audio cable is connected to **AUDIO L/R** or **AUDIO IN** (mini-jack only).

Computer connection issues

The computer display on the TV is not stable:

- Check that your PC uses the supported resolution and refresh rate.
- Set the TV picture format to unscaled.

Contact us

If you cannot resolve your problem, refer to the FAQs for this product at www.philips.com/support.

If the problem remains unresolved, contact Philips Consumer Care in your country as listed in the Addendum.



Warning

- Do not attempt to repair the product yourself. This may cause severe injury, irreparable damage to your product or void your warranty.



Note

- Make a note of your TV model and serial number before you contact Philips. These numbers are printed on the back of the TV and on the packaging.

10 Index

A

antenna

B

bracket for wall mount 35

C

channel list

favourite 14
troubleshooting 36

Channels

favourite list 14
install
 automatic 22
 manual 23
rename 24
reorder 25
tune 24

child lock

TV lock 17

Clock

17

computer

technical specifications 34

Connections

HDMI
 troubleshooting 37
overview 26
PC 37, 30
technical specifications 34
troubleshooting 37

connectors

overview 26

D

demo 21

devices

add to home menu 11
connect 26
watch 10

Digital channel

digital services

teletext 10, 14

display

resolution 34

Dual view

18

E

EasyLink

disable 31
enable 31
one-touch play 31
one-touch standby 31
system audio control 31, 31

Electronic Programme Guide

environmental care 5

F

factory settings

21

favourites list

create list 14
view list 14

H

HDMI

troubleshooting 37

home mode

20

I

install channels

automatic 22
manual 23

K

Kensington lock

33

L

location

20

lock

Kensington 33
TV lock 17

M	
menu	
main menu	11
teletext	14
MPEG artifact reduction	12
Multimedia	
technical specifications	34
music	
USB	20

O	
on timer	16, 15
One-touch play	31
One-touch standby	31

P	
PC	
pc connection	30
picture format	
change	12
troubleshooting	36
picture settings	11
PIN code	16
power	34

R	
reception	36
remote control	
batteries	34, 5
overview	7
RC pass-through	31
technical specifications	34

S	
settings	
picture	11, 12
sound	13, 11
settings assistant	11
shop mode	20
smart settings	12, 13
software	
version	20
sound settings	13, 13

T	
Table of Pages	14
technical specifications	34
teletext	
features	14
menu	14
subpages	14
Table of Pages	14
timer	
on timer	15, 16
Sleep timer	15
standby	15
troubleshooting	36
TV	
adjust volume	10
as PC monitor	30
menu	11
pc connection	30
preferences	20
screen care	5
software	20
standby	9
switch channels	9
switch off	9
switch on	9
troubleshooting	36
tuner technical specifications	34
wall mount	35
TV lock	
lock channels	17
lock connected devices	17
PIN code	16

U	
USB	
listen to music	20
view photos	19

V	
video format	
technical specifications	34
volume	
adjust	10
automatic levelling	13
delta	13
mute	10

Free Manuals Download Website

<http://myh66.com>

<http://usermanuals.us>

<http://www.somanuals.com>

<http://www.4manuals.cc>

<http://www.manual-lib.com>

<http://www.404manual.com>

<http://www.luxmanual.com>

<http://aubethermostatmanual.com>

Golf course search by state

<http://golfingnear.com>

Email search by domain

<http://emailbydomain.com>

Auto manuals search

<http://auto.somanuals.com>

TV manuals search

<http://tv.somanuals.com>