

DPM 9350/00

User Manual
International Edition



PHILIPS

VERSION

DPM 9350/00 (International edition/English) - 08/2003

COPYRIGHT

© 2003 Philips Speech Processing

All rights reserved. Reproduction in whole or in part is prohibited without the written consent of the copyright owner. Information in this manual is subject to change without notice.

TRADEMARKS



Pocket Memo[®] is a registered trademark of Philips.

Windows 98 SE, Windows Me, Windows 2000, Windows NT 4.0 and Windows XP are registered trademarks of Microsoft Corporation. All other names are trademarks, registered trademarks or service marks of their respective owners.

DISCLAIMER AND NOTICES

Philips Speech Processing has carried out extensive testing with most popular configurations. However, since PC add-ons and device drivers change very rapidly, we are unable to guarantee conflict-free operation.

 The CE mark confirms that the device corresponds to the relevant guidelines of the European Union. This manual has been printed on chlorine-free, recycled paper, in line with the highest standards of environmental friendliness. The cardboard used for packaging can be recycled. This electronic facility contains recyclable material.

Technical changes and errors excepted.

Table of Contents

Chapter 1: Introduction	1
DPM features.....	1
Package contents	2
Chapter 2: Introducing the DPM	3
DPM graphic.....	3
LCD display	7
Batteries	8
Chapter 3: Getting Started.....	10
Activating the DPM	10
Memory card.....	11
Start screen	13
DPM menu	16
Power Save mode	28
Chapter 4: Basic Operations	29
Recording	29
Finishing a dictation (EOL and Priority)	32
Recording mode (Insert/Overwrite).....	34
Playback	35
Fast Forward and Fast Rewind.....	36
Deleting	37
Recording format (Standard Play/Long Play)	39
Voice-activated recording	40
Skip Forward and Skip Back	41
Chapter 5: Advanced Operations	42
Assigning Keywords	42
Transferring data between DPM and PC.....	45
Appendix: Troubleshooting the DPM	47
Index.....	48

Chapter 1: Introduction

The DPM 9350/00 (Digital Pocket Memo) has been designed to offer optimum user convenience and greater efficiency for your daily work. This manual provides a comprehensive overview of all the device's features and detailed instructions on how to operate the device.

DPM features

- The DPM 9350/00 is a state-of-the-art digital voice recorder for the professional user.
- Digital recording allows instant access to any point in the dictation and enables you to make precise deletions from sound files and to correctly place insertions.
- The DPM 9350/00 provides workflow management capabilities for easy transfer of files to the PC.
- 4-Position Switch for single-handed operation and ease-of-use.
- User-defined information (Keywords) can be stored with the sound file.
- USB connection for simple data transfer between the device and the PC.
- Ergonomic design.
- High-resolution LCD display with backlight.

Package contents

- DPM 9350/00 - the digital voice recorder for the professional user.
- Philips MMC 9016 - memory card with a 16 MB storage capacity.
- Installation CD for the DPM Download/Configuration program for Windows 98 SE, Windows Me, Windows NT 4.0, Windows 2000 and Windows XP.
- A leather pouch.
- 2 Philips AAA batteries.
- A USB cable.
- *DPM 9350/00 User Manual, DPM 9350/00 Quick Reference*

Accessories available from your vendor

- Power Supply LFH 9145
- DPM Docking Station 9110
- Rechargeable batteries LFH 9144

For more information about Philips, Philips Speech Processing and the available products, go to:

www.philips.com

www.dictation.philips.com

Chapter 2: Introducing the DPM

This chapter introduces the DPM 9350/00.

DPM graphic

The following graphics show the device and the names of the various parts.

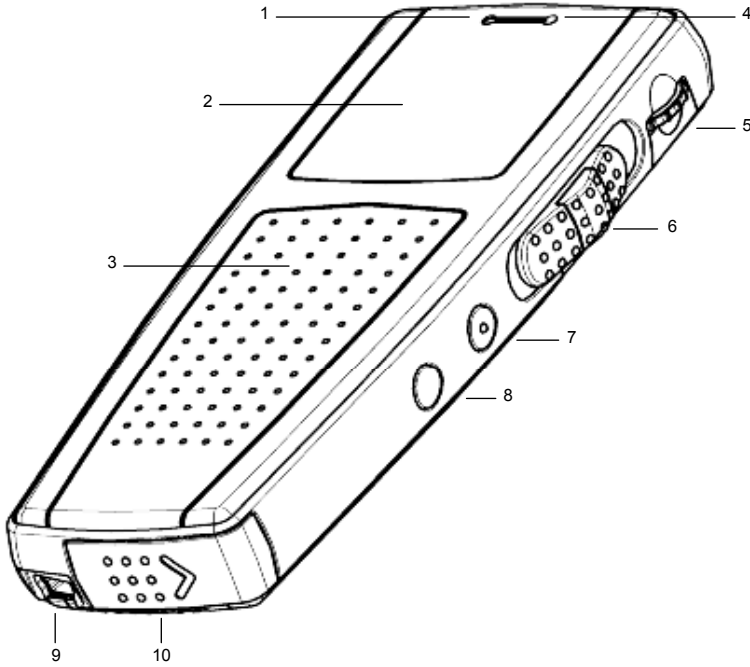



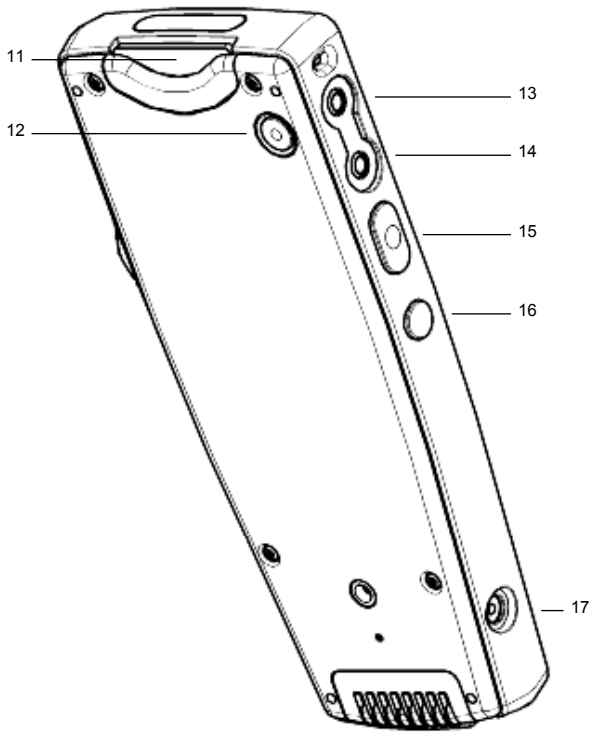

















- 1 Record LED
- 2 LCD display
- 3 Built-in loudspeaker
- 4 Built-in microphone
- 5 Jog Dial (for volume control, Skip Forward and Skip Back, accessing the DPM menu, moving between menu entries and confirming selections)
- 6 4-Position Switch (positions from top to bottom: Fast Forward, Play, Stop and Fast Rewind) with Lock/Hold switch functionality
- 7 INS/OVR button (for switching between Insert and Overwrite mode)
- 8 DEL button (Delete)
- 9 USB socket
- 10 Battery compartment



- 11 Memory card slot
- 12 L/P button (for assigning the End-of-Letter attribute and Priority)
- 13 MIC (microphone socket)
- 14 EAR (earphone socket)
- 15 REC button (Record)
- 16 DL/S button (for PC download)
- 17 Power supply socket (for Philips LFH 9145)

LCD display

The DPM 9350/00 has a high-quality graphical LCD display. You will see the following symbols:

	Standard Play mode		Long Play mode
	AM symbol (hours before noon)		PM symbol (hours after noon)
	Fast Rewind		Fast Forward
	Recording		Record Standby
	Stop		Playback
	Voice-activated recording		
	EOL (End-of-Letter)		Priority
	Write-protected SD card		Insert mode
	Batteries: 100%		Batteries: 80%
	Batteries: 60%		Batteries: 40%
	Batteries: 20%		Batteries: empty



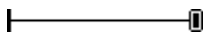
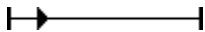
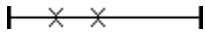
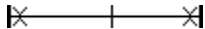



The status indication bar may appear as follows (note that the following overview only lists the most common displays of the status indication bar):

	A dictation is being recorded.
	A sound file is being played back.
	A section of the sound file is marked for deletion.
	The whole sound file is marked for deletion.

Batteries

The DPM 9350/00 can be operated with the two standard AAA alkaline batteries delivered with the product. You can also use rechargeable Philips NiMH batteries (LFH 9144). For recharging the batteries, only use the power supply LFH 9145; it can also be used for running the DPM from the mains power supply.

The power indicator on the display may appear as follows:

-  The batteries are full (100%).
-  4/5 of the battery power is available (80%).
-  3/5 of the battery power available (60%).
-  2/5 of the battery power available (40%).
-  1/5 of the battery power available (20%).
-  The batteries are empty and should be replaced.

If the batteries are dangerously low and should be replaced or recharged, this symbol is displayed:



Note: If the power level in the batteries drops below 2.0 V, no recording or playback is possible.

Recharging batteries

The DPM can be operated with the rechargeable Philips NiMH batteries LFH 9144. For recharging these batteries, either use the DPM Docking Station 9110 or the Philips power supply LFH 9145.

For more information about recharging the batteries with the DPM Docking Station 9110, refer to the documentation delivered with the product.



When recharging the batteries with the Philips power supply LFH 9145, note the following:

There are two ways to recharge the batteries.

- **Fast recharge:** Connect the Philips power supply LFH 9145 to the mains power supply before deactivating the DPM via the Lock/Hold switch. Deactivating the DPM starts the recharging process.



Important: The DPM can become quite warm during fast recharging.

- **Slow recharge:** The DPM can be connected to the mains power supply with the Philips power supply LFH 9145 at any time, even when recording dictations. The batteries will recharge, but at a slower rate.

The recharging process is indicated on the DPM display with these alternating symbols:  and .

When recharging is finished, only the symbol for full battery power is displayed:



Note: When working with standard rechargeable batteries, the DPM only displays the symbol for 80% battery power () even if the batteries have been fully recharged. The symbol for 100% battery power () is only displayed when completely new standard batteries (not rechargeable) are inserted or when the DPM is run from the mains power supply.

Chapter 3: Getting Started

This chapter provides an introduction to the basic functions of the DPM 9350/00:

- Activating the DPM
- Memory card
- Start screen
- DPM menu
- Power Save mode

Activating the DPM

The DPM can be turned on and off via the Lock/Hold switch. If the device is locked, it is not possible to use any of the DPM buttons and none of the buttons can be pressed accidentally.

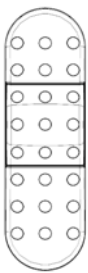

The device is unlocked.

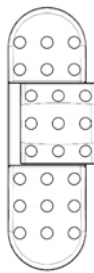

The device is locked.

When you work with the DPM for the first time, insert the batteries and unlock the Lock/Hold switch. The device is now operational and you can insert the memory card.

For activating the device when it has already been in use, there are the following options:

- If the Lock/Hold switch was activated, unlock the device.
- If the device has gone into Power Save mode (the device has been left inactive for more than 4 minutes), activate the device by pressing any button or by moving the 4-Position Switch.
- If the DPM has been left inactive for more than 2 hours, it is automatically turned off. In this case, it can only be turned on via the Lock/Hold switch (OFF-ON functionality).

Memory card

The DPM 9350/00 operates with a memory card of the type MMC or SD. The DPM supports MMC and SD cards of all storage capacities. It is delivered with a 16 MB memory card of the type MMC. This card supports about 156 minutes of recording time in Standard Play mode or 234 minutes of recording time in Long Play mode.

If there is no memory card inserted into the DPM, this screen is displayed:



After inserting the memory card, one of the following screens will be displayed:

- If the memory card is new and has not been formatted, a confirmation dialog for formatting the memory card is displayed; for more information, see below.
- If the memory card has been in use before, a start screen with the information stored on the memory card is displayed.

Formatting the memory card

When you insert a new, unformatted memory card, the following screen is displayed:



To confirm and start the formatting process, press the DEL button for at least 2 seconds. If you want to cancel the formatting process, either remove the memory card or move the 4-Position Switch.

Note: The memory card delivered with your DPM 9350/00 has already been preformatted.

Important: Any memory card used with the DPM should be formatted by the DPM itself and not any other device.

For more information about reformatting the memory card, refer to the corresponding section in the *DPM menu* chapter in this manual.

Full memory card

If only 2 minutes of recording time are left on the memory card, the remaining time on the DPM display will start to blink. When the memory card is full, a warning is displayed and the device beeps; recording stops.

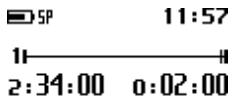

Start screen

After the memory card has been inserted or the DPM is turned on, a start screen is displayed. This screen is identical to the screen which is displayed when the DPM is in Stop mode.

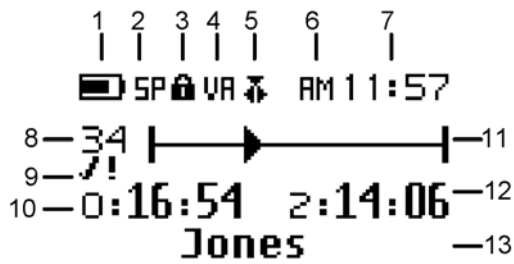

Note: The screen above is a fictional screen with the maximum number of symbols which could appear.

- 1 Battery power.
- 2 Recording format: Standard Play or Long Play.
- 3 Write-protected SD memory card.
- 4 Voice-activated recording mode is enabled.
- 5 Insert mode is activated.
- 6 AM (or PM) symbol if the US time format is used.
- 7 Current time in HH:MM (hours:minutes).

- 8 Current file number. The current file will always be the last file you worked on. If you do not jump to a different file, this file will be opened automatically.
- 9 EOL (End-of-Letter) indication and Priority assignment.
- 10 Recording or playback time of the current dictation.
- 11 Status indication bar which provides a graphical display for the space left on the memory card. When recording, playback, winding etc. is done in the sound file, this bar displays the corresponding symbols and actions.
- 12 Remaining recording time on the memory card depending on the setting for the recording mode (Standard Play or Long Play).
- 13 The current Keyword 1 assignment.

If you inserted and formatted a new memory card, moving the Jog Dial (Skip Forward) or pressing the REC button will automatically generate a new file. After a file has been created by pressing the REC button, the DPM is already in Record Standby mode.

DPM display options

The appearance of the DPM display depends on the corresponding setting (**Standard display** and **Advanced display** options) in the DPM Download/Configuration program. For more information, refer to the *DPM Download/Configuration Online Help*.

The **Standard display** option uses larger symbols without showing the status indication bar:

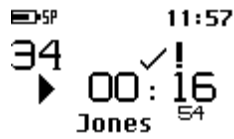

The **Advanced display** option uses smaller symbols. It enables to view more information about the current dictation and shows the status indication bar. This bar provides visual feedback when a dictation, for example, is recorded or played back.

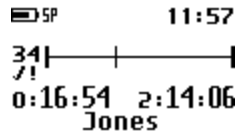

DPM menu

The DPM 9350/00 comes with a menu which provides the following options:

- Assigning Keywords
- Setting the date and time
- Setting the recording format
- Enabling and disabling the DPM device beep
- Setting the microphone sensitivity
- Voice-activated recording
- Backlight on/off
- Changing the contrast
- Displaying the remaining time
- Reformatting the memory card

Note: The setting for the DPM display appearance (**Standard display** and **Advanced display** options) can only be made via the DPM Download/Configuration program.

Accessing the DPM menu

You can access the DPM menu by pressing the Jog Dial for about 2 seconds. The DPM menu can only be accessed when the DPM is in Stop mode.

- To move between the DPM menu entries, move the Jog Dial up or down:

- To select a menu entry, for example the date and time setting, go to this menu entry by moving the Jog Dial up or down. Then press the Jog Dial to confirm the selection. This enables you to access the menu entry and change the settings for it. Confirm the changes by pressing the Jog Dial; this returns you to the DPM main menu.

To exit a menu entry selection without confirming the changes, press the DEL button on the DPM. This exits the DPM main menu and discards any changes.

Note: If no menu entry selection is made within 10 seconds, the DPM automatically exits the DPM menu and goes back into Stop mode.

To exit the DPM menu, do one of the following:

- Select the menu entry for exiting the DPM menu and confirm the selection by pressing the Jog Dial: 
- Press the DEL button.

Assigning Keywords

If Keywords have been defined for the DPM with the DPM Download/Configuration program, the menu entry for assigning a Keyword is always displayed first when you access the DPM menu:

```
AUTHOR:
  Jones
  +
  OK ← [Jog Dial]
```

This is an example screen for a Keyword menu entry which has been defined as follows: usage = Author, content = a selection of author names; the current Keyword assignment is the author name Jones. When you confirm the menu entry selection by pressing the Jog Dial, the list of all defined author names is displayed. For more information about assigning DPM Keywords, refer to the chapter *Assigning Keywords* in this manual.

Note: If no Keywords are defined, the menu selection starts with the menu entry for setting the date and time on the DPM. For more information about DPM Keywords, refer to the *DPM Download/Configuration Online Help*.

Setting the date and time

The DPM 9350/00 displays the date and time in the following format:

YYYY-MM-DD (year-month-day) and HH:MM (hours:minutes)

The menu entry for the date and time displays the current date setting:

```

2003
12-30
OK ← ↻

```

Confirm the menu entry selection by pressing the Jog Dial and proceed as follows:

1. Set the year by moving the Jog Dial up or down. Confirm the setting by pressing the Jog Dial.

```

2003 12 30
↑
11:57
OK ← ↻

```

```

2004 12 30
↑
11:57
OK ← ↻

```

2. Set the month and the day.

```

2004 12 30
↑
11:57
OK ← ↻

```

```

2004 11 30
↑
11:57
OK ← ↻

```

3. Set the time.

2004 11 29

11:57
↑ OK ← →

2004 11 29

10:57
↑ OK ← →

When you have set and confirmed the **MM** (minutes) setting, you will automatically return to the DPM main menu.

Note: If you do not want to change, for example, the **YY** (year) setting, you can proceed to the **MM** (month) setting by pressing the Jog Dial.

When you change the batteries for the DPM, a built-in power storage will keep the clock active for 10 hours. After that, the time setting has to be repeated as described above. Alternatively, you can also connect the DPM to the PC and enable the **Synchronize DPM time with PC time** option in the **Program Options** dialog box of the DPM Download/Configuration program.

Setting the recording format

The DPM enables to record dictations either in the Standard Play or the Long Play recording format. The default setting is Standard Play (SP).

This is the menu entry for the recording format; the current setting is indicated with large, bold letters:



Confirm the menu entry selection by pressing the Jog Dial and proceed as follows:

- Set the Long Play mode: LP
- Set the Standard Play mode: SP

Confirm the setting by pressing the Jog Dial and to return to the DPM main menu.

For more information about the recording format, refer to the *Recording format* chapter in this manual.



DPM device beep

You can define whether you want the DPM to beep when specific operations take place. Otherwise the DPM is muted except for warnings, for example, when the batteries are almost empty or the memory card is almost full.

This is the menu entry for the device beep; a check mark next to the symbol indicates that the beep function is enabled. The symbol always shows the current setting:



Confirm the menu entry selection by pressing the Jog Dial and proceed as follows:

- Enable the device beep; this is the default setting: 
- Disable the device beep: 

Confirm the setting by pressing the Jog Dial and to return to the DPM main menu.



Setting the microphone sensitivity

The setting for the microphone sensitivity defines the audio input level for the DPM's built-in microphone.

This is the menu entry for the microphone sensitivity; the symbol always shows the current setting:



Confirm the menu entry selection by pressing the Jog Dial and proceed as follows:

- Set the microphone sensitivity to low when recording dictations in a noisy environment : 
- Set the microphone sensitivity to medium when recording dictations in a normal environment; this is the default setting: 
- Set the microphone sensitivity to high when, for example, recording at a conference: 

Confirm the setting by pressing the Jog Dial and to return to the DPM main menu.



Voice-activated recording

The DPM supports the voice-activated recording mode.

This is the menu entry for voice-activated recording; a check mark next to the symbol indicates that voice-activated recording is enabled. The symbol always shows the current setting:



Confirm the menu entry selection by pressing the Jog Dial and proceed as follows:

- Enable voice-activated recording: 
- Disable voice-activated recording; this is the default setting: 

Confirm the setting by pressing the Jog Dial and to return to the DPM main menu.

For more information about the voice-activated recording mode, refer to the *Voice-activated recording* chapter in this manual.



Backlight on/off

The DPM provides a backlit display for improved visibility.

This is the menu entry for the display backlight; a check mark next to the symbol indicates that the backlit display function is enabled. The symbol always shows the current setting:



Confirm the menu entry selection by pressing the Jog Dial and proceed as follows:

- Enable the backlight; this is the default setting. When you press a button on the DPM, the DPM display will be backlit for about 6 seconds: 
- Disable the backlight; this setting guarantees a longer lifetime for the DPM's batteries: 

Confirm the setting by pressing the Jog Dial and to return you to the DPM main menu.



Changing the contrast

You can change the contrast setting for the DPM display.

This is the menu entry for the contrast setting:

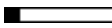

Confirm the menu entry selection by pressing the Jog Dial.

The DPM provides seven contrast levels, from low contrast  to high contrast . The default setting is level 5: .

Confirm your preferred contrast setting by pressing the Jog Dial; this also returns you to the DPM main menu.

Displaying the remaining time



The DPM enables you to have an additional time displayed for the recording time which is left on the memory card. The remaining recording time depends on the setting for the recording mode (SP/LP).

Note: The remaining time is only displayed if you have set the **Advanced display** option for the DPM appearance in the DPM Download/Configuration program.

This is the menu entry for the remaining time; a check mark next to the symbol indicates that the remaining time is available on the DPM display. The symbol always shows the current setting:



Confirm the menu entry selection by pressing the Jog Dial and proceed as follows:

- Enable the display of the remaining time; this is the default setting:  ✓
- Disable the display of the remaining time: 

Confirm the setting by pressing the Jog Dial and to return to the DPM main menu.

Reformatting the memory card

You can erase any data on the memory card by reformatting the memory card.

This is the menu entry for reformatting:



Confirm the menu entry selection by pressing the Jog Dial. The following screen is displayed:



To reconfirm and start the reformatting process, press the DEL button for at least 2 seconds. This will erase all data on the memory card permanently.

Note: You can cancel the reformatting process by removing the memory card or by moving the 4-Position Switch.

Note: When reformatting a memory card of the type SD, make sure the card is not write-protected. A write-protected SD card is indicated with this symbol on the DPM display: 

Power Save mode

If the DPM is left inactive for more than 4 minutes, it goes automatically into Power Save mode and the display is turned off. You can reactivate the DPM by pressing any button or moving the 4-Position Switch. This does **not** initiate the function of the corresponding button. The only exception is if you move the 4-Position Switch to the Play position; this will start playback.

When the device has been reactivated, it will either display the start screen or reenter the mode which was active before it entered the Power Save mode.

Note: If you have voice-activated recording enabled and the DPM is in Record Standby mode, the device will go into Power Save mode after 60 minutes.

Chapter 4: Basic Operations

This chapter provides an introduction to the basic functions of the DPM 9350/00:

- Recording a dictation
- Recording mode (Insert/Overwrite)
- Playing back a dictation
- Fast Forward and Fast Rewind
- Deleting parts of a sound file and deleting entire sound files
- Finishing a dictation (EOL and Priority)
- Additional settings

Recording

With the DPM you can create high-quality digital recordings. Follow these steps to make a recording:

1. Make sure that the 4-Position Switch is in the Stop position and that you have the memory card inserted.
2. Press the REC button; the device goes into Record Standby mode.

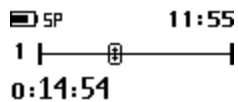

While the device is in Record Standby mode, the Record LED blinks red.

Note: The LED can be either red or green depending on the setting for the recording mode. The default setting for the recording mode is Overwrite. For Overwrite mode, the LED is red. If the setting is Insert mode, the LED is green.

- To start recording, move the 4-Position Switch to the Play position and start dictating. Speak clearly and keep a distance of approximately 4 inches (ten centimeters) between your mouth and the DPM.

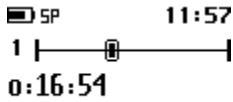

While the device is in Record mode, the Record LED shines permanently red.

Note: In Record mode, the following buttons are not available: L/P, INS/OVR, DEL, REC

- Move the 4-Position Switch to the Stop position to return to Record Standby mode.

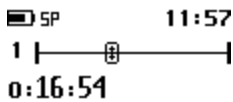

Note: Pressing the REC button enables to switch between Record Standby mode and Stop mode.

- While the device is in Record Standby mode, you can do one of the following:

- To continue recording, move the 4-Position Switch to the Play position again.

SP 11:57
1 |-----|
0:16:54

- To leave Record Standby and enter Stop mode, either move the 4-Position Switch to the Fast Rewind position or press the REC button.

SP 11:57
1 |-----|
0:16:54 2:14:06

6. When you are finished and do not want to make any further changes to the dictation, press the L/P button to mark the current dictation as finished (EOL indication: /). Finishing a dictation via the L/P button is also possible in Record Standby mode.

The file will be closed and a new, empty file is automatically generated. The file number is increased by one.

Finishing a dictation (EOL and Priority)

The L/P button on the DPM has two functions: marking a dictation as finished (EOL function, End-of-Letter) and assigning priority to a dictation (Priority function). The L/P button is only operational if the 4-Position Switch is in the Stop position and recording has been done in the file.

Note: Finishing a dictation via the L/P button is also possible in Record Standby mode.

 EOL indication (End-of-Letter)

 Priority indication

The functions of the L/P button are as follows:

- If you press the L/P button once, the current file is marked as finished (EOL indication). The file is closed and a new, empty file is created.

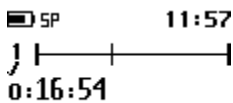

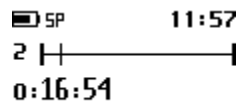

- If you press the L/P button twice within half a second, the current file is marked as finished (EOL indication) and assigned the Priority status. This also closes the current file and creates a new, empty file.

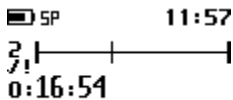

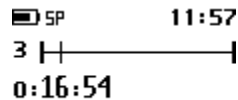

Note: If you have finished a file with the EOL indication, no further recording is possible in this file. It is also not possible to delete the file or to delete a section from the file.

Removing EOL and Priority from a file

To remove the EOL indication or Priority assignment from a dictation, follow these steps:

1. Make sure the 4-Position Switch is in the Stop position.
2. Go to the respective file by moving the Jog Dial up or down.
3. To confirm the file selection and access the file, press the Jog Dial.
4. To either remove the EOL indication or the Priority assignment, do one of the following:
 - To remove the EOL indication, press the L/P button once.
 - To remove the Priority status, press the L/P button twice within half a second.

Recording mode (Insert/Overwrite)

The INS/OVR button switches between Insert and Overwrite mode:

The default setting is Overwrite mode which means that new speech replaces existing speech in the sound file from the insertion point forward.

If the mode setting is Overwrite, the LED is red. If the device is set to Insert mode, the LED is green and an additional symbol is shown on the DPM display.

This is the DPM display in Stop mode and with Overwrite mode enabled:

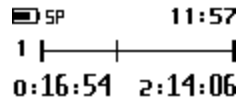

The DPM display shows a battery icon, the text "SP", and the time "11:57". Below this is a horizontal line with a vertical tick mark on the left and another on the right, with the number "1" positioned between these two marks. At the bottom, the time "0:16:54" is displayed on the left and "2:14:06" on the right.

This is the DPM display in Stop mode and with Insert mode enabled:

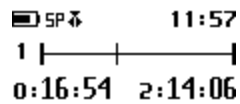

The DPM display shows a battery icon, the text "SP" with a small symbol to its right, and the time "11:57". Below this is a horizontal line with a vertical tick mark on the left and another on the right, with the number "1" positioned between these two marks. At the bottom, the time "0:16:54" is displayed on the left and "2:14:06" on the right.

Playback

To play back a selected sound file through the earphones or the built-in loudspeaker, move the 4-Position Switch to the Play position.

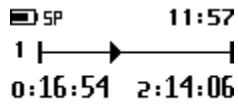

To stop playback, move the 4-Position Switch to the Stop position. When the end of the file is reached, playback stops automatically.

Note: In Playback mode, the following buttons do not function: L/P, DEL, INS/OVR, REC and DL/S.

Adjusting the volume

Moving the Jog Dial up and down during playback adjusts the playback volume for the earphones and the built-in loudspeaker. While the volume is being adjusted, a speaker symbol and volume slider are displayed:



Fast Forward and Fast Rewind

The 4-Position Switch on the DPM also supports fast forwarding and fast rewinding through a sound file. Move the switch to the Fast Forward or Fast Rewind position to start winding and hold it at that position to carry out the winding operation. When the end or beginning of the file is reached, winding stops automatically.

This is the DPM display in Fast Forward mode:

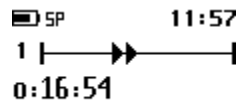

This is the DPM display in Fast Rewind mode:

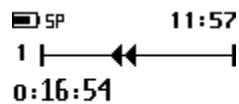

The winding speed starts at 5 times the playback speed. After 2 seconds it is accelerated to 10 times the playback speed; after 8 seconds to 20 times and after 30 seconds to 100 times the playback speed.

Deleting

The DEL button on the DPM can be used for two purposes: deleting a section from a sound file and deleting the whole sound file.

Deleting a section

To delete a section from the current dictation, follow these steps:

1. Go to the beginning of a section which is to be deleted by using Fast Forward, Fast Rewind or Play, move the 4-Position Switch to the Stop position and press the DEL button once.

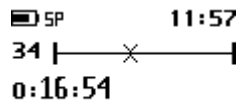

The beginning of the section is marked with x.

2. Use either Play, Fast Forward or Fast Rewind to go to the end of the section that is to be deleted and press the DEL button again.

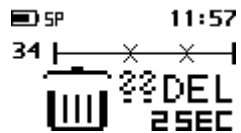

The end of the section is marked with another x. The open waste bin with a question mark indicates that the delete operation must be confirmed.

3. Confirm the operation by pressing the DEL button again for at least 2 seconds and the section is deleted permanently from the file.



The waste bin symbol indicates that the section has been deleted.

Deleting a file

To permanently delete an entire sound file, follow these steps:

1. If you do not have the file you want to delete already open, go to the file by moving the Jog Dial up or down.
2. Confirm the file selection by pressing the Jog Dial and make sure that the 4-Position Switch is in the Stop position.
3. Press the DEL button for at least 2 seconds.



An x symbol appears at the beginning and the end of the file to indicate that the sound file is marked to be deleted.

4. Confirm the operation by pressing the DEL button again for at least 2 seconds.

Note: To cancel any delete operation, move the 4-Position Switch to any position. Dictations which have been finished with the EOL (End-of-Letter) indication cannot be deleted unless the EOL indication is removed from the file.

Recording format (Standard Play/Long Play)

The recording format (Standard Play and Long Play) determines the recording speed and audio quality of the recorded sound files..

SP Standard Play mode

LP Long Play mode

The default setting is Standard Play (SP). For more information about changing this setting, refer to the corresponding section in the *DPM menu* chapter in this manual.

Note: Only one format can be selected for each file; the format for a file can be changed as long as no recording has been done in the file.

After recording has been done in the file, it is possible to switch between the Standard Play and Long Play audio format on the DPM display. This change will not take effect for the current file but from the next new file onwards. From that point on, any new files are recorded in the selected audio format until the setting is changed again.

The values for the two formats are as follows:

Standard Play (SP) 13.7 kbit/s

With this format, about 156 minutes of recording time are available on a 16 MB memory card. This recording format provides excellent audio quality. It is recommended when the dictation sound files are used, for example, for speech recognition.

Long Play (LP) 9.1 kbit/s

This recording format provides good audio quality. With this format, about 234 minutes of recording time are available on a 16 MB memory card.

Voice-activated recording

Voice-activated recording mode is a convenient feature for hands-free dictation. When voice-activated recording is enabled, the DPM is in Record Standby mode; recording will start automatically when the input level exceeds a certain threshold (i.e. usually when you start dictating). This means that recording stops a few seconds after you stop speaking and restarts automatically when you start speaking again.

To operate the DPM in voice-activated recording mode, follow these steps:

1. Enable voice-activated recording in the DPM menu.

For more information, refer to the corresponding section in the *DPM menu* chapter in this manual.

2. Make sure that the 4-Position Switch is in the Stop position.
3. Press the REC button; the device is in Record Standby mode.
4. Move the 4-Position Switch to the Play position.
5. Start dictating and recording will start automatically. The symbol for voice-activated recording is shown on the DPM display.

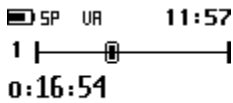

The screenshot shows the DPM display with the following elements: a battery level indicator, the text 'SP UR', the time '11:57', a horizontal progress bar with a small square marker, and the recording time '0:16:54'.

When you stop dictating, the DPM goes back into Record Standby after three seconds.

Skip Forward and Skip Back

The Jog Dial on the DPM supports a skip function for moving between files:

Before you move the Jog Dial up or down, make sure that the 4-Position Switch is in the Stop position:

- Moving the Jog Dial up skips to the end of the current file. Then, moving the Jog Dial up will always skip to the end of the next file.

For example, the current file number is 5. Moving the Jog Dial up goes to the end of file number 5. Moving the Jog Dial further up goes to the end of file number 6, then to the end of file number 7, and so on.

- Moving the Jog Dial down skips to the beginning of the current file. Then, moving the Jog Dial down will always skip to the beginning of the previous file.

For example, the current file number is 5. Moving the Jog Dial down goes to the beginning of file number 5. Moving the Jog Dial further down goes to the beginning of file number 4, then to the beginning of file number 3, and so on.

When you want to continue working on a specific file, confirm the file selection by pressing the Jog Dial.

Note: When you skip forward and the last file is reached, a new empty file is created automatically.

If you do not move the Jog Dial for more than 2 seconds, the DPM returns to the position prior to moving the Jog Dial.

Chapter 5: Advanced Operations

This chapter introduces you to some of the more advanced aspects of the DPM:

- Assigning Keywords
- Transferring data between the DPM and a PC

Note: These functions are only available when using the DPM 9350/00 together with DPM Download/Configuration program.

Assigning Keywords

The DPM allows you to personalize your dictations via predefined Keywords. For this purpose, you create a configuration file on the PC using the Download/Configuration program. For DPM 9350/00 this configuration file can have up to two Keywords defined to be used on the DPM.

Keywords are a combination of their usage definition and the content definitions for that usage. All this information is stored in the configuration file which is transferred to the DPM. On the DPM, the authors can select from the predefined entries and assign them to their dictations. These entries are saved together with the dictation and can finally be used by the transcriptionist for filtering the dictations.

For more information about DPM Keywords, refer to the *DPM Download/Configuration Online Help*.

Example: The first Keyword can have the usage *Author*. The entries, this is the content, for this Keyword would then be a selection of author's names: *Jones, Singh, Watson* etc. The second Keyword can have the usage *Subject*. The entries for this Keyword would then be a selection of possible subject areas: *Radiology, Surgery, Patient* etc. This information is transferred to the

DPM where the author selects the author name and subject area for each dictation.

To assign Keywords to a dictation, follow these steps:

1. Press the Jog Dial for about 2 seconds to access the DPM menu and display the Keyword's usage definition, for example: *Author*

AUTHOR

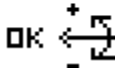

Note: If a Keyword assignment has already been made, the current assignment is displayed as the menu entry, for example: *AUTHOR: Singh*

2. Confirm the Keyword selection by pressing the Jog Dial. The Keyword's content definitions are displayed, for example, the author names: *Jones, Singh, Watson*
3. Move the Jog Dial to scroll to the name you want to assign.

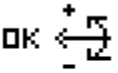

Jones

4. Confirm your selection by pressing the Jog Dial and to return to the DPM main menu.

- To assign a second Keyword, move the Jog Dial to display this Keyword's usage definition, for example: *Subject*

SUBJECT

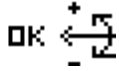

- Confirm the Keyword selection by pressing the Jog Dial. The Keyword's content definitions are displayed, for example: *Radiology, Surgery, Patient*
- Move the Jog Dial to scroll to the subject you want to assign.

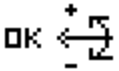

Patient

- Confirm your selection by pressing the Jog Dial and to return to the DPM main menu.

The selected Keyword definitions will be stored with your dictation. Any new dictation you create will be assigned the same information unless you select different Keyword definitions.

You can select different Keyword definitions as long as no recording has been done in the file. After recording has been done in the file, it is possible to choose different Keyword definitions on the DPM display. These changes will not take effect for the current file but from the next new file onwards.

Note: If the DPM goes into Power Save mode while assigning Keywords, the DPM is reactivated in Stop mode. Any unconfirmed Keyword assignments will have been discarded. You have to access the DPM menu and repeat the Keyword assignment.

Transferring data between DPM and PC

You can use your DPM as part of the workflow management for exchanging and transferring data with the PC. With the DPM Download/Configuration program, you make settings and choose options on how to operate the device. This data can then be downloaded and is stored on the DPM. With the DPM you create your dictations which are then transferred to the PC for further processing.

Depending on how you have configured the download process with the Download/Configuration program, the download process is either started automatically or by pressing the DL/S button on the DPM. You can also configure whether individual sound files or all of the sound files will be transferred from the DPM to the PC.

To transfer data from the DPM to the PC with the automatic download functionality enabled in the DPM Download/Configuration program, follow the steps below. For more information about the automatic download procedure, refer to the *DPM Download/Configuration Online Help* or the *User Manual* delivered with the CD.

1. Make sure the DPM is connected to the PC and that the 4-Position Switch is in the Stop position.

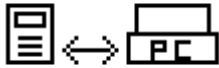

The data transfer is started either automatically or by pressing the DL/S button on the DPM, depending on how you have configured the download process.

- The progress of the file transfer is displayed.



- When the download is finished, one of the following symbols will appear:

The download finished successfully:



The download did not succeed:



Note: Whether the downloaded files on the DPM are deleted after transferring depends on the corresponding settings in the DPM Download/Configuration program.

Additional information

- During transfer and as long as the DPM is connected to the PC, all buttons and switches on the DPM are inactive.
- For more information about the different download configuration options, refer to the *DPM Download/Configuration Online Help* or the *User Manual* delivered with the CD.

Appendix: Troubleshooting the DPM

If you have problems with your DPM, please try the following before you contact your vendor.

Resetting the DPM

To reset the DPM, remove the batteries from the device. Wait for at least 5 seconds before you re-insert the batteries.

DPM warnings



If the DPM displays this warning screen, the problem could be one of the following:

- The memory card cannot be read. Try a different memory card or a different type of memory card.
- The memory card is not formatted or corrupted.
- One of the DPM buttons could be stuck.

Index

- 4**
- 4-Position Switch
 - Fast Forward position, 36
 - Fast Rewind position, 36
 - Lock/Hold switch, 10
 - Playback, 35
- A**
- Advanced display, 15
- Advanced operations, 42
- Appearance, 15
- Assign
 - Keywords, 18
- Authors, 42
- Automatic recording, 24, 40
- B**
- Backlight, 25
- Basics, 29
- Batteries, 8
 - Recharge, 9
- Beep, 22
- Button
 - DEL, 37
 - EOL, 32
 - INS/OVR, 34
 - L/P, 32
 - Priority, 32
 - REC, 29
- C**
- Card, 11
- Configuration file, 42
- Configuration program, 45
- Contrast, 26
- D**
- Data transfer, 45
- Date, 19
- DEL, 37
- DEL button, 37
- Delete
 - File, 38
 - Section, 37
- Delete operations, 37
- Dictation
 - Create, 29
- Display, 7
- Download program, 45
- DPM
 - Activate, 10
 - Batteries, 8
 - Formatting the memory card, 12
 - Graphic, 3
 - Keywords, 42
 - Memory card, 11
 - Overview, 3
 - Reset, 47
- DPM display, 15, 25, 26
- DPM Download/Configuration, 45
- DPM menu, 16, 18, 19, 21, 22, 23, 24, 25, 26, 27
- E**
- End-of-Letter button, 32

EOL, 32
EOL button, 32

F

Fast Forward, 36
Fast Rewind, 36
Features, 1
File
 Delete, 38
 Skip Back, 41
 Skip Forward, 41
First steps, 29
Format for recording
 Long Play, 39
 Standard Play, 39
Formatting
 Memory card, 12

G

Getting started, 10
Graphic
 DPM, 3

I

INS/OVR, 34
INS/OVR button, 34
Insert
 Memory card, 11
Insert mode, 34
Introduction, 1

J

Jog Dial, 16
 Keywords, 43
 Skip Back, 41
 Skip Forward, 41
 Volume, 35

K

Keywords, 42
 DPM menu, 18

L

L/P, 32
L/P button, 32
LCD display, 7
LED
 Green, 34
 Red, 34
Lock/Hold switch, 10
Long Play, 21, 39

M

Memory card, 11
 Format, 12
 Insert, 11
 Reformat, 27
Menu, 16
 Backlight, 25
 Contrast, 26
 Date and time, 19
 Device beep, 22
 Keywords, 18
 Microphone sensitivity, 23
 Reformatting the memory card, 27
 Remaining time, 26
 SP/LP, 21
 Voice-activated recording, 24
Microphone sensitivity, 23
MMC, 11
Mode
 Insert, 34
 Overwrite, 34
 Power Save, 28
 Record Standby, 29

O

Operations
 Advanced, 42
 Basic, 29
Overwrite mode, 34

P

Package contents, 2
Playback, 35
Power Save mode, 28
Priority, 32
Priority button, 32
Program
 DPM Download/Configuration, 42,
 45

R

REC, 29
REC button, 29
Recharge
 Batteries, 9
Record Standby, 29
Recording, 29
Recording format
 Long Play, 21, 39
 Standard Play, 21, 39
Recording mode
 Insert, 34
 Overwrite, 34
Reformat
 Memory card, 27
Remaining time, 26
Reset
 DPM, 47

S

SD, 11

Section (sound file)

 Delete, 37
 Skip Back, 41
 Skip Forward, 41
Software
 DPM Download/configuration, 42
 DPM Download/Configuration, 45

Sound file

 Delete - file, 38
 Delete section, 37
 Playback, 35
 Skip Back, 41
 Skip Forward, 41
Sound file format
 Long Play, 21, 39
 Standard Play, 21, 39

SP/LP, 21, 39

Standard display, 15
Standard Play, 21, 39
Start screen, 13
Symbols, 7

T

Time, 19
Transfer
 Data, 45
Troubleshooting, 47

V

VA, 24, 40
Voice-activated recording, 24, 40
Volume, 35

W

Warnings, 47
Winding, 36
Workflow management, 45

Printed in Austria



5103 109 95481

Free Manuals Download Website

<http://myh66.com>

<http://usermanuals.us>

<http://www.somanuals.com>

<http://www.4manuals.cc>

<http://www.manual-lib.com>

<http://www.404manual.com>

<http://www.luxmanual.com>

<http://aubethermostatmanual.com>

Golf course search by state

<http://golfingnear.com>

Email search by domain

<http://emailbydomain.com>

Auto manuals search

<http://auto.somanuals.com>

TV manuals search

<http://tv.somanuals.com>