

# **DPM 9400**

## User Manual



# PHILIPS

## **DPM 9400 - User Manual**

### **VERSION**

DPM 9400 - 05/2005 (English)

### **COPYRIGHT**

© 2003 - 2005 Philips Austria GmbH, PSP - Dictation Systems. All rights reserved. Reproduction in whole or in part is prohibited without the written consent of the copyright owner. Information in this manual is subject to change without notice.

### **TRADEMARKS**

Pocket Memo® is a registered trademark of Philips. Windows 2000 and Windows XP are registered trademarks of Microsoft Corporation. All other names are trademarks, registered trademarks or service marks of their respective owners.

### **DISCLAIMER AND NOTICES**

Philips has carried out extensive testing with most popular configurations. However, since PC add-ons and device drivers change very rapidly, we are unable to guarantee conflict-free operation.

The CE mark confirms that the device corresponds to the relevant guidelines of the European Union. The cardboard used for packaging can be recycled. This electronic facility contains recyclable material.



Technical changes and errors excepted.

Please note that not all accessories mentioned in this manual are necessarily part of the package contents. Descriptions of accessories, such as memory cards, additional microphones or the Foot Control, are for information only and do not require Philips to deliver any of these accessories with *DPM 9400*.



### **Declaration of Conformity**

Tested to comply with FCC standards. For home or office use.

Model number:	DPM 9400
Trade name:	Philips Digital Pocket Memo
Responsible party:	Philips Speech Processing - Dictation Systems
Address:	64 Perimeter Center East, Fifth Floor, Atlanta, GA 30346, USA
Telephone number:	+1 770 821 2400

This device complies with Part 15 of the FCC Rules. Operation is subject to the following two conditions:

1. This device may not cause harmful interference.
2. This device must accept any interference received, including interference that may cause undesired operation.

**Table of Contents**

**Chapter 1: Introduction ..... 1**  
 DPM features ..... 1  
 Package contents ..... 1

**Chapter 2: Introducing the DPM ..... 2**  
 DPM graphic ..... 2  
 LCD display ..... 3  
 Batteries ..... 4  
 Recharging the batteries ..... 4

**Chapter 3: Getting Started ..... 5**  
 Activating the DPM ..... 5  
 Memory card ..... 5  
 Formatting the memory card ..... 5  
 Full memory card ..... 6  
 Start screen ..... 6  
 Display appearance ..... 7  
 DPM menu ..... 7  
 Accessing the DPM menu ..... 7  
 User-defined labels ..... 8  
 Assigning Keywords ..... 8  
 Setting the date and time (DPM 9400/00) ..... 8  
 Setting the date and time (DPM 9400/52) ..... 9  
 Setting the recording format ..... 9  
 DPM device beep ..... 10  
 Setting the microphone sensitivity ..... 10  
 Voice-activated recording ..... 10  
 Backlight on/off ..... 10  
 Changing the contrast ..... 11  
 Displaying the recording time ..... 11  
 Reformatting the memory card ..... 11  
 Power Save mode ..... 11

**Chapter 4: Basic Operations ..... 12**  
 Recording - DPM 9400/00 ..... 12  
 Recording - DPM 9400/52 ..... 13  
 Finishing a dictation (EOL and Priority) ..... 13  
 Recording mode (Insert/Overwrite) ..... 14  
 Playback ..... 14  
 Adjusting the volume ..... 14  
 Fast Forward and Fast Rewind ..... 15  
 DPM 9400/00 ..... 15  
 DPM 9400/52 ..... 15  
 Deleting ..... 15  
 Deleting a section ..... 15  
 Deleting a file ..... 16  
 Recording format (Standard Play/Long Play mobile) ..... 16  
 Voice-activated recording ..... 16  
 DPM 9400/00 ..... 16  
 DPM 9400/52 ..... 17  
 Skip Forward and Skip Back ..... 17

**Chapter 5: Advanced Operations ..... 18**  
 Inserting index marks ..... 18  
 Deleting index marks ..... 18  
 Entering user-defined labels ..... 19  
 Assigning Keywords ..... 19  
 Example: Assigning Keywords ..... 20  
 Scanning barcode information into Keywords ..... 21  
 Example: Barcode scanning ..... 21  
 Linked Keywords ..... 22  
 Example: Linked Keywords ..... 22  
 Recording spoken instructions ..... 23  
 Recording spoken instructions in Overwrite mode ..... 23  
 Recording spoken instructions in Insert mode ..... 24  
 Deleting spoken instructions ..... 24  
 Transferring data between DPM and PC ..... 24  
 Mandatory user input ..... 25

**DPM 9400 - User Manual**

**Appendix: Troubleshooting the DPM..... 26**  
**Index ..... 28**

## Chapter 1: Introduction

The DPM 9400 (Digital Pocket Memo) has been designed to offer optimum user convenience and greater efficiency for your daily work. This manual provides a comprehensive overview of all the device's features and detailed instructions on how to operate the device.

### DPM features

- The DPM 9400 is a state-of-the-art digital voice recorder for the professional user.
- Digital recording allows instant access to any point in the dictation and enables you to make precise deletions from sound files and to correctly place insertions.
- The DPM 9400 provides workflow management capabilities for easy transfer of files to the PC.
- 4-Position Switch for single-handed operation and ease-of-use.
- User-defined information (Keywords and labels) can be stored with the sound file.
- USB connection for simple data transfer between the device and the PC.
- Ergonomic design.
- High-resolution LCD display with backlight.
- Recording of spoken instructions.
- Utmost flexibility through the low level API and easy integration via the high level API.

### Package contents

- DPM 9400 - the digital voice recorder for the professional user.
- Philips memory card of the type MMC.
- A luxury pouch.
- 2 Philips AAA batteries.
- A USB cable.
- *Quick Reference* for DPM 9400/00 or DPM 9400/52.
- The DPM models 9400/00E and 9400/52E further include:
  - DPM Docking Station 9110 with Philips rechargeable batteries LFH 9144.
  - Installation CD for *SpeechExec Dictate* for Windows 2000 and Windows XP.

### Accessories available from your vendor

- Power Supply LFH 9145
- DPM Docking Station 9110
- Rechargeable batteries LFH 9144

For more information on Philips and the available products, go to:

[www.philips.com](http://www.philips.com)  
[www.philips.com/dictation](http://www.philips.com/dictation)

## Chapter 2: Introducing the DPM

This chapter introduces the DPM 9400. Below you find a graphic of the device which shows and explains the various parts. You also find a detailed description of the DPM display and useful information on how to operate the device with batteries.

### DPM graphic

The following graphics show the device and the names of the various parts.

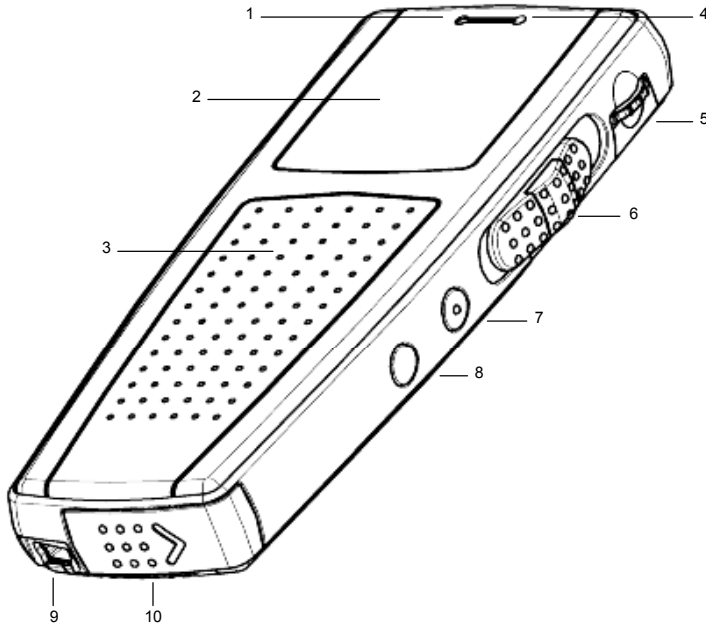

- 1: Record LED: Depending on the setting for the recording mode, the LED can be either red or green. In Overwrite mode the LED is red; Overwrite is the default setting for the recording mode. In Insert mode, the LED is green.
- 2: LCD display.
- 3: Built-in loudspeaker.
- 4: Built-in microphone.
- 5: Jog Dial (↕): Volume control, Skip Forward and Skip Back, access to the DPM menu and moving between menu entries, and confirmation of selections.
- 6: 4-Position Switch with Lock/Hold switch functionality. Depending on your DPM model, the positions on the 4-Position Switch are (from top to bottom):  
DPM 9400/00: Fast Forward (▲), Play (▶), Stop (●) and Fast Rewind (◀).  
DPM 9400/52: Record (REC), Stop (STOP), Play (PLAY), Fast Rewind (FRWD).
- 7: INS/OVR: Button for switching between Insert (INS) and Overwrite (OVR) mode.
- 8: DEL: The Delete button.
- 9: USB socket.
- 10: Battery compartment.

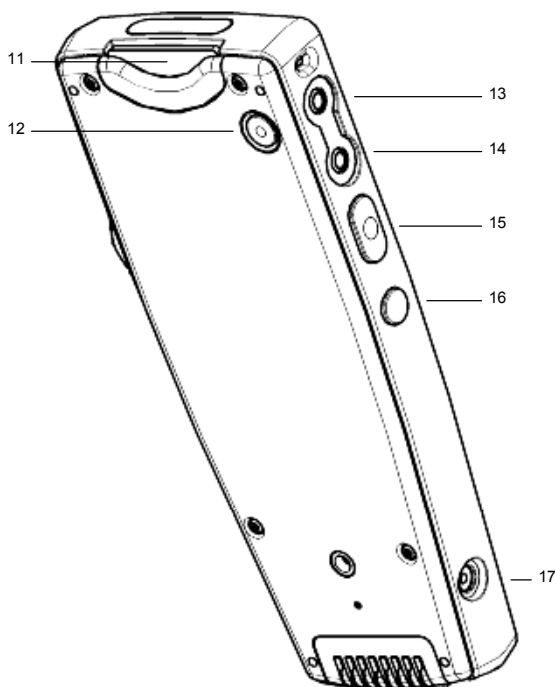

11: Memory card slot: Insert the memory card and push it down until you hear a click. To remove the memory card from the DPM, push it down again until you hear the click.

12: L/P: Press this button once (●EOL) to evoke the End-of-Letter function which marks the dictation as finished. Press this button twice (●●P) to mark the dictation as finished and to assign priority to it.

13: MIC: The microphone socket.

14: EAR: The earphone socket.

15: The function of this button depends on your DPM model:

DPM 9400/00: Record (REC).

DPM 9400/52: Fast Forward (FFWD).

16: DL/S.Instr: This is a multi-function button which supports the following operations:

- When the DPM is connected to the PC, this button activates the download function.
- When you press the button for about 0.3 seconds in Playback or Recording mode, an index mark is inserted into the sound file.
- When you press the button for at least 1 second in Recording mode, a spoken instruction is inserted into the sound file.

17: Power supply socket for Philips LFH 9145.

### **LCD display**

The DPM 9400 has a high-quality graphical LCD display. You will see the following symbols:

<b>SP</b>	Standard Play	<b>LP<sub>m</sub></b>	Long Play mobile
<b>AM</b>	AM symbol (hours before noon)	<b>PM</b>	PM symbol (hours after noon)
<b>⏮</b>	Fast Rewind	<b>⏭</b>	Fast Forward
<b>📁</b>	Recording	<b>⏸</b>	Record Standby
<b>+</b>	Stop	<b>▶</b>	Playback
<b>🗣</b>	Voice-activated recording	<b>🔒</b>	Insert mode
<b>📄</b>	EOL (End-of-Letter)	<b>!</b>	Priority
<b>🔒</b>	Write-protected SD card	<b>    </b>	Barcode information
<b>🔋</b>	Batteries: 100%	<b>🔋</b>	Batteries: 80%

## DPM 9400 - User Manual

 Batteries: 60%





 Batteries: 40%

 Batteries: 20%

 Batteries: empty

### Status indication bar

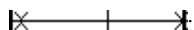
The status indication bar may appear as follows (note that the following overview only lists the most common displays of the status indication bar):

	A dictation is being recorded.
	A sound file is being played back.
	A section of the sound file is marked for deletion.
	The whole sound file is marked for deletion.
	The sound file has index marks.
	The sound file includes spoken instructions.

### Batteries

The DPM 9400 can be operated with the two standard AAA alkaline batteries delivered with the product. You can also use rechargeable Philips NiMH batteries (LFH 9144). For recharging the batteries, only use the power supply LFH 9145; it can also be used for running the DPM from the mains power supply.

The power indicator on the display may appear as follows:

: The batteries are full (100%).

: 4/5 of the battery power is available (80%).

: 3/5 of the battery power available (60%).

: 2/5 of the battery power available (40%).

: 1/5 of the battery power available (20%).

: The batteries are empty and should be replaced.

If the batteries are dangerously low and should be replaced or recharged, this symbol is displayed:

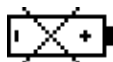

**Note:** If the power level in the batteries drops below 2.0 V, no recording or playback is possible.

### Recharging the batteries

The DPM can be operated with the rechargeable Philips NiMH batteries LFH 9144. For recharging these batteries, either use the DPM Docking Station 9110 or the Philips power supply LFH 9145.

For more information on recharging the batteries with the DPM Docking Station 9110, refer to the documentation delivered with the product.



To recharge the batteries (fast recharge) with the Philips power supply LFH 9145, do the following:

1. Connect the Philips power supply LFH 9145 to the mains power supply.
2. Deactivate the DPM via the Lock/Hold switch; this starts the recharging process.

**Important:** The DPM can become quite warm during fast recharging.

The recharging process is indicated on the DPM display with these alternating symbols:  and 

When recharging is finished, only the symbol for full battery power is displayed: 

**Note:** When working with standard rechargeable batteries, the DPM only displays the symbol for 80% battery power () even if the batteries have been fully recharged. The symbol for 100% battery power () is only displayed when completely new standard batteries (not rechargeable) are inserted or when the DPM is run from the mains power supply.



## Chapter 3: Getting Started

This chapter provides an introduction to the basic functions of the DPM 9400:

- Activating the DPM
- Memory card
- Start screen
- DPM menu
- Power Save mode

### Activating the DPM

The DPM can be turned on and off via the Lock/Hold switch. If the device is locked, it is not possible to use any of the DPM buttons and none of the buttons can be pressed accidentally.

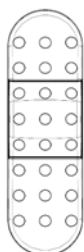

The device is unlocked.

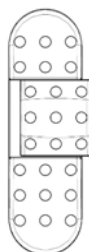

The device is locked.

When you work with the DPM for the first time, insert the batteries and unlock the Lock/Hold switch. The device is now operational and you can insert the memory card.

For activating the device when it has already been in use, there are the following options:

- If the Lock/Hold switch was activated, unlock the device.
- If the device has gone into Power Save mode (the device has been left inactive for more than four minutes), activate the device by pressing any button or by moving the 4-Position Switch.
- If the DPM has been left inactive for more than two hours, it is automatically turned off. In this case, it can only be turned on via the Lock/Hold switch (OFF-ON functionality) or by moving the 4-Position Switch.

### Memory card

The DPM 9400 operates with a memory card of the type MMC or SD. It supports MMC and SD cards with storage capacities of up to 1 GB. For example, a 32 MB memory card of the type MMC supports about 312 minutes of recording time in SP format or 468 minutes of recording time in LPm format.

If there is no memory card inserted into the DPM, this screen is displayed:



After inserting the memory card, one of the following screens will be displayed:

- If the memory card is new and has not been formatted, a confirmation dialog for formatting the memory card is displayed; for more information, see below.
- If the memory card has been in use before, a start screen with the information stored on the memory card is displayed.

### Formatting the memory card

When you insert a new, unformatted memory card, the following screen is displayed:

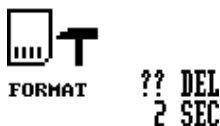

To confirm and start the formatting process, press the DEL (Delete) button for at least two seconds. If you want to cancel the formatting process, either remove the memory card or move the 4-Position Switch.

**Note:** The memory card delivered with your DPM 9400 has already been preformatted.

**Important:** Any memory card used with the DPM should be formatted by the DPM itself and not any other device.

For more information on reformatting the memory card, refer to the corresponding *DPM menu* section in this manual.

### Full memory card

If only two minutes of recording time are left on the memory card, the recording time on the DPM display will start to blink. This can either be the remaining recording time or the used-up recording time. Note that this additional time display is only available in combination with the **Advanced** display option.

When the memory card is full, a warning is displayed and the device beeps; recording stops.

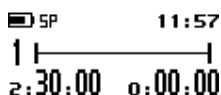

### Start screen

After the memory card has been inserted or the DPM is turned on, a start screen is displayed. This screen is identical to the screen which is displayed when the DPM is in Stop mode.

The following screen is a fictional screen with the maximum number of symbols which could appear.

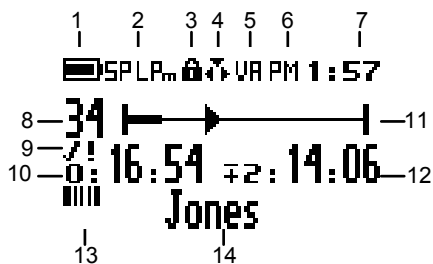

- 1: The battery power.
- 2: The recording format. This can be either SP or LPm.
- 3: The SD memory card is write-protected.
- 4: Insert mode is activated. The default setting is Overwrite mode. For Overwrite mode, no symbol is displayed.
- 5: Voice-activated recording mode is enabled.
- 6: AM (or PM) symbol if the US time format is used. The US time format is the default setting for DPM 9400/52.
- 7: Current time in HH:MM (hours:minutes).
- 8: The current file number. The current file will always be the last file you worked on. If you do not jump to a different file, this file will be opened automatically.
- 9: The dictation is marked as finished (EOL, End-of-Letter: ! ) and has a Priority (! ) assignment.
- 10: The recording or playback time of the current dictation.
- 11: The status indication bar. This is a graphical display for the space left on the memory card. When recording, playback, winding etc. is done in the sound file, the bar displays the corresponding symbols and actions. The bar above also indicates that the sound file contains a spoken instruction.
- 12: The remaining recording time (-) or used-up recording time (+) on the memory card depending on the setting made with *SpeechExec Dictate*. The displayed time also depends on the SP/LPm setting.
- 13: The current recording has barcode information.
- 14: The current Keyword 1 assignment.

**Note:** If you inserted and formatted a new memory card, moving the Jog Dial (Skip Forward), pressing the REC button (DPM 9400/00) or moving the 4-Position Switch to the Record position (DPM 9400/52) will automatically generate a new file:

- DPM 9400/00: The new file is immediately in Record Standby mode.
- DPM 9400/52: The new file is immediately in Recording mode.

## Display appearance

The appearance of the DPM display depends on the corresponding setting (**Standard display** and **Advanced display** options) in *SpeechExec Dictate*. For more information, refer to the *SpeechExec Dictate Online Help*.

- The **Standard display** option uses larger symbols without showing the status indication bar:

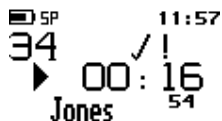

- The **Advanced display** option uses smaller symbols. It enables to view more information on the current dictation and shows the status indication bar. This bar provides visual feedback when a dication, for example, is recorded or played back.

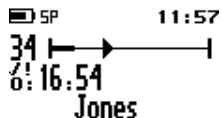

## DPM menu

The DPM 9400 comes with a menu which provides the following options:

- User-defined labels
- Assigning Keywords
- Setting the date and time
- Setting the recording format
- Enabling and disabling the DPM device beep
- Setting the microphone sensitivity
- Voice-activated recording
- Backlight on/off
- Changing the contrast
- Displaying the recording time
- Reformatting the memory card

**Note:** The setting for the DPM display appearance (**Standard display** and **Advanced display** options), for enabling/disabling the record notification beep and for recording into one file only can only be made via the *SpeechExec Dictate*.

**Note:** If the one file function is activated, any recording will be stored in a single file. The Skip Forward, Skip Back and EOL functions are not available. If the record notification beep is enabled, you will hear two beeps every time the DPM goes into Recording mode.

## Accessing the DPM menu

You can access the DPM menu by pressing the Jog Dial (⬆) for about two seconds. The DPM menu can only be accessed when the DPM is in Stop mode.

- To move between the DPM menu entries, move the Jog Dial up or down: 
- To select a menu entry, for example the date and time setting, go to this menu entry by moving the Jog Dial up or down. Then press the Jog Dial to confirm the selection. This enables you to access the menu entry and change the settings for it. Confirm the changes by pressing the Jog Dial; this returns you to the DPM main menu.

To exit a menu entry selection without confirming the changes, press the DEL (Delete) button on the DPM. This exits the DPM main menu and discards any changes.

**Note:** If no menu entry selection is made within ten seconds, the DPM automatically exits the DPM menu and goes back into Stop mode.

## DPM 9400 - User Manual

To exit the DPM menu, do one of the following:

- Select the menu entry for exiting the DPM menu and confirm the selection by pressing the Jog Dial: 
- Press the DEL button.

### User-defined labels

This menu entry is only available if the corresponding option has been enabled in *SpeechExec Dictate* and the setting was transferred to the DPM. If enabled, it is displayed as the first entry when you access the menu.

```
LABEL-1
9      OK ←→
```

The DPM stores the last user-defined label(s) you entered. These will be displayed when you access the menu entry. You can either accept the existing labels or enter new labels. For more information, refer to the *Entering user-defined labels* section in this manual. For more information on *SpeechExec Dictate*, refer to the Online Help delivered with the program.

### Assigning Keywords

This menu entry is only available if Keywords have been defined for the DPM with *SpeechExec Dictate*. It is always displayed as the first menu entry unless you can also create user-defined labels on the DPM:

```
AUTHOR:
Jones
      OK ←→
```

This is an example screen for a Keyword menu entry which has been defined as follows: *usage = Author, content = a selection of author names*; the current Keyword assignment is the author name *Jones*. When you confirm the menu entry selection by pressing the Jog Dial, the list of all defined author names is displayed.

For more information on assigning DPM Keywords, refer to the *Assigning Keywords* section in this manual. For more information on DPM Keywords, refer to the *SpeechExec Dictate Online Help*.

If the DPM has been configured with the **Linked Keywords** setting, this menu contains the available Keyword sets. For more information, refer to the *Linked Keywords* section in this manual.

**Note:** If no Keywords are defined and no user-defined labels are enabled, the menu selection starts with the menu entry for setting the date and time on the DPM.

### Setting the date and time (DPM 9400/00)

This is the default date and time format for DPM 9400/00:

YYYY-MM-DD (year-month-day) and HH:MM (hours:minutes)

The menu entry for the date and time displays the current date setting:

```
2005
12-30
      OK ←→
```

Confirm the menu entry selection by pressing the Jog Dial and do the following:

1. Set the year by moving the Jog Dial up or down. Confirm the setting by pressing the Jog Dial.

```
2005-12-30
↑
11:57
      OK ←→
```

```
2006-12-30
↑
11:57
      OK ←→
```

2. Set the month and the day.

```
2006-12-30
↑
11:57
      OK ←→
```

```
2006-01-30
↑
11:57
      OK ←→
```

- Set the time.

2006-01-01  
11:57  
↑  
OK ← →

2006-01-01  
00:57  
↑  
OK ← →

When you have set and confirmed the MM (minutes) setting, you will automatically return to the DPM main menu.

See also the *Additional information* section below.

### Setting the date and time (DPM 9400/52)

This is the default date and time format for DPM 9400/52:

YYYY-MM-DD (year-month-day) and HH:MM (hours:minutes)

The menu entry for the date and time displays the current date setting:

2005  
12-30  
OK ← →

Confirm the menu entry selection by pressing the Jog Dial and do the following:

- Set the year by moving the Jog Dial up or down. Confirm the setting by pressing the Jog Dial.

2005-12-30  
↑  
AM 11:57  
OK ← →

2006-12-30  
↑  
AM 11:57  
OK ← →

- Set the month and the day.

2006-12-30  
↑  
AM 11:57  
OK ← →

2006-01-30  
↑  
AM 11:57  
OK ← →

2006-01-30  
↑  
AM 11:57  
OK ← →

2006-01-01  
↑  
AM 11:57  
OK ← →

- Set the time.

2006-01-01  
AM 11:57  
↑  
OK ← →

2006-01-01  
PM 11:57  
↑  
OK ← →

2006-01-01  
PM 00:57  
↑  
OK ← →

2006-01-01  
PM 00:00  
↑  
OK ← →

When you have set and confirmed the MM (minutes) setting, you will automatically return to the DPM main menu.

### Additional information

- If you do not want to change, for example, the YY (year) setting, you can proceed to the MM (month) setting by pressing the Jog Dial.
- When you change the batteries for the DPM, a built-in power storage will keep the clock active for ten hours. After that, the time setting has to be repeated as described above. Alternatively, you can also connect the DPM to the PC and enable the **Synchronize DPM time with PC time** option in *SpeechExec Dictate*.

### Setting the recording format

The DPM enables you to record dictations either in the Standard Play or the Long Play mobile recording format. The default setting is Standard Play (SP).

This is the menu entry for the recording format; the current setting is indicated with large, bold letters:

**SP**LP<sub>m</sub>

Confirm the menu entry selection by pressing the Jog Dial and do the following:

- Set LPm: LP<sub>m</sub>

- Set SP: <sup>5P</sup>

Confirm the setting by pressing the Jog Dial and to return to the DPM main menu. For more information on the recording format, refer to the *Recording format* section in this manual.

### DPM device beep

You can define whether you want the DPM to beep when specific operations take place. Otherwise the DPM is muted except for warnings, for example, when the batteries are almost empty or the memory card is almost full.

This is the menu entry for the device beep; a check mark next to the symbol indicates that the beep function is enabled. The symbol always shows the current setting:



Confirm the menu entry selection by pressing the Jog Dial and do the following:

- Enable the device beep; this is the default setting:
- Disable the device beep:

Confirm the setting by pressing the Jog Dial and to return to the DPM main menu.

### Setting the microphone sensitivity

The setting for the microphone sensitivity defines the audio input level for the DPM's built-in microphone.

This is the menu entry for the microphone sensitivity; the symbol always shows the current setting:



Confirm the menu entry selection by pressing the Jog Dial and do the following:

- Set the microphone sensitivity to low when recording dictations in a noisy environment :
- Set the microphone sensitivity to medium when recording dictations in a normal environment; this is the default setting:
- Set the microphone sensitivity to high when, for example, recording at a conference:

Confirm the setting by pressing the Jog Dial and to return to the DPM main menu.

### Voice-activated recording

The DPM supports the voice-activated recording mode.

This is the menu entry for voice-activated recording; a check mark next to the symbol indicates that voice-activated recording is enabled. The symbol always shows the current setting:



Confirm the menu entry selection by pressing the Jog Dial and do the following:

- Enable voice-activated recording:
- Disable voice-activated recording; this is the default setting:

Confirm the setting by pressing the Jog Dial and to return to the DPM main menu.

For more information on the voice-activated recording mode, refer to the *Voice-activated recording* section in this manual.

### Backlight on/off

The DPM provides a backlit display for improved visibility.

This is the menu entry for the display backlight; a check mark next to the symbol indicates that the backlit display function is enabled. The symbol always shows the current setting:

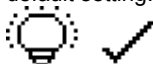

Confirm the menu entry selection by pressing the Jog Dial and do the following:

- Enable the backlight; this is the default setting. When you press a button on the DPM, the DPM display will be backlit for about eight seconds: 

- Disable the backlight; this setting guarantees a longer lifetime for the DPM's batteries: . Confirm the setting by pressing the Jog Dial and to return you to the DPM main menu.



### **Changing the contrast**

You can change the contrast setting for the DPM display.

This is the menu entry for the contrast setting:



Confirm the menu entry selection by pressing the Jog Dial.



The DPM provides seven contrast levels, from low contrast  to high contrast . The default setting is level 5: .

Confirm your preferred contrast setting by pressing the Jog Dial; this also returns you to the DPM main menu.

### **Displaying the recording time**

The DPM enables you to have an additional time displayed for the recording time. Depending on the setting which has been made in *SpeechExec Dictate* you will either see the used-up recording time or the remaining recording time. This time display also depends on the setting for the recording format (SP/LPm).

**Note:** The recording time is only displayed if you have set the **Advanced display** option for the DPM appearance in *SpeechExec Dictate*.

- This is the menu entry for the remaining recording time setting; the check mark next to the symbol indicates that this additional time is currently displayed on the DPM: 
- This is the menu entry for the used-up recording time setting; the check mark next to the symbol indicates that this additional time is currently displayed on the DPM: 

To disable the display of this additional time, confirm the menu entry selection by pressing the Jog Dial. Move the Jog Dial to have the symbol without the check mark and confirm your changes by pressing the Jog Dial again. You will return to the DPM main menu.

### **Reformatting the memory card**

You can erase any data on the memory card by reformatting the memory card.

This is the menu entry for reformatting:



Confirm the menu entry selection by pressing the Jog Dial. The following screen is displayed:

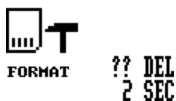

To reconfirm and start the reformatting process, press the DEL button for at least two seconds. This will erase all data on the memory card permanently.

**Note:** You can cancel the reformatting process by removing the memory card or by moving the 4-Position Switch.

**Note:** When reformatting a memory card of the type SD, make sure the card is not write-protected. A write-protected SD card is indicated with this symbol on the DPM display: .

### **Power Save mode**

If the DPM is left inactive for more than four minutes, it goes automatically into Power Save mode and the display is turned off. You can reactivate the DPM by pressing any button or moving the 4-Position Switch. This does **not** initiate the function of the corresponding button. The only exception is if you move the 4-Position Switch to the Play position; this will start playback.

When the device has been reactivated, it will either display the start screen or reenter the mode which was active before it entered the Power Save mode.

**Note:** If you have voice-activated recording enabled and the DPM is in Record Standby mode, the device will go into Power Save mode after 60 minutes.

## Chapter 4: Basic Operations

This chapter provides an introduction to the basic functions of the DPM 9400:

- Recording a dictation
- Recording mode (Insert/Overwrite)
- Playing back a dictation
- Fast Forward and Fast Rewind
- Deleting parts of a sound file and deleting entire sound files
- Finishing a dictation (EOL and Priority)
- Additional settings

### Recording - DPM 9400/00

DPM 9400/00 enables you to create high-quality digital recordings. To make a recording with DPM 9400/00, do the following:

1. Make sure that the 4-Position Switch is in the Stop position (●) and that you have the memory card inserted.
2. Press the REC (Record) button; DPM 9400/00 goes into Record Standby mode.

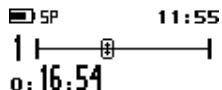

While DPM 9400/00 is in Record Standby mode, the Record LED blinks red.

**Note:** Depending on the setting for the recording mode, the LED can be either red or green. In Overwrite mode the LED is red; Overwrite is the default setting for the recording mode. In Insert mode, the LED is green.

3. To start recording, move the 4-Position Switch to the Play position (▲) and start dictating. Speak clearly and keep a distance of approximately 4 inches (ten centimeters) between your mouth and the DPM.

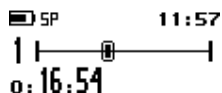

While DPM 9400/00 is in Recording mode, the Record LED shines permanently red (if Overwrite mode).

**Note:** In Recording mode, the following buttons are not available: L/P, INS/OVR, DEL, REC

4. Move the 4-Position Switch to the Stop position (●) to return to Record Standby mode.

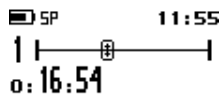

**Note:** Pressing the REC button enables to switch between Record Standby mode and Stop mode.

5. While DPM 9400/00 is in Record Standby mode, you can do one of the following:

- To continue recording, move the 4-Position Switch to the Play position (▲) again.



- To leave Record Standby and enter Stop mode, either move the 4-Position Switch to the Fast Rewind position (▼) or press the REC button.

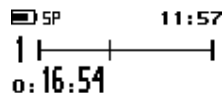



- When you are finished and do not want to make any further changes to the dictation, press the L/P button (End-of-Letter and Priority) to mark the current dictation as finished (EOL symbol: ¶). Finishing a dictation via the L/P button is also possible in Record Standby mode.

The file is closed and a new, empty file is automatically generated. The file number is increased by one.

### **Recording - DPM 9400/52**

DPM 9400/52 enables you to create high-quality digital recordings. To make a recording with DPM 9400/52, do the following:

- Move the 4-Position Switch to the REC (Record) position and start dictating.

Speak clearly and keep a distance of approximately 4 inches (ten centimeters) between your mouth and the DPM.

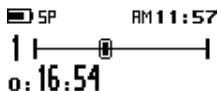

While DPM 9400/52 is in Recording mode, the Record LED shines permanently red (if Overwrite mode).

**Note:** Depending on the setting for the recording mode, the LED can be either red or green. In Overwrite mode the LED is red; Overwrite is the default setting for the recording mode. In Insert mode, the LED is green.

**Note:** In Recording mode, the following buttons are not available: L/P, INS/OVR, DEL, REC

- Move the 4-Position Switch to the STOP (Stop) position to stop recording.

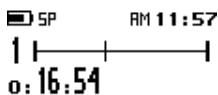

The Record LED goes out.

- To continue recording, move the 4-Position Switch to the REC (Record) position again.
- When you are finished and do not want to make any further changes to the dictation, press the L/P button to mark the current dictation as finished (EOL symbol: ¶).

The file is closed and a new, empty file is automatically generated. The file number is increased by one.

### **Finishing a dictation (EOL and Priority)**

The L/P button on the DPM has two functions: marking a dictation as finished (EOL function, End-of-Letter) and assigning priority to a dictation (Priority function). The L/P button is only operational if the 4-Position Switch is in the Stop position and recording has been done in the file.

¶ : The dictation is marked as finished (EOL, End-of-Letter).

! : The dictation has been assigned priority.

**Note:** Finishing a dictation via the L/P button is also possible in Record Standby mode.

The functions of the L/P button are as follows:

- If you press the L/P button once, the current file is marked as finished (EOL attribute). The file is closed and a new, empty file is created.

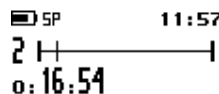
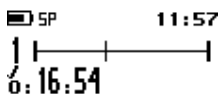

- If you press the L/P button twice within half a second, the current file is marked as finished (EOL attribute) and assigned the Priority status. This also closes the current file and creates a new, empty file.

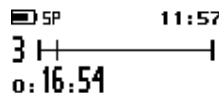
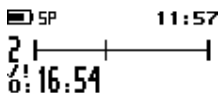

**Note:** If you have finished a file with the EOL attribute, no further recording is possible in this file. It is also not possible to delete the file or to delete a section from the file.

### Removing EOL and Priority from a dictation

To remove the EOL attribute or Priority assignment from a dictation, do the following:

1. Make sure the 4-Position Switch is in the Stop position.
2. Go to the respective file by moving the Jog Dial up or down.
3. To confirm the file selection and access the file, press the Jog Dial.
4. To either remove the EOL attribute or the Priority assignment, do one of the following:
  - To remove the EOL attribute, press the L/P button once.
  - To remove the Priority status, press the L/P button twice within half a second.

### Recording mode (Insert/Overwrite)

The INS/OVR button switches between Insert and Overwrite mode:

The default setting is Overwrite mode which means that new speech replaces existing speech in the sound file from the insertion point forward.

If the mode setting is Overwrite, the LED is red. If the device is set to Insert mode, the LED is green and an additional symbol is shown on the DPM display.

- This is the DPM display in Stop mode and with Overwrite mode enabled:

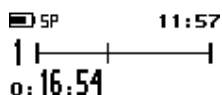

SP 11:57  
|-----|  
0:16:54

- This is the DPM display in Stop mode and with Insert mode enabled:

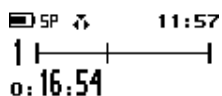

SP 11:57  
|-----|  
0:16:54

### Playback

To play back a selected sound file through the earphones or the built-in loudspeaker, move the 4-Position Switch to the Play position.



SP 11:57  
34 |----->|  
0:16:54

To stop playback, move the 4-Position Switch to the Stop position. When the end of the file is reached, playback stops automatically.

**Note:** In Playback mode, the following buttons do not function: L/P, DEL, INS/OVR, REC and DL/S.Instr.

### Adjusting the volume

Moving the Jog Dial up and down during playback adjusts the playback volume for the earphones and the built-in loudspeaker. While the volume is being adjusted, a speaker symbol and volume slider are displayed:



SP 11:57  
[Speaker Symbol] [Volume Slider]

## Fast Forward and Fast Rewind

The DPM supports fast forwarding and fast rewinding through a sound file.

### DPM 9400/00

On DPM 9400/00, move the 4-Position Switch to the Fast Forward position (▲) or Fast Rewind position (▼) to start winding. Hold it at that position to carry out the winding operation. When the end or beginning of the file is reached, winding stops automatically.

### DPM 9400/52

- To fast forward a sound file, press the FFWD (Fast Forward) button on DPM 9400/52. When the end of the file is reached, winding stops automatically.
- To fast rewind a sound file, move the 4-Position Switch to the FRWD (Fast Rewind) position and hold it at that position. Winding is stopped when you either release the 4-Position Switch or it stops automatically when the beginning of the file is reached.

### DPM display during winding

- This is the DPM display in Fast Forward mode:

- This is the DPM display in Fast Rewind mode:

The winding speed starts at 5 times the playback speed. After two seconds it is accelerated to 10 times the playback speed; after eight seconds to 20 times and after thirty seconds to 100 times the playback speed.

## Deleting

The DEL button on the DPM can be used for two purposes: deleting a section from a sound file and deleting the whole sound file.

### Deleting a section

To delete a section from the current dictation, do the following:

1. Go to the beginning of a section which is to be deleted by using Fast Forward, Fast Rewind or Play, move the 4-Position Switch to the Stop position and press the DEL (Delete) button once.

The beginning of the section is marked with x.

2. Use either Play, Fast Forward or Fast Rewind to go to the end of the section that is to be deleted and press the DEL (Delete) button again.

The end of the section is marked with another x. The open waste bin with a question mark indicates that the delete operation must be confirmed.

3. Confirm the operation by pressing the DEL button again for at least two seconds and the section is deleted permanently from the file.



The waste bin symbol indicates that the section has been deleted.

### Deleting a file

To permanently delete an entire sound file, do the following:

1. If you do not have the file you want to delete already open, go to the file by moving the Jog Dial up or down.
2. Confirm the file selection by pressing the Jog Dial and make sure that the 4-Position Switch is in the Stop position.
3. Press the DEL (Delete) button for at least two seconds.

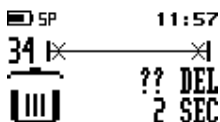

An x symbol appears at the beginning and the end of the file to indicate that the sound file is marked to be deleted.

4. Confirm the operation by pressing the DEL button again for at least two seconds.

**Note:** To cancel any delete operation, move the 4-Position Switch to any position. Dictations which have been finished with the EOL (End-of-Letter) attribute cannot be deleted unless the EOL attribute is removed from the file.

### Recording format (Standard Play/Long Play mobile)

The recording format determines the recording speed and audio quality of the recorded sound files.

SP : Standard Play recording format.

LP<sub>m</sub> : Long Play mobile recording format.

The default setting is SP. For more information on changing this setting, refer to the corresponding *DPM menu* section in this manual.

**Note:** Only one format can be selected for each file; the format for a file can be changed as long as no recording has been done in the file.

After recording has been done in the file, it is possible to switch between the SP and LP<sub>m</sub> recording format in the DPM menu. This change will not take effect for the current file but from the next new file onwards. From that point on, any new files are recorded in the selected format until the setting is changed again.

The values for the two formats are as follows:

#### Standard Play (SP) 13.7 kbit/s

With this format, about 312 minutes of recording time are available on a 32 MB memory card. This recording format provides excellent audio quality. It is recommended when the dictation sound files are used, for example, for speech recognition.

#### Long Play mobile (LP<sub>m</sub>) 9.1 kbit/s

This recording format provides good audio quality. With this format, about 468 minutes of recording time are available on a 32 MB memory card.

### Voice-activated recording

Voice-activated recording mode is a convenient feature for hands-free dictation. When voice-activated recording is enabled, the DPM is in Record Standby mode; recording will start automatically when the input level exceeds a certain threshold (i.e. usually when you start dictating). This means that recording stops a few seconds after you stop speaking and restarts automatically when you start speaking again.

#### DPM 9400/00

To operate DPM 9400/00 in voice-activated recording mode, do the following:

1. Enable voice-activated recording in the DPM menu. For more information, refer to the corresponding *DPM menu* section in this manual.

## DPM 9400 - User Manual

2. Make sure that the 4-Position Switch is in the Stop position (●).
3. Press the REC (Record) button; DPM 9400/00 goes into in Record Standby mode.
4. Move the 4-Position Switch to the Play position (▲).
5. Start dictating and recording will start automatically. The symbol for voice-activated recording is shown on the DPM display.

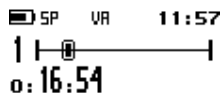

When you stop dictating, the DPM goes back into Record Standby after three seconds.

### DPM 9400/52

To operate DPM 9400/52 in voice-activated recording mode, do the following:

1. Enable voice-activated recording in the DPM menu. For more information, refer to the corresponding *DPM menu* section in this manual.
2. Move the 4-Position Switch to the REC (Record) position; DPM 9400/52 goes into Record Standby mode.
3. Start dictating and recording will start automatically. The symbol for voice-activated recording is shown on the DPM display (see above).

When you stop dictating, the DPM goes back into Record Standby after three seconds.

### Skip Forward and Skip Back

The Jog Dial on the DPM supports a skip function for moving between files:

Before you move the Jog Dial up or down, make sure that the 4-Position Switch is in the Stop position (DPM 9400/00: ●, DPM 9400/52: STOP):

- Moving the Jog Dial up skips to the end of the current file. Then, moving the Jog Dial up will always skip to the end of the next file.

For example, the current file number is 5. Moving the Jog Dial up goes to the end of file number 5. Moving the Jog Dial further up goes to the end of file number 6, then to the end of file number 7, and so on.

- Moving the Jog Dial down skips to the beginning of the current file. Then, moving the Jog Dial down will always skip to the beginning of the previous file.

For example, the current file number is 5. Moving the Jog Dial down goes to the beginning of file number 5. Moving the Jog Dial further down goes to the beginning of file number 4, then to the beginning of file number 3, and so on.

When you want to continue working on a specific file, confirm the file selection by pressing the Jog Dial.

**Note:** When you skip forward and the last file is reached, a new empty file is created automatically.

**Note:** If you do not move the Jog Dial for more than two seconds, the DPM returns to the position prior to moving the Jog Dial.

## Chapter 5: Advanced Operations

This chapter introduces you to some of the more advanced aspects of the DPM:

- Inserting index marks
- Entering user-defined labels
- Assigning Keywords
- Recording spoken instructions
- Transferring data between the DPM and a PC
- Mandatory user input

**Note:** These functions for assigning Keywords and for transferring data are only available when using the DPM together with *SpeechExec Dictate*.

### Inserting index marks

Index marks can be inserted at any position in the sound file. You can insert an index mark during Playback or Recording mode. Proceed as follows:

1. Press the DL/S.Instr button for about 0.3 seconds. An index mark will be inserted at the current position in the sound file. The index mark appears a vertical bar on the display; additionally, the string *Index 1* is shown.

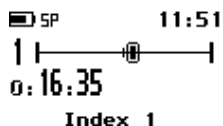

2. Continue recording.
3. Press the DL/S.Instr button again to insert another index mark. Another vertical bar appears on the display and the string *Index 2* is shown.

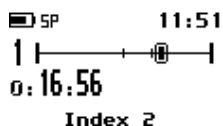

#### Additional information

- When you fast forward or fast rewind the file, the DPM will interrupt the current action at the insertion point of an index mark for about 1 second and the DPM will beep. The action is then continued automatically.

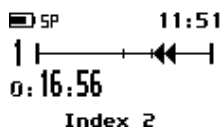

- In Playback mode, only the index mark string is shown on the display when the playback cursor moves over an index mark. The DPM will not beep and playback will not be interrupted.
- When you are recording in Overwrite mode, index marks will be overwritten without any warning.
- You can insert up to 32 index marks into one file.
- You cannot insert index marks into dictations which have been finished with EOL.

### Deleting index marks

To delete an index mark, do the following:

1. Go to the position of the index mark in the file using the fast forward or fast rewind function. Fast forward or fast rewind will stop automatically at the insertion point of an index mark and the DPM will beep.

**Note:** Do not use the playback function because playback does not allow you to position correctly at the insertion point of an index mark.

2. Press the DEL button for about 2 seconds. The string for the index mark will flash. The index mark will be deleted after 2 seconds.

## Entering user-defined labels

A user-defined label is an alphanumeric string which can have up to 13 characters. Such a label is entered directly on the DPM. If and how many user-defined labels can be entered depends on the corresponding setting in *SpeechExec Dictate*. For more information, refer to the Online Help delivered with the program.

When entering user-defined labels on the DPM you can use the characters A-Z and the numbers 0-9; spaces are also allowed.

To enter a user-defined label, do the following:

1. Press the Jog Dial for about two seconds to access the DPM menu.

The menu entry for user-defined labels is displayed first per default. If you have previously entered a user-defined label, the menu entry will display this label.

```
LABEL-1
9      OK ←→
```

2. To start editing the label, press the Jog Dial again.

```
OK ←→
9
↑
LABEL-1
```

**Note:** If the mandatory user input option for entering user-defined labels has been set in *SpeechExec Dictate*, you will immediately access the DPM menu at this level.

3. Select or change the first character/number of the label by moving the Jog Dial up or down. Confirm a character/number selection by pressing the Jog Dial.

```
OK ←→
89
↑
LABEL-1
```

4. When you have entered the complete label string, confirm by pressing the Jog Dial for about two seconds.

### Additional information

- If there is more than one user-defined label enabled, you will automatically go to the next label upon confirming the first label:

```
LABEL-2                                OK ←→
9      OK ←→                            9
↑                                         ↑
                                           LABEL-2
```

- To delete a character from a label string, press the DEL (Delete) button briefly. To discard any changes you have made and to exit the DPM menu, press the DEL button for about two seconds.
- To insert a character into a label string, press the INS/OVR (Insert/Overwrite) button.
- To move one character to the left, press the REC (Record) button.
- To re-use an already existing label without changing it, confirm the label by pressing the Jog Dial for about two seconds. The DPM will beep and you are required to confirm again.

## Assigning Keywords

The DPM allows you to personalize your dictations via predefined Keywords. For this purpose, you create a configuration file on the PC using *SpeechExec Dictate*. For DPM 9400 this configuration file can have up to five Keywords defined to be used on the DPM.

**Note:** Assigning Keywords as described below is only available if the DPM has not been configured with the **Linked Keywords** setting in *SpeechExec Dictate*.

**Note:** If the DPM has been configured with the **Barcode into Keywords** setting, you have to scan in the barcode information because this is a mandatory setting. In this case, you can later change the Keyword assignment manually via the DPM menu as described below.

## DPM 9400 - User Manual

Keywords are a combination of their usage definition and the content definitions for that usage. All this information is stored in the configuration file which is transferred to the DPM. On the DPM, the authors can select from the predefined entries and assign them to their dictations. These entries are saved together with the dictation and can finally be used by the transcriptionist for filtering the dictations.

For more information on DPM Keywords, refer to the *SpeechExec Dictate Online Help*.

### Example: Assigning Keywords

In the example, the following Keywords have been defined with the *SpeechExec Dictate*:

	<u>Keyword 1</u>	<u>Keyword 2</u>	<u>Keyword 3</u>	<u>Keyword 4</u>	<u>Keyword 5</u>
<u>Usage</u>	<i>Author</i>	<i>Patient</i>	<i>Document</i>	<i>Typist</i>	<i>Delivery</i>
<u>Content</u>	<i>Jones</i>	<i>Peter</i>	<i>Letter</i>	<i>Smith</i>	<i>Fax</i>
	<i>Singh</i>	<i>Steve</i>	<i>Memo</i>	<i>Simpson</i>	<i>Print</i>
	<i>Watson</i>	<i>Patricia</i>	<i>Report</i>	<i>Green</i>	<i>Email</i>

This information is transferred to the DPM where the author makes the required Keyword assignments.

Do the following:

1. Press the Jog Dial for about two seconds to access the DPM menu and display the Keyword's usage definition: *Author*

**AUTHOR:**  
Jones

OK ← 

**Note:** If a Keyword assignment has already been made, the current assignment is displayed as the menu entry, for example: *AUTHOR: Jones*

2. Confirm the Keyword selection by pressing the Jog Dial. The Keyword's content definitions are displayed: *Jones, Singh, Watson*
3. Move the Jog Dial to scroll to the name you want to assign.

OK ← 

**Singh**

4. Confirm your selection by pressing the Jog Dial and to return to the DPM main menu.
5. Assign a second Keyword by moving the Jog Dial to display its usage definition: *Patient*

**PATIENT:**

OK ← 

6. Confirm the Keyword selection by pressing the Jog Dial. The Keyword's content definitions are displayed: *Peter, Steve, Patricia*
7. Move the Jog Dial to scroll to the patient name you want to assign.

OK ← 

**Peter**

8. Confirm your selection by pressing the Jog Dial and to return to the DPM main menu.
9. Assign a third Keyword by repeating the steps from above: *Document*

**DOCUMENT:**

OK ← 

OK ← 

**Report**



10. Assign a fourth Keyword: *Typist*

```

TYPIST:                                     OK ←
                                     OK ←
                                     Green
    
```

11. Assign a fifth Keyword: *Delivery*

```

DELIVERY:                                 OK ←
                                     OK ←
                                     Fox
    
```

The selected Keyword definitions will be stored with your dictation. Any new dictation you create will be assigned the same information unless you select different Keyword definitions.

You can select different Keyword definitions as long as no recording has been done in the file. After recording has been done in the file, it is possible to choose different Keyword definitions on the DPM display. These changes will not take effect for the current file but from the next new file onwards.

**Note:** If the DPM goes into Power Save mode while assigning Keywords, the DPM is reactivated in Stop mode. Any unconfirmed Keyword assignments will have been discarded. You have to access the DPM menu and repeat the Keyword assignment.

### Scanning barcode information into Keywords

When using the DPM in combination with the DPM Barcode Scanner Module 9284, you can scan barcode information into the Keyword fields if the corresponding setting has been enabled in *SpeechExec Dictate*. For more information on this setting, refer to the Online Help delivered with the program.

**Note:** The **Barcode into Keywords** setting is a mandatory setting if your DPM has been configured with it.

When you create a new dictation file and have the Barcode Module attached, you must scan in the barcode information before you can start to record your dictation.

If no Barcode Module is attached to the DPM, the setting will be ignored.

#### Example: Barcode scanning

Keyword 1 has been configured as *patient ID* and Keyword 2 as *insurance no.* Keywords 3 - 5 are left empty. The DPM is configured for barcode input and the Barcode Module is attached. Do the following:

1. Make sure the DPM is in Stop mode and create a new dictation file, e.g. by pressing the REC (Record) button.

The DPM now expects the barcode input; on the DPM display this is indicated by the following screen:

```

    █ █ █ █   OK ←
patient ID:
    
```

2. Press the Jog Dial only briefly and release it again to set Barcode Scanning mode.
3. Scan the barcode. If the Barcode Module recognizes the barcode input, it will beep and the barcode information is displayed on the DPM.

```

    █ █ █ █   ?? OK
patient ID:
    235423-235
    
```

4. Confirm the barcode input for Keyword 1 by pressing the Jog Dial briefly.

**Note:** To discard the barcode input, press the DEL (Delete) button.

5. You are now asked for the Keyword 2 input.

```

    █ █ █ █   OK ←
insurance no.:
    
```

- Repeat steps 2 and 3 from above.

```

    |||   ?? OK
insurance no. :
AZ947382
    
```

- Confirm the barcode input for Keyword 2.

This concludes the mandatory barcode input. You can now start to record your dictation.

For more information on the DPM Barcode Scanner Module 9284, refer to the documentation delivered with the product.

### Linked Keywords

When the **Linked Keywords** setting is enabled in *SpeechExec Dictate* and the DPM has been configured with this setting, you can transfer sets of Keyword strings to the DPM. These sets can then be selected on the DPM and assigned to a dictation file.

A Keyword set is the sum of all content definitions which have been made in *SpeechExec Dictate* in the same row (see below). The name of the Keyword set is taken from the usage definition of Keyword 1; this name is also displayed on the DPM when you enter the DPM menu. The usage definitions of any other Keywords are ignored.

#### Example: Linked Keywords

The usage definition of Keyword 1 is *patient*; the content definitions of the Keyword 1 column are patient names. Keyword 2 is the department, Keyword 3 the patient ID, Keyword 4 a comment, Keyword 5 the patient's gender. In this example, a Keyword set thus combines all of this patient data.

The **Keyword Definition** tab in *SpeechExec Dictate* is as follows:

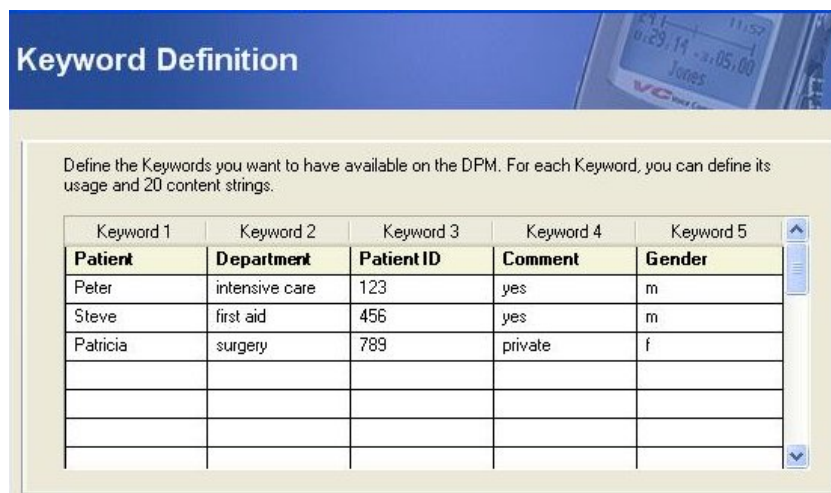

This defines the following Keyword sets:  
 Keyword set 1 = *Peter, intensive care, 123, yes, m*  
 Keyword set 2 = *Steve, first aid, 456, yes, m*  
 Keyword set 3 = *Patricia, surgery, 789, private, f*

After this configuration has been transferred to the DPM, the Keyword sets can be selected on the DPM as follows:

- Press the Jog Dial for about two seconds to access the DPM menu. The Keyword set name (taken from the usage definition of Keyword 1) is displayed. If a Keyword set has already been assigned previously, two of the content definitions of the currently assigned set are also displayed, for example:

```

PATIENT:
Peter
Intensive care
    OK ←
    
```

- Press the Jog Dial again to access the available Keyword sets. The currently assigned set is displayed:

```

      OK ←→
Peter
Intensive care
123
yes
m
    
```

- Move the Jog Dial to scroll to the Keyword set you want to assign.

```

      OK ←→
Steve
First aid
456
yes
m
    
```

- Confirm the new assignment by pressing the Jog Dial and to return to the DPM main menu. The menu entry displays the new Keyword set:

```

PATIENT:
Steve
First aid
      OK ←→
    
```

This Keyword set is now assigned automatically to any new dictation file.

**Note:** The **Linked Keyword** setting and the **Barcode into Keywords** setting do not overrule each other. If the DPM has been configured with both settings, you will have to scan in the barcode information first (mandatory setting). To overwrite the barcode information with a Keyword set, enter the Keyword menu manually and change the assignment.

### Recording spoken instructions

Spoken instructions can be compared to comments which are recorded by the author during dictation. They are stored within the dictation sound file at the position in the sound file where the instruction was actually recorded. Examples for spoken instructions are 'insert a paragraph here' or 'correct spelling is Z E L A Z O W S K I'.

DPM 9400 supports the recording of spoken instructions for your dictations. Spoken instructions can only be inserted in Recording mode.

To insert an instruction, do the following:

- Make sure that the DPM is in Recording mode and that the device is disconnected from your PC. Otherwise the DL/S.Instr button has the download function.
- Press and hold the DL/S.Instr button for at least 1 second to insert your spoken instruction.
- Keep the button pressed as long as you record your spoken instruction. When you are finished, release the button and continue with your normal dictation.

A spoken instruction appears as a thick horizontal bar on the status bar of the DPM display. The pictures below show the DPM display while a spoken instruction is being recorded and after you have returned to normal recording.

```

SP 11:54
|-----|
|-----|
0:16:14
INSTR 1
    
```

```

SP 11:54
|-----|
|-----|
0:16:35
INSTR 1
    
```

- To insert another spoken instruction, follow the steps from above.

```

SP 11:55
|-----|
|-----|
0:17:15
INSTR 2
    
```

### Recording spoken instructions in Overwrite mode

When Overwrite mode is enabled on your DPM, the behavior is as follows:

- Spoken instructions will be overwritten, partially or completely, without any warning.
- When you start normal recording inside a spoken instruction and finish recording before you have reached the end of the spoken instruction, the instruction is split into two parts.

For example, you have a spoken instruction with a length of 12 seconds. You position inside the instruction at 5 seconds and do normal recording for 5 seconds. Your sound file will then have a spoken instruction of 5 seconds followed by normal recording of 5 seconds followed by the remainder of the instruction of 2 seconds.

However, the total length of the instruction has been decreased to 7 seconds because the middle part has been overwritten with the normal recording.

### Recording spoken instructions in Insert mode

When Overwrite mode is enabled on your device, the behavior is as follows:

- When you insert a spoken instruction before an existing one, the numbering of the consecutive instructions is increased by 1. For example, if you inserted an instruction before *INSTR 2*, *INSTR 2* would become *INSTR 3*, *INSTR 3* would become *INSTR 4* and so on.
- When you insert normal recording into an existing spoken instruction, the spoken instruction is split into two individual instructions. The total number of instructions in your sound file is increased by 1. However, the contents of the instruction are preserved and not overwritten.

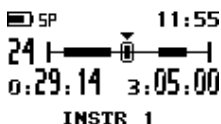

### Additional information

- When you fast forward or fast rewind the file, the device will interrupt the current action at the insertion point of a spoken instruction for about 1 second and it will beep. The action is then continued automatically.

While the device stops at a spoken instruction, the corresponding string is displayed on the device:

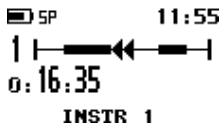

- In Playback mode, only the spoken instruction string is shown on the display when the playback cursor moves over a spoken instruction. The device will not beep and playback will not be interrupted.
- You can insert up to 32 spoken instructions into one file.
- You cannot insert spoken instructions into dictations which have been finished with EOL.
- You cannot insert an index mark into a spoken instruction.

### Deleting spoken instructions

Deleting a spoken instruction is similar to deleting a section from the sound file. Do the following:

1. Go to the beginning of the spoken instruction and press the DEL button once.

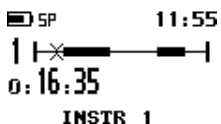

2. Go to the end of the spoken instruction and press the DEL button again.

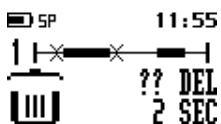

3. Confirm the delete operation by pressing the DEL button for at least two seconds.

### Transferring data between DPM and PC

You can use your DPM as part of the workflow management for exchanging and transferring data with the PC. With *SpeechExec Dictate*, you make settings and choose options on how to operate the device. This data can then be downloaded and is stored on the DPM. With the DPM you create your dictations which are then transferred to the PC for further processing.

## DPM 9400 - User Manual

Depending on how you have configured the download process with *SpeechExec Dictate*, the download process is either started automatically or by pressing the DL/S.Instr button on the DPM. You can also configure whether individual sound files or all of the sound files will be transferred from the DPM to the PC.

To transfer data from the DPM to the PC with the automatic download functionality enabled in the DPM Download/Configuration program, do the following:

1. Make sure the DPM is connected to the PC and that the 4-Position Switch is in the Stop position (DPM 9400/00: ●, DPM 9400/52: STOP).

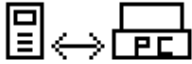



The data transfer is started either automatically or by pressing the DL/S.Instr button on the DPM, depending on how you have configured the download process.

2. The progress of the file transfer is displayed.



3. When the download is finished, one of the following symbols will appear:

- The download finished successfully: 
- The download did not succeed: 

**Note:** Whether the downloaded files on the DPM are deleted after transferring depends on the corresponding settings in *SpeechExec Dictate*.

### Additional information

- During transfer and as long as the DPM is connected to the PC, all buttons and switches on the DPM are inactive.
- For more information on the different download configuration options, including the automatic download procedure, refer to the *SpeechExec Online Help* or the *User Manual* delivered with the CD.

### Mandatory user input

*SpeechExec Dictate* enables you to configure the DPM in such a way that mandatory information must be provided before you can start a recording. The mandatory user input options are:

- Mandatory **Keyword** input: This means that the menu entry for assigning Keywords is displayed automatically on the DPM when you create a new dictation. You cannot start recording the dictation unless you make selections for all predefined Keywords available on the DPM.
- Mandatory **user-defined label**: This means that the menu entry for entering user-defined labels is displayed automatically when you create a new dictation. You cannot start recording the dictation unless you enter the required user-defined labels. For information on entering labels, refer to the *Entering user-defined label* section in this manual.

## **Appendix: Troubleshooting the DPM**

If you have problems with your DPM, please try the following before you contact your vendor.

### **Nothing appears on the DPM display**

- The batteries are not loaded properly: Verify that the polarity is correct.
- The batteries are dead: Change the batteries.
- The DPM is turned off: Turn the DPM on.

### **DPM warning:**

- The memory card cannot be read. Try a different memory card or a different type of memory card.
- The memory card is not formatted: Format the memory card via the DPM menu.
- One of the DPM buttons could be stuck: Make sure none of the buttons is stuck.

### **DPM is inactive**

- The DPM is turned off: Turn the DPM on.
- The batteries are dead: Change the batteries.

### **Recording is not possible**

- There is not enough space left on the memory card: Delete files from the memory card or use a new memory card.
- The memory card is not formatted: Format the memory card.

### **No sound during playback**

- The volume is turned down (0): Turn the volume up.
- Earphones are plugged into the DPM: Unplug the earphones to listen to playback via the built-in loudspeaker.

### **Deleting files is not possible**

- The file has been finished with EOL: Remove the EOL attribute from the file by pressing the L/P or EOL/P (End-of-Letter and Priority) button once.
- Your memory card, of the type SD, is write-protected (

### **Wrong file**

- The wrong file is being played back: Open the correct file.

### **Connection to the PC is not possible**

#### **USB driver has not been installed properly**

Solution: Check whether the USB drivers have been installed correctly. If you did not complete the installation of the USB driver or canceled the 'Unknown device detected' process the first time you connected the DPM to your PC. Proceed as follows:

1. Connect the DPM to your PC.
2. Go to the **Start** menu, **Settings, Control Panel, System, Device Manager**.
3. Look for an unknown USB device in the list.
4. Select the **Unknown Device** and click **Remove**.
5. Click **OK** and close the **Control Panel** window.
6. Disconnect the DPM and reconnect it again.
7. The **Add New Hardware Wizard** is started. Click **Next**.
8. Follow the instructions which appear on the screen. When the wizard detects the driver (USB Mass Storage Device), click **Next** to copy the driver to your PC.
9. On the last wizard page, click **Finish** to complete the installation.

#### **Windows XP**

When installing the DPM, the operating system automatically assigns a drive for the DPM. This drive appears as a 'removable disk' in the Windows Explorer. Sometimes, the drive letter assignment for the DPM conflicts with an existing drive letter mapping; this is why the DPM cannot be seen in the Windows Explorer. Additionally, *SpeechExec Dictate* displays the DPM status as **DPM (disconnected)**.

Solution: Mount all network drives starting with drive letters Z, Y, X (in reverse alphabetical order).

## ***DPM 9400 - User Manual***

### **PC sound system is not functioning**

- The DPM is used as a USB sound device: Open the **Sounds and Multimedia Properties** dialog box in the Control Panel. Make sure your PC's sound system is the **Preferred device** selection. Activate the **Use only preferred devices** option.

### **Recharging batteries is not possible**

- The DPM is turned on and connected to the PC with download mode activated: Turn the DPM off to start recharging.

**Important:** The DPM can only recharge the rechargeable Philips NiMH batteries LFH 9144.

## Index

- 4**
- 4-Position Switch
  - Lock/Hold switch, 5
  - Playback, 14
- A**
- Advanced display, 7
- Advanced operations, 18
- Appearance, 7
- Assign
  - Keywords, 8
- Authors, 20
- Automatic recording, 10, 16
- B**
- Backlight, 10
- Barcode into Keywords, 21
- Barcode scanning, 21
- Basics, 12
- Batteries, 4
  - Recharge, 4
- Beep, 10
- Button
  - DEL, 15
  - DL/S.Instr, 23
  - EOL, 13
  - Fast Forward, 15
  - INS/OVR, 14
  - L/P, 13
  - Priority, 13
  - REC, 12
- C**
- Card, 5
- Configuration file, 20
- Contrast, 11
- D**
- Data transfer, 24
- Date (DPM 9400/00), 8
- Date (DPM 9400/52), 9
- DEL, 15
- DEL button, 15
- Delete
  - File, 16
  - Section, 15
  - Spoken instruction, 24
- Delete operations, 15
- Dictation
  - DPM 9400/00, 12
  - DPM 9400/52, 13
- Display, 3
- DL/S.Instr, 23
- DL/S.Instr button, 23
- DPM
  - Activate, 5
  - Batteries, 4
  - Formatting the memory card, 5
  - Graphic, 2
  - Keywords, 20
  - Memory card, 5
  - Overview, 2
  - Troubleshooting, 26
  - DPM 9400/00, 8, 12
    - VA, 16
  - DPM 9400/52, 9, 13
    - VA, 17
  - DPM display, 7, 10, 11
  - DPM menu, 7, 8, 9, 10, 11
- E**
- End-of-Letter button, 13
- Entering user-defined labels, 19
- EOL, 13
- EOL button, 13
- F**
- Fast Forward, 15
  - DPM 9400/00, 15
  - DPM 9400/52, 15
- Fast Rewind, 15
  - DPM 9400/00, 15
  - DPM 9400/52, 15
- Features, 1
- FFWD, 15
- File
  - Delete, 16
  - Skip Back, 17
  - Skip Forward, 17
- First steps, 12
- Format for recording
  - Long Play mobile, 16
  - Standard Play, 16
- Formatting
  - Memory card, 5
- FRWD, 15
- G**
- Getting started, 5
- Graphic
  - DPM, 2
- I**
- Index marks, 18
- INS/OVR, 14
- INS/OVR button, 14
- Insert, 24
  - Memory card, 5
- Insert mode, 14
- Inserting index marks, 18
- Instructions
  - Record, 23
- Introduction, 1
- J**
- Jog Dial, 7
  - Keywords, 20
  - Skip Back, 17
  - Skip Forward, 17
  - Volume, 14
- K**
- Keywords, 20
  - Barcode information, 21
  - DPM menu, 8



- Linked, 22
- L**
- L/P, 13
- L/P button, 13
- Label, 19
- LCD display, 3
- LED, 12, 13
  - Green, 14
  - Red, 14
- Linked Keywords, 22
- Lock/Hold switch, 5
- Long Play mobile, 9, 16
- M**
- Memory card, 5
  - Format, 5
  - Insert, 5
  - Reformat, 11
- Menu, 7
  - Backlight, 10
  - Contrast, 11
  - Date and time, 8, 9
  - Device beep, 10
  - Keywords, 8
  - Microphone sensitivity, 10
  - Recording time, 11
  - Reformatting the memory card, 11
  - SP/LPm, 9
  - User-defined label, 8
  - Voice-activated recording, 10
- Microphone sensitivity, 10
- MMC, 5
- Mode
  - Insert, 14
  - Overwrite, 14
  - Power Save, 11
  - Record Standby, 12
- O**
- Operations
  - Advanced, 18
  - Basic, 12
- Overwrite, 23
- Overwrite mode, 14
- P**
- Package contents, 1
- Playback, 14
- Power Save mode, 11
- Priority, 13
- Priority button, 13
- Program
  - SpeechExec Dictate, 24
- R**
- REC, 12, 13
- REC button, 12
- Recharge
  - Batteries, 4
- Record, 13
  - Instructions, 23
- Record LED, 12, 13
- Record Standby, 12
- Recording
  - DPM 9400/00, 12
  - DPM 9400/52, 13
  - Recording format
    - Long Play mobile, 9, 16
    - Standard Play, 9, 16
  - Recording mode
    - Insert, 14
    - Overwrite, 14
  - Recording time, 11
  - Reformat
    - Memory card, 11
- S**
- Scan
  - Barcode, 21
- SD, 5
- Section (sound file)
  - Delete, 15
- Skip Back, 17
- Skip Forward, 17
- Software
  - SpeechExec Dictate, 20, 24
- Sound file
  - Delete - file, 16
  - Delete section, 15
  - Playback, 14
  - Skip Back, 17
  - Skip Forward, 17
- Sound file format
  - Long Play mobile, 9, 16
  - Standard Play, 9, 16
- SP/LPm, 9, 16
- SpeechExec Dictate, 20, 24
- Spoken instruction
  - Delete, 24
  - Insert mode, 24
  - Overwrite mode, 23
- Spoken instructions, 23
- Standard display, 7
- Standard Play, 9, 16
- Start screen, 6
- Symbols, 3
- T**
- Time (DPM 9400/00), 8
- Time (DPM 9400/52), 9
- Transfer
  - Data, 24
- Troubleshooting, 26
- U**
- User-defined label, 19
  - DPM menu, 8
- V**
- VA, 10, 16
  - DPM 9400/00, 16
  - DPM 9400/52, 17
- Voice-activated recording, 10, 16
- Volume, 14
- W**
- Warning, 26
- Winding, 15
  - DPM 9400/00, 15



## Free Manuals Download Website

<http://myh66.com>

<http://usermanuals.us>

<http://www.somanuals.com>

<http://www.4manuals.cc>

<http://www.manual-lib.com>

<http://www.404manual.com>

<http://www.luxmanual.com>

<http://aubethermostatmanual.com>

Golf course search by state

<http://golfingnear.com>

Email search by domain

<http://emailbydomain.com>

Auto manuals search

<http://auto.somanuals.com>

TV manuals search

<http://tv.somanuals.com>