

SMARTLOADER

Clon99-BK

Instructions for use



Let's make things better.



PHILIPS

TABLE OF CONTENTS

Table of Contents	2
Safety/Precautions.....	2
Introduction.....	2
Getting Started	3
Battery Installation.....	3
Connecting the Clon99-BK Box.....	4
Erasing Memory	5
Reading Memory	6
Programming (Writing) Memory to a TV	7
Running a System Test	8
Exiting the Menu System	9
Programming with the On-Set Keyboard.....	10
On-Screen Displays for Non-Global TV using the Transmitter	11
On-Screen Displays for Non-Global TV using the On-Set Keyboard.....	12
Index	12

Optimum Performance of the Clon99-BK SmartLoader box is obtained by plugging it into an ITV set that is already turned on.

KNOW THESE SAFETY SYMBOLS



▲ This “bolt of lightning” indicates uninsulated material within your unit which may cause an electrical shock. For the safety of everyone in your household, please do not remove product covering.

▲ The “exclamation point” calls attention to features for which you should read the enclosed literature closely to prevent operating and maintenance problems.

WARNING: TO PREVENT FIRE OR SHOCK HAZARD, DO NOT EXPOSE THIS EQUIPMENT TO RAIN OR MOISTURE.

CAUTION: To prevent electric shock, match wide blade of plug to wide slot, and fully insert.

ATTENTION: Pour éviter les chocs électriques, introduire la lame la plus large de la fiche dans la borne correspondante de la prise et pousser jusqu'au fond.

For Customer Use:

Enter below the Serial No. which is located on the product. Retain this information for future reference.

Model No _____

Serial No. _____

INTRODUCTION

Assembling and operating your Philips Clon99-BK SmartLoader is designed to be an easy process. The purpose is to allow you to more easily program a number of televisions using just a few simple steps.

The Clon99-BK SmartLoader replaces the RL-5180CK model. The Clon99-BK SmartLoader is compatible with all Philips SmartPort and ClonPort TV sets including Global 1999 models from the PL9XXX, PC9XXX, and PA9XXX series.

Please be sure that you have the following material before beginning any procedures with the Clon99-BK SmartLoader box.

- A television capable of sending and receiving Clon99-BK SmartLoader information on TV settings.
- One 9-volt battery (for the Clon99-BK SmartLoader).
- Remote Control RG4172BK (T374AH).
- Three AA batteries for the remote control.
- Cable (6-conductor included with the Clon99-BK SmartLoader)

Please thoroughly read all the procedures listed within this booklet before starting any process.

Clon99™, SmartCard™, SmartLoader™, SmartPort™ ClonPort™ are registered trademarks of the Philips Consumer Electronics Company. © 1999 Philips Consumer Electronics Company.

GETTING STARTED

CAUTION:

Failure to follow these instructions may result in product damage. Please read all instructions before beginning.

Battery installation Clon99-BK SmartLoader

Before operating the Clon99-BK SmartLoader, load a 9-volt battery into the compartment in the bottom of the Clon99-BK SmartLoader.

(BEGIN)

- 1 Slide the compartment lid in the direction indicated by the triangle.
- 2 Plug the battery into the battery cable, then place the battery in the compartment.
- 3 Replace the compartment lid.

Battery installation RG4172BK (T374AH) Remote Control

Before operating the Remote Control, please load the three AA batteries into the compartment in the bottom of the Remote Control.

(BEGIN)

- 1 Press the tab on the battery lid and lift off the remote.
- 2 Following the diagrams inside the Remote Control, load the batteries.
- 3 Then replace the battery lid. Point the Remote Control at the TV and see if it turns on the TV. If it does not, repeat this step.

SMART HELP



Remember. Always be sure to check the polarity of the batteries before inserting them in the Clon99-BK SmartLoader or the RG4172BK (T374AH) Remote Control.

Clon99-BK SmartLoader Battery Installation

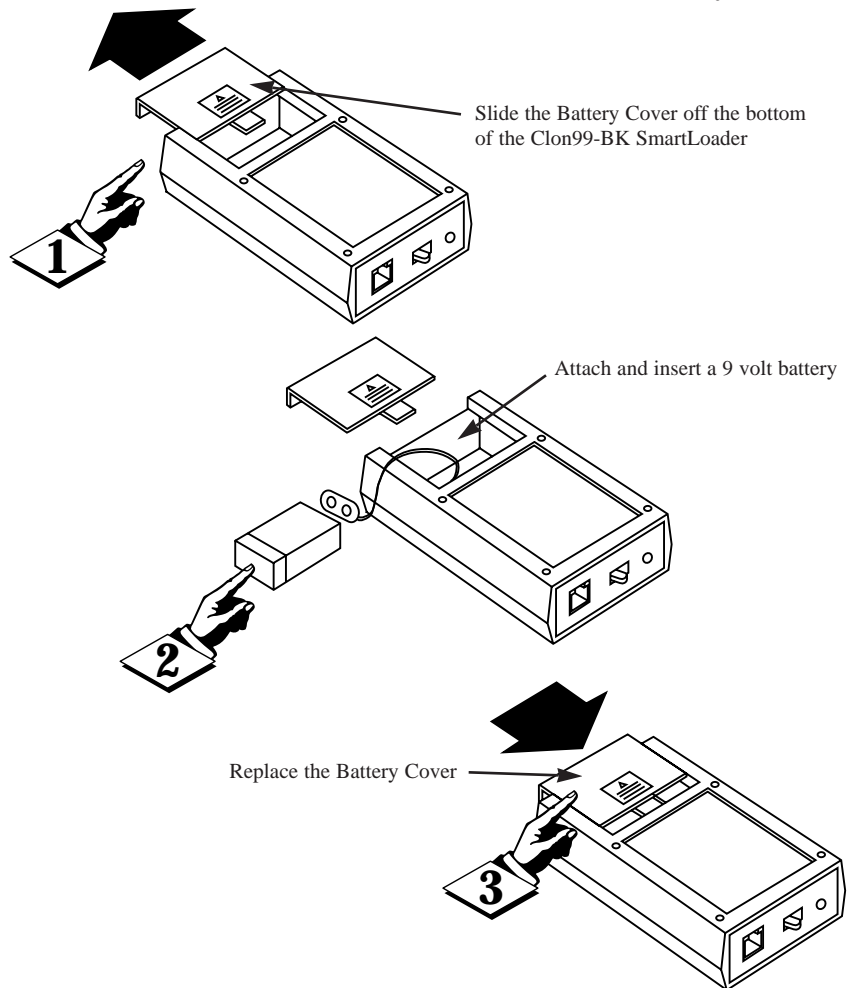

RG4172BK (T374AH) Remote Control Battery Installation

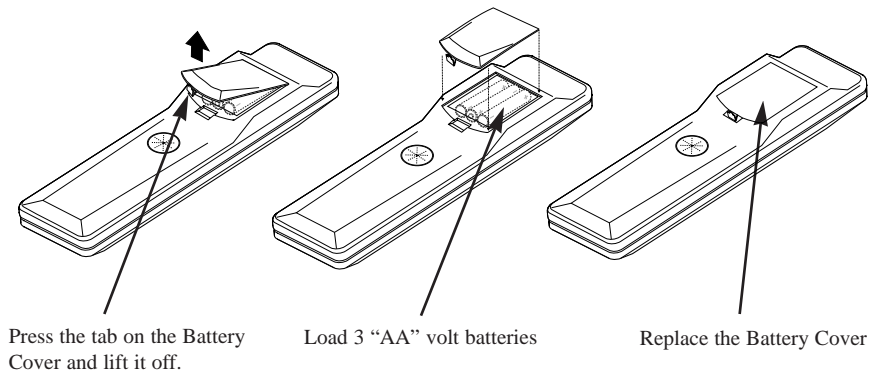

CONNECTING THE CLON99-BK SMARTLOADER

Optimum Performance of the Clon99-BK SmartLoader box is obtained by plugging it into an ITV set that is already turned on.

BEGIN

- 1** Press the POWER button to turn the ITV ON.
- 2** Plug one end of the cable into the jack provided on the Clon99-BK SmartLoader.
- 3** Plug the other end into the jack provided on the back of the TV. The TV's jack is next to the Antenna Input terminal and may be labeled various ways such as; Smart Port, Clone Port, etc.
- 4** Push the Slide Switch to the ON position. The red LED should light. (If the TV is turned off, it should turn on within 15 seconds.)
- 5** Within 20 seconds, the Clon99-BK SmartLoader on-screen display should appear. If the display does not appear, check the connections and push the Slide Switch to the ON position again. If there is still no response from the SmartLoader, replace its 9-volt battery.
- 6** Once the Clon99-BK SmartLoader on-screen display appears, press the POWER button on the RG4172BK (T374AH) Remote Control. The SmartLoader Setup Menu should appear.

Clon99-BK SmartLoader Connection

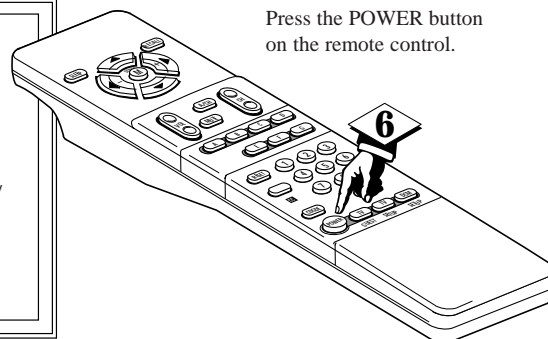
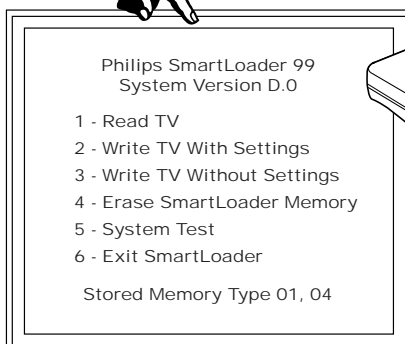
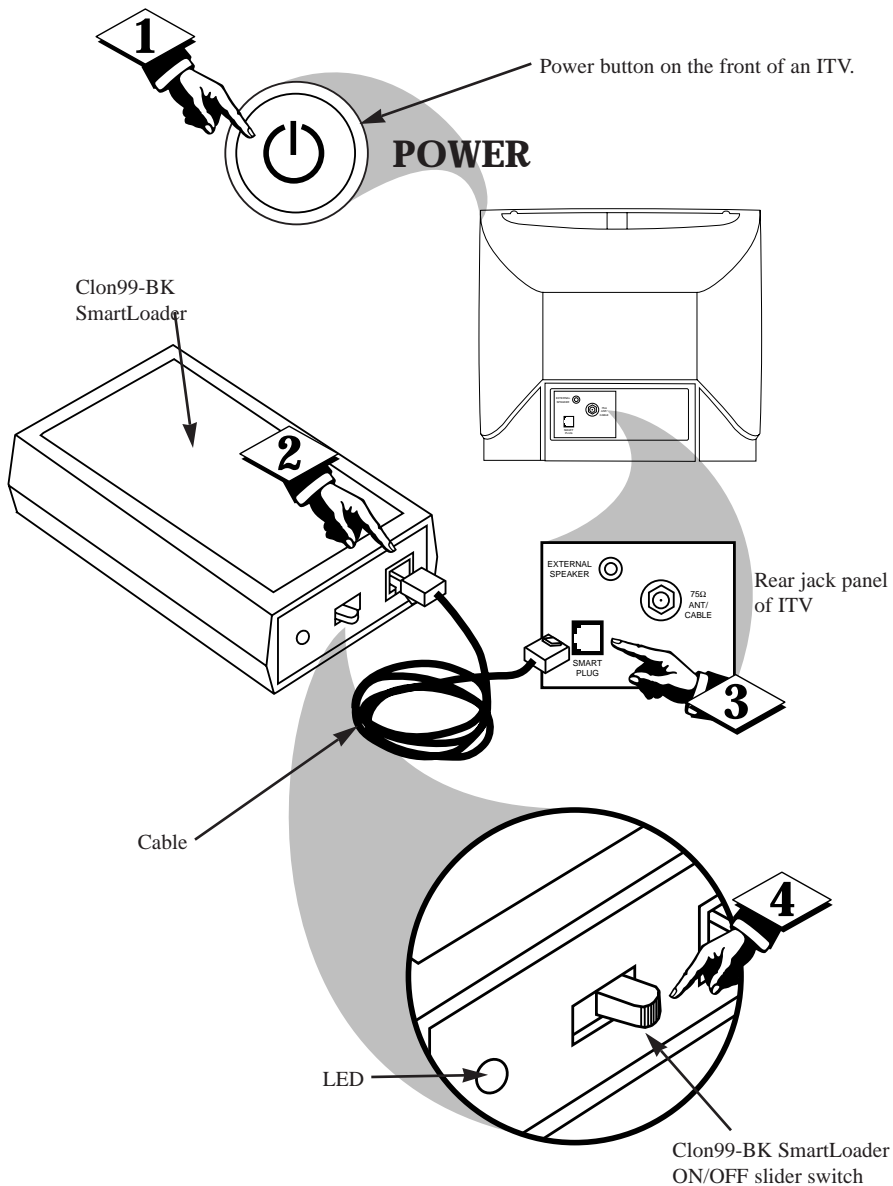

ERASING MEMORY OR DATA

ERASE MEMORY

To read and save the television memory, it is first necessary to erase any currently saved data in the Clon99-BK SmartLoader. If the "Stored Memory Type" indicates no data is saved currently, you may bypass the ERASE MEMORY operation and move directly to the READ MEMORY operation.

BEGIN

- 1 With the Clon99-BK SmartLoader on-screen display showing, press the POWER button on the remote control
- 2 The Setup Menu will appear. Press the Number 4 button on the Remote Control to select the 4th option "Erase SmartLoader Memory."
- 3 The screen will ask "Erase?" Press the 0 button on the remote to confirm and begin the procedure.
- 4 The screen will indicate "Memory Erased" when the data has been erased for the Clon99-BK SmartLoader.

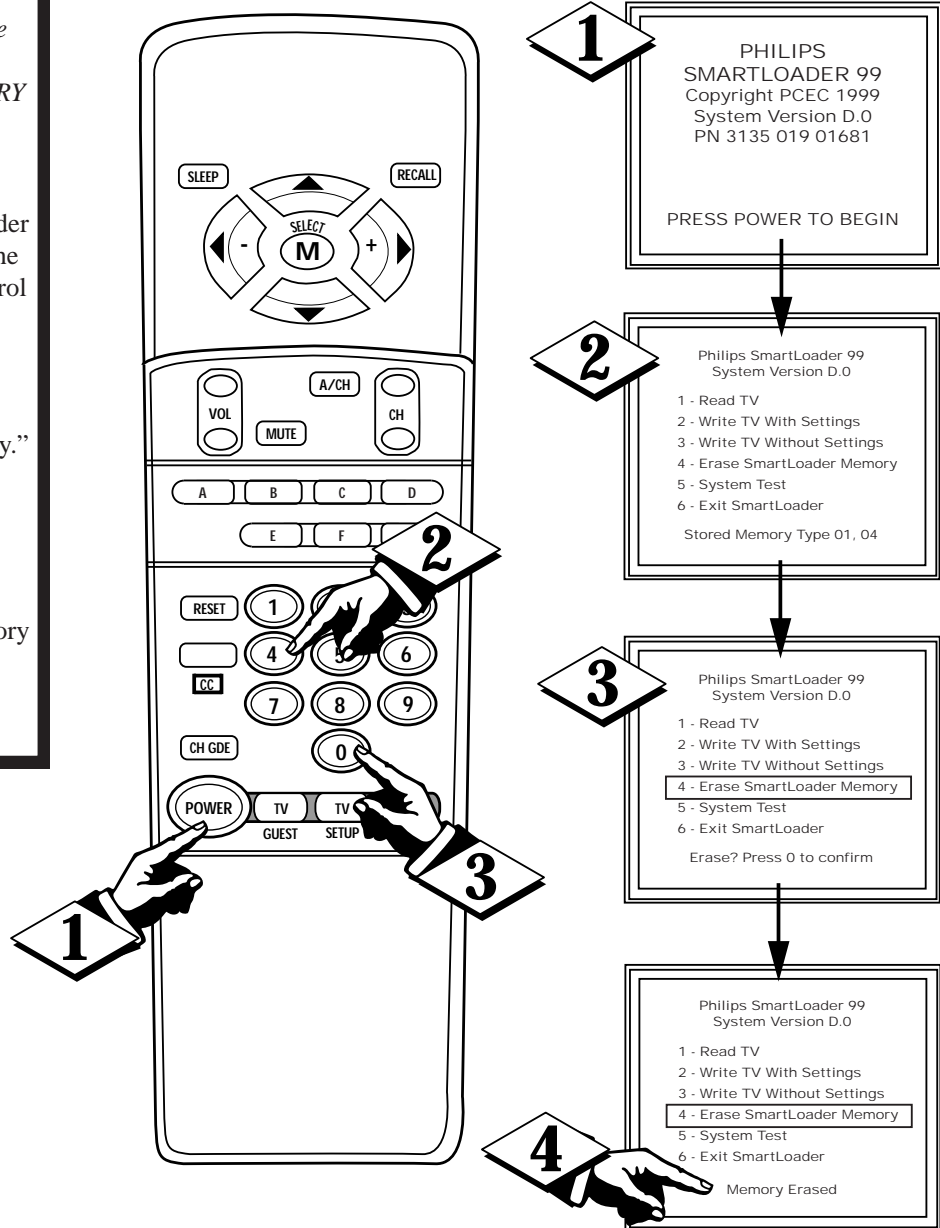

READING MEMORY OR DATA

READ MEMORY

Once the memory has been erased, the Clon99-BK SmartLoader is ready to read a television's memory. Follow the steps below to complete the procedure.

(BEGIN)

- 1 With the Clon99-BK SmartLoader on-screen display showing, press the POWER button on the remote control.
- 2 The Setup Menu will appear. Press the Number 1 button on the Remote Control to select the first option "Read TV."
- 3 The on-screen display will ask, "Read?" Press the 0 button to confirm and begin the Read procedure.
- 4 The on-screen menu will reading blocks of data on the bottom of the display.
- 5 Once the "Read" procedure is complete, "Finished Reading Memory" will appear at the bottom of the display.
- 6 Disconnect the SmartLoader cable from the back of the TV to complete the "Read TV" operation or another Numbered button to choose a different option.

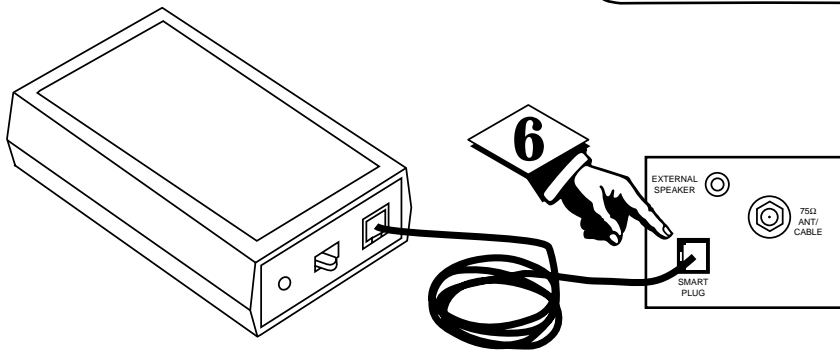
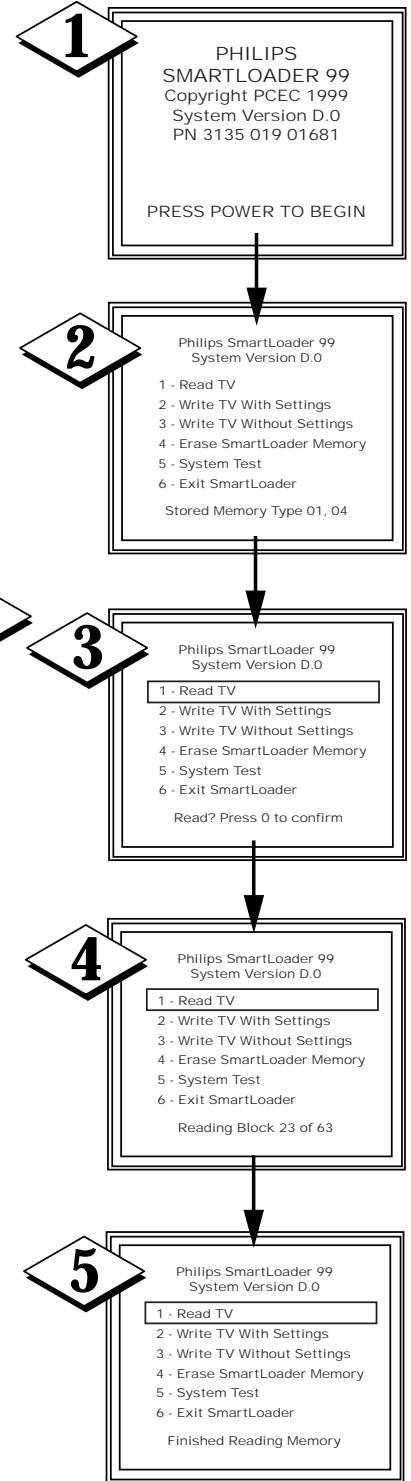
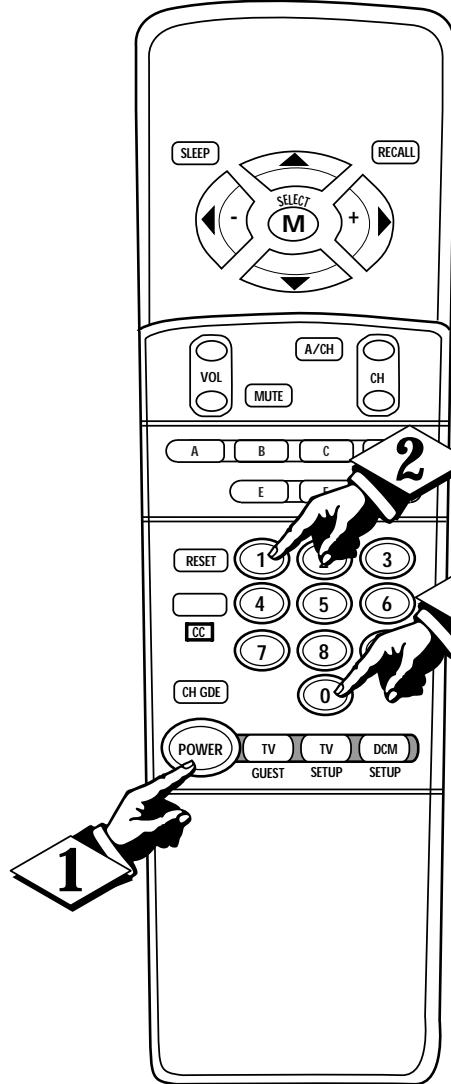

PROGRAMMING A TELEVISION'S INTERNAL MEMORY

WRITING TV MEMORY

After the Memory has been read from one television, the Clon99-BK SmartLoader is now ready to write the memory to other televisions. This memory can be written with or without certain settings. These settings include: Picture Adjustment, Minimum and Maximum Volume, and the On Volume settings.

BEGIN

- 1 Plug one end of the cable into the jack provided on the SmartLoader. Then plug the other end into the jack provided on the back of the TV. The TV jack is next to the Antenna Input terminal.
- 2 Push the Slide Switch to the ON position on the SmartLoader. If the TV is currently off, it should turn on within 15 seconds.
- 3 Within 20 seconds, the SmartLoader on-screen display should appear on the TV screen. If the display does not appear, check connections and push the Slide Switch to the ON position again. If there is still no response from the SmartLoader, replace its 9-volt battery.
- 4 Press the POWER button on the remote to display the Clon99-BK SmartLoader Setup Menu.
- 5 With the Setup Menu visible, press the Number 2 button on the Remote Control to select the 2nd option "Write TV With Settings" or press the Number 3 button to select the third option "Write TV Without Settings."
- 6 The screen will ask "Write?" Press the 0 button on the remote to confirm and begin the procedure.
- 7 The screen will indicate "Writing Block 24 of 63" while the Clon99-BK SmartLoader is downloading the data.
- 8 The display will then read "Finished Writing Memory" when the procedure has been completed.

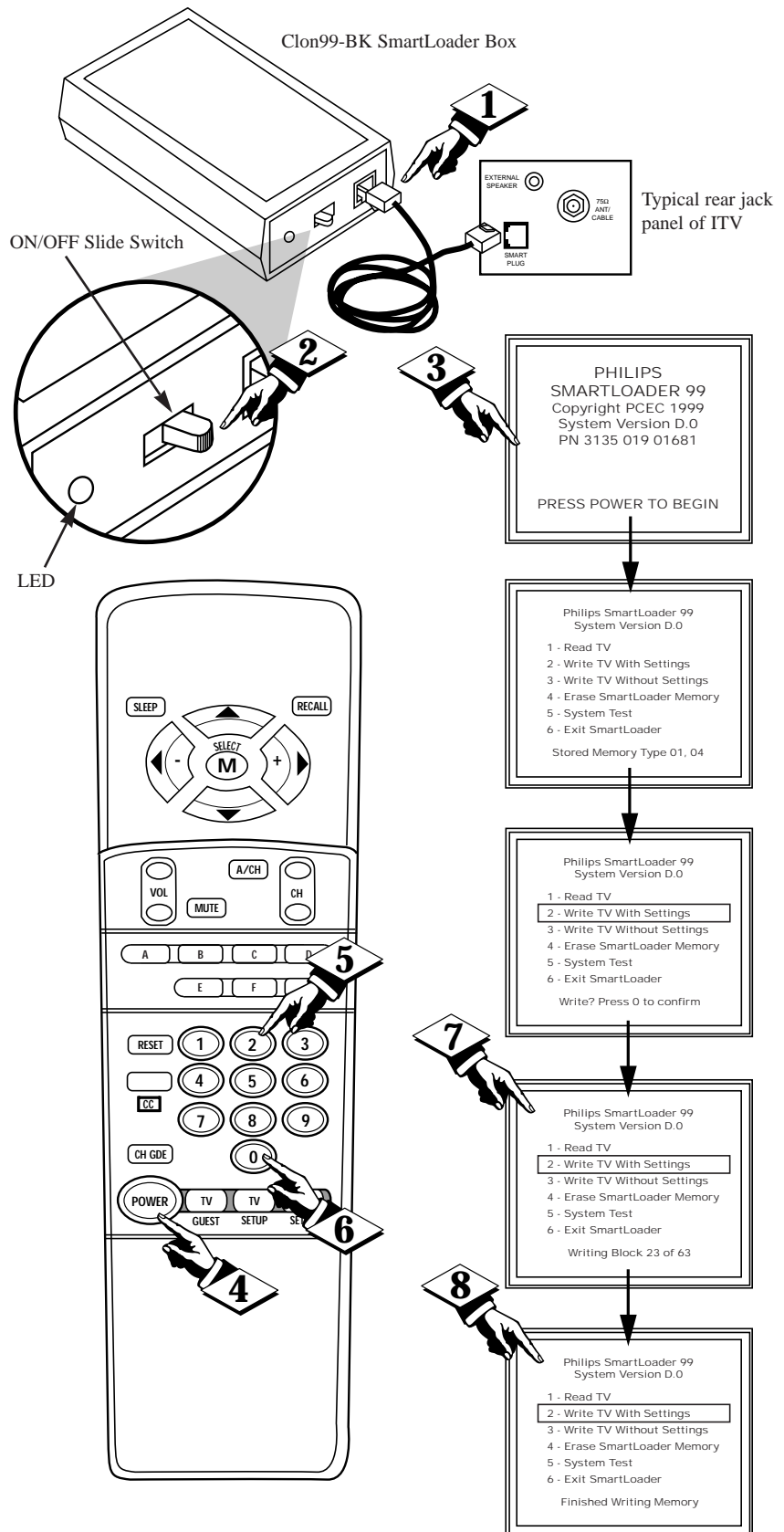

RUNNING A SYSTEM TEST

SYSTEM TEST

A System Test of the Clon99-BK SmartLoader can be performed by following the steps below.

BEGIN

- 1 With the Clon99-BK SmartLoader on-screen display showing, press the POWER button on the remote control
- 2 The Setup Menu will appear. Press the Number 5 button on the Remote Control to select the 5th option "System Test."
- 3 The screen will ask "Test?" Press the 0 button on the remote to confirm and begin the procedure.
- 4 As the System Test proceeds, the display will prompt the user to press the Number 1 button or the A/CH button to continue or skip to the next part of the test.
- 5 When the display shows "Test Finished," press the Number 1 button to return to the Clon99-BK SmartLoader Setup Menu.

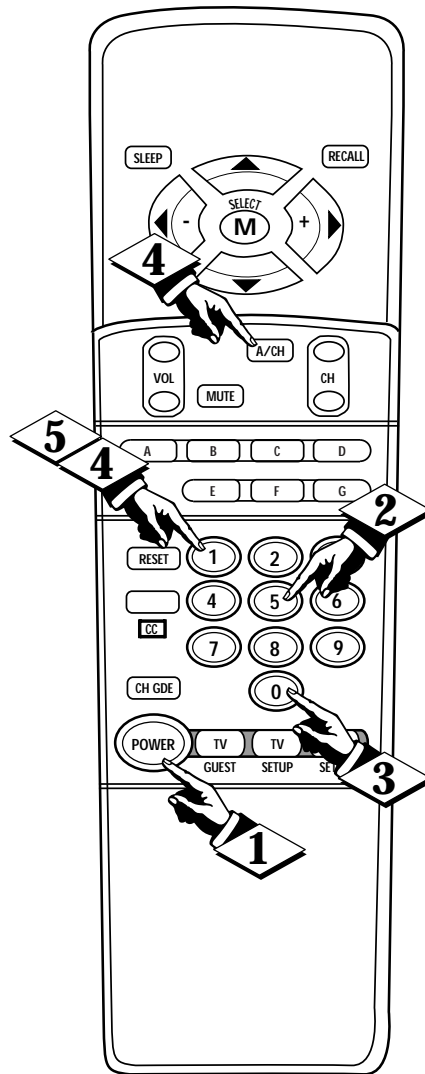

```

PHILIPS
SMARTLOADER 99
Copyright PCEC 1999
System Version D.0
PN 3135 019 01681

PRESS POWER TO BEGIN
    
```

```

Philips SmartLoader 99
System Version D.0

1 - Read TV
2 - Write TV With Settings
3 - Write TV Without Settings
4 - Erase SmartLoader Memory
5 - System Test
6 - Exit SmartLoader

Stored Memory Type 01, 04
    
```

```

Philips SmartLoader 99
System Version D.0

1 - Read TV
2 - Write TV With Settings
3 - Write TV Without Settings
4 - Erase SmartLoader Memory
5 - System Test
6 - Exit SmartLoader

Test? Press 0 to confirm
    
```

```

.....
SmartLoader 99
System Test
.....

Press 1 to Continue
    
```

```

.....
Display Registration
12 Rows by 32 Columns
.....
0123456789012345678901
.....
Press 1 to Continue
    
```

```

.....
Character Set Display
!@#$%^&'()*+,-./01234
56789:;<=>?@ABCDEF
GHIJKLMNOPQRSTUVWXYZ
.....
Press 1 to Continue
    
```

```

.....
Check +12V Power Supply
12V Detected
.....

Press 1 to Continue
    
```

```

.....
IR Test
Press A/CH to Continue
.....

Press 1 to Skip
    
```

```

.....
IR Test
A/CH detected, IR good
.....

Press 1 to Continue
    
```

```

.....
Test Finished
.....

Press 1 to Continue
    
```



EXITING THE CLON99-BK SMARTLOADER MENU

EXIT SMARTLOADER

When you have completed all the procedures you wish to perform, exiting the Clon99-BK SmartLoader and shutting down is simple.

BEGIN

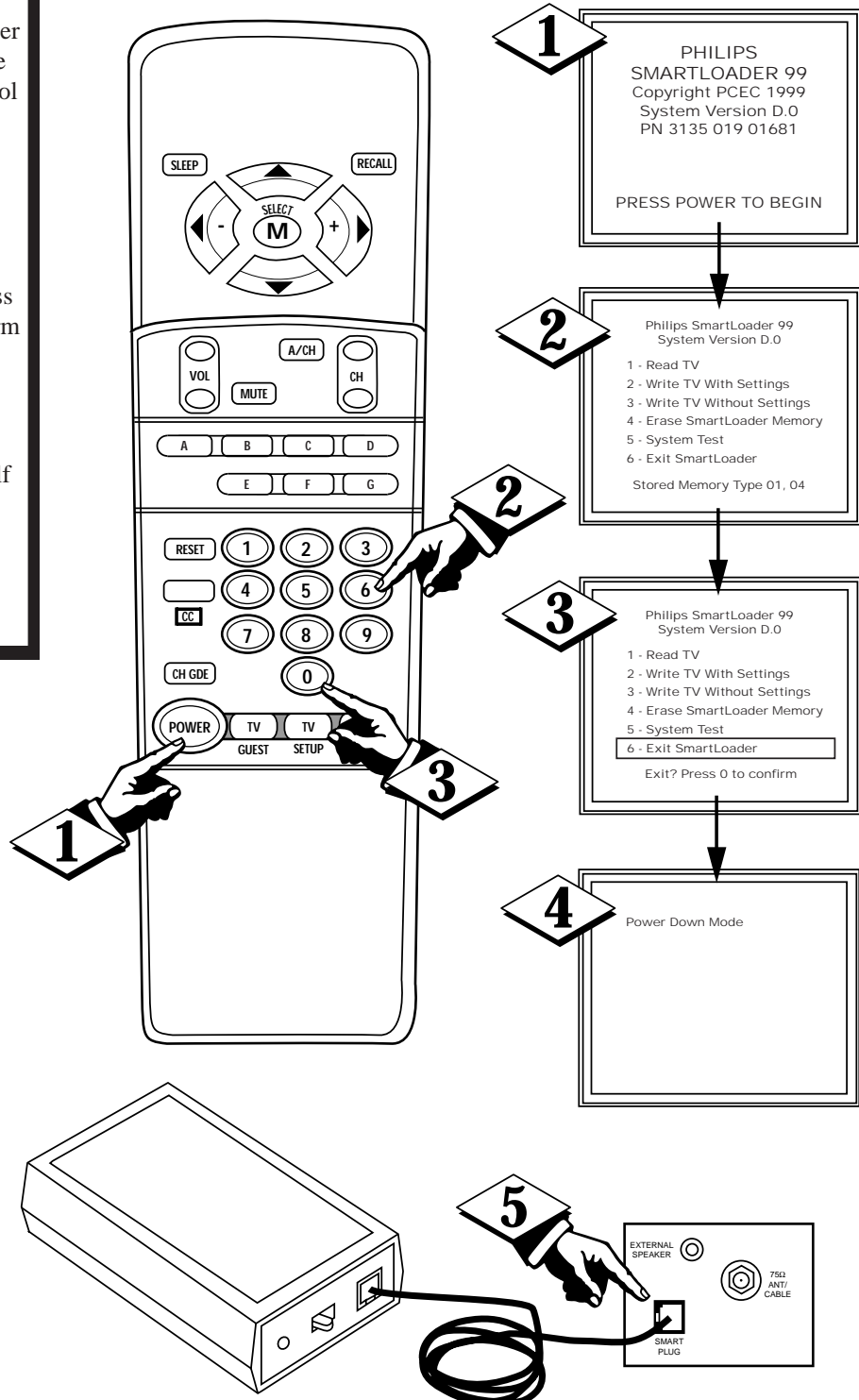
- 1 With the Clon99-BK SmartLoader on-screen display showing, press the POWER button on the remote control
- 2 The Setup Menu will appear. Press the Number 6 button on the Remote Control to select the 6th option "Exit SmartLoader."
- 3 The screen will ask "Exit?" Press the 0 button on the remote to confirm and begin the procedure.
- 4 The Clon99-BK SmartLoader will display a screen that reads "Power Down Mode" then shut itself off.
- 5 When finished, unplug the Clon99-BK SmartLoader from the rear jack panel of the television.



PROGRAMMING A TELEVISION WITH THE ON-SET KEYBOARD

WRITING TV MEMORY WITH THE ON-SET KEYBOARD

After the Memory has been read from one television, the Clon99-BK SmartLoader is now ready to write the memory to other televisions. The following steps show how to download or "write" memory from one television to another using the On-Set Keyboard.

BEGIN

- 1 Plug one end of the cable into the jack provided on the SmartLoader. Then plug the other end into the jack provided on the back of the TV. The TV jack is next to the Antenna Input terminal.
- 2 Push the Slide Switch to the ON position on the SmartLoader. If the TV is currently off, it should turn on within 15 seconds.
- 3 Within 20 seconds, the SmartLoader on-screen display should appear on the TV screen. If the display does not appear, check connections and push the Slide Switch to the ON position again. If there is still no response from the SmartLoader, replace its 9-volt battery.
- 4 Press the POWER button on the front of the TV to display the Clon99-BK SmartLoader "Write TV" Menu.
- 5 Press the CH/UP button on the front of the TV to write the memory to the television.
- 6 The screen will ask "Press CH/UP to Confirm Write," "Press the CH/DN to Abort," or "Press the Power to Exit System." Press the CH/UP button to confirm and begin the procedure.
- 7 The screen will indicate "Writing Block XX of XX" while the Clon99-BK SmartLoader is downloading the data.
The display will then read "Finished Writing Memory" when the procedure has been completed.
- 8 Press the Power button on the front of the TV to EXIT the system.

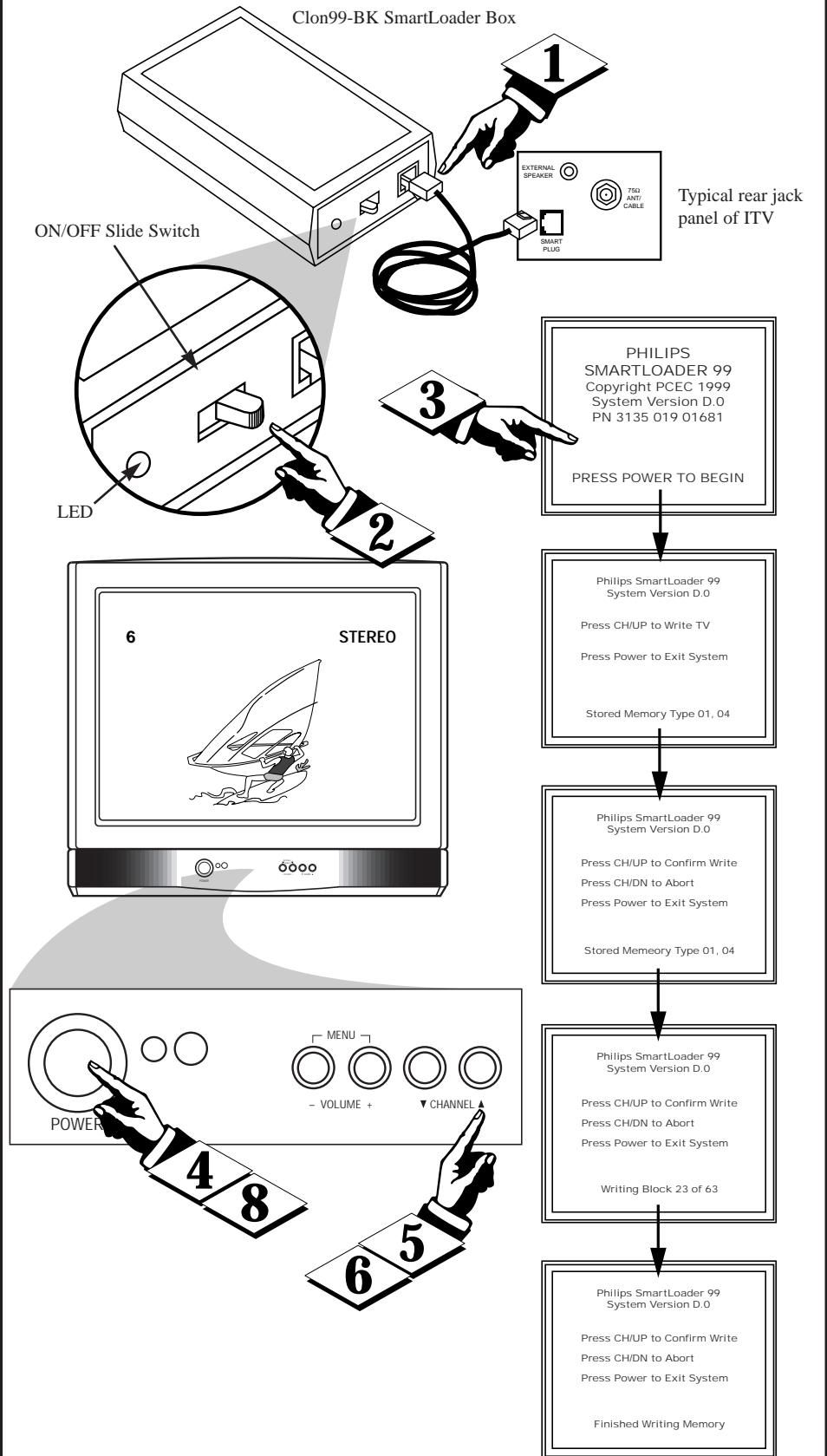

CLON99-BK SMARTLOADER DISPLAYS USING PROGRAMMING TRANSMITTER FOR NON-GLOBAL TV

Follow these screens when choosing option "0" - EXIT.

0

PHILIPS SMART LOADER SYSTEM REVISION D.0 PN 3135 019 01681 PRESS POWER TO BEGIN	TELEVISION TYPE -- SAVED DATA TYPE -- 0 - EXIT 1 - READ TV 2 - WRITE TV - PIC 3 - WRITE TV - NO PIC 4 - ERASE 5 - TV/BUS SYSTEM TEST	EXIT SMART LOADER SYSTEM ?? ARE YOU SURE?? 1 - EXIT SMART LOADER 0 - RETURN TO MENU
---	---	--

Follow these screens when choosing option "1" - READ TV.

1

PHILIPS SMART LOADER SYSTEM REVISION D.0 PN 3135 019 01681 PRESS POWER TO BEGIN	TELEVISION TYPE -- SAVED DATA TYPE -- 0 - EXIT 1 - READ TV 2 - WRITE TV - PIC 3 - WRITE TV - NO PIC 4 - ERASE 5 - TV/BUS SYSTEM TEST	TELEVISION TYPE -- 1 - READ TV MEMORY 0 - RETURN TO MENU	TELEVISION TYPE -- ?? ARE YOU SURE ?? 1 - READ TV MEMORY 0 - RETURN TO MENU	READING BLOCK ..	TV MEMORY READ AND SAVED
---	---	--	--	------------------	-----------------------------

Follow these screens when choosing option "2" or "3" - WRITE TV - PIC, or WRITE TV - NO PIC.

2 **3**

PHILIPS SMART LOADER SYSTEM REVISION D.0 PN 3135 019 01681 PRESS POWER TO BEGIN	TELEVISION TYPE -- SAVED DATA TYPE -- 0 - EXIT 1 - READ TV 2 - WRITE TV - PIC 3 - WRITE TV - NO PIC 4 - ERASE 5 - TV/BUS SYSTEM TEST	TELEVISION TYPE -- SAVED DATA TYPE -- 1 - WRITE TV MEMORY 0 - RETURN TO MENU	TELEVISION TYPE -- SAVED DATA TYPE -- ?? ARE YOU SURE ?? 1 - WRITE TV MEMORY 0 - RETURN TO MENU	WRITING BLOCK ..	MEMORY WRITE COMPLETE
---	---	---	---	------------------	-----------------------

Follow these screens when choosing option "4" - ERASE.

4

PHILIPS SMART LOADER SYSTEM REVISION D.0 PN 3135 019 01681 PRESS POWER TO BEGIN	TELEVISION TYPE -- SAVED DATA TYPE -- 0 - EXIT 1 - READ TV 2 - WRITE TV - PIC 3 - WRITE TV - NO PIC 4 - ERASE 5 - TV/BUS SYSTEM TEST	SAVED DATA TYPE -- 1 - ERASE MEMORY DATA 0 - RETURN TO MENU	SAVED DATA TYPE -- ?? ARE YOU SURE ?? 1 - ERASE MEMORY DATA 0 - RETURN TO MENU	DATA ERASURE COMPLETE
---	---	---	---	-----------------------

Follow these screens when choosing option "5" - TV/BUS SYSTEM TEST.

5

PHILIPS SMART LOADER SYSTEM REVISION D.0 PN 3135 019 01681 PRESS POWER TO BEGIN	TELEVISION TYPE -- SAVED DATA TYPE -- 0 - EXIT 1 - READ TV 2 - WRITE TV - PIC 3 - WRITE TV - NO PIC 4 - ERASE 5 - TV/BUS SYSTEM TEST	TV/DATA TERMINAL SYSTEM TEST SEQUENCE 1 - CONTINUE TEST 0 - RETURN TO MENU	*DISPLAY REGISITRATION* * * 1 - CONTINUE TEST * 0 - RETURN TO MENU * * * 10 LINES/26 CHARACTERS *	DOWNLOAD CHARATER SET !"#%&'()*+,-.0123 456789:;<=>?@BCDEFG HIJKLMNOPQRSTUVWXYZ 1 - CONTINUE TEST 0 - RETURN TO MENU	IR DATA LINK TEST PRESS A/CH ON TRANSMITTER 1 - CONTINUE TEST 0 - RETURN TO MENU
TEST DATA TERMINAL POWER NO POWER SUPPLY DETECTED 1 - CONTINUE TEST 0 - RETURN TO MENU	NO INTERNAL TELEVISION ERRORS DETECTED 1 - TEST COMPLETE				

CLON99-BK SMARTLOADER DISPLAYS USING ON-SET KEYBOARD WITH NON-GLOBAL TV

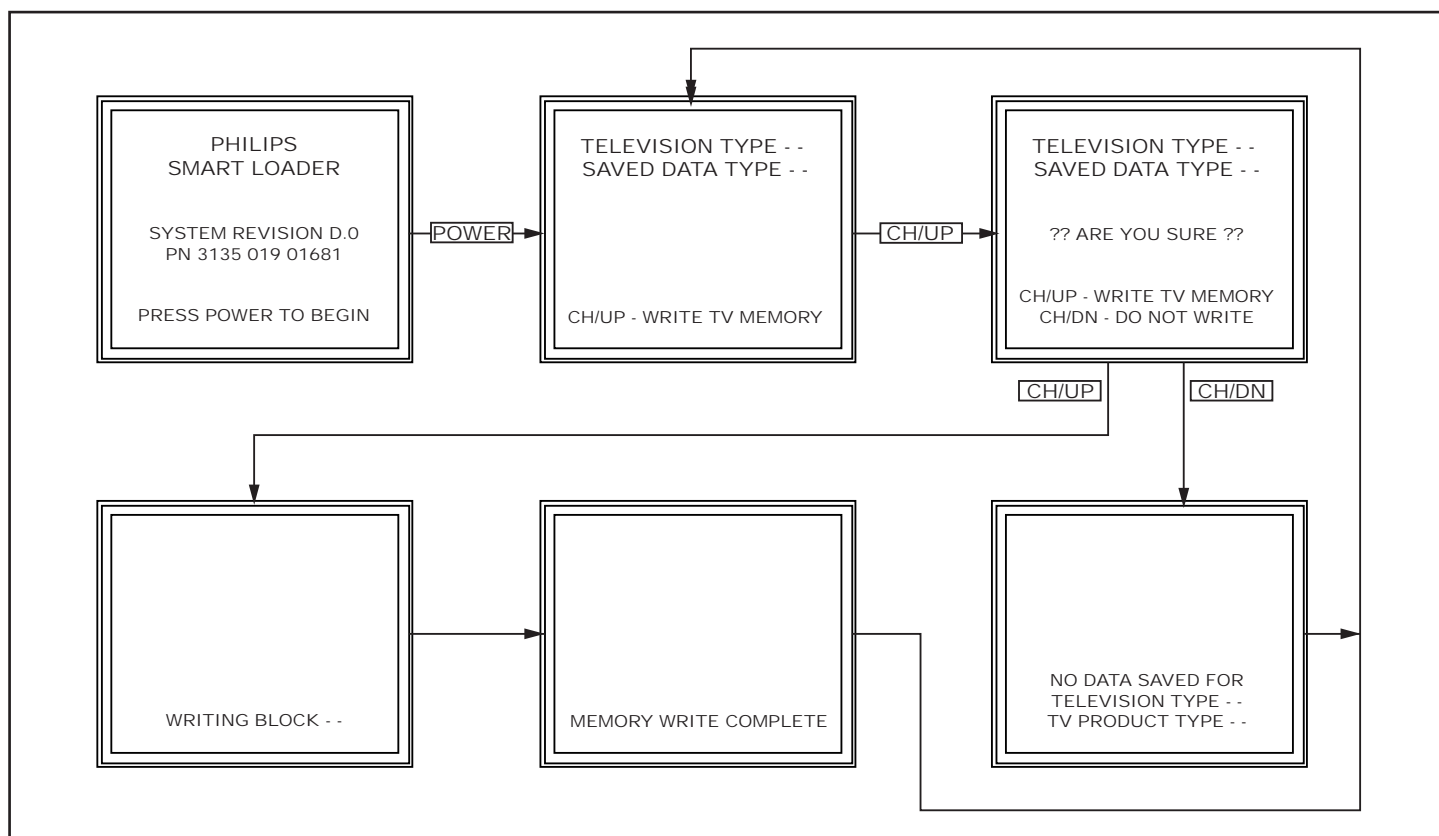

INDEX

Battery Installation - Remote	3
Battery Installation - Clon99-BK SmartLoader	3
Connections	4
Erase Memory	5
Exiting the Menu	9
Introduction	2
On-Set TV Keyboard	10, 12
On-Screen Displays for Non-Global TV with Transmitter	11
On-Screen Displays for Non-Global TV with On-Set Keyboard	12
Programming with On-Set Keyboard for Global TV	10
Programming (Writing) Memory	7
Read Memory	6
Remote Control	3, 5-9
Safety/Precautions	2
System Test	8
Table of Contents	2

Free Manuals Download Website

<http://myh66.com>

<http://usermanuals.us>

<http://www.somanuals.com>

<http://www.4manuals.cc>

<http://www.manual-lib.com>

<http://www.404manual.com>

<http://www.luxmanual.com>

<http://aubethermostatmanual.com>

Golf course search by state

<http://golfingnear.com>

Email search by domain

<http://emailbydomain.com>

Auto manuals search

<http://auto.somanuals.com>

TV manuals search

<http://tv.somanuals.com>