

Register your product and get support at
www.philips.com/welcome

Streamium

MCi8080/12



EN User manual

PHILIPS

Contents

1 Important	5
Safety	5
Environmental notices	6
Recycling	7
Trademark notice	7
2 Your MCi8080	9
Introduction	9
What's in the box	9
Overview	10
Top and front view	10
Rear view	11
Remote control	12
Touch screen	14
Home screen	14
Play screen	15
Text entry	15
3 Prepare	17
Connect the HDD to a computer	17
Copy MCi8080 files to the computer	17
Copy media files to the HDD	17
Install batteries into the remote control	18
4 Place the unit	19
Place the speakers	20
5 Connect	21
Connect the main unit and CD/DVD unit	21
Connect speakers	21
Connect for disc play	22
Connect a TV	22
Connect the FM antenna	23
Connect external audio devices	23
Connect an iPod / iPhone dock	24
Turn on/off	24
Connect power supply	24
Turn on/off	24
6 First-time setup	26
Connect to home Wi-Fi/wired network	27
Wireless connection: One-touch Wi-Fi Protected Setup (WPS)	28
Wireless connection: Enter encryption key manually	29
Wireless connection: Enter IP address manually	30
Wired connection	31
Wired connection: Enter IP address manually	32
7 Play from home Wi-Fi/wired network	33
Play from the hard disk drive (HDD)	33
Connect the HDD to MCi8080	33
Library on the HDD	33
Play from the HDD	36
Multiroom music	37
Stream from a UPnP server	38
Library on a UPnP server	39
Stream from a UPnP server	39
Play Internet radio stations	41
Tune to Internet radio stations	41
Store preset stations	41
Edit favorite stations	42
Manage Internet radio online	43
Manually add stations online	44
Stream from online music services	45
Stream from Napster	45
Search for music/pictures	46
Alphanumeric search	46
Quickjump	47
Superscroll	47
8 Play music CD/movie DVDs	48
Basic operations	48
Use the disc menu	49
Access the disc menu	49
Play movie discs(DVD/DivX/VCD)	49
Pause/Resume/Stop	49
Search	50
Select languages for disc play	50
Program favorite chapters/tracks	50

Select play options	51		
Select Repeat/Shuffle options	51		
Zoom in/out image	51		
Change a camera angle	51		
<hr/>			
9 Play FM radio	52	12 Register MCI8080 with Philips	62
Tune to FM radio stations	52	Benefits	62
Autostore	52	Register MCI8080	62
Manual tuning	52	Register on the web site	62
Edit preset stations	52	Register on the device	62
Listen to FM radio	52	Unregister MCI8080	63
RDS (Radio Data System)	53	Check registration information	63
Use the RDS for clock setting	53	<hr/>	
<hr/>			
10 Play from an external audio device (AUX)	54	13 Maintenance	64
Play from an external audio device	54	Cleaning	64
<hr/>			
11 Settings	55	14 Technical data	65
Play modes	55	<hr/>	
Sound settings	55	15 Troubleshooting	69
Bass and treble	55	<hr/>	
Full sound	55	16 Contact information	70
Direct Source	55		
Audio balance	55		
Display settings	56		
Brightness	56		
Wallpaper	56		
Screensaver	56		
Slideshow settings	56		
Album art	56		
Clicker sound	57		
Clock settings	57		
Alarm	57		
Sleep timer	58		
Date and time	58		
Network settings	59		
Setup network	59		
Device name	60		
USB sharing	60		
Location and time zone	60		
Language	60		
Device information	60		
Check for software upgrades	60		
Demo mode	60		
Restore factory settings	61		

1 Important

Safety

Information for Europe:

Know these safety symbols



The 'exclamation mark' calls attention to features for which you should carefully read the supplied literature to prevent operating and maintenance problems.

The 'lightening bolt' symbol indicates uninsulated components within the product that can cause an electric shock.

To reduce the risk of fire or electric shock, do not expose the product to rain or moisture and do not place any objects filled with liquids, such as vases, on the product.

- ① Read these instructions.
- ② Keep these instructions.
- ③ Heed all warnings.
- ④ Follow all instructions.
- ⑤ Do not use this product near water.
- ⑥ Clean only with dry cloth.
- ⑦ Do not block any ventilation openings. Install in accordance with the manufacturer's instructions.

- ⑧ Do not remove the casing of this product.
- ⑨ Only use this product indoors. Do not expose the product to dripping / splashing water, rain or high humidity.
- ⑩ Keep this product away from direct sunlight, naked flames or heat.
- ⑪ Do not install near any heat sources such as radiators, heat registers, stoves, or other electrical equipment (including amplifiers).
- ⑫ Do not place any other electrical equipment on the product.
- ⑬ Do not place any sources of danger on the product (e.g. objects containing liquids, burning candles).
- ⑭ This product may include batteries. Please refer to safety and disposal instructions for batteries in this user manual.
- ⑮ This product may contain lead and mercury. Disposal of these materials may be regulated due to environmental considerations. Please refer to disposal instructions in this user manual.

Caution

- Use of controls or adjustments or performance of procedures other than herein may result in hazardous radiation exposure or other unsafe operation.

Warning

- Never remove the casing of this apparatus.
- Never lubricate any part of this apparatus.
- Never place this apparatus on other electrical equipment.
- Keep this apparatus away from direct sunlight, naked flames or heat.
- Never look into the laser beam inside this apparatus.
- Ensure that you always have easy access to the power cord, plug or adaptor to disconnect this apparatus from the power.
- Where the mains plug or an appliance coupler is used as the disconnect device, the disconnect device shall remain readily operable.

Risk of overheating! Never install this apparatus in a confined space. Always leave a space of at least four inches around this apparatus for ventilation. Ensure curtains or other objects never cover the ventilation slots on this apparatus.

Hearing Safety



Listen at a moderate volume:

Using headphones at a high volume can impair your hearing. This product can produce sounds in decibel ranges that may cause hearing loss for a normal person, even for exposure less than a minute. The higher decibel ranges are offered for those that may have already experienced some hearing loss.

Sound can be deceiving. Over time your hearing 'comfort level' adapts to higher volumes of sound. So after prolonged listening, what sounds 'normal' can actually be loud and harmful to your hearing. To guard against this, set your volume to a safe level before your hearing adapts and leave it there.

To establish a safe volume level:

Set your volume control at a low setting.

Slowly increase the sound until you can hear it comfortably and clearly, without distortion.

Listen for reasonable periods of time:

Prolonged exposure to sound, even at normally 'safe' levels, can also cause hearing loss.

Be sure to use your equipment reasonably and take appropriate breaks.

Be sure to observe the following guidelines when using your headphones.

Listen at reasonable volumes for reasonable periods of time.

Be careful not to adjust the volume as your hearing adapts.

Do not turn up the volume so high that you can't hear what's around you.

You should use caution or temporarily discontinue use in potentially hazardous situations.

Environmental notices



This product complies with the radio interference requirements of the European Community.

CE 0560  R&TTE Directive 1999/5/EC													
BG	✓	RO	✓	BE	✓	LT	✓	LI	✓	IS	✓	SE	✓
DK	✓	ES	✓	CZ	✓	NL	✓	AT	✓	LV	✓	SK	✓
FR	✓	UK	✓	FI	✓	PT	✓	CY	✓	MT	✓	PL	✓
HU	✓	NO	✓	GR	✓	SI	✓	EE	✓				
IT	✓	LU	✓	IE	✓	CH	✓	DE	✓				

This product complies with the requirement of the 1999/5/EC directive.

This apparatus includes this label:

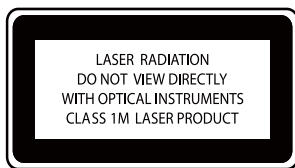

Class II equipment symbol:



This symbol indicates that this product has a double insulation system.

Modifications

Modifications not authorized by the manufacturer may void user's authority to operate this product.

Recycling



Your product is designed and manufactured with high quality materials and components, which can be recycled and reused.

When you see the crossed-out wheel bin symbol attached to a product, it means the product is covered by the European Directive 2002/96/EC:



Never dispose of your product with other household waste. Please inform yourself about the local rules on the separate collection of electrical and electronic products. The correct disposal of your old product helps prevent potentially negative consequences on the environment and human health.

Information about the use of batteries:



Caution

- Risk of leakage: Only use the specified type of batteries. Do not mix new and used batteries. Do not mix different brands of batteries. Observe correct polarity. Remove batteries from products that are not in use for a longer period of time. Store batteries in a dry place.
- Risk of injury: Wear gloves when handling leaking batteries. Keep batteries out of reach of children and pets.
- Risk of explosion: Do not short circuit batteries. Do not expose batteries to excessive heat. Do not throw batteries into the fire. Do not damage or disassemble batteries. Do not recharge non-rechargeable batteries.

Battery disposal information:

Your product contains batteries covered by the European Directive 2006/66/EC, which cannot be disposed of with normal household waste.

Please inform yourself about the local rules on separate collection of batteries. The correct disposal of batteries helps prevent potentially negative consequences on the environment and human health.

Trademark notice



HDMI, and HDMI logo, and High-Definition Multimedia Interface are trademarks or registered trademarks of HDMI licensing LLC in the United States and other countries.



Manufactured under license from Dolby Laboratories. Dolby and the double-D symbol are trademarks of Dolby Laboratories.



DivX® and DivX Ultra® are registered trademarks of DivX, Inc. and are used under license. DivX Ultra® Certified to play DivX® video with advanced features and premium content.

ABOUT DIVX VIDEO: DivX® is a digital video format created by DivX, Inc. This is an official DivX Certified device that plays DivX video. Visit www.divx.com for more information and software tools to convert your files into DivX video.

ABOUT DIVX VIDEO-ON-DEMAND: This DivX Certified® device must be registered in order to play DivX Video-on-Demand (VOD) content. To generate the registration code, locate the DivX VOD section in the device setup menu. Go to vod.divx.com with this code to complete the registration process and learn more about DivX VOD.



'DVD Video' is a trademark of DVD Format/ Logo Licensing Corporation.



Windows Media and the Windows logo are trademarks, or registered trademarks of Microsoft Corporation in the United States and/or other countries.



The making of unauthorized copies of copy-protected material, including computer programs, files, broadcasts and sound recordings, may be an infringement of copyrights and constitute a criminal offence. This equipment should not be used for such purposes.

This item incorporates copy protection technology that is protected by U.S. patents and other intellectual property rights of Rovi Corporation. Reverse engineering and disassembly are prohibited.

2 Your MCI8080

Congratulations on your purchase, and welcome to Philips! To fully benefit from the support that Philips offers, register your product at www.philips.com/welcome.

Introduction

MCI8080 can

- Connect a hard disk drive (USB mass storage device);
- Connect to the existing home Wi-Fi/wired network, which can consist of computers and UPnP devices;
- Connect the existing home audio/video systems, including TV, audio systems and MP3 players.
- Connect an iPod/iPhone dock.

With such connections, you can

- Play music stored on a hard disk drive (HDD) through the speakers;
- Play Internet radio stations and *online music services over the Internet;
- Play movie DVDs on a TV;
- Play music/photos stored on a computer/UPnP server;
- Play music from an audio system/portable media player through the speakers.
- Charge or play your iPod/iPhone through this unit.



Tip

- *Online services are available in some countries only.

The DVD player on MCI8080 supports these disc formats:

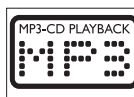

What's in the box



Check and identify the contents of your package:

- Main unit and CD/DVD unit
- Hard disk drive (HDD) with a USB cable
- 2 speakers (with connection cables)
- Remote control with batteries
- Composite video cable
- FM T-type antenna
- AC power cord
- Stand for the hard disk drive (HDD)
- Software suite (stored in the supplied hard disk drive)
- Quick Start Guide

Overview

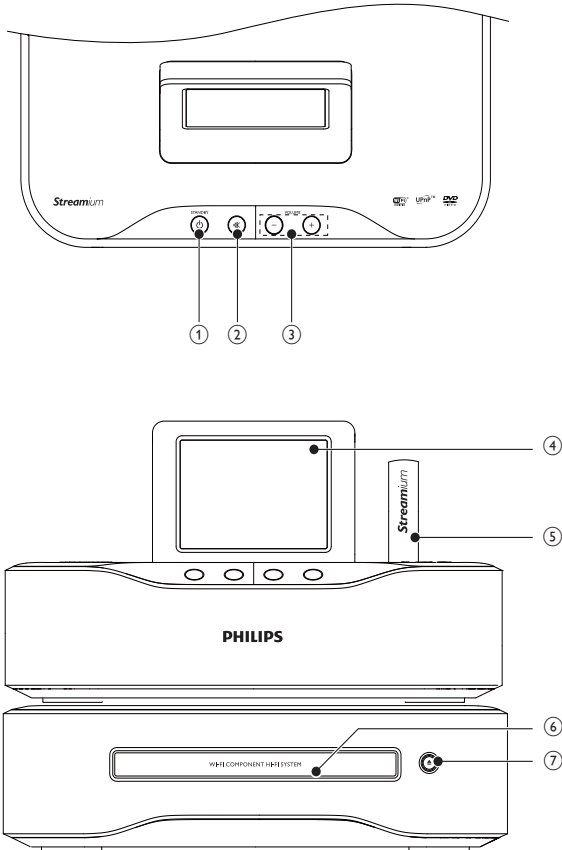
Top and front view



- 1. STANDBY** 
Press to turn on the set;
To turn off, press to switch to active standby; or, press and hold to switch to Eco standby.
Exit Demo mode.
- 2. **
Mute/ unmute sound.
- 3. - VOLUME +**
Increase/decrease volume.

- 4.** LCD display
- 5.** Wi-Fi antenna
- 6.** Disc compartment
- 7. **
Open or close the disc compartment.

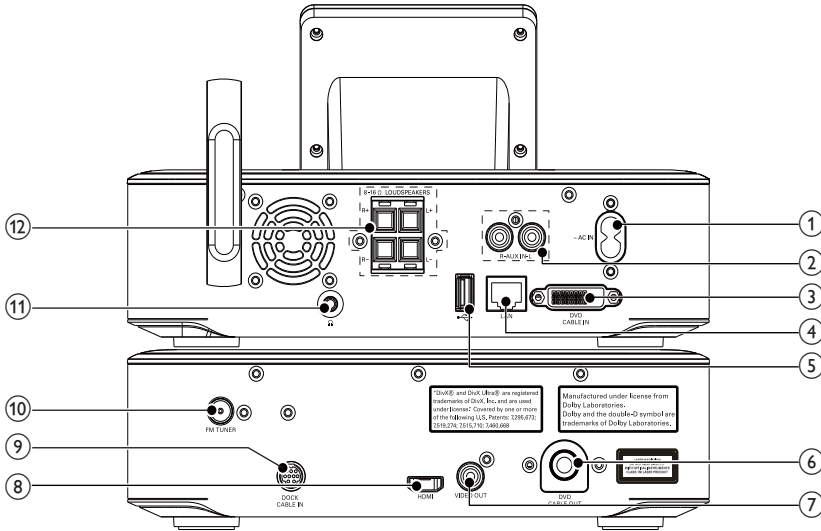

- 1. **~ AC IN**
for AC power cord
- 2. **AUX IN L / R**
Audio input sockets for a portable media player to play through the speakers on MCI8080
- 3. **DVD CABLE IN**
Socket for connection of the main unit to the CD/DVD unit
- 4. **LAN**
Socket for the Ethernet cable that connects MCI8080 with the home Wi-Fi/wired network, if you want a wired connection to the home Wi-Fi/wired network
- 5. 
USB port for the hard disk drive
- 6. **DVD CABLE OUT**
Socket for connection of the CD/DVD unit to the main unit

- 7. **VIDEO OUT**
Video output socket for the disc player for the supplied composite video cable that connects the disc player and a standard TV
- 8. **HDMI**
Video output socket for the disc player for the HDMI cable (not supplied) that connects the disc player and a high-definition TV (HDTV)
- 9. **DOCK CABLE IN**
Socket for connection of an iPod/iPhone dock (not supplied)
- 10. **FM TUNER**
Socket for connection of the supplied FM antenna
- 11. 
3.5 mm headphone jack
- 12. **LOUDSPEAKERS**
Sockets for connection cables that connect the supplied speakers

Remote control

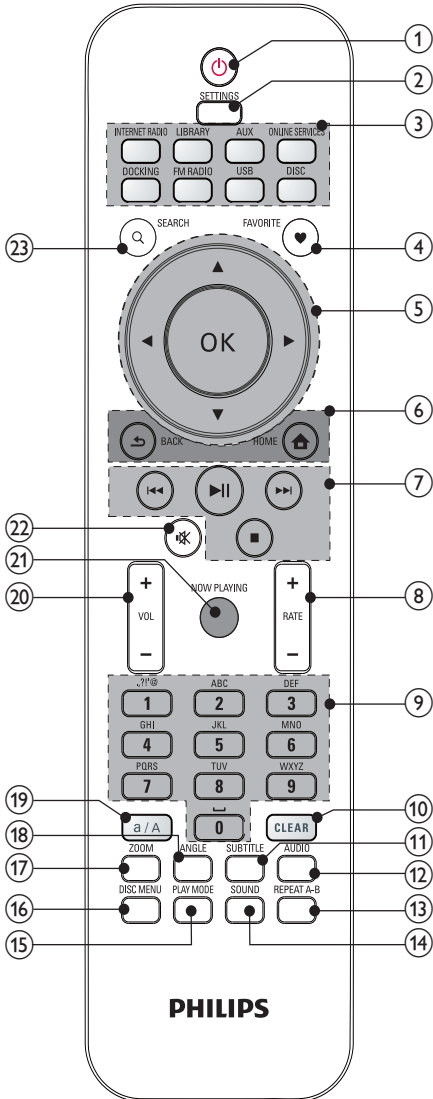

- 

Press to turn on the unit;
To turn off, press to switch to active standby; or, press and hold to switch to Eco standby.
- SETTINGS**

Enter the settings menus.
- Source selector**

Select a media source:

 - INTERNET RADIO:** Radio services provided over the Internet;
 - LIBRARY:** Media library on a UPnP media server;
 - AUX:** Connected external audio device (e.g. an MP3 player or other portable music players);
 - ONLINE SERVICES:** Supported music services provided over the Internet (available in some countries only);
 - DOCKING:** Supported media on the connected iPod/iPhone;
 - FM RADIO:** FM radio stations, with RDS (Radio Data System) supported;
 - USB:** Media library on the hard disk drive connected to the unit;
 - DISC:** DVDs, DivX/WMA/ MP3/ WMA files on discs, and audio CDs.
- FAVORITE**

 - In **LIBRARY** mode:
Add songs to the list of favorites.
 - In **INTERNET RADIO** mode:
Add current station to the list of Favorite Stations.
- 

Navigation buttons
Press to navigate through menus.



In **LIBRARY/INTERNET RADIO/USB** mode:
Superscroll: In a long list of options, press and hold to start Superscroll. Release to jump to the first item starting with current alphabet/ number.

In **DISC** mode:
Select an album (for MP3/WMA CDs).



In **FM RADIO** mode:
Press and hold to start the auto tuning to the next available station; Press repeatedly for fine tuning.

OK

Confirm selection.

6.

HOME: Return to Home screen (main menu).



BACK: Go back to previous screen.

7.

In **LIBRARY/USB/DISC** mode:
Press to skip to the previous/ next chapter/track;



Start/pause/resume play;
In **LIBRARY/USB** mode: Start to play the entire file folder (SuperPlay™).



Stop play;

8. **+RATE -**

In **ONLINE SERVICES** mode:
Increase/decrease rating* of current music.

9. **Alphanumeric buttons**

For text entry

In **INTERNET RADIO/FM RADIO** mode:
On the radio play screen, press and hold a numeric button to store current station in the location as a preset station.

In **LIBRARY/INTERNET RADIO/USB** mode:

Quickjump: In a long list of options that are sorted in an alphabetical order, press once or repeatedly to select an alphabet, and jump to the first item that starts with the selected alphabet.

10. **CLEAR**

Press to delete the previous entry; Press and hold to delete all entries.

11. **SUBTITLE**

In **DISC** mode: Select a subtitle language (for DVD and DivX discs only).

12. **AUDIO**

In **DISC** mode:
Select stereo, mono-left, mono-right, or mix-mono channel (for VCD discs only);
Select an audio language (for DVD and DivX discs only).

13. **REPEAT A-B**

In **DISC** mode: Repeat a specific section within a track/disc.

14. **SOUND**

Select sound settings.

15. **PLAY MODE**

Select repeat play or random play.

16. **DISC MENU**

In **DISC** mode:
Enter or exit the disc menu.

17. **ZOOM**

In **DISC** mode: Zoom in/out (for video discs and picture files on CDs).

18. **ANGLE**

In **DISC** mode: Select a camera angle (for video discs and picture files on CDs).

19. **a/A**

Press to switch between lower and upper cases;
In **FM RADIO** mode, press in the list of presets to start editing station name.

20. **+VOL -**

Increase/decrease the volume.

21. **NOW PLAYING**
Return to play screen.
22. 
Mute/unmute sound.
23. **SEARCH**
Press to start the search/browsing by alphanumeric entry.

 **Note**

- * Rating current music is available only for music services that support rating, and is available only in some countries.

Touch screen

MCi8080 is equipped with a touch screen.

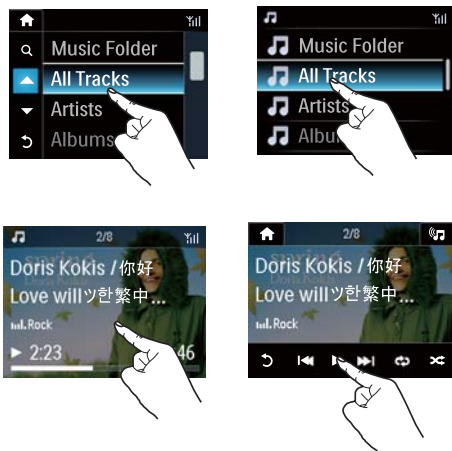

- If necessary, tap on the screen to show functional buttons;
- Tap on the buttons to select corresponding functions;
- Tap on an option to select.

Home screen

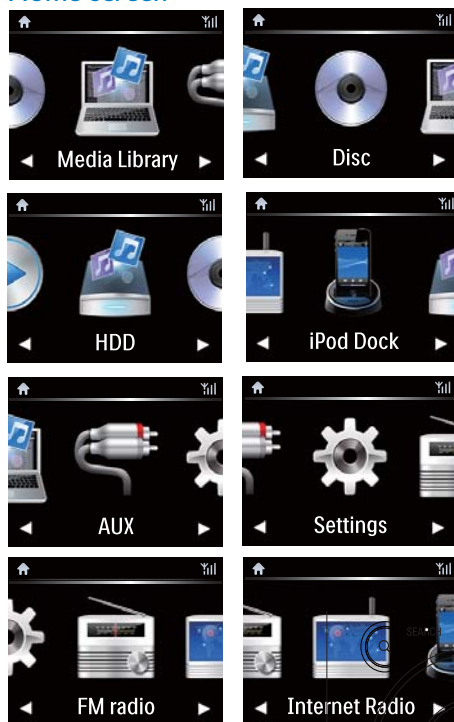

On MCi8080, you enter Home screen after the first-time setup is complete.

To select a music source, or enter the [Settings] menu

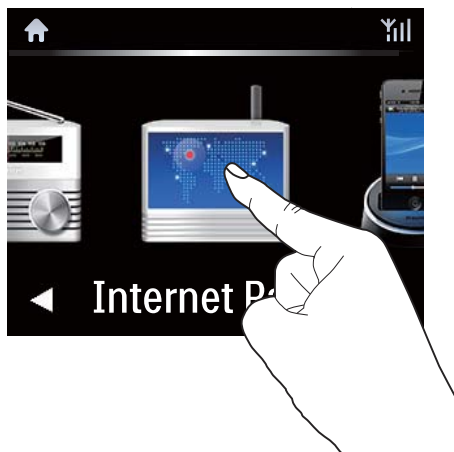

- On Home screen, tap on  to navigate through icons. Tap on the corresponding icon to select.



- Or, press /OK on the remote control to select the desired source.

To go back to previous screen

- Press  BACK.

To return to Home screen

- Press  HOME.



Play screen



In **LIBRARY/INTERNET RADIO/ONLINE SERVICES** mode, Play screen appears when play starts.



To navigate through menus during music play, do the following:

- 1 On the remote control, press  and then, use the Navigation buttons.
- 2 To return to Play screen, press **NOW PLAYING**.

Tip

- On Play screen, you can also press  and  repeatedly to select songs.

Text entry

To enter text and symbols, you can:

- tap on the text box and enter text and symbols with the pop-up keypad directly
- press corresponding alphanumeric buttons on the remote control

Text entry with the remote control

- To enter letters/numbers/symbols corresponding to the same alphanumeric button, briefly and repeatedly press the button.

English		
	abc...	ABC...
1	1.,?!'@- _::/'#\$%& ())*+<=>[N^'{} ~	1.,?!'@- _::/'#\$%& ())*+<=>[N^'{} ~
2	abc2	ABC2
3	def3	DEF3
4	ghi4	GHI4
5	jkl5	JKL5
6	mno6	MNO6
7	pqrs7	PQRS7
8	tuv8	TUV8
9	wxyz9	WXYZ9
0	_0	_0

- To enter symbols, press **1** repeatedly.
- To enter space, press **0**.
- To switch between lower and upper cases, press **a/A**.
- To delete previous character, press **CLEAR**.
To delete all entries, press and hold **CLEAR**.

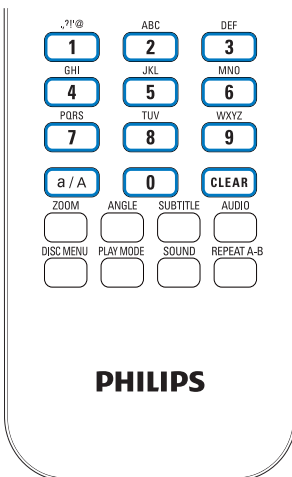

Tip

- For languages other than English, letters that an alphanumeric button corresponds to may vary.

Русский	
абв...	АБВ...
1.,?!'@- _::/'#\$%& ())*+<=>[N^'{} ~	1.,?!'@- _::/'#\$%& ())*+<=>[N^'{} ~
абвр2abc	АБВГ2ABC
дежз3def	ДЕЖЗ3DEF
ийкл4ghi	ИЙКЛ4GHI
mnop5jkl	МНОП5JKL
рсту6mno	РСТУ6MNO
фхцч7pqrs	ФХЦЧ7PQRS
шщъы8tuv	ШЩЪЫ8TUV
ьэюя9wxyz	ЬЭЮЯ9WXYZ
_0	_0

Other Languages	
abc...	ABC...
1.,?!'@- _::/'#\$%& ())*+<=>[N^'{} ~	1.,?!'@- _::/'#\$%& ())*+<=>[N^'{} ~
abc2áâãäåæ	ABC2ÁÁÁÁÁÆ
def3éèë	DEF3ÉÉÉÉ
ghi4íîï	GHI4ÍÍÍÍ
jkl5	JKL5
mno6ñóôõöø	MNO6ÑÓÓÓÓ
pqrs7ß	PQRS7ß
tuv8úûü	TUV8ÚÚÚÚ
wxyz9	WXYZ9
_0	_0

3 Prepare

Connect the HDD to a computer

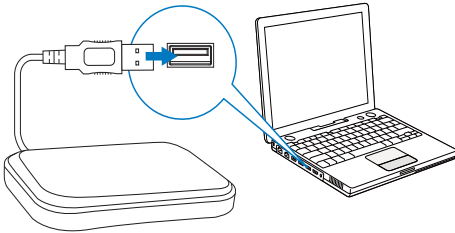

The supplied hard disk drive (HDD) contains the PC/Mac software for **MCi8080 (Media Browser/TwonkyMedia Server)**, video tutorial, User Manual, and other information about MCi8080 that may be helpful to you.

- Connect the supplied HDD to a computer.
↳ Wait till the HDD is detected on the computer.

Copy MCi8080 files to the computer

- 1 On the computer, under [My Computer] or [Computer],
 - Find the HDD of **MCi8080**;
 - Find a location on the computer to store the **MCi8080** files from the HDD.
- 2 Drag and drop the "MCi8080" folder from the HDD to the desired location on the computer.

Copy media files to the HDD

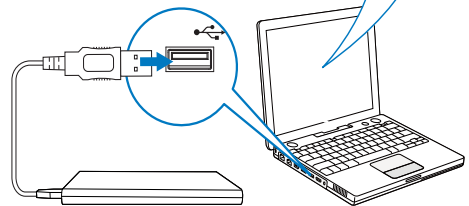
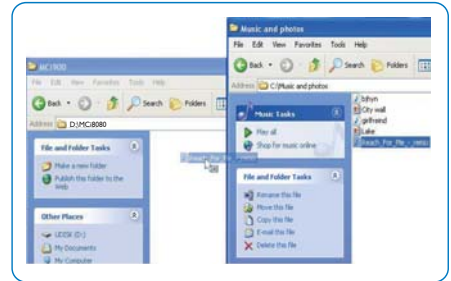

Transfer music/photo files from the computer to HDD. You can play music and photos on **MCi8080**.

- 1 On the computer, under [My Computer] or [Computer],
 - Find the HDD of **MCi8080**;
 - Find the desired music folder.
- 2 From the music/photo folder on your computer, drag and drop music/photo files to the HDD.

Tip

- Copy media files to the HDD, regardless of the folder structure.
- The music/photo file transfer may take you some time. You may proceed to next steps when transferring music/photo files to the HDD.

Install batteries into the remote control



Caution

- Risk of explosion! Keep batteries away from heat, sunshine or fire. Never discard batteries in fire.
- Risk of decreased battery life! Never mix different brands or types of batteries.
- Risk of product damage! When the remote control is not used for long periods, remove the batteries.

- 1 Open the battery compartment.
- 2 Insert two AAA LR03 batteries with correct polarity (+/-) as indicated.
- 3 Close the battery compartment.

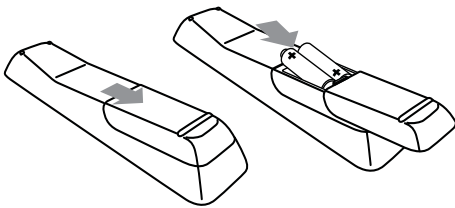

4 Place the unit

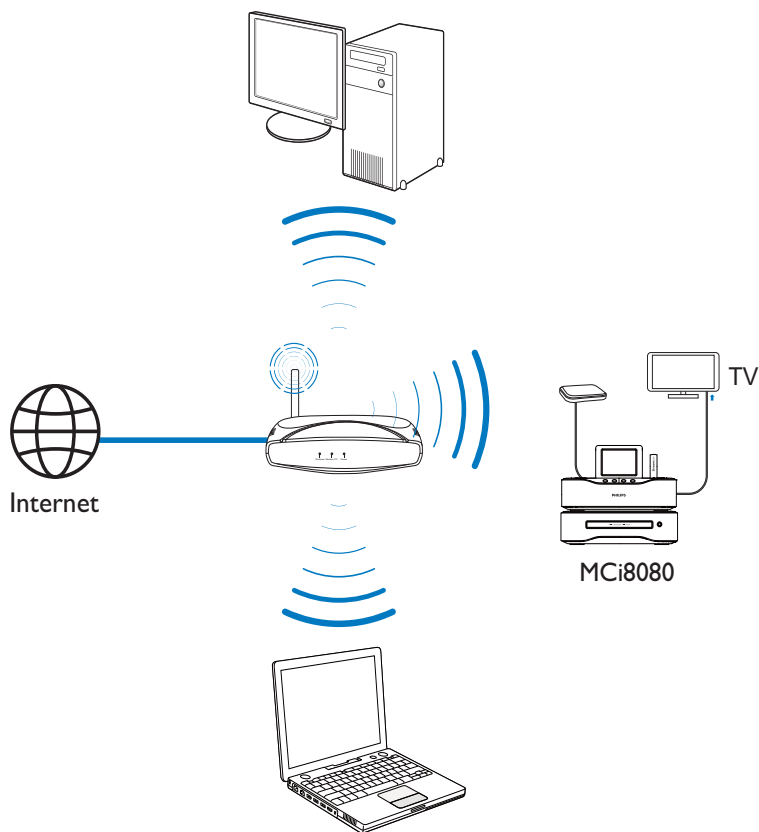

- Place **MCi8080** near a TV to use the disc player.
- For good Wi-Fi reception, place the unit within the coverage of the router/ Access point (not supplied).
- To avoid magnetic interference or unwanted noise, never place this apparatus and speakers too close to any radiation devices.

Note

- Never place this unit in an enclosed cabinet.
- Install this unit near the AC outlet where the AC power plug can be easily reached.

Place the speakers

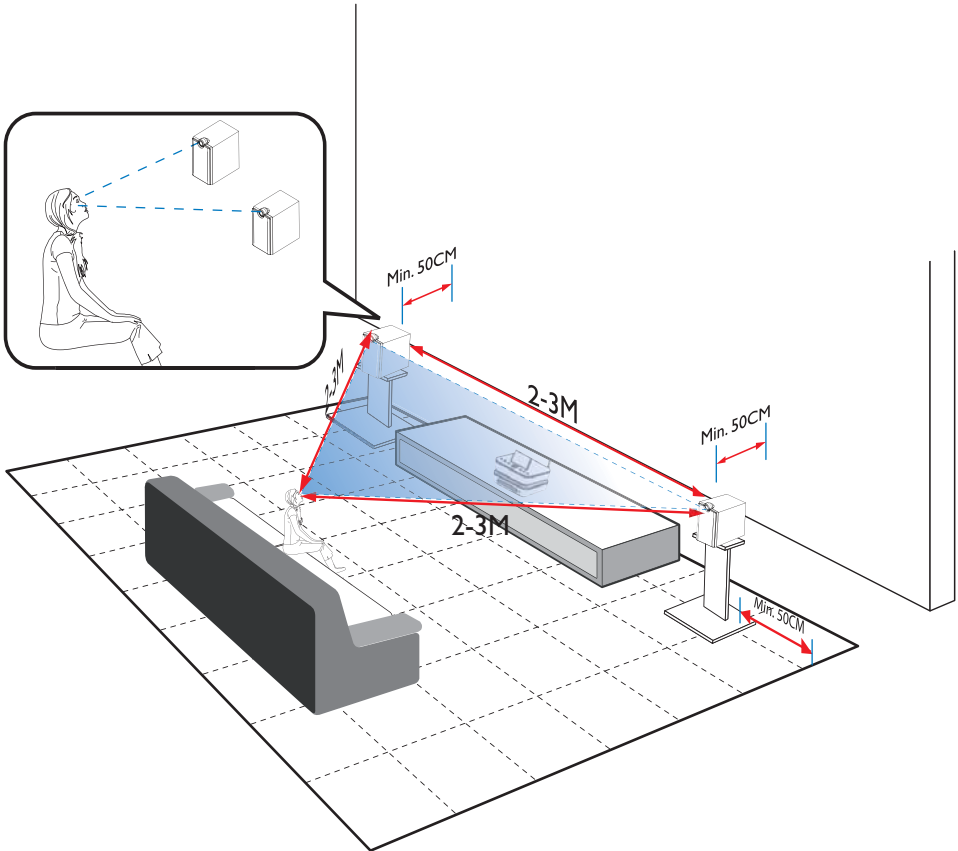

For the best listening experience:

- Place the speakers with the tweeters at the ear height, and at least 50 cm away from the rear wall.
- Place the speakers on speaker stands to get the best result.
- Place the speakers 2 to 3 meters away from each other, with the two speakers and your preferred listening position forming an equilateral triangle.
- Place the speakers with the tweeters facing your preferred listening area.

- To keep the tweeters unobstructed, never place the speakers in between shelves.

Tip

- Alternatively, you can place the speakers on the floor or on top of shelves, though not preferable.
- By placing the speakers at least 50 cm from the rear wall, you can make the bass tighter and improve your listening experience.

5 Connect

Connect the main unit and CD/DVD unit

- As shown, plug the cable into **DVD CABLE IN**.

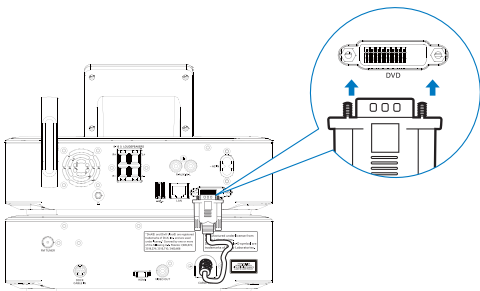

For the main unit side:

- Hold down the socket flap.
- Insert the stripped part of the wire completely.
 - Insert the right speaker wires to "R", left speaker wires to "L".
 - Insert the red wires to "+", black wires to "-".
- Release the socket flap.

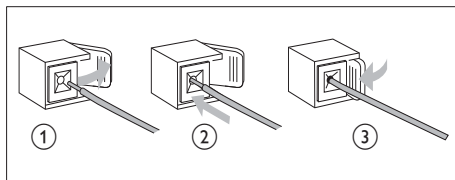

For the speaker side:

- Unscrew the speaker connectors.
- For the left speaker, identify the speaker cable that is connected to the left connectors on the main unit.
- Insert fully the red end of the speaker cable into the red (+) connector.
- Screw the red (+) connector to secure the cable.
- Insert fully the silver end of the speaker cable into the black (-) connector.
- Screw the black (-) connector to secure the cable.
- Repeat steps 2-6 for the right speaker.

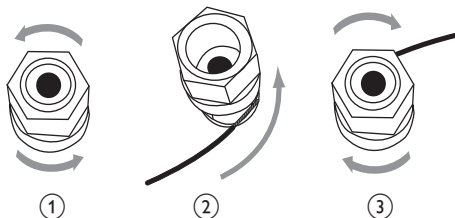

Connect speakers

Note

- Ensure that the colors of the speaker wires and terminals are matched.
- For optimal sound, use the supplied speakers only.
- Connect only speakers with impedance that is the same or higher than the supplied speakers. Refer to the Specifications section of this manual.

Connect for disc play

For disc play, make audio/video connections.

Connect a TV

On **MCi8080**, you can connect a TV through one of the two video jacks.

Select the video jack that your TV supports:

- Composite video (CVBS): for a standard TV;
- HDMI jack: for a high-definition TV compliant with HDMI (High Definition Multimedia Interface)/DVI (Digital Visual Interface), and HDCP (High-bandwidth Digital Contents Protection).

Using the CVBS jack

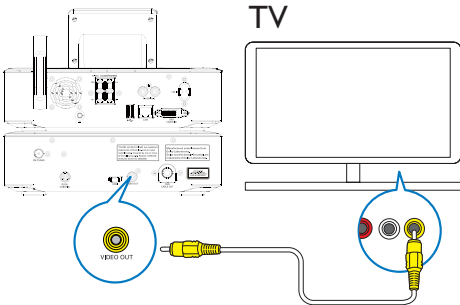

- As shown, plug the supplied composite video cable into the corresponding sockets.

Using the HDMI jack (sold separately)

Use the HDMI jack to connect a high-definition TV (HDTV), which is equipped with HDMI (High Definition Multimedia Interface) or DVI (Digital Visual Interface), and compliant with HDCP (High-bandwidth Digital Contents Protection).

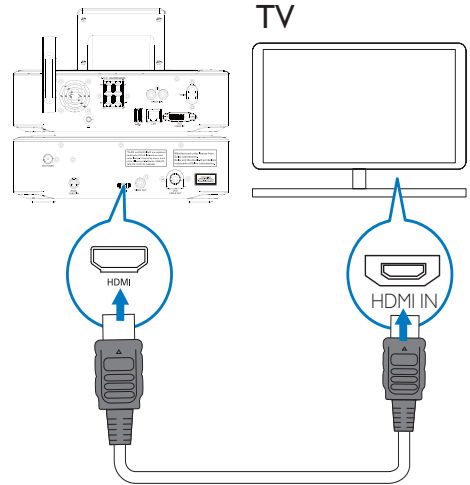

- As shown, connect an HDMI cable (not supplied) to:
 - the **HDMI** socket on this unit, and
 - the **HDMI** input socket on the TV.
- For TV/ monitor with a DVI jack only, use a DVI-to-HDMI adapter.

Tip

- As a compact audio/video interface, HDMI transmits uncompressed digital data. With the HDMI connection, high-definition video/audio contents can present optimum video and audio quality on a HDTV.

Connect the FM antenna

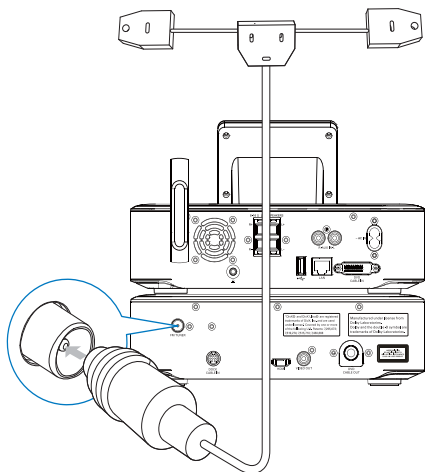

Note

- Always plug in the FM antenna before tuning to an FM radio station.
- Connect the supplied FM T-type antenna to the **FM TUNER** socket on the unit;
- Stretch the antenna to its full length, and fix it on the wall.

Connect external audio devices

You can listen to an external audio device through the speakers on **MCi8080**. To do so, do the following connections, and then, select the **AUX** mode on **MCi8080**.

- Connect audio cables (red/white - not supplied) to:
 - the **AUX IN L / R** sockets on this unit, and
 - the audio output sockets on the external audio device.

- Or, to play from a portable media player with 3.5mm headphone jack
Connect a headphone to RCA cable (not supplied) to:
 - the **AUX IN L / R** sockets on this unit, and
 - the 3.5mm headphone jack on the portable media player.

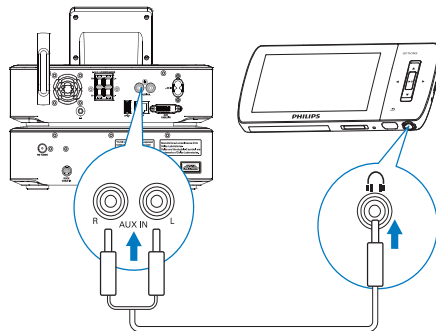

Connect an iPod / iPhone dock

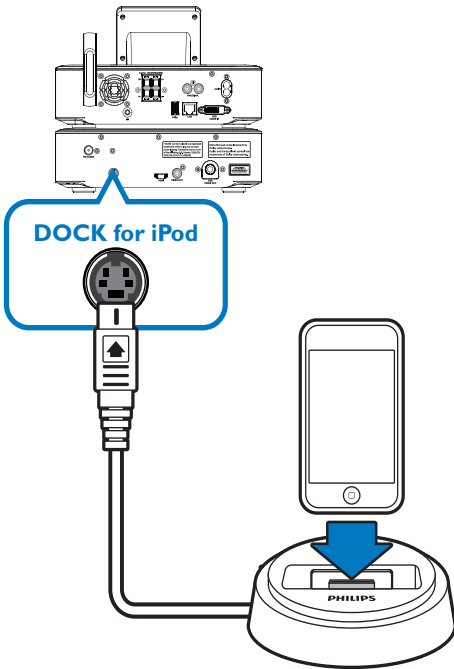

With the connected iPod / iPhone dock, you can charge or listen to music from your iPod / iPhone through this unit.

- Connect a dock (not supplied) to the **DOCK CABLE IN** socket on this unit.

Tip

- To listen to music from the docked iPod / iPhone, first press **DOCKING** to select the dock source.

Turn on/off

Connect power supply

Warning

- Risk of product damage! Ensure that the power supply voltage corresponds to the voltage printed on the back or the underside of the product.

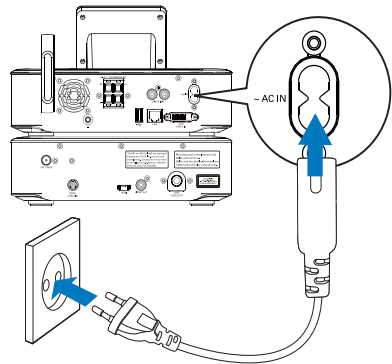



- Connect **MCi8080** to the power supply.

Note

- The type plate information is located at the back or at the underside of the product.

Turn on/off

- 1 Press  or a source selector to turn on the unit.
- 2 To turn off the unit,
 - Press  to switch to active standby;
 - Or, press and hold  to switch to Eco standby (energy-saving mode).

Active standby

When in active standby, some major functions of **MCi8080** remain in the normal state of power consumption, e.g. Wi-Fi connection, clock display. Thus, **MCi8080** can quickly go to the running state when you switch **MCi8080** from active standby to on.

In active standby,

- The power indicator lights up red;
- Clock time is displayed if you have set clock.

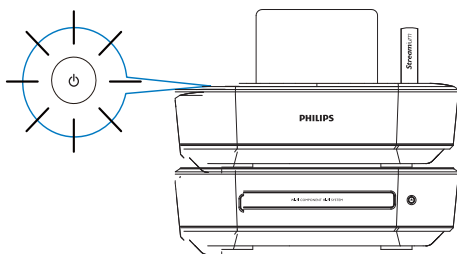

And, the unit is still connected to the Wi-Fi/wired network.

Auto active standby

If no activity happens on **MCi8080** for 20 minutes, **MCi8080** can switch to active standby automatically.

Eco standby

Eco standby is an energy-saving mode. In Eco standby, all major functions are switched to a low-power state or off, e.g. micro-processor, Wi-Fi connection, display, and hard disk.

6 First-time setup

The first time you turn on MCI8080,

- 1 Select the desired language on the screen as prompted.
- 2 To learn major functions on MCI8080,
 - Select [**Yes, show me the demo**], when asked whether to view demo;
 - If necessary, press **+VOL-** to adjust the volume;
 - To exit the demo play, press **⏏**.
 - ↳ The unit is switched to Eco standby.
 - ↳ Press **⏏** again to turn on **MCI8080**, and restart the setup.

To proceed to network setup,

 - Select [**No**], when asked whether to view demo.
- 3 Select your location and time zone from the list as prompted.
- 4 Select [**Yes**], when asked whether to set up network connection.

Connect to home Wi-Fi/ wired network

Connect wirelessly

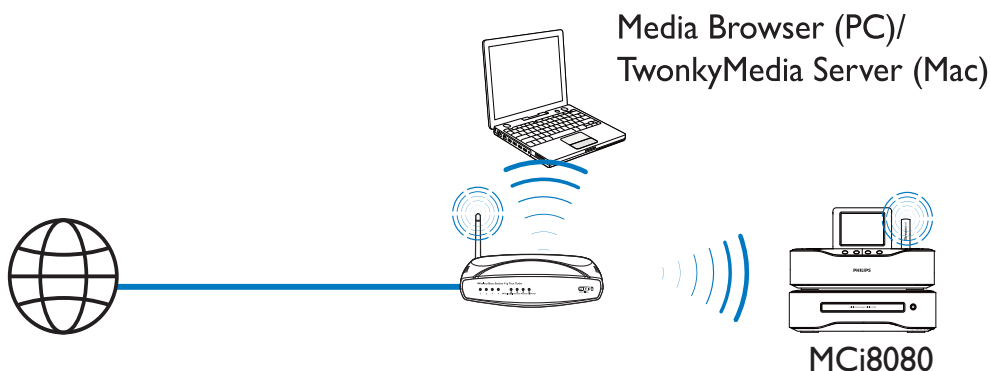

Connect through an Ethernet cable

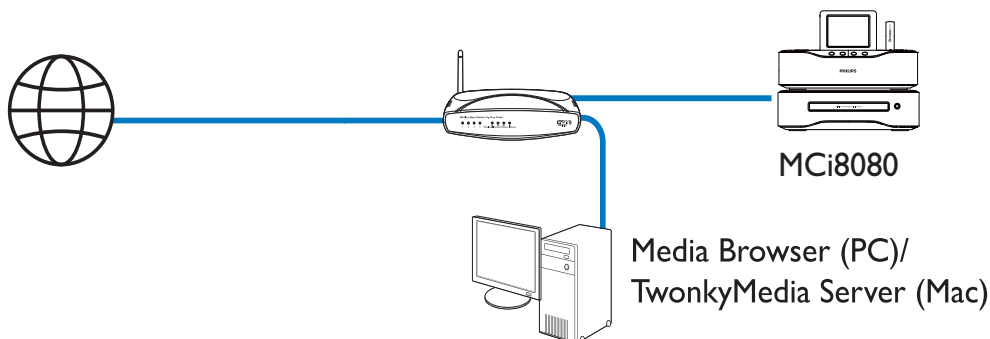

You can connect **MCi8080** to home Wi-Fi/
wired network in different ways: wireless or
wired, automatic or manual.

- Use a router (or Access Point) for home Wi-Fi/wired network. That is, connect computers/devices to a router.
- Connect **MCi8080** to the router wirelessly or through an Ethernet cable.
- To have the unit connected to the Internet over home Wi-Fi/wired network, ensure that the router connects to the Internet directly and no dial-up is required on the computer.
- To switch between different connection methods (wireless or wired, automatic or manual), or switch between different routers, go to **[Settings] > [Network settings] > [Setup network]**.

Wireless connection: One-touch Wi-Fi Protected Setup (WPS)

MCi8080 supports Wi-Fi Protected Setup (WPS). You can quickly and securely connect **MCi8080** to a wireless router that also supports the WPS.

You can select one of the two setup methods: PBC (Push Button Configuration), or PIN (Personal Identification Number).

Tip

- Wi-Fi Protected Setup (WPS) is a standard created by Wi-Fi Alliance for easy establishment of secure wireless home network.

Turn on WPS-PBC on MCi8080

- 1 Select **[Yes]**, when asked whether to set up network connection (see 'First-time setup').
- 2 Select **[Wireless (WiFi)] > [Push button (WPS - PBC)]**.

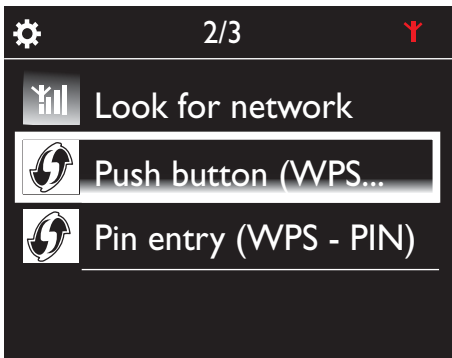

Add MCi8080 on the router

- Consult the user manual of the router to learn how to add a WPS device to the router. For example:
 - ↳ The router starts to search for a WPS device.
 - ↳ On MCi8080, a message appears when the connection is completed successfully.

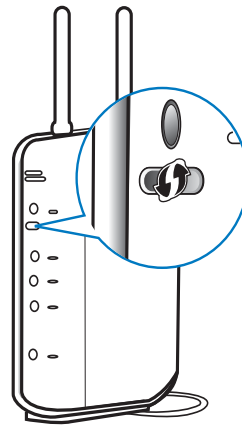

Tip

- To use PIN (Personal Identification Number) as the setup method: On **MCi8080**, select **[Wireless (WiFi)] > [Pin entry (WPS - PIN)]**, and write down the PIN that is displayed on **MCi8080**; On the router, enter the PIN.
- Consult the user manual of the router to learn how to enter the PIN the router.

Connect to the Internet

- Connect to the Internet as prompted.
 - ↳ You enter Home screen after the first-time setup is complete.

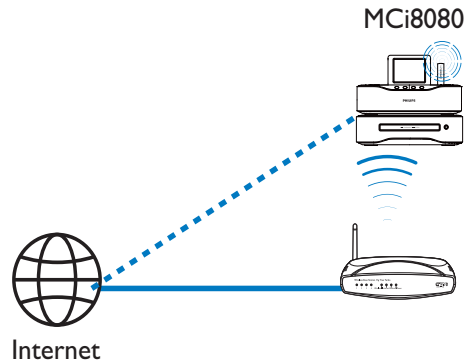

Note

- Ensure that the router connects to the Internet directly and no dial-up is required on the computer.

Wireless connection: Enter encryption key manually



Tip

- Before you start the network setup, have the encryption key to your router ready.

- 1 Select **[Yes]**, when asked whether to set up network connection (see 'First-time setup').
- 2 Select **[Wireless (WiFi)] > [Look for network]**.
 - ↳ The unit starts to search for wireless networks.
 - ↳ A list of available Wi-Fi networks appears.

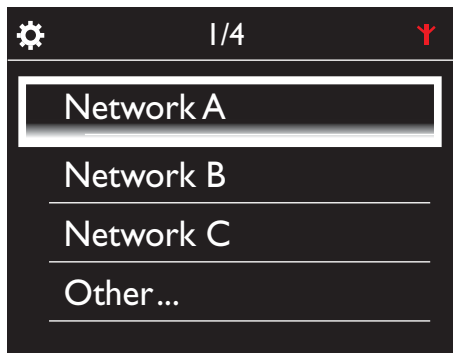

- 3 Select the desired Wi-Fi network.
- 4 As prompted, enter the encryption key to the network.
 - ↳ The unit starts to acquire an IP address assigned by the Wi-Fi network automatically.
 - ↳ A message appears when the connection is completed successfully.

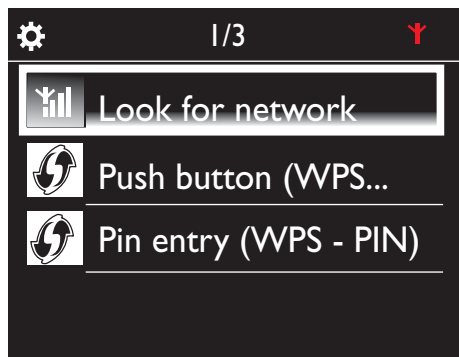

Tip

- If you have hidden the SSID of the router (e.g. disable the SSID broadcasting), go to the end of the list of Wi-Fi network. Select **[Other..]** > **[Manual SSID entry]**. In the text box, enter the name of the router.

Note

- The router may fail to assign an IP address, if the DHCP (Dynamic Host Configuration Protocol) is unavailable or disabled on the router. You may need to enter the IP address manually, or press **BACK** to start re-connecting.

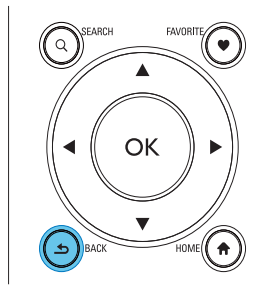

Wireless connection: Enter IP address manually



Stop getting Auto IP

- 1 Search for the home Wi-Fi network, and then, connect to the home Wi-Fi network.
↳ The unit starts to acquire an IP address assigned by the Wi-Fi network automatically.
- 2 Press **BACK** on the remote control to stop getting auto IP.

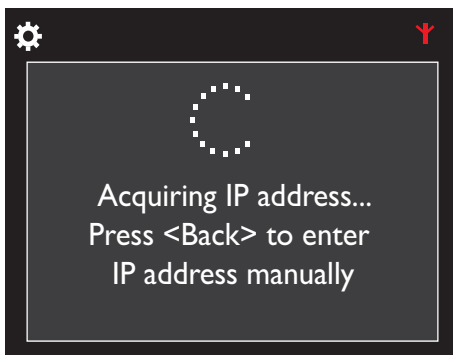

Get the IP address of the router

- Consult the user manual of the router.
- Or, to check for the settings of the router, enter the IP address (e.g. 192.168.1.1) in the web browser (e.g. Internet Explorer) of the computer, and then, get the desired information in the setup page.

Enter the IP address manually

- On the **MCi8080**, enter an IP address that allows the unit to be in the same subnet as the router.
For example, if the router has IP address: 192.168.1.1, Subnet mask: 255.255.255.000;
Then, enter the following on the unit: IP address: 192.168.1.XX (where XX denotes a number), Subnet mask: 255.255.255.000.



- Press **◀▶** repeatedly to select the entry location;

- To enter the desired digits, use the alphanumeric buttons on the remote control; or press ▲▼ repeatedly.

Note

- Ensure that you never enter an IP address that is already assigned to a computer/device on the network.

Wired connection



Connect to the router by using the Ethernet cable

- 1 Select **[Yes]**, when asked whether to set up network connection (see 'First-time setup').
- 2 Use an Ethernet cable to connect the unit to the router.

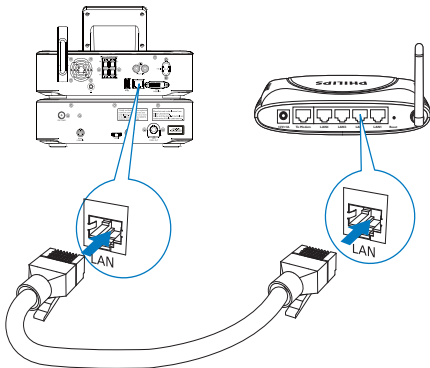

Connect to the home Wi-Fi/wired network

- On the unit, select **[Wired (Ethernet)]**.
 - ↳ The unit starts to acquire an IP address assigned by the network automatically.

- ↳ A message appears when the connection is completed successfully.

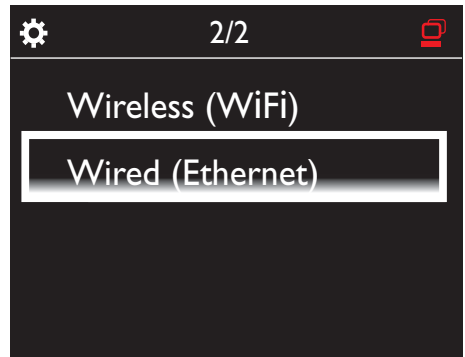

Tip

- The router may fail to assign an IP address, if the DHCP (Dynamic Host Configuration Protocol) is unavailable or disabled on the router. You may need to enter the IP address manually, or press **BACK** to start re-connecting.

Connect to the Internet

- Connect to the Internet as prompted.
 - ↳ You enter Home screen after the first-time setup is complete.

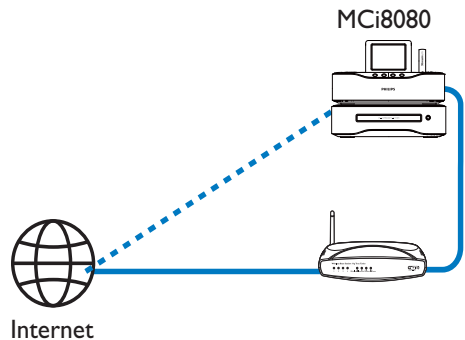

Note

- Ensure that the router connects to the Internet directly and no dial-up is required on the computer.

Wired connection: Enter IP address manually



Stop getting Auto IP

- 1 Use an Ethernet cable to connect the unit to the router.
- 2 On the unit, select **[Wired (Ethernet)]**.
- 3 Press **BACK** on the remote control to stop getting auto IP.

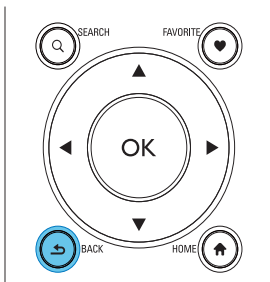

Get the IP address of the router

- Consult the user manual of the router.
- Or, to check for the settings of the router, enter the IP address (e.g. 192.168.1.1) in the web browser (e.g. Internet Explorer) of the computer; and then, get the desired information in the setup page.

Assign the IP address manually

- On the **MCi8080**, enter an IP address that allows the unit to be in the same subnet as the router.
For example, if the router has IP address: 192.168.1.1, Subnet mask: 255.255.255.000;
Then, enter the following on the unit: IP address: 192.168.1.XX (where XX denotes a number), Subnet mask: 255.255.255.000.

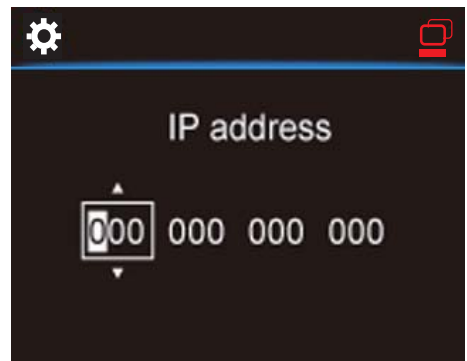

- Press **◀▶** repeatedly to select the entry location;
- To enter the desired digits, use the alphanumeric buttons on the remote control; or press **▲/▼** repeatedly.

Note

- Ensure that you never enter an IP address that is already assigned to a computer/device on the network.

7 Play from home Wi-Fi/wired network

Play from the hard disk drive (HDD)

Connect the HDD to MCI8080

After you have transferred music/picture files from the computer to HDD CA - COMMON TOPIC - PREPARE - HEADER - Prepare (see 'Prepare' on page 17),

- 1 Install the supplied software on the computer: **Media Browser** for PC, **TwonkyMedia Server** for Mac.
 - On the computer, find the "MCI8080 folder" you copied from the HDD;
 - Run the setup file under **TwonkyMedia** folder to start installation on the computer.
- 2 Ensure that you have removed the HDD safely from the computer.
- 3 Connect the HDD to MCI8080.

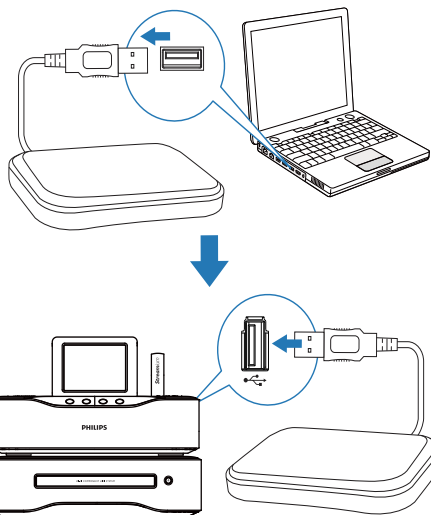

* Tip

- With the software installed, the computer can work as a music server. You can stream music/pictures from the computer to **MCI8080**, if both of them are connected to the home Wi-Fi/wired network.

Library on the HDD

You can transfer the music/ picture files from a computer to the HDD in two ways:

- by using a USB cable that connects the HDD to the computer;
- or, through the home Wi-Fi/wired network.

Transfer through the home Wi-Fi/wired network

Through the network, you can conveniently transfer a smaller number of songs/pictures from the computer to HDD, without removing the HDD from MCI8080.

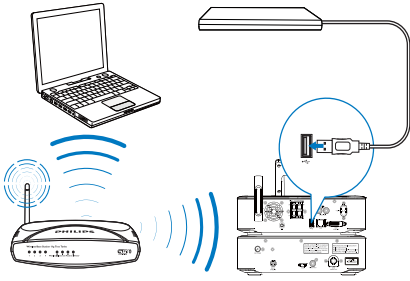

- 1 Ensure that the computer is connected to the home Wi-Fi/wired network. On MCI8080, ensure that
 - The HDD is properly connected;

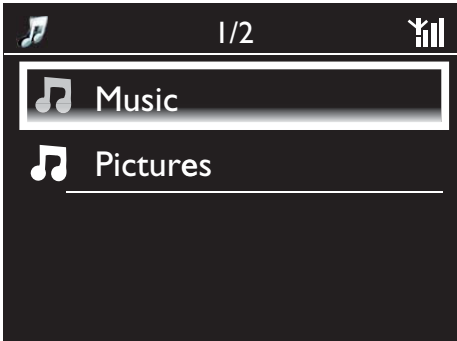

- In [Settings] > [Network settings], "[USB sharing]" is turned on. For computers running Windows XP Professional:

- 2 The first time you connect the HDD as a network drive, assign a network drive to the HDD on the computer.
 - On the computer running Windows XP, double click [My Computer];
 - On the computer running Windows Vista, double click [Computer].



- On [My Computer], select [Tools] > [Map Network Drive];
- Click to assign a network drive to the HDD (e.g. X: as shown). As shown, type in the HDD name \\ Philipsmci8080\usb. Click [Finish].

3 On [My Computer] (Windows XP), or [Computer] (Windows Vista),

- Find the HDD under [Network Drives];
- Find the music/photos folder on the computer.

For computers running Mac OS X:

- As shown, select [Go] > [Network];
- Under [SHARED], select [All] > [philips-network];
- On [philips-network], select [philipsmci8080], and then [usb].

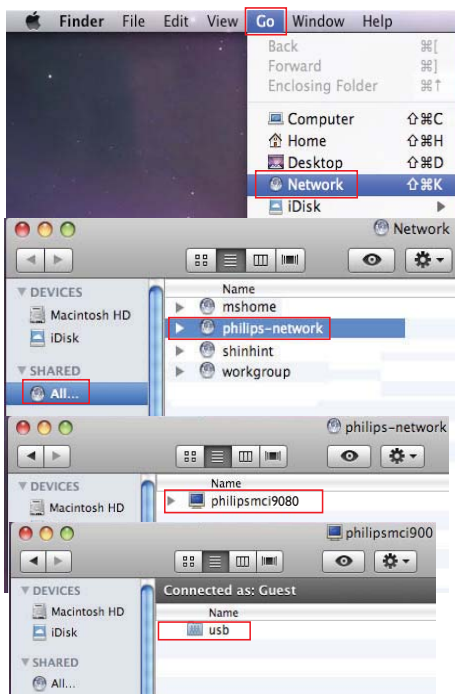

- Find the music/photos folder on the computer.

4 Drag and drop music/picture files from the music/photos folder to MCI8080.
 ↳ On MCI8080, You can switched to the music/photo collection on the [HDD] source (Press **HDD** on the remote control).



Tip

- In the case of a large number of media files, network performance may affect the transfer speed, or even cause the interruption of transfer.
- **Philipsmci8080** is the default device name. To change the device name, go to [Settings] > [Device ID and information].

Organize files on the HDD

- Audio files:
 If the files contain file information (meta tag or ID3 tag), the files can be sorted automatically by the file information, like Artist, Album, Genre, and others.

Launch media management software to check or edit the file information. For example, click as shown in **Windows Media Player 11**. Select the desired song, and then, double click it to edit.



If necessary, you can also organize audio files in different folders as desired.

- Picture files:

Organize files in different folders as desired. The folders are sorted in an alphabetical order.

Play from the HDD

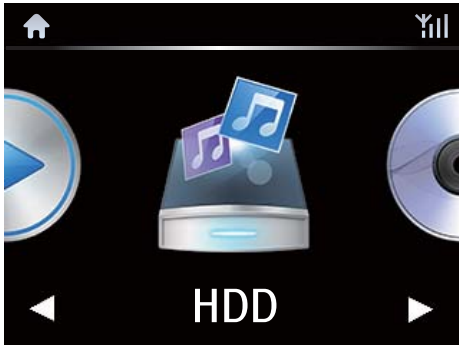

- 1 On MCI8080, ensure that the HDD is properly connected.
- 2 On the remote control, press **USB**.
 - ↳ The file sorting process may take some time. During file sorting, the file folders are displayed.
 - ↳ Audio files are displayed under different categories (e.g. Artist, Album, Genre), if meta/ID3 tags are edited for the files.
 - ↳ Picture files are also organized.
- 3 Select your desired track or album.
- 4 Press **▶||** to start play.
 - Play starts from the beginning of the album, if you press **▶||** on an album.
 - Play screen appears when play starts (see 'Your MCI8080'-'>'Overview'-'>'Play screen').
- 5 To stop play, press **■**.

Multiroom music

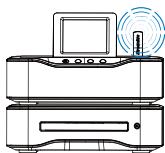

MCI8080

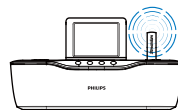

NP3700

With the Multiroom Music feature, you can play the same song on MCI8080 and a Philips network music player (NP3700) at the same time.

Before you enable this feature, make sure that:

- both MCI8080 and NP3700 are connected to the home Wi-Fi network;
- you are playing songs from the HDD connected to MCI8080;

- 1 Play a song from the HDD (see 'Play from home Wi-Fi/wired network' -> 'Play from the hard disk drive (HDD) -> 'Play from the HDD').
- 2 From Home screen, select **[Multiroom Music]** to enable the Multiroom Music feature.

- 3 Wait until the Multiroom Music feature is enabled successfully.

- To cancel simultaneous play, press **■** on MCI8080.

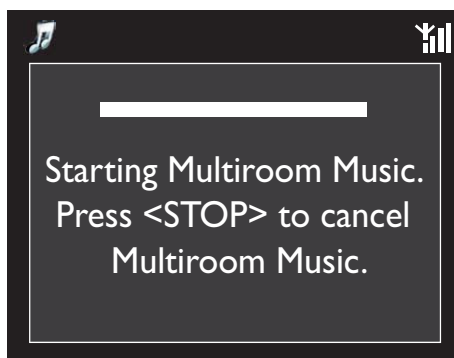

Stream from a UPnP server

Media Browser (PC)/
TwonkyMedia Server (Mac)

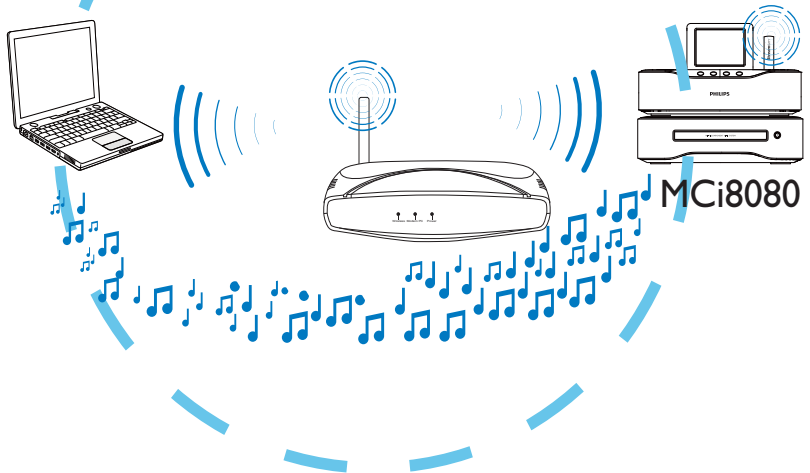

You can stream music/photos between computers and **MCI8080**, when

- **MCI8080** is connected to home Wi-Fi/wired network;
- Music sharing is set up on the computers, other UPnP servers that are also connected to the home Wi-Fi/wired network.

With the music sharing software (the supplied **Media Browser** and **TwonkyMedia Server**), such computers can work as UPnP media servers (music/photo libraries) of **MCI8080**, if they are turned on.

Through the UPnP (Universal Plug and Play) protocols, a UPnP media server allows music or picture files to be streamed from the server to a UPnP client device (e.g. MCI8080). On the UPnP client device, you can play the music and pictures from the server.

MCI8080 can also be the UPnP media server of such computers and other UPnP devices that are connected to the home Wi-Fi network, if **MCI8080** is turned on or switched to active standby.

Connect a hard disk drive (HDD)* to **MCI8080**. Music and pictures on the HDD can be played on such computers and UPnP devices.

Tip

- *The Hard disk drive (HDD) can have a maximum capacity of 160 GB, or up to 40,000 media files.

Library on a UPnP server

On the computers (UPnP servers), the supplied software **Media Browser** or **TwonkyMedia Server** can access music libraries that are organized by different media management software, including **Windows Media Player 11** and **iTunes**.

iTunes is the a trademark of Apple Inc., registered in the U.S. and other countries.

Stream from a UPnP server

On MCi8080, play music/picture libraries that are streamed from a UPnP server (a computer on the home Wi-Fi/wired network).

- 1 Ensure that the UPnP server is connected to the home Wi-Fi/wired network.
- 2 On MCi8080, press **LIBRARY** on the remote control.
 - Or, from Home screen, select **[Media Library]**.
- 3 Select a music/pictures library.
 - ↳ You can see the categories by which the music/pictures are sorted (e.g. Artist, Album, Genre).
- 4 Select your desired track or album.
- 5 Press **▶||** to start play.
 - Play starts from the beginning of the album, if you press **▶||** on an album.
 - Play screen appears when play starts (see 'Your MCi8080' -> 'Overview' -> 'Play screen').



- 6 To stop play, press **■**.

Play favorite songs

On MCi8080, you may wish to listen to certain songs from different artists, albums, and genres. Add the songs to **[Favorites]**.

- 1 Go to a list of songs.
- 2 On the remote control, press **FAVORITE** to add current song to **[Favorites]**.
 - Or, press **FAVORITE** when listening to a song.
 - A list of favorite songs is created under **[Media Library] > [Favorites]**.
- 3 To find and play the favorite songs, press **HOME** on the remote control.
 - ↳ From home screen, you can find the favorite songs under **[Media Library] > [Favorites]**.
 - To remove a favorite song from [Favorites]**
 - ↳ Select the song in **[Media Library] > [Favorites]**. Press **FAVORITE** on the remote control.

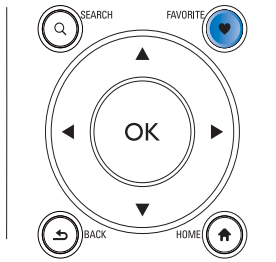

Play photos

- Press ▲/▼ to rotate the picture;
- Press ◀▶ to move to previous/next picture;
- Press ▶|| to start playing all pictures in slideshow mode.



External control from a PC

Through the home W-Fi/wired network, the **Media Browser** on a PC (UPnP server) allows you to control MCI8080.

- 1 On the PC desktop, launch **Media Browser** by double clicking the icon.
- 2 In **Media Browser**, select songs to be played on MCI8080. Drag the songs to the icon of MCI8080.
 - ↳ A green "+" appears if the songs are in supported formats.

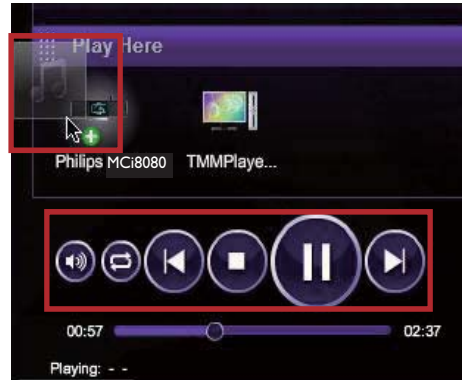

- 3 On the computer, you can click the buttons to
 - Adjust the volume;
 - Select previous/next songs if you have dragged more than one songs to MCI8080. See the Step 2 above.
 - Fast search forward or backward;
 - Play/pause and resume.
- 4 On MCI8080, do the following to exit the external control.
 - Press ■ on the remote control;
 - Press a source selector on the remote control;
 - Press ⏻;
 - Press HOME.

Note

- The external control is stopped if the sleeper timer is turned on after the set time duration.

Play Internet radio stations

To play Internet radio stations, ensure that

- **MCi8080** is connected to the Internet over the home Wi-Fi/wired network.

Note

- Ensure that the router connects to the Internet directly and no dial-up is required on the computer.

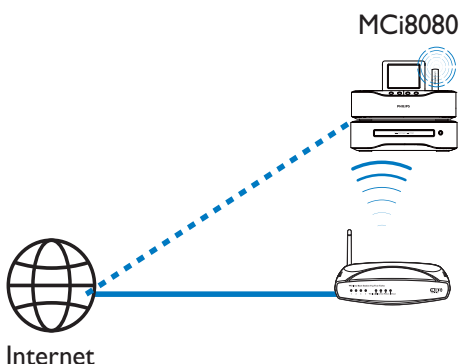

Tune to Internet radio stations

- 1 Ensure that MCi8080 is connected to the Internet.
- 2 On MCi8080, press **INTERNET RADIO** on the remote control.
 - Or, from Home screen, select **[Internet Radio]**.
- 3 To search for radio stations,
 - Go to **[All stations] > [Locations]** to locate stations by region;
 - To search for a station by name, use the remote control to start alphanumeric search or Superscroll (see 'Play from home Wi-Fi/wired network'->'Search for music/pictures').
- 4 Select the desired station to start play.

Store preset stations

On MCi8080, you can store up to 10 preset stations. Each preset station corresponds to a numeric button on the remote control. On the radio play screen, press a numeric button, you quickly switch to the corresponding preset station.

By default, preset stations are pre-loaded to MCi8080 according to the location that you select during the first-time setup. To check or change the location, go to **[Settings] > [Location and time zone]**.

To store preset station

- 1 Play the desired station (see 'Play from home Wi-Fi/wired network'->'Play Internet radio stations'->'Tune to Internet radio stations').
- 2 On the play screen, press and hold the desired numeric button (0-9).
 - ↳ A message appears, indicating that the station is added to the corresponding location.
 - ↳ The new preset replaces the old one if the location has been filled.

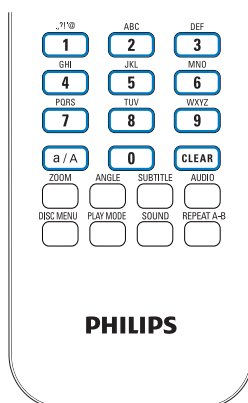

To play a preset station

- Go to **[Internet Radio] > [Presets]**.
- Or, on the radio play screen, press the corresponding numeric button (0-9).

Edit favorite stations

On MCI8080, you can mark an Internet radio station as favorite. All the stations are added to **[Internet Radio] > [Favorite stations]**. In this way, you can quickly access your favorite stations.

To add a station to [Favorite stations]

- On a list of stations, select the desired station. Press **FAVORITE** on the remote control.
- Or, play the desired station. On the play screen, press **FAVORITE** on the remote control.
 - ↳ A message appears, indicating that the station is added to **[Favorite stations]**.

To remove a station from [Favorite stations]

- Select the station in the list of stations; or, go to the play screen of the station. Press **FAVORITE** again.
- Or, press **CLEAR** on the play screen of the station.

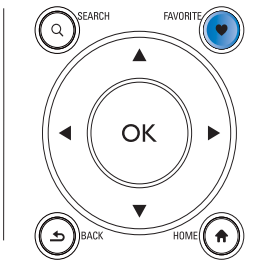

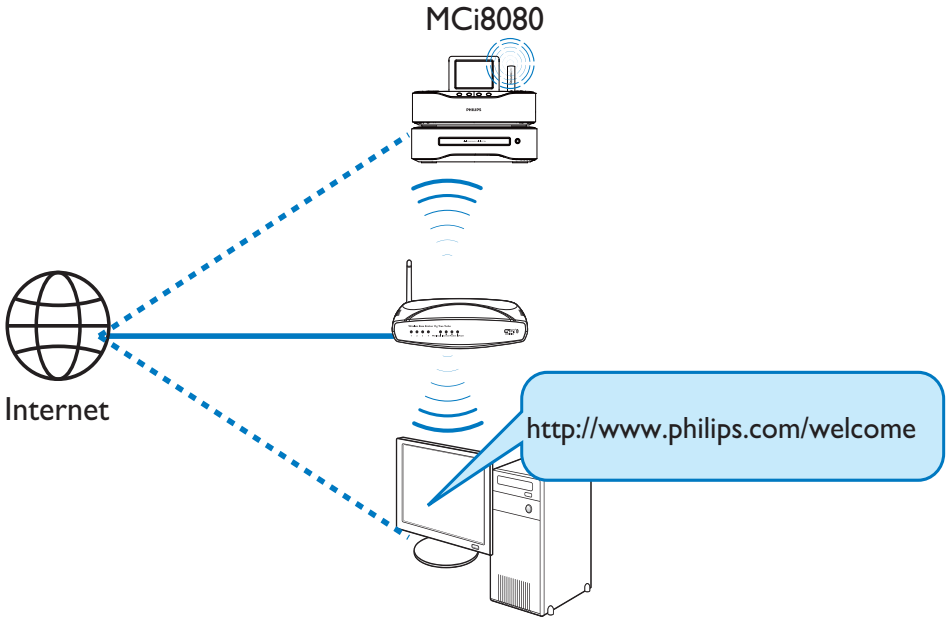

By registering MCI8080 on www.philips.com/welcome (see 'Register MCI8080 with Philips'), you can log in to Club Philips. On Club Philips, you can do the following to manage the Internet Radio on a computer:

- Edit favorite stations;
- Manually add stations that you are unable to find on MCI8080.

Edit favorite stations online

Through Club Philips, you can manage the list of favorite stations on a computer. When connecting MCI8080 to the Internet, you update the favorite stations on MCI8080.

- 1 On a computer, log in to Club Philips (see 'Register MCI8080 with Philips').
- 2 To mark/unmark stations as favorite:
 - Click [Streamium management] > [Favorites] > [Browse];

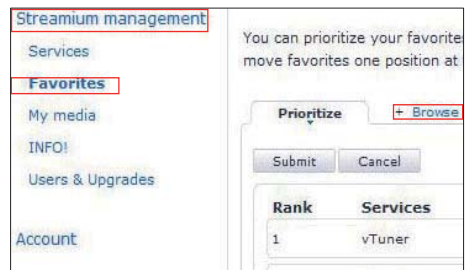

- In [Browse], find the desired stations;



- Under [Favorite], check the box corresponding to the station.
↳ The station is marked as favorite.
- To unmark, uncheck the box corresponding to a station.

Name	Favorite
+SWR3	<input type="checkbox"/>
+NOS Radio 1	<input checked="" type="checkbox"/>
+France Inter	<input type="checkbox"/>
+Deutschlandfunk	<input type="checkbox"/>
Antenne Bayern	<input checked="" type="checkbox"/>
+NDR 2	<input type="checkbox"/>
+Classic FM	<input checked="" type="checkbox"/>

- 3 To change the order of favorite stations in the list:
- Click [Prioritize];
 - Click on the row of the station to be moved;
 - Drag and drop the row upward or downward.

Prioritize + Browse

Submit Cancel

Rank	Services	Name
2	My Media	City FM!
1	vTuner	HIT FM
3	vTuner	Classic FM

- ↳ On MCI8080, you can find the stations in the desired order under **[Internet Radio] > [Favorite stations]**, if you have connected MCI8080 to the Internet.

Tip

- In the list of favorite stations, to put a favorite station ahead of the first one, make the station just behind the first one; drag and drop the first station downward.
- To put a station behind the last one, make the station just ahead of the last one; drag and drop the last station upward.

Manually add stations online

Manually add stations

Through Club Philips, you can manually add Internet radio stations to MCI8080 on a computer:

- 1 On a computer, log in to Club Philips (see 'Register MCI8080 with Philips').
- 2 To add a station, click [Streamium management] > [My media] > [Music].

Favorites

My media

INFO!

Users & Upgrades

ccount

consumer Product

Music + Capabili

* URL

* Nickname

Mimetype audi

* Description

Mark as favorite

- 3 In [Music], enter station information in the text boxes:
 - In [URL], fill in the web site of the station;
 - In [Nickname], fill in a name that appears as station name in [My media];
 - In [Description], fill in one-word description about the station, e.g. music, sports, new.
The description is used as a category to sort stations under [My media].
- 4 Click [Save].
↳ A station is manually added the below the edit boxes.

To edit an added station

Music + Capabilities

* URL

* Nickname

Mimetype

* Description

Mark as favorite

Click a stream to select and edit:

NICKNAME	MIMETYPE
+ City FM	audio/x-pn-real

- As shown, click the station.
 - ↳ The text boxes are filled, showing the information about the station.
- Click on the text boxes to edit the information.

Stream from online music services

On MCI8080, you can enjoy the online music services.

With the online music services, you can access their online music libraries.

Create a user account to use the services. To access some features, you may need to subscribe services.

Note

- Online services are available in some countries only.

Stream from Napster

Note

- To stream from online music services, ensure that MCI8080 is connected to the Internet over the home Wi-Fi/wired network.

Log in to your Napster account

To access **Napster** online music service, you need to log in to your **Napster** account. Use your existing **Napster** account, or use the trial account before you create an account with **Napster**.

- On MCI8080, press **ONLINE SERVICES** on the remote control.
 - From Home screen, go to [Online services] > [Napster].
- Log in to the existing account/trial account:
 - Press ◀ or ▶ to select the entry location;
 - Use the alphanumeric buttons to enter desired digits/letters;
 - You can also press ▲ or ▼ repeatedly, or press and hold ▲ or ▼ until the desired digit/letter appears;
 - Press **OK** to confirm.
 - ↳ Next time you select **Napster**, you see the account name/password that you previously entered.

Tip

- You go to the screen of account management, if you fail to log in to the **Napster** account. As prompted, log in to the account again, or change to another account.

Search for music

1 On the **Napster** screen, select **[Search]** > **[Song]**, **[Album]**, or **[Artist]**.

↳ You can search for music by the name of a song, album, or artist.

2 Enter the name of the desired song, album, or artist.

- Press ◀ or ▶ to select the entry location;
- Use the alphanumeric buttons to enter desired letters;
- You can also press ▲ or ▼ repeatedly, or press and hold ▲ or ▼ until the desired letter appears;
- Press **OK** to confirm.

Or,

1 On the **Napster** screen, select **[Channels]**.

2 Select a playlist by genre (e.g. jazz, blues).

Or,

- On the **Napster** screen, select **[Catalogue]**.
↳ You can browse music as sorted and organized by the expert music service of **Napster**.

Play music

- To start play, press ▶||.
- To stop play, press ■.

My Library

All your played music is saved to **[My Library]**. You can search for the music by song, channel, album, artist, and genre.

Search for music/pictures

In a list of options, you can do one of the following to search for what you need.



Tip

- When doing searching in the following ways, ensure that MCI8080 is in the mode of **[Media Library]**, **[HDD]**, or **[Internet Radio]**.

- Use the navigation keys ▲, ▼, ◀, ▶.
- Start quick search by using the **alphanumeric search**, **Superscroll**, and **Quickjump**.



Note

- **Alphanumeric search**, **Superscroll** and **Quickjump** are available only when you enter a long sorted list of options (excluding the home screen and lists of menus).

Alphanumeric search

In a long list of options, start alphanumeric search by entering characters that an item starts with or contains.

1 Press **SEARCH** on the remote control, if necessary.

↳ A text box appears.



2 Enter characters by using the remote control (see 'Your MCI8080'->'Overview'->'Text entry').

- 3 Press **OK** after completing text entry.
 - ↳ Search starts.
 - ↳ You can find a list of items that contain the characters.
 - ↳ You can find a close match if there is no item that contains the character.

Quickjump

You can also use **Quickjump** for alphanumeric search.

To reach the first item that starts with a certain letter

- On the button corresponding to the letter, press once or repeatedly until the letter appears.



To reach the first item that starts with the next letter

- Press **▶**.

To reach the first item that starts with the previous letter

- Press **◀**.

Superscroll

In a long list of options, **Superscroll** allows you to start a search in an alphabetical order. You can quickly reach the first item that starts with the selected alphabet.

- 1 Press and hold **▲/▼** to start Superscroll.
 - ↳ A pop-up text box appears. Letters are displayed repeatedly in an alphabetical order, starting from current letter:

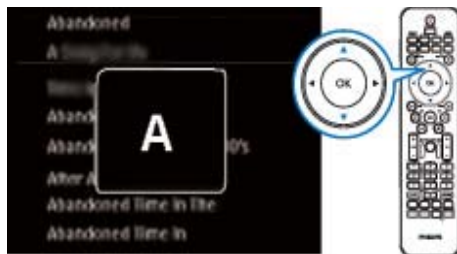

- 2 Release **▲/▼** when you reach the desired letter.
 - ↳ You reach the first item that starts with the letter:

8 Play music CD/ movie DVDs

! Caution

- Never look at the laser beam inside the unit.
- Risk of product damage! Never play discs with accessories such as disc stabilizer rings or disc treatment sheets.
- Never put any objects other than discs into the disc compartment.

☰ Note

- Ensure that you have made connections for disc play (see 'Connect'->'Connect for disc play').
- For the supported disc formats, see 'Your MCI8080'->'Introduction'.

Basic operations

- 1 On MCI8080, press ▲
↳ The disc tray opens.
- 2 Load a disc onto the tray, the printed side facing up. Press ▲
↳ Play starts automatically after disc reading is complete.

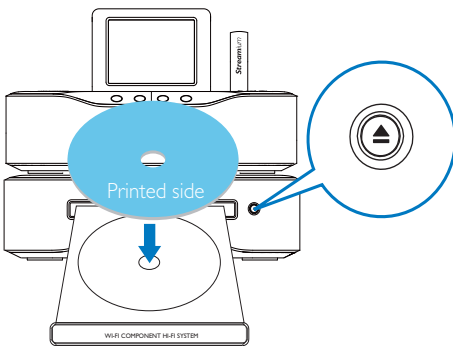

- 3 If necessary, press **DISC** on the remote control, and then press **▶||** to start play.
- 4 During disc play,
 - Press **◀◀▶▶** repeatedly to select a track/chapter. For WMA/MP3 files on a CD-R/RW, or recordable DVD, press **▲/▼** to select a file folder.
 - Press and hold **◀▶** to search forward/backward.
 - Press **▶||** to pause or resume.
 - Press **■** to stop.

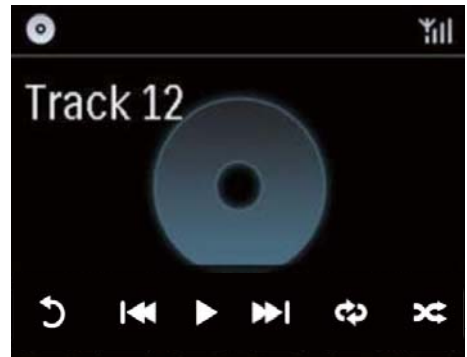

On the CD play screen,

- Tap on the screen to show functional buttons;
- Select play options by tapping on corresponding buttons:

|| / ▶: Tap to pause or play current song;

◀◀ / ▶▶: Tap to select previous/next song;

↻: Tap to play all songs in current folder randomly;

🔄: Tap to play all songs in current folder repeatedly;

⏮: Tap to return to the previous screen.

Use the disc menu

After loading a disc onto the tray, you can see the disc settings on the TV screen.

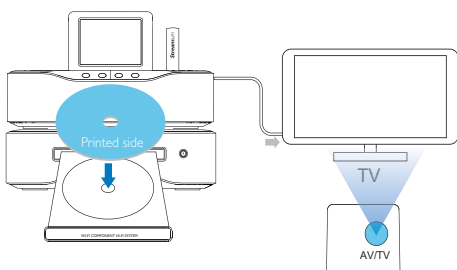

- 1 On MCi8080, load a disc onto the tray.
- 2 Turn on the TV and switch to the correct video-in channel in one of the following ways:
 - On the remote control of your TV, press the AV/TV button repeatedly until you see the Philips screen, or the video disc screen.
 - Go to the lowest channel on your TV, then press the Channel Down button until you see the Philips screen, or the video disc screen.
 - Press the source button repeatedly on the remote control of your TV.

Tip

- The video-in channel is between the lowest and highest channels and may be called FRONT, A/V IN, VIDEO etc. See the TV user manual on how to select the correct input on the TV.

Access the disc menu

To access or exit the menu manually

- In the **DISC** mode, press **DISC MENU** or **SETTINGS** on the remote control.

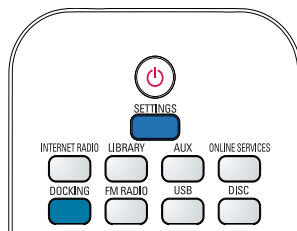

Play movie discs(DVD/DivX/VCD)

Pause/Resume/Stop

To pause

- During disc play, press **▶||** to pause.
 - ↳ The TV screen shows the scenes where you stop play.
- Or, during DVD play, press **■**.
 - ↳ The TV screen shows the Philips screen.

To resume

- Press **▶||**.
 - ↳ The disc play resumes from the last stop point.

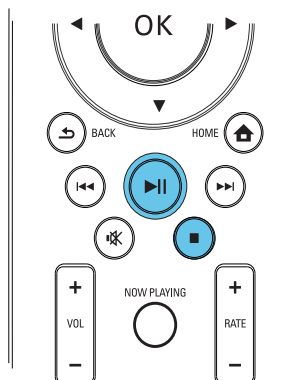

To stop

- Press **■** again.



Search

Fast search forward/backward

- 1 During play, press and hold  to select a search speed.
 - To resume play at normal speed, press .

Search by time or chapter/track

- 1 During disc play, press **SEARCH** until a time field or chapter/track field is displayed.
 - For the time field, enter the play position in hours, minutes and seconds.
 - For the chapter/track field, enter the chapter/track.
 - ↳ Play starts automatically at your selected point.

Select languages for disc play

Select an audio language

You can select an audio language on DVDs or DivX discs.

- 1 During disc play, press **AUDIO**.
 - ↳ The language options appear. If the selected audio channels is unavailable, the default disc audio channel is used.

Note

- For some DVDs, the language can only be changed from the disc menu.

Select a subtitle language

You can select a subtitle language on DVDs.

- During disc play, press **SUBTITLE**.

Note

- For some DVDs, the language can only be changed from the disc menu.

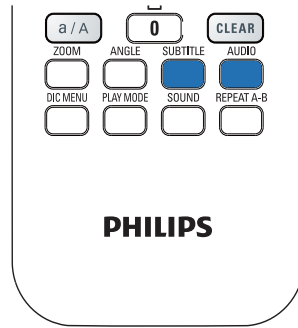

Program favorite chapters/tracks

You can play certain chapters/tracks on a disc. Program the chapters/tracks as desired on the TV screen.

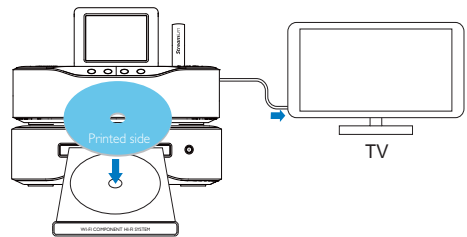



- 1 In the **DISC** mode, ensure that the disc play stops.
- 2 Press **FAVORITE** on the remote control.
 - ↳ On the TV screen, you can see a menu for you to program desired chapters/tracks.

- 3 Use the remote control to enter the desired chapters/tracks.

- 4 Press **FAVORITE** to exit.

To play the program

- Press .
- To erase the program
 - Press  twice;
 - Or, remove the disc from the disc tray.

Select play options

Select Repeat/Shuffle options

During disc play, you can repeatedly play a chapter/track, or a file or files in a folder. You can also play tracks or files in a folder in a random order.

To turn on or off the repeat/shuffle options

- Press **PLAY MODE** on the remote control.

To repeatedly play a section in a disc

- 1 During music or video play, press **REPEAT A-B** at the start point.
- 2 Press **REPEAT A-B** at the end point.
 - ↳ The selected section starts to play repeatedly.
 - ↳ To cancel repeat play, press **REPEAT A-B** again.

Note

- The section A and B can be set only within the same track/title.

Zoom in/out image

- 1 During video/picture play, press **ZOOM** repeatedly to zoom in/out the image.
 - When the image is zoomed in, you can press **▲/▼/◀/▶** to pan through the image.

Change a camera angle

Some DVDs contain alternate scenes, such as scenes recorded from different camera angles. For such DVDs, you can select from the available alternate scenes.

- 1 During DVD play, press **ANGLE** repeatedly to switch between camera angles.



9 Play FM radio

Tune to FM radio stations

Note

- Before you tune to FM radio stations, make sure that you have properly installed the supplied FM antenna (see 'Connect'-'>'Connect the FM antenna').

Autostore

- 1 On MCI8080, press **FM RADIO** on the remote control.
 - Or, from Home screen, select **[FM radio]**.
- 2 In **[FM radio]**, select **[Auto store]**.
 - ↳ MCI8080 starts to search for available stations automatically.
 - ↳ Radio play starts and a maximum of 60 stations are stored as presets when the auto tune is complete.
 - ↳ The preset stations are listed in the order of reception strength, with the RDS stations at the top.
- 3 To select a preset station, go to **[Presets]**.
 - Or, press **FAVORITE** during radio play.

Manual tuning

- 1 In **[FM radio]**, select **[Manual tuning]**.
- 2 Press and hold **◀▶** to start auto tuning.
 - ↳ You tune to the next available station with sufficient reception.
- 3 Press **◀▶** repeatedly for fine tuning.

Edit preset stations

Store current station to a location

When listening to a radio station, you can store current station to a desired location (0-9) in the preset list. The numeric buttons (0-9) on the remote control correspond to the locations (0-9) in the preset list.

- 1 Tune to your desired station.
- 2 On the radio play screen, press and hold a numeric button.
 - If necessary, press **NOW PLAYING** to return to the radio play screen.
 - Current station is stored to the location.

Edit station information

- 1 In the **FM RADIO** mode, go to **[Presets]**.
 - On the radio play screen, press **FAVORITE**.
- 2 In the list of preset stations,
 - Select the station to be edited;
 - Press **a/A** to start editing;
 - Press **◀▶** to select the entry location; press **▲/▼** repeatedly to select desired letters.
- 3 Press **OK** to confirm. Press **BACK** to discard the changes.

Listen to FM radio

- 1 On MCI8080, press **FM RADIO** on the remote control.
 - Or, from Home screen, select **[FM radio]**.
- 2 Tune to your desired station (see 'Play FM Radio'-'>'Tune to FM radio stations').
 - **To select a preset station:**
Go to **[FM radio]** > **[Presets]**;
Or, press the corresponding numeric button on the radio play screen (for the first 10 preset stations only).
- 3 To mute/unmute the radio play
 - Press **⏸**.

RDS (Radio Data System)

RDS (Radio Data System) is a service that allows FM stations to show additional information.

During Autostore, RDS stations are automatically stored at the top of the list of preset stations.

When tuning to an RDS station, you can see the following information on the screen:

- Station name;
- Program type, such as news, sports, and pop music;
- Frequency;
- Scrolling text (RDS text), if available.

Use the RDS for clock setting



Note

- When you use an RDS station for clock setting, ensure that the RDS station broadcasts time signals.

- 1 From Home screen, select **[Settings]** > **[Clock settings]** > **[Date and time]**.
 - To enter **[Settings]**, you can also press **SETTINGS** on the remote control.
- 2 In **[Date and time]**, select **[Current date and time]** > **[Automatic (RDS)]**.
 - ↳ The unit searches for the first preset station automatically.
 - ↳ The time is set according to time signals from the station.
- 3 To use another RDS station for clock setting, tune to the RDS station immediately.



Tip

- To use an RDS station for regular clock setting, store the station as the first preset station.

10 Play from an external audio device (AUX)

With the **AUX IN L / R** socket and **AUX** mode, MCI8080 allows you to play an external audio device (e.g. a portable media player) through the speakers of MCI8080.

Play from an external audio device

- 1** Ensure that the external audio device is properly connected to MCI8080 (see 'Connect'->'Connect external audio devices').
- 2** On MCI8080, select the **AUX** mode.
 - From Home screen, select **[AUX]**.
 - Or, press **AUX** on the remote control.
- 3** On the external audio device, start music play.
 - For the music play, you can use the sound settings on MCI8080 (see 'Settings'->'Sound settings').



11 Settings

Play modes

When playing music, you can choose to play repeatedly, play in random order, or play one by one. Select a play mode as desired.

To select a play mode for music play

Before or during music play,

- From Home screen, go to **[Settings]** > **[Play mode]**; Or,
- Press **PLAY MODE** on the remote control.
 - ↳  - Play all songs in current folder repeatedly;
 - ↳  - Play current song repeatedly;
 - ↳  - Play all songs in current folder randomly.

Sound settings

On MCI8080, you can select different sound settings in **[Settings]** > **[Sound settings]**.

- 1 From Home screen, go to **[Settings]** > **[Sound settings]**.
 - Or, press **SETTINGS** on the remote control to enter **[Settings]**.
- 2 Select the option. Press **OK** to turn it on or off.

Or,

On the remote control, press **SOUND** to enter the menu of sound settings.

 - To exit the menu of sound settings, press  **BACK**.

Bass and treble

Use **[Bass / Treble]** to adjust the low (bass) or high (treble) range of musical notes.

- 1 From Home screen, go to **[Settings]** > **[Sound settings]** > **[Bass / Treble]**.
 - Or, press **SOUND** on the remote control to enter the menu of sound settings.
- 2 Press  repeatedly to increase/decrease the level.
 - Press **CLEAR** to select neutral level.

Full sound

[FullSound] restores the sonic details that music compression loses (e.g. MP3, WMA).

Turn on or off **[FullSound]** in **[Settings]** > **[Sound settings]**.

Direct Source

With **[Direct source]**, you can turn off the settings of sound effects on MCI8080, including **[FullSound]** and **[Bass / Treble]**.

Thus, music plays in an original way, without the sound effects from MCI8080.

- Turn on or off **[Direct source]** in **[Settings]** > **[Sound settings]**.

Tip

- When **[Direct source]** is on, you can still adjust the volume and **[Balance]**.
- The sound effect settings are retained and enabled when **[Direct source]** is off.

Audio balance

With **[Balance]**, you can improve listening experience by adjusting difference between the left and right audio channels.

- 1 From Home screen, go to **[Settings]** > **[Sound settings]** > **[Balance]**.
 - Or, press **SOUND** on the remote control to enter the menu of sound settings.

- 2 Press ◀▶ repeatedly to increase/decrease the output from left/right audio channels.
 - Press **CLEAR** for equal output from left/right audio channels.

Display settings

Brightness

On MCI8080, you can adjust the brightness of the display. As desired, the display lights up, dims or turns off when MCI8080 is turned on or switched to active standby.

- In **[Settings] > [Display settings] > [Brightness when on]** or **[Brightness when standby]**, select an option and press **OK**.

Wallpaper

For menus on MCI8080, you can set the background display (wallpaper).

To set wallpaper

- 1 On MCI8080, select and play a photo.
- 2 Press **SETTINGS** on the remote control to select **[Settings] > [Display settings] > [Wallpaper]**.
- 3 In **[Wallpaper]**, select **[Current picture]**.
↳ Current picture is set as wallpaper.

Screensaver

On MCI8080, the screensaver is turned on when MCI8080 is switched to active standby.

When turned on, the selected screensaver appears. The clock is shown on the lower right corner of the screen.

By default, clock display appears as the screensaver.

To set screensaver

- 1 On MCI8080, select and play a picture.
- 2 Press **SETTINGS** on the remote control to select **[Settings] > [Display settings] > [Screen saver]**.
- 3 In **[Screen saver]**, select **[Current picture]**.
↳ Current picture is set as screensaver.

Slideshow settings

When in the slideshow mode, you can view pictures one by one.

To select a play mode for slideshow

- 1 From the home screen, go to **[Settings] > [Slideshow settings]**.
Or, press **SETTINGS** on the remote control to enter **[Settings]**.
- 2 Select one of the following play modes. Press **OK** to turn it on or off.
 - ↳ **[Repeat]**: Play all pictures repeatedly;
 - ↳ **[Shuffle]**: Play all pictures randomly.

To set the play time of each picture

- 1 From Home screen, go to **[Settings] > [Slideshow settings] > [Time per slide]**.
 - Or, press **SETTINGS** on the remote control to enter **[Settings]**.
- 2 In **[Time per slide]**, select the desired time duration.

Album art

Album art (the picture of CD/album cover) is sometimes available for music downloads. With some media management software, album art can be inserted for the songs. By turning **[Album art]** on or off, you can choose whether to show the picture of CD/album cover for corresponding songs.

To turn on [Album art]

- 1 From the home screen, go to **[Settings]** > **[Album art]**.
Or, press **SETTINGS** on the remote control to enter **[Settings]**.
- 2 Select **[Album art]**. Press **OK** to turn it on or off.
If **[Album art]** is on,
↳ In the list of songs, the album art appears as thumbnail along with the corresponding song.



- ↳ During the song play, the album art is displayed in full screen as the background.



Clicker sound

MCi8080 can give you an audible feedback (clicker sound) every time you press a button on the remote control.

You can turn the clicker sound on or off in **[Settings]** > **[Clicker sound]**.

Clock settings

Alarm

Set the alarm

- 1 Ensure that you have set the clock (see 'Settings'->'Date and time').
- 2 From Home screen, go to **[Settings]** > **[Clock settings]** > **[Alarm]**.
 - Or, press **SETTINGS** on the remote control to enter **[Settings]**.
- 3 To set the source of alarm sound,
 - Select **[Music]**:
↳ At the set alarm time, last played song starts/resumes, or you tune to the last played Internet radio station.
 - Select **[Buzzer]**.
↳ At the set alarm time, the buzzer sounds.
- 4 To set the alarm time,
 - Press and hold **▲/▼**, or press **▲/▼** repeatedly until you reach the desired digits. Press **OK** to confirm.
 - Or, enter the desired digits by using the alphanumeric buttons on the remote control.
↳ The alarm icon **🔔** appears on the screen.

To play a song or Internet radio station as the next alarm sound

- 1 Ensure that you have selected **[Music]** in the Step 3 above;
- 2 Before you turn off MCI8080, or switch MCI8080 to active standby,
 - Go to **[Media Library]**, and select and play the desired song;
 - Or, go to **[Internet Radio]**, and tune to the desired station.

Use the alarm

At the set alarm time, music/Internet radio plays as desired, or the buzzer sounds.

Note

- The alarm sounds even if you have switched MCI8080 to active standby or Eco standby.
- The buzzer sounds instead, if MCI8080 fails to connect to a music library or an Internet radio station.
- MCI8080 is unmuted if it has been muted.
- The alarm sounds in a higher volume if the volume level is lower than minimum.

To snooze the alarm

- Press any button on the unit or the remote control (except for the volume buttons).
 - ↳ The alarm sounds again 15 minutes later. The alarm icon remains.

To stop the alarm

- Press and hold *** or 0**.
 - ↳ The alarm is stopped. The alarm icon disappears.
 - ↳ The alarm sounds again next day.

To turn off the alarm

- Go to **[Settings] > [Clock settings] > [Alarm]**. Select **[Alarm off]** and press **OK** on the remote control.

Sleep timer

With the sleep timer, you can have MCI8080 turned off automatically after the set timer duration.

To set the time duration

- 1 From the home screen, go to **[Settings] > [Clock settings] > [Sleep timer]**.
 - Or, press **SETTINGS** on the remote control to enter **[Settings]**.
- 2 Select an option. Press **OK** to turn it on.

Date and time

The date and time can be set automatically or manually.

Automatic setting

For automatic clock setting, use the online service over the Internet, or use the time signal from FM RDS radio.

Through the online service over the Internet

- 1 Turn on the unit, if necessary.
 - Ensure that the unit is connected to the home Wi-Fi/wired network and Internet.
- 2 From Home screen, select **[Settings] > [Clock settings] > [Date and time]**.
 - Or, press **SETTINGS** on the remote control to enter **[Settings]**.
- 3 In **[Date and time]**, select **[Current date and time] > [Automatic (Internet)]**.
 - ↳ The unit starts auto time setting over the Internet.
 - ↳ A message appears when the setting is done.

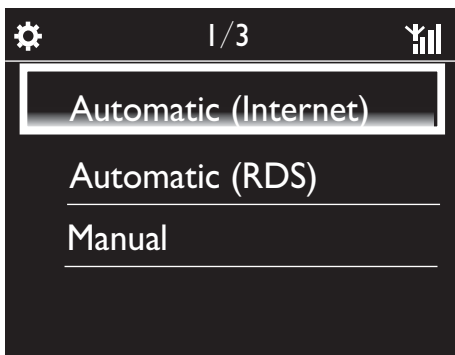

Tip

- According to the location and time zone you select, the unit can have the clock time set and adjusted automatically through the online service over the Internet.
- To check and change current location and time zone, go to **[Settings]** > **[Location and time zone]**.

Through time signals from FM RDS radio

- 1 On the unit, turn on the FM radio, if necessary.
 - Ensure that the FM antenna is connected properly CA-MCI8080-Connect the FM antenna (see 'Connect the FM antenna' on page 23).
- 2 On the first location for preset stations, store an FM RDS station that transmits time signals.
- 3 From Home screen, select **[Settings]** > **[Clock settings]** > **[Date and time]**.
 - Or, press **SETTINGS** on the remote control to enter **[Settings]**.
- 4 In **[Date and time]**, select **[Current date and time]** > **[Automatic (RDS)]**.
 - ↳ The unit searches for the first preset station automatically.
 - ↳ The time is set according to time signals from the station.

Manual setting

- 1 Turn on the unit, if necessary.
- 2 From Home screen, select **[Settings]** > **[Clock settings]** > **[Date and time]**.
 - Or, press **SETTINGS** on the remote control to enter **[Settings]**.
- 3 In **[Date and time]**, select **[Current date and time]** > **[Manual]**.
- 4 To enter date and time,
 - Press ◀ or ▶ to select the entry location;
 - Use the alphanumeric buttons to enter desired digits;
 - Press **OK** to confirm.
 - You can also press ▲ or ▼ repeatedly, or press and hold ▲ or ▼ until the desired digit appears.

Set date/time format

Select how date and time are displayed in the clock.

- 1 Follow Step 1-2 under "Manual setting".
- 2 In **[Date and time]**, go to **[Time format]** or **[Date format]** to select options.

Network settings

Setup network

After the first-time setup, you can change how **MCI8080** connects to home Wi-Fi/wired network:

- Switch between different connection methods (wireless or wired, automatic or manual);
- Switch between different routers. To do so, do the following:
 - 1 From Home screen, go to **[Settings]** > **[Network settings]** > **[Setup network]**.
 - Or, press **SETTINGS** on the remote control to enter **[Settings]**.

- 2 Connect **MCi8080** as you did in the first-time setup (see 'First-time setup'->'Connect to home Wi-Fi/wired network').

Device name

In **[Device name]**, you can name/rename your MCi8080. On a connected UPnP server/client, the MCi8080 can be found as named.

- 1 From Home screen, go to **[Settings]** > **[Network settings]** > **[Device name]**.
- 2 In **[Device name]**, press **◀▶** to select the entry location; press **▲/▼** repeatedly to select desired letters.

USB sharing

When you connect **MCi8080** to home Wi-Fi/wired network, the HDD connected to **MCi8080** can work as a shared disk of the network. Contents on the HDD can be played or shared on computers or UPnP devices that are also connected to the network.

- To permit or prohibit the sharing, go to **[Settings]** > **[Network settings]** > **[USB sharing]**. Press **OK** to turn on or off the sharing.

Location and time zone

After the first-time setup, you can change the selected location and time zone when moving to a new location or time zone.

According to the selected location and time zone, MCi8080 can

- Set clock automatically over the Internet (see 'Settings'->'Date and time');
- Pre-load preset Internet radio stations automatically.

Language

After the first-time setup, you can change the language selection in **[Settings]** > **[Language]**.

Device information

From the home screen, go to **[Settings]** > **[Device ID and information]**. You can learn about information about MCi8080, including model number, name to be shown on a UPnP server/client, software version and network settings.

Check for software upgrades

On the MCi8080, you can check for software upgrades. After you click to agree to the terms and conditions, the downloading and installation of new upgrades start automatically.

- 1 Ensure that MCi8080 is connected to the Internet.
- 2 From Home screen, go to **[Settings]** > **[Check for software upgrades]**.

Demo mode

After the first-time setup, you can view the demo again.

- 1 From Home screen, go to **[Settings]** > **[Demo mode]**.
↳ Demo play starts.
- 2 To exit the demo play, press **⏏**.
↳ The unit is switched to Eco standby.

Restore factory settings

You can restore MCI8080 to factory settings. All your settings are removed, including the settings of network, sound, display, clock, alarm and language.

- 1 Go to **[Settings]** > **[Restore factory settings]**.
- 2 As prompted, select **[Yes]**.
 - ↳ The unit is turned off.
 - ↳ The unit is turned on again automatically when the factory settings are restored.
 - ↳ Start the first-time setup.

12 Register MCI8080 with Philips

Benefits

By registering MCI8080 on www.philips.com/welcome, you can

- Get free software upgrades;
- Manage your own favorite radio stations;
- Receive Streamium newsletters.

Note

- Registration of **MCI8080** requires a valid email address.

Register MCI8080

Use a valid email address as the account when you register MCI8080 on www.philips.com/welcome.

You can complete the registration directly on www.philips.com/welcome. Or, use an email address to register on the device, and then, complete the registration through the web site link that you received in the email.

Register on the web site

To register MCI8080 directly on www.philips.com/welcome, you need to fill in the following information as prompted during registration:

- A valid email address as the registration account;
- Product model number;
- Product registration ID.

To get the product model number

- Look at the packaging box of the device or the product label. You can always find the model number on the packaging box or product label (e.g. MCI8080, NP3700).



To get the product registration ID

- On MCI8080, go to **[Settings]** > **[Device ID and information]**. Press ▼ repeatedly to find **[Product Registration ID]**.

Register on the device

Use an email address to register on the device, and then, complete the registration through the web site link that you received in the email.

- 1 Ensure that MCI8080 is connected to the Internet.
- 2 To register with www.philips.com/welcome,
 - On MCI8080, select **[Settings]** > **[User registration]** > **[Register now]** > **[Register on the device]**;
 - As prompted, enter your valid email address (see 'Your MCI8080' -> 'Overview' -> 'Text entry').
 - ↳ You receive an email message from ConsumerCare@Philips.com.

- On a computer, use the web site link in the email to complete registration.

**Tip**

- To log in to Philips online services later, use the web site link in the email, and the password.

Unregister MCI8080

When registering with www.philips.com/welcome, you can only use one account for one unit (e.g. MCI8080). For each account, you can maintain a set of favorite stations and manually added stations.

To use another account for registration, you need to unregister current one.

To unregister an account

- 1 On MCI8080, select **[Settings]** > **[User registration]** > **[Unregister]**.
- 2 As prompted, confirm to start unregistering the account.

**Tip**

- When re-registering the account, you can recover the Internet radio stations that you maintained with Philips online services.

Check registration information

You can check whether you have registered the MCI8080, and what account you have used for registration. To check the information, go to **[Settings]** > **[User registration]** > **[Registration status]**.

13 Maintenance

This chapter tells you how to care for MCI8080.

Cleaning



Note

- Avoid moisture and abrasion.

- 1 Clean MCI8080 only with a soft dry cloth.

14 Technical data

General

AC Power (Main unit)

230V \pm 10%, 50Hz (for /12, /05 /79)

120V \pm 10%, 60Hz (for /37)

DC Power (DVD unit)

DIN connector (Output provided by Main unit)

DC Power (HDD unit)

5V USB power, 900mA (Provided by Main unit)¹

Dimensions

Main unit: 251 x 251 x 142mm (including LCD)

DVD unit: 251 x 251 x 74mm

HDD unit: 122 x 75 x 13mm

Speaker box: 180 x 282.9 x 295mm

Weight (net)

12.50kg (all items)

Note

- ¹Use HDD only with the by-packed USB wire.

Power consumption

Active (On)

50W

(Active) Standby

\leq 12.5W (HDD-spun down)

ECO (Passive) Standby

\leq 0.9W

Audio inputs

Aux in (Line in)

2x Cinch

Input sensitivity

0.8V

Input impedance

$>$ 10k Ω (Ohms)

Audio outputs

Headphones

1 x 3.5mm jack, 20 – 18000Hz, 32 Ω (Ohms)

Signal to noise ratio (Headphones)

typically \geq 85dBa (IEC)

Distortion (Headphones)

\leq 1%

Audio / Video outputs (only provide output during disc playback)

CVBS

1 x Cinch, 1Vpp, 75 Ohm

HDMI

480i, 480p, 576i, 576p, 1080i, 1080p

Video system

PAL / NTSC

Video format

4:3 / 16:9

Audio amplifier (Digital)

Output power

2 x 50W (RMS) (= total power 100W)

Frequency response

20Hz to 20000Hz (\pm 0.5dB)

Signal to noise ratio

typically 92dB/ \geq 93dBa

Speakers

Power handling

50W (RMS)

Impedance

8 Ω (Ohms)

Sensitivity

83dB/ 1m / W

Dimensions

Woofer: 5.25 inches

Tweeter: 1.00 inches

Frequency response

75 to 20000Hz

Sound features

FullSound®

Yes (on/ off)

Bass / Treble control

+/- 10 steps

Balance control

+/- 10 steps

Direct Source (Flat)

Yes (on/ off)

Wireless

Wireless standard

802.11n, backwards compatible to 802.11b/ g

Wireless security

WEP (64 or 128 bit),

WPA / WPA2 (8-63 characters)

Frequency range

2412 - 2462 MHz (CH1-CH11) (for /79, /37, /55, /97)

2412 - 2472 MHz (CH1-CH13) (for /12, /05)

Antenna

1 x external, diversity mode enabled

Wireless protected setup (WPS)

Yes (PBC + PIN)

Wired (LAN / Ethernet)

Wired standard

802.3 / 802.3 u

Speed

10 / 100mbps

Mode

half / full duplex

Crossover detection (Auto MDIX)

Yes

Note

- The wired and wireless network interfaces cannot be turned on at the same time.

Internet services

Internet radio

Media Library

Decoding capabilities (excluding the disc player)

MP3

8 - 320kbps (CBR / VBR)

WMA

32kbps - 192kbps (CBR / VBR)

WMT DRM - ND (WMA DRM - 10)

Yes, enabled (only from a UPnP server)

AAC (M4A)

16 - 320kbps (CBR / VBR)

PCM/ WAV

1x (1.4Mbps)

FLAC

Yes, supported

Ogg Vorbis

Yes, supported

eAAC+

Yes, supported

JPEG

Yes, supported (Maximum size: 7MB)

Playlist support (excluding the disc player)

*.m3u, *.wpl

Yes

iTunes, Rhapsody

Yes (via by-packed UPnP Server)

FM Tuner

Frequency range

87.50 to 108.00MHz

No. of Presets

60

Signal noise ratio

Typically 60dB

Tuning grid

50kHz

RDS

Yes, including RDS clock setting

Antenna connector

IEC (75 Ohm)

DISC player

Supported discs

DVD, VCD, SVCD, DVD+RW, DVD-RW, DVD+R, DVD-R, Picture (JPEG) CD, DivX (Ultra) Disc, MP3 / WMA CDR / CDRW, CD (CDDA)

Disc size support

8cm/ 12cm

Video decoding

MPEG 1, MPEG 2, DivX, JPEG

Audio decoding

MP3: 32 to 320kbps (Sampling rate: 32, 44.1, 48kHz)

WMA: 32 to 360kbps (Sampling rate: 44.1, 48kHz)

RDS

Yes; PTY, PS, Text including RDS clock setting

HDMI Audio support

Yes

USB

USB port type

Type A

Supported media

FAT, FAT-32, NTFS V 3-1

Supported class

MSC only (no MTP support)

Multi-partition support

No, only first readable partition

Database support

Up to 40000 songs

HDD

Disc type

2.5 inches

Size

160GB³

Format

FAT32



Note

- ³Available disc size is less due to preloaded contents.

Display/Clock

Resolution

Dotmatrix, 320 x 240 dots (QVGA), Color TFT

Size

3.5 inches

Backlight

Can be turned on/ off and can be dimmed

Clock/ Date display

Yes

Wallpaper/ Screensaver

Yes

Automatic time setting via Internet (NTP)

Yes, enabled

Sleep timer

Yes

Internal (key) clicker

Yes

Others

UPnP²

DMP (Local Renderer, Local Controlpoint)/
DMS

Note

- ² Requires User-registration @ Rhapsody.
- ² Capable to connect to - Windows Media Player 11/12, Winamp, TwonkyMedia;- Philips Music Center WAC3500 / WAC7500 / MCi500H;- Philips NAS SPD8020CC;- Mobile phone Nokia N85, N95,N900.
- Specifications and external appearance are subject to changes without notice.

15 Troubleshooting

I cannot hear any sound or the sound is poor, what do I do?

- Press + VOL - to increase the volume.
- Press the MUTE button again to reactivate the sound output.

Is there a maximum distance of transmission between a wireless router and MCi8080 for effective streaming?

Yes. The maximum distance of Wi-Fi transmission is 250m measured in open spaces. However, in a home environment, where solid obstacles such as walls and doors are present, the effective transmission distance is reduced to 50-100m. Reposition the devices if you experience transmission problems.

I have not received any registration email from ConsumerCare@Philips.com.

- Check that the email address that is entered in the user registration section is valid and spelled correctly.
- Check that the PC has an active Internet connection.
- The Internet server may be busy, try again later.
- Check if the email was redirected to the spam folder.

How do I avoid Wi-Fi interferences from other devices that operate in the same (2.4GHz) frequency spectrum, such as Dect phones or bluetooth devices?

- Move MCi8080 at least 3m away from such devices.
- Use a WEP/WPA encryption key when you create the wireless connection your PC / home network.
- Change the operating channel on the interfering devices.
- Turn the devices in different directions to minimize interference.

16 Contact information

Argentina	(54-11) 4544-2047
Australia	1300 363 391
Austria	0810 000 205
Belgium	78250145
Belarus	882000110068
Brazil	0800 701 02 03 (all except Sao Paulo)(11) 2121-0203 (Sao Paulo only)
Bulgaria	8001154424
Canada	1-888-744-5477
Chile	600 744 5477 (600-PHILIPS)
China	4008 800 008
Colombia	01 800 700 7445
Croatia	800222778
Czech Republic	800142840
Denmark	35258759
Estonia	8000100288
Finland	923113415
France	805025510
Germany	8000007520
Greece	80031221280
Hong Kong	852-2619 9663
Hungary	680018189
India	1860-180-1111
Ireland	16011777
Israel	9600900-09
Italy	800088774
Japan	0570-07-6666
Korea	080-600-6600
Latvia	80002794
Luxembourg	4066615644
Malaysia	1800 880 180
Mexico	01 800 504 6200
Netherlands	8000230076
New Zealand	0800 658 224
Norway	22708111

Pakistan	051 580 902-3
Peru	0800 00100
Philippines	(63 2) 667 9000
Poland	8003111318
Portugal	800780903
Romania	800894910
Russia Federation	(495)961-1111 (local rate)8-800-200-0880 (mobile phone - free)
Singapore	65 6882 3999
Slovakia	800004537
South Africa	(011) 471-5194
Spain	900800655
Sweden	857929100
Switzerland	844800544
Taiwan	0800 231 099
Thailand	66 2 652 8652
Turkey	0800 261 3302
Ukraine	8-800-500-69-70
United Kingdom	8003316015
United States	1-888-744-5477
Uruguay	(598-2) 619 6666
Venezuela	0800 100 4888

Streamium terms and conditions

Terms and Conditions of Use of your Philips Streamium-enabled Device

Congratulations on your purchase of a Philips Streamium-enabled Device ("Device"). These Terms and Conditions of Use give you the rights to use certain features on your Device relating to the streaming of content. You must agree to these Terms and Conditions of Use before using the Device. Your use of the Device constitutes your agreement to be bound by these Terms and Conditions of Use and will give you the right to access these features. If you do not agree to these Terms and Conditions of Use, you may return your Device to the point of purchase. These Terms and Conditions of Use supplement, and do not replace, any terms, conditions or disclaimers which were provided with your purchase of the Device. All such terms, conditions and disclaimers remain in full force and effect.

Eligibility for Registration.

You must be at least 14 years of age to assume the responsibilities of these Terms and Conditions of Use. If you are under 14 years of age, you may not use the Device unless one of your parents or legal guardians assumes the responsibilities of these Terms and Conditions of Use. Your use of the Device constitutes your representation that you are either 14 years of age or, if you are under 14 years of age, that your parent or legal guardian has assumed the responsibilities of these Terms and Conditions of Use.

Restrictions on Modification of your Device

Your Device provides access to certain streams of content. As a condition of obtaining access to those streams through the Device, you agree not to tamper with or otherwise modify or attempt to modify the Device in any way (including through the use of software or by making physical alterations to the Device). You agree that you will not circumvent or attempt to circumvent technological measures employed to control access to, or the rights in, any content. You agree that you will not circumvent or attempt to circumvent any copy management system by any means. You agree that you will not decipher or attempt to decipher cryptographic keys or otherwise defeat or attempt to defeat any security features implemented in the Device or in the content streams. You agree that you will not use the Device for any unauthorized purpose or in contravention of any law or regulation.

Disclaimers Regarding Content

The streams of content which are accessible through your Device are not controlled or programmed by Philips. Rather, they are provided by third parties. Think of your Device (in addition to its other features) as a form of "tuner" which allows you to receive the content broadcast by many others outside of your local area. Since the content is provided by others, PHILIPS HAS NO EDITORIAL CONTROL OVER ANY OF THAT CONTENT RECEIVED THROUGH YOUR DEVICE AND, THEREFORE IS NOT LIABLE FOR CONTENT OR ITS NATURE OR DELIVERY. PHILIPS DOES NOT ENDORSE ANY OPINIONS EXPRESSED IN ANY CONTENT RECEIVED THROUGH YOUR DEVICE. PHILIPS DOES NOT GUARANTEE THE TRUTHFULNESS, ACCURACY, RELIABILITY, COMPLETENESS OR TIMELINESS OF CONTENT. YOU AGREE THAT ANY RELIANCE ON CONTENT IS AT YOUR OWN RISK.

Limitations on Access to Streams.

Philips does not guarantee access to any particular stream or to the content contained in any stream. Philips may, in its discretion, add or remove access to any specific stream or content at any time. Some streams are accessible through arrangements with online service providers which determine which streams are listed on their directories. Although Philips will strive to provide a good selection of online service providers, Philips does not guarantee continued access to any specific online service provider. Philips may, in its discretion, add or remove access to any specific online service provider.

Rights in Content

Content may be protected by copyright laws or other intellectual property or proprietary laws. In some situations, such as use of the Device in a commercial environment, it may be necessary for you to obtain, at your own risk, a license or other authorization to use such content. You agree that, in the event such a license or

authorization is necessary, it is your responsibility to obtain any such license or authorization. You agree that you are solely liable for any damages you may incur resulting from your failure to obtain the proper license or authorization for use of the content accessible through the Device. You agree that Philips will have no liability to you with regard to your use of the content.

Changes in Features

Philips may, in its discretion, change the features of the Device, including adding features to, or removing features from, the Device. Some new features may require changes to these Terms and Conditions of Use. Your use of those new features will constitute your agreement to the revised Terms and Conditions of Use.

Software and Intellectual Property Rights

You may need to use certain software programs to use or have full access to certain features of the Device. You received certain software with the purchase of the Device and may receive other software from time to time in the future. Most of that software is contained in the Device and is not accessible to you. Some of that software is owned by Philips and some is owned by others. Your use of software owned by Philips is subject to these Terms and Conditions of Use and any applicable license agreement. Your use of software owned by others is governed by their applicable license agreements. Your use of software does not transfer any title or ownership rights in the software to you. Philips retains all its rights in software and other intellectual property, including copyrights, patent rights, and rights in its trademarks and trade names. You agree that you will not disassemble, decompile, create derivative works of, reverse engineer, modify, sublicense, distribute the software or use the software for any unauthorized purpose or in contravention of any law or regulation.

Warranty Disclaimer

PHILIPS MAKES NO REPRESENTATION OR WARRANTY, EXPRESS OR IMPLIED, THAT THE DEVICE WILL MEET YOUR REQUIREMENTS OR THAT THE USE OF THE DEVICE WILL BE UNINTERRUPTED, TIMELY, SECURE OR FREE FROM ERRORS. PHILIPS MAKES NO WARRANTY AS TO THE CONTENT CARRIED IN ANY STREAM. PHILIPS MAKES NO REPRESENTATION OR WARRANTY, EXPRESS OR IMPLIED, AS TO THE INFORMATION OR CONTENT ACCESSED THROUGH YOUR DEVICE OR TO YOUR RELIANCE ON, OR USE OF, ANY INFORMATION OR CONTENT ACCESSED THROUGH YOUR DEVICE. SPECIFIC WARRANTIES WERE PROVIDED WITH YOUR PURCHASE OF YOUR DEVICE AND THOSE WARRANTIES, INCLUDING ANY DISCLAIMERS TO THOSE WARRANTIES, CONTINUE TO APPLY. Because some jurisdictions do not permit the disclaimer of implied warranties, such disclaimers may not apply to you.

Limitation of Liability

PHILIPS WILL NOT BE LIABLE TO YOU OR TO ANY OTHER PARTY FOR ANY INDIRECT, INCIDENTAL, PUNITIVE, SPECIAL OR CONSEQUENTIAL DAMAGES (INCLUDING LOST PROFITS OR LOST SAVINGS) OR FOR LOSS OF DATA OR BUSINESS INTERRUPTION ARISING OUT OF OR RELATING TO YOUR USE OF THE DEVICE WHETHER OR NOT SUCH DAMAGES ARE BASED ON TORT, WARRANTY, CONTRACT OR ANY OTHER LEGAL THEORY - EVEN IF PHILIPS HAS BEEN ADVISED, OR IS AWARE, OF THE POSSIBILITY OF SUCH DAMAGES. IN NO EVENT WILL PHILIPS CUMULATIVE LIABILITY FOR DAMAGE (FROM ANY CAUSE WHATSOEVER) EXCEED THE AMOUNT YOU PAID FOR YOUR DEVICE.

Miscellaneous

"This agreement will be governed by the laws of the jurisdiction in which the Device was sold and you hereby consent to the non-exclusive jurisdiction of courts in the relevant country. If any provision of this agreement is invalid or unenforceable under applicable law, such provision will be deemed modified to the extent necessary to render such provision valid and enforceable and the other provisions of this agreement will remain in full force and effect. These Terms and Conditions of Use will not be governed by the United Nations Convention of Contracts for the International Sale of Goods, the application of which is hereby expressly waived."

BY USING YOUR DEVICE, YOU REPRESENT THAT YOU HAVE READ AND UNDERSTOOD THESE TERMS AND CONDITIONS OF USE AND THAT YOU ACCEPT THEM.

NOTICE

SOFTWARE END USER LICENSE AGREEMENT

THIS SOFTWARE END USER LICENSE AGREEMENT (“THIS AGREEMENT”) IS A LEGAL AND BINDING AGREEMENT BETWEEN YOU (EITHER AN INDIVIDUAL OR ENTITY) AND PHILIPS CONSUMER ELECTRONICS B.V.A DUTCH LIMITED LIABILITY COMPANY, WITH ITS PRINCIPAL OFFICE AT GLASLAAN 2, 5616 LW EINDHOVEN, THE NETHERLANDS AND ITS SUBSIDIARY COMPANIES (INDIVIDUALLY AND COLLECTIVELY “PHILIPS”). THIS AGREEMENT GIVES YOU THE RIGHT TO USE CERTAIN SOFTWARE (THE “SOFTWARE”) INCLUDING USER DOCUMENTATION IN ELECTRONIC FORM WHICH MAY HAVE BEEN PROVIDED SEPARATELY OR TOGETHER WITH A PHILIPS PRODUCT (THE “DEVICE”) OR A PC. BY DOWNLOADING, INSTALLING OR OTHERWISE USING THE SOFTWARE, YOU ACCEPT AND AGREE TO BE BOUND BY ALL OF THE TERMS AND CONDITIONS OF THIS AGREEMENT. IF YOU DO NOT AGREE TO THESE TERMS AND CONDITIONS, DO NOT DOWNLOAD, INSTALL OR OTHERWISE USE THE SOFTWARE. IF YOU ACQUIRED THE SOFTWARE IN TANGIBLE MEDIA E.G. CD WITHOUT THE OPPORTUNITY TO REVIEW THIS LICENSE AND DO NOT ACCEPT THESE TERMS, YOU MAY RECEIVE A FULL REFUND OF THE AMOUNT, IF ANY, THAT YOU PAID FOR THE SOFTWARE IF YOU RETURN THE SOFTWARE UNUSED WITH PROOF OF PAYMENT WITHIN 30 DAYS FROM THE DATE OF PURCHASE.

1. Grant of License. This Agreement grants you a non-exclusive, nontransferable, non-sub licensable license to install and use, on the Device or a PC, as applicable, one (1) copy of the specified version of the Software in object code format as set out in the user documentation solely for your personal use. The Software is “in use” when it is loaded into the temporary or permanent memory (i.e. RAM, hard disk, etc.) of the PC or the Device.

2. Ownership. The Software is licensed and not sold to you. This Agreement grants you only the right to use the Software, but you do not acquire any rights, express or implied, in the Software other than those specified in this Agreement. Philips and its licensors retain all right, title, and interest in and to the Software, including all patents, copyrights, trade secrets, and other intellectual property rights incorporated therein. The Software is protected by copyright laws, international treaty provisions, and other intellectual property laws. Therefore, other than as expressly set forth herein, you may not copy the Software without prior written authorization of Philips, except that you may make one (1) copy of the Software for your back-up purposes only. You may not copy any printed materials accompanying the Software, nor print more than one (1) copy of any user documentation provided in electronic form, except that you may make one (1) copy of such printed materials for your back-up purposes only.

3. License Restrictions. Except as provided otherwise herein, you shall not rent, lease, sublicense, sell, assign, loan, or otherwise transfer the Software. You shall not, and you shall not permit any third party, to reverse engineer, decompile, or disassemble the Software, except to the extent that applicable law expressly prohibits the foregoing restriction. You may not remove or destroy any product identification, copyright notices, or other proprietary markings or restrictions from the Software. All titles, trademarks, and copyright and restricted rights notices shall be reproduced on your back up copy of the Software. You may not modify or adapt the Software, merge the Software into another program or create derivative works based upon the Software.

4. Termination of certain functionality. The Software may contain components of certain licensed software including software licensed from Microsoft Corporation (“Microsoft”) which implements Microsoft’s digital rights management technology for Windows Media. Content providers are using the digital rights management technology for Windows Media (“WM-DRM”) to protect the integrity of their content (“Secure Content”) so that their intellectual property, including copyright, in such content is not misappropriated. Your Device may also use WM-DRM software to transfer or play Secure Content (“WM-DRM Software”). If the security of such WM-DRM Software is compromised, Microsoft may revoke (either on its own or upon the request of the owners of Secure Content (“Secure Content Owners”)) the WM-DRM Software’s right to acquire new licenses to copy, store, transfer, display and/or play Secure Content. Revocation does not alter the WM-DRM Software’s

ability to play unprotected content. A list of revoked WM-DRM Software is sent to your PC and/or your Device whenever you download a license for Secure Content. Microsoft may, in conjunction with such license, also download revocation lists onto your Device on behalf of Secure Content Owners, which may disable your Device's ability to copy, store, display, transfer, and/or play Secure Content. Secure Content Owners may also require you to upgrade some of the WM-DRM components distributed with this Software ("WM-DRM Upgrades") before accessing their content. When you attempt to play Secure Content, WM-DRM Software built by Microsoft will notify you that a WM-DRM Upgrade is required and then ask for your consent before the WM-DRM Upgrade is downloaded. WM-DRM Software built by Philips may do the same. If you decline the upgrade, you will not be able to access Secure Content that requires the WM-DRM Upgrade; however, you will still be able to access unprotected content and Secure Content that does not require the upgrade. WM-DRM features that access the Internet, such as acquiring new licenses and/or performing a required WM-DRM Upgrade, can be switched off. When these features are switched off, you will still be able to play Secure Content if you have a valid license for such content already stored on your Device. However, you will not be able to use certain of the WM-DRM Software features that require Internet access such as the ability to download content that requires the WM-DRM Upgrade. All title and intellectual property rights in and to the Secure Content is the property of the respective Secure Content owners and may be protected by applicable copyright or other intellectual property laws and treaties. This Agreement grants you no rights to use such Secure Content. **To summarize, if the Software contains Microsoft WM-DRM components – Secure Content you desire to download, copy, store, display, transfer, and/or play is protected by the Microsoft WM-DRM components of the Software. Microsoft, Secure Content Owners, or Secure Content distributors may deny you access, or restrict your access, to Secure Content even after you have paid for, and/or obtained, it. Neither your consent nor the consent or approval of Philips is necessary for any of them to deny, withhold or otherwise restrict your access to Secure Content. Philips does not guaranty that you will be able to download, copy, store, display, transfer, and/or play Secure Content.**

5. Open Source Software. (a) This software may contain components that are subject to open-source terms, as stated in the documentation accompanying the Device. This Agreement does not apply to this software as such. (b) Your license rights under this Agreement do not include any right or license to use, distribute or create derivative works of the Software in any manner that would subject the Software to Open Source Terms. "Open Source Terms" means the terms of any license that directly or indirectly (1) create, or purport to create, obligations for Philips with respect to the Software and/or derivative works thereof; or (2) grant, or purport to grant, to any third party any rights or immunities under intellectual property or proprietary rights in the Software or derivative works thereof.

6. Termination. This Agreement shall be effective upon installation or first use of the Software and shall terminate (i) at the discretion of Philips, due to your failure to comply with any term of this Agreement; or (ii) upon destruction of all copies of the Software and related materials provided to you by Philips hereunder. Philips's rights and your obligations shall survive the termination of this Agreement.

7. Upgrades. Philips may, at its sole option, make upgrades to the Software available by general posting on a website or by any other means or methods. Such upgrades may be made available pursuant to the terms of this Agreement or the release of such upgrades to you may be subject to your acceptance of another agreement.

8. Support Services. Philips is not obligated to provide technical or other support ("Support Services") for the Software. If Philips does provide you with Support Services, these will be governed by separate terms to be agreed between you and Philips.

9. Limited Software Warranty. Philips provides the Software 'as is' and without any warranty except that the Software will perform substantially in accordance with the documentation accompanying the Software for a period of one year after your first download, installation or use of the Software, whichever occurs first. Philips' entire liability and your exclusive remedy for breach of this warranty shall be, at Philips' option, either (i) return of the price paid by you for the Software (if any); or (b) repair or replacement of the Software that does not

meet the warranty set forth herein and that is returned to Philips with a copy of your receipt. This limited warranty shall be void if failure of the Software has resulted from any accident, abuse, misuse or wrongful application. Any replacement Software will be warranted for the remainder of the original warranty period or thirty (30) days, whichever is longer. This limited warranty shall not apply to you if the Software was provided to you free of charge on an evaluation only basis.

10. NO OTHER WARRANTIES. EXCEPT AS SET FORTH ABOVE, PHILIPS AND ITS LICENSORS DO NOT WARRANT THAT THE SOFTWARE WILL OPERATE ERROR FREE OR UNINTERRUPTED, OR WILL MEET YOUR REQUIREMENTS. YOU ASSUME ALL RESPONSIBILITIES FOR SELECTION OF THE SOFTWARE TO ACHIEVE YOUR INTENDED RESULTS, AND FOR THE INSTALLATION OF, USE OF, AND RESULTS OBTAINED FROM THE SOFTWARE. TO THE MAXIMUM EXTENT PERMITTED BY APPLICABLE LAW, PHILIPS AND ITS LICENSORS DISCLAIM ALL WARRANTIES AND CONDITIONS, WHETHER EXPRESS OR IMPLIED, INCLUDING BUT NOT LIMITED TO THE IMPLIED WARRANTIES OF MERCHANTABILITY, FITNESS FOR A PARTICULAR PURPOSE, AND ACCURACY OR COMPLETENESS OF RESULTS WITH RESPECT TO THE SOFTWARE AND THE ACCOMPANYING MATERIALS. THERE IS NO WARRANTY AGAINST INFRINGEMENT. PHILIPS DOES NOT WARRANT THAT YOU WILL BE ABLE TO DOWNLOAD, COPY, STORE, DISPLAY, TRANSFER, AND/OR PLAY SECURE CONTENT.

11. LIMITATION OF LIABILITY. UNDER NO CIRCUMSTANCES WILL PHILIPS OR ITS LICENSORS BE LIABLE FOR ANY CONSEQUENTIAL, SPECIAL, INDIRECT, INCIDENTAL OR PUNITIVE DAMAGES WHATSOEVER, INCLUDING, WITHOUT LIMITATION, DAMAGES FOR LOSS OF PROFITS OR REVENUES, BUSINESS INTERRUPTION, LOSS OF BUSINESS INFORMATION, LOSS OF DATA, LOSS OF USE OR OTHER PECUNIARY LOSS, EVEN IF PHILIPS OR ITS LICENSORS HAVE BEEN ADVISED OF THE POSSIBILITY OF SUCH DAMAGES. IN NO EVENT SHALL PHILIPS' OR ITS LICENSORS' AGGREGATE LIABILITY FOR DAMAGES ARISING OUT OF THIS AGREEMENT EXCEED THE GREATER OF THE PRICE ACTUALLY PAID BY YOU FOR THE SOFTWARE OR FIVE TEN POUNDS STERLINGUS DOLLARS (510.00).

12. Trademarks. Certain of the product and Philips names used in this Agreement, the Software, and the printed user documentation may constitute trademarks of the Philips, its licensors or other third parties. You are not authorized to use any such trademarks.

13. Export Administration. You agree that you will not directly or indirectly, export or re-export the Software to any country for which the United States Export Administration Act, or any similar United States law or regulation requires an export license or other U.S. Government approval, unless the appropriate export license or approval has first been obtained. By downloading or installing the Software you agree to abide by this Export provision.

14. Governing law. This Agreement is governed by the laws of your country of residence, residence, without reference to its conflict of laws principles. Any dispute between you and Philips regarding this Agreement shall be subject to the non-exclusive jurisdiction of the courts of your country of residence.-

15. General. This Agreement contains the entire agreement between you and Philips and supersedes any prior representation, undertaking or other communication or advertising with respect to the Software and user documentation. If any part of this Agreement is held invalid, the remainder of this Agreement will continue in full force and effect. This Agreement shall not prejudice the statutory rights of any party dealing as a consumer.

Written Offer

Philips Electronics Hong Kong Ltd. hereby offers to deliver, upon request, a copy of the corresponding source code for the open source software packages used in this product for which such offer is requested by the respective licenses. This offer is valid up to three years after product purchase. To obtain source code, please contact open.source@philips.com. If you prefer not to use email or if you do not receive confirmation receipt within a week after mailing to this email address, please write to Open Source Team, Philips Intellectual Property & Standards, P.O. Box 220, 5600 AE Eindhoven, The Netherlands. If you do not receive timely confirmation of your letter, please email to the email address above.

This product uses the following open source software:

uClinux for Blackfin 2009R1 Release <<http://blackfin.uclinux.org/>>, licensed under GPL V2,

BusyBox R1.13.4 <<http://www.busybox.net/>>, licensed under GPL V2,

Samba r3.0.25a <<http://samba.org/samba/>>, licensed under GPL V2,

Wireless Tools for Linux v29 <http://www.hpl.hp.com/personal/Jean_Tourrilhes/Linux/Tools.html>, licensed under GPL V2,

NTFS-3G driver r2009.11.14 <<http://www.tuxera.com/community/>>, licensed under GPL V2,

Das U-Boot r1.1.6 <<http://www.denx.de/wiki/U-Boot>>, with exclusions for user programs.

NOTE! This copyright does **not** cover the so-called "standalone" applications that use U-Boot services by means of the jump table provided by U-Boot exactly for this purpose - this is merely considered normal use of U-Boot, and does **not** fall under the heading of "derived work".

The header files "include/image.h" and "include/asm-*/u-boot.h" define interfaces to U-Boot. Including these (unmodified) header files in another file is considered normal use of U-Boot, and does *not* fall under the heading of "derived work".

Also note that the GPL below is copyrighted by the Free Software Foundation, but the instance of code that it refers to (the U-Boot source code) is copyrighted by me and others who actually wrote it.
-- Wolfgang Denk

Linux kernel release 2.6.xx <<http://kernel.org/>>, licensed under GPL V2 with exclusions for user programs.

NOTE! This copyright does *not* cover user programs that use kernel services by normal system calls - this is merely considered normal use of the kernel, and does *not* fall under the heading of "derived work". Also note that the GPL below is copyrighted by the Free Software Foundation, but the instance of code that it refers to (the Linux kernel) is copyrighted by me and others who actually wrote it.

Also note that the only valid version of the GPL as far as the kernel is concerned is this particular version of the license (ie v2, not v2.2 or v3.x or whatever), unless explicitly otherwise stated.

Linus Torvalds

GPL V2

GNU GENERAL PUBLIC LICENSE
Version 2, June 1991

Copyright (C) 1989, 1991 Free Software Foundation, Inc.
51 Franklin St, Fifth Floor, Boston, MA 02110-1301 USA
Everyone is permitted to copy and distribute verbatim copies

of this license document, but changing it is not allowed.

Preamble

The licenses for most software are designed to take away your freedom to share and change it. By contrast, the GNU General Public License is intended to guarantee your freedom to share and change free software--to make sure the software is free for all its users. This General Public License applies to most of the Free Software Foundation's software and to any other program whose authors commit to using it. (Some other Free Software Foundation software is covered by the GNU Library General Public License instead.) You can apply it to your programs, too.

When we speak of free software, we are referring to freedom, not price. Our General Public Licenses are designed to make sure that you have the freedom to distribute copies of free software (and charge for this service if you wish), that you receive source code or can get it if you want it, that you can change the software or use pieces of it in new free programs; and that you know you can do these things.

To protect your rights, we need to make restrictions that forbid anyone to deny you these rights or to ask you to surrender the rights. These restrictions translate to certain responsibilities for you if you distribute copies of the software, or if you modify it.

For example, if you distribute copies of such a program, whether gratis or for a fee, you must give the recipients all the rights that you have. You must make sure that they, too, receive or can get the source code. And you must show them these terms so they know their rights.

We protect your rights with two steps: (1) copyright the software, and (2) offer you this license which gives you legal permission to copy, distribute and/or modify the software.

Also, for each author's protection and ours, we want to make certain that everyone understands that there is no warranty for this free

software. If the software is modified by someone else and passed on, we want its recipients to know that what they have is not the original, so that any problems introduced by others will not reflect on the original authors' reputations.

Finally, any free program is threatened constantly by software patents. We wish to avoid the danger that redistributors of a free program will individually obtain patent licenses, in effect making the program proprietary. To prevent this, we have made it clear that any patent must be licensed for everyone's free use or not licensed at all.

The precise terms and conditions for copying, distribution and modification follow.

GNU GENERAL PUBLIC LICENSE TERMS AND CONDITIONS FOR COPYING, DISTRIBUTION AND MODIFICATION

0. This License applies to any program or other work which contains a notice placed by the copyright holder saying it may be distributed under the terms of this General Public License. The "Program", below, refers to any such program or work, and a "work based on the Program" means either the Program or any derivative work under copyright law: that is to say, a work containing the Program or a portion of it, either verbatim or with modifications and/or translated into another language. (Hereinafter, translation is included without limitation in the term "modification".) Each licensee is addressed as "you".

Activities other than copying, distribution and modification are not covered by this License; they are outside its scope. The act of running the Program is not restricted, and the output from the Program is covered only if its contents constitute a work based on the Program (independent of having been made by running the Program). Whether that is true depends on what the Program does.

1. You may copy and distribute verbatim copies of the Program's source code as you receive it, in any medium, provided that you conspicuously and appropriately publish on each copy an appropriate

copyright notice and disclaimer of warranty; keep intact all the notices that refer to this License and to the absence of any warranty; and give any other recipients of the Program a copy of this License along with the Program.

You may charge a fee for the physical act of transferring a copy, and you may at your option offer warranty protection in exchange for a fee.

2. You may modify your copy or copies of the Program or any portion of it, thus forming a work based on the Program, and copy and distribute such modifications or work under the terms of Section 1 above, provided that you also meet all of these conditions:

a) You must cause the modified files to carry prominent notices stating that you changed the files and the date of any change.

b) You must cause any work that you distribute or publish, that in whole or in part contains or is derived from the Program or any part thereof, to be licensed as a whole at no charge to all third parties under the terms of this License.

c) If the modified program normally reads commands interactively when run, you must cause it, when started running for such interactive use in the most ordinary way, to print or display an announcement including an appropriate copyright notice and a notice that there is no warranty (or else, saying that you provide a warranty) and that users may redistribute the program under these conditions, and telling the user how to view a copy of this License. (Exception: if the Program itself is interactive but does not normally print such an announcement, your work based on the Program is not required to print an announcement.)

These requirements apply to the modified work as a whole. If identifiable sections of that work are not derived from the Program, and can be reasonably considered independent and separate works in themselves, then this License, and its terms, do not apply to those sections when you distribute them as separate works. But when you distribute the same sections as part of a whole which is a work based

on the Program, the distribution of the whole must be on the terms of this License, whose permissions for other licensees extend to the entire whole, and thus to each and every part regardless of who wrote it.

Thus, it is not the intent of this section to claim rights or contest your rights to work written entirely by you; rather, the intent is to exercise the right to control the distribution of derivative or collective works based on the Program.

In addition, mere aggregation of another work not based on the Program with the Program (or with a work based on the Program) on a volume of a storage or distribution medium does not bring the other work under the scope of this License.

3. You may copy and distribute the Program (or a work based on it, under Section 2) in object code or executable form under the terms of Sections 1 and 2 above provided that you also do one of the following:

- a) Accompany it with the complete corresponding machine-readable source code, which must be distributed under the terms of Sections 1 and 2 above on a medium customarily used for software interchange; or,
- b) Accompany it with a written offer, valid for at least three years, to give any third party, for a charge no more than your cost of physically performing source distribution, a complete machine-readable copy of the corresponding source code, to be distributed under the terms of Sections 1 and 2 above on a medium customarily used for software interchange; or,
- c) Accompany it with the information you received as to the offer to distribute corresponding source code. (This alternative is allowed only for noncommercial distribution and only if you received the program in object code or executable form with such an offer; in accord with Subsection b above.)

The source code for a work means the preferred form of the work for making modifications to it. For an executable work, complete source code means all the source code for all modules it contains, plus any

associated interface definition files, plus the scripts used to control compilation and installation of the executable. However, as a special exception, the source code distributed need not include anything that is normally distributed (in either source or binary form) with the major components (compiler, kernel, and so on) of the operating system on which the executable runs, unless that component itself accompanies the executable.

If distribution of executable or object code is made by offering access to copy from a designated place, then offering equivalent access to copy the source code from the same place counts as distribution of the source code, even though third parties are not compelled to copy the source along with the object code.

4. You may not copy, modify, sublicense, or distribute the Program except as expressly provided under this License. Any attempt otherwise to copy, modify, sublicense or distribute the Program is void, and will automatically terminate your rights under this License. However, parties who have received copies, or rights, from you under this License will not have their licenses terminated so long as such parties remain in full compliance.

5. You are not required to accept this License, since you have not signed it. However, nothing else grants you permission to modify or distribute the Program or its derivative works. These actions are prohibited by law if you do not accept this License. Therefore, by modifying or distributing the Program (or any work based on the Program), you indicate your acceptance of this License to do so, and all its terms and conditions for copying, distributing or modifying the Program or works based on it.

6. Each time you redistribute the Program (or any work based on the Program), the recipient automatically receives a license from the original licensor to copy, distribute or modify the Program subject to these terms and conditions. You may not impose any further restrictions on the recipients' exercise of the rights granted herein. You are not responsible for enforcing compliance by third parties to this License.

7. If, as a consequence of a court judgment or allegation of patent infringement or for any other reason (not limited to patent issues), conditions are imposed on you (whether by court order, agreement or otherwise) that contradict the conditions of this License, they do not excuse you from the conditions of this License. If you cannot distribute so as to satisfy simultaneously your obligations under this License and any other pertinent obligations, then as a consequence you may not distribute the Program at all. For example, if a patent license would not permit royalty-free redistribution of the Program by all those who receive copies directly or indirectly through you, then the only way you could satisfy both it and this License would be to refrain entirely from distribution of the Program.

If any portion of this section is held invalid or unenforceable under any particular circumstance, the balance of the section is intended to apply and the section as a whole is intended to apply in other circumstances.

It is not the purpose of this section to induce you to infringe any patents or other property right claims or to contest validity of any such claims; this section has the sole purpose of protecting the integrity of the free software distribution system, which is implemented by public license practices. Many people have made generous contributions to the wide range of software distributed through that system in reliance on consistent application of that system; it is up to the author/donor to decide if he or she is willing to distribute software through any other system and a licensee cannot impose that choice.

This section is intended to make thoroughly clear what is believed to be a consequence of the rest of this License.

8. If the distribution and/or use of the Program is restricted in certain countries either by patents or by copyrighted interfaces, the original copyright holder who places the Program under this License may add an explicit geographical distribution limitation excluding those countries, so that distribution is permitted only in or among

countries not thus excluded. In such case, this License incorporates the limitation as if written in the body of this License.

9. The Free Software Foundation may publish revised and/or new versions of the General Public License from time to time. Such new versions will be similar in spirit to the present version, but may differ in detail to address new problems or concerns.

Each version is given a distinguishing version number. If the Program specifies a version number of this License which applies to it and "any later version", you have the option of following the terms and conditions either of that version or of any later version published by the Free Software Foundation. If the Program does not specify a version number of this License, you may choose any version ever published by the Free Software Foundation.

10. If you wish to incorporate parts of the Program into other free programs whose distribution conditions are different, write to the author to ask for permission. For software which is copyrighted by the Free Software Foundation, write to the Free Software Foundation; we sometimes make exceptions for this. Our decision will be guided by the two goals of preserving the free status of all derivatives of our free software and of promoting the sharing and reuse of software generally.

NO WARRANTY

11. BECAUSE THE PROGRAM IS LICENSED FREE OF CHARGE, THERE IS NO WARRANTY FOR THE PROGRAM, TO THE EXTENT PERMITTED BY APPLICABLE LAW. EXCEPT WHEN OTHERWISE STATED IN WRITING THE COPYRIGHT HOLDERS AND/OR OTHER PARTIES PROVIDE THE PROGRAM "AS IS" WITHOUT WARRANTY OF ANY KIND, EITHER EXPRESSED OR IMPLIED, INCLUDING, BUT NOT LIMITED TO, THE IMPLIED WARRANTIES OF MERCHANTABILITY AND FITNESS FOR A PARTICULAR PURPOSE. THE ENTIRE RISK AS TO THE QUALITY AND PERFORMANCE OF THE PROGRAM IS WITH YOU. SHOULD THE PROGRAM PROVE DEFECTIVE, YOU ASSUME THE COST OF ALL NECESSARY SERVICING, REPAIR OR CORRECTION.

12. IN NO EVENT UNLESS REQUIRED BY APPLICABLE LAW OR AGREED TO IN WRITING WILL ANY COPYRIGHT HOLDER, OR ANY OTHER PARTY WHO MAY MODIFY AND/OR REDISTRIBUTE THE PROGRAM AS PERMITTED ABOVE, BE LIABLE TO YOU FOR DAMAGES, INCLUDING ANY GENERAL, SPECIAL, INCIDENTAL OR CONSEQUENTIAL DAMAGES ARISING OUT OF THE USE OR INABILITY TO USE THE PROGRAM (INCLUDING BUT NOT LIMITED TO LOSS OF DATA OR DATA BEING RENDERED INACCURATE OR LOSSES SUSTAINED BY YOU OR THIRD PARTIES OR A FAILURE OF THE PROGRAM TO OPERATE WITH ANY OTHER PROGRAMS), EVEN IF SUCH HOLDER OR OTHER PARTY HAS BEEN ADVISED OF THE POSSIBILITY OF SUCH DAMAGES.

END OF TERMS AND CONDITIONS

How to Apply These Terms to Your New Programs

If you develop a new program, and you want it to be of the greatest possible use to the public, the best way to achieve this is to make it free software which everyone can redistribute and change under these terms.

To do so, attach the following notices to the program. It is safest to attach them to the start of each source file to most effectively convey the exclusion of warranty; and each file should have at least the "copyright" line and a pointer to where the full notice is found.

```
<one line to give the program's name and a brief idea of what it does.>  
Copyright (C) <year> <name of author>
```

```
This program is free software; you can redistribute it and/or modify  
it under the terms of the GNU General Public License as published by  
the Free Software Foundation; either version 2 of the License, or  
(at your option) any later version.
```

```
This program is distributed in the hope that it will be useful,  
but WITHOUT ANY WARRANTY; without even the implied warranty of  
MERCHANTABILITY or FITNESS FOR A PARTICULAR PURPOSE. See the  
GNU General Public License for more details.
```

You should have received a copy of the GNU General Public License along with this program; if not, write to the Free Software Foundation, Inc., 51 Franklin St, Fifth Floor, Boston, MA 02110-1301 USA

Also add information on how to contact you by electronic and paper mail.

If the program is interactive, make it output a short notice like this when it starts in an interactive mode:

```
Gnomovision version 69, Copyright (C) year name of author
Gnomovision comes with ABSOLUTELY NO WARRANTY; for details type
`show w'.
```

```
This is free software, and you are welcome to redistribute it
under certain conditions; type `show c' for details.
```

The hypothetical commands ``show w'` and ``show c'` should show the appropriate parts of the General Public License. Of course, the commands you use may be called something other than ``show w'` and ``show c'`; they could even be mouse-clicks or menu items--whatever suits your program.

You should also get your employer (if you work as a programmer) or your school, if any, to sign a "copyright disclaimer" for the program, if necessary. Here is a sample; alter the names:

```
Yoyodyne, Inc., hereby disclaims all copyright interest in the program
`Gnomovision' (which makes passes at compilers) written by James Hacker.
```

```
<signature of Ty Coon>, 1 April 1989
Ty Coon, President of Vice
```

This General Public License does not permit incorporating your program into proprietary programs. If your program is a subroutine library, you may consider it more useful to permit linking proprietary applications with the library. If this is what you want to do, use the GNU Library General Public License instead of this License.

uClibc r0.9 <<http://www.uclibc.org/>>, , licensed under LGPL V2,

LGPL V2

GNU LIBRARY GENERAL PUBLIC LICENSE
Version 2, June 1991

Copyright (C) 1991 Free Software Foundation, Inc.
675 Mass Ave, Cambridge, MA 02139, USA

Everyone is permitted to copy and distribute verbatim copies
of this license document, but changing it is not allowed.

[This is the first released version of the library GPL. It is
numbered 2 because it goes with version 2 of the ordinary GPL.]

Preamble

The licenses for most software are designed to take away your
freedom to share and change it. By contrast, the GNU General Public
Licenses are intended to guarantee your freedom to share and change
free software--to make sure the software is free for all its users.

This license, the Library General Public License, applies to some
specially designated Free Software Foundation software, and to any
other libraries whose authors decide to use it. You can use it for
your libraries, too.

When we speak of free software, we are referring to freedom, not
price. Our General Public Licenses are designed to make sure that you
have the freedom to distribute copies of free software (and charge for
this service if you wish), that you receive source code or can get it
if you want it, that you can change the software or use pieces of it
in new free programs; and that you know you can do these things.

To protect your rights, we need to make restrictions that forbid

anyone to deny you these rights or to ask you to surrender the rights. These restrictions translate to certain responsibilities for you if you distribute copies of the library, or if you modify it.

For example, if you distribute copies of the library, whether gratis or for a fee, you must give the recipients all the rights that we gave you. You must make sure that they, too, receive or can get the source code. If you link a program with the library, you must provide complete object files to the recipients so that they can relink them with the library, after making changes to the library and recompiling it. And you must show them these terms so they know their rights.

Our method of protecting your rights has two steps: (1) copyright the library, and (2) offer you this license which gives you legal permission to copy, distribute and/or modify the library.

Also, for each distributor's protection, we want to make certain that everyone understands that there is no warranty for this free library. If the library is modified by someone else and passed on, we want its recipients to know that what they have is not the original version, so that any problems introduced by others will not reflect on the original authors' reputations.

Finally, any free program is threatened constantly by software patents. We wish to avoid the danger that companies distributing free software will individually obtain patent licenses, thus in effect transforming the program into proprietary software. To prevent this, we have made it clear that any patent must be licensed for everyone's free use or not licensed at all.

Most GNU software, including some libraries, is covered by the ordinary GNU General Public License, which was designed for utility programs. This license, the GNU Library General Public License, applies to certain designated libraries. This license is quite different from the ordinary one; be sure to read it in full, and don't assume that anything in it is the same as in the ordinary license.

The reason we have a separate public license for some libraries is that

they blur the distinction we usually make between modifying or adding to a program and simply using it. Linking a program with a library, without changing the library, is in some sense simply using the library, and is analogous to running a utility program or application program. However, in a textual and legal sense, the linked executable is a combined work, a derivative of the original library, and the ordinary General Public License treats it as such.

Because of this blurred distinction, using the ordinary General Public License for libraries did not effectively promote software sharing, because most developers did not use the libraries. We concluded that weaker conditions might promote sharing better.

However, unrestricted linking of non-free programs would deprive the users of those programs of all benefit from the free status of the libraries themselves. This Library General Public License is intended to permit developers of non-free programs to use free libraries, while preserving your freedom as a user of such programs to change the free libraries that are incorporated in them. (We have not seen how to achieve this as regards changes in header files, but we have achieved it as regards changes in the actual functions of the Library.) The hope is that this will lead to faster development of free libraries.

The precise terms and conditions for copying, distribution and modification follow. Pay close attention to the difference between a "work based on the library" and a "work that uses the library". The former contains code derived from the library, while the latter only works together with the library.

Note that it is possible for a library to be covered by the ordinary General Public License rather than by this special one.

GNU LIBRARY GENERAL PUBLIC LICENSE TERMS AND CONDITIONS FOR COPYING, DISTRIBUTION AND MODIFICATION

0. This License Agreement applies to any software library which contains a notice placed by the copyright holder or other authorized

party saying it may be distributed under the terms of this Library General Public License (also called "this License"). Each licensee is addressed as "you".

A "library" means a collection of software functions and/or data prepared so as to be conveniently linked with application programs (which use some of those functions and data) to form executables.

The "Library", below, refers to any such software library or work which has been distributed under these terms. A "work based on the Library" means either the Library or any derivative work under copyright law: that is to say, a work containing the Library or a portion of it, either verbatim or with modifications and/or translated straightforwardly into another language. (Hereinafter, translation is included without limitation in the term "modification".)

"Source code" for a work means the preferred form of the work for making modifications to it. For a library, complete source code means all the source code for all modules it contains, plus any associated interface definition files, plus the scripts used to control compilation and installation of the library.

Activities other than copying, distribution and modification are not covered by this License; they are outside its scope. The act of running a program using the Library is not restricted, and output from such a program is covered only if its contents constitute a work based on the Library (independent of the use of the Library in a tool for writing it). Whether that is true depends on what the Library does and what the program that uses the Library does.

1. You may copy and distribute verbatim copies of the Library's complete source code as you receive it, in any medium, provided that you conspicuously and appropriately publish on each copy an appropriate copyright notice and disclaimer of warranty; keep intact all the notices that refer to this License and to the absence of any warranty; and distribute a copy of this License along with the Library.

You may charge a fee for the physical act of transferring a copy, and you may at your option offer warranty protection in exchange for a fee.

2. You may modify your copy or copies of the Library or any portion of it, thus forming a work based on the Library, and copy and distribute such modifications or work under the terms of Section 1 above, provided that you also meet all of these conditions:

- a) The modified work must itself be a software library.
- b) You must cause the files modified to carry prominent notices stating that you changed the files and the date of any change.
- c) You must cause the whole of the work to be licensed at no charge to all third parties under the terms of this License.
- d) If a facility in the modified Library refers to a function or a table of data to be supplied by an application program that uses the facility, other than as an argument passed when the facility is invoked, then you must make a good faith effort to ensure that, in the event an application does not supply such function or table, the facility still operates, and performs whatever part of its purpose remains meaningful.

(For example, a function in a library to compute square roots has a purpose that is entirely well-defined independent of the application. Therefore, Subsection 2d requires that any application-supplied function or table used by this function must be optional: if the application does not supply it, the square root function must still compute square roots.)

These requirements apply to the modified work as a whole. If identifiable sections of that work are not derived from the Library, and can be reasonably considered independent and separate works in themselves, then this License, and its terms, do not apply to those sections when you distribute them as separate works. But when you distribute the same sections as part of a whole which is a work based

on the Library, the distribution of the whole must be on the terms of this License, whose permissions for other licensees extend to the entire whole, and thus to each and every part regardless of who wrote it.

Thus, it is not the intent of this section to claim rights or contest your rights to work written entirely by you; rather, the intent is to exercise the right to control the distribution of derivative or collective works based on the Library.

In addition, mere aggregation of another work not based on the Library with the Library (or with a work based on the Library) on a volume of a storage or distribution medium does not bring the other work under the scope of this License.

3. You may opt to apply the terms of the ordinary GNU General Public License instead of this License to a given copy of the Library. To do this, you must alter all the notices that refer to this License, so that they refer to the ordinary GNU General Public License, version 2, instead of to this License. (If a newer version than version 2 of the ordinary GNU General Public License has appeared, then you can specify that version instead if you wish.) Do not make any other change in these notices.

Once this change is made in a given copy, it is irreversible for that copy, so the ordinary GNU General Public License applies to all subsequent copies and derivative works made from that copy.

This option is useful when you wish to copy part of the code of the Library into a program that is not a library.

4. You may copy and distribute the Library (or a portion or derivative of it, under Section 2) in object code or executable form under the terms of Sections 1 and 2 above provided that you accompany it with the complete corresponding machine-readable source code, which must be distributed under the terms of Sections 1 and 2 above on a medium customarily used for software interchange.

If distribution of object code is made by offering access to copy from a designated place, then offering equivalent access to copy the source code from the same place satisfies the requirement to distribute the source code, even though third parties are not compelled to copy the source along with the object code.

5. A program that contains no derivative of any portion of the Library, but is designed to work with the Library by being compiled or linked with it, is called a "work that uses the Library". Such a work, in isolation, is not a derivative work of the Library, and therefore falls outside the scope of this License.

However, linking a "work that uses the Library" with the Library creates an executable that is a derivative of the Library (because it contains portions of the Library), rather than a "work that uses the library". The executable is therefore covered by this License. Section 6 states terms for distribution of such executables.

When a "work that uses the Library" uses material from a header file that is part of the Library, the object code for the work may be a derivative work of the Library even though the source code is not. Whether this is true is especially significant if the work can be linked without the Library, or if the work is itself a library. The threshold for this to be true is not precisely defined by law.

If such an object file uses only numerical parameters, data structure layouts and accessors, and small macros and small inline functions (ten lines or less in length), then the use of the object file is unrestricted, regardless of whether it is legally a derivative work. (Executables containing this object code plus portions of the Library will still fall under Section 6.)

Otherwise, if the work is a derivative of the Library, you may distribute the object code for the work under the terms of Section 6. Any executables containing that work also fall under Section 6, whether or not they are linked directly with the Library itself.

6. As an exception to the Sections above, you may also compile or link a "work that uses the Library" with the Library to produce a work containing portions of the Library, and distribute that work under terms of your choice, provided that the terms permit modification of the work for the customer's own use and reverse engineering for debugging such modifications.

You must give prominent notice with each copy of the work that the Library is used in it and that the Library and its use are covered by this License. You must supply a copy of this License. If the work during execution displays copyright notices, you must include the copyright notice for the Library among them, as well as a reference directing the user to the copy of this License. Also, you must do one of these things:

a) Accompany the work with the complete corresponding machine-readable source code for the Library including whatever changes were used in the work (which must be distributed under Sections 1 and 2 above); and, if the work is an executable linked with the Library, with the complete machine-readable "work that uses the Library", as object code and/or source code, so that the user can modify the Library and then relink to produce a modified executable containing the modified Library. (It is understood that the user who changes the contents of definitions files in the Library will not necessarily be able to recompile the application to use the modified definitions.)

b) Accompany the work with a written offer, valid for at least three years, to give the same user the materials specified in Subsection 6a, above, for a charge no more than the cost of performing this distribution.

c) If distribution of the work is made by offering access to copy from a designated place, offer equivalent access to copy the above specified materials from the same place.

d) Verify that the user has already received a copy of these materials or that you have already sent this user a copy.

For an executable, the required form of the "work that uses the Library" must include any data and utility programs needed for reproducing the executable from it. However, as a special exception, the source code distributed need not include anything that is normally distributed (in either source or binary form) with the major components (compiler, kernel, and so on) of the operating system on which the executable runs, unless that component itself accompanies the executable.

It may happen that this requirement contradicts the license restrictions of other proprietary libraries that do not normally accompany the operating system. Such a contradiction means you cannot use both them and the Library together in an executable that you distribute.

7. You may place library facilities that are a work based on the Library side-by-side in a single library together with other library facilities not covered by this License, and distribute such a combined library, provided that the separate distribution of the work based on the Library and of the other library facilities is otherwise permitted, and provided that you do these two things:

- a) Accompany the combined library with a copy of the same work based on the Library, uncombined with any other library facilities. This must be distributed under the terms of the Sections above.
- b) Give prominent notice with the combined library of the fact that part of it is a work based on the Library, and explaining where to find the accompanying uncombined form of the same work.

8. You may not copy, modify, sublicense, link with, or distribute the Library except as expressly provided under this License. Any attempt otherwise to copy, modify, sublicense, link with, or distribute the Library is void, and will automatically terminate your rights under this License. However, parties who have received copies, or rights, from you under this License will not have their licenses

terminated so long as such parties remain in full compliance.

9. You are not required to accept this License, since you have not signed it. However, nothing else grants you permission to modify or distribute the Library or its derivative works. These actions are prohibited by law if you do not accept this License. Therefore, by modifying or distributing the Library (or any work based on the Library), you indicate your acceptance of this License to do so, and all its terms and conditions for copying, distributing or modifying the Library or works based on it.

10. Each time you redistribute the Library (or any work based on the Library), the recipient automatically receives a license from the original licensor to copy, distribute, link with or modify the Library subject to these terms and conditions. You may not impose any further restrictions on the recipients' exercise of the rights granted herein. You are not responsible for enforcing compliance by third parties to this License.

11. If, as a consequence of a court judgment or allegation of patent infringement or for any other reason (not limited to patent issues), conditions are imposed on you (whether by court order, agreement or otherwise) that contradict the conditions of this License, they do not excuse you from the conditions of this License. If you cannot distribute so as to satisfy simultaneously your obligations under this License and any other pertinent obligations, then as a consequence you may not distribute the Library at all. For example, if a patent license would not permit royalty-free redistribution of the Library by all those who receive copies directly or indirectly through you, then the only way you could satisfy both it and this License would be to refrain entirely from distribution of the Library.

If any portion of this section is held invalid or unenforceable under any particular circumstance, the balance of the section is intended to apply, and the section as a whole is intended to apply in other circumstances.

It is not the purpose of this section to induce you to infringe any patents or other property right claims or to contest validity of any

such claims; this section has the sole purpose of protecting the integrity of the free software distribution system which is implemented by public license practices. Many people have made generous contributions to the wide range of software distributed through that system in reliance on consistent application of that system; it is up to the author/donor to decide if he or she is willing to distribute software through any other system and a licensee cannot impose that choice.

This section is intended to make thoroughly clear what is believed to be a consequence of the rest of this License.

12. If the distribution and/or use of the Library is restricted in certain countries either by patents or by copyrighted interfaces, the original copyright holder who places the Library under this License may add an explicit geographical distribution limitation excluding those countries, so that distribution is permitted only in or among countries not thus excluded. In such case, this License incorporates the limitation as if written in the body of this License.

13. The Free Software Foundation may publish revised and/or new versions of the Library General Public License from time to time. Such new versions will be similar in spirit to the present version, but may differ in detail to address new problems or concerns.

Each version is given a distinguishing version number. If the Library specifies a version number of this License which applies to it and "any later version", you have the option of following the terms and conditions either of that version or of any later version published by the Free Software Foundation. If the Library does not specify a license version number, you may choose any version ever published by the Free Software Foundation.

14. If you wish to incorporate parts of the Library into other free programs whose distribution conditions are incompatible with these, write to the author to ask for permission. For software which is copyrighted by the Free Software Foundation, write to the Free Software Foundation; we sometimes make exceptions for this. Our

decision will be guided by the two goals of preserving the free status of all derivatives of our free software and of promoting the sharing and reuse of software generally.

NO WARRANTY

15. BECAUSE THE LIBRARY IS LICENSED FREE OF CHARGE, THERE IS NO WARRANTY FOR THE LIBRARY, TO THE EXTENT PERMITTED BY APPLICABLE LAW. EXCEPT WHEN OTHERWISE STATED IN WRITING THE COPYRIGHT HOLDERS AND/OR OTHER PARTIES PROVIDE THE LIBRARY "AS IS" WITHOUT WARRANTY OF ANY KIND, EITHER EXPRESSED OR IMPLIED, INCLUDING, BUT NOT LIMITED TO, THE IMPLIED WARRANTIES OF MERCHANTABILITY AND FITNESS FOR A PARTICULAR PURPOSE. THE ENTIRE RISK AS TO THE QUALITY AND PERFORMANCE OF THE LIBRARY IS WITH YOU. SHOULD THE LIBRARY PROVE DEFECTIVE, YOU ASSUME THE COST OF ALL NECESSARY SERVICING, REPAIR OR CORRECTION.

16. IN NO EVENT UNLESS REQUIRED BY APPLICABLE LAW OR AGREED TO IN WRITING WILL ANY COPYRIGHT HOLDER, OR ANY OTHER PARTY WHO MAY MODIFY AND/OR REDISTRIBUTE THE LIBRARY AS PERMITTED ABOVE, BE LIABLE TO YOU FOR DAMAGES, INCLUDING ANY GENERAL, SPECIAL, INCIDENTAL OR CONSEQUENTIAL DAMAGES ARISING OUT OF THE USE OR INABILITY TO USE THE LIBRARY (INCLUDING BUT NOT LIMITED TO LOSS OF DATA OR DATA BEING RENDERED INACCURATE OR LOSSES SUSTAINED BY YOU OR THIRD PARTIES OR A FAILURE OF THE LIBRARY TO OPERATE WITH ANY OTHER SOFTWARE), EVEN IF SUCH HOLDER OR OTHER PARTY HAS BEEN ADVISED OF THE POSSIBILITY OF SUCH DAMAGES.

END OF TERMS AND CONDITIONS

Appendix: How to Apply These Terms to Your New Libraries

If you develop a new library, and you want it to be of the greatest possible use to the public, we recommend making it free software that everyone can redistribute and change. You can do so by permitting redistribution under these terms (or, alternatively, under the terms of the

ordinary General Public License).

To apply these terms, attach the following notices to the library. It is safest to attach them to the start of each source file to most effectively convey the exclusion of warranty; and each file should have at least the "copyright" line and a pointer to where the full notice is found.

```
<one line to give the library's name and a brief idea of what it does.>  
Copyright (C) <year> <name of author>
```

This library is free software; you can redistribute it and/or modify it under the terms of the GNU Library General Public License as published by the Free Software Foundation; either version 2 of the License, or (at your option) any later version.

This library is distributed in the hope that it will be useful, but WITHOUT ANY WARRANTY; without even the implied warranty of MERCHANTABILITY or FITNESS FOR A PARTICULAR PURPOSE. See the GNU Library General Public License for more details.

You should have received a copy of the GNU Library General Public License along with this library; if not, write to the Free Software Foundation, Inc., 675 Mass Ave, Cambridge, MA 02139, USA.

Also add information on how to contact you by electronic and paper mail.

You should also get your employer (if you work as a programmer) or your school, if any, to sign a "copyright disclaimer" for the library, if necessary. Here is a sample; alter the names:

Yoyodyne, Inc., hereby disclaims all copyright interest in the library `Frob' (a library for tweaking knobs) written by James Random Hacker.

```
<signature of Ty Coon>, 1 April 1990  
Ty Coon, President of Vice
```

That's all there is to it!

Curl and libcurl 7.19.7 <<http://curl.haxx.se/>>, licensed under a MIT/X derivate license,

COPYRIGHT AND PERMISSION NOTICE

Copyright (c) 1996 - 2009, Daniel Stenberg, <daniel@haxx.se>.

All rights reserved.

Permission to use, copy, modify, and distribute this software for any purpose with or without fee is hereby granted, provided that the above copyright notice and this permission notice appear in all copies.

THE SOFTWARE IS PROVIDED "AS IS", WITHOUT WARRANTY OF ANY KIND, EXPRESS OR IMPLIED, INCLUDING BUT NOT LIMITED TO THE WARRANTIES OF MERCHANTABILITY, FITNESS FOR A PARTICULAR PURPOSE AND NONINFRINGEMENT OF THIRD PARTY RIGHTS. IN NO EVENT SHALL THE AUTHORS OR COPYRIGHT HOLDERS BE LIABLE FOR ANY CLAIM, DAMAGES OR OTHER LIABILITY, WHETHER IN AN ACTION OF CONTRACT, TORT OR OTHERWISE, ARISING FROM, OUT OF OR IN CONNECTION WITH THE SOFTWARE OR THE USE OR OTHER DEALINGS IN THE SOFTWARE.

Except as contained in this notice, the name of a copyright holder shall not be used in advertising or otherwise to promote the sale, use or other dealings in this Software without prior written authorization of the copyright holder.

OpenSSL 1.0.0 <<http://www.openssl.org/>>, licensed under both OpenSSL License and Original SSLeay license,

OpenSSL License

/*

* Copyright (c) 1998-2008 The OpenSSL Project. All rights reserved.

/*

* Redistribution and use in source and binary forms, with or without
* modification, are permitted provided that the following conditions
* are met:

/*

* 1. Redistributions of source code must retain the above copyright
* notice, this list of conditions and the following disclaimer:

/*

* 2. Redistributions in binary form must reproduce the above copyright
* notice, this list of conditions and the following disclaimer in
* the documentation and/or other materials provided with the
* distribution.

/*

* 3. All advertising materials mentioning features or use of this
* software must display the following acknowledgment:

* "This product includes software developed by the OpenSSL Project
* for use in the OpenSSL Toolkit. (<http://www.openssl.org/>)"

/*

* 4. The names "OpenSSL Toolkit" and "OpenSSL Project" must not be used to
* endorse or promote products derived from this software without
* prior written permission. For written permission, please contact
* openssl-core@openssl.org.

/*

* 5. Products derived from this software may not be called "OpenSSL"
* nor may "OpenSSL" appear in their names without prior written
* permission of the OpenSSL Project.

/*

* 6. Redistributions of any form whatsoever must retain the following
* acknowledgment:

* "This product includes software developed by the OpenSSL Project
* for use in the OpenSSL Toolkit (<http://www.openssl.org/>)"

/*

* THIS SOFTWARE IS PROVIDED BY THE OpenSSL PROJECT ``AS IS'' AND
ANY EXPRESSED OR IMPLIED WARRANTIES, INCLUDING, BUT NOT
LIMITED TO, THE IMPLIED WARRANTIES OF MERCHANTABILITY AND
FITNESS FOR A PARTICULAR PURPOSE ARE DISCLAIMED. IN NO EVENT

SHALL THE OpenSSL PROJECT OR ITS CONTRIBUTORS BE LIABLE FOR ANY DIRECT, INDIRECT, INCIDENTAL, SPECIAL, EXEMPLARY, OR CONSEQUENTIAL DAMAGES (INCLUDING, BUT NOT LIMITED TO, PROCUREMENT OF SUBSTITUTE GOODS OR SERVICES; LOSS OF USE, DATA, OR PROFITS; OR BUSINESS INTERRUPTION) HOWEVER CAUSED AND ON ANY THEORY OF LIABILITY, WHETHER IN CONTRACT, STRICT LIABILITY, OR TORT (INCLUDING NEGLIGENCE OR OTHERWISE) ARISING IN ANY WAY OUT OF THE USE OF THIS SOFTWARE, EVEN IF ADVISED OF THE POSSIBILITY OF SUCH DAMAGE.

*

*

* This product includes cryptographic software written by Eric Young
* (eay@cryptsoft.com). This product includes software written by Tim
* Hudson (tjh@cryptsoft.com).

*

*/

Original SSLeay License

/* Copyright (C) 1995-1998 Eric Young (eay@cryptsoft.com)

* All rights reserved.

*

* This package is an SSL implementation written
* by Eric Young (eay@cryptsoft.com).

* The implementation was written so as to conform with Netscapes SSL.

*

* This library is free for commercial and non-commercial use as long as
* the following conditions are adhered to. The following conditions
* apply to all code found in this distribution, be it the RC4, RSA,
* lhash, DES, etc., code; not just the SSL code. The SSL documentation
* included with this distribution is covered by the same copyright terms
* except that the holder is Tim Hudson (tjh@cryptsoft.com).

*

* Copyright remains Eric Young's, and as such any Copyright notices in
* the code are not to be removed.

* If this package is used in a product, Eric Young should be given attribution
* as the author of the parts of the library used.

- * This can be in the form of a textual message at program startup or
- * in documentation (online or textual) provided with the package.
- *
- * Redistribution and use in source and binary forms, with or without
- * modification, are permitted provided that the following conditions
- * are met:
- * 1. Redistributions of source code must retain the copyright
- * notice, this list of conditions and the following disclaimer:
- * 2. Redistributions in binary form must reproduce the above copyright
- * notice, this list of conditions and the following disclaimer in the
- * documentation and/or other materials provided with the distribution.
- * 3. All advertising materials mentioning features or use of this software
- * must display the following acknowledgement:
- * "This product includes cryptographic software written by
- * Eric Young (eay@cryptsoft.com)"
- * The word 'cryptographic' can be left out if the routines from the library
- * being used are not cryptographic related :-).
- * 4. If you include any Windows specific code (or a derivative thereof) from
- * the apps directory (application code) you must include an
- acknowledgement:
- * "This product includes software written by Tim Hudson (tjh@cryptsoft.
- com)"
- *
- * THIS SOFTWARE IS PROVIDED BY ERIC YOUNG ``AS IS'' AND
- * ANY EXPRESS OR IMPLIED WARRANTIES, INCLUDING, BUT NOT
- LIMITED TO, THE IMPLIED WARRANTIES OF MERCHANTABILITY AND
- FITNESS FOR A PARTICULAR PURPOSE ARE DISCLAIMED. IN NO EVENT
- SHALL THE AUTHOR OR CONTRIBUTORS BE LIABLE FOR ANY DIRECT,
- INDIRECT, INCIDENTAL, SPECIAL, EXEMPLARY, OR CONSEQUENTIAL
- DAMAGES (INCLUDING, BUT NOT LIMITED TO, PROCUREMENT OF
- SUBSTITUTE GOODS OR SERVICES; LOSS OF USE, DATA, OR PROFITS;
- OR BUSINESS INTERRUPTION) HOWEVER CAUSED AND ON ANY
- THEORY OF LIABILITY, WHETHER IN CONTRACT, STRICT LIABILITY, OR
- TORT (INCLUDING NEGLIGENCE OR OTHERWISE) ARISING IN ANY
- WAY OUT OF THE USE OF THIS SOFTWARE, EVEN IF ADVISED OF THE
- POSSIBILITY OF SUCH DAMAGE.
- *
- * The licence and distribution terms for any publicly available version or

- * derivative of this code cannot be changed. i.e. this code cannot simply be
- * copied and put under another distribution licence
- * [including the GNU Public Licence.]
- */

Ogg Vorbis <<http://xiph.org/vorbis/>>, licensed as below,

Copyright (c) 2002, Xiph.org Foundation

Redistribution and use in source and binary forms, with or without modification, are permitted provided that the following conditions are met:

- Redistributions of source code must retain the above copyright notice, this list of conditions and the following disclaimer:
- Redistributions in binary form must reproduce the above copyright notice, this list of conditions and the following disclaimer in the documentation and/or other materials provided with the distribution.
- Neither the name of the Xiph.org Foundation nor the names of its contributors may be used to endorse or promote products derived from this software without specific prior written permission.

THIS SOFTWARE IS PROVIDED BY THE COPYRIGHT HOLDERS AND CONTRIBUTORS ``AS IS" AND ANY EXPRESS OR IMPLIED WARRANTIES, INCLUDING, BUT NOT LIMITED TO, THE IMPLIED WARRANTIES OF MERCHANTABILITY AND FITNESS FOR A PARTICULAR PURPOSE ARE DISCLAIMED. IN NO EVENT SHALL THE FOUNDATION OR CONTRIBUTORS BE LIABLE FOR ANY DIRECT, INDIRECT, INCIDENTAL, SPECIAL, EXEMPLARY, OR CONSEQUENTIAL DAMAGES (INCLUDING, BUT NOT LIMITED TO, PROCUREMENT OF SUBSTITUTE GOODS OR SERVICES; LOSS OF USE, DATA, OR PROFITS; OR BUSINESS INTERRUPTION) HOWEVER CAUSED AND ON ANY THEORY OF LIABILITY, WHETHER IN CONTRACT, STRICT LIABILITY, OR TORT (INCLUDING NEGLIGENCE OR OTHERWISE) ARISING IN ANY WAY OUT

OF THE USE OF THIS SOFTWARE, EVEN IF ADVISED OF THE POSSIBILITY OF SUCH DAMAGE.

FLAC <<http://flac.sourceforge.net/index.html>>, licensed as below,

Copyright (C) 2000,2001,2002,2003,2004,2005,2006,2007,2008,2009 Josh Coalson

Redistribution and use in source and binary forms, with or without modification, are permitted provided that the following conditions are met:

- Redistributions of source code must retain the above copyright notice, this list of conditions and the following disclaimer:
- Redistributions in binary form must reproduce the above copyright notice, this list of conditions and the following disclaimer in the documentation and/or other materials provided with the distribution.
- Neither the name of the Xiph.org Foundation nor the names of its contributors may be used to endorse or promote products derived from this software without specific prior written permission.

THIS SOFTWARE IS PROVIDED BY THE COPYRIGHT HOLDERS AND CONTRIBUTORS "AS IS" AND ANY EXPRESS OR IMPLIED WARRANTIES, INCLUDING, BUT NOT LIMITED TO, THE IMPLIED WARRANTIES OF MERCHANTABILITY AND FITNESS FOR A PARTICULAR PURPOSE ARE DISCLAIMED. IN NO EVENT SHALL THE FOUNDATION OR CONTRIBUTORS BE LIABLE FOR ANY DIRECT, INDIRECT, INCIDENTAL, SPECIAL, EXEMPLARY, OR CONSEQUENTIAL DAMAGES (INCLUDING, BUT NOT LIMITED TO, PROCUREMENT OF SUBSTITUTE GOODS OR SERVICES; LOSS OF USE, DATA, OR PROFITS; OR BUSINESS INTERRUPTION) HOWEVER CAUSED AND ON ANY THEORY OF LIABILITY, WHETHER IN CONTRACT, STRICT LIABILITY, OR TORT (INCLUDING NEGLIGENCE OR OTHERWISE) ARISING IN ANY WAY OUT

OF THE USE OF THIS SOFTWARE, EVEN IF ADVISED OF THE POSSIBILITY OF SUCH DAMAGE.



Free Manuals Download Website

<http://myh66.com>

<http://usermanuals.us>

<http://www.somanuals.com>

<http://www.4manuals.cc>

<http://www.manual-lib.com>

<http://www.404manual.com>

<http://www.luxmanual.com>

<http://aubethermostatmanual.com>

Golf course search by state

<http://golfingnear.com>

Email search by domain

<http://emailbydomain.com>

Auto manuals search

<http://auto.somanuals.com>

TV manuals search

<http://tv.somanuals.com>