

Register your product and get support at  
[www.philips.com/welcome](http://www.philips.com/welcome)

PET749



Thank you for choosing Philips.

### Need help fast?

Read your Quick Start Guide and/or User Manual first for quick tips that make using your Philips product more enjoyable.

If you have read your instructions and still need assistance, you may access our online help at

[www.philips.com/welcome](http://www.philips.com/welcome)

or call

1-888-PHILIPS (744-5477)

while with your product.

(and Model / Serial number)



Philips vous remercie de votre confiance.

### Besoin d'une aide rapide?

Le Guide rapide de début et Manuel de l'utilisateur regorgent d'astuces destinées à simplifier l'utilisation de votre produit Philips.

Toutefois, si vous ne parvenez pas à résoudre votre problème, vous pouvez accéder à notre aide en ligne à l'adresse

[www.philips.com/welcome](http://www.philips.com/welcome)

ou formez le

1-800-661-6162 (Francophone)

1-888-PHILIPS (744-5477) (English speaking)

Veillez à avoir votre produit à portée de main.

(et model / serial nombre)



Gracias por escoger Philips

### Necesita ayuda inmediata?

Lea primero la Guía rápida del comienzo o el Manual del usuario, en donde encontrará consejos que le ayudarán a disfrutar plenamente de su producto Philips.

Si después de leerlo aún necesita ayuda, consulte nuestro servicio de asistencia en línea en

[www.philips.com/welcome](http://www.philips.com/welcome)

o llame al teléfono

1-888-PHILIPS (744-5477)

y tenga a mano el producto.

(y número de model / serial)



---

EN User manual

---

ES Manual del usuario

---

FR Mode d'emploi

---

# PHILIPS

# Contents

---

<b>1</b>	<b>Important</b>	<b>6</b>
	Important safety instructions	6
	Notice	9
<hr/>		
<b>2</b>	<b>Your portable DVD player</b>	<b>12</b>
	Introduction	12
	What's in the box	12
	Overview of the main unit	13
	Overview of the remote control	15
<hr/>		
<b>3</b>	<b>Get started</b>	<b>18</b>
	Charge the battery	18
	Install remote control battery	19
	Connect additional equipment	20
<hr/>		
<b>4</b>	<b>Play</b>	<b>22</b>
	Turn on	22
	Select OSD language	22
	Play discs	22
	Play options	23
	Adjust settings	23
<hr/>		
<b>5</b>	<b>Watch TV</b>	<b>25</b>
	First time installation	25
	Switch channels	27
	View program information	27
	Manage channels	27
	Play options	28
	Adjust settings	28
<hr/>		
<b>6</b>	<b>Product information</b>	<b>34</b>
<hr/>		
<b>7</b>	<b>Troubleshooting</b>	<b>35</b>

Return your Product Registration Card or register online at  
[www.philips.com/welcome](http://www.philips.com/welcome) today to get the very most from your purchase.

Registering your model with PHILIPS makes you eligible for all of the valuable benefits listed below, so don't miss out. Complete and return your Product Registration Card at once, or register online at [www.philips.com/welcome](http://www.philips.com/welcome) to ensure:

#### \*Proof of Purchase

Returning the enclosed card guarantees that your date of purchase will be on file, so no additional paperwork will be required from you to obtain warranty service.

#### \*Product Safety Notification

By registering your product, you'll receive notification - directly from the manufacturer - in the rare case of a product recall or safety defect.

#### \*Additional Benefits

Registering your product guarantees that you'll receive all of the privileges to which you're entitled, including special money-saving offers.

## PHILIPS

*Congratulations on your purchase, and welcome to the "family!"*

**Dear PHILIPS product owner:**

Thank you for your confidence in PHILIPS. You've selected one of the best-built, best-backed products available today. We'll do everything in our power to keep you happy with your purchase for many years to come.

As a member of the PHILIPS "family," you're entitled to protection by one of the most comprehensive warranties and outstanding service networks in the industry. What's more, your purchase guarantees you'll receive all the information and special offers for which you qualify, plus easy access to accessories from our convenient home shopping network.

Most importantly, you can count on our uncompromising commitment to your total satisfaction.

All of this is our way of saying welcome - and thanks for investing in a PHILIPS product.

**P.S. To get the most from your PHILIPS purchase, be sure to complete and return your Product Registration Card at once, or register online at:**

[www.philips.com/welcome](http://www.philips.com/welcome)

Know these  
**safety** symbols



 This "bolt of lightning" indicates un-insulated material within your unit may cause an electrical shock. For the safety of everyone in your household, please do not remove product covering.

 The "exclamation point" calls attention to features for which you should read the enclosed literature closely to prevent operating and maintenance problems.

**WARNING:** To reduce the risk of fire or electric shock, this apparatus should not be exposed to rain or moisture and objects filled with liquids, such as vases, should not be placed on this apparatus.

**CAUTION:** To prevent electric shock, match wide blade of plug to wide slot, fully insert.

**ATTENTION:** Pour éviter les choc électriques, introduire la lame la plus large de la fiche dans la borne correspondante de la prise et pousser jusqu'au fond.

#### For Customer Use

Enter below the Serial No. which is located on the rear of the cabinet. Retain this information for future reference.

Model No. \_\_\_\_\_

Serial No. \_\_\_\_\_

**PHILIPS** Visit our World Wide Web Site at <http://www.philips.com/welcome>

## PHILIPS LIMITED WARRANTY ONE (1) YEAR

### WARRANTY COVERAGE:

PHILIPS warranty obligation is limited to the terms set forth below.

### WHO IS COVERED:

Philips warrants the product to the original purchaser or the person receiving the product as a gift against defects in materials and workmanship as based on the date of original purchase ("Warranty Period") from an Authorized Dealer. The original sales receipt showing the product name and the purchase date from an authorized retailer is considered such proof.

### WHAT IS COVERED:

The Philips warranty covers new products if a defect in material or workmanship occurs and a valid claim is received by Philips within the Warranty Period. At its option, Philips will either (1) repair the product at no charge, using new or refurbished replacement parts, or (2) exchange the product with a product that is new or which has been manufactured from new, or serviceable used parts and is at least functionally equivalent or most comparable to the original product in Philips current inventory, or (3) refund the original purchase price of the product. Philips warrants replacement products or parts provided under this warranty against defects in materials and workmanship from the date of the replacement or repair for ninety (90) days or for the remaining portion of the original product's warranty, whichever provides longer coverage for you. When a product or part is exchanged, any replacement item becomes your property and the replaced item becomes Philips' property. When a refund is given, your product becomes Philips' property.

**Note: Any product sold and identified as refurbished or renewed carries a ninety (90) day limited warranty.**

**Replacement product can only be sent if all warranty requirements are met. Failure to follow all requirements can result in delay.**

### WHAT IS NOT COVERED - EXCLUSIONS AND LIMITATIONS:

This Limited Warranty applies only to the new products manufactured by or for Philips that can be identified by the trademark, trade name, or logo affixed to it. This Limited Warranty does not apply to any non-Philips hardware product or any software, even if packaged or sold with the product. Non-Philips manufacturers, suppliers, or publishers may provide a separate warranty for their own products packaged with the bundled product.

Philips is not liable for any damage to or loss of any programs, data, or other information stored on any media contained within the product, or any non-Philips product or part not covered by this warranty. Recovery or reinstallation of programs, data or other information is not covered under this Limited Warranty.

This warranty does not apply (a) to damage caused by accident, abuse, misuse, neglect, misapplication, or non-Philips product, (b) to damage caused by service performed by anyone other than Philips or Philips Authorized Service Location, (c) to a product or a part that has been modified without the written permission of

Philips, or (d) if any Philips serial number has been removed or defaced, or (e) product, accessories or consumables sold "AS IS" without warranty of any kind by including refurbished Philips product sold "AS IS" by some retailers.

### This Limited Warranty does not cover:

- Shipping charges to return defective product to Philips.
- Labor charges for installation or setup of the product, adjustment of customer controls on the product, and installation or repair of antenna/signal source systems outside of the product.
- Product repair and/or part replacement because of improper installation or maintenance, connections to improper voltage supply, power line surge, lightning damage, retained images or screen markings resulting from viewing fixed stationary content for extended periods, product cosmetic appearance items due to normal wear and tear, unauthorized repair or other cause not within the control of Philips.
- Damage or claims for products not being available for use, or for lost data or lost software.
- Damage from mishandled shipments or transit accidents when returning product to Philips.
- A product that requires modification or adaptation to enable it to operate in any country other than the country for which it was designed, manufactured, approved and/or authorized, or repair of products damaged by these modifications.
- A product used for commercial or institutional purposes (including but not limited to rental purposes).
- Product lost in shipment and no signature verification receipt can be provided.
- Failure to operate per Owner's Manual.

### TO OBTAIN ASSISTANCE IN THE U.S.A., PUERTO RICO, OR U.S. VIRGIN ISLANDS...

Contact Philips Customer Care Center at:  
1-888-PHILIPS (1-888-744-5477)

### TO OBTAIN ASSISTANCE IN CANADA...

1-800-661-6162 (French Speaking)  
1-888-PHILIPS (1-888-744-5477) - (English or Spanish Speaking)

REPAIR OR REPLACEMENT AS PROVIDED UNDER THIS WARRANTY IS THE EXCLUSIVE REMEDY FOR THE CONSUMER. PHILIPS SHALL NOT BE LIABLE FOR ANY INCIDENTAL OR CONSEQUENTIAL DAMAGES FOR BREACH OF ANY EXPRESS OR IMPLIED WARRANTY ON THIS PRODUCT. EXCEPT TO THE EXTENT PROHIBITED BY APPLICABLE LAW, ANY IMPLIED WARRANTY OF MERCHANTABILITY OR FITNESS FOR A PARTICULAR PURPOSE ON THIS PRODUCT IS LIMITED IN DURATION TO THE DURATION OF THIS WARRANTY.

Some states do not allow the exclusions or limitation of incidental or consequential damages, or allow limitations on how long an implied warranty lasts, so the above limitations or exclusions may not apply to you.

*This warranty gives you specific legal rights. You may have other rights which vary from state/province to state/province.*

Philips, P.O. Box 10313 Stamford, CT 06904

3140 035 50201

# 1 Important

## Important safety instructions

### Important Safety Instructions

- ① Read these instructions.
- ② Keep these instructions.
- ③ Heed all warnings.
- ④ Follow all instructions.
- ⑤ Do not use this apparatus near water.
- ⑥ Clean only with dry cloth.
- ⑦ Do not block any ventilation openings. Install in accordance with the manufacturer's instructions.
- ⑧ Do not install near any heat sources such as radiators, heat registers, stoves, or other apparatus (including amplifiers) that produce heat.
- ⑨ For countries with a polarized mains, do not defeat the safety purpose of the polarized or grounding-type plug. A polarized plug has two blades with one wider than the other. A grounding type plug has two blades and a third grounding prong. The wide blade or the third prong are provided for your safety. If the provided plug does not fit into your outlet, consult an electrician for replacement of the obsolete outlet.

Caution: To prevent electric shock, match the wide blade of the plug to the wide slot, fully insert.



- ⑩ Protect the power cord from being walked on or pinched, particularly at plugs, convenience receptacles, and the point where they exit from the apparatus.
- ⑪ Only use attachments/accessories specified by the manufacturer.

- ⑫ Use only with the cart, stand, tripod, bracket, or table specified by the manufacturer or sold with the apparatus. When a cart is used, use caution when moving the cart/apparatus combination to avoid injury from tip-over.



- ⑬ Unplug this apparatus during lightning storms or when unused for long periods of time.
- ⑭ Refer all servicing to qualified service personnel. Servicing is required when the apparatus has been damaged in any way, such as power-supply cord or plug is damaged, liquid has been spilled or objects have fallen into the apparatus, the apparatus has been exposed to rain or moisture, does not operate normally, or has been dropped.
- ⑮ Battery usage **CAUTION** – To prevent battery leakage which may result in bodily injury, property damage, or damage to the unit:
- Install all batteries correctly, + and - as marked on the unit.
  - Do not mix batteries (old and new or carbon and alkaline, etc.).
  - Remove batteries when the unit is not used for a long time.
- ⑯ Apparatus shall not be exposed to dripping or splashing.
- ⑰ Do not place any sources of danger on the apparatus (e.g. liquid filled objects, lighted candles).
- ⑱ This product may contain lead and mercury. Disposal of these materials may be regulated due to environmental considerations. For disposal or recycling information, please contact your local authorities or the Electronic Industries Alliance: [www.eiae.org](http://www.eiae.org).
- ⑲ Where the MAINS plug or an appliance coupler is used as the disconnect device, the disconnect device shall remain readily operable.



## Warning

- Never remove the casing of this apparatus.
- Never lubricate any part of this apparatus.
- Never place this apparatus on other electrical equipment.
- Keep this apparatus away from direct sunlight, naked flames or heat.
- Never look into the laser beam inside this apparatus.
- Ensure that you always have easy access to the power cord, plug or adaptor to disconnect this apparatus from the power.

---

## Hearing safety

### Listen at a moderate volume.

- Using headphones at a high volume can impair your hearing. This product can produce sounds in decibel ranges that may cause hearing loss for a normal person, even for exposure less than a minute. The higher decibel ranges are offered for those that may have already experienced some hearing loss.
- Sound can be deceiving. Over time your hearing 'comfort level' adapts to higher volumes of sound. So after prolonged listening, what sounds 'normal' can actually be loud and harmful to your hearing. To guard against this, set your volume to a safe level before your hearing adapts and leave it there.

### To establish a safe volume level:

- Set your volume control at a low setting.
- Slowly increase the sound until you can hear it comfortably and clearly, without distortion.

### Listen for reasonable periods of time:

- Prolonged exposure to sound, even at normally 'safe' levels, can also cause hearing loss.
- Be sure to use your equipment reasonably and take appropriate breaks.

### Be sure to observe the following guidelines when using your headphones.

- Listen at reasonable volumes for reasonable periods of time.
- Be careful not to adjust the volume as your hearing adapts.

- Do not turn up the volume so high that you can't hear what's around you.
- You should use caution or temporarily discontinue use in potentially hazardous situations. Do not use headphones while operating a motorized vehicle, cycling, skateboarding, etc.; it may create a traffic hazard and is illegal in many areas.



### Caution

- Use of controls or adjustments or performance of procedures other than herein may result in hazardous radiation exposure or other unsafe operation.

---

## Notice

Any changes or modifications made to this device that are not expressly approved by Philips Consumer Lifestyle may void the user's authority to operate the equipment.

### Notice for the USA

**This equipment has been tested and found to comply with the limits for a Class B digital device, pursuant to part 15 of the FCC Rules.** These limits are designed to provide reasonable protection against harmful interference in a residential installation. This equipment generates, uses, and can radiate radio frequency energy and, if not installed and used in accordance with the instruction manual, may cause harmful interference to radio communications.

However, there is no guarantee that interference will not occur in a particular installation. If this equipment does cause harmful interference to radio or television reception, which can be determined by turning the equipment off and on, the user is encouraged to try to correct the interference by one or more of the following measures:

- Relocate the receiving antenna.
- Increase the separation between equipment and receiver.
- Connect the equipment into an outlet on a circuit different from that to which the receiver is connected.
- Consult the dealer or an experienced radio/TV technician for help.



## Environmental information

All unnecessary packaging has been omitted. We have tried to make the packaging easy to separate into three materials: cardboard (box), polystyrene foam (buffer) and polyethylene (bags, protective foam sheet.) Your system consists of materials which can be recycled and reused if disassembled by a specialized company. Please observe the local regulations regarding the disposal of packaging materials, exhausted batteries and old equipment.

---

## Disposal of your old product and batteries

Your product is designed and manufactured with high quality materials and components, which can be recycled and reused.

Never dispose of your product with other household waste. Please inform yourself about the local rules on the separate collection of electrical and electronic products and batteries. The correct disposal of these products helps prevent potentially negative consequences on the environment and human health.

Your product contains batteries, which cannot be disposed of with normal household waste.

Please inform yourself about the local rules on separate collection of batteries. The correct disposal of batteries helps prevent potentially negative consequences on the environment and human health.

Please visit [www.recycle.philips.com](http://www.recycle.philips.com) for additional information on a recycling center in your area.



### Caution

- Removal of the built-in battery invalidates the warranty and may destroy the product.



Be responsible  
Respect copyrights

The making of unauthorized copies of copy-protected material, including computer programs, files, broadcasts and sound recordings, may be an infringement of copyrights and constitute a criminal offence. This equipment should not be used for such purposes.

Recording and playback of material might require consent. See Copyright Act 1956 and The Performer's Protection Acts 1958 to 1972.

This apparatus includes this label:



## 2 Your portable DVD player

Congratulations on your purchase, and welcome to Philips! To fully benefit from the support that Philips offers, register your product at [www.philips.com/welcome](http://www.philips.com/welcome).

---

### Introduction

Your portable DVD player plays digital video discs that conform to the universal DVD Video standard. With it, you can play movies with true cinema picture quality and stereo or multi-channel sound (depending on disc and playback set-up), and enjoy digital TV programs.

You can also select sound track, subtitle languages, and different angle of view (again depending on DVD disc). Besides, you can restrict the play of discs that are not suitable for children.

You can play the following discs on the DVD player (including CD-R, CD-RW, DVD±R and DVD±RW):

- DVD-Video
- Video CD
- Audio CD
- MP3 CD
- Discs with JPEG files

---

### What's in the box

Check and identify the contents of your package:

- Portable DVD player
- Remote control
- AC power adaptor, AY5808 (Philips)
- Car adaptor
- AV cable
- Antenna
- User manual
- Quick start guide

## Overview of the main unit

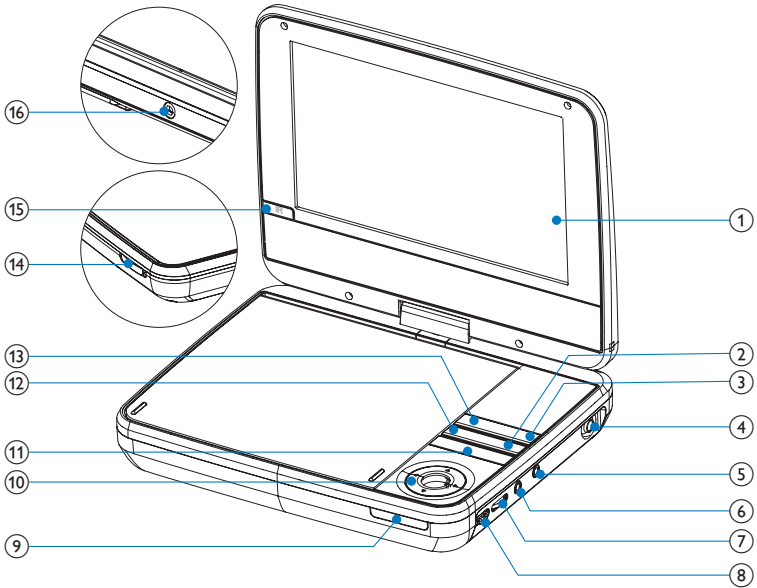

- ① **Display panel**
- ② ■
  - Stops disc play.
- ③ **TV OPTIONS**
  - Accesses TV options relating to the current activity or selection.
- ④ **ANTENNA**
  - Antenna jack.
- ⑤ **AV OUT**
  - Audio/video output jack.
- ⑥ 
  - Headphone jack.
- ⑦ **VOLUME**
  - Increases or decreases volume.

- ⑧ **OFF - POWER - ON (CHR)**
  - Turns on/off DVD player.
- ⑨ **CHR**
  - Charging indicator.
- ⑩ **▲ (CH+), ▼ (CH-), ◀, ▶**
  - Navigates menus.
- ▲ (CH+), ▼ (CH-)**
  - Switches to the next or previous channel.
- ◀, ▶**
  - Searches backward/forward at different speeds.
- ▶▶**
  - Confirms an entry or selection.
  - Starts, pauses or resumes disc play.
- ⑪ **◀▶**
  - Skips to the previous or next title, chapter, or track.
- ⑫ **DISC MENU**
  - For DVD, accesses or exits disc menu.
  - For VCD, turns on or off PBC (Playback Control) mode.
  - For VCD version 2.0 or SVCD with PBC turned on, returns to the menu.
- ⑬ **DVD/DTV**
  - Switches between DVD and DTV.
- ⑭ **OPEN**
  - Opens the disc compartment.
- ⑮ **IR**
  - Remote control sensor
- ⑯ **DC IN 9-12V**
  - Power supply socket.

# Overview of the remote control

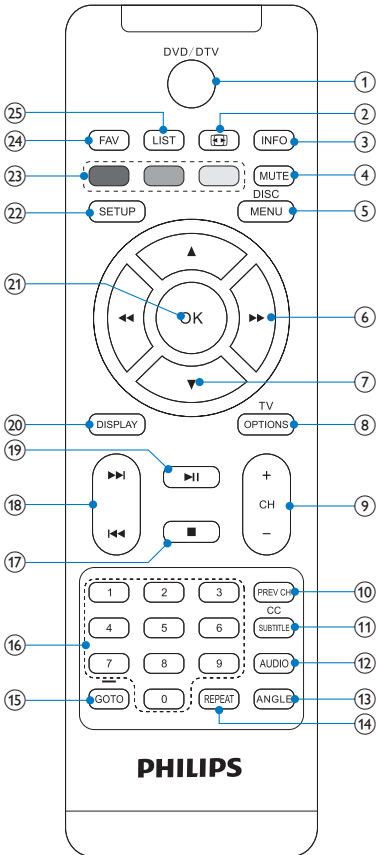

- ① **DVD/DTV**
  - Switches between DVD and DTV.
- ② **4:3**
  - Adjusts screen aspect ratio.
- ③ **INFO**
  - For TV, displays program information (if available).
  - For DVD, displays playback information.

- ④ **MUTE**
  - Mutes or restores volume.
- ⑤ **DISC MENU**
  - For DVD, accesses or exits disc menu.
  - For VCD, turns on or off PBC (Playback Control) mode.
  - For VCD version 2.0 or SVCD with PBC turned on, returns to the menu.
- ⑥ **◀◀, ▶▶**
  - Navigates menus.
  - Searches backward/forward at different speeds.
- ⑦ **▲, ▼**
  - Navigates menus.
- ⑧ **TV OPTIONS**
  - Accesses TV options relating to the current activity or selection.
- ⑨ **CH+/-**
  - Switches to the next or previous channel.
- ⑩ **PREV CH**
  - Returns to the previously viewed channel.
- ⑪ **CC/SUBTITLE**
  - For TV, turns off or on display captions.
  - Selects DVD subtitle language.
- ⑫ **AUDIO**
  - For DVD/TV/radio programs, selects an audio language.
  - For VCD, selects an audio mode.
- ⑬ **ANGLE**
  - Selects a different viewing angle of a DVD.
- ⑭ **REPEAT**
  - Repeats a chapter/track/title.
- ⑮ **-/GOTO**
  - Inputs a separator for digital channel numbers.
  - During disc play, specify a position to start play.
- ⑯ **Numeric Keypad 0 - 9**
  - Input numbers.

- ①7 ■
  - Stops disc play.
- ①8 |◀◀ ▶▶|
  - Skips to the previous or next title, chapter, or track.
- ①9 ▶||
  - Starts, pauses or resumes disc play.
- ②0 **DISPLAY**
  - Adjusts the display value of the system.
- ②1 **OK**
  - Confirms an entry or selection.
  - Accesses or exits the channel list.
- ②2 **SETUP**
  - Accesses or exits the setup menu.
- ②3 **Color keys**
  - For TV channel management, selects tasks or options.
- ②4 **FAV**
  - For TV, accesses or exits the favorite channel list.
- ②5 **LIST**
  - For TV, displays the list of channels.



## 3 Get started



### Caution

- Use the controls only as stated in this user manual.
- Always follow the instructions in this chapter in sequence.

If you contact Philips, you will be asked for the model and serial number of your player. The model number and serial number are on the bottom of your player. Write the numbers here:

Model No. \_\_\_\_\_

Serial No. \_\_\_\_\_

---

## Charge the battery



### Caution

- Risk of product damage! Ensure that the power supply voltage corresponds to the voltage printed on the bottom of the player.
- Use only the supplied AC adaptor to charge the battery.



### Note

- The type plate is located on the bottom of the player.
- You can only charge the player when it is in power-off mode.

- 1 Slide the **OFF - POWER - ON (CHR)** switch to **OFF** position.
- 2 Connect the supplied AC adaptor to the player and to the AC outlet.

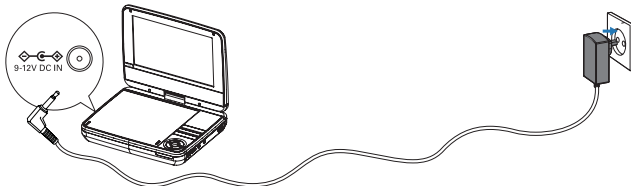

- ↳ The charge indicator turns on. It takes less than 6 hours to fully charge the battery.
- ↳ When the battery is fully charged, the charge indicator turns off.

## Install remote control battery



### Caution

- Risk of explosion! Keep batteries away from heat, sunshine or fire. Never discard batteries in fire.
- Danger of explosion if battery is incorrectly replaced. Replace only with the same or equivalent type.
- Batteries contain chemical substances, they should be disposed of properly.
- Perchlorate Material - special handling may apply. See [www.dtsc.ca.gov/hazardouswaste/perchlorate](http://www.dtsc.ca.gov/hazardouswaste/perchlorate).

### For first-time use:

- 1 Remove the protective tab to activate the remote control battery.

### To replace the remote control battery:

- 1 Open the battery compartment.
- 2 Insert 1 CR2025 battery with correct polarity (+/-) as indicated.
- 3 Close the battery compartment.

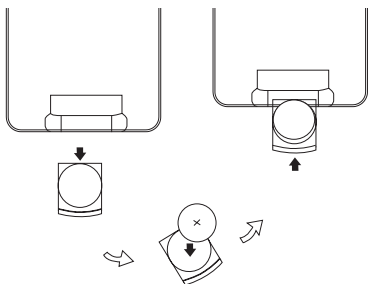

---

# Connect additional equipment

---

## Connect a TV



### Caution

- Turn off your player before connecting to any additional equipment.

You can connect the player to a TV to enjoy DVD.

- Match the color of the AV cables (the AV cable connected to the TV is not supplied) with the jacks: the yellow cable is for the yellow video jack, the red/white cable is for the red/white audio jacks.

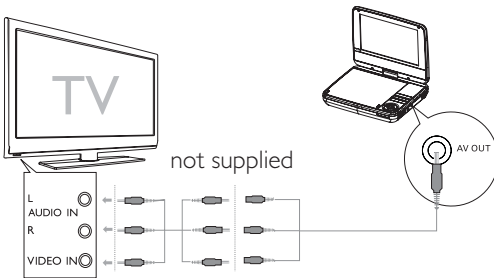

### Note

- You cannot output the TV content from the player to a TV.

---

## Connect TV antenna

You can connect your player to the supplied antenna or home antenna to receive digital TV program.

- 1 Connect the antenna to the **ANTENNA** jack.

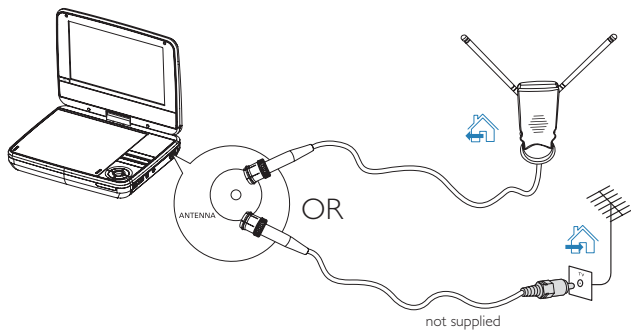

### Tip

- Fully extend the antenna for better reception.
- The antenna with the magnetic base can be attached to any ferrous surface for your convenience.

## 4 Play

### Turn on

Slide the **OFF - POWER - ON (CHR)** switch to the **ON** position.

### Select OSD language

You can choose a different language for the on-screen display text.

- 1 Press **SETUP**.  
↳ The setup menu appears.

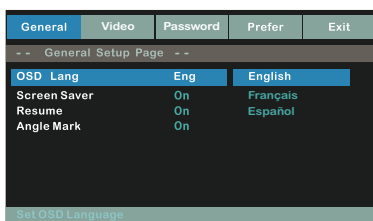

- 2 Select **[-- General Setup Page --]** > **[OSD Lang]**.
- 3 Press **▶▶** to select an option.
- 4 Press **OK** to confirm.
- 5 Press **SETUP** to exit.

### Play discs

- 1 Press **DVD/DTV** to switch to DVD mode.
- 2 Press **OPEN** on the player to open the disc compartment.
- 3 Insert a disc with label side facing up.
- 4 Push down to close the disc compartment.  
↳ Play starts automatically. If not, press **▶||/OK**.
  - If a menu appears, select an item, then press **▶||/OK** to start play.
  - To pause, press **▶||**. Press again to resume play.
  - To stop, press **■** twice.
  - To select the previous/next item, press **◀◀** or **▶▶**.
  - To start search within video/audio, press **◀◀/▶▶** once or more.

---

## Play options

---

### Select audio language

For DVDs that contain two or more audio languages.

- During play, press **AUDIO** repeatedly until the language is selected.

### Select subtitle language

For DVDs that contain two or more subtitle languages.

- During play, press **SUBTITLE** repeatedly until the language is selected.

---

## Repeat

- During play, press **REPEAT** repeatedly to select different repeat options.



Tip

- For VCDs, if PBC is on, you cannot repeat items.

---

## Rotate pictures

For JPEG CDs only. While the JPEG is displayed:

- Press ◀ to rotate counter-clockwise.
- Press ▶ to rotate clockwise.
- Press ▲ to flip up/down.
- Press ▼ to flip left/right.

---

## Adjust settings

To maximize your play experience, use **SETUP** to fine tune your settings.

- 1 In DVD mode, press **SETUP**.  
↳ The setup menu is displayed.
- 2 Press ▲▼ to select an option and press ▶||/OK to confirm.

<b>[-- General Setup Page --]</b>	
<b>[OSD Lang]</b>	Select on-screen display language.
<b>[Screen Saver]</b>	Activate/deactivate screen saver.
<b>[Resume]</b>	Select whether to start play from the point where it was last stopped.
<b>[Angle Mark]</b>	select angle mark display options.
<b>[--Video Setup Page--]</b>	
<b>[TV Type]</b>	Set TV standard.
<b>[--Password Setup Page--]</b>	
<b>[Password]</b>	Change password (3308 by default).
<b>[--Preference Setup Page--]</b>	
<b>[Audio]</b>	Select audio language.
<b>[Subtitle]</b>	Select subtitle language.
<b>[Disc Menu]</b>	Select disc menu language.
<b>[Parental]</b>	Select parental level.
<b>[Default]</b>	Restore original settings.

**3** Press ◀◀ to go back to previous menu level.

**4** Press **SETUP** to exit.

## Adjust display

**1** Press **DISPLAY** on the remote control.  
 ↳ The display setup menu is displayed.

**2** Press ▲/▼ to select an option.

**3** Press ◀◀/▶▶ to change the value.

**4** Press **DISPLAY** again to exit.

# 5 Watch TV



## Note

- Before you start, ensure that you have connected the antenna to the player.
- Make sure you are in an area with sufficient signal coverage. You can check the signal coverage with the TV broadcast authority of your country or visit [www.philips.com/support](http://www.philips.com/support).

## First time installation

- 1 When the unit is turned on, press **DVD/DTV** to switch to DTV mode.
  - When you switch to the DTV mode for the first time, follow the on-screen instructions.
  - You are prompted to select the menu language.



- 2 Press **◀◀▶▶** to select your language, then press **▼** to select **[Go to next step :]** and press **OK** to confirm.  
↳ You are prompted to select the time zone and daylight saving time.

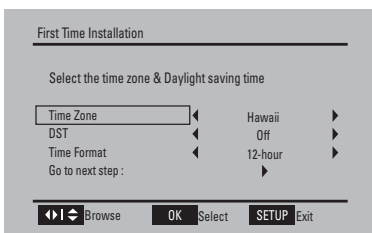



- 3 Select the time zone, DST and timer format, then press ▼ to select [Go to next step :] and press OK to confirm.

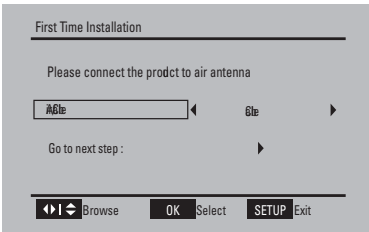

- 4 Select the antenna type as [Air], then press ▼ to select [Go to next step :] and press OK to confirm.

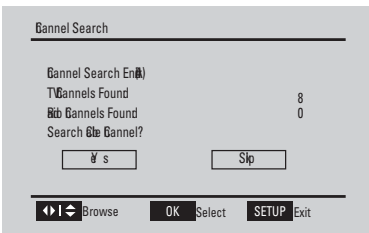
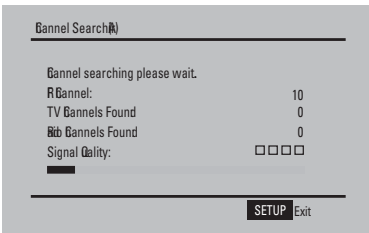

- ↳ Auto channel search (Air) starts and will take a few minutes.
- ↳ When auto channel search is complete, the total number of TV and radio channels found is displayed.

- 5 To skip the cable channel search, select [Skip], and then press OK.
- ↳ The programs of the first found channel play automatically.

- 6 If you connect the portable TV to a cable TV socket, select **[Yes]**, and then press **OK**.
- ↳ Auto channel search (Cable) starts and will take a few minutes.
  - ↳ When auto channel search is complete, the total number of TV and radio channels found is displayed.
    - To view the programs of the first found channel, press **OK**.

## Switch channels

Press **▲/▼** on the main unit, **CH+/-** or **Number keys** on the remote control.

- Press **PREV CH** to return to the previously viewed channel.

## View program information

To view brief information of the current program, press **INFO**.

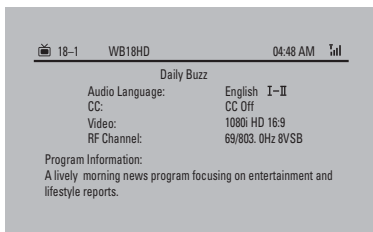

### Tip

- **I-II**: Program containing different audio languages. You can press **AUDIO** or **TV OPTIONS** to access this function.

## Manage channels

### Change channel name

- 1 Press **SETUP**.
  - ↳ The setup menu is displayed.
- 2 Select **[Channel management]** > **[Channel name]**, and press **OK**.

- 3 Select a channel, and then press ▲, ▼, ◀, ▶ to change the channel name.

---

## Edit channels

- 1 Press **SETUP**.  
↳ The setup menu is displayed.
- 2 Select [**Channel management**] > [**Channel edit**], and press **OK**.
- 3 Select a channel.
  - To delete the channel, press the red button.
  - To set the channel your favorite one, press the green button.
  - To hide the channel, press the yellow button.

---

## Play options

- 1 Press **TV OPTIONS** to select some play options.

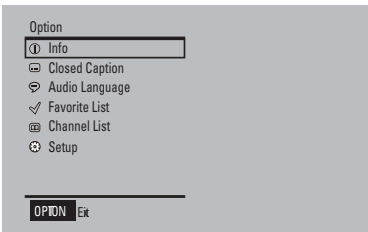

- 2 Follow the on-screen instructions.

---

## Adjust settings

To maximize your play experience, use **SETUP** to fine tune your settings.

- 1 In DTV mode, press **SETUP**.  
↳ The setup menu is displayed.
- 2 Press ▲▼ to select an option and press **OK** to confirm.

<b>[General]</b>	
<b>[Menu language]</b>	Select menu display language.
<b>[Closed Caption]</b>	Select closed caption services.
<b>[Factory reset]</b>	Restore original settings.
<b>[Time]</b>	
<b>[Time zone]</b>	Select the time zone.
<b>[DST]</b>	Set the Daylight Saving Time. <b>[On]:</b> If it is summer time, select this option. <b>[Off]:</b> If it is not summer time, select this option.
<b>[Time format]</b>	Select the time format.
<b>[Channel installation]</b>	
<b>[Air/Cable]</b>	Select the antenna type.
<b>[Auto scan]</b>	Search TV channels automatically.
<b>[Manual scan]</b>	Search TV channels manually. This option is not available in cable mode.
<b>[Channel management]</b>	
<b>[Channel name]</b>	Change channel name.
<b>[Channel edit]</b>	Edit channels.

**3** Press ◀◀ to go back to previous menu level.

**4** Press **SETUP** to exit.

## View closed captions (subtitles)

The caption service displays transmitted CC- and T- text. The caption text can be displayed permanently or only when the TV is muted.



- This television provides a display of television closed captioning that conforms with the EIA-608 standard and in accordance with Sections 15.119 of the FCC rules.
- The captions do not always use correct spelling and grammar.
- Not all TV programs and product commercials include closed caption information. Refer to your area TV program listings for the TV channels and times of closed caption shows. The captioned programs are usually noted in the TV listings with service marks such as 'CC'.

---

## Closed captioning

Closed captioning is an assistive technology that allows persons with hearing disabilities to access television programming. Closed captioning displays the audio portion of programming as text superimposed over the video.

---

## Display captions

- 1 Press **SETUP**.  
↳ The setup menu is displayed.
- 2 Select **[General] > [Closed Caption] > [CC mode]**, and press **OK** to confirm.
- 3 Press **▲** or **▼** to select an option, and press **OK** to confirm:
  - **[CC on]**: The closed caption is enabled.
  - **[CC off]**: The closed caption is disabled.
  - **[CC on Mute]**: The closed caption is enabled in mute mode.
- 4 Press **SETUP** to exit.

---

## Select caption services

- 1 Select a caption service for analog channels:
  - Press **SETUP** and select **[General] > [Closed Caption] > [Basic selection]**, then press **OK** to confirm.
  - Press **▲** or **▼** to select one of the listed caption services, and press **OK** to confirm.



## Note

- Not all caption services are used by a TV channel during the transmission of a closed caption program.

2 Press **SETUP** to exit.

## Summary of caption services

Service	Description
CC-1 and T-1	are the primary caption and text services. The captioning or text is displayed in the same language as the program's dialogue (up to 4 lines of script on the TV screen, where it does not obstruct relevant parts of the picture).
CC-3 and T-3;	serve as the preferred data channels. The captioning or text is often a secondary language.
CC-2, CC-4, T-2 and T-4;	are rarely available and broadcasters use them only in special conditions, such as when <b>[CC-1]</b> and <b>[CC-3]</b> or <b>[T-1]</b> and <b>[T-3]</b> are not available. <ul style="list-style-type: none"> <li>• There are 3 display modes according to programs:               <p><b>Paint-on mode:</b> Displays input characters on the TV screen immediately.</p> <p><b>Pop-on mode:</b> Once characters are stored in memory, they are displayed all at once.</p> <p><b>Roll-up mode:</b> Displays the characters continuously by scrolling (max. 4 lines).</p> </li> </ul>

## Select DTV caption services

- 1 Select a caption service for digital channels:
  - Press **SETUP** and select **[General] > [Closed Caption] > [Advanced selection]**, then press **OK** to confirm.
  - Press **▲** or **▼** to select one of the listed caption services, and press **OK** to confirm.

[Advanced selection]	[Off]	Select if you do not want Digital Caption Service.
[Service1] to [Service6]		Select one of these before changing any other item in [Closed Caption] menu. Choose [Service1] under normal circumstances.

2 Press **SETUP** to exit.

## Select how digital captions are displayed

You can choose the size, font, color, background and other characteristics of the caption text.

- 1 Press **SETUP** and select **[General] > [Closed Caption] > [Option] > [Mode]**, then press **OK** to confirm.
- 2 Press **▲/▼** to select **[Custom]**, then press **OK** to confirm.
- 3 Press **▲/▼** to select an option, and press **OK** to confirm.
  - **[Font style]**: select the caption font style.
  - **[FG color]**: select the caption font color.
  - **[BG color]**: select the caption background color.
  - **[FG opacity]**: select the caption font opacity.
  - **[BG opacity]**: select the caption background opacity.
- 4 Press **▲/▼** to select a setting for the option, and press **OK** to confirm.
- 5 Press **SETUP** to exit.

---

## Difficulties viewing closed captions on DTV programming

If you have difficulties viewing closed captions on DTV programming, including HDTV, received from your subscription television provider, you should:

- consult any consumer information and manuals/guides on closed captions for DTV programming provided by your subscription television provider;
- ensure that the captioning function on your DTV is turned on.

If you are still unable to view closed captions on DTV programming, you should contact your subscription television provider for assistance.



## 6 Product information



### Note

- Product information is subject to change without prior notice.

Dimensions	210 x 39 x 178 mm
Weight	0.7 kg
Power supply	Input: 100-240V~ 50/60Hz Output: DC 9V--- 1A
Power consumption	9 W
Operating temperature range	0-45°C
Laser wavelength	650 nm
TV system	ATSC
Video output	
Output format (DVD)	PAL & NTSC
Output level	1Vp - p ± 20%
Load impedance	75 Ω
Audio line out	
Audio out (analog audio)	Output level: 2V ± 10%
Load impedance	10 KΩ
Audio distortion + noise	≤ -80 (1KHz)
Frequency response	20Hz-20KHz ± 1dB
Signal/noise ratio	≥ 80 dB
Channel separation	≥ 80 dB
Dynamic range	≥ 80 dB

# 7 Troubleshooting



## Warning

- Risk of electric shock. Never remove the casing of the player.

To keep the warranty valid, never try to repair the system yourself. If you encounter problems when using the player, check the following points before requesting service. If the problem remains unsolved, register your player and get support at [www.philips.com/welcome](http://www.philips.com/welcome).

### No power

- Ensure that both plugs of the mains cord are properly connected.
- Ensure that there is power at the AC outlet.
- Check if the built-in battery is drained.

### No sound

- Ensure that the AV cable is connected correctly.

### No response to the remote control

- Ensure that the path between the remote control and the player is clear from obstacles.
- From a close distance, point the remote control directly at the player.
- Replace the remote control batteries.
- The function does not work for this disc. Refer to the disc instructions.

### Distorted picture

- Clean the disc. With a clean, soft, lint-free cloth, wipe the disc outwards from the center.
- Make sure that the video output format of the disc is compatible with the TV.
- Change the video output format to match your TV or program.
- The LCD is manufactured using high precision technology. You may, however, see tiny black points and/or bright points (red, blue, green) that continuously appear on the LCD. This is a normal result of the manufacturing process and does not indicate a malfunction.

### **Cannot play disc**

- Ensure the disc label is upwards.
- Clean the disc. With a clean, soft, lint-free cloth, wipe the disc outwards from the center.
- Check if the disc is defective by trying another disc.

### **No response to operating commands**

- The operation is not permitted by the disc.

### **The player feels warm**

- When the player is in use for a long period of time, its surface will be heated. This is normal.

### **No/weak signal displayed on the screen or no channel found**

- TV signal is too weak or out of TV signal coverage.
- Make sure you are in an area with sufficient signal coverage.



#### **Tip**

- For DTV signal coverage, please visit <http://www.fcc.gov/mb/engineering/maps/>.
- Connect to your home roof antenna or attach the supplied antenna with the magnetic base to the ferrous surface for better reception.
- Receiving TV in a driving car may cause signal problems.

Philips Consumer Lifestyle  
A division of Philips Electronics North America Corporation  
P.O. Box 10313  
Stamford, CT 06904  
Phone: 1-888-PHILIPS (744-5477)

Meet Philips at the Internet  
<http://www.philips.com/welcome>



© 2010 Koninklijke Philips Electronics N.V.

All rights reserved.

Printed in China

PET749\_37\_UM\_V1.0



## Free Manuals Download Website

<http://myh66.com>

<http://usermanuals.us>

<http://www.somanuals.com>

<http://www.4manuals.cc>

<http://www.manual-lib.com>

<http://www.404manual.com>

<http://www.luxmanual.com>

<http://aubethermostatmanual.com>

Golf course search by state

<http://golfingnear.com>

Email search by domain

<http://emailbydomain.com>

Auto manuals search

<http://auto.somanuals.com>

TV manuals search

<http://tv.somanuals.com>