

cineos™
HDTV Monitor

Your Television's Directions for Use

55PL9224
55PL9524
62PL9524

Highlights

- **Liquid-crystal-on-silicon (LCOS) High-definition Imaging**
- **High-resolution Display—1280 x 720 pixels**

Features

- Digital Natural Motion™
- Active Control™—analyzes and adjusts incoming signal
- Two-tuner, Double-window PIP (Picture-in-Picture)
- Dolby® Virtual Surround, 30-watt RMS
- 3D Y/C Comb Filter
- HD Component and DVI Input
- Side AV Convenience Jacks
- Matching stand and swivel available



Refer to the **Quick Use and Setup Guide** (supplied with your TV) for information on basic connections, remote control button descriptions, on-screen menu language, and Autoprogram.

PHILIPS

Return your Product Registration Card today to get the very most from your purchase.

Registering your model with PHILIPS makes you eligible for all of the valuable benefits listed below, so don't miss out. Complete and return your Product Registration Card at once to ensure:

*Proof of Purchase

Returning the enclosed card guarantees that your date of purchase will be on file, so no additional paperwork will be required from you to obtain warranty service.

*Product Safety Notification

By registering your product, you'll receive notification - directly from the manufacturer - in the rare case of a product recall or safety defect.

*Additional Benefits of Product Ownership

Registering your product guarantees that you'll receive all of the privileges to which you're entitled, including special money-saving offers.

PHILIPS

Congratulations on your purchase, and welcome to the "family!"

Dear PHILIPS product owner:

Thank you for your confidence in PHILIPS. You've selected one of the best-built, best-backed products available today. We'll do everything in our power to keep you happy with your purchase for many years to come.

As a member of the PHILIPS "family," you're entitled to protection by one of the most comprehensive warranties and outstanding service networks in the industry. What's more, your purchase guarantees you'll receive all the information and special offers for which you qualify, plus easy access to accessories from our convenient home shopping network.

Most importantly, you can count on our uncompromising commitment to your total satisfaction.

All of this is our way of saying welcome - and thanks for investing in a PHILIPS product.

P.S. To get the most from your PHILIPS purchase, be sure to complete and return your Product Registration Card at once.

Know these **safety** symbols



This "bolt of lightning" indicates uninsulated material within your unit may cause an electrical shock. For the safety of everyone in your household, please do not remove product covering.



The "exclamation point" calls attention to features for which you should read the enclosed literature closely to prevent operating and maintenance problems.

CAUTION: To prevent electric shock, match wide blade of plug to wide slot, fully insert.

ATTENTION: Pour éviter les choc électriques, introduire la lame la plus large de la fiche dans la borne correspondante de la prise et pousser jusqu'au fond.

For Customer Use

Enter below the Serial No. which is located on the rear of the cabinet. Retain this information for future reference.

Model No. _____

Serial No. _____

Visit our World Wide Web Site at <http://www.philips.com>

IMPORTANT SAFETY INSTRUCTIONS

Read before operating equipment

1. Read these instructions.
2. Keep these instructions.
3. Heed all warnings.
4. Follow all instructions.
5. Do not use this apparatus near water.
6. Clean only with a dry cloth.
7. Do not block any of the ventilation openings. Install in accordance with the manufacturers instructions.
8. Do not install near any heat sources such as radiators, heat registers, stoves, or other apparatus (including amplifiers) that produce heat.
9. Do not defeat the safety purpose of the polarized or grounding-type plug. A polarized plug has two blades with one wider than the other. A grounding type plug has two blades and third grounding prong. The wide blade or third prong are provided for your safety. When the provided plug does not fit into your outlet, consult an electrician for replacement of the obsolete outlet.
10. Protect the power cord from being walked on or pinched particularly at plugs, convenience receptacles, and the point where they exit from the apparatus.
11. Only use attachments/accessories specified by the manufacturer.
12.  Use only with a cart, stand, tripod, bracket, or table specified by the manufacturer, or sold with the apparatus. When a cart is used, use caution when moving the cart/apparatus combination to avoid injury from tip-over.
13. Unplug this apparatus during lightning storms or when unused for long periods of time.
14. Refer all servicing to qualified service personnel. Servicing is required when the apparatus has been damaged in any way, such as power-supply cord or plug is damaged, liquid has been spilled or objects have fallen into apparatus, the apparatus has been exposed to rain or moisture, does not operate normally, or has been dropped.
15. This product may contain lead and mercury. Disposal of these materials may be regulated due to environmental considerations. For disposal or recycling information, please contact your local authorities or the Electronic Industries Alliance: www.eiae.org
16. **Damage Requiring Service** - The appliance should be serviced by qualified service personnel when:
 - A. The power supply cord or the plug has been damaged; or
 - B. Objects have fallen, or liquid has been spilled into the appliance; or
 - C. The appliance has been exposed to rain; or
 - D. The appliance does not appear to operate normally or exhibits a marked change in performance; or
 - E. The appliance has been dropped, or the enclosure damaged.
17. **Tilt/Stability** - All televisions must comply with recommended international global safety standards for tilt and stability properties of its cabinet design.
 - Do not compromise these design standards by applying excessive pull force to the front, or top, of the cabinet which could ultimately overturn the product.
 - Also, do not endanger yourself, or children, by placing electronic equipment/toys on the top of the cabinet. Such items could unsuspectingly fall from the top of the set and cause product damage and/or personal injury.
18. **Wall or Ceiling Mounting** - The appliance should be mounted to a wall or ceiling only as recommended by the manufacturer.
19. **Power Lines** - An outdoor antenna should be located away from power lines.
20. **Outdoor Antenna Grounding** - If an outside antenna is connected to the receiver, be sure the antenna system is grounded so as to provide some protection against voltage surges and built up static charges. Section 810 of the National Electric Code, ANSI/NFPA No. 70-1984, provides information with respect to proper grounding of the mast and supporting structure, grounding of the lead-in wire to an antenna discharge unit, size of grounding connectors, location of antenna-discharge unit, connection to grounding electrodes, and requirements for the grounding electrode. See Figure below.
21. **Object and Liquid Entry** - Care should be taken so that objects do not fall and liquids are not spilled into the enclosure through openings.
 - a) **Warning:** To reduce the risk of fire or electric shock, this apparatus should not be exposed to rain or moisture and objects filled with liquids, such as vases, should not be placed on this apparatus.
22. **Battery Usage CAUTION** - To prevent battery leakage that may result in bodily injury, property damage, or damage to the unit:
 - Install all batteries correctly, with + and - aligned as marked on the unit.
 - Do not mix batteries (old and new or carbon and alkaline, etc.).
 - Remove batteries when the unit is not used for a long time.

Note to the CATV system installer: This reminder is provided to call the CATV system installer's attention to Article 820-40 of the NEC that provides guidelines for proper grounding and, in particular, specifies that the cable ground shall be connected to the grounding system of the building, as close to the point of cable entry as practical.

Example of Antenna Grounding as per NEC - National Electric Code

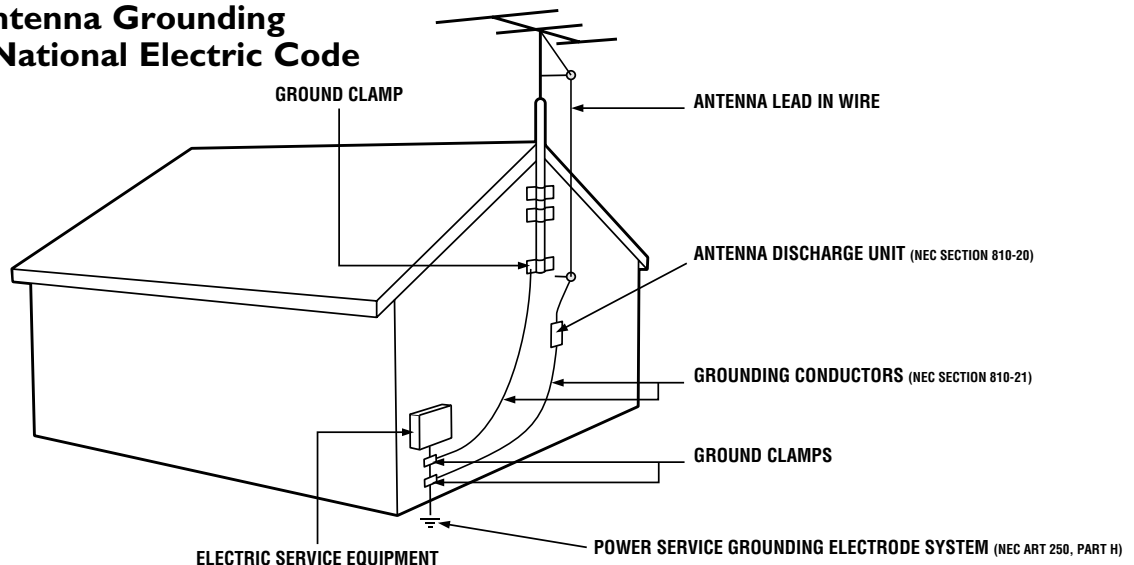

Contents

INTRODUCTION

Welcome/Registration of Your TV	.2
Safety/Precautions	.3
Features	.5

CONNECTING ACCESSORY DEVICES TO YOUR TV

Information about TV Signals	.6
Descriptions of Jacks, Cables, and Connectors	.7
Panel Jack Compatibility Information	.8
Pre-connection Recommendations	.9
Connecting a VCR	.10
Connecting a VCR and Cable Box	.11
Connecting an S-Video Device	.12
Connecting a Standard DVD Player	.13
Connecting a Progressive-scan DVD Player	.14
Connecting an HD Satellite Receiver to YPbPr	.15
Connecting an HD Satellite Receiver to DVI	.16
Connecting Surround Sound Equipment	.17
Connecting to the Side Inputs: Video Game System	.18
Labeling the Audio/Video Input Sources	.19

USING THE REMOTE CONTROL

Remote Control Buttons	.20-21
Programming the Remote Control	.22-23
Programming the Remote Control: Set-up Codes	.24-25
Operating Accessory Devices with the TV Remote	.26-27
Using Active Control™ Plus	.28

USING THE ON-SCREEN MENUS

PICTURE

Adjusting/Setting the Picture Controls	.29
Selecting a Digital Processing Option	.30
Selecting a Dynamic Contrast Option	.31
Selecting a DNR (Dynamic Noise Reduction) Option	.32
Turning on Color Enhancement	.33
Selecting an AutoPicture™ Option	.34
Selecting a Picture Format Option	.35-36

SOUND

Adjusting the TV and Headphone Volume	.37
Selecting a TV Equalizer Option	.38
Adjusting TV Speaker Balance	.39
Turning Loudness on or off	.40
Selecting a Sound Mode Option	.41
Using Alternate Audio (SAP)	.42

Setting the TV for Stereo Programming	.43
Turning the AVL (Audio Volume Leveler) on or off	.44
Adjusting the Delta Volume	.45
Selecting an AutoSound™ Option	.46

FEATURES

Using Closed Captioning	.47
Setting the Sleptimer	.48
Setting the On Timer	.49

CHANNELS

Using the Channel List	.50
Removing Channels from the Channel List	.51
Using Lock Channel	.52
Using Lock After	.53
Blocking Programming Based on TV Ratings	.54
Blocking Programming Based on Movie Ratings	.55
Turning the Antenna Attenuator on or off	.56

GENERAL

Using Surf	.57
Using Dual Screen and PIP	.58
Changing Channels or Input Sources in Dual Screen/PIP	.59
Selecting a Picture Freeze Option	.60
Resetting the Audio/Video Settings to Factory Default Values	.61
Selecting an On-screen Display Option	.62
Setting up or Changing a PIN (Personal Identification Number)	.63
Setting the Subwoofer Control	.64
Setting the Clock—Auto Clock Mode	.65
Setting the Clock Manually	.66
Selecting a Time Zone and Setting the Daylight Savings Control	.67
Using Installation Features: Language and Autoprogram	.68

ADDITIONAL INFORMATION

Cleaning the TV	.69
Cleaning or Replacing the Filters	.70
Replacing the Lamp	.71-72
Resetting the Lamp's Lifetime Counter	.73
Troubleshooting	.74-75
Product Specifications	.76
Index	.77
Limited Warranty	.80

Features

Compact design with low weight

The unique Philips single-panel liquid-crystal-on-silicon (LCOS) technology allows for a large screen TV with a very low depth and low weight. This TV will find a place in any living room without occupying a large area, and it can be easily handled by two persons.

Philips Single-panel LCOS Imaging System

The Philips single-panel LCOS technology produces unmatched high-resolution and flicker-free video with superb brightness. This technology enables a large-screen-size TV with low weight and shallow depth without any concerns for convergence or image retention.

Digital Natural Motion™

Digital Natural Motion™ offers razor-sharp reproduction of movement and motion. Its unique and highly advanced processing calculates motion trajectories of moving picture elements. It corrects jerky movement from both studio programs or movie material.

ActiveControl™ Plus

Active Control™ Plus automatically analyzes the incoming signals from the Tuner, AV1, AV2, and Side video inputs 50 times per second and adjusts key picture settings. In addition to measuring picture noise, this feature uses an ambient light sensor to adjust the picture settings according to viewing conditions in the room.

Dolby* Virtual Surround

Dolby processing circuitry provides an enhanced cinema surround sound effect without the need for rear speakers.

Double-window, Two-Tuner PIP

Your TV features double-window, two-tuner PIP with second tuner double window. The TV also has single PIP (free positioning), as well as threefold and sixfold side PIPs. In addition, you get photo finish, freeze Main, and freeze PIP. Replay lets you play back the previous few seconds in a PIP screen—if you missed the action, replay it as much as you want.

Audio/Video (A/V) Jack Panel

The A/V jack panel allows direct connections with VCRs, DVDs, high-definition receivers, or other devices, providing quality TV picture and sound playback.

Audio Volume Leveler (AVL) Control

AVL keeps the TV sound at an even level. Peaks and valleys that occur at commercial breaks or during program changes are reduced, providing a more consistent, comfortable sound.

V-Chip (with Channel Lock)

The V-Chip feature (with Channel Lock) will allow you to block the viewing of channels or programs with certain ratings, and thus prevent your children from watching inappropriate materials.

Autoprogramming

The TV's Autoprogram feature searches (when activated) for all available channels from regular antenna or cable signals and stores active broadcast stations in the TV's memory.

Surf Button

Philips Auto Surf™ allows you to easily switch between only the channels that are of interest to you. Surf allows two-channel surfing or nine-channel surfing.

Items Included with This TV

As you unpack your TV, please note the included items:

- *Quick Use and Setup Guide* to help you set up your new TV.
- *Directions for Use* manual—contains information on safety, set maintenance, Factory Service Center locations, and product warranty
- Warranty Registration Card
- Remote Control (with supplied batteries).

Please take a few minutes to complete your registration card. The serial number for the TV is on the rear of the set. For your future reference, please write down the serial and model number of this television in the space provided on the warranty page at the back of this manual. (In the unlikely event you should need to place a service call, these numbers will be needed.)

End-of-Life Disposal

Your new television and its packing contain materials that can be recycled and reused. Specialized companies can recycle your product to increase the amount of reusable materials and minimize the amounts that need to be properly disposed of. Your product also uses batteries that should not be thrown away when depleted, but should be handed in and disposed of as small chemical waste.

When you replace your existing equipment, please find out about the local regulations regarding disposal of your old television, batteries, and packing materials.



As an Energy Star® Partner, Philips Consumer Electronics has determined this product meets the Energy Star® guidelines for energy efficiency.

Energy Star® is a U.S. registered mark. Using products with the Energy Star® label can save energy. Saving energy reduces air pollution and lowers utility bills.

*Manufactured under license from Dolby Laboratories. "Dolby" and the double-D symbol are trademarks of Dolby Laboratories.

Active Control, AutoPicture, AutoSound, AutoSurf, Cineos, Digital Crystal Clear, Digital Natural Motion, and Pixel Plus are trademarks of Philips Consumer Electronics. Copyright 2004 Philips Consumer Electronics. All rights reserved.



Ways TV Signals Can Come to Your Home

Over the Air

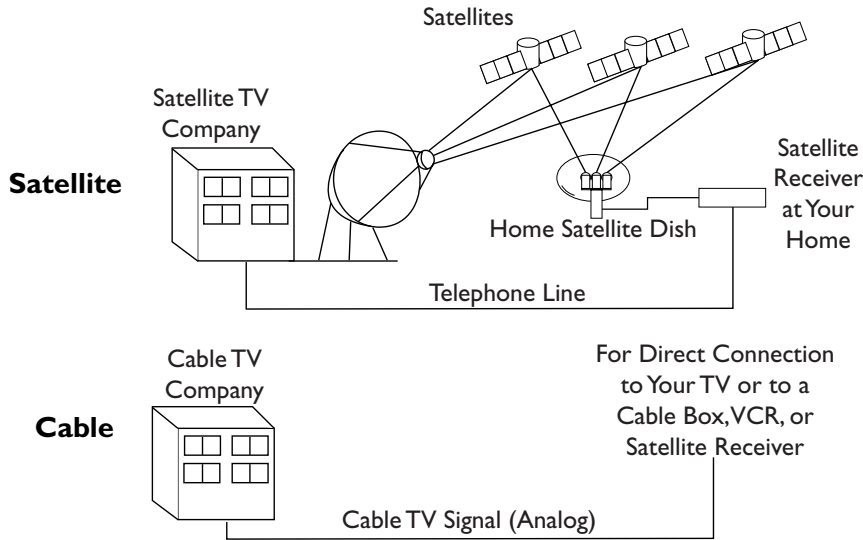
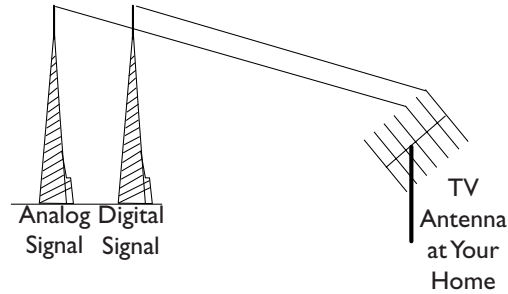

Your High-definition-ready Set

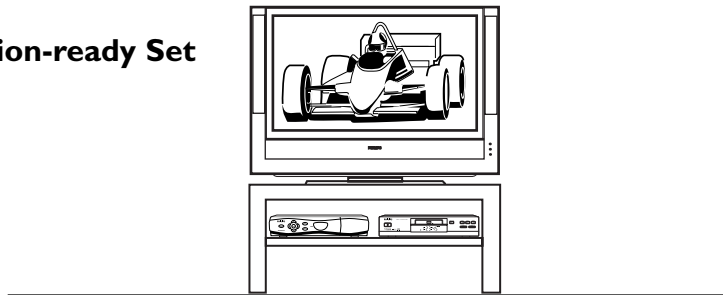

High-definition television offers a picture with unprecedented crispness and clarity. The TV broadcast industry is moving toward high definition as the signal standard. Currently, the number of programs being broadcast in high definition is limited, but this is changing. To view high-definition programs on your TV, you will need to connect a satellite receiver, cable box, or set-top box that can decode HD signals.

Resolution information

Image resolutions are commonly referred to by a number followed by a letter: 480i, 480p, 720p and 1080i. The number in each format refers to the number of lines of resolution, so for example both 480i and 480p offer 480 lines of resolution. The "i" or "p" refers to whether the signal is displayed using respectively interlaced or progressive scan. Interlaced scan breaks each frame of video into 2 fields, one made up of even lines and one made up of odd lines. The image is reproduced by drawing all odd lines first (1,3,5,...479) than all the even ones (2,4,6,...,480). Progressive scan, on the other hand reproduces an image by drawing all lines in succession (1,2,3,4,...,480).

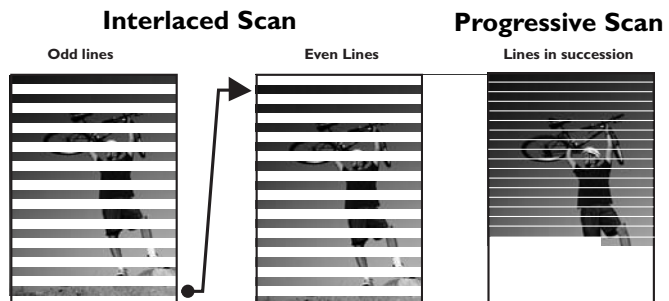

Descriptions of Jacks, Cables, and Connectors



This page contains descriptions and illustrations of jacks, cables, and connectors you might use in making connections. The cables and connectors are not supplied with your TV, but you can purchase at your electronics dealer. Or you can order them by calling our Customer Care Center at 1-800-531-0039.

DVI-D Input Jack

Cable used: DVI-D

This jack works only with DVI TMDS (Transition Minimized Differential Signaling) digital video. Allows encrypted transmissions of uncompressed digital content. The DVI-D jack used in this product is not for computer connections.

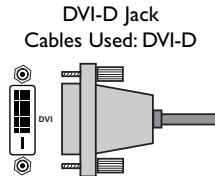

Component Video Input Jacks

Cables used: component video with RCA-type phono plugs

Allow you to connect accessory devices such as DVD players. Separating the video into three signals, these inputs provide excellent quality. Be sure to connect the left and right audio cables, because the Y, Pb, Pr jacks receive only the picture signal.

NOTE: See the "Helpful Hint" on page 13 for more information.

Component Video Jacks
Cables Used: Component Video with RCA-type Phono Plugs

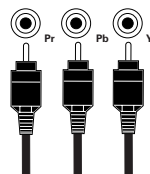

S-Video Input Jacks

Cable used: S-Video

Provide a higher quality picture than the Video (composite) jacks because the color part of the picture is separated from the black and white portion. Be sure to connect the left and right audio cables, because the S-Video jacks receive only the picture signal.

S-VIDEO Jack
Cable Used: S-Video

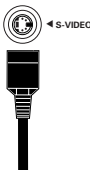

RGB+HV Input Jack

Cable used: HD DB15

Allows you to connect equipment with RGB or VGA output.

VGA/HD15 Jack
Cable Used: HD DB15

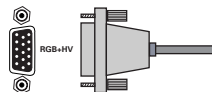

Video (called "CVBS" or "composite") Input Jacks

Cable used: Video with RCA-type phono plugs

Provide better picture performance than the antenna RF input. Be sure to connect the audio cables, because the video jacks receive only the picture signal.

Your TV also has a monitor output ("MON OUT") video ("V") jack. Use a video cable with RCA-type phone plugs to make connections.

Video (Composite) Jack
Cable Used: Video with RCA-type Phono Plugs

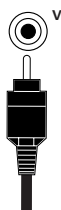

Tuner (RF) Input Jack

Cables used: RF coaxial cable (75Ω)

Allows you to connect an antenna, cable TV, or components having RF outputs to the antenna input on the TV. RF coaxial cables are available in push-on or screw-on type.

Antenna RF Jack
Cable Used: RF Coaxial (75Ω)

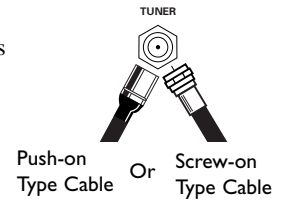

Signal Splitter

Allows you to route an antenna or cable TV signal to two inputs.

Signal Splitter
Cables Used: RF Coaxial (75Ω)

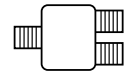

300- to 75-ohm Twin-lead Adapter

Accepts twin-lead wires from an antenna and allows connection to the antenna input on the TV. If your antenna is already equipped with an RF coaxial cable you will not need this adapter.

300- to 75-ohm Twin-lead Adapter

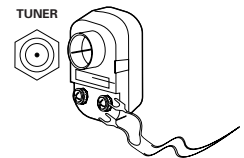

Audio Input Jacks

Cables used: Audio with RCA-type phono plugs

Provide sound for the video inputs. If your accessory device has only one output for audio, connect it to the left (color coded white) audio jack on the TV.

Your TV also has monitor output ("MON OUT") audio ("L" and "R") jacks and a subwoofer output ("SUB OUT") jack. Use an audio cable with RCA-type phone plugs to make connections.

Audio Jacks
Cables Used: Audio with RCA-type Phono Plugs

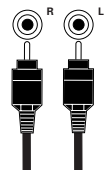

3.5mm Stereo Mini Phone Plug to RCA Jack Adapter

Allows a connection between the 3.5mm stereo audio out jack on a computer and the left and right audio inputs on the television. Connect A/V cables with RCA-type phono plugs to the adapter, then to the TV.

3.5mm Stereo Mini Phone Plug to RCA Jack Adapter

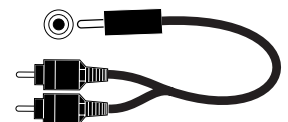



Panel Jack Compatibility Information

1 AV 1 Input Jacks
Signals accepted: NTSC (480i).
Inputs available: YPbPr, S-Video (Y/C), and CVBS, plus audio left and right.
Use only one of the video signal inputs at a time. If you should forget and have more than one type of signal connected, the set will automatically show the one of better quality: CVBS—good, S-Video—better, and YPbPr—best. For sound, connections must be made to the AV1 audio inputs.

2 MON OUT Output Jacks
 Provide video and audio output signals from all TV when those sources are being viewed on the main screen. Output from the audio L/R jacks is at a fixed volume level; changing the TV volume does not affect them. Adjust the volume at your external home cinema system.

3 AV 2 Input Jacks
Signals accepted: NTSC (480i).
Inputs available: S-Video (Y/C) and CVBS, plus audio left and right.
Use only one of the video signal inputs at a time. If you should forget and have both types of signal connected, the set will automatically show the S-Video, since it is of better quality than CVBS. For sound, connections must be made to the AV2 audio inputs.

4 SUB OUT Output Jack
 Provides a signal to an external powered subwoofer.

5 AV3 Input Jacks
Signals accepted: NTSC (480i), 480p, 720p, and 1080i, plus audio left and right.
Inputs available: YPbPr, plus audio. For sound, connections must be made to the AV3 audio inputs.

6 AV4 Input Jacks
Signals accepted: NTSC (480i), 480p, 720p, and 1080i, plus audio left and right.
Inputs available: YPbPr, plus audio. For sound, connections must be made to the AV4 audio inputs.

7 TUNER Input Jack
Signals accepted: RF modulated NTSC.
Inputs available: 75Ω RF coaxial.

8 AV5 Input Connectors
Signals accepted: NTSC (480i), 480p, 720p, 1080i, and VGA plus audio left and right.
Inputs available: RGB+HV. For sound, connections must be made to the AV5 audio inputs.

9 AV6 Input Connectors
Signals accepted: Digital only (TMDS [Transition Minimized Differential Signaling] encoded, uncompressed); DVI 480i, 480p, 720p, and 1080i, plus audio left and right.
Inputs available: DVI TMDS, plus audio. For sound, connections must be made to the AV6 audio inputs.
Intended use of the input: digital set-top boxes and inputs from other digital video devices.
NOTE: This DVI jack is not for computer connections. VGA cannot be connected.

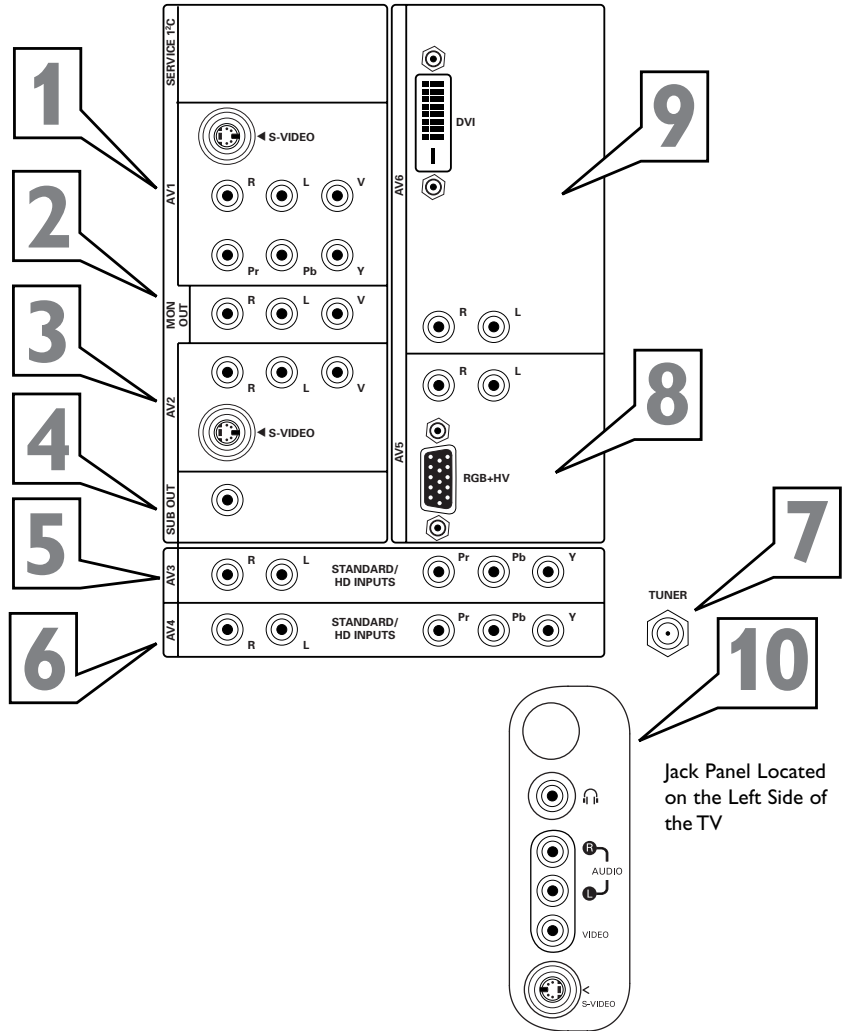

Definitions:
NTSC—National Television System Committee.
CVBS—labeled “V,” provides a small step up in quality from the Tuner (RF) input. Called Composite Video.
S-Video (Y/C)—provides better picture quality than CVBS. Separates the signal into color and brightness.
YPbPr—provides the best quality video signal. Called Component Video Input, the signal is split into three parts, two color and one brightness.

10 SIDE JACK PANEL
Signals accepted: NTSC (480i).
Inputs available: S-Video (Y/C) and CVBS, plus audio left and right.
Output available: Headphone.
 Only one of the inputs can be used at a time. Select the Side source, and the TV detects the input to which you have connected. Connections must be made to the audio inputs for sound.



Positioning the TV

Before connecting accessory devices—VCR, DVD player, or HD satellite receiver, for example—please keep the following in mind:

- Place the TV on a flat surface. An unlevel surface may adversely affect picture performance.
- Do not place the TV on shag carpet or any surface that will block the ventilation openings at the bottom of the set. Blockage will cause the TV to overheat and shut down.
- Allow 4 to 6 inches of space behind the TV for ventilation.
- An optional swivel and an optional stand are available for use with your TV. See your electronics dealer.
- Test various locations in the room to find the optimal spot to locate the set for best viewing.
- Do not place the TV in direct sunlight or near a heating appliance.
- Do not expose the TV to rain or moisture.
- To prevent any unsafe situations, do not place objects on top of the TV.

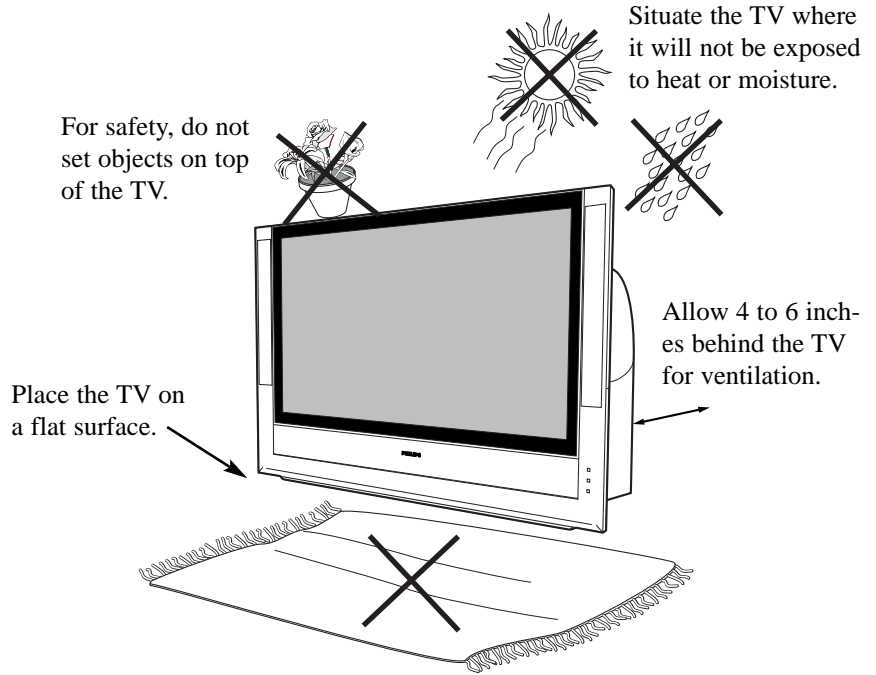

Providing Protection Against Power Surges

- Connect all accessory devices before you plug any of their power cords into the wall outlet or power strip. NEVER plug your TV into an outlet that is controlled by a wall switch.
- Turn off the TV and/or accessory devices before you connect or disconnect any cables.
- Ensure that all antennas and cables are properly grounded. See page 3, "Important Safety Instructions."

Protecting Accessory Devices from Overheating

- Arrange accessory devices so that air can circulate freely around them.
- Don't stack the accessory devices. Arrange them to allow for good ventilation. The optional Philips stand provides enough room for two accessory devices, side by side.
- If you connect an audio receiver or amplifier, place it on the top shelf so the heated air from it will not flow around other components.

Connecting Cables

Be sure to insert each cable firmly into the correct jack.

Using the Connection Examples in This Manual

The accessory device jack panels shown are for example purpose only. The jack panels on your accessory devices may look different. Also, note that connections can be made in various ways. The examples are presented only as guides.

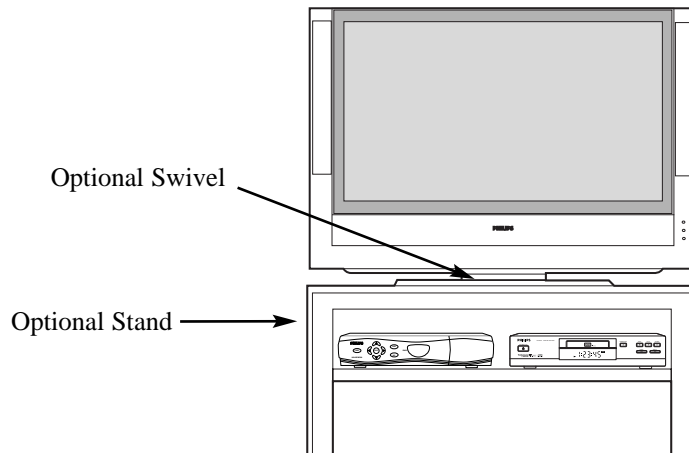



Connecting a VCR

- 1** Connect the incoming antenna or cable TV signal to the ANT IN jack on the back of the VCR.
- 2** Using a coaxial cable, connect to the OUT jack on the back of the VCR and to the TUNER jack on the back of the TV.
- 3** Using A/V cables, connect from the AUDIO and VIDEO OUT jacks on the back of the VCR to the corresponding AV2 audio (L and R) and video (V) jacks on the back of the TV.
- 4** Press the AV+ button on the remote control to access the Source list.
- 5** Press the Cursor Up or Down button to select the AV2 input source.
- 6** Press the OK button to confirm your choice. The set is now switched to the AV2 input source for the viewing of programs from the VCR.

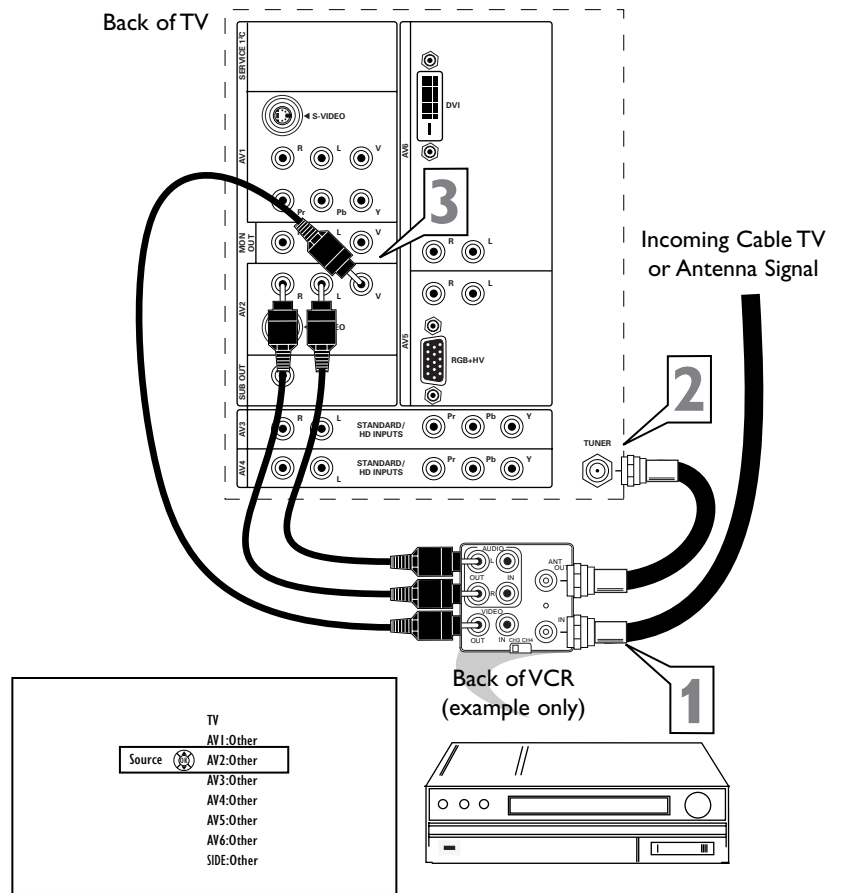

NOTE: Since you've connected the cable TV signal directly to the TV's tuner (step 2 above), you can watch the unscrambled programs by simply tuning to the desired channel. To store channels in the TV's memory, you must use Autoprogram, which you can access through "Install" in the TV's on-screen menu. See the Autoprogram section in the *Quick Use and Setup Guide* that came with the TV. If you use Autoprogram, you can select channels by pressing the CH + or - buttons on the TV remote control (in TV mode). Otherwise, you must press the digit (number) buttons to tune directly to the channel you desire.

HELPFUL HINT

Color Coding Used on Jacks and Plugs to simplify connections:

Yellow: Video (Composite Video)

Red: Right Audio

White: Left Audio.

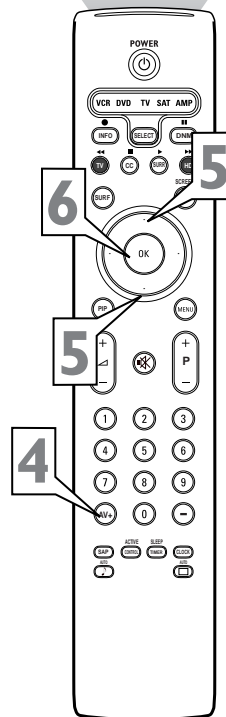

Connecting a VCR and Cable Box



NOTE: A cable box with AUDIO OUT jacks such as the one used in the example on this page might pass stereo sound to the TV. Check with your cable TV company. The RF jack output jack on a cable box (commonly labeled “OUT TO TV,” “OUTPUT,” or “OUT”) will not pass stereo sound to your TV.

- 1** Connect the incoming cable TV signal to a two-way signal splitter. The signal splitter enables you to route the cable signal to the TV without using the OUT TO TV jack on the cable box, which will not pass stereo sound to the TV.
- 2** Using a coaxial cable, connect to one of the connectors on the signal splitter and to the TUNER jack on the back of the TV.
- 3** Using a coaxial cable, connect to the other connector on the signal splitter and to the CABLE IN jack on the back of the cable box.
- 4** Using Audio/Video cables, connect to the AUDIO and VIDEO OUT jacks on the back of the cable box and to the corresponding AUDIO and VIDEO IN jacks on the back of the VCR.
- 5** Using Audio/Video cables, connect to the AUDIO and VIDEO OUT jacks on the back of the VCR and to the corresponding AV2 audio (L and R) and video (V) input jacks on the back of the TV.
- 6** Press the AV+ button on the remote control to access the Source list.
- 7** Press the Cursor Up or Down button to select the AV2 input source.
- 8** Press the OK button to confirm your choice. The set is now switched to the AV2 input source for the viewing of programs from the cable box or the VCR.

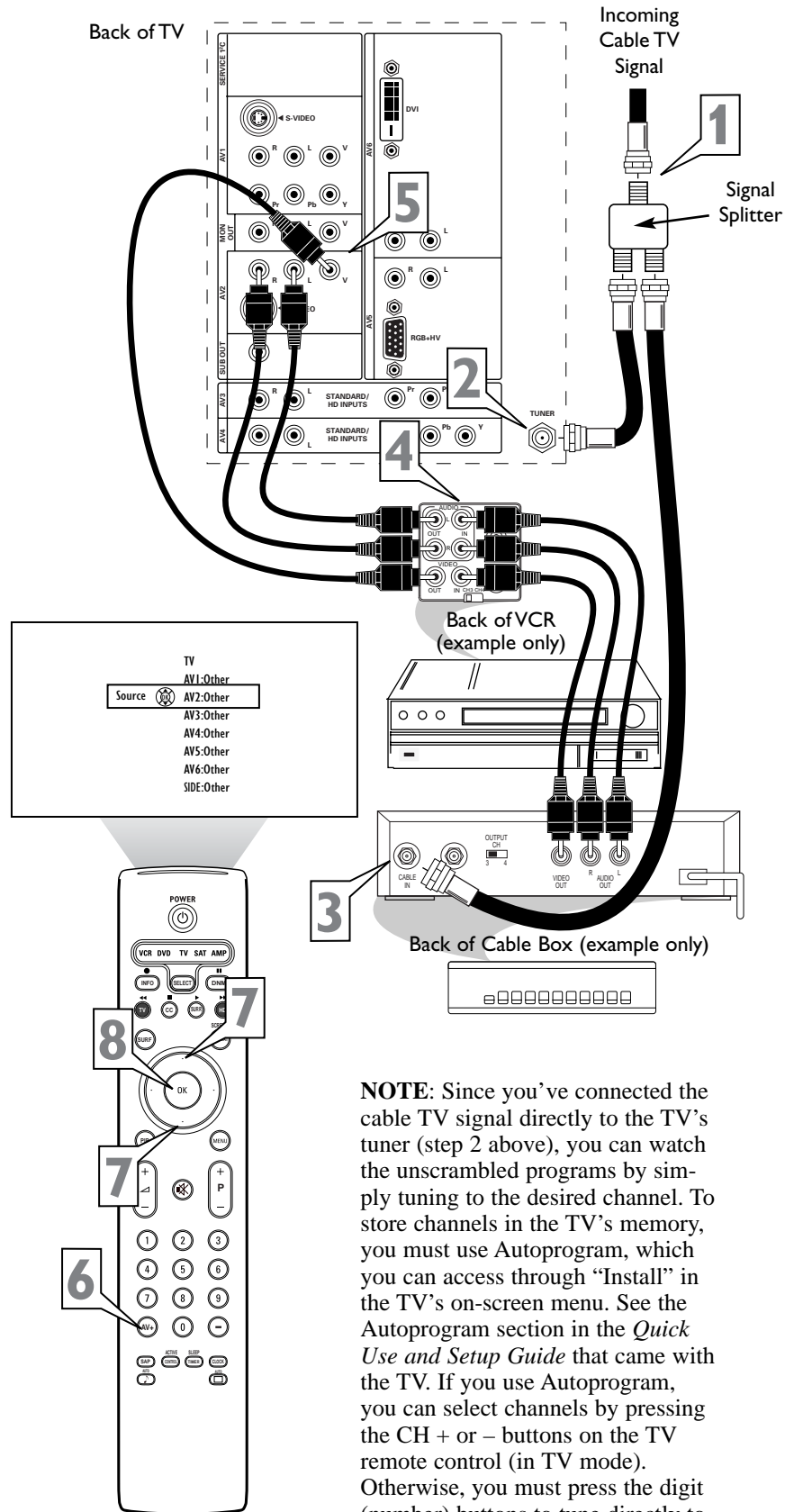

NOTE: Since you've connected the cable TV signal directly to the TV's tuner (step 2 above), you can watch the unscrambled programs by simply tuning to the desired channel. To store channels in the TV's memory, you must use Autoprogram, which you can access through "Install" in the TV's on-screen menu. See the Autoprogram section in the *Quick Use and Setup Guide* that came with the TV. If you use Autoprogram, you can select channels by pressing the CH + or - buttons on the TV remote control (in TV mode). Otherwise, you must press the digit (number) buttons to tune directly to the channel you desire.

HELPFUL HINT

Color Coding Used on Jacks and Plugs to simplify connections:
Yellow: Video (Composite Video)
Red: Right Audio
White: Left Audio.



Connecting an S-Video Device

- 1** Using an S-Video cable, connect to the S-Video output on the back of the S-Video device and to the AV2 S-VIDEO input.
- 2** Using Stereo Audio cables, connect to the AUDIO OUT jacks on the back of the S-Video device and to the corresponding AV2 audio inputs (L and R).
- 3** Press the AV+ button on the remote control to access the Source list.
- 4** Press the Cursor Up or Down button to select the AV2 input source.
- 5** Press the OK button to confirm your choice. The set is now switched to the AV2 input source for the viewing of programs from the S-Video device.

HELPFUL HINT

To simplify making connections, the connectors on audio and video cables are often color coded to match the colors on TV jacks, red for right, and white for left.

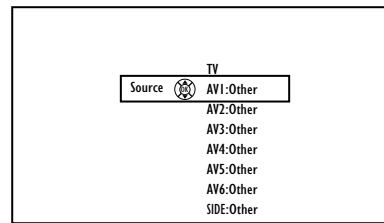
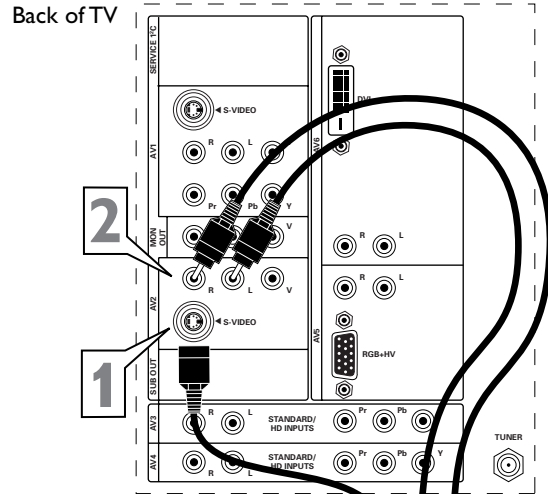

Back of Standard S-Video Device (example only)

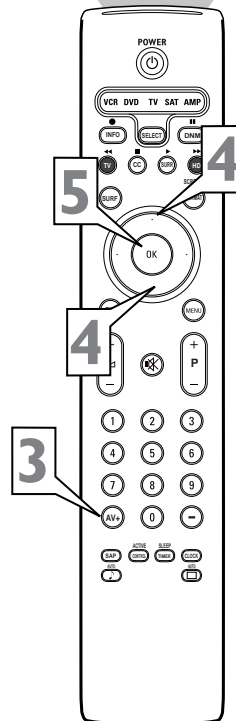
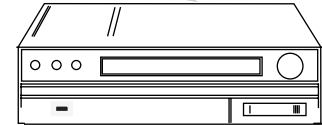

Connecting a Standard DVD Player



- 1** Using Audio/Video cables, connect to the YPbPr jacks on the back of the standard DVD player and to the AV1 YPbPr jacks on the back of the TV.
- 2** Using Stereo Audio cables, connect to the AUDIO OUT jacks on the back of the DVD player and to the corresponding AV1 audio (L and R) jacks on the back of the TV.
- 3** Press the AV+ button on the remote control to access the Source list.
- 4** Press the Cursor Up or Down button to select the AV1 input source.
- 5** Press the OK button to confirm your choice. The set is now switched to the AV1 input source for the viewing of programs from the DVD player.

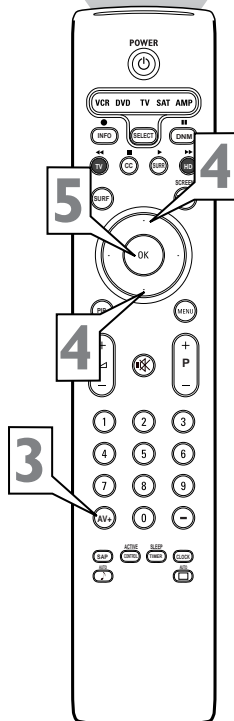
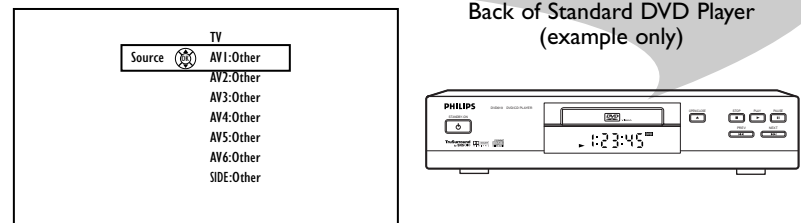
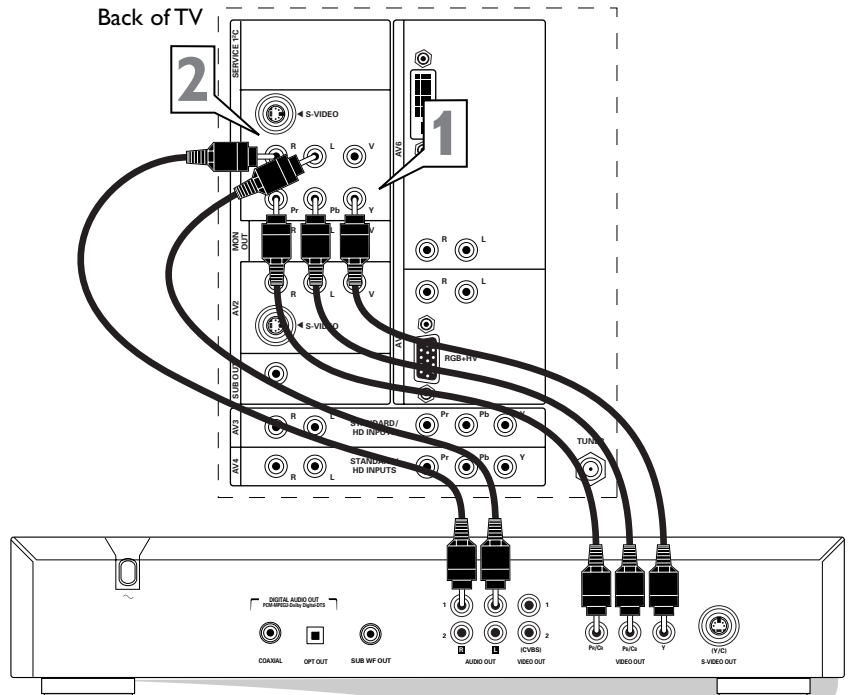

HELPFUL HINTS

- If you do not know whether your DVD player is standard or progressive scan, you can connect it to either AV3 or AV4, and the TV will automatically determine the type of output.
- To simplify making connections, the connectors on audio and video cables are often color coded to match the colors on TV jacks: green for Y, blue for Pb, and red for Pr; also red for right audio, and white for left audio.
- The names for the component video jacks may differ depending on the DVD player or accessory digital source equipment used. For example, besides YPbPr, you may see R-Y/B-Y/Y; or CrCbY. Although abbreviations and terms may vary, the letters *B* and *R* stand for the blue and red color component signal connectors, respectively, and *Y* indicates the luminance signal. If necessary, refer to the user manual for your DVD or digital accessory for more information.
- If you experience difficulties receiving sound with a DVD disc, check the sound settings through the DVD disc's menu.



Connecting a Progressive-scan DVD Player

1 Using Audio/Video cables, connect to the YPbPr jacks on the back of the progressive-scan DVD player and to the AV3 or AV4 YPbPr jacks on the back of the TV.

2 Using Stereo Audio cables, connect to the AUDIO OUT jacks on the back of the DVD player and to the corresponding AV3 or AV4 audio (L and R) jacks on the back of the TV.

3 If your DVD player has an I/P switch on the back, be sure it is set to the "P" position for progressive-scan mode.
NOTE: Some DVD players have an I/P switch on the back, while others may allow the user to change the mode by pressing a button on the DVD player's remote control or by using the DVD player's on-screen menu. Also, some DVD players have dedicated progressive-scan output jacks that are labeled as such and require no switching by the user. See the user manual for your DVD player for more information on placing the player in progressive-scan mode.

4 Press the AV+ button on the remote control to access the Source list.

5 Press the Cursor Up or Down button to select the AV3 input source.

6 Press the OK button to confirm your choice. The set is now switched to the AV3 input source for the viewing of programs from the DVD player.

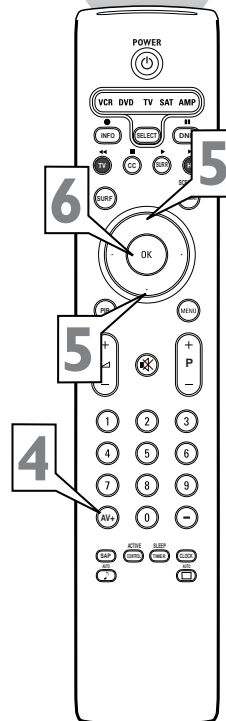
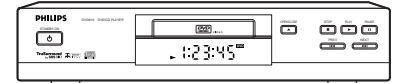
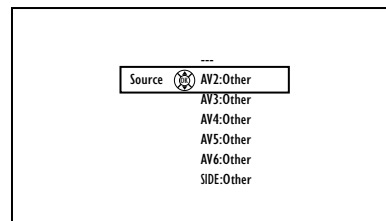
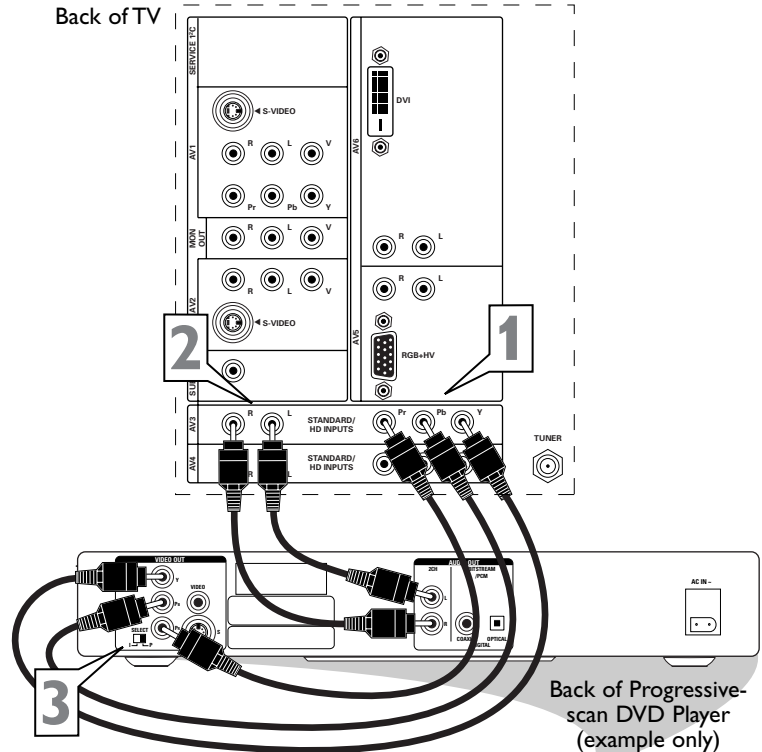

HELPFUL HINT

Inputs AV3–AV6 allow horizontal and vertical picture panning using the Cursor Left, Right, Up, and Down buttons. The Side input allows vertical picture panning; left and right panning with the Side input is possible when the input has been labeled "Game." See pages 18 and 19 for details on side panel connections and source labeling.

HELPFUL HINTS

- To simplify making connections, the connectors on audio and video cables are often color coded to match the colors on TV jacks: green for Y, blue for Pb, and red for Pr; also red for right audio, and white for left audio.
- The names for the component video jacks may differ depending on the DVD player or accessory digital source equipment used. For example, besides YPbPr, you may see R-Y/B-Y/Y; or CrCbY. Although abbreviations and terms may vary, the letters *B* and *R* stand for the blue and red color component signal connectors, respectively, and *Y* indicates the luminance signal. If necessary, refer to the user manual for your DVD or digital accessory for more information.
- If you experience difficulties receiving sound with a DVD disc, check the sound settings through the DVD disc's menu.

Connecting an HD Satellite Receiver to YPbPr



- 1** Using Component Video cables, connect to the YPbPr jacks on the back of the HD satellite receiver and to the corresponding AV3 or AV4 YPbPr jacks on the back of the TV.
- 2** Using Stereo Audio cables, connect to the AUDIO OUT jacks on the back of the HD satellite receiver and to the corresponding AV3 or AV4 audio (L and R) jacks on the back of the TV.
- 3** Refer to the user manual for the HD satellite receiver to complete the connections to the HD satellite receiver and to use the HD satellite receiver's on-screen setup menus.
- 4** After completing HD satellite receiver connections and setup through the on-screen setup menus, press the AV+ button on the TV remote to access the Source list.
- 5** Press the Cursor Up or Down button to select the AV4 input source.
- 6** Press the OK button to confirm your choice. The set is now switched to the AV4 input source for the viewing of programs from the HD satellite receiver.

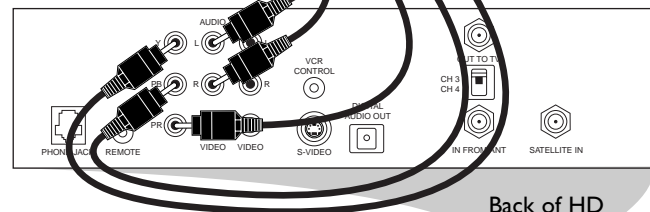
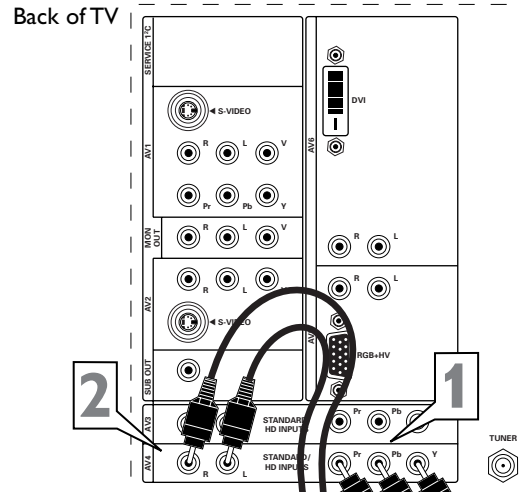

Back of HD Satellite Receiver (example only)

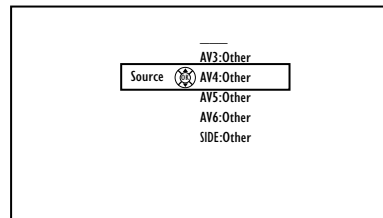
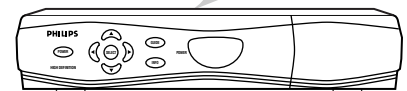

HELPFUL HINTS

- To simplify making connections, the connectors on audio and video cables are often color coded to match the colors on TV jacks: green for Y, blue for Pb, and red for Pr; also red for right audio, and white for left audio.
- The names for the component video jacks may differ depending on the DVD player or accessory digital source equipment used. For example, besides YPbPr, you may see R-Y/B-Y/Y; or CrCbY. Although abbreviations and terms may vary, the letters *B* and *R* stand for the blue and red color component signal connectors, respectively, and *Y* indicates the luminance signal. If necessary, refer to the user manual for your DVD or digital accessory for more information.
- Inputs AV3–AV6 allow horizontal and vertical picture panning using the Cursor Left, Right, Up, and Down buttons. The Side input allows vertical picture panning; left and right panning with the Side input is possible when the input has been labeled “Game.” See pages 18 and 19 for details on side panel connections and source labeling.

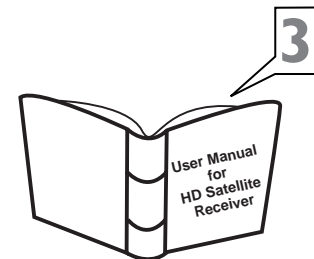
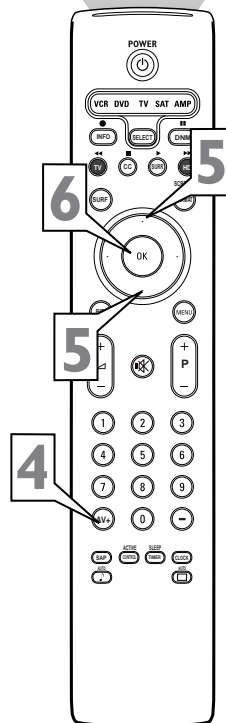



Connecting an HD Satellite Receiver to DVI

- 1** Using a DVI cable, connect to the DVI jack on the back of the HD satellite receiver and to the corresponding AV6 DVI jack on the back of the TV.
- 2** Using Stereo Audio cables, connect to the AUDIO OUT jacks on the back of the HD satellite receiver and to the corresponding AV6 audio (L and R) jacks on the back of the TV.
- 3** Refer to the user manual for the HD satellite receiver to complete the connections to the HD satellite receiver and to use the HD satellite receiver's on-screen setup menus.
- 4** After completing HD satellite receiver connections and setup through the on-screen setup menus, press the AV+ button on the TV remote to access the Source list.
- 5** Press the Cursor Up or Down button to select the AV6 input source.
- 6** Press the OK button to confirm your choice. The set is now switched to the AV6 input source for the viewing of programs from the HD satellite receiver.

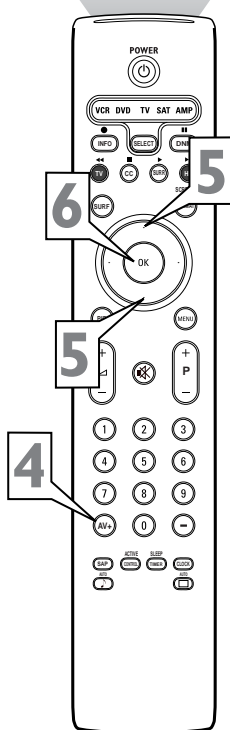
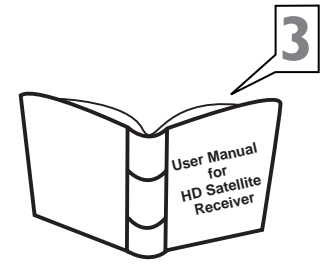
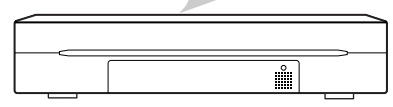
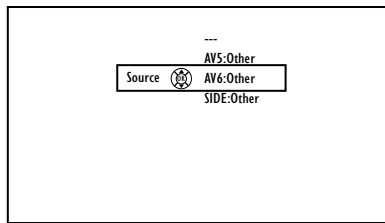
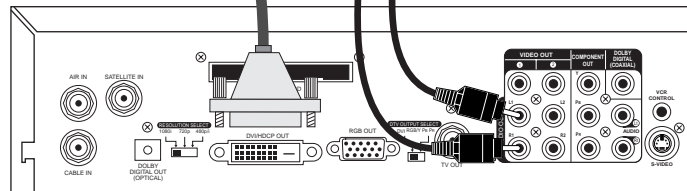
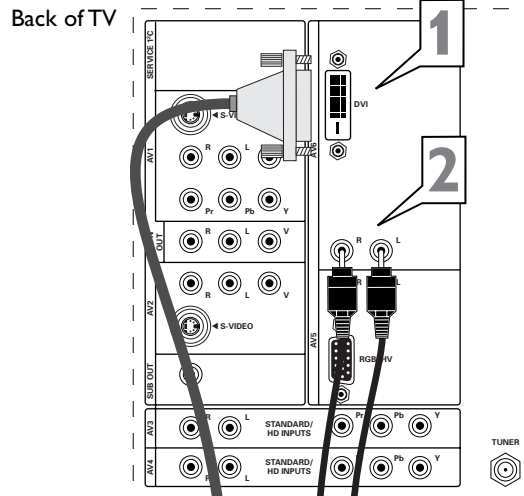

HELPFUL HINTS

- To simplify making connections, the connectors on audio cables are often color coded to match the colors on TV jacks: red for right audio, and white for left audio.
- Because DVI is such new technology, the electronics industry is still working toward a decision on one standard. Philips testing has determined that compatibility issues exist with respect to a limited number of high-definition receivers when they are connected to the DVI input on this television. If you should experience difficulties, please contact our Customer Care Center at 1-800-531-0039.
- Inputs AV3–AV6 allow horizontal and vertical picture panning using the Cursor Left, Right, Up, and Down buttons. The Side input allows vertical picture panning; left and right panning with the Side input is possible when the input has been labeled "Game." See pages 18 and 19 for details on side panel connections and source labeling.

Connecting Surround Sound Equipment



- 1** Using Stereo Audio cables, connect to the MON OUT L and R jacks on the back of the TV and to the corresponding TV IN jacks on the back of the receiver.
- 2** Using an Audio cable, connect to the SUB OUT jack on the back of the TV and to the Audio Input jack on the back of a powered subwoofer.
- 3** Using speaker wires, connect to the R and L Front Speakers terminals and to the corresponding terminals on the backs of the front speakers.
- 4** Using speaker wires, connect to the Surround Speakers terminals (+, -) on the back of the receiver and to the corresponding terminals (+, -) on the back of the surround speakers.
- 5** Press the Menu button on the remote control to display the on-screen menu.
- 6** Press the Cursor Down button to select "Settings."
- 7** Press the Cursor Right button to select "General."
- 8** Press the Cursor Down button repeatedly until "Subwoofer" is selected.
- 9** Press the Cursor Right or Left button to select "Yes."

NOTE: "Yes" must be activated for the Subwoofer menu selection before the SUB OUT jack will supply output. This is because the subwoofer's low frequencies are redirected to the main TV speakers when "No" is selected.

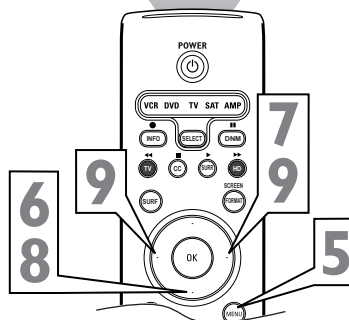
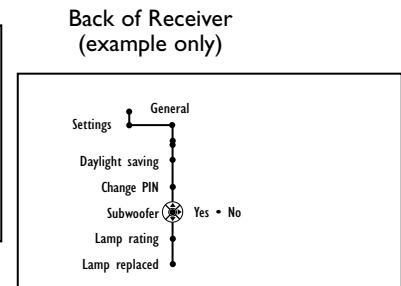
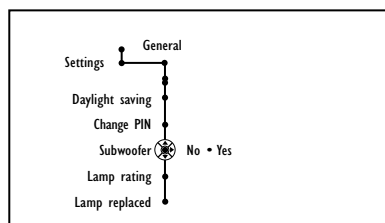
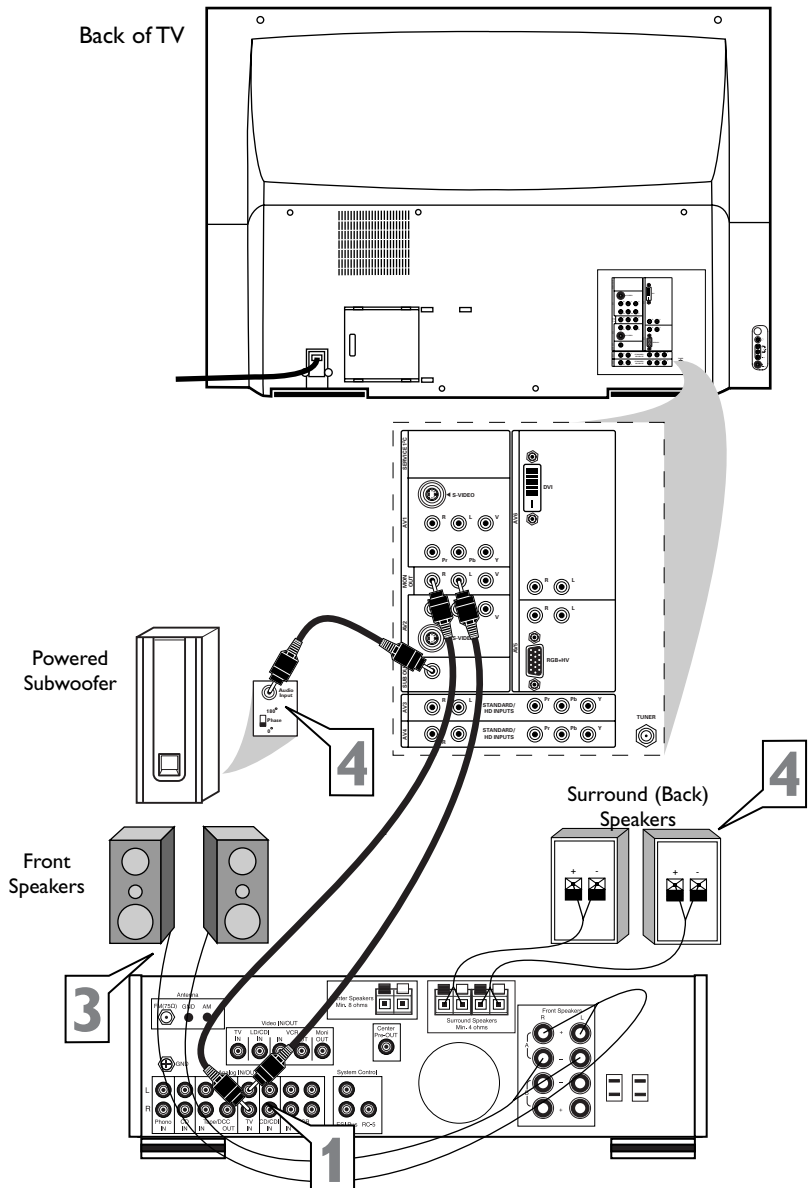

Back of Receiver (example only)

HELPFUL HINT

To simplify making connections, the connectors on audio cables are often color coded to match the colors on TV jacks: red for right audio, and white for left audio.



Connecting to the Side Inputs: Video Game System

1 Using the Audio/Video cable supplied with your video game system, connect to the back of the game system and to the corresponding S-VIDEO and AUDIO (L and R) jacks in the Side panel of the TV.

NOTE: If your game system cable does not have an S-Video plug, you can instead make a regular Video connection.

2 Press the Source button on the TV remote control to access the Source list.

3 Press the Cursor Up or Down button to select the Side input source.

4 Press the OK button to confirm your choice. The set is now switched to the Side input source for the viewing of your video game system.

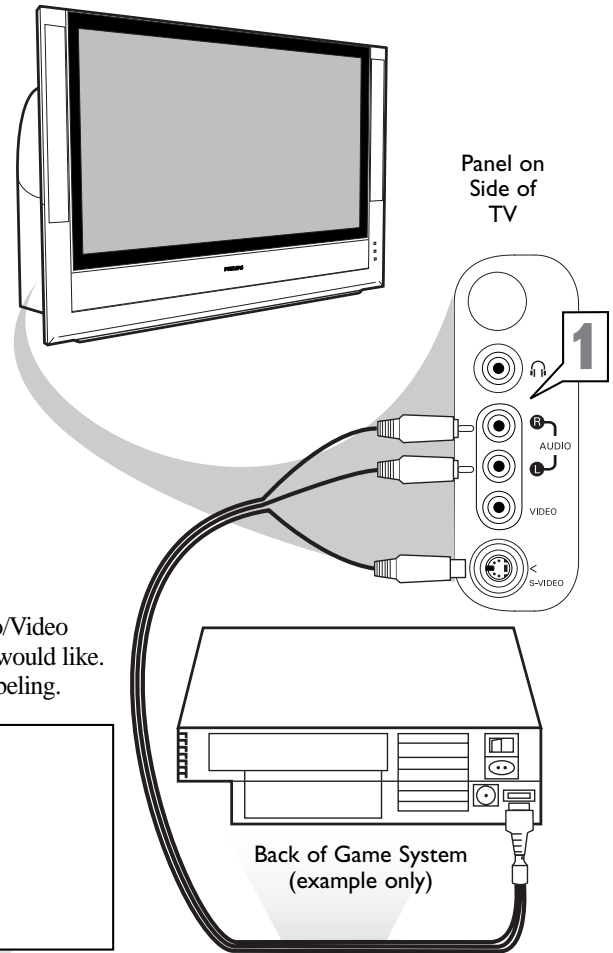

You can label the Side Audio/Video input source "Game" if you would like. See page 19 for details on labeling.

HELPFUL HINTS

- To simplify making connections, the connectors on audio and video cables are often color coded to match the colors on TV jacks: yellow for video (composite), red for right audio, and white for left audio.
- Inputs AV3–AV6 allow horizontal and vertical picture panning using the Cursor Left, Right, Up, and Down buttons. The Side input allows vertical picture panning; left and right panning with the Side input is possible when the input has been labeled "Game." See page 19 for details on source labeling.

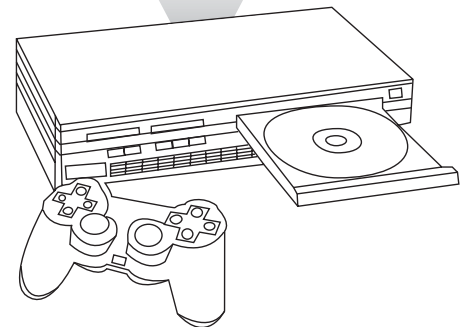
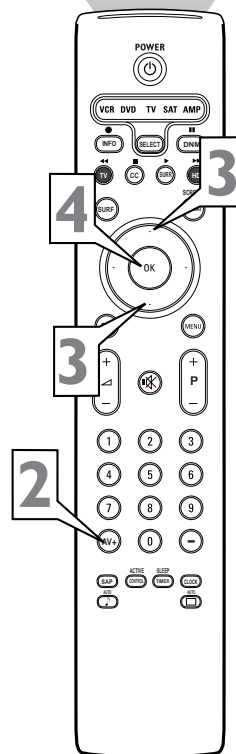
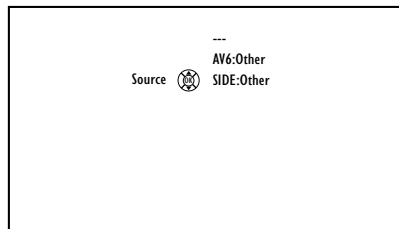

The side panel is also convenient for connecting equipment such as camcorders or cameras. If the equipment has an S-Video output jack, it is the suggested one to use for your connection to receive the best picture. Otherwise, you can make a regular Video connection. You must also make an audio connection (L and R for stereo or L for mono) to receive sound. Neither an S-Video or Video cable carries a sound signal.

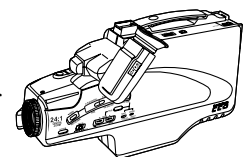

Camcorder

Labeling the Audio/Video Input Sources



You can label all the external Audio/Video input sources—AV1, AV2, AV3, AV4, AV5, AV6, and Side—according to the type of accessory device you have connected to each input.

After labeling, you can use the Source button to cycle through and select your desired source. The labels will appear alongside the channel indicator when you select the AV input sources.

- 1** Press the Menu button on the remote control to display the on-screen menu.
- 2** Press the Cursor Down button to select “Settings.”
- 3** Press the Cursor Right button repeatedly to select the “Source” menu.
- 4** Press the Cursor Down button repeatedly to select any of the AV Inputs—AV1, AV2, AV3, AV4, AV5, AV6, or Side. A list of labels will appear next to the selected AV input.
- 5** Press the Cursor Right button to enter the list.
- 6** Press the Cursor Up or Down button to scroll and select one of the labels in the list.
- 7** Press the Menu button on the remote control to remove the on-screen menu from the TV screen.
- 8** Press the Source button on the remote control to display the list of AV inputs and their labels.

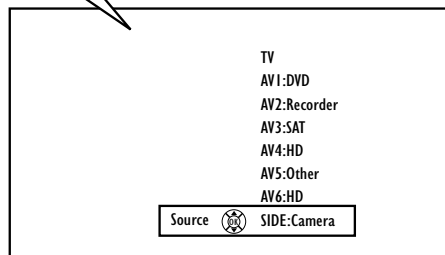
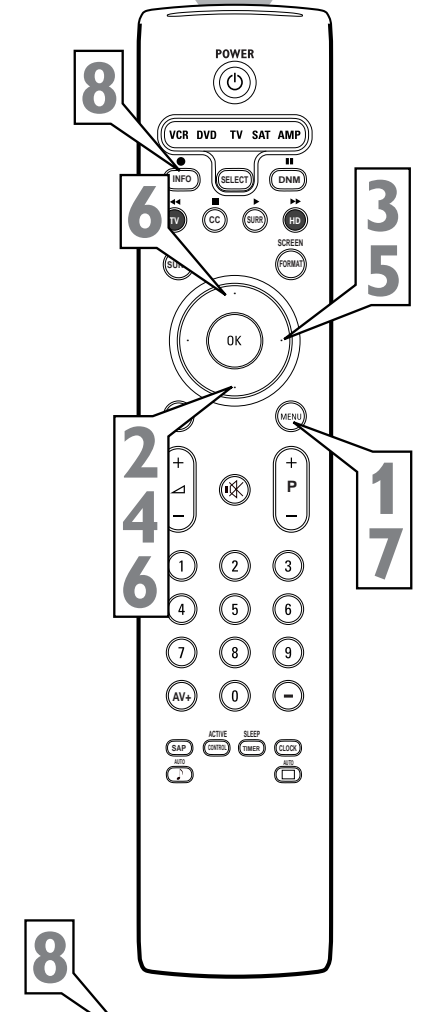
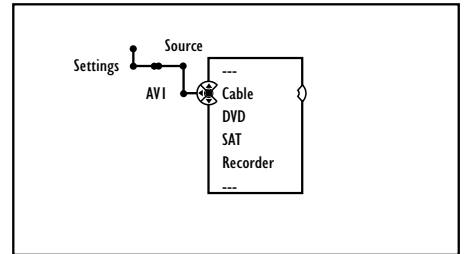
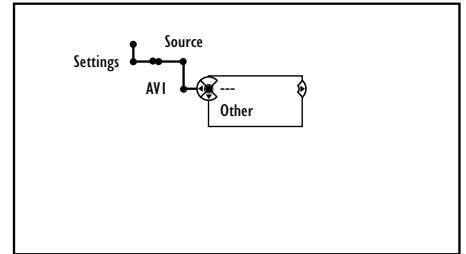
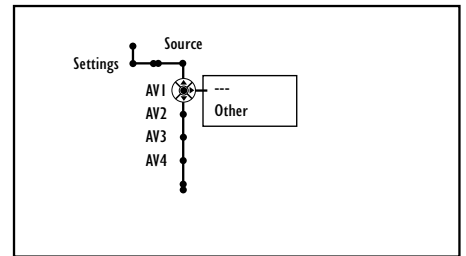
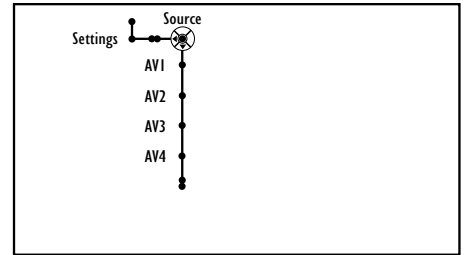
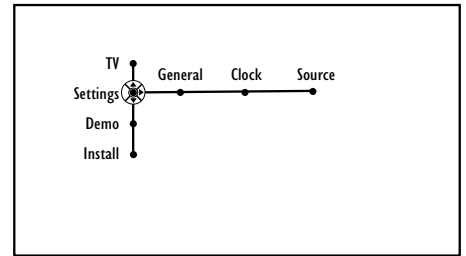
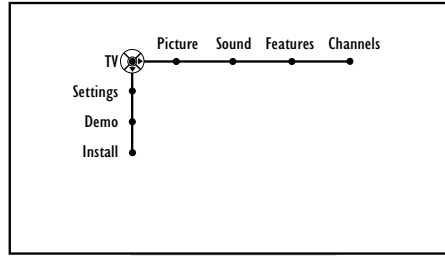

This is just a sample of what the labeling might look like. Your Source Labels will depend on the options you choose to label the AV inputs.



Remote Control Buttons

Select (CBL VCR DVD SAT AMP) and Backlight

Press this button to cycle across the accessory mode dial. Stop pressing when the mode you desire is lighted. The light will stay on for 2 seconds and then begin blinking to indicate the remote is in your desired mode. As long as the button blinks, the remote is in the accessory mode. (See pages 22–25 for programming the remote) Pressing and holding the Select button for 2 seconds backlights the remote control buttons. The buttons remain lighted for 5 seconds after you press Select.

Information Plus

Press to show information (when available) about the current channel, program, source, number or name, local time, CC availability, SAP availability, program ratings, display format, sound mode, and remaining length of a Sleep timer setting.

TV

Press to directly set the TV into the TV Mode of operation.

CC (Closed Captioning)

Press to turn Closed Captioning off, on, or on during mute. (See page 47 in the *Directions for Use* manual.)

Surf

If you set the Surf control in the TV's on-screen menu to two channels, this button will allow you to toggle between the current channel and the last viewed channel. If you choose the nine-channel Surf, pressing this button allows you to add and scroll up to nine of your favorite channels. See page 57 in the *Directions for Use* manual.

OK

Press to activate or confirm menu choices.

Dual Screen/PIP (Picture-in-Picture)

Press to turn the PIP dual screen on or off. Continuing to hold the Dual Screen/PIP button down will cycle through the Dual Screen/PIP options. (See page 58 in the *Directions for Use* manual.)

VOL (Volume)

Press + or – to adjust the volume.

Mute

Press to interrupt or restore sound.

Source (AV+)

Press to display a list of source options—TV, AV1, AV2, AV3, AV4, AV5, AV6, or Side. Use the Cursor Up/Down buttons to select the next item, then press the OK button to confirm or press the Source Select button to select the next item in the list.

Alternate Audio (SAP)

When you tune to a channel where SAP (Second Audio Program) is available, you can toggle between Main and SAP. If SAP is not available, only Main can be selected. (See page 42 in the *Directions for Use* manual.)

AutoSound™

Press to select the next item in the AutoSound™ menu. The factory-set options are Speech, Music, Movies, and Multimedia, each corresponding with specific settings of treble and bass. You can also select the Personal option, which is based on the adjustments you make through the Sound menu. (See page 46 in the *Directions for Use*.)

Active Control™ Plus

NOTE: Active Control™ Plus is not available for use with the AV3, AV4, AV5, and AV6 input sources.

Press to toggle the options Off, Minimum, Medium, and Maximum.

Maximum is the recommended option. (See page 28 in the *Directions for Use* manual.)

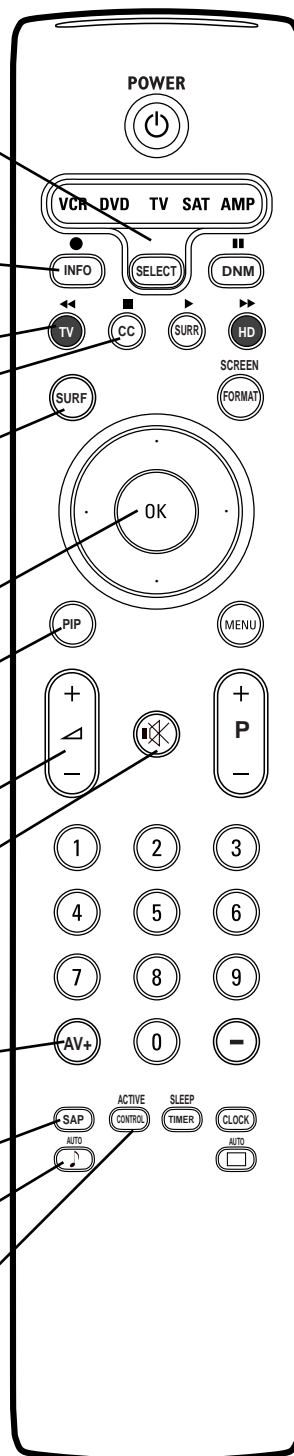

Active Control, AutoSurf, Incredible Surround, are trademarks of Philips Consumer Electronics. Copyright 2004 Philips Consumer Electronics. All rights reserved.

*Manufactured under license from Dolby Laboratories. "Dolby" and the double-D symbol are trademarks of Dolby Laboratories.

Remote Control Buttons

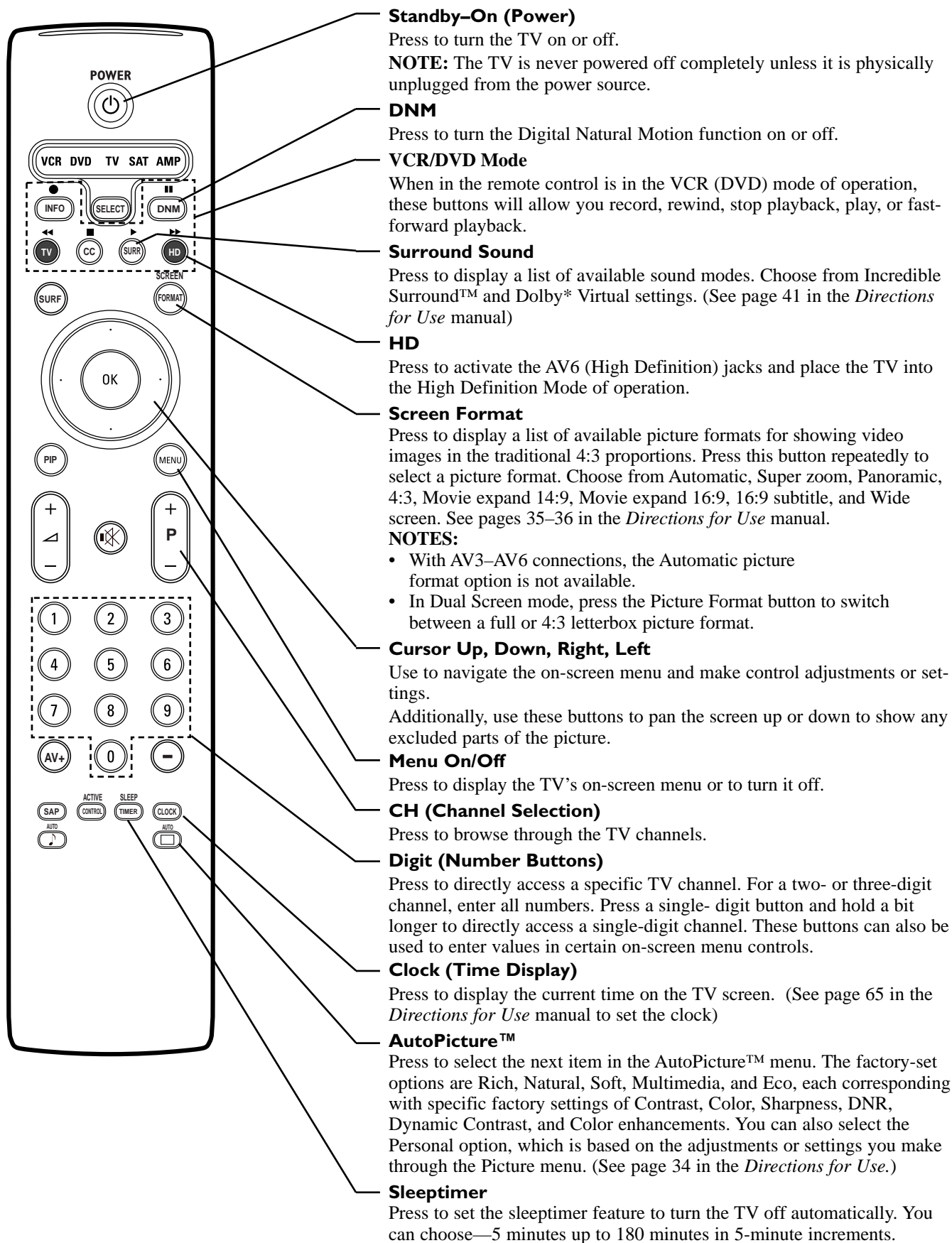



Programming the Remote Control

Your TV remote control can operate accessory devices such as cable boxes, VCRs, DVD players, satellite receivers, and amplifiers.

Normally, the remote is in TV mode. You must press the Select button to switch the remote to one of the accessory modes—CBL, VCR, DVD, SAT, or AMP.

It is likely you will need to program your remote, but, before you do, try this test:

- Press the Select button repeatedly until the mode you desire lights up. When the light begins blinking, point the remote toward the accessory device, then press the Standby-On button. If the device responds you do not need to program the remote. If not, follow the steps below to program the remote.

1 Look up the number for the device on the list below:

- 1 Cable (CBL)
- 2 VCR
- 3 DVD
- 4 Satellite (SAT)
- 5 Amplifier (AMP)

Look up the number for the manufacturer on pages 24–25.

2 Press the Select and Standby-On buttons at the same time, then release.

3 Press the number for the device followed by the manufacturer's code. The green Standby-On light will blink, indicating the code is valid. If the light does not blink, start again at step 1 using another code (if available).

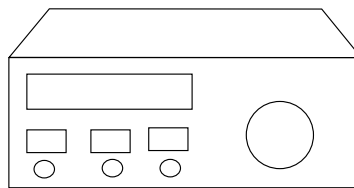

AMP

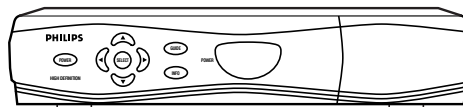

SAT



DVD

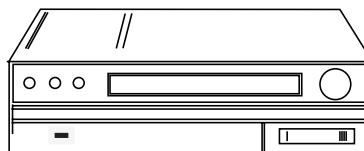

VCR

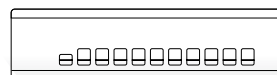

CBL

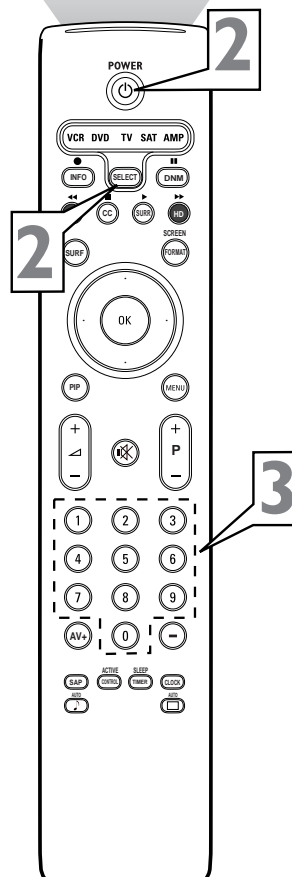

Programming the Remote Control



Now try to use the remote control with the accessory device to see if it is correctly programmed.

4 Press the Select button on the remote to select the type of device. When the mode you desire lights up, stop pressing the button. When the light begins blinking the remote is ready for use with the device.

5 Press the Standby–On button. As long as the light keeps blinking, you can use the remote with the selected device. Once the light disappears, the remote is back in TV mode.

If the device does not respond to the Standby–On command, repeat steps 1–6 using a different code. If there are no other for the type and brand of accessory device, the remote likely will not operate your particular model of accessory device.

NOTE: Your TV remote is not necessarily capable of operating all models of the brands of accessory devices listed on pages 24–25. You may want to try the programming process again. Try using the number(s) that are listed for your type and brand of device to be sure you did not make a mistake in inputting the digits during your first attempt at programming.

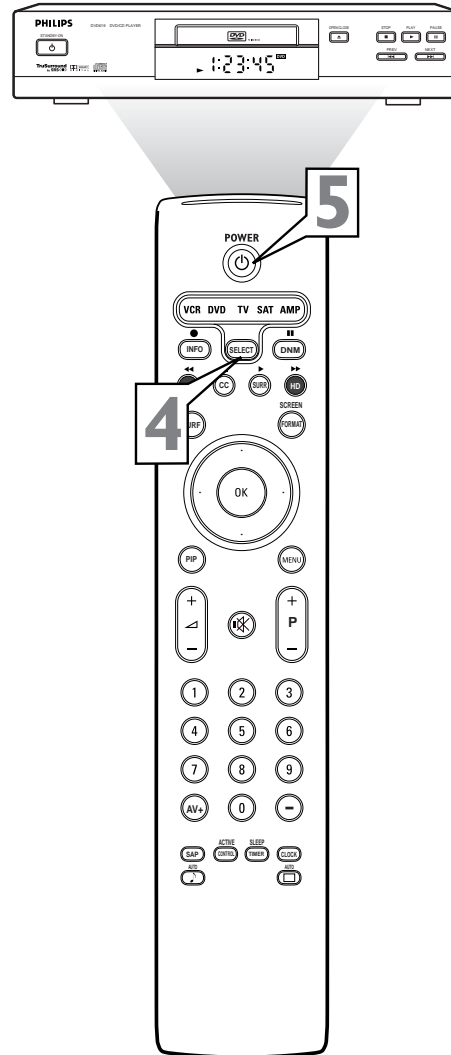

CHECK IT OUT

You can change the duration of the time-out mode by simultaneously pressing the Select button and a digit button, 1–4. Using digit 1 will set the time-out to 15 seconds; digit 2, 30 seconds; digit 3, 60 seconds; and digit 4, 120 seconds. The default time-out setting after you replace the batteries in the remote is 60 seconds. All modes will have the same time-out setting.

HELPFUL HINT

If the remote control is in one of the accessory modes (a mode light is flashing)—CBL, VCR, DVD, SAT, AMP—and you don't press any of the remote buttons for sixty seconds, a "time-out" occurs, returning the remote to TV mode.



Programming the Remote Control: Setup Codes

Amplifier

Carver	.0296
Curtis Mathes	.0327
GE	.0105
JVC	.0358
Linn	.0296
Magnavox	.0296
Marantz	.0296
Optimus	.0422, 0327
Philips	.0296
Pioneer	.0327
Polk Audio	.0296
RCA	.0327
Realistic	.0422
Sony	.0716, 0247
Soundesign	.0105
Victor	.0358
Wards	.0105
Yamaha	.0381

Cable Box

ABC	.0030, 0034, 0035
Allegro	.0180, 0342
Americast	.0926
Archer	.0180, 0824
BellSouth	.0926
Century	.0180
Citizen	.0180, 0342
Comtronics	.0067
Contec	.0046
Emerson	.0824
Everquest	.0042, 0067
Focus	.0427
Garrard	.0180
Gemini	.0042
General Instrument	.0503, 0837
GoldStar	.0067, 0171
Goodmind	.0824
Hamlin	.0047, 0036, 0286, 0061
Hytex	.0034
Jasco	.0042, 0180, 0342
Jerrold	.0030, 0039, 0503, 0042, .0837
Memorex	.0027
Motorola	.1133
Movie Time	.0090
NSC	.0090
Oak	.0046, 0034
Optimus	.0048
Panasonic	.0048, 0134, 0027
Paragon	.0027
Philips	.0180, 0332, 0344
Pioneer	.0171, 0560, 0904
Popular Mechanics	.0427
Pulsar	.0027
Quasar	.0027
RCA	.0048
Radio Shack	.0042, 0910, 0342, 0824
Recoton	.0427
Regal	.0047, 0286
Runco	.0027
SL Marx	.0067
Samsung	.0067, 0171
Scientific Atlanta	.0035, 0504, 0904
Signal	.0042, 0067
Sprucer	.0048
Starcom	.0030, 0042
Stargate	.0067, 0042, 0824
Starquest	.0042
TV86	.0090

Televue	.0067
Tocom	.0039
Toshiba	.0027
Tusa	.0042
Unika	.0180
United Artists	.0034
Universal	.0180, 0218
Viewstar	.0090
Zenith	.0027, 0552, 0926
Zentek	.0427

Surround Sound Receiver

ADC	.0558
Aiwa	.0148
Capetronic	.0558
Carver	.0069, 1116, 1216
Casio	.0222
Clarinet	.0222
Denon	.1187, 1131
Fisher	.0069
Garrard	.0490
Harman/Kardon	.0137
JVC	.0101
Kenwood	.1054, 0069, 0213, 1340 .1596, 1597
Lloyd's	.0222
MCS	.0066
Magnavox	.0418, 1116, 0558, 1216 .0222
Marantz	.1116, 1216, 0066
Modulaire	.0222
Nakamichi	.0124
Onkyo	.0162
Optimus	.1050, 0213, 0558, 0069
Panasonic	.0066, 1545
Penney	.0222
Philips	.1116, 1216, 1296, 0418
Pioneer	.0177, 0558, 1050
Proscan	.1281
Quasar	.0066
RCA	.1281, 0558, 1050
Realistic	.0222
Sansui	.1116
Sharp	.0213
Sherwood	.0529
Sony	.1185, 1085, 1285
Sunfire	.1340
Teac	.0490
Technics	.0066, 1335, 1545, 1336
Thorens	.1216
Victor	.0101
Yamaha	.0203, 0213, 1203
Yorx	.0222

Satellite Receiver

AlphaStar	.0799
Echostar	.1032, 0802
Expressvu	.0802
GE	.0593
General Instrument	.0388, 0896, 0654
HTS	.0802
Hitachi	.0846
Hughes Network Systems	.0776
JVC	.0802
Jerrold	.0388, 0654
Magnavox	.0749, 0751
Memorex	.0751
Next Level	.0896
Panasonic	.0728
Philips	.1103, 0749, 0751
Primestar	.0654, 0388

RCA	.0593, 0170, 0419, 0882
Radio Shack	.0896
Samsung	.1136
Sony	.0666
Star Choice	.0896
Toshiba	.0776, 0817
Uniden	.0751, 0749
Zenith	.0883

VCR

Admiral	.0075, 0236
Adventura	.0027
Aiko	.0305
Aiwa	.0027, 0064
Akai	.0068
America Action	.0305
American High	.0062
Asha	.0267
Audiovox	.0064
Beaumarck	.0267
Bell & Howell	.0131
Broksonic	.0148, 0211, 0029, 0236, 0506
CCE	.0099, 0305
Calix	.0064
Canon	.0062
Carver	.0108
Cineral	.0305
Citizen	.0305, 0064
Colt	.0099
Craig	.0064, 0099, 0074, 0267, 0298
Curtis Mathes	.0062, 0068, 0087, 0189 .0787
Cybernex	.0267
Daewoo	.0305, 0072
Denon	.0069
Dynatech	.0027
Electrohome	.0064
Electroponic	.0064
Emerex	.0059
Emerson	.0211, 0029, 0236, 0305, .0148, 0506, 0027, 0064, .0070
Fisher	.0074, 0131
Fuji	.0062
Funai	.0027
GE	.0062, 0087, 0075, 0267, .0787
Garrard	.0027
Go Video	.0459, 0553
GoldStar	.0064, 0065
Gradiente	.0027
HI-Q	.0074
Harley Davidson	.0027
Harman/Kardon	.0065, 0108
Harwood	.0099
Hitachi	.0069, 0027, 0068
Hughes Network Systems	.0069
JVC	.0094, 0068
Jensen	.0068
KEC	.0064, 0305
KLH	.0099
Kenwood	.0068, 0094, 0065
Kodak	.0062, 0064
LXI	.0064
Lloyd's	.0027
Logik	.0099
MEI	.0062
MGA	.0070, 0267
MGN Technology	.0267
MTC	.0027, 0267
Magnasonic	.0305
Magnavox	.0062, 0108, 0027, 0066, 0176

Programming the Remote Control: Setup Codes



VCR (continued)

Magnin	.0267	Realistic	.0027, 0131, 0074, 0075, .0064, 0062	XR-1000	.0099, 0027, 0062
Marantz	.0108, 0062	ReplayTV	.0641, 0643	Yamaha	.0065
Marta	.0064	Runco	.0066	Zenith	.0066, 0027, 0236, 0506
Matsushita	.0062, 0189	STS	.0069		
Memorex	.0131, 0074, 0506, 0027	Samsung	.0072, 0267		
	.0064, 0075, 0062, 0267	Sanky	.0066, 0075		
	.0066, 0189, 0236, 1189	Sansui	.0068, 0506, 0027, 0094, 0236, 0298		
Minolta	.0069	Sanyo	.0074, 0131, 0267		
Mitsubishi	.0070, 0075, 0094	Scott	.0211, 0148, 0070, 0072		
Motorola	.0062, 0075	Sears	.0064, 0069, 0027, 0062, .0074, 0131		
Multitech	.0027, 0099	Semp	.0072		
NEC	.0065, 0068, 0094, 0131	Sharp	.0075		
Nikko	.0064	Shintom	.0099		
Noblex	.0267	Shogun	.0267		
Olympus	.0062	Singer	.0099		
Optimus	.0189, 1189, 0075, 0064, .0131, 0459	Sony	.0059, 0027, 0062, 0063		
Orion	.0506, 0029, 0211, 0236	Sylvania	.0062, 0108, 0027, 0070		
Panasonic	.0062, 0189, 1189, 0643	Symphonic	.0027		
Penney	.0062, 0267, 0064, 0069, 0065	TMK	.0267		
Pentax	.0069	Tatung	.0068		
Philco	.0062, 0236, 0506	Teac	.0027, 0068		
Philips	.0108, 0062, 0645	Technics	.0062, 0189		
Pilot	.0064	Teknika	.0027, 0062, 0064		
Pioneer	.0094	Thomas	.0027		
Polk Audio	.0108	Tivo	.0645, 0663		
Profitronic	.0267	Toshiba	.0072, 0070		
Proscan	.0087, 0787	Totevision	.0064, 0267		
Protec	.0099	Unitech	.0267		
Pulsar	.0066	Vector	.0072		
Quasar	.0062, 0189, 1189	Vector Research	.0065		
RCA	.0087, 0176, 0069, 0062, .0075, 0267, 0787	Video Concepts	.0072		
Radio Shack	.0027	Videosonic	.0267		
Radix	.0064	Wards	.0062, 0087, 0027, 0074, .0267, 0069, 0075, 0099		
Randex	.0064		.0108, 0176, 0787		
		White Westinghouse	.0099, 0305, 0236		

Digital Video Disc (DVD)

Apex	.0699
Denon	.0517
Fisher	.0697
GE	.0549
Hitachi	.0691
Hiteker	.0699
JVC	.0650, 0585
Kenwood	.0709, 0561
Konka	.0746, 0738, 0747, 0748
Magnavox	.0530, 0702
Marantz	.0566
Mitsubishi	.0548
Onkyo	.0530
Optimus	.0598
Oritron	.0678
Panasonic	.0517, 0659
Philips	.0566, 0530
Pioneer	.0598, 0552, 0659
Proscan	.0549
RCA	.0549, 0598
Samsung	.0600
Sharp	.0657
Sony	.0560
Technics	.0517
Theta Digita	.0598
Toshiba	.0530
Yamaha	.0517, 0572
Zenith	.0618, 0530



Operating Accessory Devices with the TV Remote

Once you have programmed your TV remote, refer to page 27 to see how the remote functions with accessory devices.

Before the remote will operate an accessory device, you must select the correct mode: CBL (cable box), VCR, DVD, SAT (satellite), or AMP (amplifier).

- 1 Press the Select button to cycle through the accessory modes. When the mode you want lights up, stop pressing the button. After a few seconds, the light will begin blinking. The blinking means that the remote is in the accessory mode you have selected.

NOTE: The remote is in accessory mode as long as the light keeps blinking. If you do not use the remote for 60 seconds the light will switch off, and the TV will go back to TV mode. The 60-second timer restarts each time you use the remote in an accessory mode.

- 2 Point the front of the remote toward the front of the accessory device, then press the button to perform the desired function.

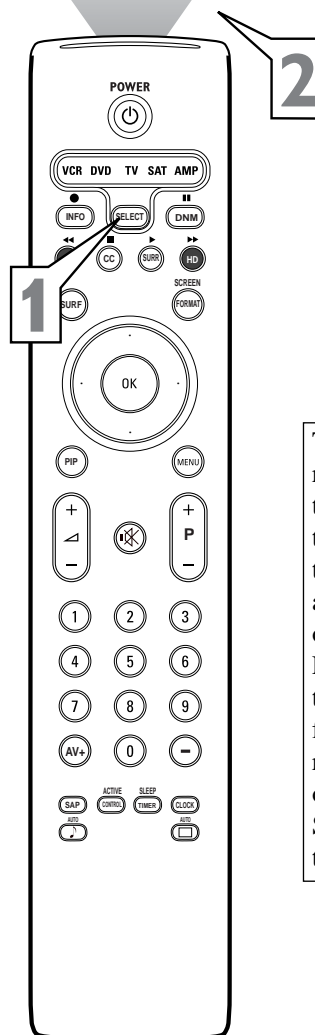
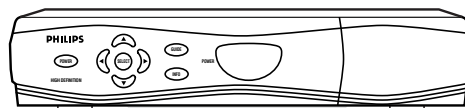

Point the front of the remote toward the front of the accessory device, then press the necessary buttons to perform the functions you desire. Refer to pages 27 to see the functions of the buttons in the respective accessory modes.

To backlight the remote control buttons, press and hold the Select button for two seconds. If you do not press any remote buttons for five seconds, the backlight switches off. Each time you press a remote button while the backlight is on, the five-second time-out function is reset. After the backlight switches off, you must press and hold the Select button for two seconds to turn it back on.



HELPFUL HINT

- Press the Select button once to return the remote to the TV mode.
- Press the Select Button twice to select another device by cycling through the accessory mode choices.

✓ CHECK IT OUT

You can change the duration of the time-out mode by simultaneously pressing the Select button and a digit button, 1–4. Using digit 1 will set the time-out to 15 seconds; digit 2, 30 seconds; digit 3, 60 seconds; and digit 4, 120 seconds. The default time-out setting after you replace the batteries in the remote is 60 seconds. All modes will have the same time-out setting.

Operating Accessory Devices with the TV Remote



VCR Mode

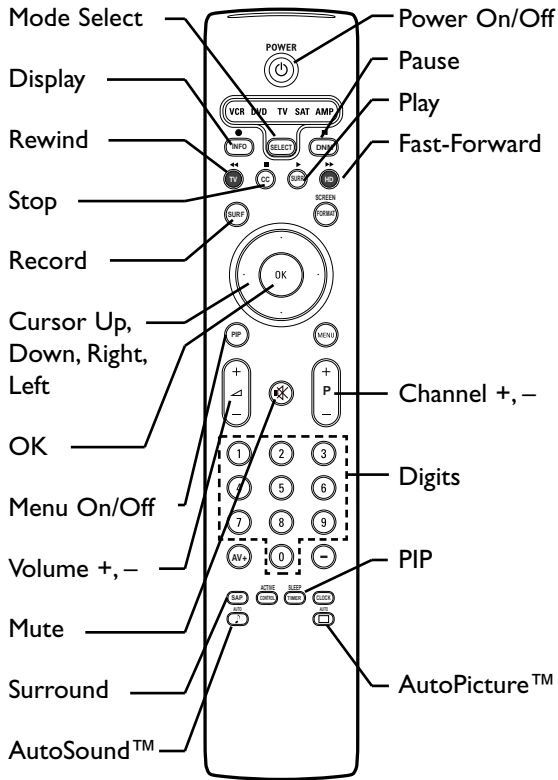

*Point remote at TV when using this button.

DVD Mode

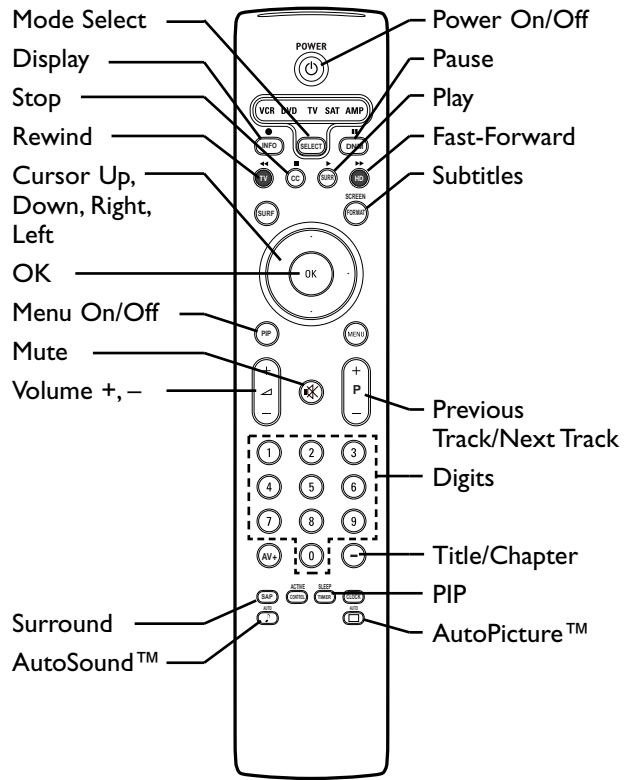

*Point remote at TV when using this button.

SAT Mode

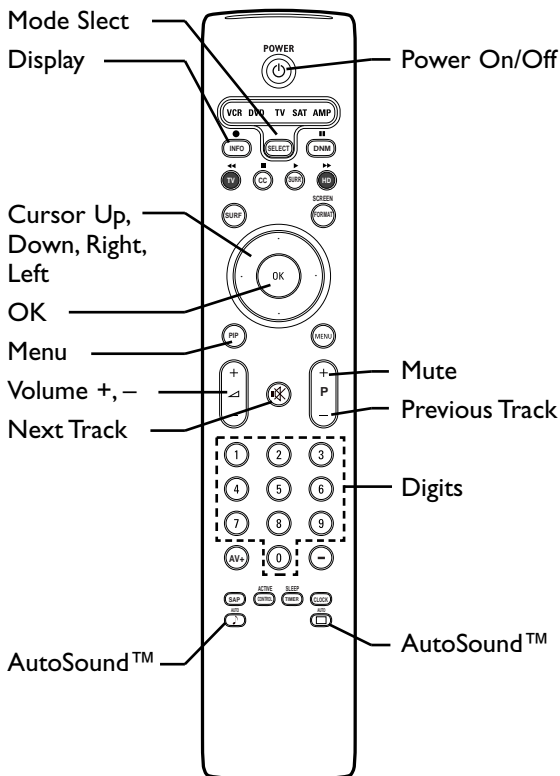

*Point remote at TV when using this button.

AMP Mode

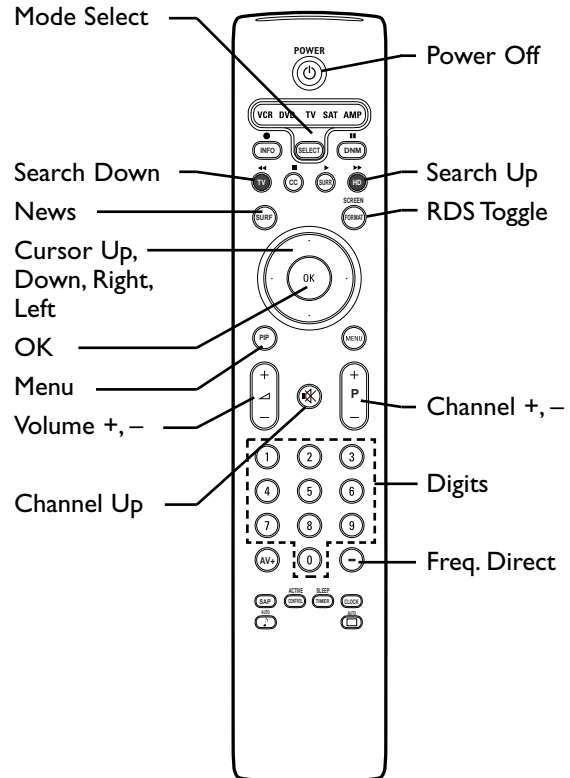

*Point remote at TV when using this button.



Using Active Control™ Plus

Active Control™ Plus monitors incoming video signals from the Tuner, AV1, AV2, and Side inputs and adjusts key picture settings for best picture quality. In addition to measuring picture noise, this feature uses an ambient light sensor (located on the front of the TV) to adjust the picture settings according to viewing conditions in the room. When you choose to turn Active Control™ Plus on, you have the options Minimum, Medium, or Maximum. Maximum is the recommended option.

NOTE: Active Control™ Plus is disabled with the AV3–AV6 input sources.

- 1** Press the Active Control™ button on the remote control to display the “Active Control” menu.
- 2** Press the Cursor Up or Down button to select one of the options: “Minimum,” “Medium,” “Maximum,” or “Off.”
- 3** Press the Cursor Right button to display the Active Control™ information window. You will notice how the values constantly change while Active Control™ is working.
- 4** Press the OK button to return to the Active Control Menu or the Menu button to remove the on-screen menu from the TV screen.

HELPFUL HINTS

Active Control™ Plus Settings

Minimum—Sharpness, Dynamic Contrast, and Noise Reduction are controlled automatically.

Medium—Sharpness, Color, Dynamic Contrast, and Noise Reduction are controlled automatically.

Maximum—Sharpness, Color, Dynamic Contrast, Noise Reduction, and Contrast are controlled automatically.

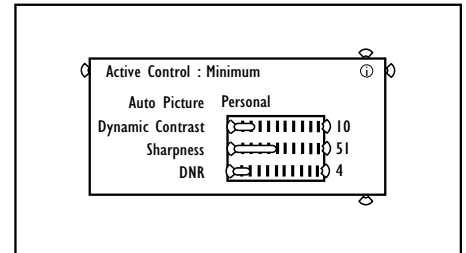
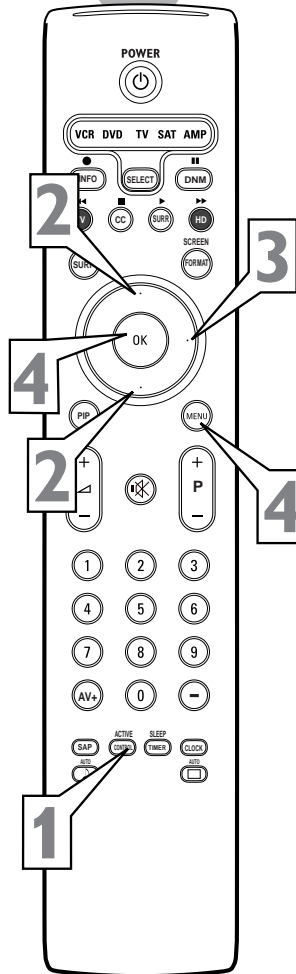
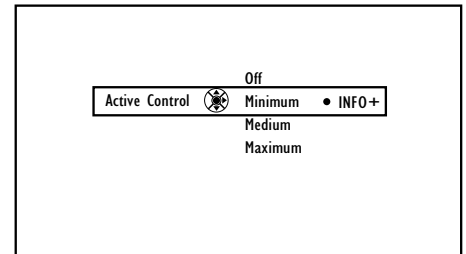
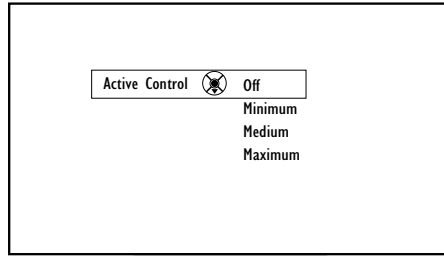

Selecting an AutoPicture™ Option



Whether you're watching a movie or playing a video game, your TV has automatic video control settings to match your current program source or content. AutoPicture™ quickly resets your TV's video controls for a number of different types of programs and viewing conditions that you may have in your home. The Personal AutoPicture™ settings are the same as the Picture control adjustments made within the on-screen menu.

- 1** Press the Menu button on the remote to display the on-screen menu.
- 2** Press the Cursor Right button to select "Picture."
- 3** Press the Cursor Down button repeatedly until the "Auto picture" control is selected.
- 4** Press the Cursor Right button to enter the AutoPicture™ submenu.
- 5** Press the Cursor Down or Up button to select one of the AutoPicture™ options: "Personal," "Rich," "Natural," "Soft," "Multimedia," or "Eco."
- 6** Press the Menu button to remove the on-screen menu from the TV screen.
- 7** You can also select the AutoPicture™ settings directly by pressing the AutoPicture™ button on the remote control.

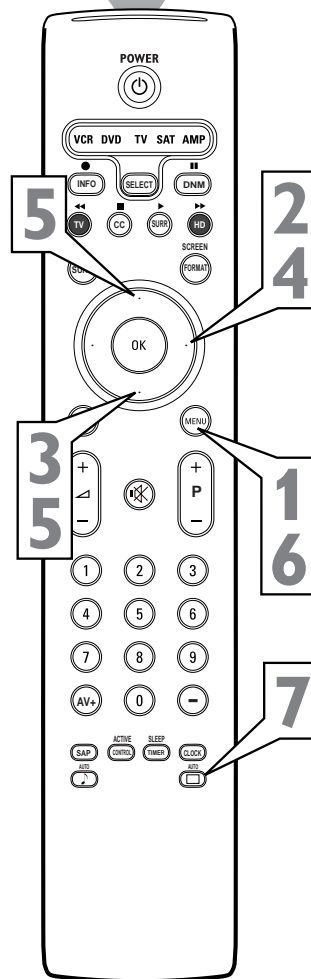
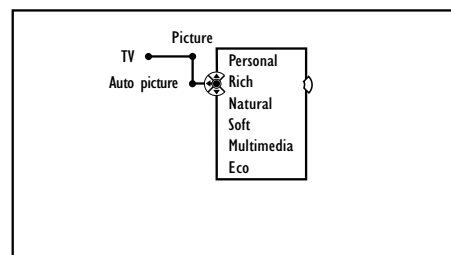
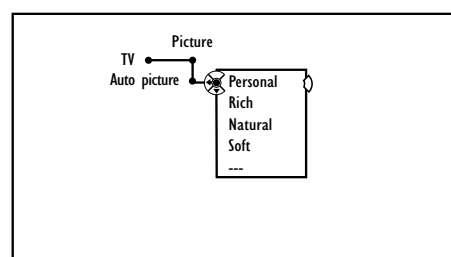
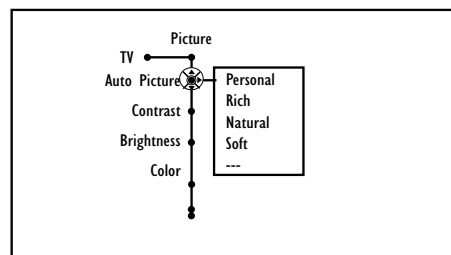
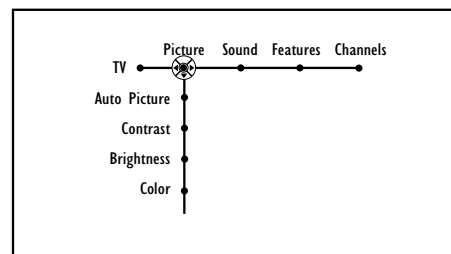
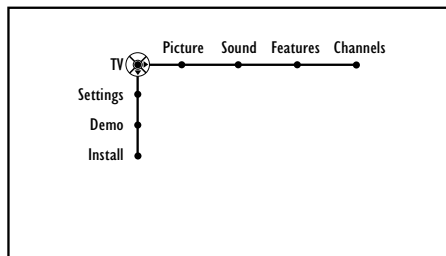

HELPFUL HINTS

AutoPicture™ Options

Personal settings are based on your personal choice or viewer control preferences.

Rich emphasizes very vibrant colors. (This is a good choice when AV mode is used in a brightly lighted room.)

Natural sets picture controls at mid-level settings for consistent viewing conditions.

Soft emphasizes warm colors. (This is a good choice for dimly lighted room. It gives a cinema-like effect when the light is switched off.)

NOTE: This option can also be used with the PixelPlus™ control to soften the appearance of harsh screen elements that can show with certain types of DVD playback conditions. See page 30 for information about PixelPlus™.

Multimedia emphasizes soft colors. (This is a good choice for playing computer games, for example.)

B&W optimizes brightness and contrast settings for viewing black and white programs.

NOTE: The Personal option shows the personal settings made in the Picture submenu. When you select one of the preset AutoPicture™ options, those settings become the Personal settings.

Adjusting/Setting the Picture Controls

To adjust your TV picture controls, select a channel and follow these steps.

- 1** Press the Menu button on the remote control to show the on-screen menu.
- 2** Press the Cursor Right button to select "Picture."
- 3** Press the Cursor Down button to select one of the picture adjustments: "Contrast," "Brightness," "Color," "Sharpness," "Color temperature," or "Tint."

NOTE: The menu will show only four items at a time, so you will need to continue scrolling with the Cursor Down button to adjust the color temperature and tint.

- 4** Press the Cursor Left or Cursor Right button to adjust the selected control. Or, if color temperature is chosen, press the Cursor Right button to choose from the options "Normal," "Warm," or "Cool."
- 5** Press the Menu button to remove the on-screen menu from the TV screen.

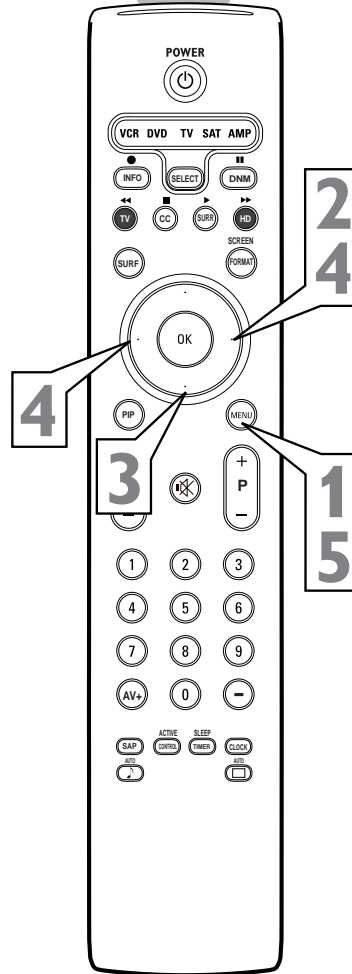
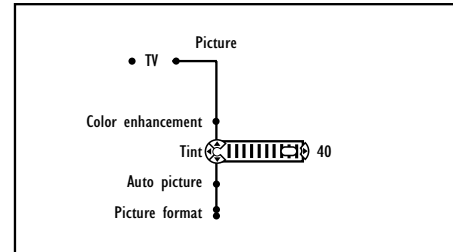
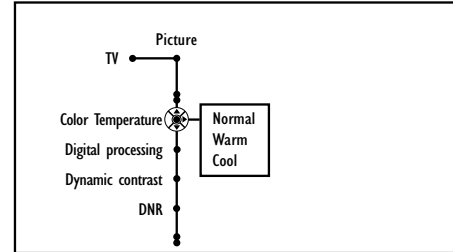
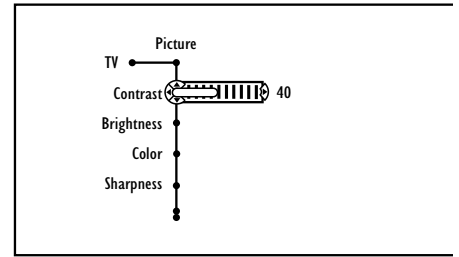
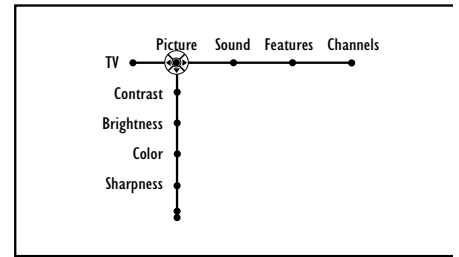
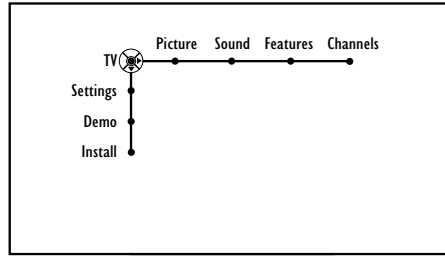

HELPFUL HINTS

- The tint control is not available with the AV3 - AV6 input sources.
- Picture Control Settings**
- **Brightness** adds or subtracts light from the darkest part of the picture.
 - **Color** adds or eliminates color.
 - **Sharpness** improves the detail in the picture.
 - **Tint** adjusts the picture to obtain natural skin tones.
 - **Color temperature** offers "Normal," "Cool," or "Warm" picture preferences.
 - **Normal** keeps whites, white.
 - **Cool** makes whites, bluish.
 - **Warm** makes whites, reddish.

Selecting a Digital Processing Option



The Digital Processing control gives you a choice of different picture scanning modes.

Progressive Scan doubles the number of picture lines, eliminating line flicker and providing a jitter-free picture.

Movie Plus provides motion compensation to increase clarity around moving images in the picture.

- 1** Press the Menu button on the remote to display the on-screen menu.
- 2** Press the Cursor Right button to select "Picture."
- 3** Press the Cursor Down button repeatedly until the "Digital processing" control is selected.
- 4** Press the Cursor Right button to enter the digital processing submenu.
- 5** Press the Cursor Up or Down button to select Progressive Scan, or Movie Plus.
- 6** Press the Menu button to remove the on-screen menu from the TV screen.

HELPFUL HINT

The Digital Processing control is not available for use with the AV3, AV4, AV5, or AV6 input sources.

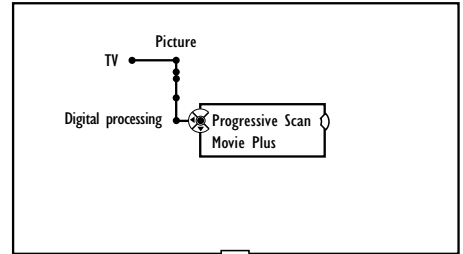
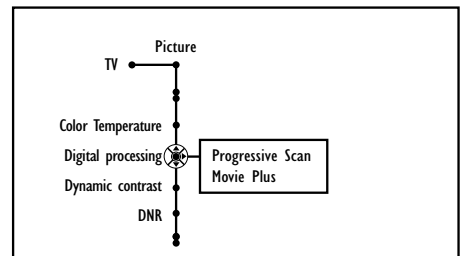
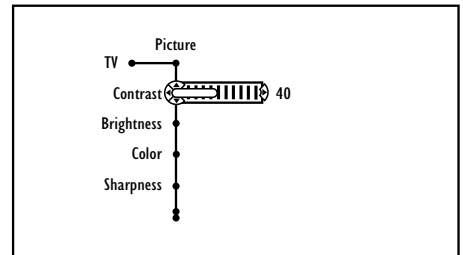
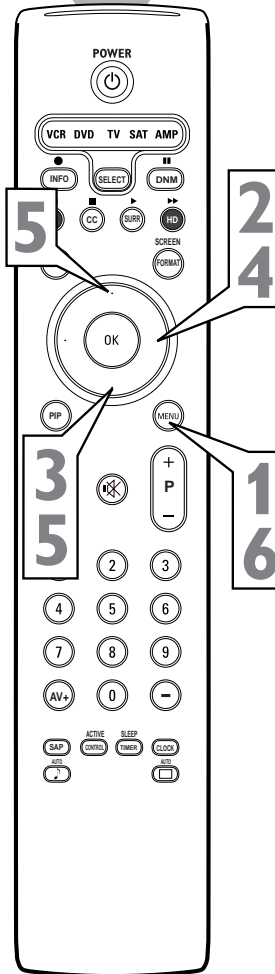
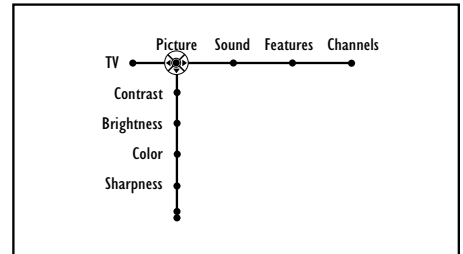
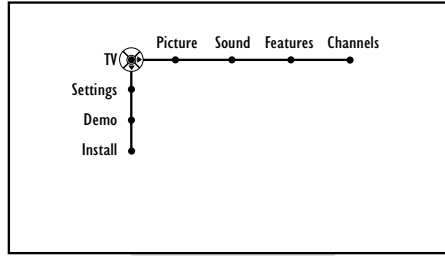

OR

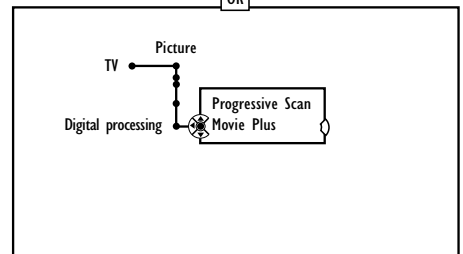

Selecting a Dynamic Contrast Option

The Dynamic Contrast control allows you to sharpen the picture quality by making dark portions of the picture darker and light portions of the picture more noticeable. Normally, you will probably want to select Medium. In certain circumstances, however, you may prefer Minimum or Maximum.

- 1** Press the Menu button on the remote to display the on-screen menu.
- 2** Press the Cursor Right button to select Picture.
- 3** Press the Cursor Down button repeatedly until the “Dynamic contrast” control is selected.
- 4** Press the Cursor Right button to enter the Dynamic Contrast submenu.
- 5** Press the Cursor Up or Down button to select one of the Dynamic Contrast options: “Off,” “Minimum,” “Medium,” or “Maximum.”
- 6** Press the Menu button to remove the on-screen menu from the TV screen.

HELPFUL HINT

The Dynamic Contrast control is not available for use with input sources AV3–AV6.

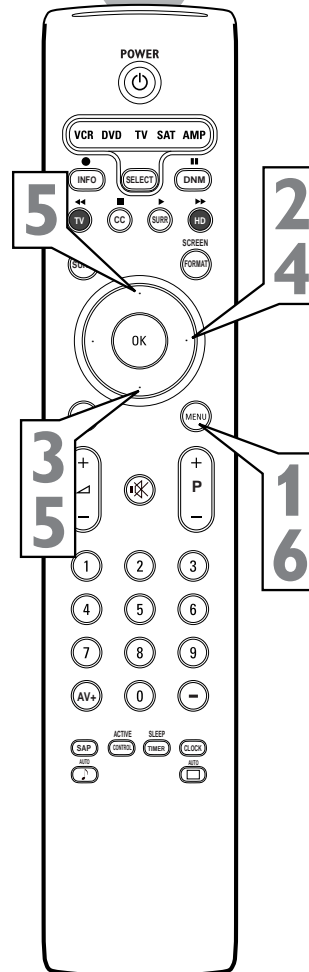
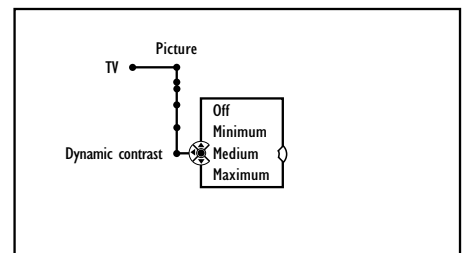
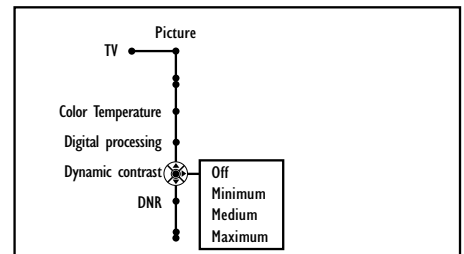
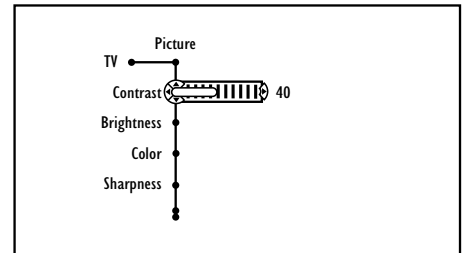
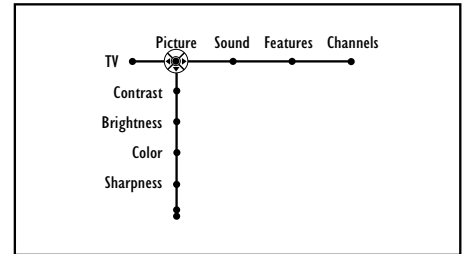
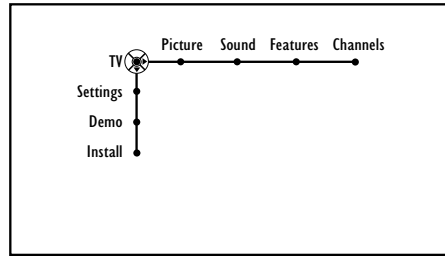

Selecting a DNR (Dynamic Noise Reduction) Option



For many reasons, one of which is poor cable reception, the picture can sometimes appear slightly “speckled” (an indication of signal noise in the picture). The DNR (Dynamic Noise Reduction) control can help eliminate this type of interference and improve the quality of the picture.

- 1** Press the Menu button on the remote to display the on-screen menu.
- 2** Press the Cursor Right button to select “Picture.”
- 3** Press the Cursor Down button repeatedly until the DNR control is selected.
- 4** Press the Cursor Right button to enter the DNR submenu.
- 5** Press the Cursor Up or Down button to select one of the DNR options: Off, Minimum, Medium, or Maximum.
- 6** Press the Menu button to remove the on-screen menu from the TV screen.

HELPFUL HINT

DNR is not available for use with input sources AV3–AV6.

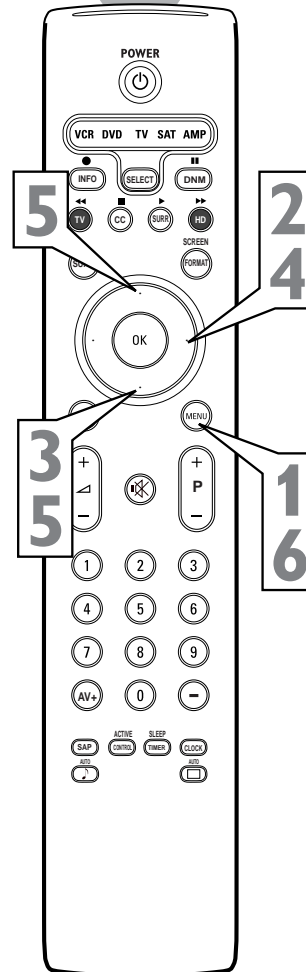
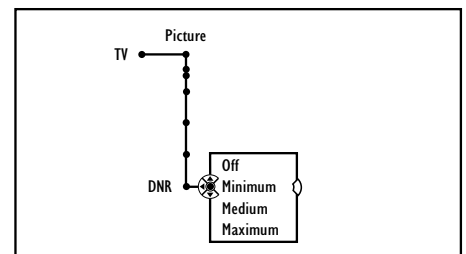
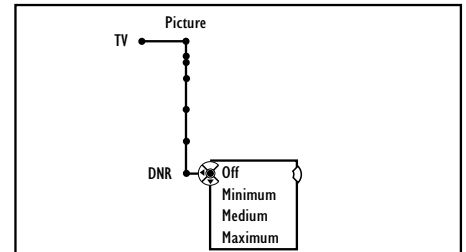
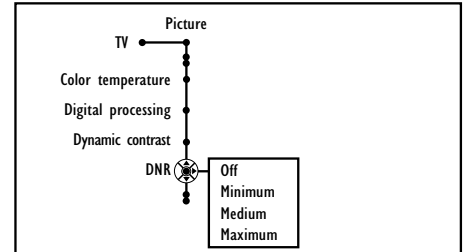
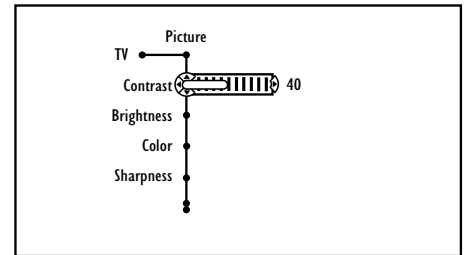
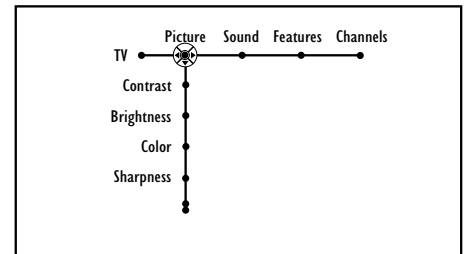
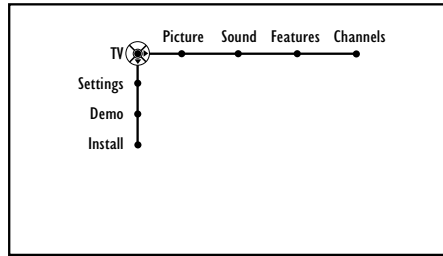



Turning on Color Enhancement

The Color Enhancement control can improve the picture quality of pictures with a high saturation of color. This control works in four ways:

Dynamic Blue Stretch corrects the white colors toward a more bluish-colored white without changing the other colors. Improves the sharpness of the picture.

Green Enhancement offers a more saturated green color in case of low green broadcasts, giving landscapes a fresher and brighter look.

Color-dependent Sharpness improves the sharpness of the picture through the color information. Gives the picture more details, especially in red colors.

Skin-tone Correction adjusts for over saturation of red that often appears in skin tones.

- 1** Press the Menu button on the remote to display the on-screen menu.
- 2** Press the Cursor Right button to select "Picture."
- 3** Press the Cursor Down button repeatedly until the "Color enhancement" control is selected.
- 4** Press the Cursor Right button to turn the color enhancement control on or off.
- 5** Press the Menu button to remove the on-screen menu from the TV screen.

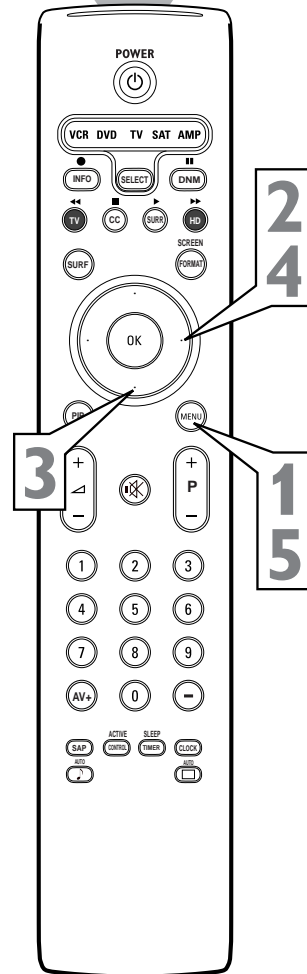
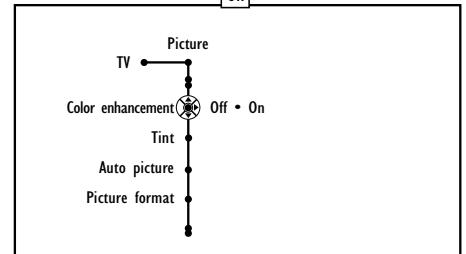
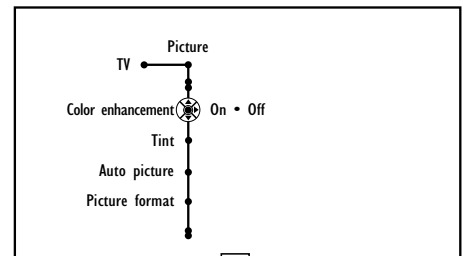
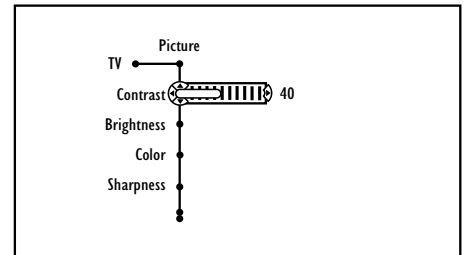
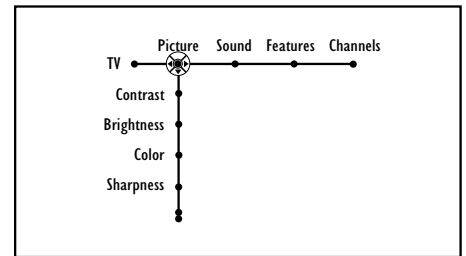
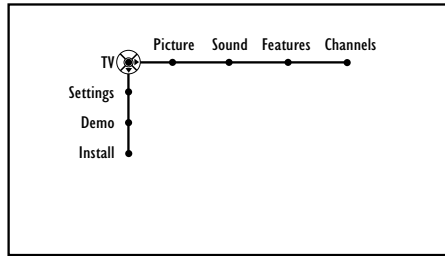

HELPFUL HINT

The color enhancement control is not available for use with inputs AV3–AV6.

Selecting a Picture Format Option



Your TV's wide screen (16:9 aspect ratio) delivers a home-cinema experience that isn't possible with a conventional (4:3 aspect ratio) set. The 16:9 format of high-definition (HD) programs and other widescreen-format video sources appear more lifelike, dramatic, and theatrical. Black or gray bars are diminished or eliminated. As the television industry moves toward the high-definition format standard and more HD broadcasts become available, you will be able to see the broadcasts as they were intended—in 16:9 format.

For flexibility in viewing conventional 4:3-format video sources on your TV's wide screen, you have the options Automatic, "Super zoom," "Panoramic," "4:3," "Movie expand 14:9," "Movie expand 16:9," "16:9 subtitle," or "Wide screen."

NOTE: The Automatic picture format is disabled for AV3–AV6.

Page 36 explains how to select a picture format option.

CHECK IT OUT

Inputs AV3–AV4 allow horizontal and vertical picture panning using the Cursor Left, Right, Up, and Down buttons. The Side input allows vertical picture panning; left and right panning with the Side input is possible when the input has been labeled "Game." See pages 18 and 19 for details on side panel connections and source labeling.

HELPFUL HINT

The term *aspect ratio* refers to the relationship between the width and height of a TV screen. Historically, TV screen width has been 33 percent greater than its height, amounting to a 4:3 aspect ratio. The width of your widescreen TV, however, is nearly 80 percent greater than its height, which means its aspect ratio is 16:9. This screen corresponds well with the tendency of the eyes to feel more comfortable with fields of view and action planes that are horizontally oriented. The wide screen is also proportionally truer to the formats in which movies are filmed and presented in theaters. However, many widescreen DVDs will still display black bars to preserve the true theatrical format.

Conventional 4:3 Screen Size

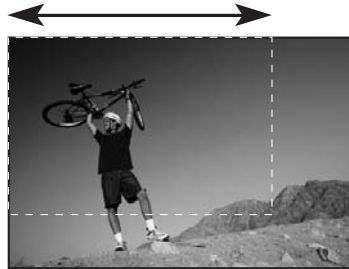

Your TV's 16:9 Screen Size

Your TV's Picture Format Options

Automatic (not depicted)

Makes the picture fill the screen as much as possible when the presence of black or gray bars is detected.



Panoramic

Evenly stretches the edges of the picture to fill the TV's wide screen.



Super zoom

Removes the black or gray bars on the sides of a 4:3-format picture with minimal distortion. Part of the top and bottom portions of the picture are excluded from the screen.



Movie expand 14:9

Expands the picture to 14:9 movie aspect ratio. Part of the top and bottom portions of the picture are excluded from the screen. Black or gray bars are shown at the left and right sides.



4:3

Displays a conventional 4:3 picture without change. Black or gray bars will show at the left and right sides.



16:9 subtitle

Zooms the picture for a full view of subtitles or other information displayed at the bottom of the picture. Part of the top portion of the picture is excluded from the screen.



Movie expand 16:9

Alters the image both horizontally (stretched) and vertically (cropped) to fill the TV's wide screen. Part of the top and bottom portions of the picture will be excluded from the screen.



Wide screen

Evenly stretches the width of the picture to fill the screen.



Selecting a Picture Format Option

Choose a picture format size to match the type of program you're watching. Select the normal 4:3 aspect ratio or a variety of widescreen formats.

- 1** Press the Menu button on the remote to display the on-screen menu.
- 2** Press the Cursor Right button to select "Picture."
- 3** Press the Cursor Down button repeatedly until the "Picture format" control is selected.
- 4** Press the Cursor Right button to enter the picture-format submenu.
- 5** Press the Cursor Down button to select one of the seven screen formats: "Automatic," "Super zoom," "Panoramic," "4:3," "Movie expand 14:9," "Movie expand 16:9," "16:9 subtitle," or "Wide screen." The Automatic option senses the presence of black or gray bars around the picture and zooms the picture to reduce or eliminate the bars.
- 6** Press the Menu button to remove the on-screen menu from the TV screen.
- 7** You can also select a picture format simply by pressing the Screen Format button on the remote control.

NOTE: The Automatic picture format option is not available with AV5 (computer) connections.

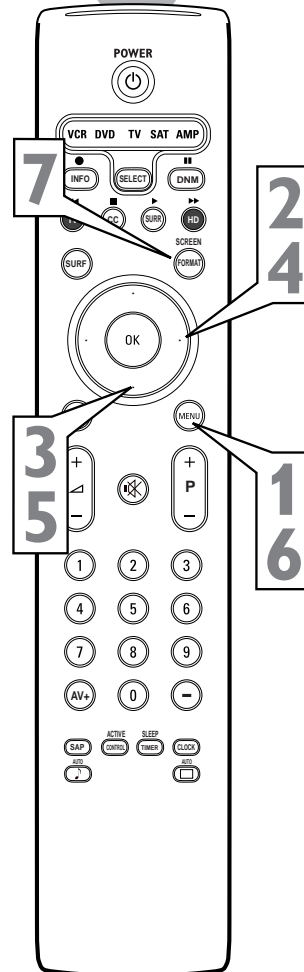
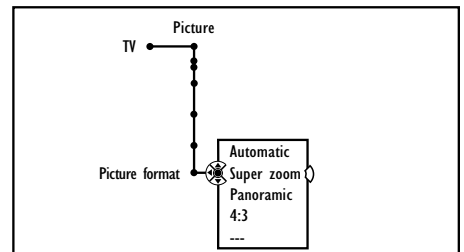
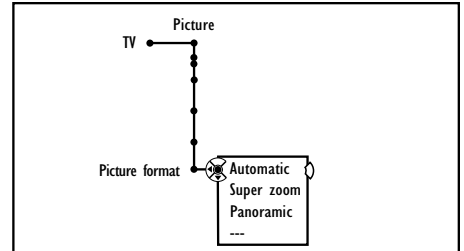
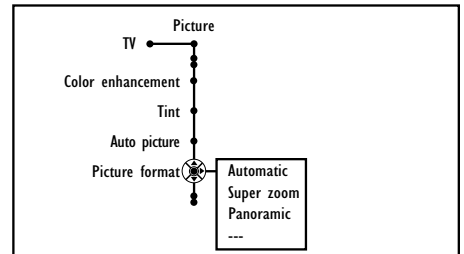
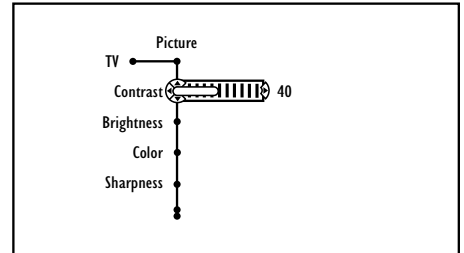
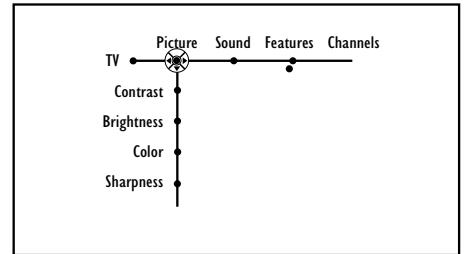
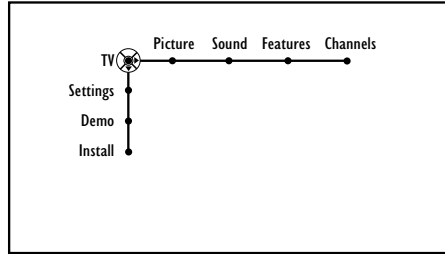

Adjusting the TV and Headphone Volume



Besides the normal volume level control, your TV also has a headphone volume control. This control can be adjusted when using headphones without having to adjust the main volume control for the TV cabinet speakers.

To control the television volume:

- 1** Press the Volume + button on the remote control to increase the television volume level.
- 2** Press the Volume – button on the remote control to decrease the television volume level.

NOTES:

- The Volume scroll will not appear on screen if the on-screen display is set to “Minimum.” See page 62 for details.
- The Volume level can also be adjusted within the on-screen menu. Select the Sound menu and cursor down to the Volume control. Use the Cursor Left and Right buttons to adjust.

To control the Headphone volume:

- 3** Press the Menu button on the remote control to display the on-screen menu.
- 4** Press the Cursor Right button to select “Sound.”
- 5** Press the Cursor Down button repeatedly until the “Headphone volume” control is selected.
- 6** Press the Cursor Right button to increase the headphone volume level.
- 7** Press the Cursor Left button to decrease the headphone volume level.
- 8** Press the Menu button on the remote control to remove the on-screen menu from the TV screen.

Television Volume

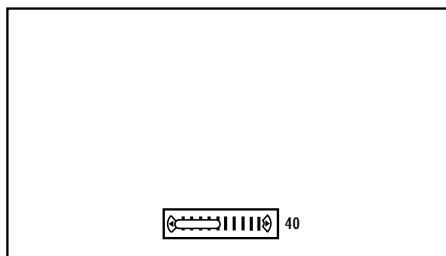

Headphone Volume

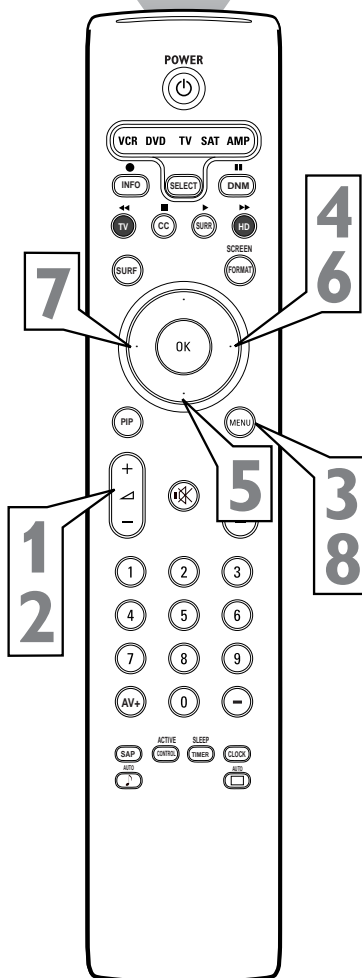
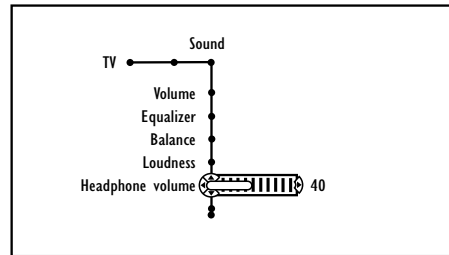
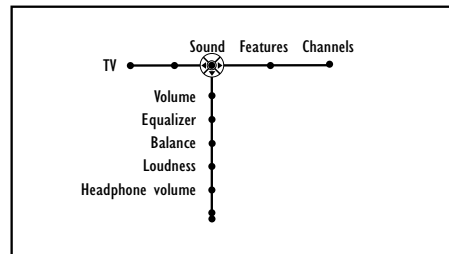
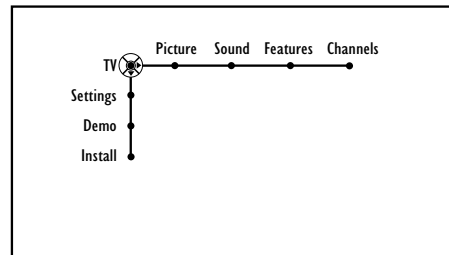

Plug your headphones into the headphone 3.5mm mini-jack in the TV's Side panel.

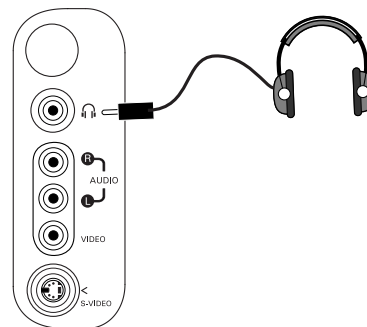



Selecting an AutoSound™ Option

AutoSound™ allows you to select from four factory-set controls and a personal control. The personal control consists of settings you adjust through the on-screen Sound menu. The four factory-set controls—Speech, Music, Movie, or Multimedia—enable you to tailor the TV sound to enhance the particular program you are watching. Follow these steps to select any of the options.

- 1** Press the Menu button on the remote to display the on-screen menu.
- 2** Press the Cursor Right button repeatedly to select “Sound.”
- 3** Press the Cursor Down button repeatedly until the “Auto sound” control is selected.
- 4** Press the Cursor Right button to enter the AutoSound™ submenu.
- 5** Press the Cursor Up or Down button to select an option: “Speech,” “Music,” “Movies,” “Multimedia,” or “Personal.”
- 6** Press the Menu button to remove the on-screen menu from the TV screen.
- 7** You can also select the AutoSound™ settings directly by pressing the AutoSound™ button on the remote control.

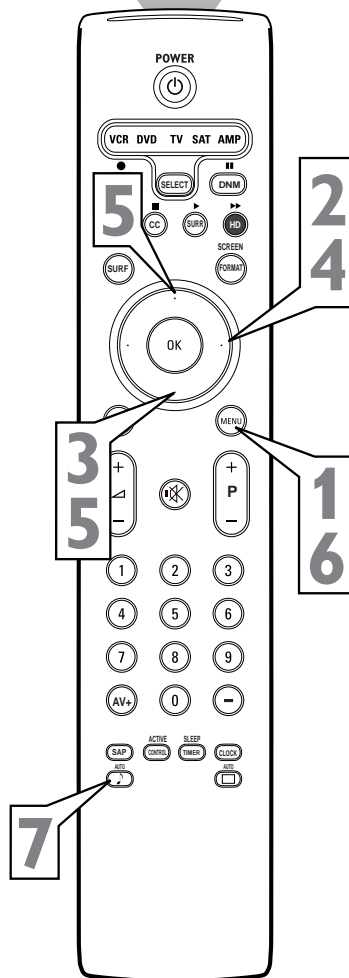
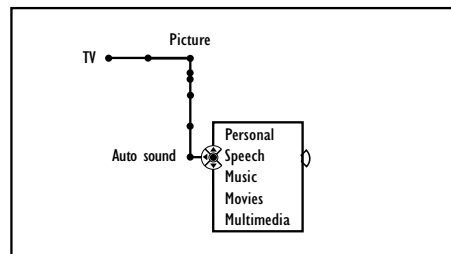
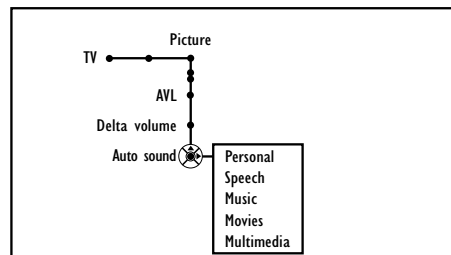
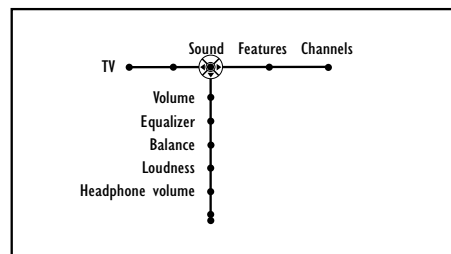
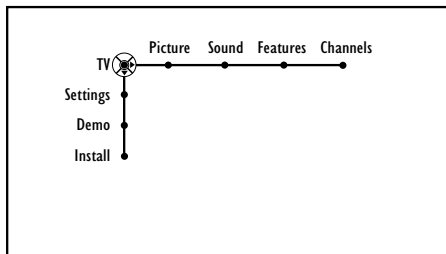

HELPFUL HINTS

AutoSound™ Options

Speech brings voices to the forefront and emphasizes them. Moves music to the background.

Music emphasizes music over voices.

Movies provides a balance between voices and music.

Multimedia provides sound balance best suited for gaming consoles or interactive media.

Personal presents the TV’s sound according to the settings you make within the sound menu.

NOTE: The Personal option shows the personal settings made in the Sound submenu. When you select one of the preset AutoSound™ options, those settings become the Personal settings.

Selecting a TV Equalizer Option



The Equalizer control will change the dynamics of the sound being heard through the TV. You can adjust the settings for the Personal Equalizer option. The other options have been preset at the factory and cannot be changed.

- 1** Press the Menu button on the remote to display the on-screen menu.
- 2** Press the Cursor Right button repeatedly to select "Sound."
- 3** Press the Cursor Down button repeatedly until the "Equalizer" control is selected.
- 4** Press the Cursor Right button to enter the equalizer submenu. Continue to press the Cursor Right button to select one of the options: "Speech," "Music," "Movie," "Multimedia," or "Personal."
- 5** If you select the Personal option and want to make adjustments, press the Cursor Down button to select an adjustment, then press the Cursor Left or Right button to adjust the slider control to the desired position.

NOTE: If you attempt to change the settings for the factory preset options Speech, Music, Movie, or Multimedia, the Equalizer control will default to the Personal option.

- 6** Press the Menu button to remove the on-screen menu from the TV screen.

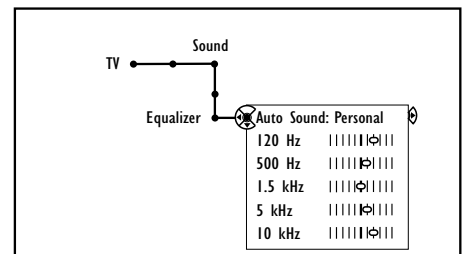
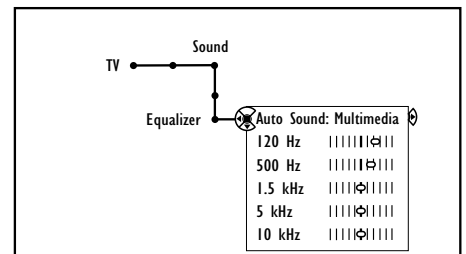
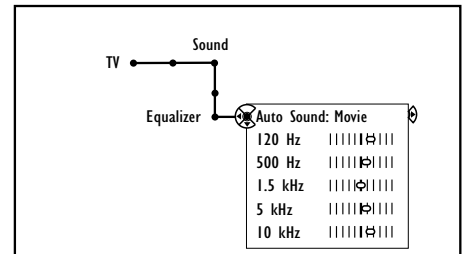
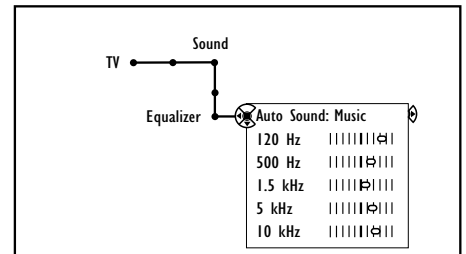
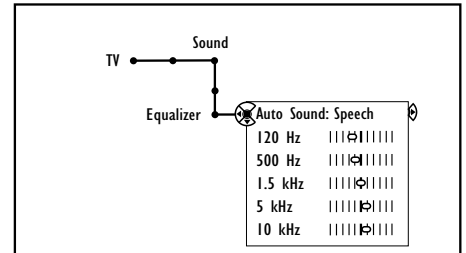
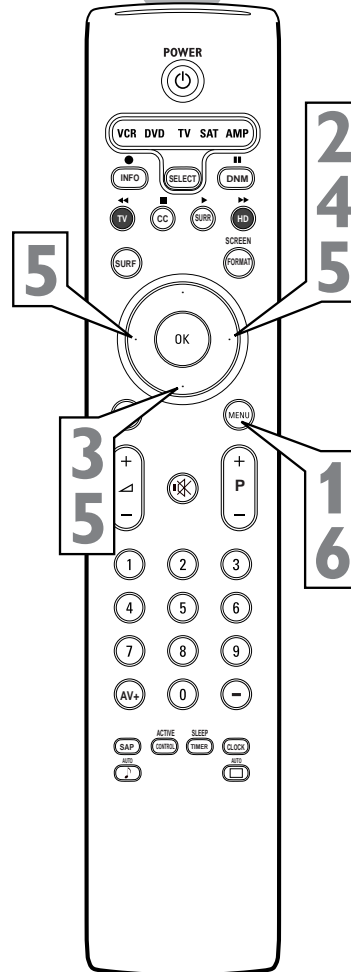
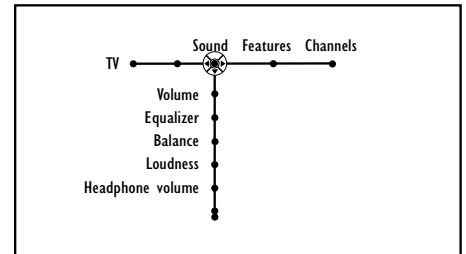
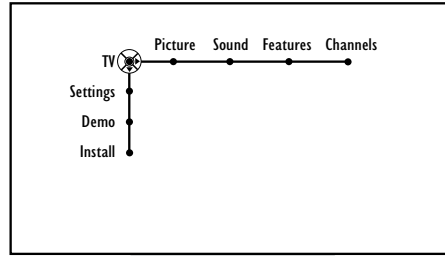



Adjusting TV Speaker Balance

You can adjust the balance of the TV speaker sound.

- 1** Press the Menu button on the remote to display the on-screen menu.
- 2** Press the Cursor Right button repeatedly to select "Sound."
- 3** Press the Cursor Down button repeatedly until the "Balance" control is selected.
- 4** Press the Cursor Right or Left button to adjust speaker balance.
- 5** Press the Menu button to remove the on-screen menu from the TV screen.

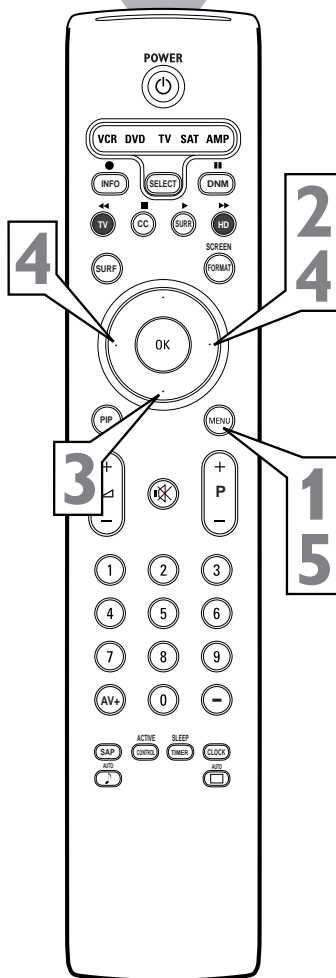
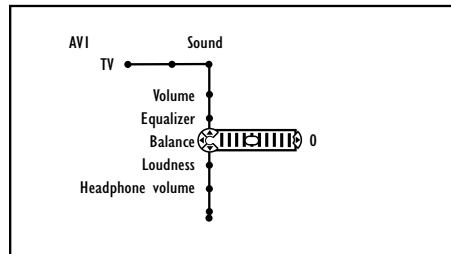
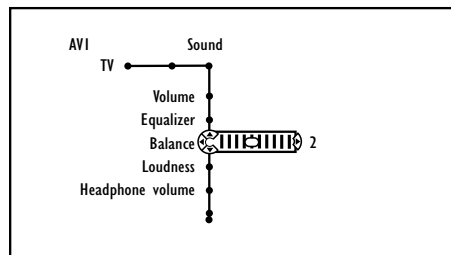
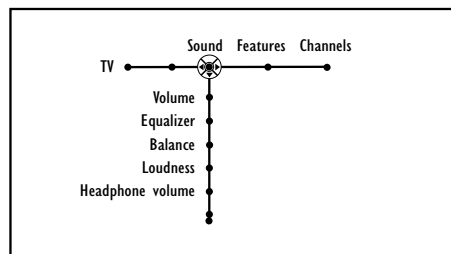
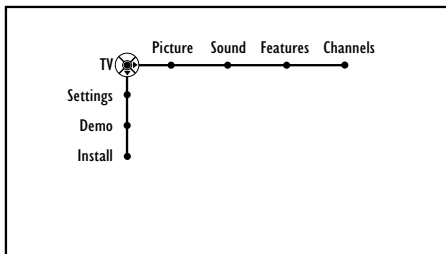

Turning Loudness on or off



Turning the Loudness control on provides a volume-dependent bass-boost effect to the speakers. Follow the steps here to turn the Loudness control on.

- 1** Press the Menu button on the remote to display the on-screen menu.
- 2** Press the Cursor Right button repeatedly to select "Sound."
- 3** Press the Cursor Down button repeatedly until the "Loudness" control is selected.
- 4** Press the Cursor Right to toggle loudness on or off.
- 5** Press the Menu button to remove the on-screen menu from the TV screen.

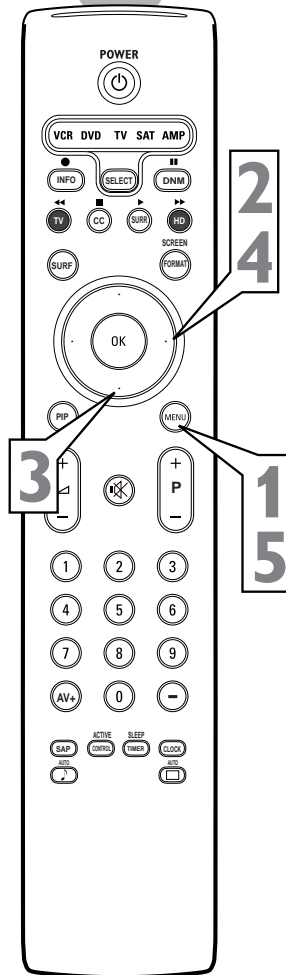
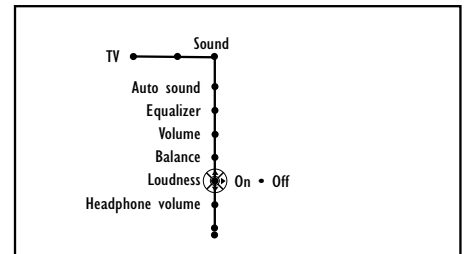
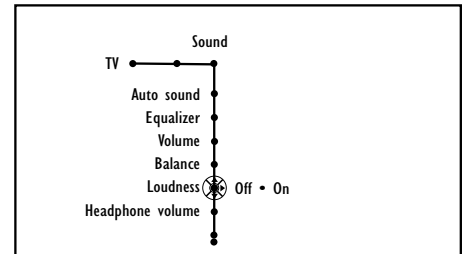
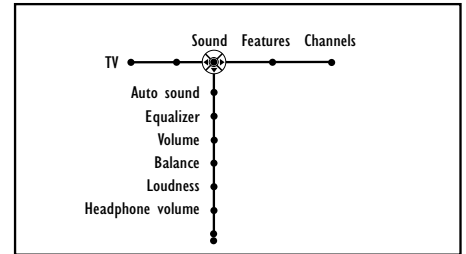
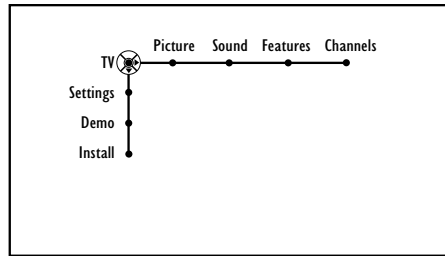



Selecting a Sound Mode Option

The Sound Mode control allows you to place the TV sound into either Incredible Surround™ or Dolby® Virtual mode. The steps below explain how to select one of those options.

- 1** Press the Menu button on the remote to display the on-screen menu.
 - 2** Press the Cursor Right button repeatedly to select “Sound.”
 - 3** Press the Cursor Down button repeatedly until the “Sound mode” control is selected.
 - 4** Press the Cursor Right button to enter the sound mode submenu.
 - 5** Press the Cursor Up or Down button to select one of modes, either “Incr. Surround” or “Dolby Virtual.”
- Incr. Surround** enhances stereo programs by making the sound broader and fuller.
- Dolby Virtual** creates a virtualized surround-sound experience from two speakers. Dolby Virtual retains all the original multichannel audio information and provides the listener with the sensation of being surrounded by additional speakers.
- 6** When finished, press the Menu button to remove the on-screen menu from the TV screen.
 - 7** You can also select a sound mode option simply by pressing the Surround Sound button on the remote control.

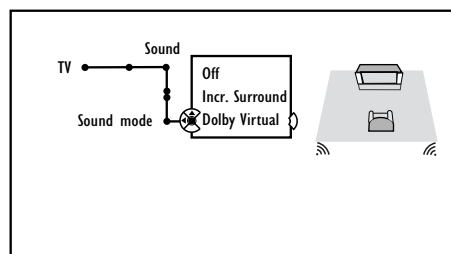
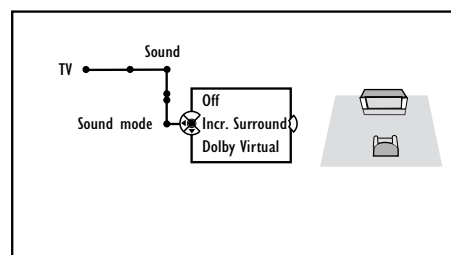
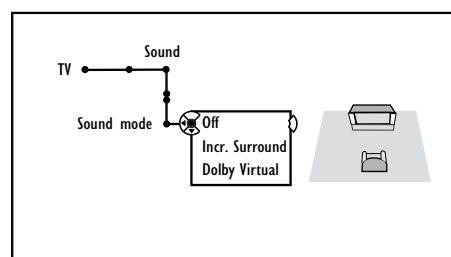
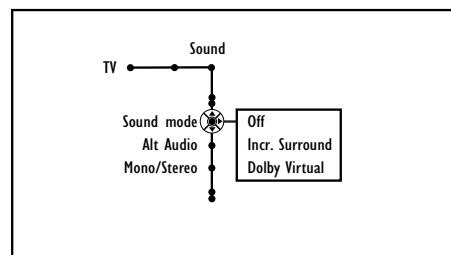
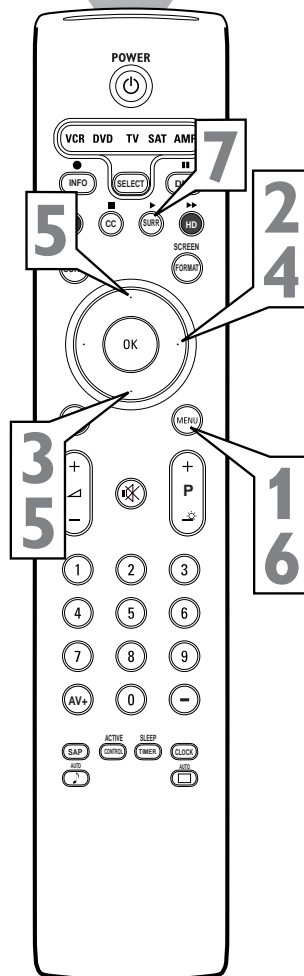
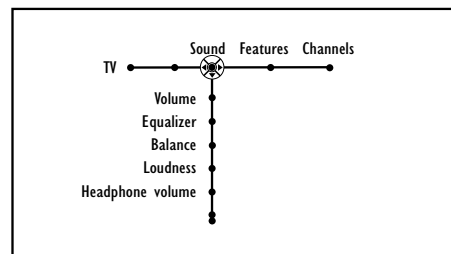
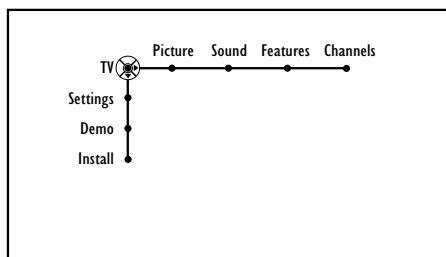

*Manufactured under license from Dolby Laboratories. “Dolby” and the double-D symbol are trademarks of Dolby Laboratories.

Incredible Surround is a trademark of Philips Consumer Electronics. Copyright 2004 Philips Consumer Electronics. All rights reserved.

Using Alternate Audio (SAP)



For broadcasts that contain SAP (Secondary Audio Program) information, the Alt Audio Control can be set to SAP. Sent as a third audio channel, SAP is an additional part of the stereo broadcast system that can be heard apart from the current TV program sound. TV stations are free to use SAP for any number of purposes.

If an SAP signal is not present with a selected program, the “Alt Audio” option in the TV’s on-screen menu cannot be selected and will appear grayed out.

If SAP is available on the tuned channel:

- 1** Press the Menu button on the remote to display the on-screen menu.
- 2** Press the Cursor Right button repeatedly to select “Sound.”
- 3** Press the Cursor Down button repeatedly until the Alt Audio control is selected.
- 4** Press the Cursor Right button to toggle and select either “Main” or “SAP.”
- 5** Press the Menu button to remove the on-screen menu from the TV screen.
- 6** You can also select SAP by simply pressing the Alternate Audio button on the remote control.

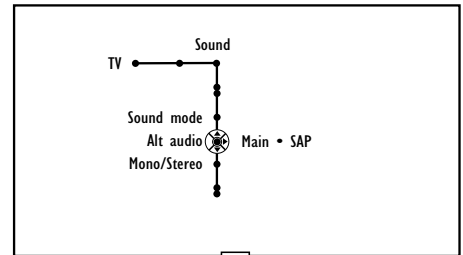
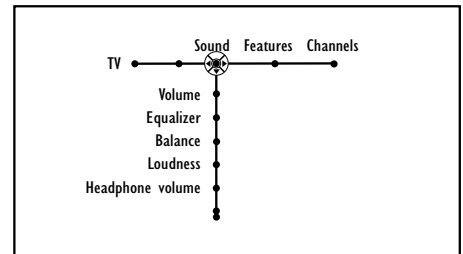
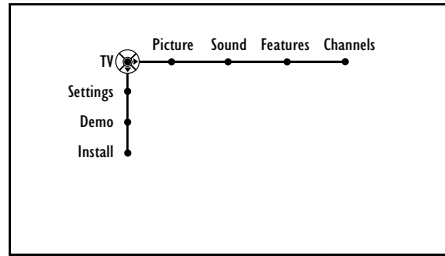

OR

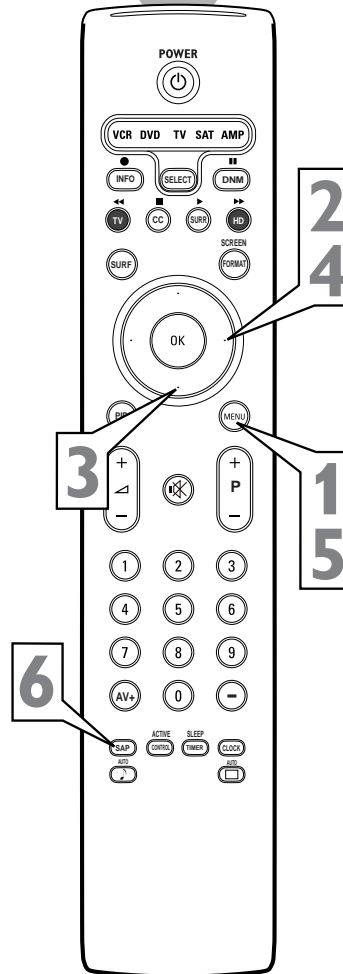
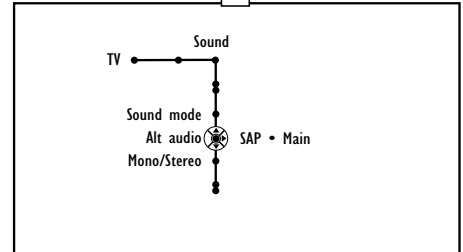



Setting the TV for Stereo Programming

Your TV can output stereo sound. It has both an amplifier and twin speakers through which the stereo sound can be heard.

- 1** Press the Menu button on the remote to display the on-screen menu.
- 2** Press the Cursor Right button repeatedly to select "Sound."
- 3** Press the Cursor Down button repeatedly until the "Mono/Stereo" control is selected.
- 4** Press the Cursor Right button to toggle and select either Mono or Stereo.

NOTE: If the signal being received is in mono, it cannot be set to Stereo. If the signal is being received in Stereo, the TV can be placed in the Mono mode. (If you select the Mono option, remember to return the Mono/Stereo control back to Stereo when using the TV with stereo programming.)

- 5** Press the Menu button to remove the on-screen menu from the TV screen.

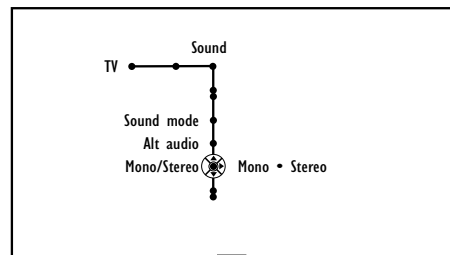
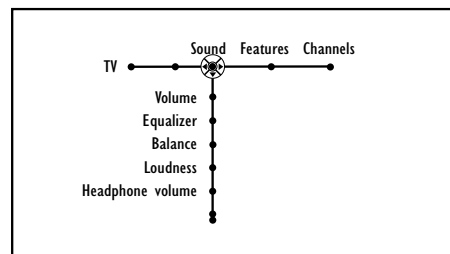
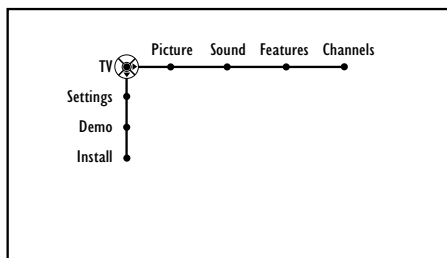

OR

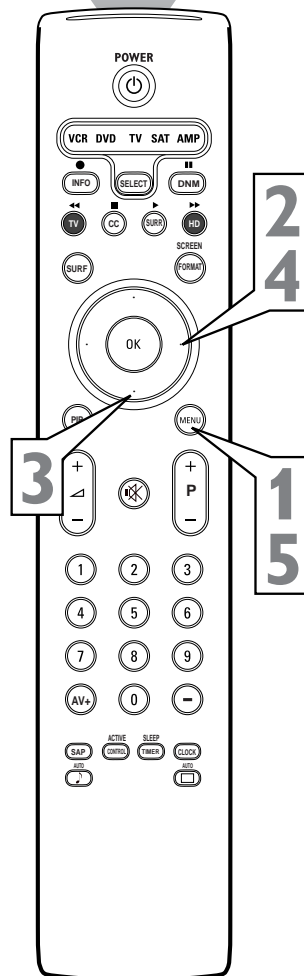
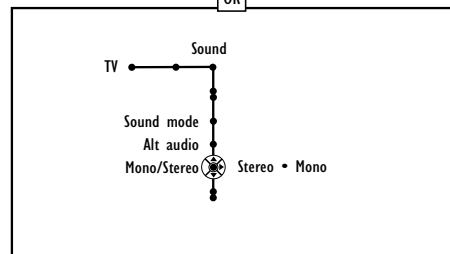

Turning the AVL (Audio Volume Leveler) on or off



You may have noticed the peaks and valleys of sound that occur between program changes or at commercial breaks. The volume levels often vary considerably. By turning on the AVL (Audio Volume Leveler) control, you can make your TV produce a more consistent volume level. Follow the steps below to turn AVL on.

- 1** Press the Menu button on the remote control to display the on-screen menu.
- 2** Press the Cursor Right button repeatedly to select "Sound."
- 3** Press the Cursor Down button repeatedly until AVL is highlighted.
- 4** Press the Cursor Right button to toggle the control on or off.
- 5** Press the Menu button to remove the menu from the TV screen.

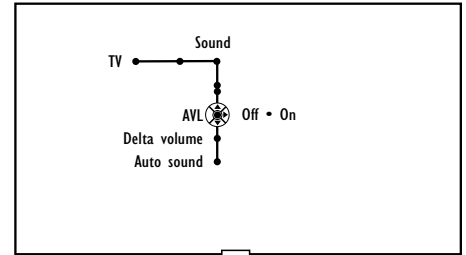
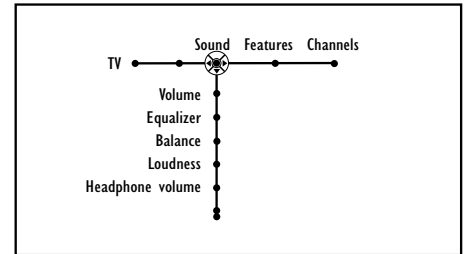
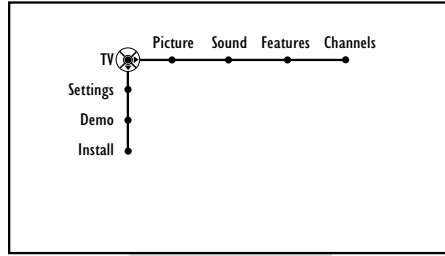

OR

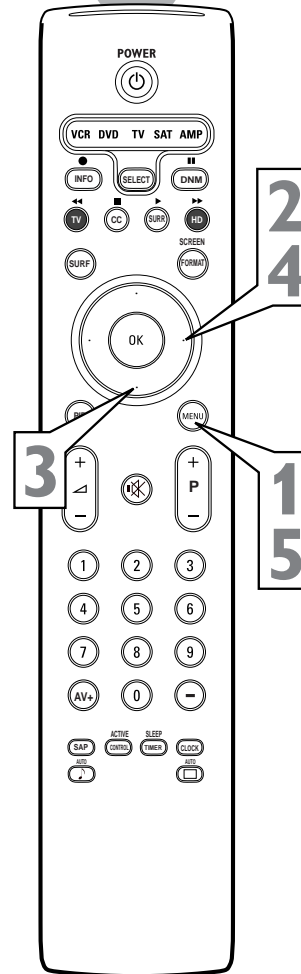
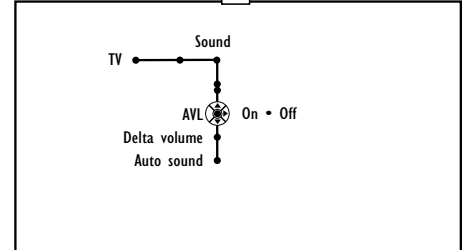



Adjusting the Delta Volume

The volume level coming from channel to channel and broadcast to broadcast can vary widely. The Delta Volume control will allow the volume to be increased for channels with weaker audio signals while allowing other channels with stronger signals to be reduced. When the Delta Volume control is adjusted or changed, it will affect only the currently tuned channel. The TV will store the setting for that channel in its memory and remember it when the channel is tuned again.

NOTE: The Delta Volume control does not work with the headphones.

- 1** Press the CH + or – button on the remote control to tune to a specific channel.
- 2** Press the Menu button on the remote control to show the on-screen menu.
- 3** Press the Cursor Right button repeatedly to select “Sound.”
- 4** Press the Cursor Down button repeatedly until “Delta volume” is highlighted.
- 5** Press the Cursor Left button to decrease the overall volume, or press the Cursor Right button to increase the overall volume for the tuned channel.

Repeat the steps above to adjust the delta volume for additional channels.

- 6** Press the Menu button to remove the on-screen menu from the TV screen.

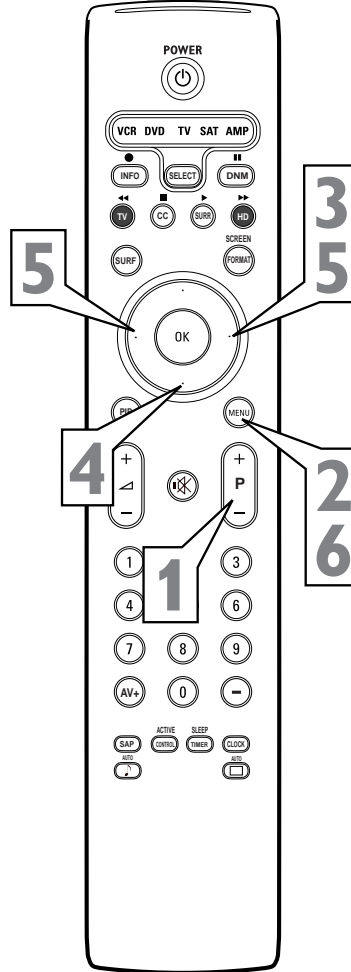
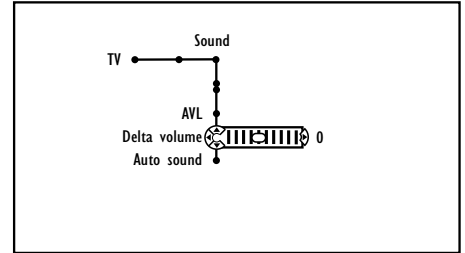
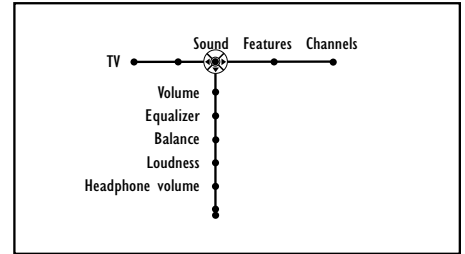
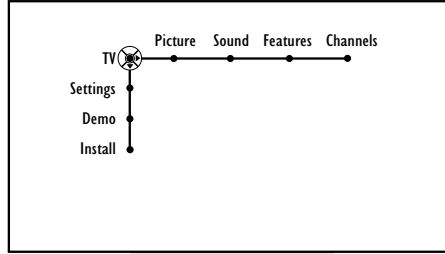

Using Closed Captioning



Closed Captioning (CC) allows you to read the voice content of television programs on the TV screen. Designed to help the hearing impaired, this feature uses on-screen text boxes to show dialogue and conversations while the TV program is in progress. Captions will appear on screen during captioned broadcasts.

Follow steps 1 through 7 to select a Closed Captioning option:

- 1** Press the Menu button on the remote control to display the on-screen menu.
- 2** Press the Cursor Down button repeatedly to select "Settings."
- 3** Press the Cursor Right button to select "General."
- 4** Press the Cursor Down button repeatedly to select "Caption service."
- 5** Press the Cursor Right button to enter the caption service submenu.
- 6** Press the Cursor Up or Down button to select one of the caption modes: **CC-1, CC-2, CC-3, or CC-4**—Dialogue (and descriptions) for the action on the captioned TV program shows on screen. CC-1 is used most frequently. CC-2 may be used for alternate languages if they are being transmitted. **T-1, T-2, T-3, or T-4**—Often used for a channel guide, schedules, bulletin board information for captioned programs, news, weather information, or stock market reports.

NOTES

- Text Modes (T-1 through T-4) appear on screen as boxes and may block portions of the TV screen.
- Not all caption services are necessarily being used by a TV channel during the transmission of a captioned program.

- 7** Press the Menu button to remove the on-screen menu from the TV screen.

To turn Closed Captioning on or off:

- 8** Press the CC button on the remote control.
- 9** Press the Cursor Up or Down button repeatedly to select "Off," "On," or "On during mute."
Off—Closed captioning service will not be displayed on the TV screen.
On—Closed captioning information (if available) will display on the TV screen.
On during mute—Closed Captioning information will turn on only when the Mute button is pressed. Turns the Closed Captioning information off when the TV volume is restored.

- 10** Press the Menu button on the remote to remove the on-screen display from the TV screen.

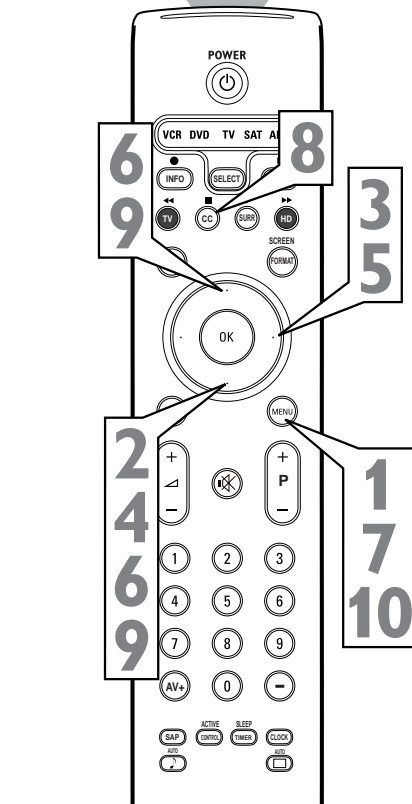
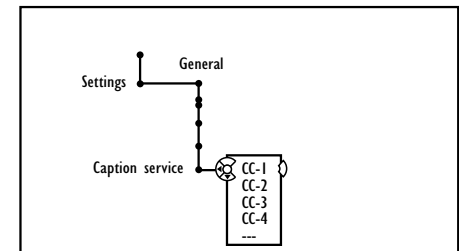
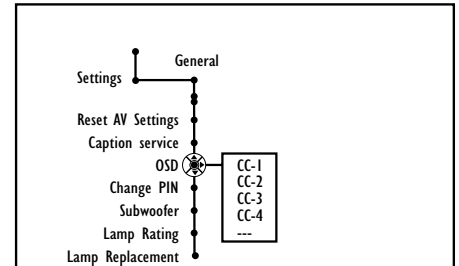
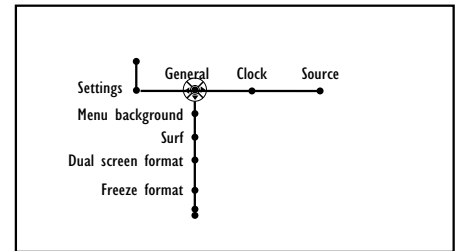
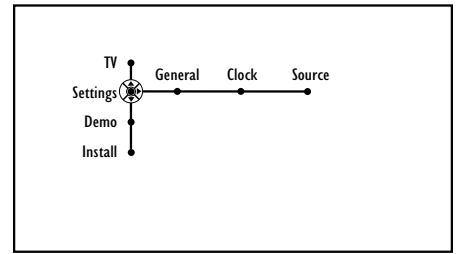
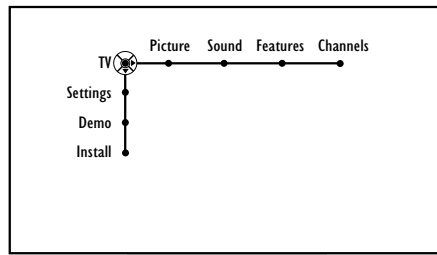

Access the CC "Off/On/On during mute control," using the CC button on the remote control or the "Features" on-screen menu.

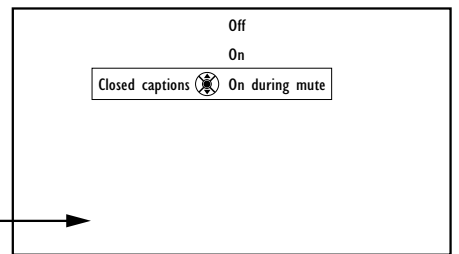
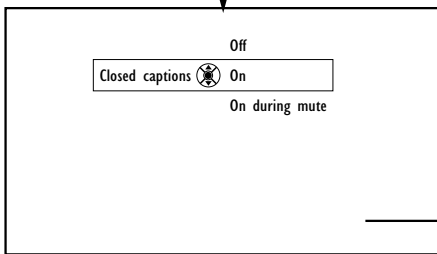
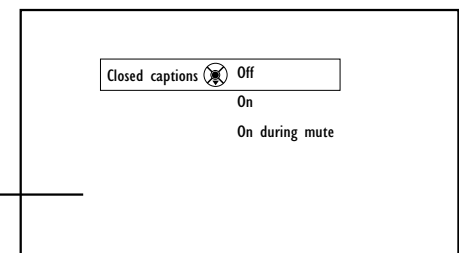

NOTES: • The captions do not always use correct spelling and grammar. • Not all TV programs and product commercials made for broadcast include Closed Captioning information. Refer to your area's TV program listings for the TV channels and times of shows with Closed Captioning. The captioned programs are usually noted in the TV listings with service marks such as "CC."



Setting the Sleptimer

NOTE: If you have not selected your time zone and set the Daylight Savings control, do so before making a Sleptimer setting. Details are on page 65.

If you have ever fallen asleep while watching TV, you may have wished you could have programmed your TV to turn off automatically. The Sleptimer feature allows you to set your TV to do that. With the Sleptimer control, you can set a timer to automatically switch the TV off after a period of time you choose—5 minutes up to 180 minutes in 5-minute increments.

- 1** Press the Menu button on the remote control to display the on-screen menu.
- 2** Press the Cursor Right button repeatedly until “Features” is selected.
- 3** Press the Cursor Down button repeatedly to select “Sleptimer.”
- 4** Press the Cursor Right button to set the sleptimer in 5-minute increments, from 5 minutes to 180 minutes.
- 5** Press the Menu button to remove the on-screen menu from the TV screen.
- 6** You can also set the Sleptimer directly by pressing the Sleptimer button on the remote control.

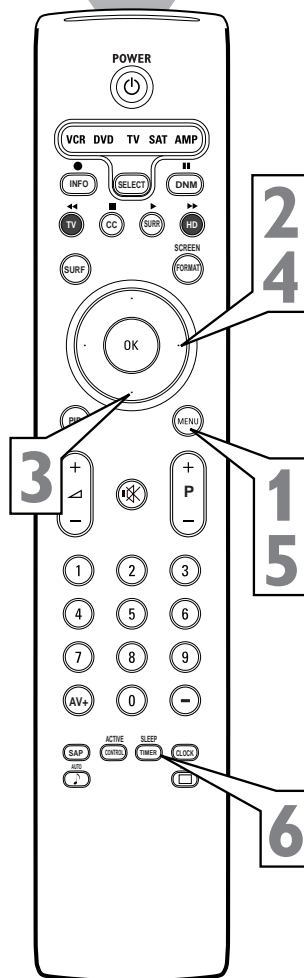
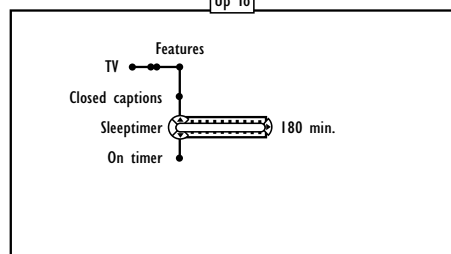
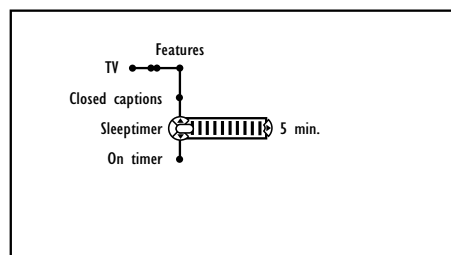
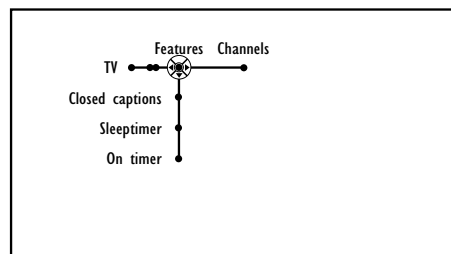
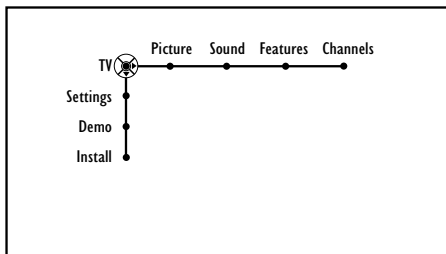

During the last minute of a sleptimer setting, the TV will display a countdown screen that will allow you to cancel the setting.

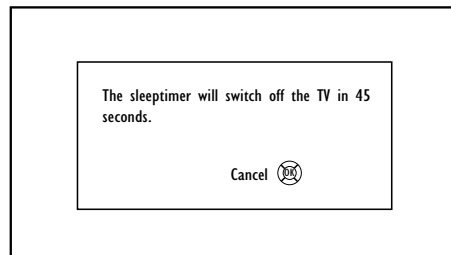

HELPFUL HINTS

- To see how many minutes remain before the TV shuts itself off, press the Information Plus **i+** button.
- An on-screen countdown will appear during the last minute before the TV shuts itself off. At this time, you may cancel the Sleptimer setting by pressing the OK button on the remote control.

Setting the On Timer



NOTE: Before you set the On Timer, you must set the clock. See page 65.

The On Timer control allows you to set a time for the TV to come on automatically at a certain time of day. The on timer can be set to work once or daily at a time you specify.

- 1** Press the Menu button on the remote control to display the on-screen menu.
- 2** Press the Cursor Right button repeatedly to select "Features."
- 3** Press the Cursor Down button repeatedly to select the "On timer" control.
- 4** Press the Cursor Right button to enter the On Timer submenu.
- 5** Press the Cursor Up or Down button to select "On."
- 6** Press the Cursor Right button to shift the menu to the start-channel submenu.
- 7** Press the Cursor Up or Cursor Down button to select the channel you would like the TV to tune to when it turns on.
- 8** Press the Cursor Right button to shift the menu to the day/daily submenu.
- 9** Press the Cursor Up or Down button to select the day to turn on or select "Daily."
- 10** Press the Cursor Right button to enter the AM/PM submenu.
- 11** Press the Cursor Up or Down button to select "AM" or "PM."
- 12** Press the Cursor Right button to enter the start time.
- 13** Press the Number buttons to enter the time. Use "0" first if entering a single digit (for example, input "0, 1, 3, 0" for 1:30).
- 14** Press the OK button to confirm.
- 15** Press the Menu button to remove the on-screen menu from the TV screen.

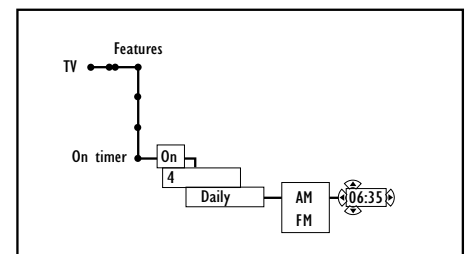
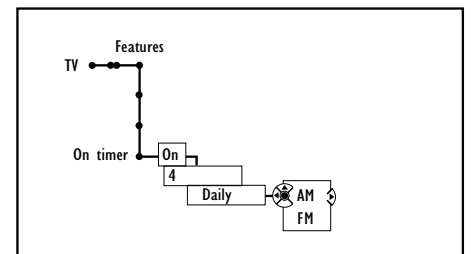
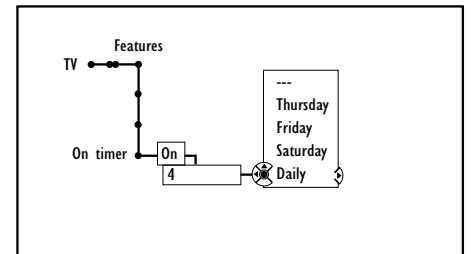
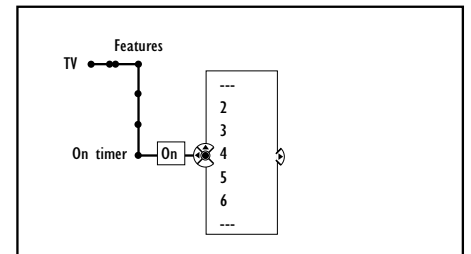
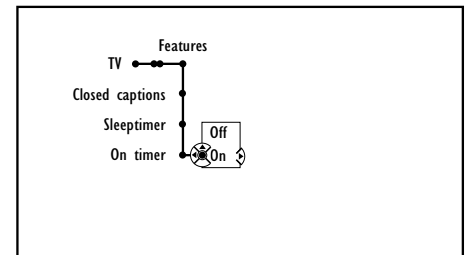
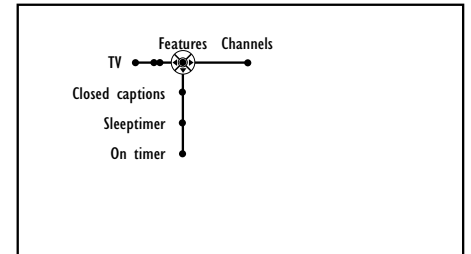
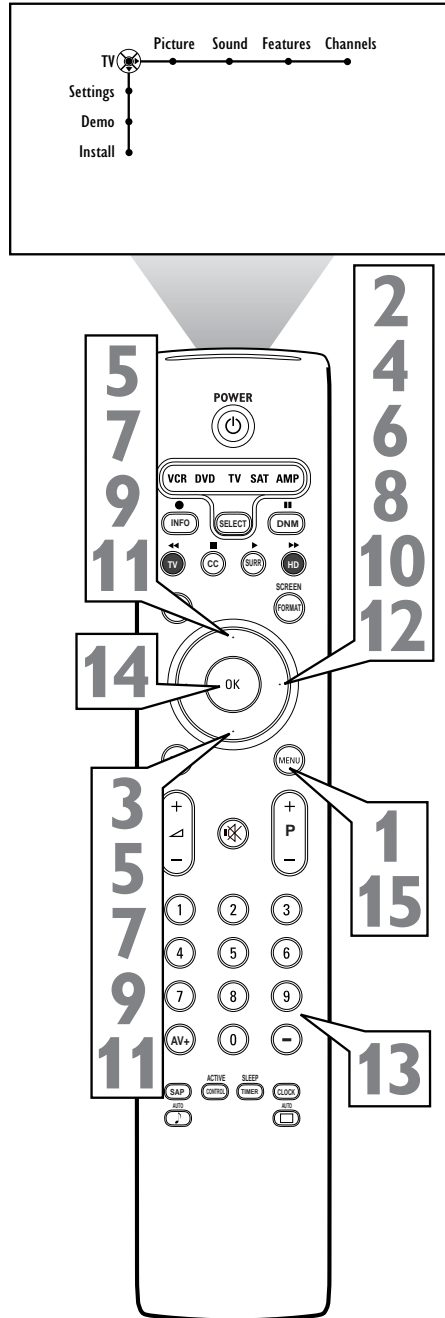

Using the Channel List

The Channel List control shows all the available channels that Auto Programming placed in the TV memory. The channels can be selected from this list.

- 1** Press the Menu button on the remote control to display the on-screen menu.
- 2** Press the Cursor Right button repeatedly to select "Channels."
- 3** Press the Cursor Down button to select the "Channel list" control.
- 4** Press the Cursor Right button to enter the Channel List submenu.
- 5** Press the Cursor Up or Down button to select a specific channel from the list.
- 6** Press the OK button. The television will tune to the selected channel.
- 7** Press the Menu button to remove the on-screen menu from the TV screen.

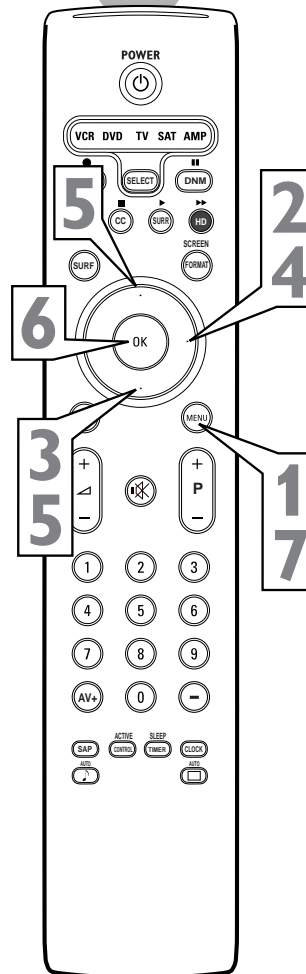
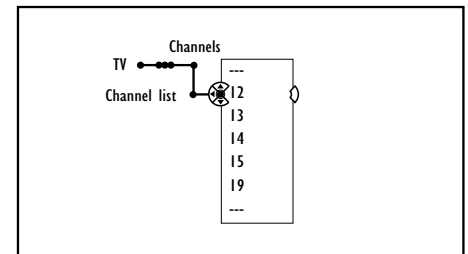
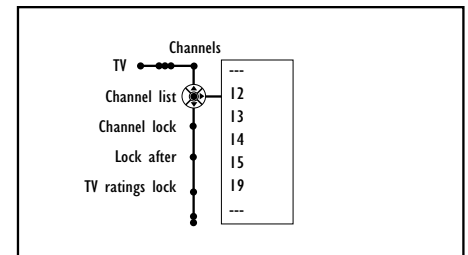
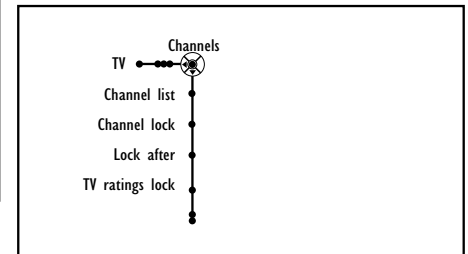
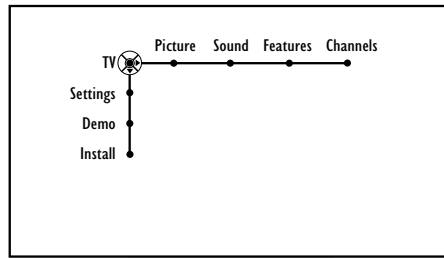

You can remove specific channels from the television's memory by using the Channel Remove control.

- 1** Press the Menu button on the remote control to display the on-screen menu.
- 2** Press the Cursor Right button repeatedly to select "Channels."
- 3** Press the Cursor Down button repeatedly to select the "Channel remove" control.
- 4** Press the Cursor Right button to enter the list of channels in the television's memory.
- 5** Press the Cursor Up or Down button to select a channel you want to remove.
- 6** Press the OK button to activate your choice. After you activate the Channel Remove control, the channel(s) highlighted will no longer be tuned when you press the CH(annel) + or - buttons.
- 7** Press the Menu button to remove the on-screen menu from the TV screen.

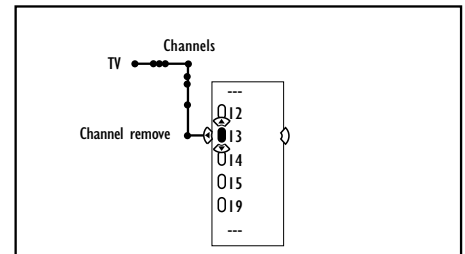
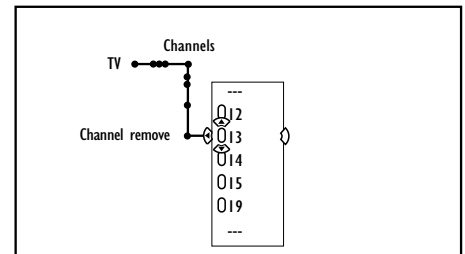
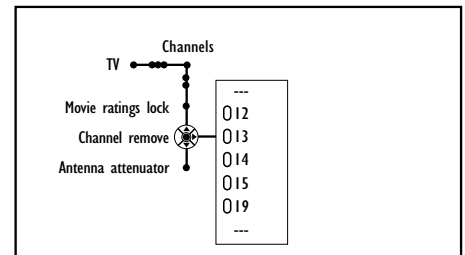
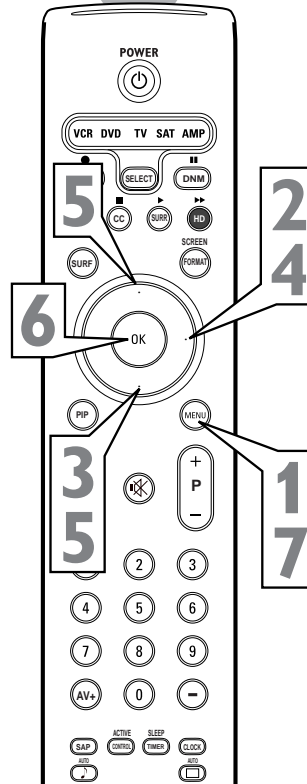
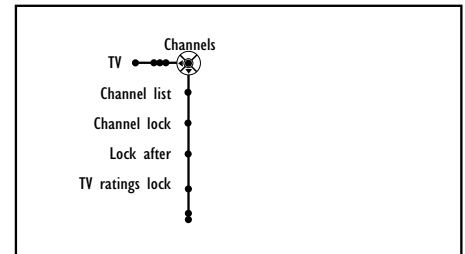
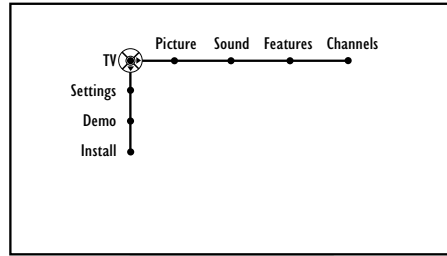

HELPFUL HINT

Once you have removed a channel from the Channel List, you must run the autoprogram to restore the channel. See the Quick Use and Setup Guide, page 8 for instructions.

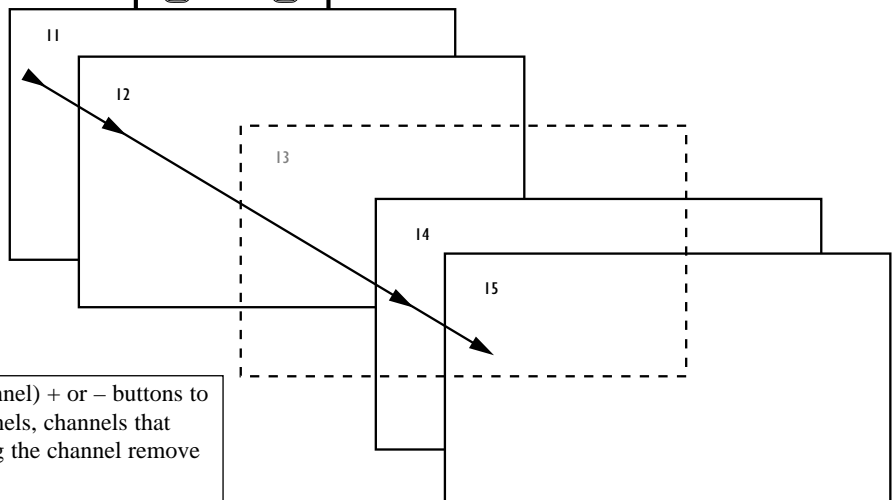

When you use the CH(annel) + or - buttons to scroll the available channels, channels that have been removed using the channel remove control will not appear.

For various reasons, you may want to block the viewing of materials on a specific channel or channels or through the audio/video (AV) inputs. Lock Channel provides this capability.

Before using the Lock Channel feature for the first time, you will be asked to enter the PIN number. Use the digit buttons on the remote control to enter the PIN you choose. All number combinations from 0000 to 9999 are valid. After you enter the number once, you will be asked to confirm the number, and then the number is stored.

To set or change your PIN number, see page 62.

- 1** Press the Menu button on the remote control to display the on-screen menu.
- 2** Press the Cursor Right button repeatedly to select "Channels."
- 3** Press the Cursor Down button repeatedly to highlight the "Channel lock" control.
- 4** Press the Cursor Right button to enter the channel lock submenu.
- 5** Press the Cursor Up or Down button to select a specific channel from the list.
- 6** Press the OK button. The oval in front of the channel number will change to yellow to show that the channel is locked.

Repeat steps 5 and 6 for other channels you want to lock.

- 7** Press the MENU button to remove the on-screen menu from the TV screen.

NOTE: To unlock a locked channel, enter your personal PIN number.

HELPFUL HINT

If you tune to a channel or input source that is locked and you enter your PIN, all locked channels or input sources will be unlocked until the television is shut off. When the television is turned back on again, previously locked channels or input sources will be locked again.

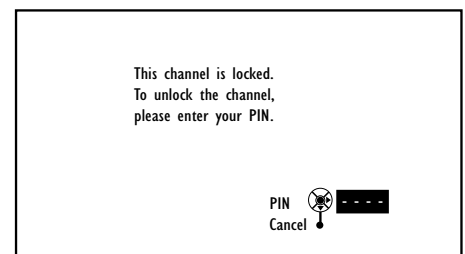
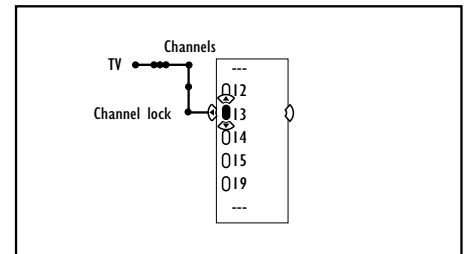
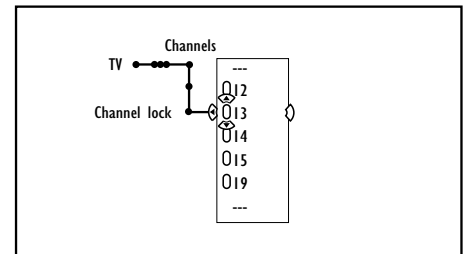
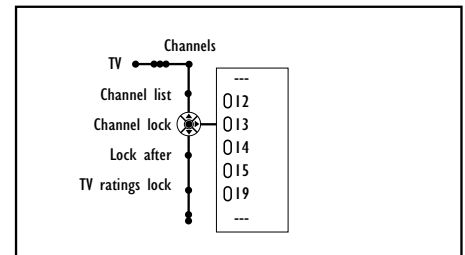
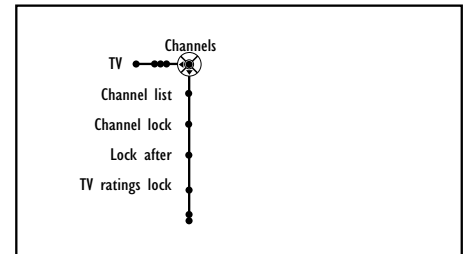
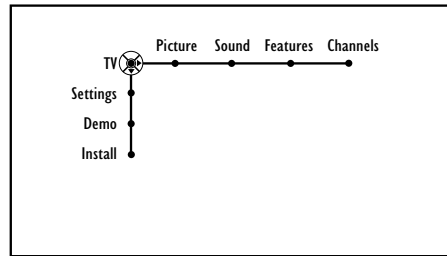

This screen will appear when tuned to a locked channel. To view the channel, enter your PIN.

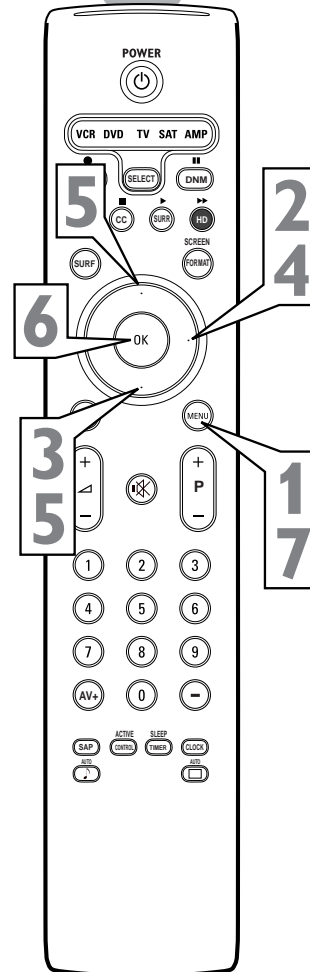

You may want to block programming after a certain time of day. This feature is excellent for limiting the amount of time your children watch TV or for preventing them watching unsuitable programs that are often shown at night.

NOTE: The set automatically unlocks after 3 a.m.

- 1** Press the Menu button on the remote control to display the on-screen menu.
- 2** Press the Cursor Right button repeatedly to select "Channels."
- 3** Press the Cursor Down button repeatedly to select the "Lock after" control.
- 4** Press the Cursor Right button to enter the Lock After submenu (with the options "Off" or "On").
- 5** Press the Cursor Up or Down button to select "On" from the submenu. A submenu with the options of "AM" or "PM" will appear.
- 6** Press the Cursor Right button to enter the AM/PM submenu. A box with the time (or area where the time can be entered) will appear.
- 7** Press the Cursor Up or Down button to select AM or PM.
- 8** Press the Cursor Right button to enter the Lock After time.
- 9** Press the Number buttons to enter the time you want the television to lock all channels.
- 10** Press the Menu button to remove the on-screen menu from the TV screen.

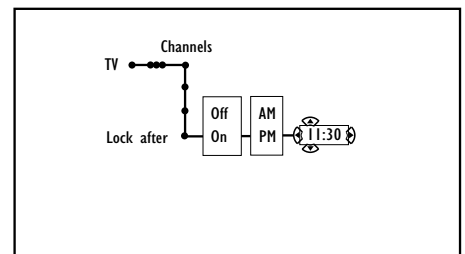
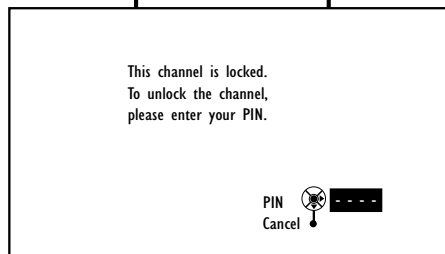
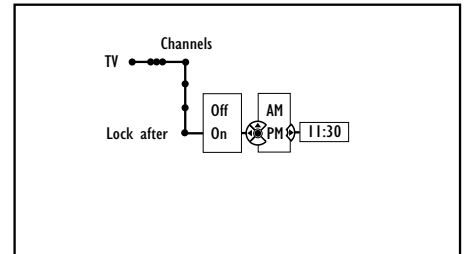
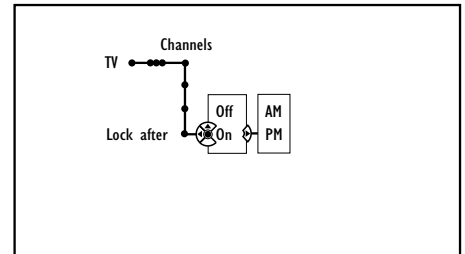
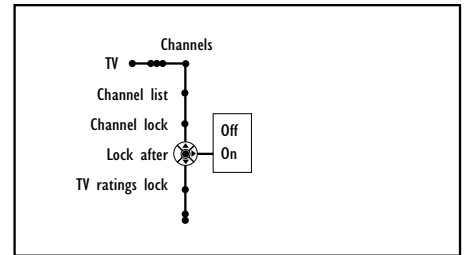
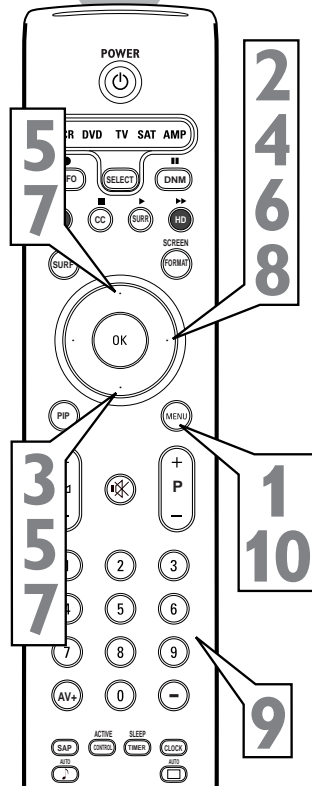
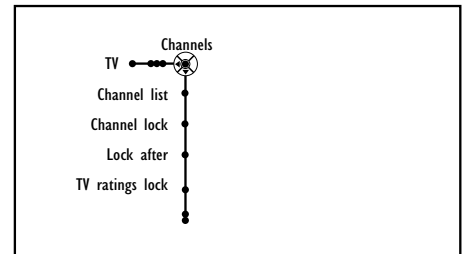
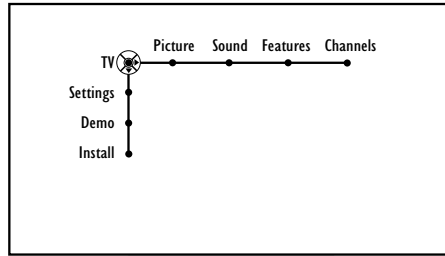

Once the time has expired, all channels will display this screen. To view the channels, enter your PIN.

HELPFUL HINT

If you tune to a channel or input source that is locked and you enter your PIN, all locked channels or input sources will be unlocked until the television is shut off. When the television is turned back on again, previously locked channels or input sources will be locked again.

Blocking Programming Based on TV Ratings

You can select specific TV Ratings to block broadcast signals that have unsuitable content.

- 1** Press the Menu button on the remote control to display the on-screen menu.
 - 2** Press the Cursor Right button repeatedly to select "Channels."
 - 3** Press the Cursor Down button repeatedly to select the "TV ratings lock" control.
 - 4** Press the Cursor Right button to enter the TV Ratings Lock list of options.
 - 5** Press the Cursor Up or Down button to select one of the ratings.
 - 6** Press the OK button to activate your choice.
- NOTE:** Some of the TV Rating options contain specific subratings. "TV-Y7" contains the "(FV) Fantasy Violence" subrating; "TV-PG" and "TV-14" contain "(D) Dialogue," "(L) Language," "(S) Sex," and "(V) Violence" subratings; "TV-MA" contains "(L) Language," "(S) Sex," and "(V) Violence" subratings.
- 7** If the PIN message is displayed, enter your PIN.
 - 8** Press the Menu button to remove the on-screen menu from the TV screen.

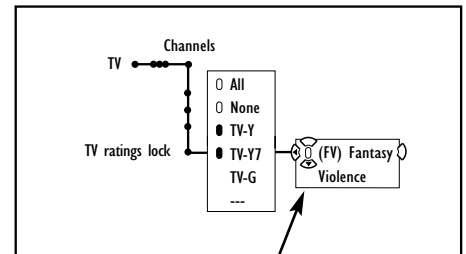
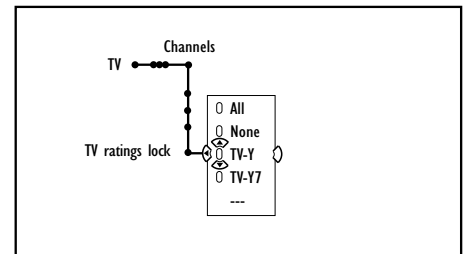
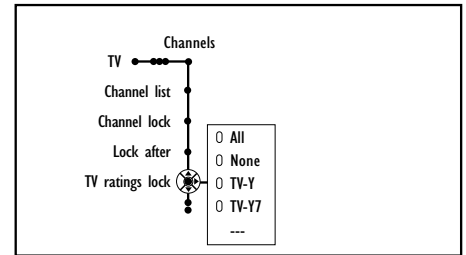
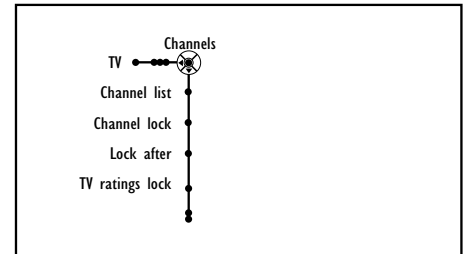
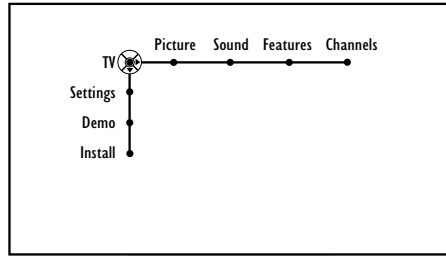

Some TV Ratings have subrating options.

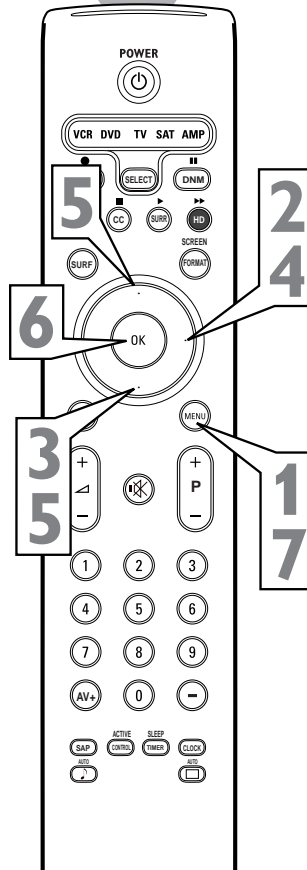

TV Ratings (from TV Broadcasters)

None—programs that are either rated "None" or have no content advisory. Selecting this option will block all such programs.

- TV Y (All Children)**—programs designed to be appropriate for all children, especially ones ages 2–6. These programs are not expected to frighten younger children.
- TV Y7 (Directed to Older Children)**—programs designed for children ages 7 and older. These programs may be more appropriate for children who have acquired the development skills needed to distinguish between make-believe and reality. Such programs may include mild fantasy and comic violence (FV).
- TV G (General Audience)**—most parents will consider programs that are rated TV-G to be suitable for children of all ages. Such programs have little or no violence, no strong language, and little or no sexual dialogue or sexual situations.
- TV PG (Parental Guidance Suggested)**—programs contain material that parents may find unsuitable for younger children. This type of programming has one or more of the following: moderate violence (V), some sexual situations (S), infrequent coarse language (L), or some suggestive dialogue (D).
- TV 14 (Parents Strongly Cautioned)**—programs contain material that many parents will find unsuitable for children under 14 years of age. These programs have one or more of the following: intense violence (V); intense sexual situations (S); strong, coarse language (L); or intensely suggestive dialogue (D).
- TV MA (Mature Audience Only)**—specifically designed to be viewed by adults and therefore may be unsuitable for children under 17. Such programs have one or more of the following: graphic violence (V); explicit sexual situations (S); or crude, indecent language (L).

You can prevent the viewing of unsuitable programming based on movie ratings.

- 1** Press the Menu button on the remote control to display the on-screen menu.
- 2** Press the Cursor Right button repeatedly to select "Channels."
- 3** Press the Cursor Down button repeatedly to select the "Movie ratings lock" control.
- 4** Press the Cursor Right button to enter the Movie Ratings Lock list of options.
- 5** Press the Cursor Up or Down button to select the rating you want to lock.
- 6** Press the OK button to activate your choice.
- 7** Press the MENU button to remove the on-screen menu from the TV screen.

NOTE: When a rating is turned on, all higher ratings (and subratings) will be turned on. (for example, if "R" is selected, "NC-17" and "X" will automatically turn on also.)

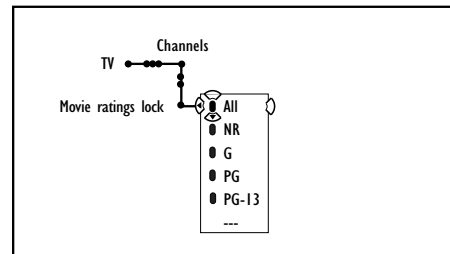
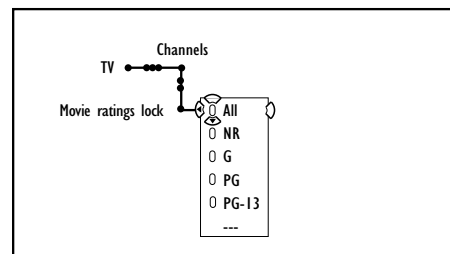
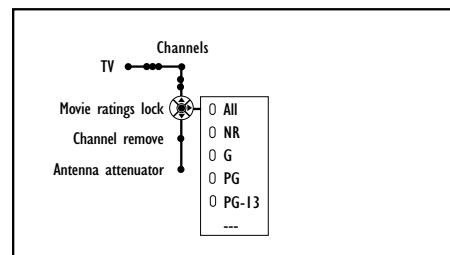
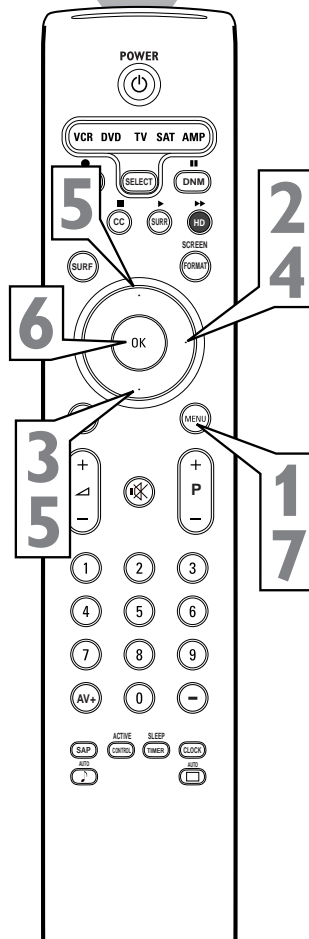
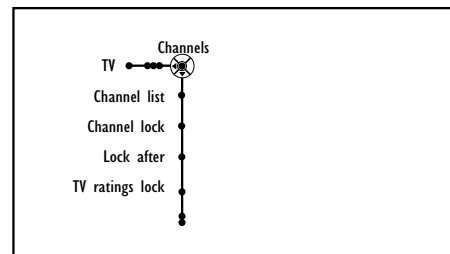
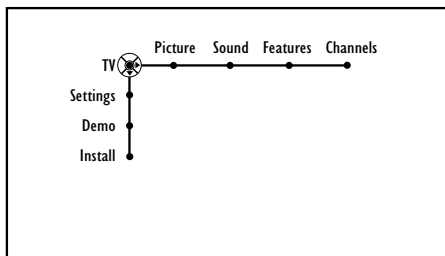

Movie Ratings (from the Motion Picture Association of America)

NR (Not Rated)—programs that the Motion Picture Association of America has chosen not to rate.

G (General Audience)—all ages admitted. Most parents will find programs that are rated G to be suitable for children of all ages. Such programs have little or no violence, no strong language, and little or no sexual dialogue or sexual situations.

PG (Parental Guidance Suggested)—contain material that parents may find unsuitable for younger children. These programs have one or more of the following: moderate violence, some sexual situations, infrequent coarse language, or some suggestive dialogue.

PG-13 (Parents Strongly Cautioned)—contain material that parents may find unsuitable for children under the age of 13. Programs that are rated PG-13 have one or more of the following: violence, sexual situations, coarse language, or suggestive dialogue.

R (Restricted)—specifically designed for adults. Anyone under the age of 17 should view programs that are rated R only with an accompanying parent or adult guardian. Such programs have one or more of the following: intense violence; intense sexual situations; strong, coarse language; or intensely suggestive dialogue.

NC-17 (No one under the age of 17 will be admitted)—should be viewed by adults only. These programs have graphic violence; explicit sex; or crude, indecent language.

X (Adults Only)—contain one or more of the following: very graphic violence, very graphic and explicit or indecent sexual acts, or very coarse and intensely suggestive language.

Turning the Antenna Attenuator on or off

If you live near a television station's transmitter tower, you may receive an interfering signal from the station while watching other TV channels. Your television's Antenna Attenuator control is designed to reduce the strength of such a signal in the presence of a strong main signal. The default setting for the Antenna Attenuator is "Off." If you need to use the feature, simply toggle it "On" in the on-screen menu. The setting you make applies to the channel you are currently watching and will remain in place until you change the setting.

- 1** Press the Menu button on the remote control to display the on-screen menu.
- 2** Press the Cursor Right button repeatedly to select "Channels."
- 3** Press the Cursor Down button repeatedly to select the "Antenna attenuator" control.
- 4** Press the Cursor Right button to toggle the control "On" or "Off."
- 5** Press the Menu button to remove the on-screen menu from the TV screen.

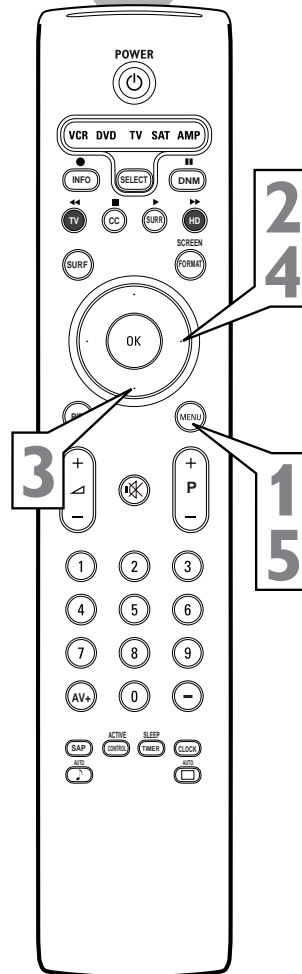
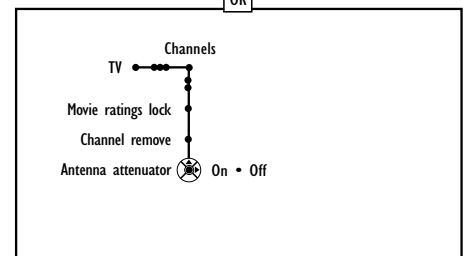
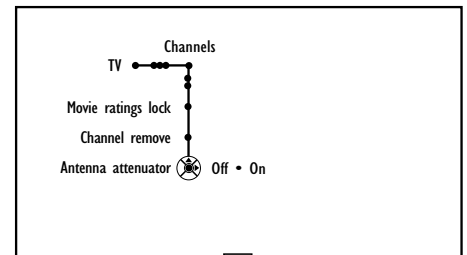
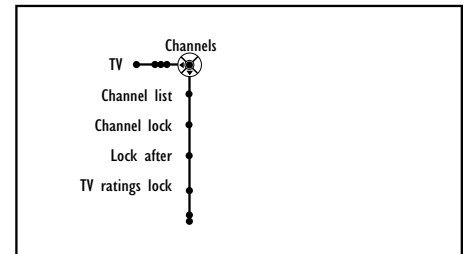
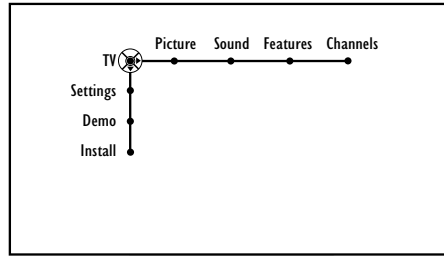

You can access a list of previously viewed channels with the Surf button on the remote control. With Surf you can easily switch between different TV channels that currently interest you. Surf allows you to set up the television to cycle through two or nine channels by pressing the Surf button on the remote control.

- 1** Press the Menu button on the remote control to display the on-screen menu.
- 2** Press the Cursor Down button to select "Settings."
- 3** Press the Cursor Right button to select the "General" menu.
- 4** Press the Cursor Down button repeatedly to select the "Surf" control.
- 5** Press the Cursor Right button to toggle the Surf control to "2 channels" or "9 channels."
- 6** Press the Menu button to remove the on-screen menu from the TV screen.
- 7** If you selected the "2 channels" Surf option, pressing the Surf button allows you to alternate between the currently viewed channel and the previously viewed channel.

If you selected the "9 channels" Surf option, pressing the Surf button displays a Surf list in which you can place up to 9 favorite channels. A/V sources also can be included in the list.

To add a channel to the list, tune to the channel, press the Surf button, then press the Cursor Right button.

If you attempt to add more than 9 channels to the list, the channel on the bottom of the list will be automatically removed to make room for the newly added channel.

After you have placed your favorite channels in the list, press the Surf button as many times as necessary to tune to the desired favorite channel. Or, with the Surf list displayed, press the Cursor Down or Up buttons to tune to the desired channel.

To remove a channel from the list, press the Surf button to display the list, press the Cursor Down or Up buttons until you select the channel you want to remove, then press the Cursor Right button.

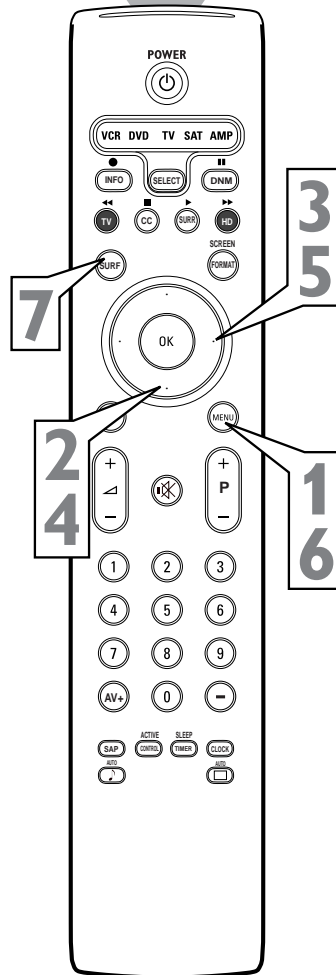
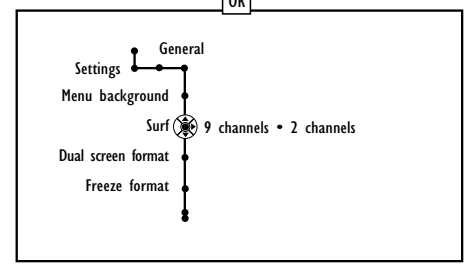
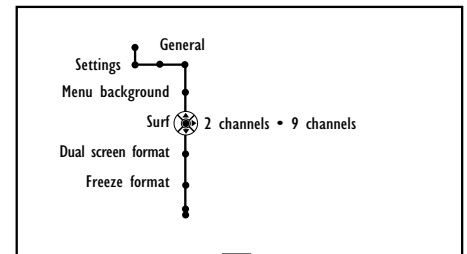
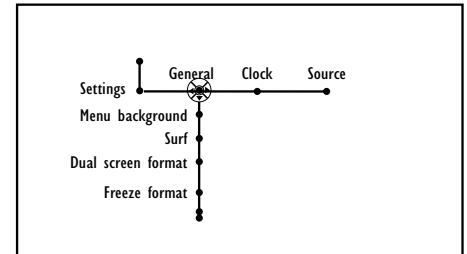
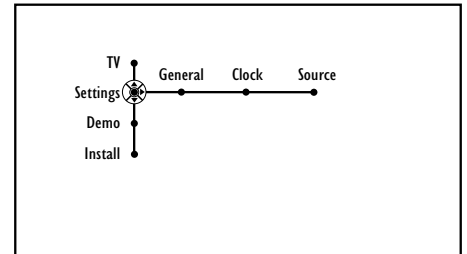
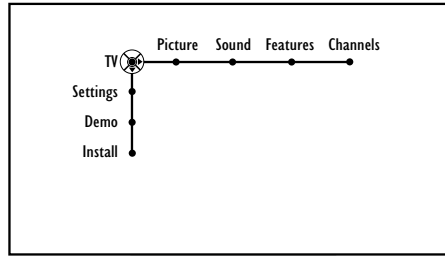

2 Channels Surf

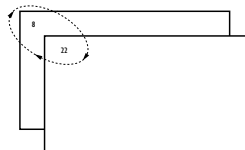

9 Channels Surf

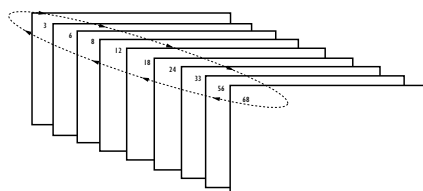

Using 9 Channels Surf, place up to 9 favorite channels in the Surf list.

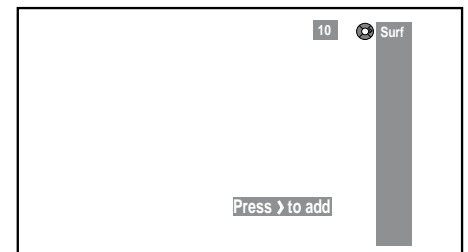

If you decide you don't want a channel in the list, you can remove it.



The Dual Screen feature, also referred to as Picture In Picture (PIP), will allow you to choose the size of the dual screen window to be displayed when the Dual Screen/PIP button is pressed on the remote control. The window can be set to Dual Screen, Large PIP, or Small.

- 1 Press the Menu button on the remote control to display the on-screen menu.
 - 2 Press the Cursor Down button to select "Settings."
 - 3 Press the Cursor Right button to select the "General" menu.
 - 4 Press the Cursor Down button repeatedly to select the "Dual screen format" control. A submenu or list of options will appear.
 - 5 Press the Cursor Right button to enter the list of options.
 - 6 Press the Cursor Up or Down button to select the desired dual screen format. Choose from "Dual screen," "Large PIP," or "Small PIP."
 - 7 Press the Menu button to remove the on-screen menu from the TV screen.
 - 8 Press the Dual Screen/PIP button on the remote control to display the second video window in the format you have chosen.
- Continuing to hold the Dual Screen/PIP button will cycle through the Dual Screen/PIP options.
- Press the Dual Screen button again to return the television to the main video screen.

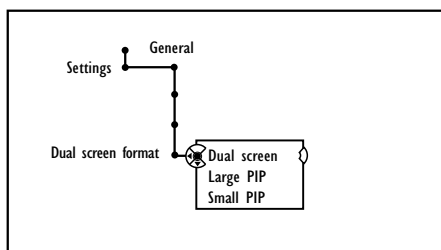
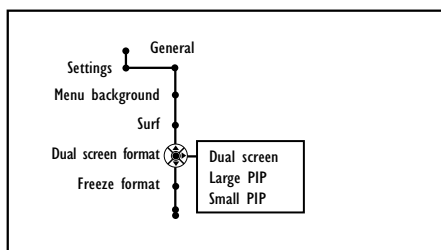
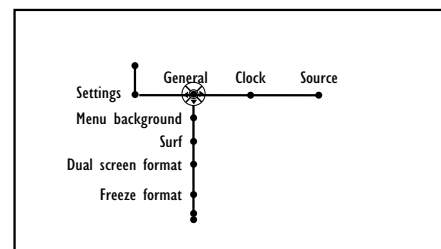
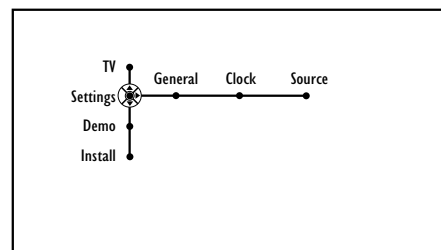
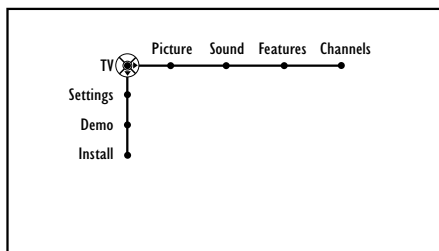

Dual Screen

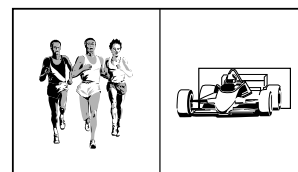

Large PIP



Small PIP

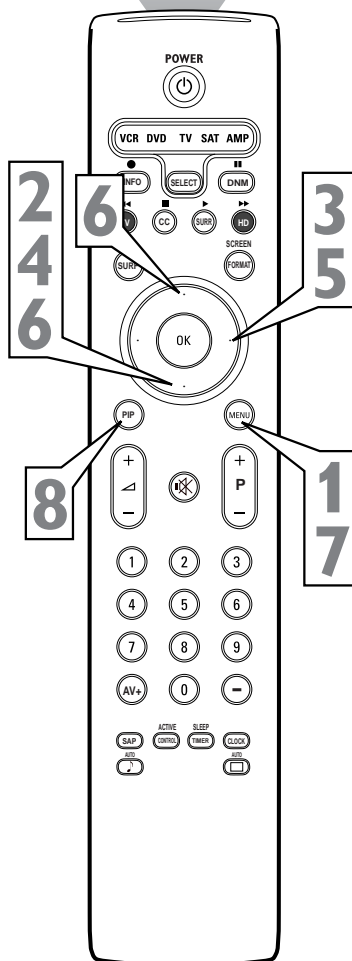
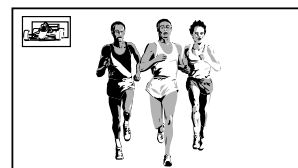

See the next page for information on changing channels or input sources in Dual Screen/PIP mode, and for re-positioning the Large or Small PIP screens.

HELPFUL HINT

Your Cineos TV has a Double Window (DW) and a Picture-in-Picture (PIP) mode in which it is possible to see a signal from another source without interrupting the program/video that you are looking at.

When switching on DW or PIP mode we want you to be aware that the color and picture settings of the left window (for DW) respectively of the main screen (for PIP) are applicable to the full screen. This may result in the fact that colors on the right window (for DW) or the small window (for PIP) look different than when that signal is displayed on the main screen. So for instance if a disc from a DVD player is playing in the right window while you watch TV in the left window it may be that the colors of the DVD player look different from when the DVD is playing full screen.

When using Dual Screen:

- 1** A light-colored border indicates the selected screen. If the screen whose channel or input source you want to change is not selected, press the Cursor Right or Left button to select the desired screen.
 - 2** To change channels in the selected screen, press the CH (Channel Selection) + or – buttons.
 - 3** Or:
To change the input source, first press the Source button. Then, within 6 seconds, press the Cursor Up or Down until your desired input source is highlighted. Press the OK button to confirm. The desired input source appears in the selected screen.
- NOTE:** If the list of input sources “times out” (leaves the screen) before you can make your selection, press the Source button again to display the list again.

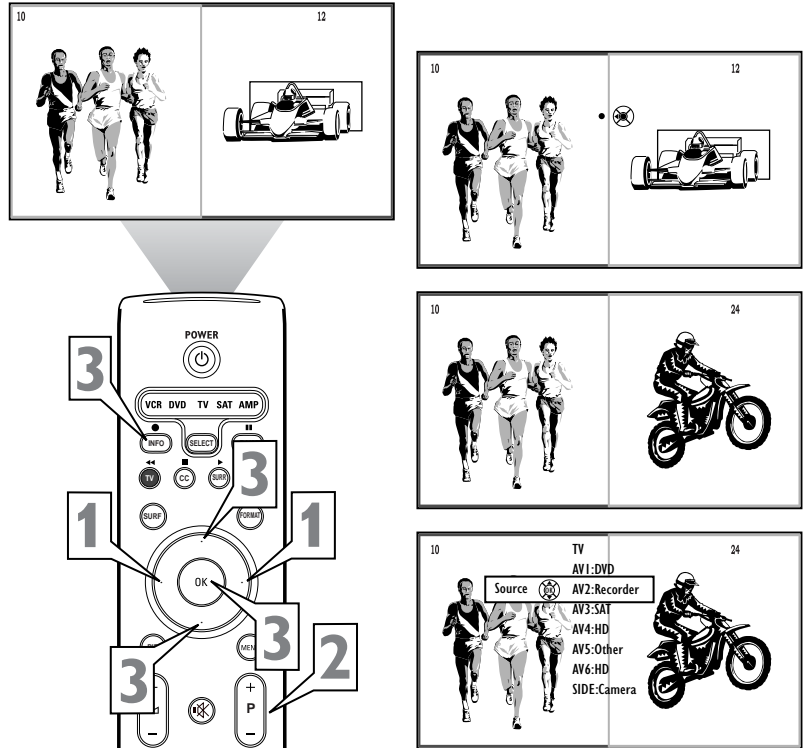

When using Large or Small PIP:

- 1** When the PIP window is on screen, press the Cursor Up or Down button to select either the main or PIP screen. A light-colored border surrounds the PIP screen when it is selected. The PIP screen must be selected before its channel or input source can be changed.
 - 2** To change channels in the PIP screen, press the CH (Channel Selection) + or – buttons.
 - 3** Or:
To select a different input source, first press the Source button. Then, within 6 seconds, press the Cursor Up or Down until your desired input source is highlighted. Press the OK button to confirm. The desired input source appears in the PIP screen.
- NOTE:** If the list of input sources “times out” (leaves the screen) before you can make your selection, press the Source button again to display the list again.

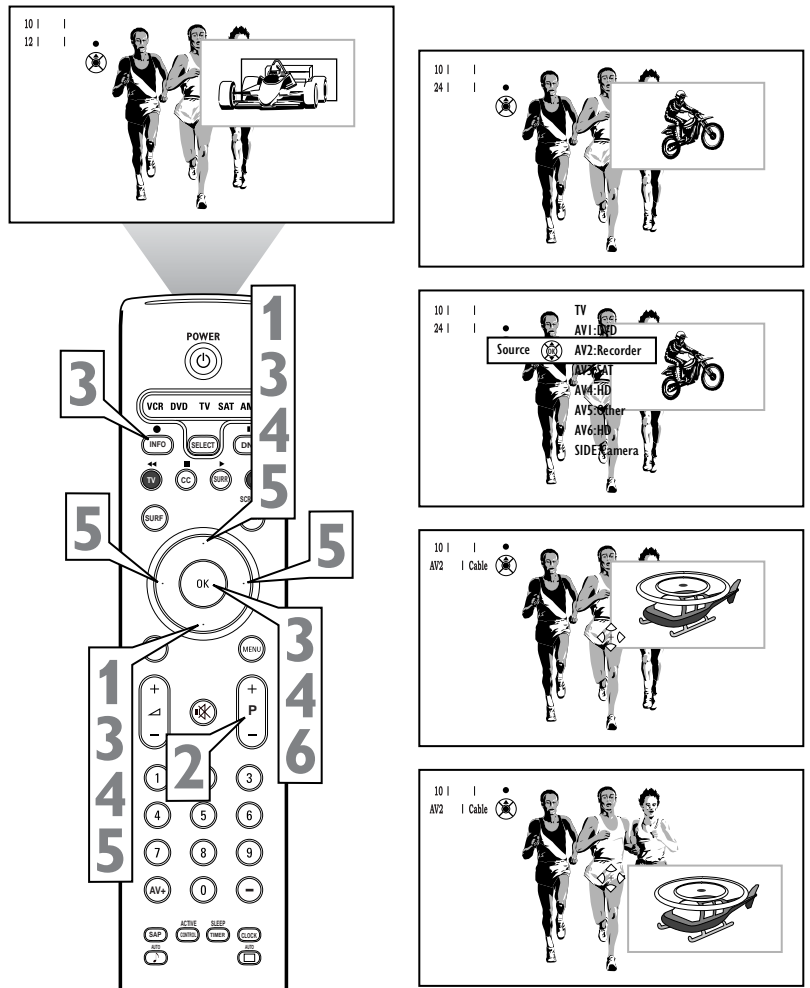

To reposition the PIP screen:

- 4** Press the Cursor Up or Down button. The ball and direction indicator appear on screen. Within 6 seconds, press the OK button. A multidirectional symbol appears on screen.
- 5** **NOTE:** If the ball and direction indicator “time out” (leave the screen) before you press the OK button, simply press the Cursor Up or Down button again.
- 5** Press the Cursor Up, Down, Left, or Right buttons to move the PIP window to the desired location.
- 6** Press the OK button. The ball and direction indicator reappear and “time out” (leave the screen) in about 6 seconds.

Selecting a Picture Freeze Option

The Freeze control provides three ways for you to stop the action of programs. The Freeze control options allow you to get a better look at exciting sports plays or copy down broadcasted addresses or phone numbers. The steps below explain how to select an option.

- 1** Press the Menu button on the remote control to display the on-screen menu.
 - 2** Press the Cursor Down button to select "Settings."
 - 3** Press the Cursor Right button to highlight the "General" menu.
 - 4** Press the Cursor Down button repeatedly to highlight the "Freeze format" control. A submenu will appear.
 - 5** Press the Cursor Right button to enter the submenu.
 - 6** Press the Cursor Up or Down button to select the desired freeze format. Choose from "Freeze," "Replay," or "Photo finish."
 - 7** Press the Menu button to remove the on-screen menu from the TV screen.
 - 8** Press the Freeze Format button on the remote control to display the format you have chosen.
- NOTE:** Continuing to hold the Freeze Format button will cycle the TV through the Freeze modes.
- To return the television to the main video screen, press the Freeze button again.

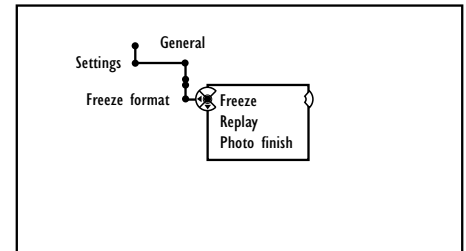
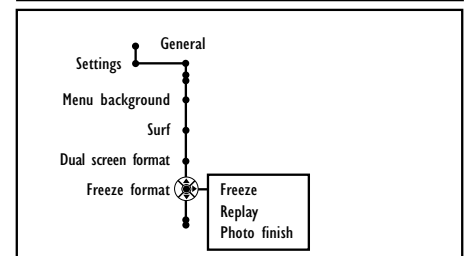
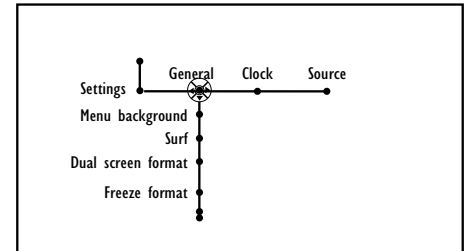
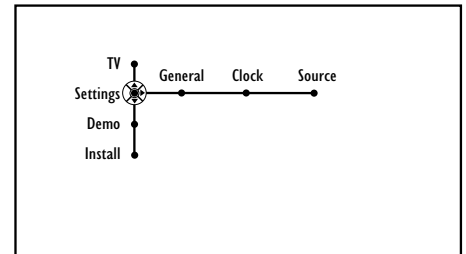
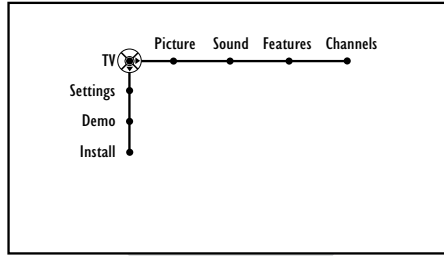
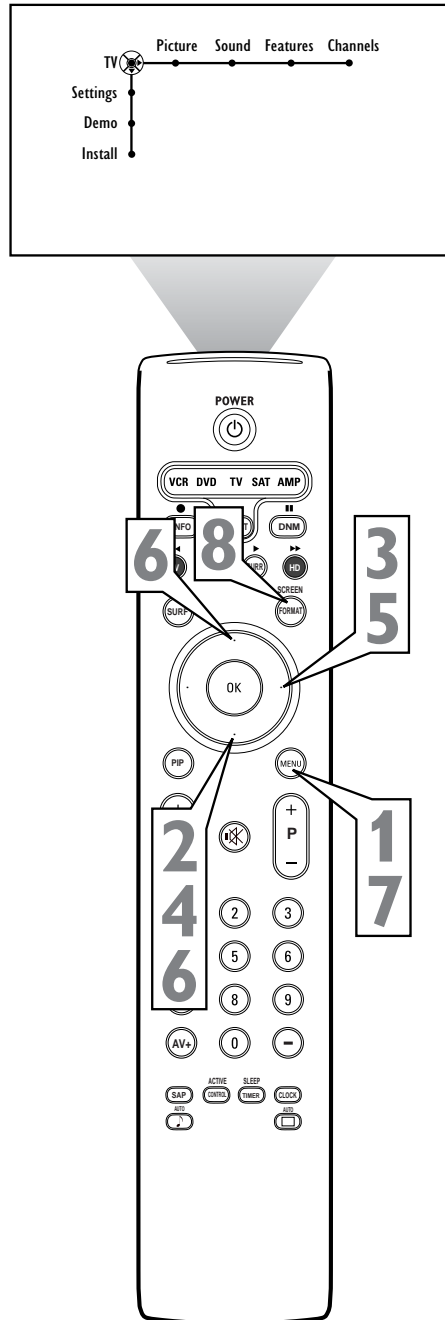

HELPFUL HINT

Replay and Photo Finish are not available with inputs AV3–AV6.



Freeze

Stops motion on the main screen.



Replay

Replays a few seconds of stored video.

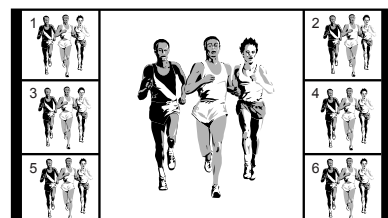

Photo finish

Displays six still frames from a TV picture while the current program continues to play on the main (center) screen.

NOTE: Frame order will vary.

Resetting the Audio/Video Settings to Factory Default Values

G

You can reset the TV's Sound and Picture settings to the factory default values.

- 1 Press the Menu button on the remote control to display the on-screen menu.
- 2 Press the Cursor Down button to select "Settings."
- 3 Press the Cursor Right button to select the "General" menu.
- 4 Press the Cursor Down button repeatedly to select the "Reset AV settings" control.
- 5 Press the OK button to reset the AV settings to factory values.
- 6 Press the Menu button to remove the on-screen menu from the TV screen.

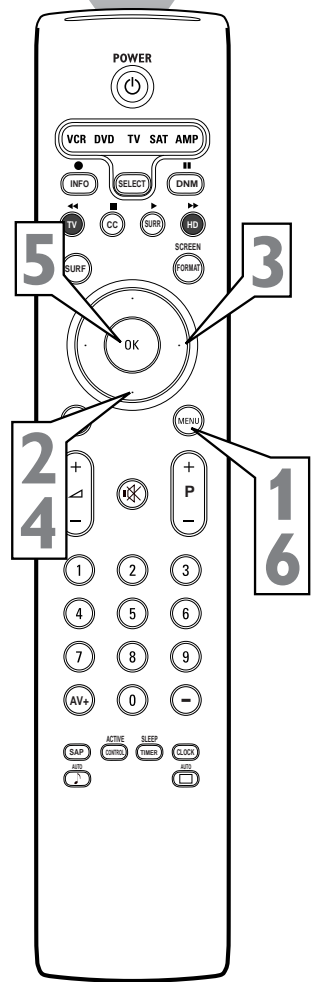
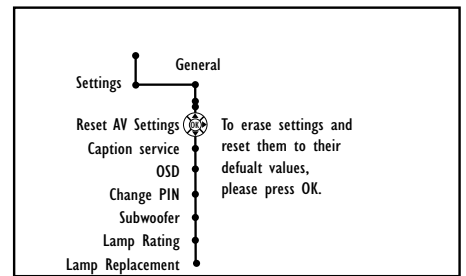
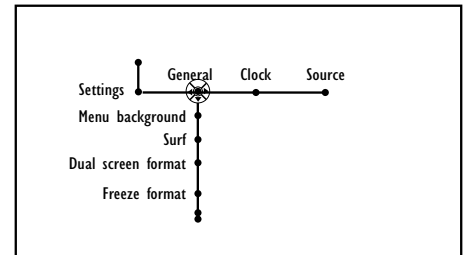
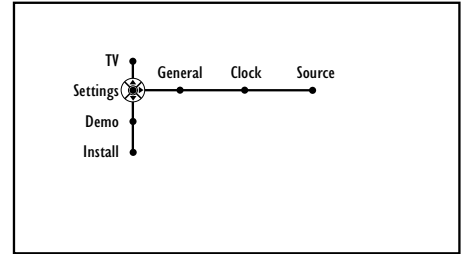
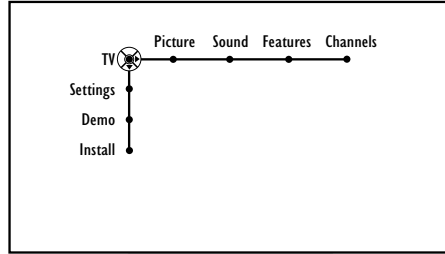

Selecting an On-screen Display Option

The television's on-screen display (OSD) can be set to show only the current channel number or the channel number with additional TV operating modes and status-screen information.

- 1** Press the Menu button on the remote control to display the on-screen menu.
 - 2** Press the Cursor Down button to select "Settings."
 - 3** Press the Cursor Right button to select the "General" menu.
 - 4** Press the Cursor Down button repeatedly to select the "OSD" control.
 - 5** Press the Cursor Right button to toggle between "Minimum" and "Normal."
- Normal mode**—the on-screen display stays on screen. Channel/Input source, call letters and program name (if provided by the signal source), picture format, and sound mode are shown.
- Minimum mode (default mode)**—channel/Input source, call letters, and program name (if provided by the signal source) are shown. The on-screen display disappears after a few seconds. In Minimum mode, the volume scroll bar will not be displayed when you press the volume control.
- 6** Press the Menu button to remove the on-screen menu from the TV screen.

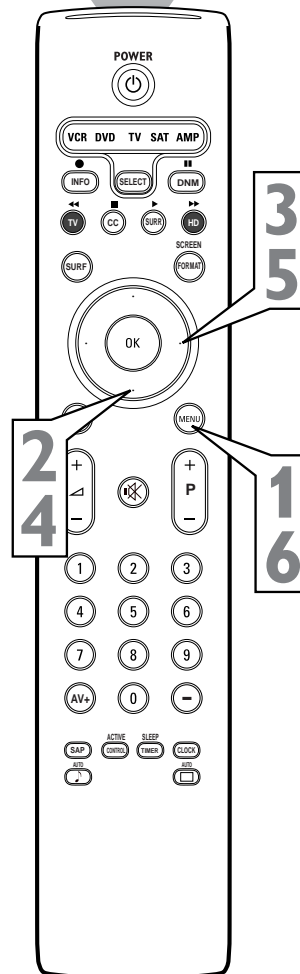
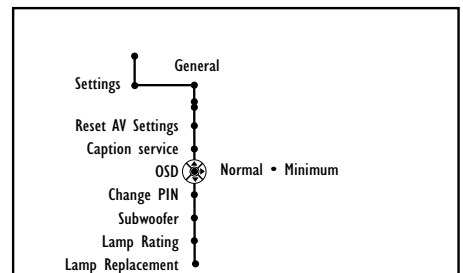
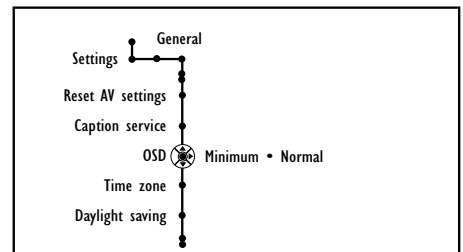
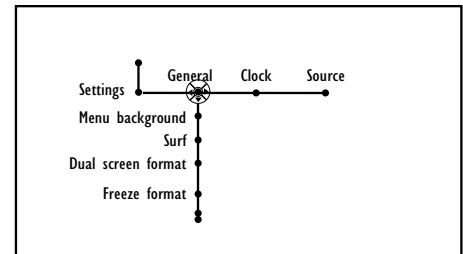
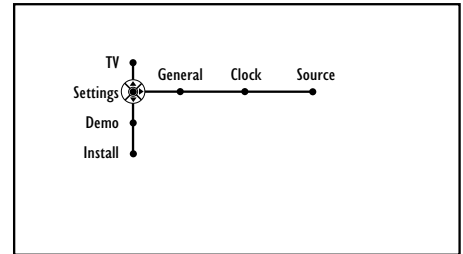
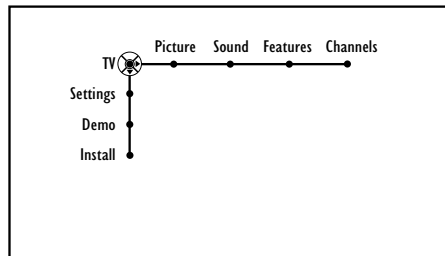
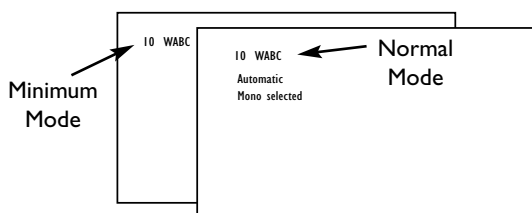

Setting up or Changing a PIN (Personal Identification Number)

G

In the General menu, you can set up a new PIN number or change an existing one for the Lock Channel feature.

- 1 Press the Menu button on the remote control to display the on-screen menu.
- 2 Press the Cursor Down button to select "Settings."
- 3 Press the Cursor Right button to select the "General" menu.
- 4 Press the Cursor Down button repeatedly to select either "Set PIN" or "Change PIN."

NOTES:

- If no PIN exists yet, the menu will show "Set PIN." Simply follow the on-screen instructions to set your PIN.
- If a PIN has previously been entered, the menu will show "Change PIN."
- All number combinations from 0000 to 9999 are valid numbers.

- 5 Press the OK or Cursor Right button to begin the process.
- 6 Enter your current PIN using the Digit buttons on the remote control.
If you have forgotten your PIN, you can enter the overriding/default PIN 0-7-1-1.
- 7 Enter a new four-digit PIN.
- 8 Re-enter your new PIN using the Digit buttons to confirm the code. Your PIN is now changed.
- 9 Press the Menu button on the remote control to remove the on-screen menu from the TV screen.

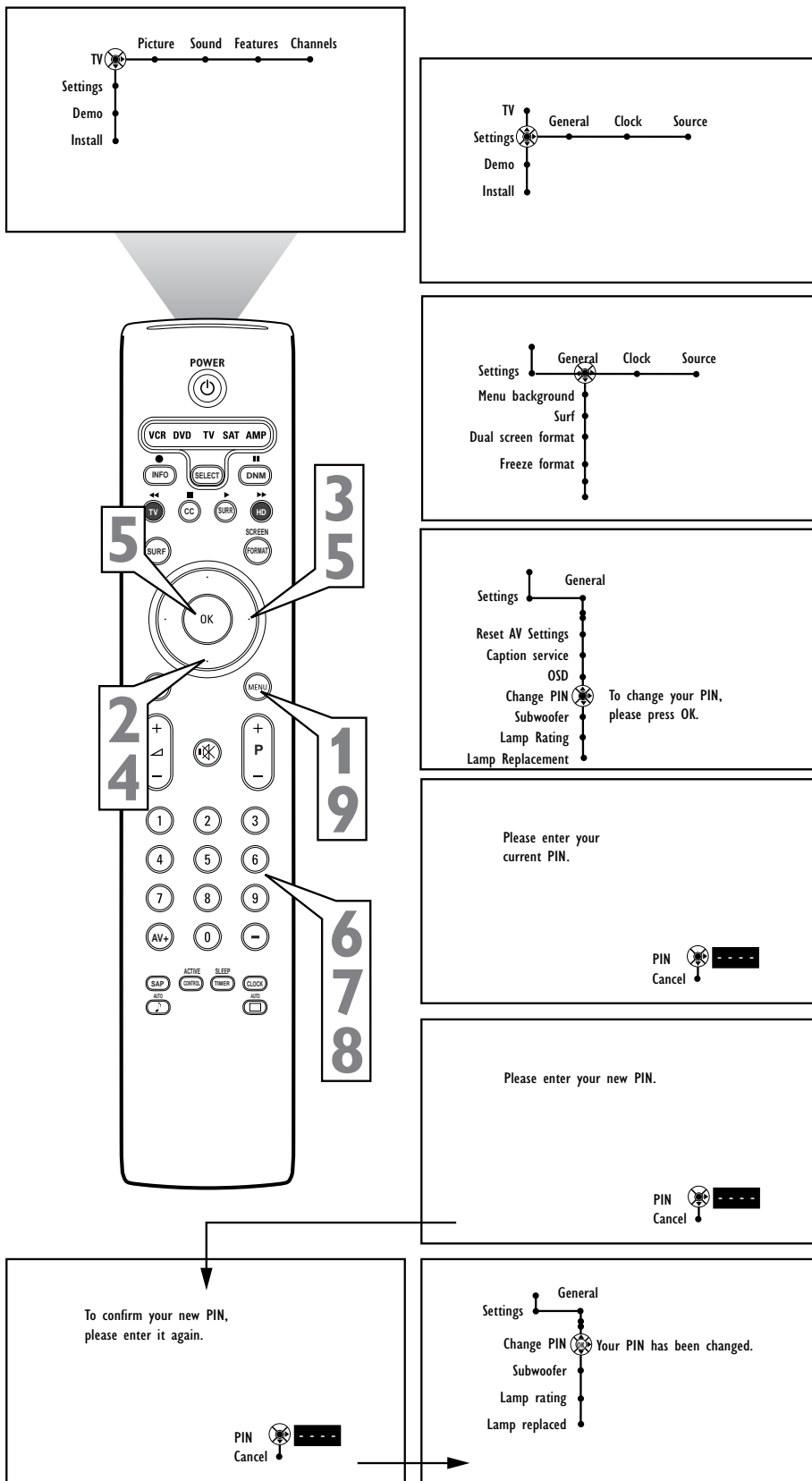

Setting the Subwoofer Control

If you connect a home-cinema surround-sound system with subwoofer to your TV (see page 15), you will need to select the Subwoofer "Yes" option in the TV's on-screen menu. These steps explain how.

- 1** Press the Menu button on the remote control to display the on-screen menu.
- 2** Press the Cursor Down button to select "Settings."
- 3** Press the Cursor Right button to select the "General" menu.
- 4** Press the Cursor Down button repeatedly to select the "Subwoofer" control.
- 5** Press the Cursor Right button to toggle the Subwoofer control to "Yes" or "No." Select Yes if you have connected an external subwoofer to the SUB OUT jack on the back of the TV.
- 6** Press the Menu button on the remote control to remove the on-screen menu from the TV screen.

HELPFUL HINT

"Yes" must be activated for the Subwoofer menu selection before the SUB OUT jack will supply output. This is because the subwoofer's low frequencies are redirected to the main TV speakers when "No" is selected.

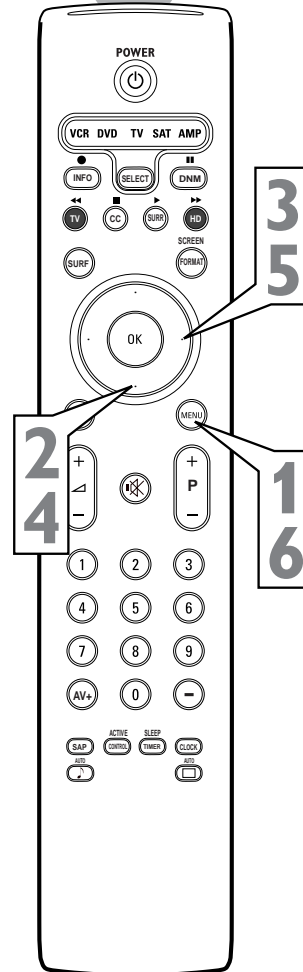
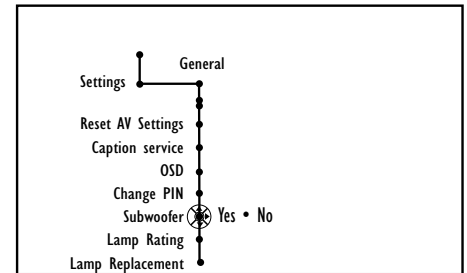
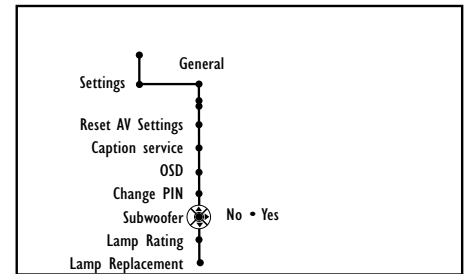
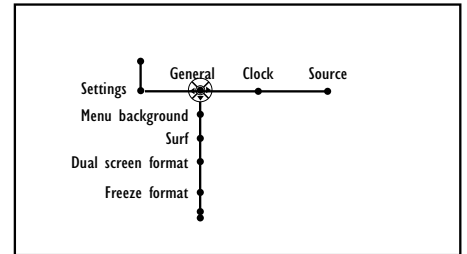
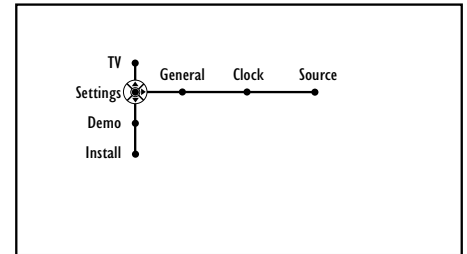
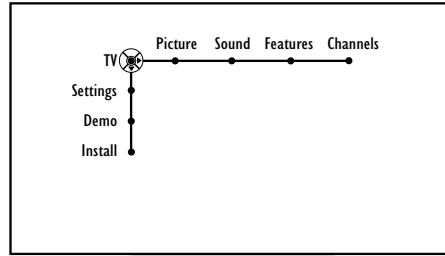

There are several features which require the TV clock to be set. You can either set the clock manually or have the TV acquire the time from the appropriate TV channel.

- 1** Press the Menu button on the remote control to display the on-screen menu.
- 2** Press the Cursor Down button to highlight “Settings.”
- 3** Press the Cursor Right button repeatedly to select the “Clock” menu.
- 4** Press the Cursor Down button to select Auto Clock Mode. Then Press Cursor Right Button to Select “Automatic” or “Manual.” Select Automatic to have the TV acquire the time from a the TV signal. Choose “Manual” to set the time yourself.

If you choose to set the time Automatically you will need to set the “AutoClock Channel” by continuing with steps 5-8 below. If you select manual you will need to make the correct settings by continuing on page 68.

Auto Clock Channel

- 5** After following steps 1-4 above, press the Cursor Down button to select Auto Clock Channel.
- 6** Press the Cursor Right button to enter the channel list. Select your local PBS channel by using the Cursor Up or Down buttons to scroll through the channel list or inputting the the channel using the number buttons.
- 7** Press the Menu button on the remote control to remove the on-screen menu from the TV screen.
- 8** Next Set the Time Zone and Daylight Savings Time. See page 69 for instructions.
- 9** You can always view the current time by pressing the “Clock” button on the remote control. Pressing the “Clock” button again will remove it from the display.

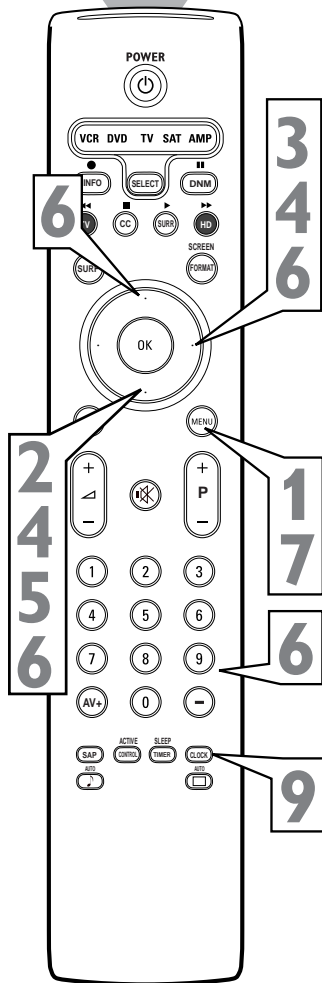
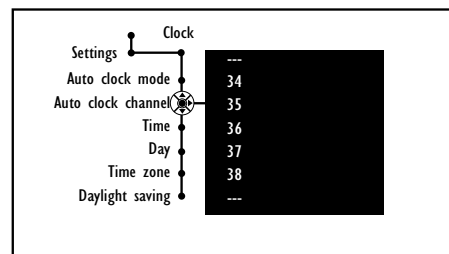
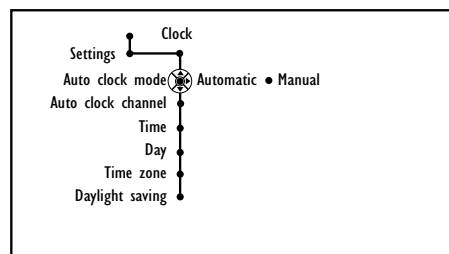
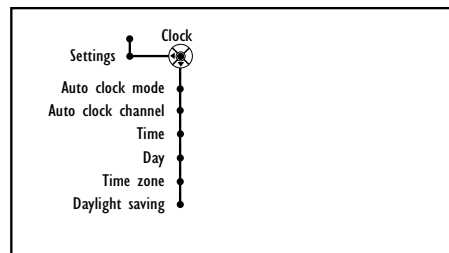
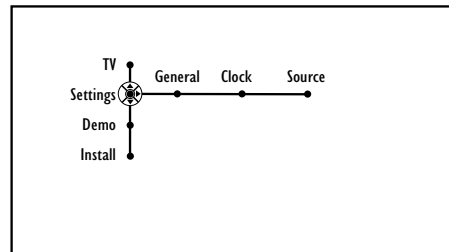
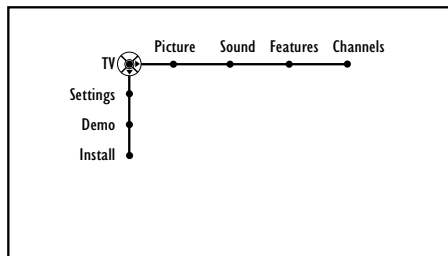

HELPFUL HINT

When the clock is set to “automatic” there will be a several second delay when the TV is turned on and off. During this delay the blue LED will blink. This is normal.

Setting the Clock Manually

If you select Manual in the Auto Clock Mode, you need to set the time manually.

- 1** Press the Menu button on the remote control to display the on-screen menu.
- 2** Press the Cursor Down button to highlight "Settings."
- 3** Press the Cursor Right button repeatedly to select the "Clock" menu.
- 4** Press the Cursor Down button to select Time.
- 5** Press the Cursor Right and Up or Down buttons to select AM or PM.
- 6** Press the Cursor Right button and use the number buttons to enter the current time. (For example, enter 0, 8, 3, and 0 if the time is 8:30 or 1, 2, 4, and 5 if the time is 12:45.) You can also use the Cursor buttons (Up, Down, Right, Left) and scroll through each number. Press Cursor Right to move to the next place.
- 7** Next press the Cursor Left button repeatedly to back out to the Clock Menu.
- 8** Press Cursor Down to select "Day". Then press Cursor Right to enter the list of days.
- 9** Press the Cursor Up or Down buttons to select the current day.
- 10** Press the Menu button on the remote control to remove the on-screen menu from the TV screen.
- 11** Next Set the Time Zone and Daylight Savings Time. See page 69 for instructions.

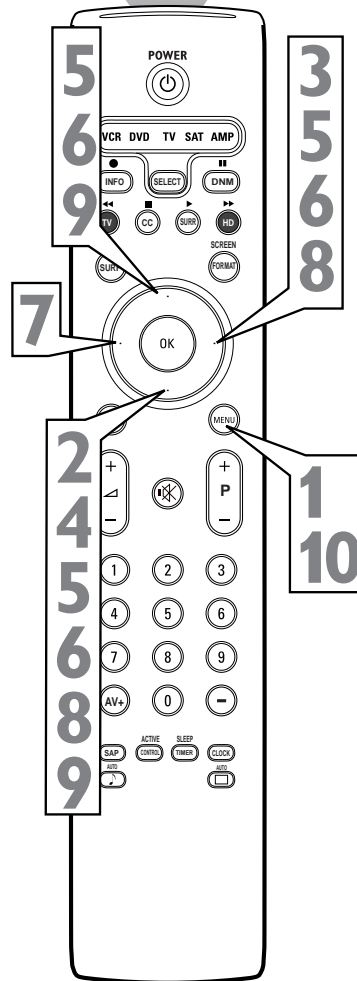
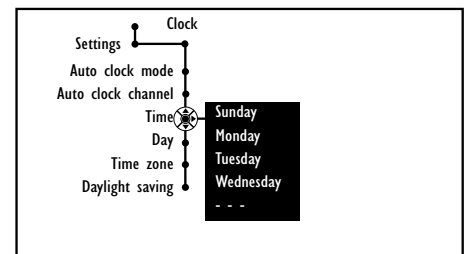
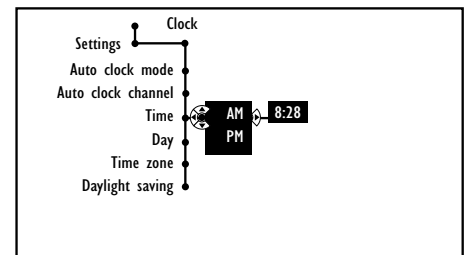
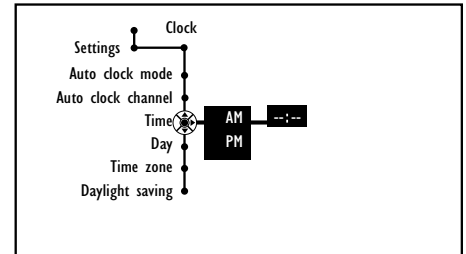
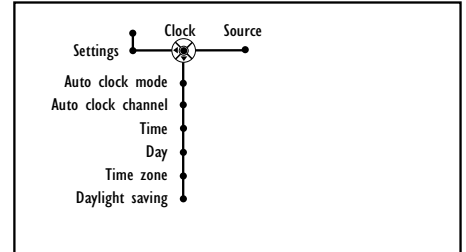
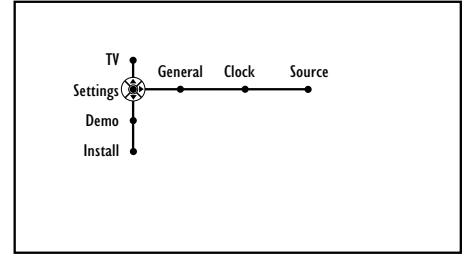
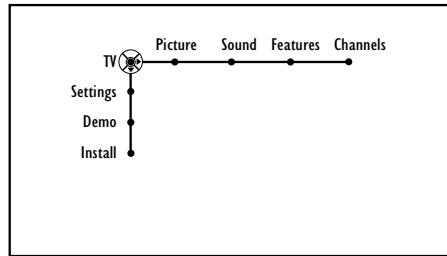

Selecting a Time Zone and Setting the Daylight Savings Control

Your television can acquire the current time from the signal being received. It needs to know your Time Zone, however, and whether or not you use Daylight Savings.

- 1** Press the Menu button on the remote control to display the on-screen menu.
- 2** Press the Cursor Down button to highlight "Settings."
- 3** Press the Cursor Right button repeatedly to select the "Clock" menu.
- 4** Press the Cursor Down button repeatedly to select the "Time Zone" control.
- 5** Press the Cursor Right button to enter the list of available time zones.
- 6** Press the Cursor Up or Down button to select your time zone.
- 7** Press the Cursor Left button, then press the Cursor Down button to select the "Daylight Savings" control.
- 8** Press the Cursor Right button to toggle "Daylight Savings" to "Automatic" for the TV to change to Daylight Savings Time automatically. Or select "Off."
- 9** Press the Menu button to remove the on-screen menu from the TV screen.

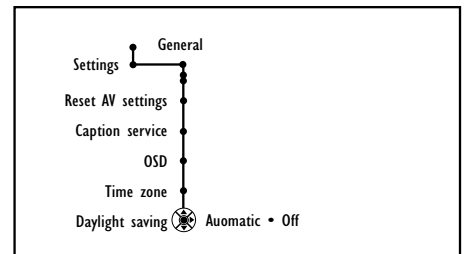
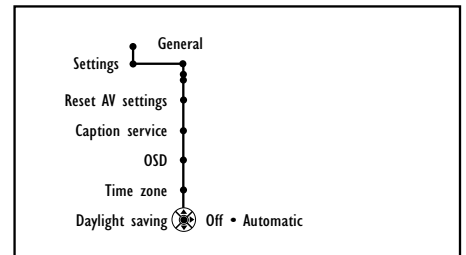
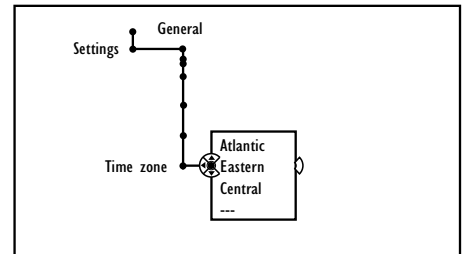
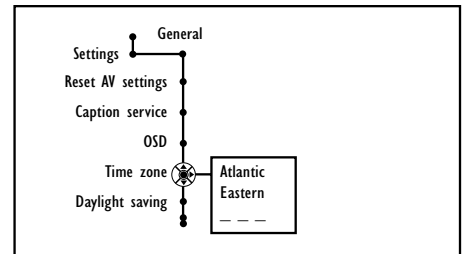
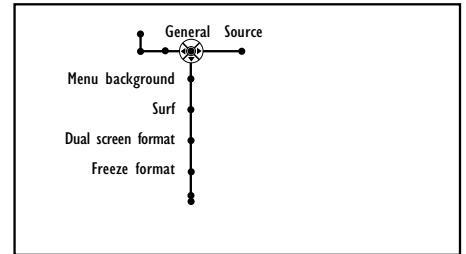
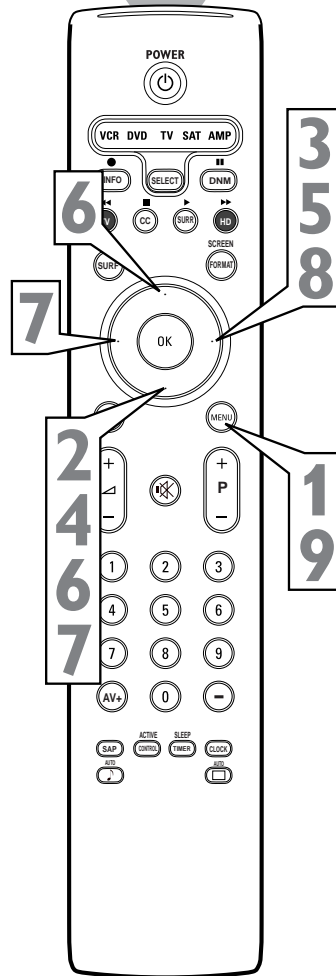
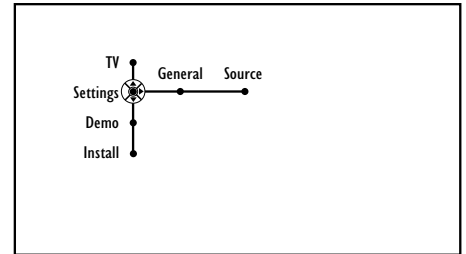
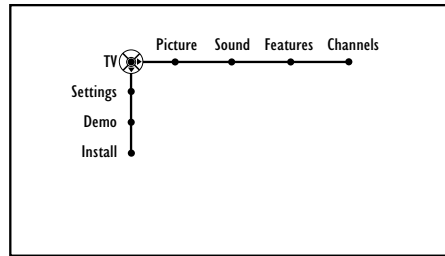

Using Installation Features: Language and Autoprogram

For Spanish- and French-speaking TV owners, an on-screen Language option is present. The Language control enables you to set the TV's on-screen menu to be shown in either English, Spanish, or French.

- 1** Press the MENU button on the remote control to show the on-screen menu.
- 2** Press the Cursor Down button repeatedly until "Install" is selected.
- 3** Press the Cursor Right button to shift the menu to the left and select "Language" or "Autoprogram."

For Language:

- 4** Press the Cursor Down button to select English, Español (Spanish), or Français (French).
- 5** After you have made your language selection, press the OK button to confirm your selection.
- 6** Press the MENU button to remove the on-screen menu from the TV screen.

For AutoProgram:

- 7** Press the Cursor Down button to select "Install" mode control.
- 8** Press the Cursor Right button to display a list of Install mode options: "Antenna," "Automatic," "Cable."
- 9** Press the Cursor Up or Down button to select one of the options. Select "Antenna" for normal outside- or inside-type antenna. Select "Cable" for a cable company supplied signal. When "Automatic" is selected, the TV will automatically set the mode based on the type of signal it detects coming into the TV. The programming process may be faster if you choose the specific type of connection you have made, either Antenna or Cable.
- 10** Press the Cursor Left button after making your "Install" mode selection.
- 11** Press the Cursor Down button to select "Install."
- 12** Press the Cursor Right button to start the programming process.
- 13** Press the Menu button to remove the on-screen menu from the TV screen when the Autoprogramming process has finished.

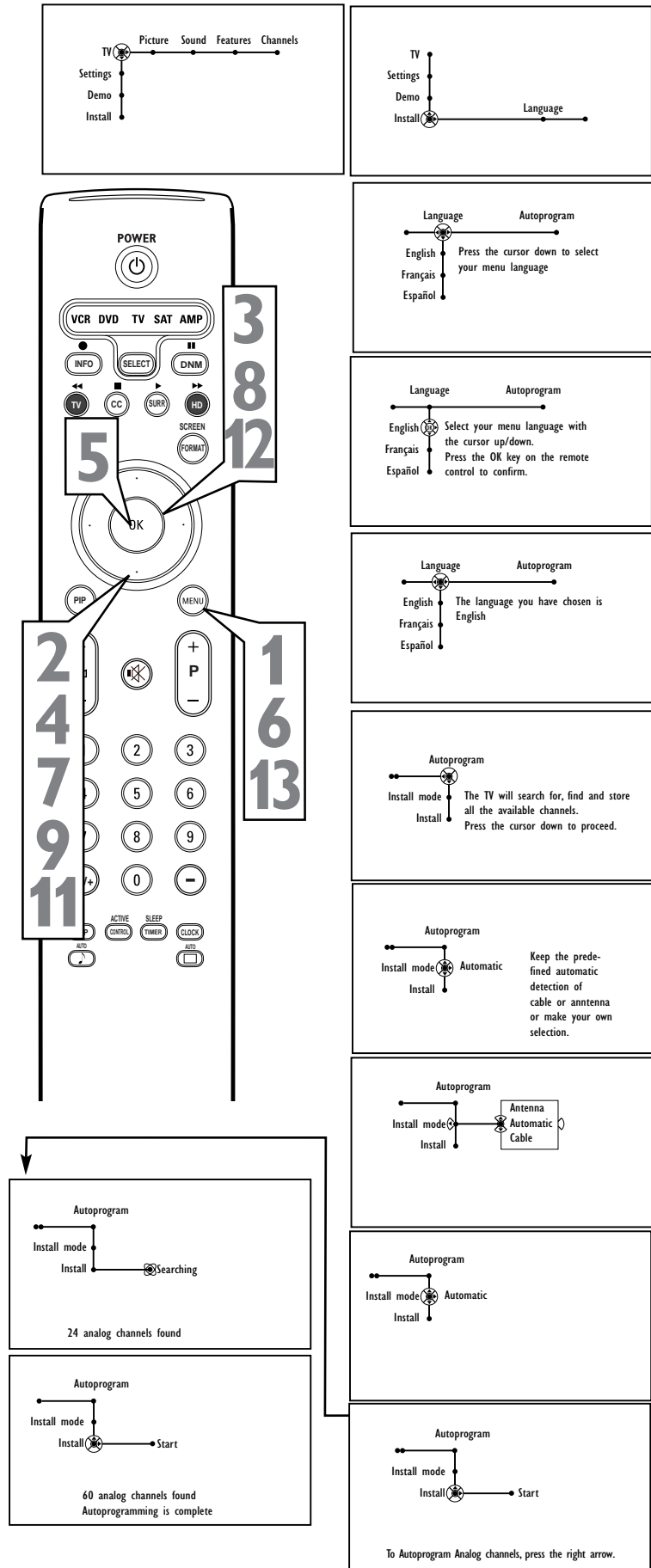



WARNING

To avoid possible shock hazard, be sure the TV is unplugged from the electrical outlet before cleaning.



Be sure the TV is unplugged before cleaning it.

Cleaning the Cabinet

- Regularly dust the TV cabinet with a dry, nonscratching duster.
- Gently wipe the cabinet surfaces with a soft, clean cloth.
- Occasionally vacuum the ventilation slots on the back cover of the set. See the next section on “Cleaning or Replacing the Filters.”
- Never use thinners, insecticide sprays, or other chemicals on or near the cabinet, as they might cause permanent marring of the cabinet finish.
- The television contains plastic parts. DO NOT use benzene, thinners, or other chemicals to clean. DO NOT use insecticide or other volatile substances nearby. DO NOT allow the TV to come into contact for extended periods of time with rubber or vinyl products.

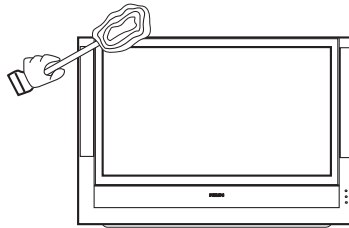

Use a nonscratching duster.

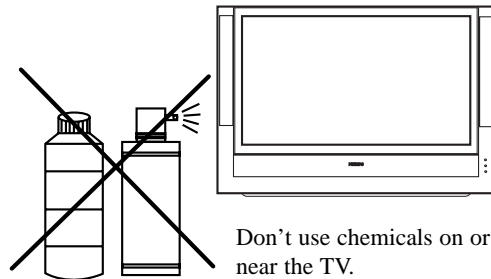

Don't use chemicals on or near the TV.

Cleaning the Screen

- Use a soft dry cloth to wipe the screen. Use even, easy, vertical strokes. Take care not to scratch or damage the screen surface. Avoid wearing jewelry or using anything abrasive.

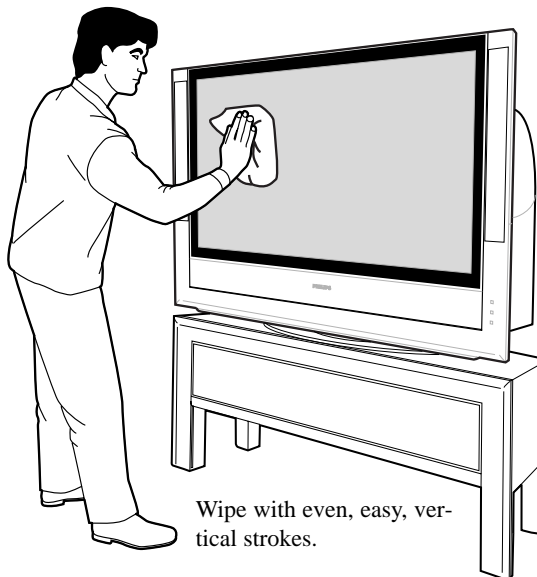

Wipe with even, easy, vertical strokes.



Avoid wearing jewelry that may scratch the TV.



Cleaning or Replacing the Filters

The Cineos TV has two filters that cover air inlets on the bottom of the set. Maintaining a free flow of air through the inlets is very important. If the air filters become dirty, clogged, or blocked, the temperature in the set will rise.

Should the heat level become too high due to blockage, a sensor detects this, and a warning message appears on screen alerting you to check the air inlets for blockage. The message will be displayed for 6 seconds. It reappears every 15 minutes as long as the temperature remains too high.

If the internal temperature of the TV rises to high, a warning message alerts you that the TV is shutting down. If the temperature remains at this high level for 1 minute, the TV will enter Standby mode. In Standby mode, the TV is off.

Be sure the TV is not placed on a surface (such as a shag carpet) that will prevent the free flow of air through the inlets, and periodically clean or replace the filters as detailed in the following instructions.

WARNING: Do not tip the TV when removing or installing the filters. This may result in instability of the TV.

1 Place your fingers under one of the filter slots located at either bottom left or right in back of the TV cabinet.

2 Grasp the filter and gently pull it straight out.

3 Examine the filter for dust or other contamination. If it is dirty, clean it with a vacuum cleaner. **DO NOT WASH** it. Replace the filter if vacuuming does not sufficiently clean it.

To order replacement filters, call the Philips Customer Care Center at 1-800-531-0039. The part number for the Philips TV inlet filter assembly is 3135 037 51810.

WARNING:

DO NOT operate the TV without filters. This will cause serious damage to the TV.

4 Turn the filter so that the arrow is pointing toward the center of the TV. Align the edges of the filter with the slot track, then gently slide it all the way back into the slot. A click sound can be heard as the filter reaches the correct position.

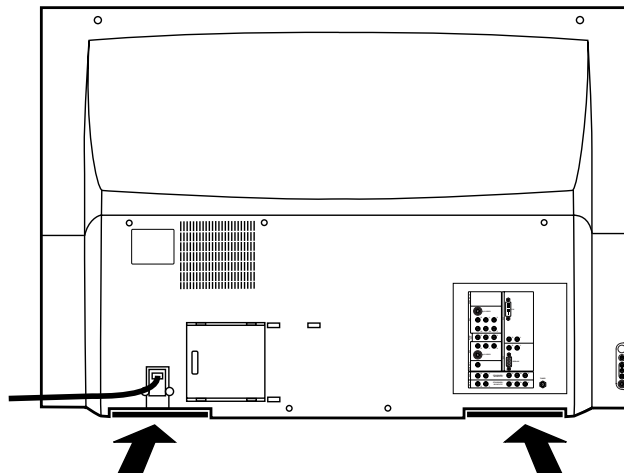

Locations of Air Filters

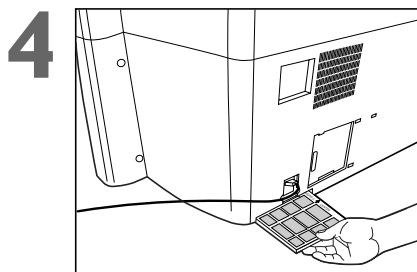
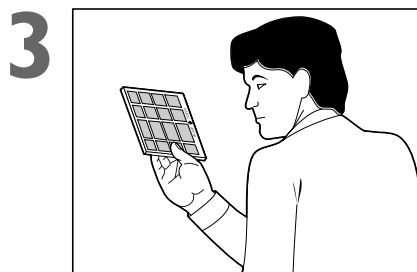
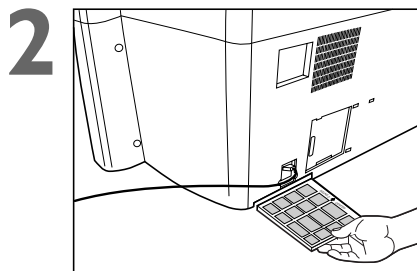
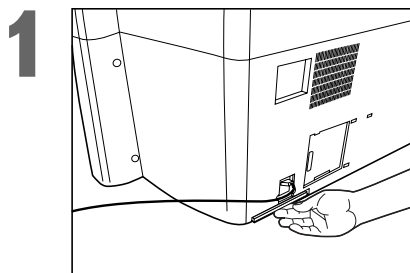

Replacing the Lamp



The Cineos TV uses a lamp with a limited lifetime to illuminate the picture. A Lifetime counter in the TV records the operating time of the lamp. One hundred hours before the lamp reaches the end of its life, a warning message will appear on screen. This will allow you to prepare to replace the lamp or take action right away. The message will disappear within 6 seconds. It will reappear each time the TV is turned on until the lamp is replaced.

To order a replacement lamp, call the Philips Customer Care Center at 1-800-531-0039. A Philips associate will be happy to assist you. The part number for the Philips TV replacement lamp is 3122 438 71310.

Here are the steps for replacing the lamp:

- 1** Power off the TV. Unplug the TV.
- 2** The lamp door is located on the back of the TV next to the power cord. Gently slide the door completely to the right to open.
CAUTION: The lamp gets extremely hot. Allow a cool-down time before removing the lamp.
- 3** Unscrew the thumb screws until they are dangling.
- 4** Lift the handle out.

Continued on page 72.

A blinking orange light in the Active Standby Window means that the lamp needs to be replaced.

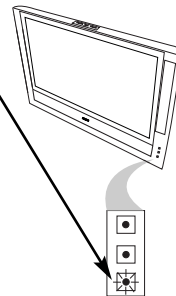

1



2

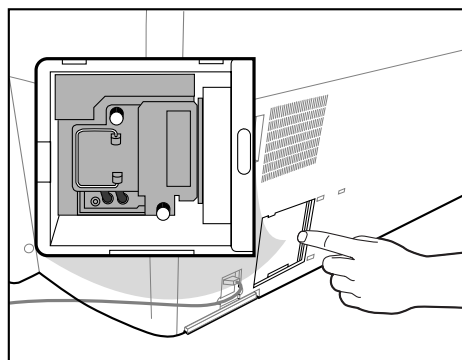

3

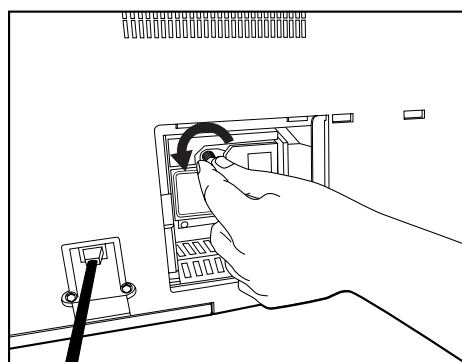

4

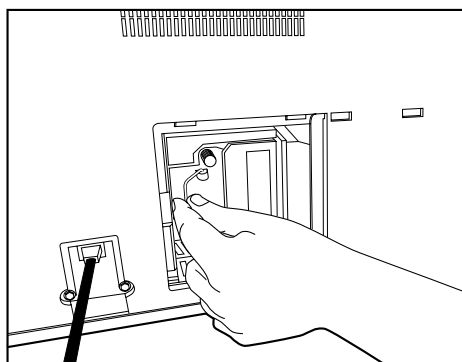



Replacing the Lamp

Continued from page 71.

5 CAUTION: When removing the lamp, do not touch the glass envelope. It may still be hot.

Grasp the handle, then pull out and slightly down to remove.

WARNING: The lamp contains mercury. Dispose of the lamp in accordance with local, state, and federal regulations.

6 CAUTION: When installing the new lamp, do not touch the glass envelope. Oil from skin can reduce lamp life.

Align the groove on top of the new lamp's housing with the corresponding groove pocket inside the TV, then slide the new lamp into place.

7 Tighten the thumb screws clockwise until finger tight only. Do not over-tighten.

8 Slide the lamp door closed.

IMPORTANT: The door must be closed completely to the left. Otherwise, the TV will not operate.

9 Go to page 69 for instructions for setting the Lamp Rating and resetting the Lamp Lifetime Counter.

5

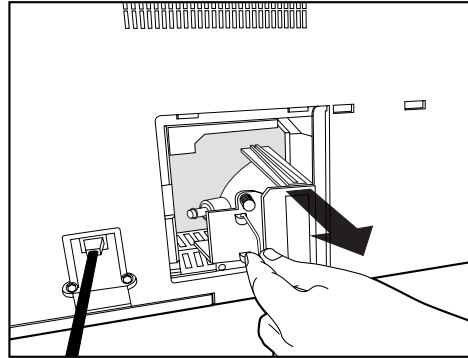

6

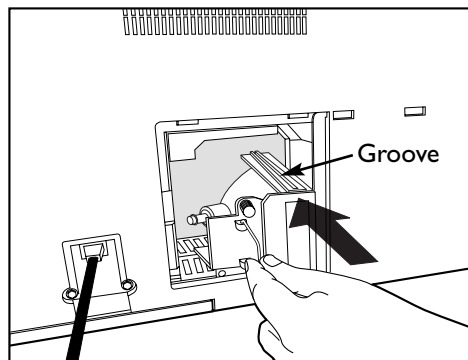

7

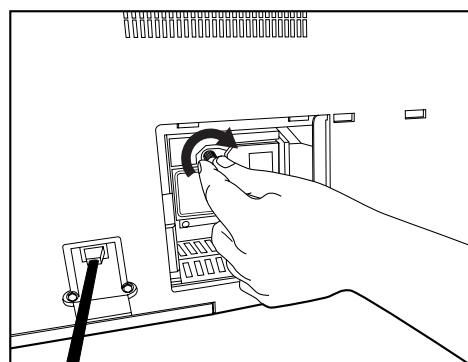

8

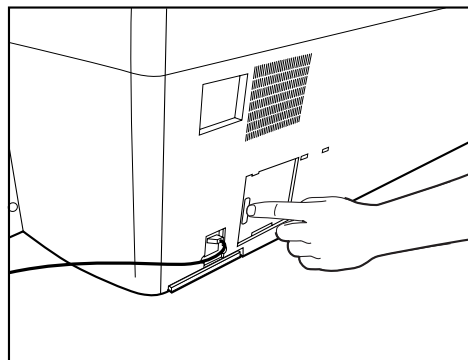

9

Go to page 69 for instructions for resetting the Lamp Lifetime counter through the TV's on-screen menu.

Resetting the Lamp's Lifetime Counter



After installing a new lamp in the TV, you need to enter the "Lamp rating" list in the on-screen menu and select the alphabetical code that is provided with the lamp. The recommended Philips replacement Lamp is rated for 6000 hours, an F rating

The next step is to use the "Lamp replaced control" to tell the TV that you have installed a new lamp. This control resets the Lifetime Counter to 0 for the new lamp and begins keeping track of the lifetime of the new lamp.

- 1** Press the Menu button on the remote control to display the on-screen menu.
- 2** Press the Cursor Down button to select "Settings."
- 3** Press the Cursor Right button to select the "General" menu.
- 4** Press the Cursor Down button repeatedly until "Lamp rating" is selected.
- 5** Press the Cursor Right button to enter the rating list.
- 6** If necessary, press the Cursor Down button as many times as necessary to select the letter for your replacement lamp.
- 7** Press the Cursor Left button to return to the "General" menu.
- 8** Press the Cursor Down button to select "Lamp replaced."
- 9** Press the OK button to confirm that you have changed the lamp.
- 10** Press the Menu button to remove the on-screen menu from the TV screen.

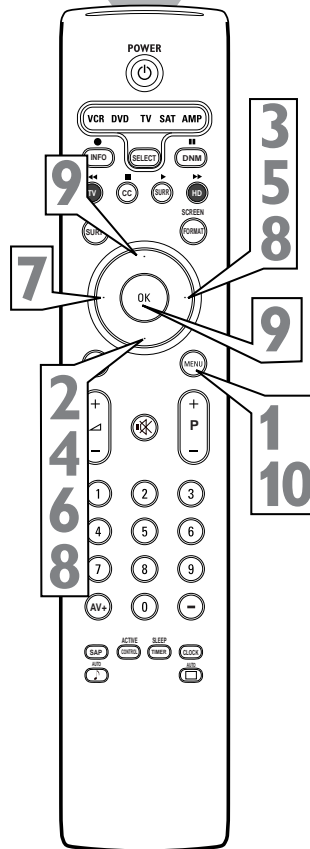
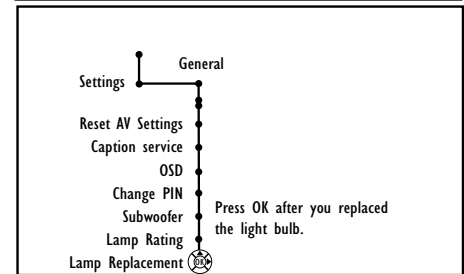
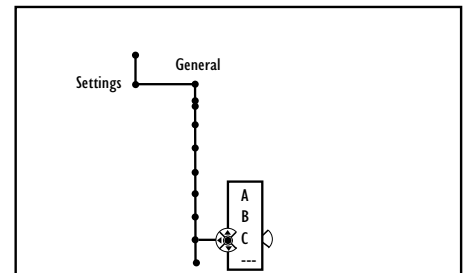
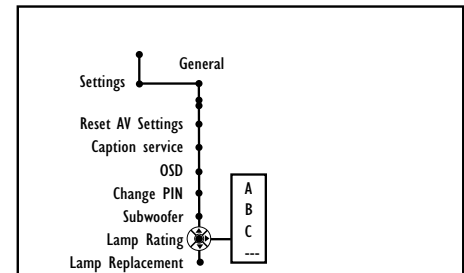
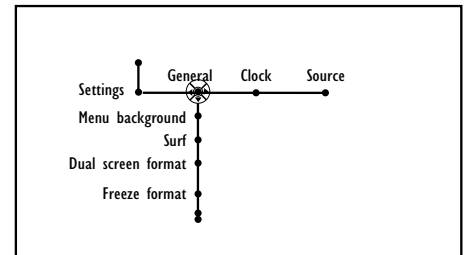
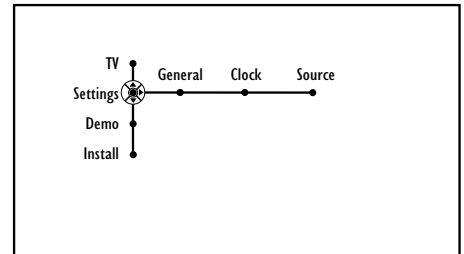
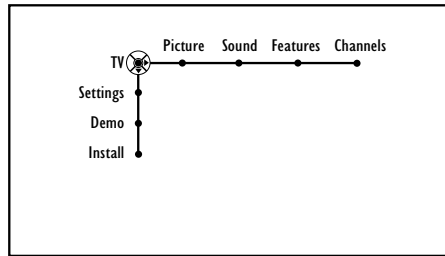

HELPFUL HINTS

- One hundred hours before the lamp reaches the end of its life, a warning message will appear on screen to alert you. Changing the lamp at this point is recommended for optimal performance.
- A blinking orange light on the front of the set means that the lamp is not working anymore and needs to be replaced.



Review This List of Symptoms and Checks Before Requesting Service

You may be able to solve the problem yourself. Charges for TV installation and adjustment of customer controls are not covered under your warranty.

If you need to call a customer service representative, please know the model number and serial number of your product before you call. This information is displayed on the back of the product. Also, please take a moment to identify the problem you are having, and be prepared to explain this to the representative. If you believe the representative will need to help you with operations, please stay near the product. Our representative will be happy to assist you. **To reach our Customer Care Center, call 1-800-531-0039.**

Reset your Cineos TV

- Modern TVs are complicated systems which consist of multiple hardware and software subsystems which operate in conjunction with each other. One consequence of the increasing complexity of televisions is that they often require some additional time to fully power on or off as all of the subsystems must power up or down as well. Occasionally one of these subsystems may not fully engage or disengage before an additional function is begun- for example pressing numerous buttons on the remote before the set is fully powered up. In such cases, the set may appear to be frozen or non-responsive.

If you are experiencing unexpected behavior from your Cineos TV the first possible fix is to unplug the set from the outlet for a minute or so. This will ensure that all subsystems are fully powered down. Then plug it back in after which the Cineos will restart and perform internal diagnostics which should result in normal operation.

TV-related Checks

The TV won't switch on.

- Make sure the power plug is plugged in.
- If you're using the TV remote control to turn the TV on, be sure the remote is in TV mode. (pages *Q6, 24.)
- Plug something else in to be sure the wall outlet (or extension cord) is receiving power.
- The remote control could have a problem. See the troubleshooting section "Remote-related Checks" on page 71.
- Make sure the lamp door is not ajar. The TV is designed not to operate with the lamp door open. (pages *Q1, 69–70)
- If a red light is blinking on the front of the TV, the set has entered protection mode. If this happens it usually means you simply need to reset the TV. Unplug the TV for 60 seconds. Then plug the TV in and try to switch it on. If the light is still blinking red, call the Customer Care Center at 1-800-531-0039.

The TV switches off unexpectedly.

- If the lamp door is opened, the TV will shut down. The TV is designed not to operate when the lamp door is ajar.
- If a red light is blinking on the front of the TV, the set has entered protection mode. Unplug and plug the set back in a couple of times and try to switch it on. If the problem persists, contact the Customer Care Center at 1-800-531-0039.
- The Sleptimer may have been set to turn the TV off. Turn the TV back on if desired. (page 45)

The TV switches on unexpectedly.

- The On Timer may have been set. (page 46)

An on-screen message tells you that it is time to replace the lamp.

- The message appears on screen when the lamp has 100 hours of life left, and will reappear each time the TV is turned on until the lamp is replaced. Prepare to replace the lamp or take action right away. (pages 71–73)

An on-screen message instructs you to check the air inlets for blockage.

- Check the air inlets and filters for blockage and clean or replace the air filters as necessary. (pages 69–70).

You have a picture but no sound.

- Make sure Mute is not on. (page *Q6)
- The TV speakers may be turned off. Make sure the Center Channel Amp Switch on the back of the TV is in the INT position. (page 7)

*Q refers to the *Quick Use and Setup Guide* that came with your TV.



TV-related Checks (continued)

You have no picture.

- If you have made a connection to the TV's Tuner jack be sure to use Autoprogram. (page *Q8).
- If you want to view materials from an accessory device (DVD player, VCR, or satellite receiver, for example) be sure you have selected the input source to which you have connected the device—AV1, AV2, AV3, AV4, AV5, AV6, or Side. (pages *Q4, *Q6, 10–16, 18, 20)
- Make sure you have made connections correctly. (pages *Q3–5, 10–16, 18, 20)

You have no picture and no sound.

- If you see a blinking orange light on the front of the set, this means that the lamp needs to be replaced. (pages 71–73)

You see scrolling images.

- Make sure you have made connections correctly. (pages *Q3–5, 10–16, 18, 20)

The picture appears doubled or tripled.

- If you are using an antenna, be sure it is facing in the correct direction. Also, check to see if it may be receiving signals that are being reflected off of mountains or buildings.

The picture shakes or is not clear.

- If you are using an antenna, make sure it is not broken or shorted, and make sure the antenna cable is connected properly and securely.
- If you are using a VCR and selecting channels on the TV, make sure the TV/VCR mode on the VCR is set to TV.

The picture has no colors or colors are not correct.

- Make sure you have made connections correctly. (pages *Q3–5, 10–14, 16, 18)
- If you have connected accessory equipment, such as an HD satellite receiver, make sure the color setting on the accessory equipment is correct. See the user manual for the HD satellite receiver.

The TV sound has an unusual quality.

- Check the TV's Equalizer control to be sure it is set to the option you want. (page 33)

Remote-related Checks

The remote control does not work.

- Make sure nothing is blocking the path between the remote control and the TV or accessory device you want to operate.
- Make sure you point the remote directly at the TV or accessory device you want to operate.
- If you want to operate the TV, make sure the remote is in TV mode. If a green light is flashing the remote is in an accessory mode, press the Select button once. If you want to operate an accessory device, program the remote to operate the device if necessary and make sure the remote is in the appropriate mode for the device. (pages *Q6, 22–28)
- Make sure you have installed the batteries correctly. (page *Q6)
- The batteries could be dead. When the batteries in the remote run low, the remote will send a “Battery Low” command to the TV. The TV will then display a message on the screen reminding you to replace the batteries as soon as possible.
- You may want to try taking the remote batteries out and then putting them back in. **NOTE:** After taking the batteries out, you may need to reprogram the remote for use with accessory devices.

*Q refers to the *Quick Use and Setup Guide* that came with your TV.



Product Specifications

Picture

- Screen Size
55PL9524 & 55PL9224: 55" measured diagonally
62PL9524: 62" measured diagonally
- Aspect ratio: 16:9
- Display technology: Philips single-panel LCOS (Liquid Crystal on Silicon)
- Flicker free; perfect convergence
- Resolution: 1280 x 720
- 1080i HD performance and line doubling
- Contrast ratio: 400:1
- Digital Natural Motion™
- Active Control™
- Widescreen Plus
- Picture Freeze

Sound

- Sound system: Hi-fi Stereo
- Virtual Dolby* Surround processing
- Output: 2 x 20W RMS at 2% distortion
- For 55PL9524 & 62PL9524
- Output: 2 x 15W RMS at 2% distortion
- For 55PL9224
- Frequency response: 20Hz–15kHz, +1/-3dB (ampl.)
- Loudspeaker configuration: two 2"/two 5"
- Control: Volume, 5-band Audio Equalizer Controls (with adjustments at 120Hz, 500Hz, 1.5KHz, 5KHz, and 10KHz), Balance, AVL (on/off), and Headphone (volume, balance)
- Subwoofer out

Operation

- Easy, menu-driven installation and operation; direct-access menus and cursor control
- Selection of three menu languages: English, French, and Spanish
- On-screen status display on programs and functions (on screen display)
- Sleptimer
- Favorite channel listing
- AutoLock™ to protect children from objectionable programming with V-chip technology
- Closed Captioning
- AutoPicture™ control: Soft, Natural, Rich, Multimedia, Personal
- AutoSound™ control: Movie, Speech, Music, Personal

- Eight widescreen modes: Automatic, Super Zoom, Panoramic, 4:3, Movie Expand 14:9, Movie Expand 16:9, 16:9 Subtitle, and Wide Screen
- Subtitle and heading shift (scroll the screen with the cursor buttons)
- Auto Format/Auto Screen Fit
- Smart Clock

Miscellaneous

- Mains: AC 110V ± 10%
- Power consumption: Normal operation: 233W
Standby: <1W
- Input and output jacks (see page 7)
- Product dimensions (d x w x h)
55PL9524 & 55PL9224: 17.4" x 56.6" x 38.1"
62PL9524: 18.2" x 62.3" x 43.3"
- Product weight (excluding packaging)
55PL9524 & 55PL9224: 95.5 lbs
62PL9524: 125 lbs
- Universal remote control: RC4336, universal RC managing TV and accessory devices

Supporting Features

- Digital Color Transient Improvement (CTI)
- Picture Freeze
- Auto Aspect Ratio Adaptation
- Incredible Surround™
- Automatic Volume Leveler (AVL)
- Independent headphone volume control
- Easy Tune™ (auto search, auto tune, auto install)
- Alternate channel
- AutoSurf™
- Low-power standby (<1W)

Supplied Accessories

- Remote control with two "AA" size batteries

Design and specifications are subject to change without notice.

Parts that will need to be replaced at some point during the life of the product:

- Philips TV inlet filter assembly: part number 3135 037 51810
- Philips TV lamp: part number 3122 438 71310.

To order the parts, contact the Philips Customer Care Center at 1-800-531-0039.

*Manufactured under license from Dolby Laboratories. "Dolby" and the double-D symbol are trademarks of Dolby Laboratories.

AutoLock and Easy Tune are trademarks of Philips Consumer Electronics. Copyright 2004 Philips Consumer Electronics. All rights reserved.



A

Active Control™ Plus, 28
 Active Control™ Plus Window, *Q5
 Active Standby Window, *Q5
 Alternate Audio (SAP) Control, 42
 Antenna Attenuator, 56
 Audio/Video Input Sources, Labeling, 19
 AutoPicture™ Options, 34
 AutoSound™ Options, 46
 AVL (Auto Volume Leveler), 44
 AV5 Clock Frequency and Phase, Adjusting, 15

B

Blocking Programs
 Based on TV Ratings, 54
 Based on Movie Ratings, 55

C

Cabinet
 Buttons, *Q5
 Windows, *Q5
 Channel List, 50
 Channels, Programming into the TV's
 Memory, *Q8
 Cleaning the TV, 69
 Closed Captioning, 47
 Color Enhancement, 33
 Connections
 Camcorder, 16
 Computer, 14
 HD Satellite Receiver to DVI, 16
 HD Satellite Receiver to YPbPr, 15
 Progressive-scan DVD Player, 14
 Standard DVD Player, 13
 Surround Sound, 17
 S-Video, 12
 VCR, 10
 VCR and Cable Box, 11
 Video Game System, 18

D

Daylight Savings, Setting, 67
 Delta Volume, 45
 Digital Processing Options, 30
 Dolby** Virtual (See Sound Mode Options)
 Dual Screen Format
 Changing Channels or Input Sources, 59
 Selecting, 58
 DVI Input Jack, 7–8, 14
 Dynamic Contrast Options, 31
 Dynamic Noise Reduction Options, 32

F

Factory Service Locations, 78–79
 Features, List of, 5
 Filters, Cleaning or Replacing, 70

H

Headphone Volume, Adjusting, 37

I

Incredible Surround™ (See Sound Mode
 Options)

J

Jacks/Cables/Connectors, Descriptions, 7

L

Lamp
 Replacing, 71–72
 Resetting the Lifetime Counter, 73
 Lamp Lifetime Counter, 73
 Lamp Rating Control, 73
 Language, Setting for the On-screen
 Menu, *Q8
 Lock After, 53
 Lock Channel, 52
 Loudness Control, 40

O

On-screen Displays Options, 62
 On Timer, 49
 Overheating, Preventing, *Q1-2, 9, 70

P

Panel Jacks, Compatibility Information, 7–8
 Panning the Screen (with Cursor Buttons),
 *Q6, 16, 35
 Picture Controls, 29
 Picture Format Options, 35–36
 Picture Freeze Options, 60
 PIN, Setting up or Changing, 63
 PIP, 58
 Power Surges, Protecting Against, 9
 Pre-connection Recommendations, 9
 Product End of Life Disposal, 5

R

Remote Control
 Programming, 20–22
 Using with the TV, *Q6
 Using with Accessory Devices, 22–27
 Remote Sensor Window, *Q5
 RGB+HV Input Jack, 7–8, 14

S

Safety Information/Instructions, *Q1, *Q2, 2,
 3, 9
 SAP (See Alternate Audio [SAP] Control)
 Service (See Factory Service Locations)
 Signal Splitter, *Q4, 8, 11
 Sleptimer, 48
 Sound Mode Options, 41

Specifications, Product, 76
 Stand (Optional), Mounting, *Q3
 Stereo, Selecting, 43
 Subwoofer
 Output Jack, 7–8, 17
 Control (in on-screen menu), 17
 Surf Options, 54
 Surround Sound (See Connections and Sound
 Mode Options)
 S-Video Input Jacks, 7–8, 12
 Swivel (Optional), Mounting, *Q2

T

Time Zone, Selecting, 67
 Troubleshooting, 74–75
 Tuner (RF) Input Jack, *Q3–5, 7–8
 TV Equalizer Options, 38
 TV Signals
 Information on, 6
 Ways of Receiving, 6
 TV Speaker Balance, 39
 Twin-lead Adapter, 8

V

Video Game System (See Connections)
 Volume, Adjusting
 Headphone, 37
 TV, 35

W

Warranty, 80
 Welcome, 2

Y

YPbPr Input Input Jacks, 7–8, 13–15

*Q refers to the *Quick Use and Setup Guide* that came with your TV.

**Manufactured under license from Dolby Laboratories. “Dolby” and the double-D symbol are trademarks of Dolby Laboratories.



Limited Warranty

PHILIPS TELEVISION

One Year Free Labor

One Year Free Service on Parts

30 days Free Service on Television Screen

This product can be repaired in-home.

WHO IS COVERED?

You must have proof of purchase to receive warranty service. A sales receipt or other document showing that you purchased the product is considered proof of purchase.

WHAT IS COVERED?

Warranty coverage begins the day you buy your product. For one year thereafter (30 days for the TV screen), all parts will be repaired or replaced, and labor and transportation are free. After one year from the day of purchase, you pay for the replacement or repair of all parts and for all labor and transportation charges.

All parts, including repaired and replaced parts, are covered only for the original warranty period. When the warranty on the product expires, the warranty on all replaced and repaired parts also expires.

WHAT IS EXCLUDED?

Your warranty does not cover:

- labor charges for installation or setup of the product, adjustment of customer controls on the product, and installation or repair of antenna systems outside of the product.
- product repair and/or part replacement because of misuse, accident, unauthorized repair or other cause not within the control of Philips Consumer Electronics Company.
- reception problems caused by signal conditions or cable or antenna systems outside the unit.
- a product that requires modification or adaptation to enable it to operate in any country other than the country for which it was designed, manufactured, approved and/or authorized, or repair of products damaged by these modifications.
- incidental or consequential damages resulting from the product. (Some states do not allow the exclusion of incidental or consequential damages, so the above exclusion may not apply to you. This includes, but is not limited to, prerecorded material, whether copyrighted or not copyrighted.)
- a product used for commercial or institutional purposes.

WHERE IS SERVICE AVAILABLE?

Warranty service is available in all countries where the product is officially distributed by Philips Consumer Electronics Company. In countries where Philips Consumer Electronics Company does not distribute the product, the local Philips service organization will attempt to provide service (although there may be a delay if the appropriate spare parts and technical manual(s) are not readily available).

MAKE SURE YOU KEEP...

Please keep your sales receipt or other document showing proof of purchase. Attach it to this owner's manual and keep both nearby. Also keep the original box and packing material in case you need to return your product.

BEFORE REQUESTING SERVICE...

Please check your owner's manual before requesting service. Adjustments of the controls discussed there may save you a service call.

TO GET WARRANTY SERVICE...

Repair must be performed by an authorized service center or a factory service center. *If you do not live near a factory service center, contact your dealer.* If your dealer is an authorized service center, he will arrange repair. If your dealer is not an authorized service center, he will direct you to the authorized service center engaged by him to service the products he sells.

(In U.S.A., Puerto Rico and U.S. Virgin Islands, all implied warranties, including implied warranties of merchantability and fitness for a particular purpose, are limited in duration to the duration of this express warranty. But, because some states do not allow limitations on how long an implied warranty may last, this limitation may not apply to you.)

(In Canada, this warranty is given in lieu of all other warranties. No other warranties are expressed or implied, including any implied warranties of merchantability or fitness for a particular purpose. Philips is not liable under any circumstances for any direct, indirect, special, incidental or consequential damages, howsoever incurred, even if notified of the possibility of such damages.)

IF YOU HAVE QUESTIONS...

Please contact Philips at:

- 1-888-PHILIPS**, if calling from the USA (English or Spanish Speaking)
- 1-800-661-6162**, if calling from Canada (French Speaking)
- 1-888-PHILIPS**, if calling from Canada (English or Spanish Speaking).

REMEMBER...

Please record below the model and serial numbers found on the product. Also, please fill out and mail your warranty registration card promptly. It will be easier for us to notify you if necessary.

MODEL # _____
 SERIAL # _____

This warranty gives you specific legal rights. You may have other rights which vary from state/province to state/province.

Philips Consumer Electronics, P.O. Box 520890, Miami, FL 33152

Free Manuals Download Website

<http://myh66.com>

<http://usermanuals.us>

<http://www.somanuals.com>

<http://www.4manuals.cc>

<http://www.manual-lib.com>

<http://www.404manual.com>

<http://www.luxmanual.com>

<http://aubethermostatmanual.com>

Golf course search by state

<http://golfingnear.com>

Email search by domain

<http://emailbydomain.com>

Auto manuals search

<http://auto.somanuals.com>

TV manuals search

<http://tv.somanuals.com>