

Quick Use and Setup Guide

HDTV Monitor
55PP9401
60PP9401

Let's make things better.



PHILIPS

TABLE OF CONTENTS

Safety/Important Notice	1	Selecting the Tuner Mode	5
Best Viewing	1	Using the Auto Program Control	5
Making a Basic Antenna or Cable TV Hookup	1	Using the Channel Edit Control	6
Making a Basic VCR Hookup	2	Using the Channel List Control	6
Using the Front Panel Jacks	2	Setting the TV's Clock	7
Performing Basic TV Operations	3	Using the Auto IntelliSense™ Focus Control	7
Learning Remote Control Buttons	3	Using the Formats Control	8
Using the On-screen Menu	4	Learning More about the Rear Panel Jacks	8
Setting the Language Control	4		

WARNING: TO PREVENT FIRE OR SHOCK HAZARD DO NOT EXPOSE THIS UNIT TO RAIN OR EXCESSIVE MOISTURE.

HOOKING UP YOUR PROJECTION TV (BASIC TV CONNECTIONS)

BEST VIEWING

The major benefit of this projection television is its large viewing screen. To see this large screen at its best, test various locations in the room to find the optimum spot for viewing.

NOTE: Be sure to allow a free flow of air to and from the perforated back cover of the set.

To avoid cabinet warping, cabinet color changes, and increased chance of set failure, do not place the TV where temperatures can become excessively hot—for example, in direct sunlight or near a heating appliance.

Magnetic fields, such as those of external speakers, may cause the picture to distort if the speakers are placed too close to the television. Move the magnetic field source away from the TV until there is no picture distortion.

ANTENNA/CABLE TV HOOKUP

BEGIN

The TV signal coming into your home may be from a Cable TV company or a combination UHF/VHF antenna. In either case, the basic connection to the TV is very easy.

A Cable TV signal may use a cable box or a direct connection and can receive up to 125 channels.

A UHF/VHF antenna can receive normal broadcast channels 2–13 for VHF and 14–69 for UHF band signals.

Unless your TV is connected to a cable TV system or to a centralized antenna system, a good outdoor color TV antenna is recommended for best performance. But if you are located in an area with an exceptionally good signal that is free from interference and multiple image “ghosts,” an indoor antenna may be sufficient.

1 Connect the coaxial cable/connector to the ANT(enna) A input on the back of the TV. If you're using a cable converter box, connect the OUT(put) plug from the converter to the ANT(enna) A input on the back of the TV.

2 If the TV signal is from a 75Ω F-type coaxial cable/connector, then you're ready to connect it to the antenna input on the back of the TV. If you're using a cable signal with a converter box, first connect the cable TV signal to the cable signal IN(put) plug on the converter box. Then connect from the OUT(put) on the converter box to the ANT(enna) input on the back of the TV.

STOP

CHECK IT OUT

- ✓ To set the TV to select only the channel numbers in your area see how to “Program” or “Add” channels in memory on page 5 (Auto Program section).
- ✓ If you intend to use separate UHF and VHF antennas, you will need an optional combiner to connect to the TV. To order any optional accessory contact your dealer or call the toll-free accessory ordering number (1-800-851-8885).
- ✓ See page 8 for more information on the Rear Panel jacks.

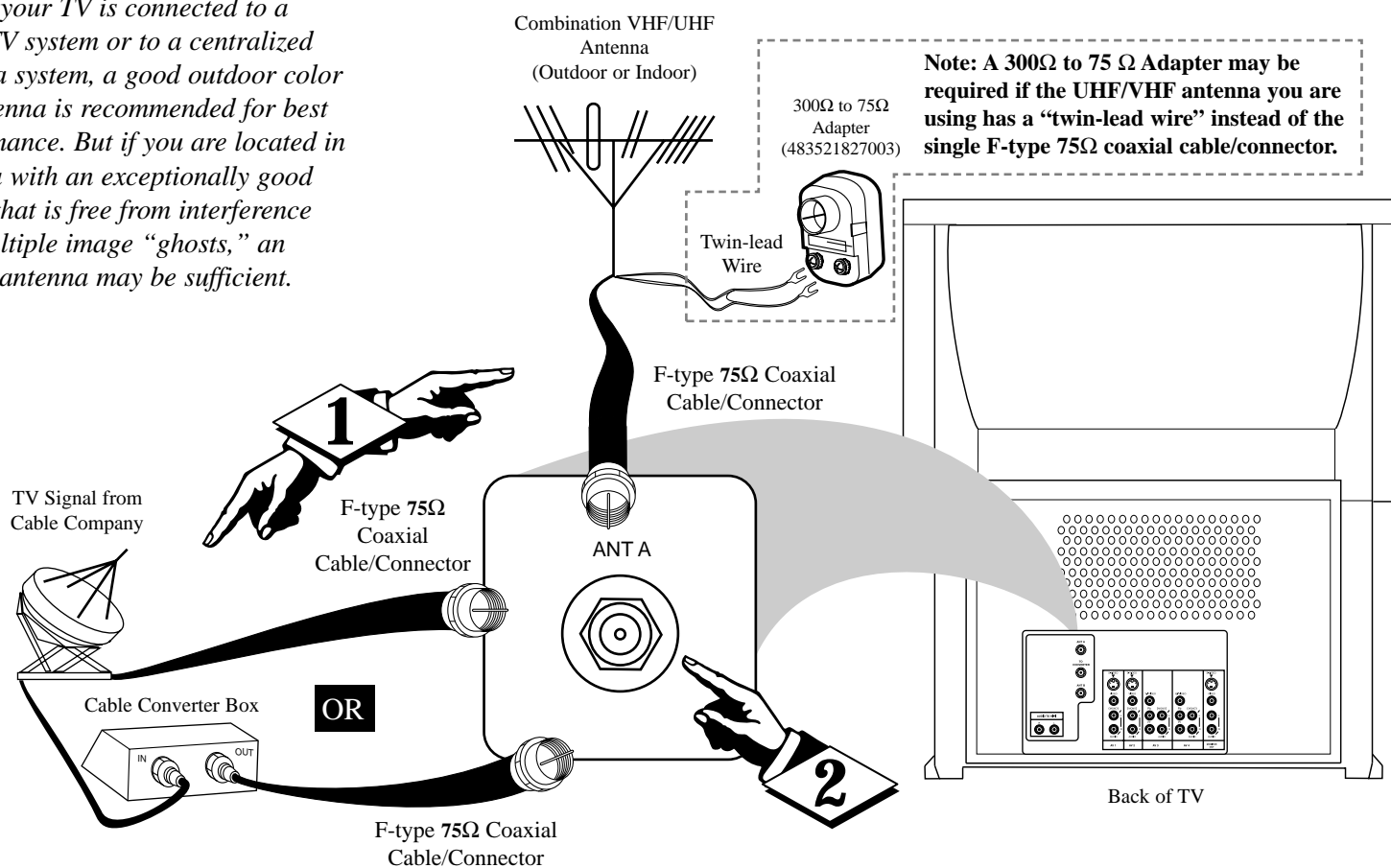

HOOKING UP YOUR TV (BASIC TV CONNECTIONS)

BASIC VCR HOOKUP

BEGIN

Follow the steps to the right to connect a basic antenna or cable TV signal to a VCR, and then the VCR to the TV. Refer to the owner's manuals for your VCR and cable converter box for further information on hookups.

- 1 Connect your antenna or cable TV signal to a two-way signal splitter.
- 2 Connect one end of coaxial cable to each of the output plugs on the signal splitter.
- 3 Connect one of the signal splitter outputs to the ANT(enna) IN(put) on the VCR.
- 4 Connect the remaining signal splitter output to the ANT(enna) A input on the back of the TV.
- 5 Connect either the S-VIDEO or V(ideo) output jack and the L(ef) and R(ight) audio output jacks on the back of the VCR to the matching AV 1 jacks on the back of the TV.
- 6 Connect the INPUT jack on the back of the cable box to the TO CONVERTER jack on the back of the TV. Then connect the OUTPUT jack on the back of the cable box to the ANT(enna) B input on the back of the TV.

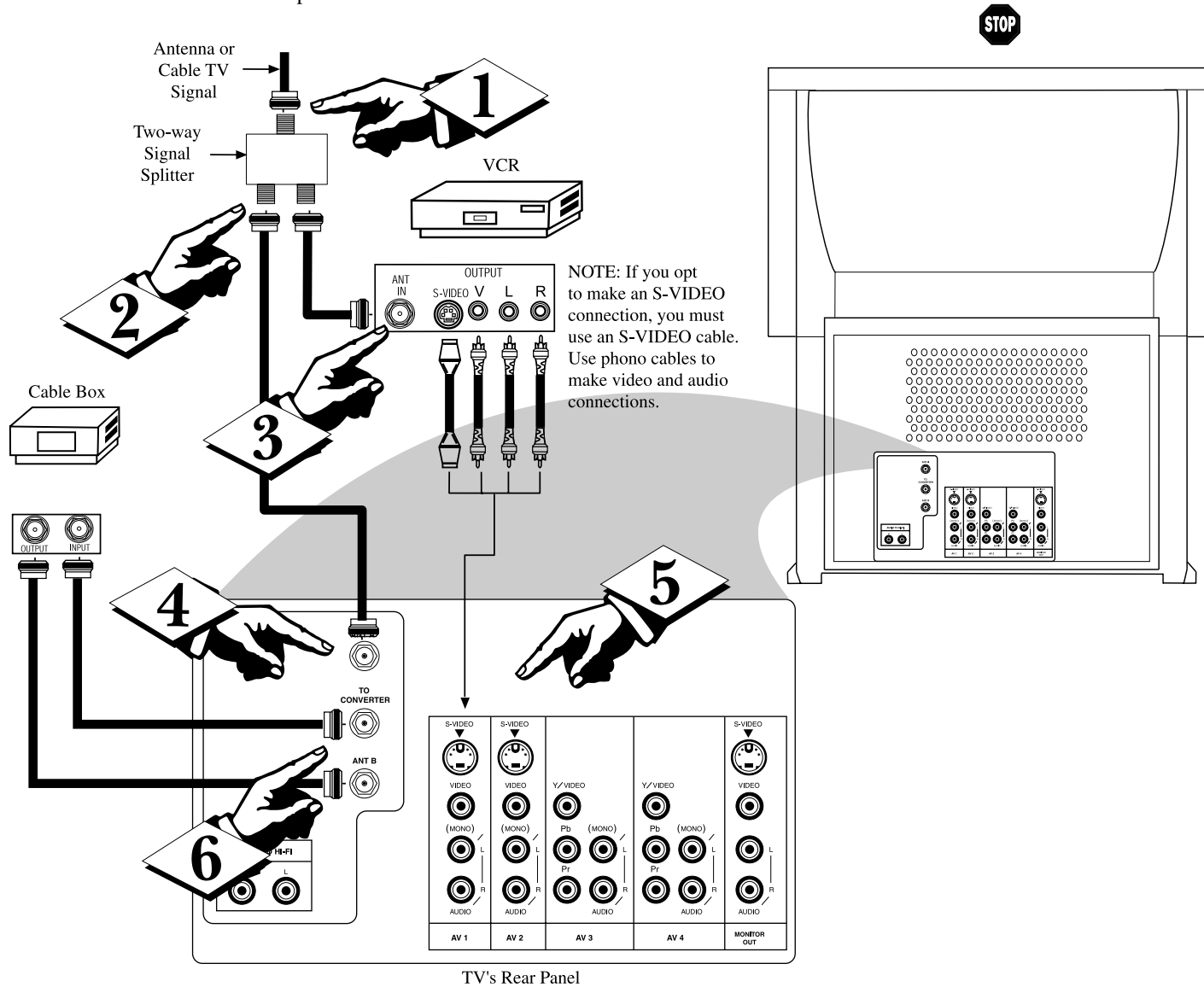

CHECK IT OUT

✓ Your TV remote control allows you to switch between two separate 75-ohm antenna inputs, ANT(enna) A and ANT(enna) B. You can display the ANT(enna) A input as a main picture or subpicture (Picture-in-Picture). You can display ANT(enna) B only as a main picture. (ANT[enna] B cannot be displayed as a subpicture.) The antenna output labeled "TO CONVERTER" allows the ANT(enna) A connection to pass directly to a different source such as a cable box, only when ANT(enna) B is displayed as a main picture.

FRONT PANEL JACKS

BEGIN

The Front Panel jacks offer you the convenience of easy connection to a camcorder or VCR.

- 1 Connect the S-VHS or Video OUTPUT jack and the audio L(ef) and R(ight) OUTPUT jacks on the back of the VCR to the TV's Front Panel jacks.
- 2 Connect the S-VHS and audio L(ef) and R(ight) OUTPUT jacks on the camcorder to the TV's Front Panel jacks.

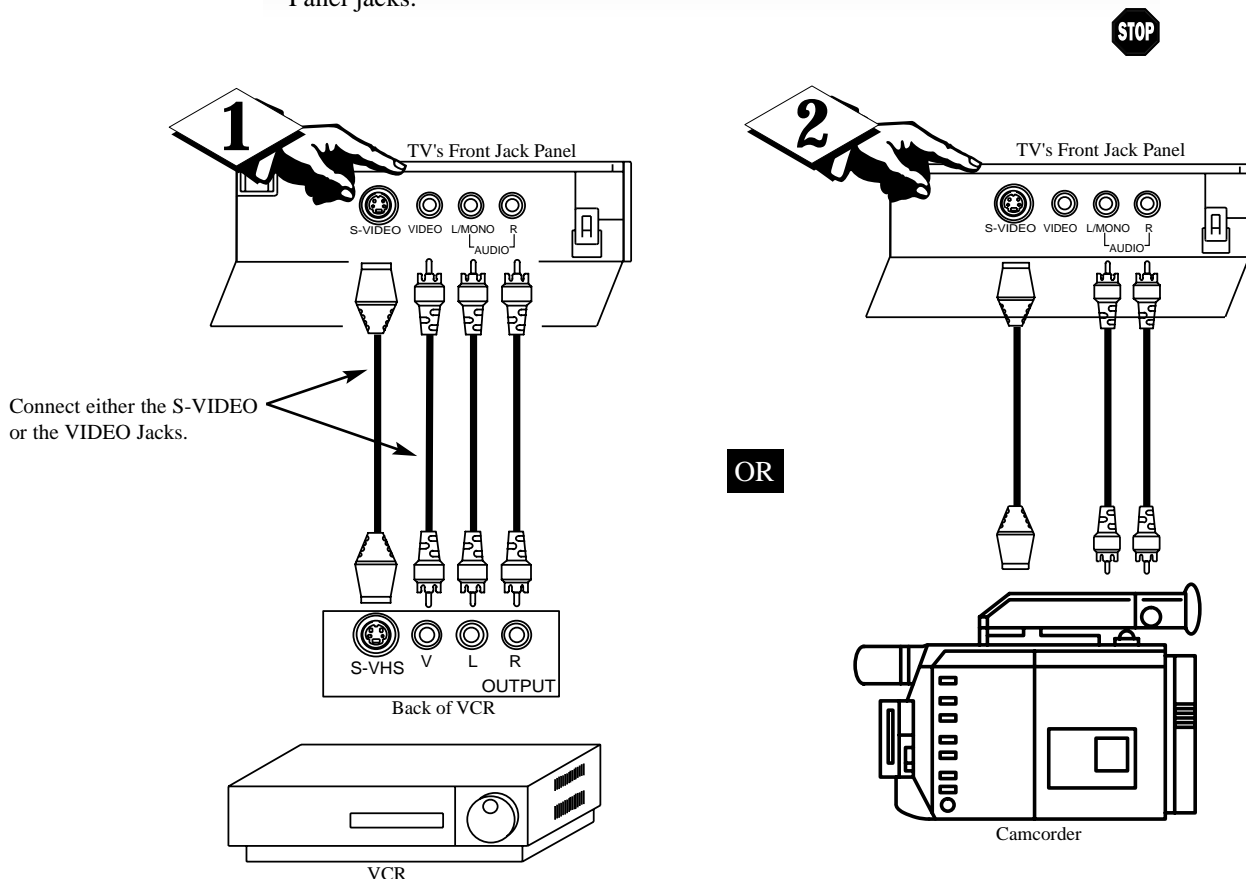

CHECK IT OUT

✓ Be sure to completely insert cord plugs when connecting to the Front Panel jacks. If you don't, the played-back picture may be abnormal.

✓ If you have an S-VHS VCR, use the S-INPUT cable in place of the standard video cable.

✓ If you have a mono VCR, insert the audio cable into the left audio jack of your TV.

PERFORMING BASIC TV OPERATIONS

TELEVISION

In this section, learn how to use the TV buttons for basic operation of the TV. (See page 4 for information on how to adjust or set TV controls through the on-screen menu using the buttons on the front of the TV, if you don't want to use the remote.)

BEGIN

- 1 Press the **POWER** button to turn the TV on.
- 2 After having connected a broadcast signal source to the TV, press the **INPUT/EXIT** button to select a source. The source options are Tuner A, Tuner B, A/V: 1, A/V: 2, Front, A/V: 3, and A/V: 4. For this example, choose the source to which you connected the broadcast signal (Tuner A or Tuner B).
- 3 Press the **CH(annel) selector** buttons until the number of the channel you desire appears in the right corner of the TV screen.
- 4 Press the **VOL(ume) level** buttons to attain your desired sound level. The volume level will be displayed on the TV screen.

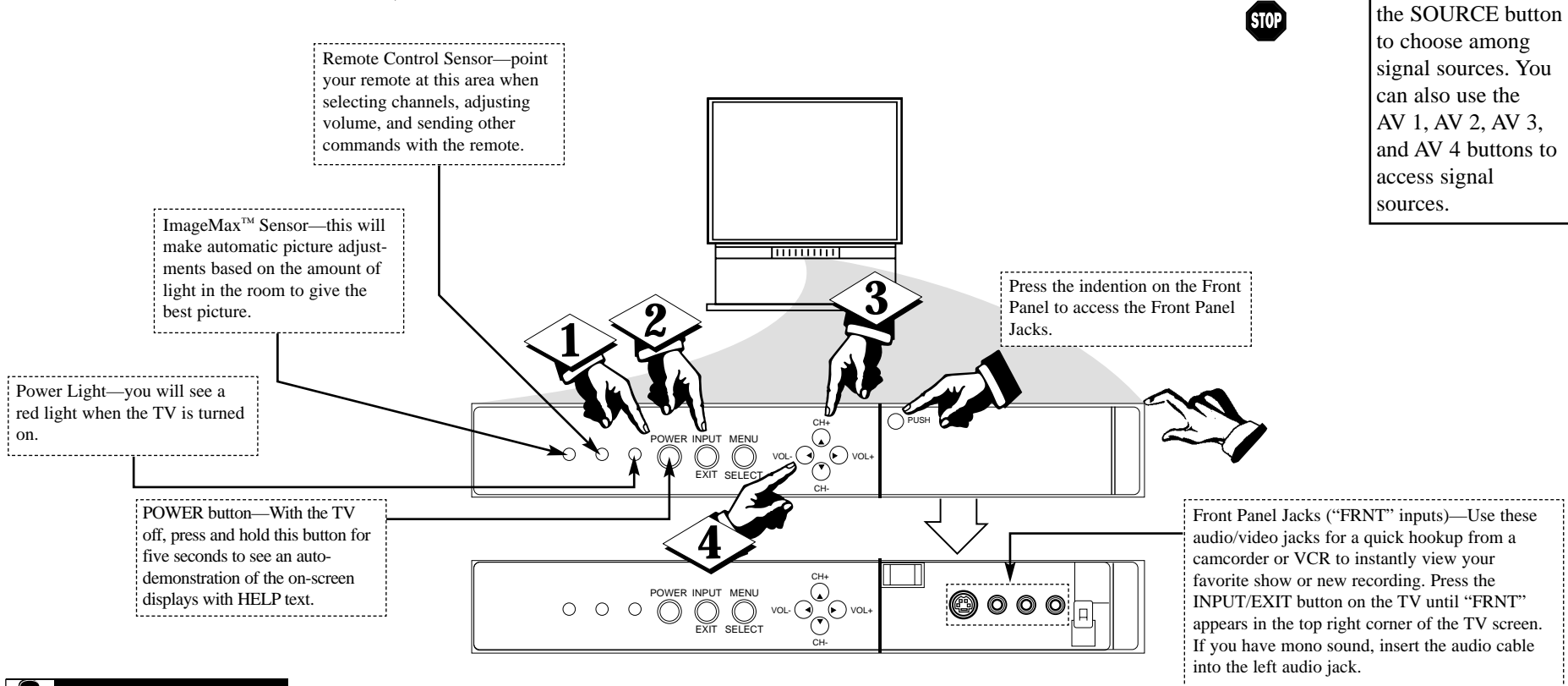

CHECK IT OUT

- ✓ Your TV will appear to be turned off if no video input is present when A/V:1, A/V: 2, FRNT, A/V: 3, or A/V: 4 are selected. Check the Power Light to make sure the TV is turned off when not in use.
- ✓ Your remote does not have an INPUT button. Use the SOURCE button to choose among signal sources. You can also use the AV 1, AV 2, AV 3, and AV 4 buttons to access signal sources.

REMOTE

Offering direct access to the on-screen menu, this remote controls all features and functions of your TV. It also controls virtually all infrared VCRs, laserdisc/DVD players, and satellite receivers, as well as on/off and channel up/down on most cable converter/decoders (see pages 31–36 of the Directions for Use manual for setup information).

SOURCE Button—Press to choose from among the TV’s signal sources: Tuner A, Tuner B, A/V: 1, A/V: 2, FRNT (Front), A/V: 3, or A/V: 4.

Mode Buttons—This remote can be set up to operate a VCR, DVD, laserdisc, cable box, or satellite receiver. Press TV to use the remote with the TV, DVD for DVD and laserdisc, VCR for VCR, and ACC(essory) for a cable box or satellite receiver. (See the Directions for Use manual.)

HELP Button—Press when a menu is on screen to view HELP text. The text gives a description of the displayed menu. The HELP text will be shown every time a MENU is displayed, until you press the HELP button again.

FORMAT Button—Press to quickly change the aspect ratio of the viewable video. Choose from 4:3, Zoom, 16:9, and Theater.

STATUS/EXIT Button—Press to display the time (after you have set it) and status of sound (stereo or mono), signal source, and screen format. Also press to clear the TV screen after setting or adjusting controls.

VOL(ume) +, – Buttons—Press + or – until you obtain the volume level you want.

A/CH (Alternate Channel) Button—Press to choose between the last two channels viewed. (This is good for switching between two sporting events, for example.)

INTELLISENSE Button—Press to automatically adjust picture convergence using Auto IntelliSense Focus.

TUNER A, TUNER B, and FRONT Buttons—Press to access either of the two tuners in the TV’s Rear Panel or the audio/video jacks in the TV’s Front Panel.

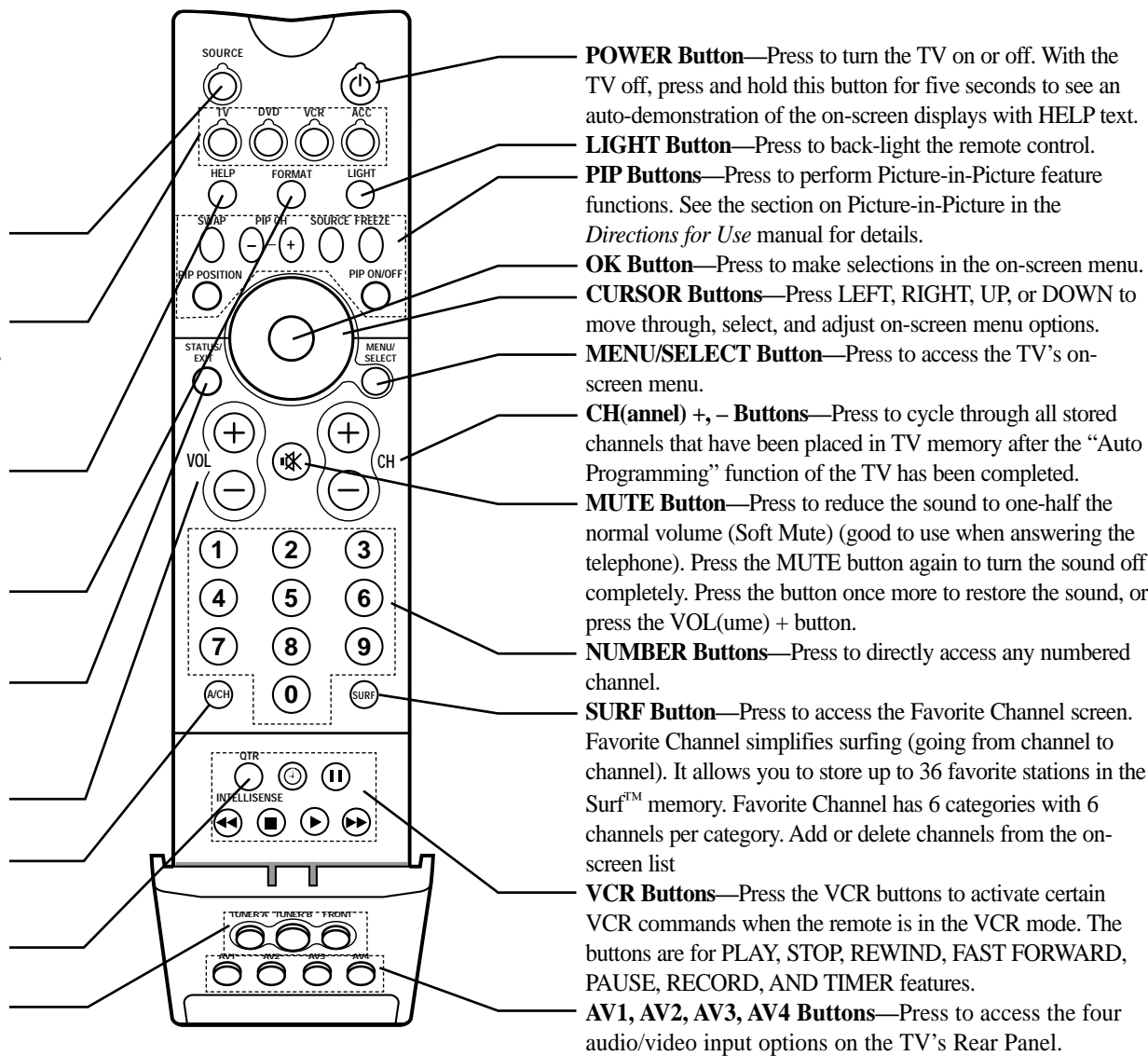

REMOTE BATTERIES

Battery Usage CAUTION—To prevent battery leakage which may result in bodily injury or damage to the unit:

- Install ALL batteries correctly, + and – as marked on the unit.
- Do not mix batteries: (OLD and NEW or CARBON and ALKALINE, etc.)
- Remove batteries when the unit is not used for a long time.

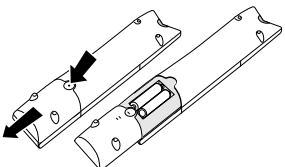

BEGIN

- 1 Remove the battery compartment lid on the back of the remote.
- 2 Place the batteries (2-AA) in the remote. Be sure the (+) and (-) ends of the batteries line up correctly (inside of case is marked).
- 3 Reattach the battery lid.

STOP

USING THE ON-SCREEN MENU

MENU

This section explains how to make selections or adjustments within the on-screen menu. The menu is simply a list of your TV's features or controls. Use the CURSOR buttons on your remote control or the CH(annel) selector and VOL(ume) buttons on the TV to move among the menu options. As necessary, on-screen messages will provide you with information to guide you. Also, with the on-screen menu displayed, you can press the HELP button on the remote control to receive more on-screen assistance.

BEGIN

- 1 Press the **MENU/SELECT** button on the remote to display the On-screen Menu. Or press the MENU/SELECT button on the TV.
- 2 To choose an item from the Menu Bar, press the CURSOR RIGHT or LEFT button. Or press the VOL(ume) level buttons on the TV.
- 3 To highlight a feature within the menu, press the CURSOR DOWN or UP button on the remote. Or press the CH(annel) selector buttons on the TV.
- 4 To move through the list of options and their setting or adjustment areas, press the CURSOR DOWN, UP, RIGHT, or LEFT buttons. Or press the CH(annel) selector or VOL(ume) buttons on the TV.
- 5 To make selections, press the **OK** button on the remote or the MENU/SELECT button on the TV. To adjust Picture or Sound settings, press the CURSOR RIGHT or LEFT buttons on the remote. Or press the VOL(ume) -, + buttons on the TV.
- 6 To remove the on-screen menu, press the STATUS/EXIT button on the remote. Or press the INPUT/EXIT button on the TV.

STOP

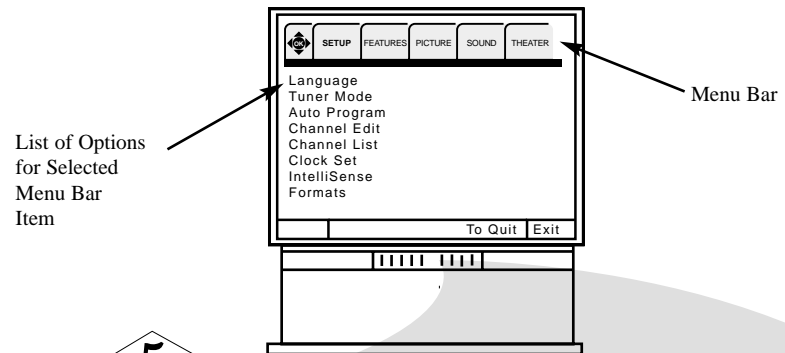

ON THE TV

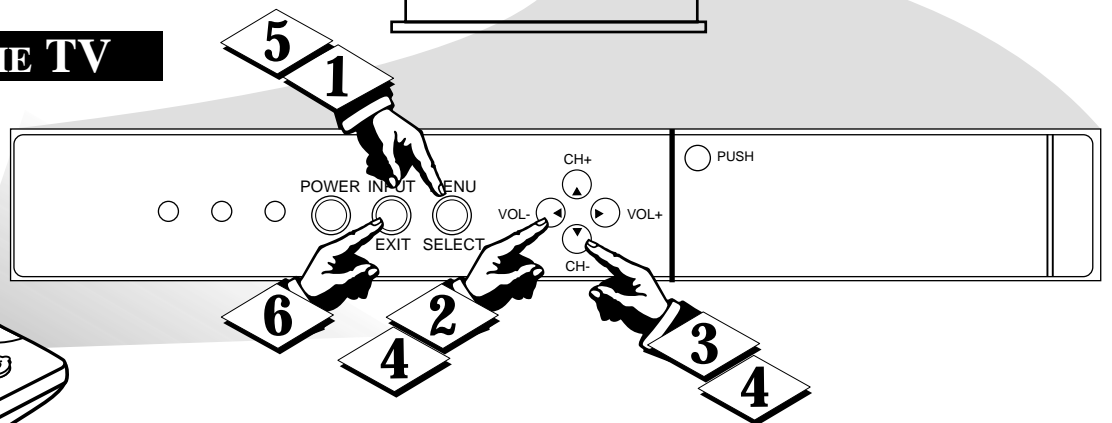

ON THE REMOTE

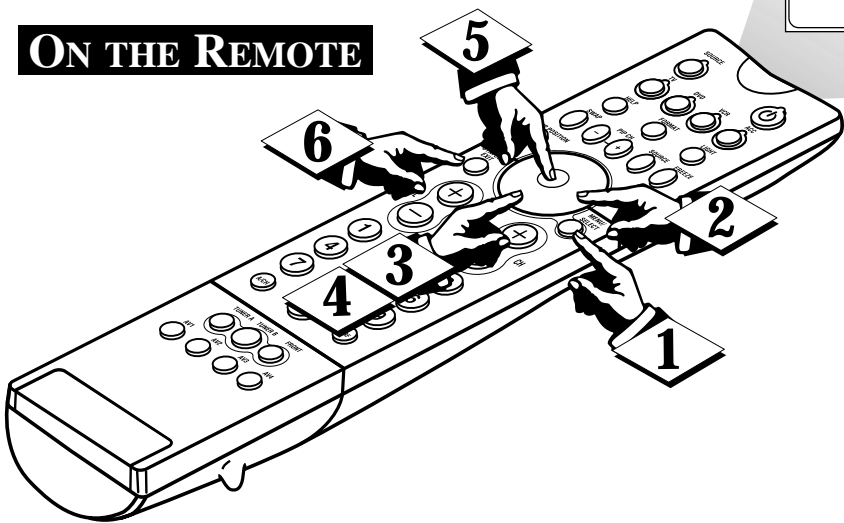

USING THE SETUP CONTROLS

LANGUAGE

The Language control will allow you to select any of three languages for all on-screen displays.

BEGIN

- 1 Press the **MENU/SELECT** button on the remote control to show the on-screen menu.
- 2 Press the **CURSOR DOWN** button to highlight Language.
- 3 Press the **CURSOR RIGHT** button to enter the Language options area.
- 4 Press the **CURSOR DOWN** or **UP** button to highlight the Language of your choice.
- 5 Press the **OK** button to select the language.
- 6 To return to the list of Setup options, press the CURSOR LEFT button. To return to the Menu Bar, press the MENU/SELECT button. To quit the on-screen menu, press the STATUS/EXIT button.

STOP

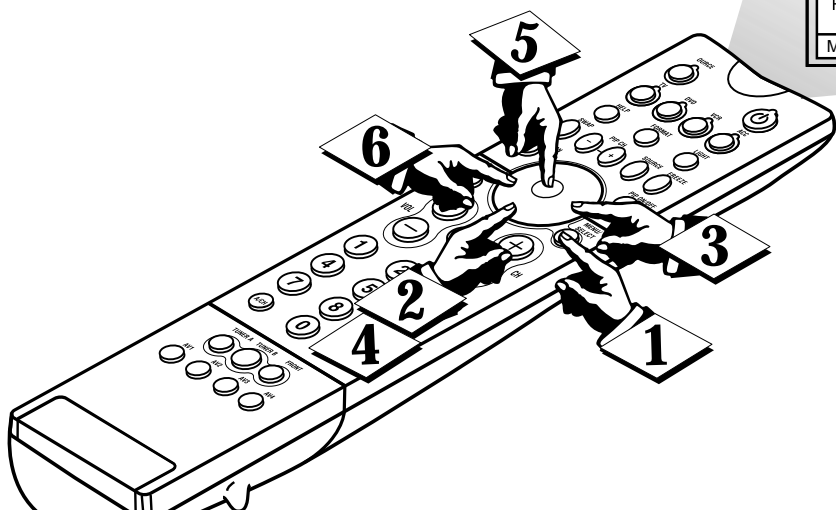
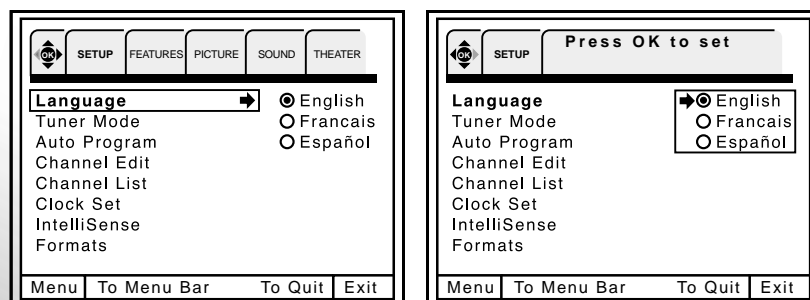

USING THE SETUP CONTROLS

TUNER MODE

BEGIN

By choosing a Tuner Mode, you are telling the TV the type of broadcast signal you have connected. Select Antenna if you are using an indoor or outdoor antenna. Choose Cable 1 or Cable 2 if you have cable TV.

- 1 Press the **MENU/SELECT** button on the remote control to show the on-screen menu.
- 2 Press the **CURSOR DOWN** button twice until Tuner Mode is highlighted.

- 3 Press the **CURSOR RIGHT** button to move to the Tuner Mode options area. Press the **CURSOR DOWN** or **UP** button until you have highlighted the correct option.
- 4 Press the **OK** button to make your selection.

- 5 To return to the list of Setup options, press the **CURSOR LEFT** button. To return to the Menu Bar, press the **MENU/SELECT** button. To quit the on-screen menu, press the **STATUS/EXIT** button.

STOP

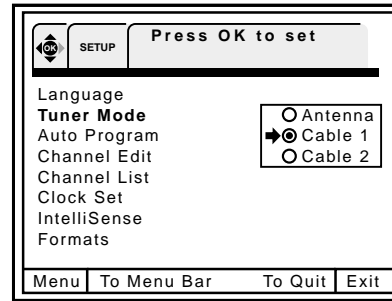
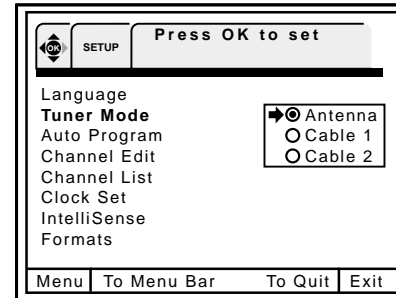
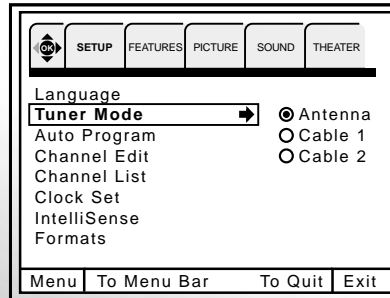

Reception Band		
Air (Antenna)	Cable 1 or Cable 2	
	Cable Channel	Indicated on the screen
VHF 2 ~ 13ch UHF 14 ~ 69ch	VHF 2~13	2 ~ 13
	Midband A~1	14 ~ 22
	A-5 ~ A-1	95 ~ 99
	Super band J~W	23 ~ 36
	Hyperband W + 1 ~ W + 28	37 ~ 64
	Ultraband W + 29 ~ W + 84	65 ~ 125

CHECK IT OUT

- ✓ The reception channels for the Antenna and Cable signal sources are shown below.
- ✓ Refer to your cable or TV guide for channel identification standards.
- ✓ If certain cable channels are poor or not possible in Cable 1 mode, set Tuner Mode to Cable 2.

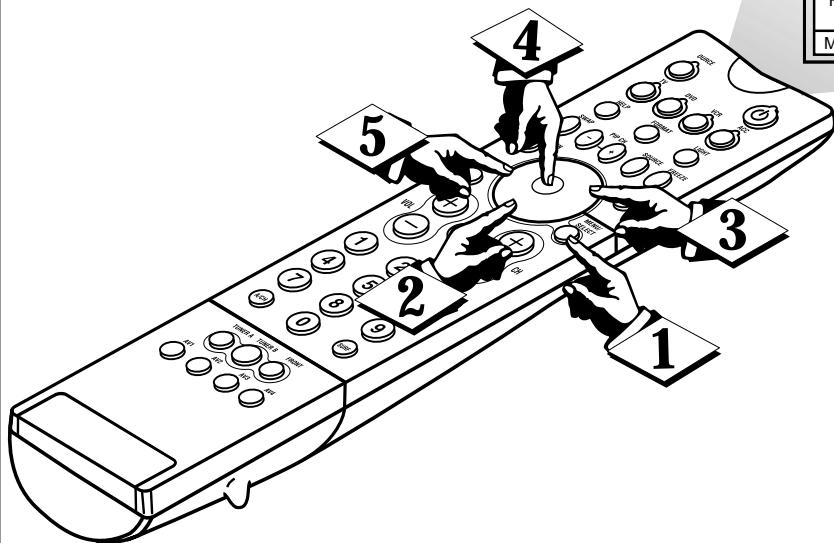

AUTO PROGRAM

BEGIN

Use this control to automatically store active TV channels in the TV's memory. This will allow you to skip unused channels when using the CH(annel) +, - buttons on your remote.

- 1 Press the **MENU/SELECT** button on the remote control to show the on-screen menu.
- 2 Press the **CURSOR DOWN** button repeatedly until Auto Program is highlighted.

- 3 Press the **CURSOR RIGHT** button to highlight Search.
- 4 Press the **OK** button to start searching for channels and programming the TV's memory.

- 5 To return to the list of Setup options, press the **CURSOR LEFT** button. To return to the Menu Bar, press the **MENU/SELECT** button. To quit the on-screen menu, press the **STATUS/EXIT** button.

STOP

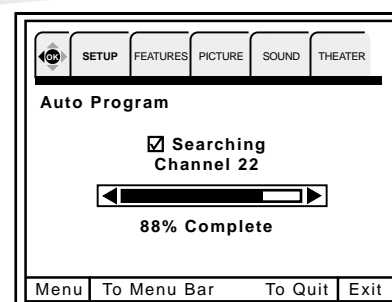
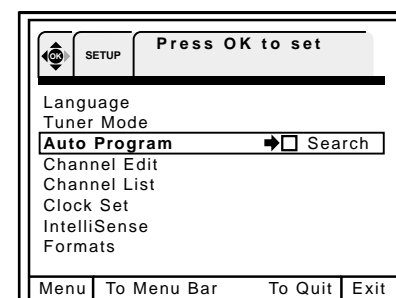
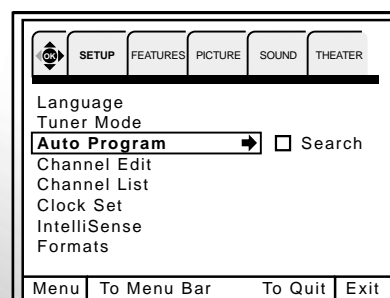

CHECK IT OUT

- ✓ If you press the EXIT button while the Auto Program function is working, programming will stop.
- ✓ If you connect two antennas, switch antenna inputs with the INPUT button and repeat Auto Program for the second antenna input.
- ✓ Remember to select the correct Tuner Mode before using Auto Program (see the Tuner Mode section).
- ✓ See Channel Edit to learn how to add or delete channels.

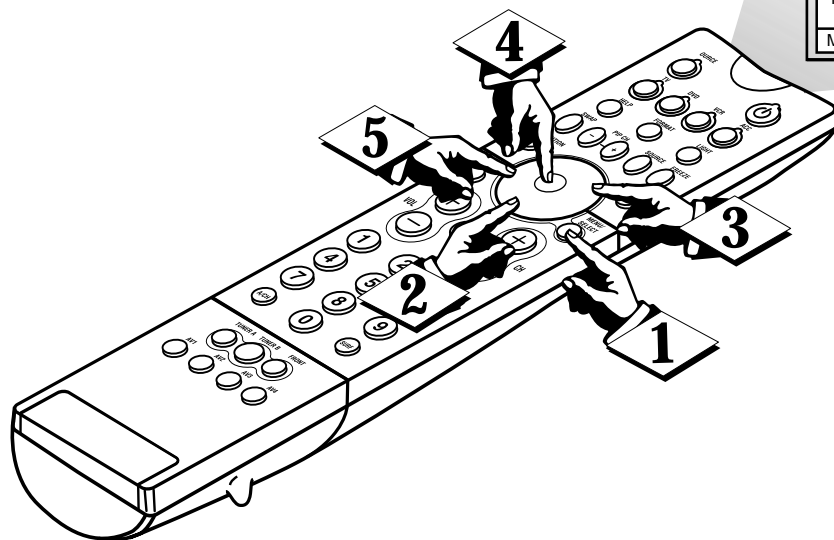

USING THE SETUP CONTROLS

CHANNEL EDIT

Select the correct Tuner Mode and run Auto Program to automatically store active TV channels (see the sections on those controls in this publication). Then use Channel Edit to add or delete channels from the TV's memory.

BEGIN

1 Press the **MENU/SELECT** button on the remote control to show the on-screen menu.

2 Press the **CURSOR DOWN** button repeatedly until Channel Edit is highlighted.

3 Press the **CURSOR RIGHT** button to enter the Add/Delete area.

4 Press the **CURSOR DOWN** or **UP** button to highlight Add or Delete.

5 To Add or Delete the current channel, press the OK button. If you want to Add or Delete a different channel, press the CH(annel) + or - buttons to select the desired channel.

6 To return to the list of Setup options, press the **CURSOR LEFT** button. To return to the Menu Bar, press the **MENU/SELECT** button. To quit the on-screen menu, press the **STATUS/EXIT** button.

STOP

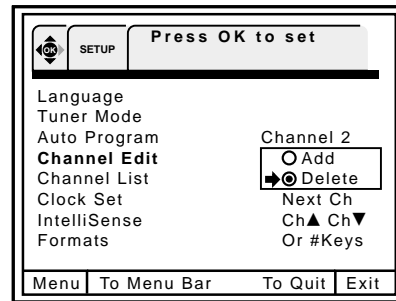
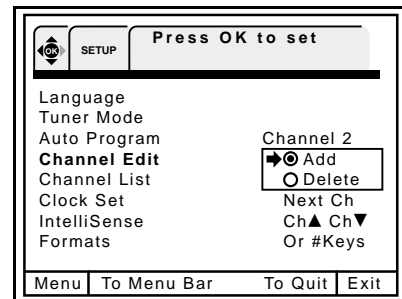
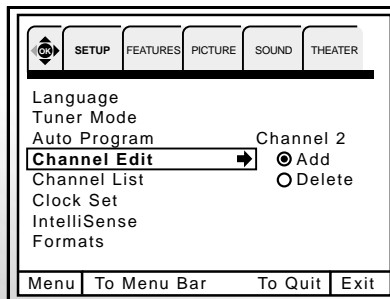
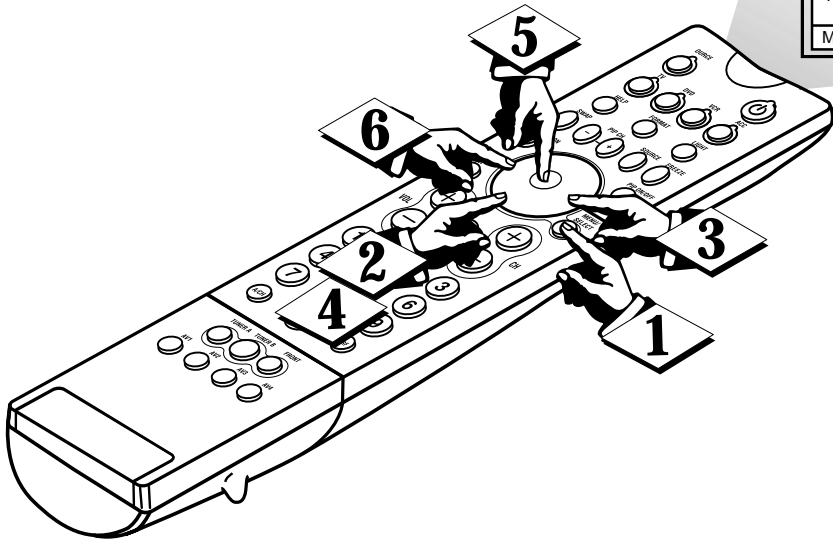

CHANNEL LIST

Channel List allows you to review labeled channels (Id). It also shows you which channels have been added to the TV's memory and which ones are protected by AutoLock.™ See the section on Channel Edit in this publication. Learn more about Channel List and AutoLock in the Directions for Use manual that came with your TV.

BEGIN

1 Press the **MENU/SELECT** button on the remote control to show the on-screen menu.

2 Press the **CURSOR DOWN** button repeatedly until Channel List is highlighted.

3 Press the **CURSOR RIGHT** button to view the Channel List. When in the Channel list, pressing the **CURSOR DOWN** or **UP** button will allow you to view the next eight channels.

4 To return to the list of Setup options, press the **CURSOR LEFT** button. To return to the Menu Bar, press the **MENU/SELECT** button. To quit the on-screen menu, press the **STATUS/EXIT** button.

STOP

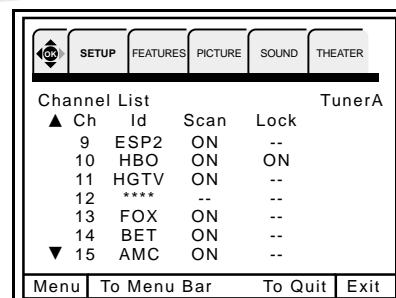
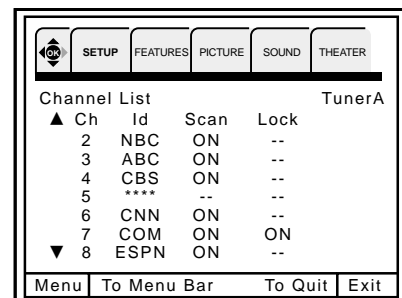
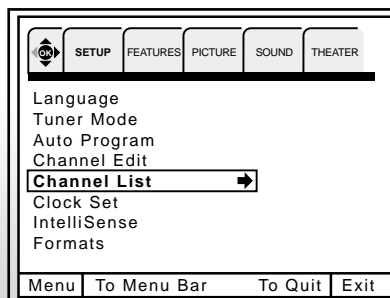
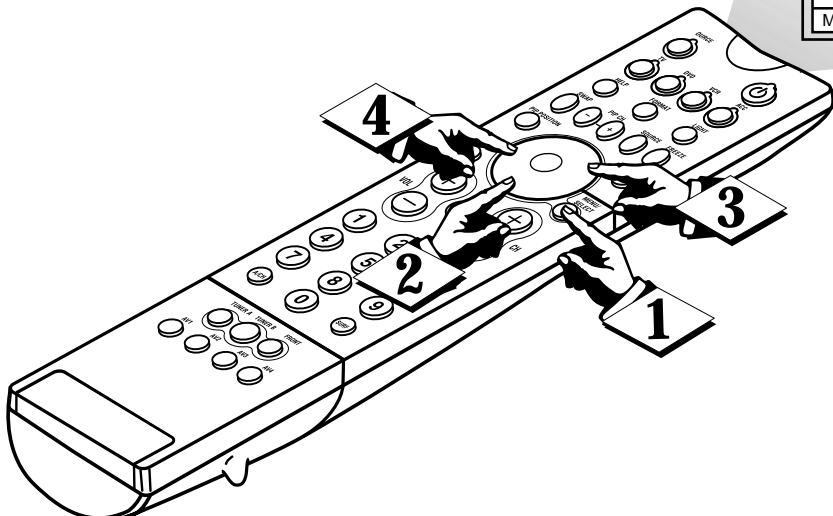

USING THE SETUP CONTROLS

CLOCK SET

You must set the time on the TV's clock before you can use the 4 Event Program or Sleep Timer (see the Directions for Use manual for details on those features).

BEGIN

- 1 Press the **MENU/SELECT** button on the remote control to show the On-screen Menu.
- 2 Press the **CURSOR DOWN** button repeatedly until Clock Set is highlighted.
- 3 Press the **CURSOR RIGHT** button to enter the Clock Set area.
- 4 Press the **CURSOR DOWN** or **UP** button to select digits for the hour. Press the **CURSOR RIGHT** button to move to the input area for the minutes. Press the **CURSOR UP** or **DOWN** to choose the digits for the minutes. Choose Am or Pm, the month, day, and year in the same manner.
- 5 After you have finished inputting the time, press the **MENU/SELECT** button to return to the Menu Bar. Or press the **STATUS/EXIT** button to quit the on-screen menu.

STOP

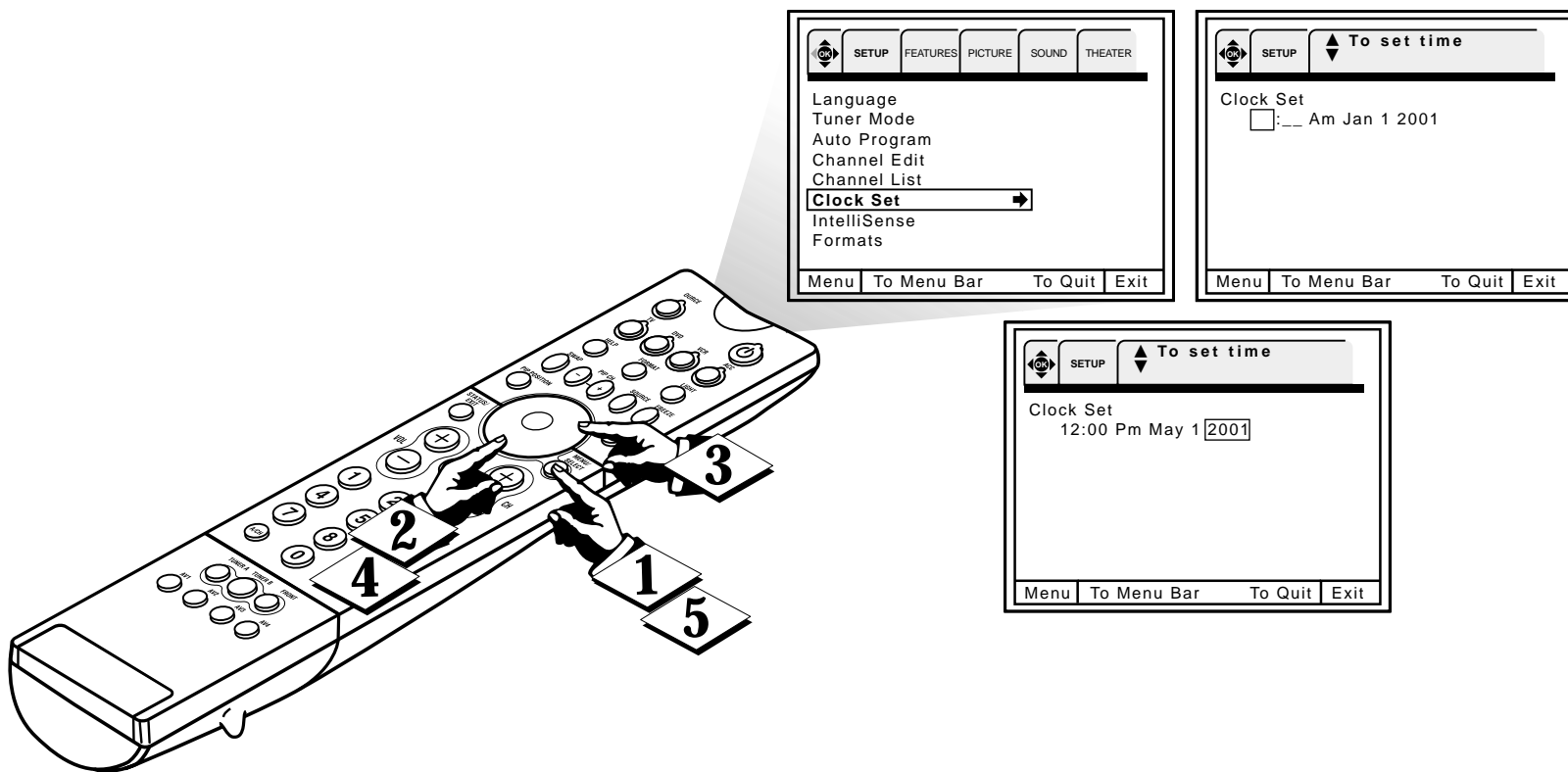

INTELLISENSE

You can automatically adjust the TV's picture convergence using Auto IntelliSense Focus. Your projection TV has three color projection tubes: one for red, one for green, and one for blue. When mixed in the proper proportion, the output of these three color tubes can produce any color. However, the beams of light coming from the tubes must be precisely aligned over each other so that the colors can be mixed. The alignment of these picture beams is called "convergence."

Over a period of time, the picture tubes can drift out of alignment because of normal bumps and vibrations or moving the TV. If you move your TV, or if, after a time, you notice color rings or halos around objects, use Auto IntelliSense Focus to adjust the convergence. This is how Auto IntelliSense Focus works: After reviewing a special test pattern, optical sensors send position information to a controller, which then corrects the picture. Auto IntelliSense Focus responds to the natural and man-made magnetic field conditions where the projection TV is located, so you always enjoy the best possible picture.

BEGIN

- 1 Press the **INTELLISENSE** button on your remote control to begin adjusting the TV's convergence. The process takes about 15 seconds.

NOTE: During the adjustment process, do not press the INTELLISENSE button again and do not move the TV.

STOP

Picture Difficulty:
Color fringes
around objects

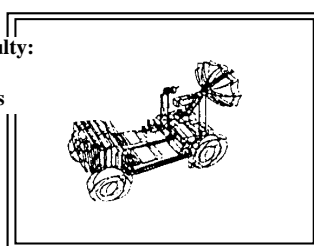

Color Fringes Gone:
Convergence adjusted

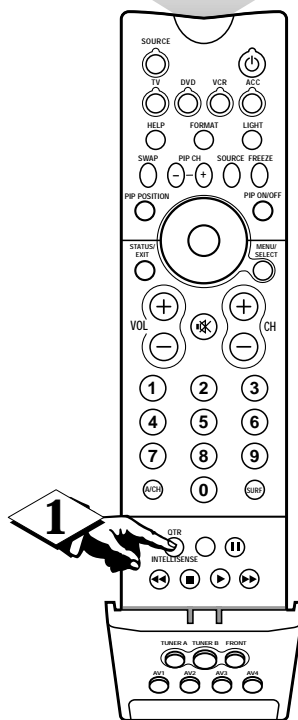
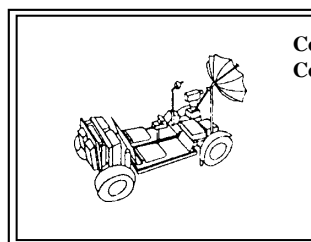

CHECK IT OUT

- ✓ After Auto IntelliSense Focus does its work, the picture will be at its best.
- ✓ You can also access Auto IntelliSense Focus through the Setup Menu.

USING THE SETUP CONTROLS

FORMATS

The **Formats** control is very useful when setting up reception for High Definition, Standard Definition, and NTSC signals. The **Comp Color Type** function allows you to automatically change tint and color coordinate for DTV programs. Use the **HDTV** (High Definition Television) setting for a High Vision Signal (Y-PbPr) from an HDTV set-top box. Use the **SDTV/DVD** setting for Standard Definition Television or Digital Video Disc (Y-CbCr) such as a digital video disc player.

BEGIN

1 Press the **MENU/SELECT** button on the remote control to show the on-screen menu.

2 Press the **CURSOR DOWN** button repeatedly until **Formats** is highlighted.

3 Press the **CURSOR RIGHT** button to enter the **Formats** selection area.

4 Press the **CURSOR DOWN** or **UP** button to highlight a screen format you want to select for the TV picture.

5 Press the **OK** button to make your selection. Repeat steps 4 and 5 to set **V. Position/Comp Color Type** and **Video Display**.

6 To return to the list of **Setup options**, press the **CURSOR LEFT** button. To return to the **Menu Bar**, press the **MENU/SELECT** button. To quit the on-screen menu, press the **STATUS/EXIT** button.



CHECK IT OUT

✓ If **Comp Color Type** is set improperly (does not match the actual input signal), the color and tint of the main picture will be abnormal.

✓ You must be tuned to **A/V: 3** or **A/V: 4** and have an accessory device hooked up to the **Y-PbPr** input jacks to access all of the **Formats Menu** options.

✓ All settings will affect only the component input you are currently viewing. If you are using both sets of component input jacks, be sure to set **Formats** for both inputs (set **A/V: 3** and **A/V: 4**).

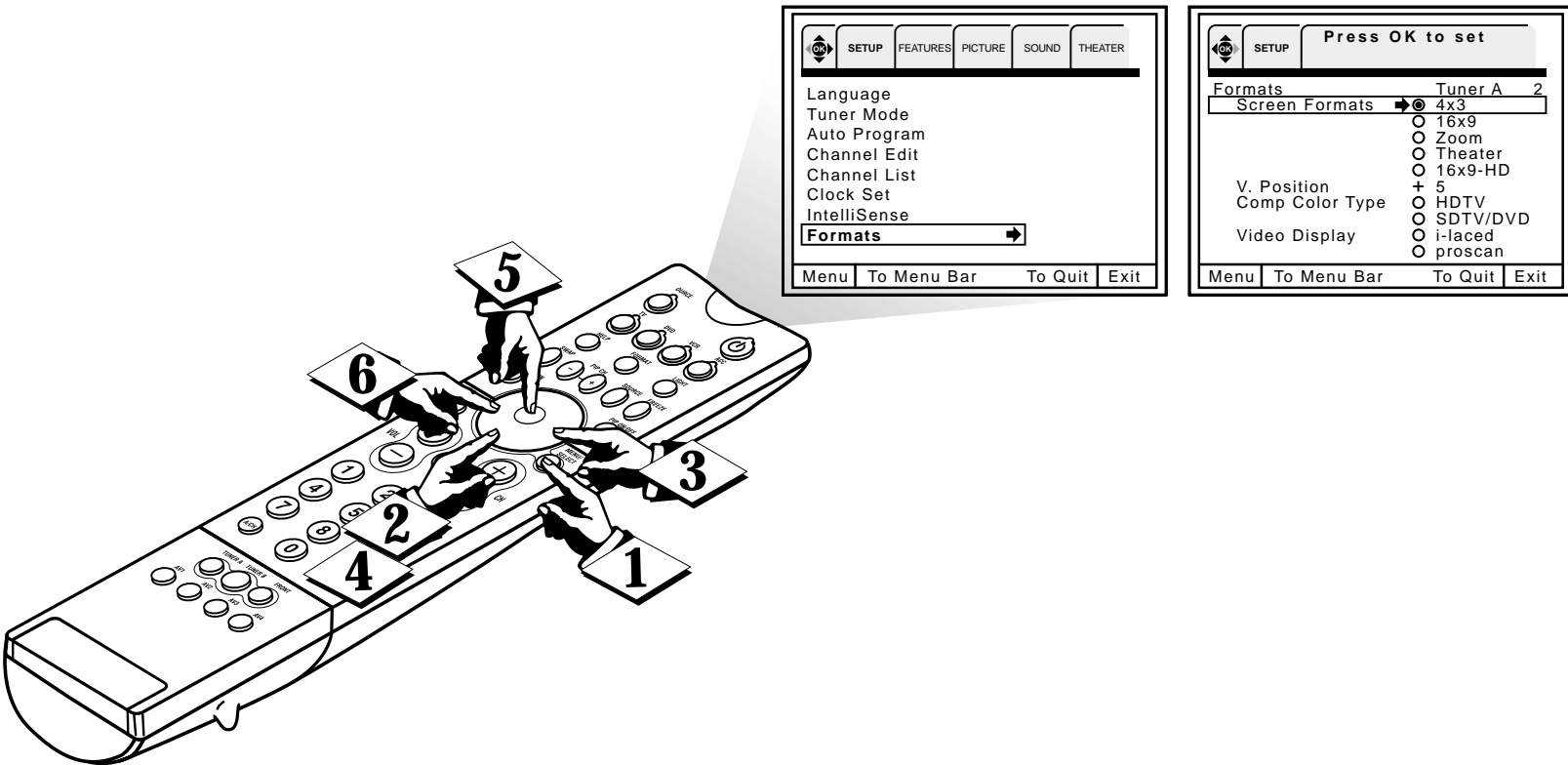

LEARNING MORE ABOUT THE REAR PANEL JACKS

JACK DESCRIPTIONS

Your TV's **Rear Panel jacks** allow the connection of a variety of accessory devices ("components"). This section explains how you may use the jacks.

Component: Y-PbPr Inputs

AV 3 and AV 4 provide **Y-PbPr** jacks for connecting equipment with **Component Video** capability. Devices such as DVD players or set-top boxes can be connected to these jacks. You may use standard video signal for AV 3 and AV 4.

NOTES:

- Your component inputs may be labeled **Y, B-Y, and R-Y**. In this case, connect the components **B-Y** output to the TV's **Pb** input and the components **R-Y** output to the TV's **Pr** input.
- Your component outputs may be labeled **Y-CbCr**. In this case, connect the component output to the TV's **Pb** input and the component **Cr** output to the TV's **Pr** input.
- It may be necessary to adjust **Tint** to obtain optimum picture quality when using the **Y-PbPr** inputs.
- To ensure no copyright infringement, the **MONITOR OUT** output will be abnormal when using the **Y-PbPr** jacks.
- When using the **Y-PbPr** jacks, the TV will automatically change to **Split PIP** mode. When you have **Picture-in-Picture** on and are viewing a **Y-PbPr** input, only **Split** mode is possible.
- AV 3 and AV 4 (**Y/VIDEO**) can be used for standard video input.

S-VIDEO Inputs 1 and 2
AV 1 and AV 2 provide **S-VIDEO** (Super Video) jacks for connecting equipment with **S-VIDEO** output capability.

Antenna Input/Output

The remote control allows you to switch between two separate 75-ohm RF antenna inputs, **ANT A** and **ANT B**. The **ANT A** input can be displayed as a main picture or subpicture. **ANT B** can be displayed only as a main picture. (**ANT B** cannot be displayed as a subpicture.) The antenna output labeled "**TO CONVERTER**" allows the **ANT A** connection to pass directly to a different source such as a cable box only when **ANT B** is displayed as the main picture.

AUDIO TO HI-FI Output

These jacks provide variable audio output to a separate stereo amplifier. With this connection, the audio to the stereo can be controlled by the television's main volume.

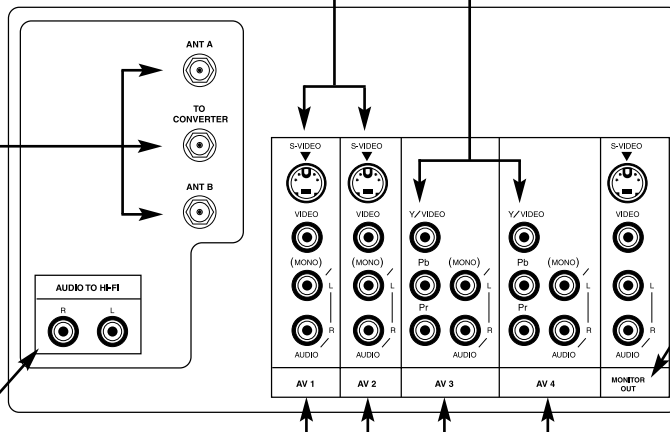

MONITOR OUT

These jacks provide fixed audio and video signals for recording. Use the **S-VIDEO Output** for high-quality video output. **NOTE:** **S-VIDEO Output** may be used for recording only when the input is of **S-VIDEO** type.

Audio/Video Inputs 1, 2, 3, and 4

The **SOURCE** button or your remote will step through each video source and antenna source input each time it is pressed. Use the audio and video inputs to connect accessory devices—VCRs, camcorders, laserdisc players, DVD players and the like. (If you have mono sound, insert the audio cable into the left audio jack.) **NOTE:** You may use **VIDEO** or **S-VIDEO** inputs to connect **AV 1** and **AV 2**, but only one of these inputs may be used at a time.

Free Manuals Download Website

<http://myh66.com>

<http://usermanuals.us>

<http://www.somanuals.com>

<http://www.4manuals.cc>

<http://www.manual-lib.com>

<http://www.404manual.com>

<http://www.luxmanual.com>

<http://aubethermostatmanual.com>

Golf course search by state

<http://golfingnear.com>

Email search by domain

<http://emailbydomain.com>

Auto manuals search

<http://auto.somanuals.com>

TV manuals search

<http://tv.somanuals.com>