

OWNER'S MANUAL

PROJECTION TELEVISION

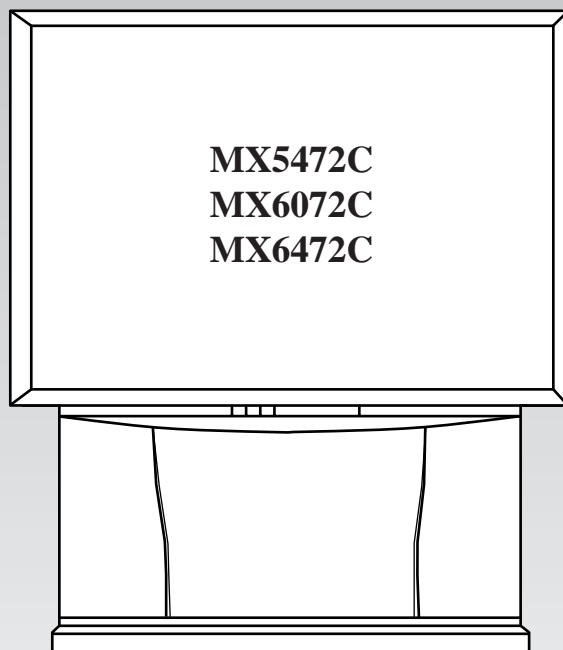

PHILIPS **MAGNAVOX**

IMPORTANT!

Return Your Warranty Registration Card
Within 10 Days. See Why Inside.

Return your Warranty Registration card today to ensure you receive all the benefits you're entitled to.

Once your PHILIPS MAGNAVOX purchase is registered, you're eligible to receive all the privileges of owning a PHILIPS MAGNAVOX product. So complete and return the Warranty Registration Card enclosed with your purchase at once. And take advantage of these important benefits.

Warranty Verification

Registering your product within 10 days confirms your right to maximum protection under the terms and conditions of your PHILIPS MAGNAVOX warranty.

Owner Confirmation

Your completed Warranty Registration Card serves as verification of ownership in the event of product theft or loss.

Model Registration

Returning your Warranty Registration Card right away guarantees you'll receive all the information and special offers which you qualify for as the owner of your model.

Congratulations on your purchase, and welcome to the "family!"

PHILIPS MAGNAVOX



Dear PHILIPS MAGNAVOX product owner:

Thank you for your confidence in PHILIPS MAGNAVOX. You've selected one of the best-built, best-backed products available today. And we'll do everything in our power to keep you happy with your purchase for many years to come.

As a member of the PHILIPS MAGNAVOX "family," you're entitled to protection by one of the most comprehensive warranties and outstanding service networks in the industry.

What's more, your purchase guarantees you'll receive all the information and special offers for which you qualify, plus easy access to accessories from our convenient home shopping network.

And most importantly you can count on our uncompromising commitment to your total satisfaction.

All of this is our way of saying welcome—and thanks for investing in a PHILIPS MAGNAVOX product.

Sincerely,

Robert Minkhorst
President and Chief Executive Officer

P.S. Remember, to get the most from your PHILIPS MAGNAVOX product, you must return your Warranty Registration Card within 10 days. So please mail it to us right now!

Know these safety symbols



This "bolt of lightning" indicates uninsulated material within your unit which may cause an electrical shock. For the safety of everyone in your household, please do not remove product covering.

The "exclamation point" calls attention to features for which you should read the enclosed literature closely to prevent operating and maintenance problems.

WARNING: TO PREVENT FIRE OR SHOCK HAZARD, DO NOT EXPOSE THIS EQUIPMENT TO RAIN OR MOISTURE.

CAUTION: To prevent electric shock, match wide blade of plug to wide slot, and fully insert.

ATTENTION: Pour éviter les chocs électriques, introduire la lame la plus large de la fiche dans la borne correspondante de la prise et pousser jusqu'au fond.

PHILIPS MAGNAVOX Visit our World Wide Web Site at <http://www.philipsmagnavox.com>

SAFETY INSTRUCTIONS - Read before operating equipment

This product was designed and manufactured to meet strict quality and safety standards. There are, however, some installation and operation precautions which you should be particularly aware of.

1. **Read Instructions** - All the safety and operating instructions should be read before the appliance is operated.
2. **Retain Instructions** - The safety and operating instructions should be retained for future reference.
3. **Heed Warnings** - All warnings on the appliance and in the operating instructions should be adhered to.
4. **Follow Instructions** - All operating and use instructions should be followed.
5. **Water and Moisture** - The appliance should not be used near water - for example, near a bathtub, washbowl, kitchen sink, laundry tub, in a wet basement or near a swimming pool, etc.
6. **Carts and Stands** - The appliance should be used only with a cart or stand that is recommended by the manufacturer.
- 6A.  An appliance and cart combination should be moved with care. Quick stops, excessive force, and uneven surfaces may cause the appliance and cart combination to overturn.
7. **Wall or Ceiling Mounting** - The appliance should be mounted to a wall or ceiling only as recommended by the manufacturer.
8. **Ventilation** - The appliance should be situated so that its location or position does not interfere with its proper ventilation. For example, the appliance should not be situated on a bed, sofa, rug, or similar surface that may block the ventilation openings; or, placed in a built-in installation, such as a bookcase or cabinet that may impede the flow of air through the ventilation openings.
9. **Heat** - The appliance should be situated away from heat sources such as radiators, heat registers, stoves, or other appliances (including amplifiers) that produce heat.
10. **Power Sources** - The appliance should be connected to a power supply only of the type described in the operating instructions or as marked on the appliance.
11. **Power-Cord Protection** - Power supply cords should be routed so that they are not likely to be walked on or pinched by items placed upon or against them, paying particular attention to cords and plugs, convenience receptacles, and the point where they exit from the appliance.

12. **Cleaning** - The appliance should be cleaned only as recommended by the manufacturer.
13. **Power Lines** - An outdoor antenna should be located away from power lines.
14. **Outdoor Antenna Grounding** - If an outside antenna is connected to the receiver, be sure the antenna system is grounded so as to provide some protection against voltage surges and built up static charges.
Section 810 of the National Electric Code, ANSI/NFPA No. 70-1984, provides information with respect to proper grounding of the mats and supporting structure grounding of the lead-in wire to an antenna discharge unit, size of grounding connectors, location of antenna-discharge unit, connection to grounding electrodes and requirements for the grounding electrode. See Fig. below.
15. **Non-use Periods** - The power cord of the appliance should be unplugged from the outlet when left unused for a long period of time.
16. **Object and Liquid Entry** - Care should be taken so that objects do not fall and liquids are not spilled into the enclosure through openings.
17. **Damage Requiring Service** - The appliance should be serviced by qualified service personnel when:
 - A. The power supply cord or the plug has been damaged; or
 - B. Objects have fallen, or liquid has been spilled into the appliance; or
 - C. The appliance has been exposed to rain; or
 - D. The appliance does not appear to operate normally or exhibits a marked change in performance; or
 - E. The appliance has been dropped, or the enclosure damaged.
18. **Servicing** - The user should not attempt to service the appliance beyond that described in the operating instructions. All other servicing should be referred to qualified service personnel.

Note to the CATV system installer: This reminder is provided to call the CATV system installer's attention to Article 820-40 of the NEC that provides guidelines for proper grounding and, in particular, specifies that the cable ground shall be connected to the grounding system of the building, as close to the point of cable entry as practical.

EXAMPLE OF ANTENNA GROUNDING AS PER NATIONAL ELECTRICAL CODE (NEC)

Example of Antenna Grounding as per NEC - National Electric Code

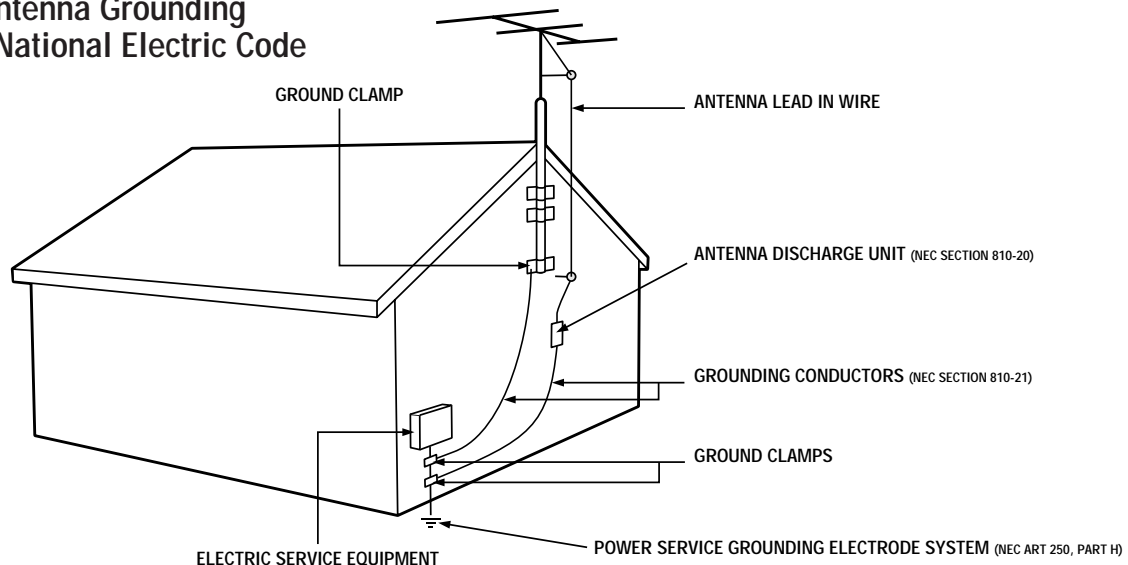

TABLE OF CONTENTS



Getting Started

Welcome/Product Registration	2
Safety/Precautions	3
Table of Contents	4
Features, Model and Cabinet Information	5



On-Screen Features

PICTURE MENU

◇ Adjusting Color, Brightness, Sharpness, Tint, and Picture Controls	6
◇ Using the Clearview Control	7
◇ Adjusting the TV's Convergence Control	8
◇ Using the Flesh Correction Control	9

FEATURES MENU

◇ Selecting a Picture Source	10
◇ Setting the TV for Closed Captioning	11
◇ Setting the TV for Cable or Antenna Signals	12
◇ Adding Channels in Memory (Automatically)	13
◇ Adding Channels in Memory (Manually)	14
◇ Setting the TV Clock	15
◇ Turn-On Timer	16
◇ Using the Sleep Timer Control	17
◇ Adjusting the Channel Display Control	18
◇ Using the Time/Channel Reminder Control	19
◇ Using Parental Control to Censor Channels 20-21	
◇ Using the Channel Label Control	22
◇ Using the Language Selection Control	23

SOUND MENU

◇ Adjusting Bass, Treble, and Balance Sound Controls	24
◇ Setting the Bass Boost Control	24
◇ Setting the TV for Stereo and SAP Programs	25
◇ Using the Incredible Surround Control	26
◇ Using the Volume Display Control	26
◇ Using the TV Speaker On/Off Control with the Audio Output jacks	27
◇ Surround Sound Connections and Variable Audio Output Control	28
◇ Optional Surround Sound Connections	29
◇ Using the TV's Audio/Video Input and Output Jacks	30-33



Remote Control Operation

Using the Remote Locator Feature	34-35
Setting the Smart Picture Control	36-37
Using Smart Sound Control	38
Using the Smart Surf Control	39
Setting the Remote to Work VCRs	40-41
Setting the Remote to Work Cable TV Converters	42-43
Setting the Remote to Work VCRs or Cable Converters - "Search Method"	44
Using the Remote's VCR buttons	45



Picture-In-Picture (PIP)

How to Use PIP (Connections)	46-47
How to Use PIP with the TV Remote	48
Selecting the Picture Source for PIP	49
Adjusting Picture-in-Picture Color and Tint	50
More PIP Connections (Cable Converter)	51



General Information

TV Help Menu	52
Tips if Something Isn't Working	53
Glossary of TV Terms	54
Index	55
Factory Service Locations	56-57
Warranty	60

SET-UP AND QUICK USE GUIDE

Use the simple Set-Up Guide (supplied with your TV information packet) for details on:

- Antenna Hook-ups
- First Time Set-Up (Automatic Settings)
- Basic TV and Remote Control Operation
- On-Screen Menu Use

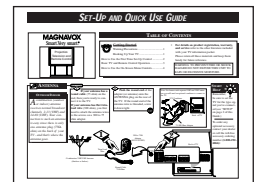

Because of continuous product improvements, the information mentioned in the documents accompanying your product are subject to change without notice.



First Time Set Up - automatically sets the TV for local channels, the correct picture signal (antenna or cable), and assists in the setting of TV's Guide Plus+ feature.

Infrared Remote Control - operates your TV set and a variety of wireless remote control VCRs and Cable TV Converters. A special "Locator" feature can also help you find the remote when it has been stuck out of sight or misplaced.

Standard TV broadcast (VHF/UHF) or Cable TV (CATV) channel capability.

Closed Captioning - allows the viewer to read TV program dialogue or voice conversations as on-screen text.

Automatic Programming of channels - for quick and easy selection of favorite stations available in your area.

Picture-In-Picture (PIP) - can show a TV program and the direct video output from an accessory (VCR, etc.) onto the TV screen at the same time.

Parental Control for "Censoring" - this feature can block out channels to keep children from watching undesirable programming.

Stereo-TV - with a built-in audio amplifier and a twin speaker system, reception of TV programs in both broadcast stereo sound or (SAP) bilingual broadcast are available.

Twin Antenna (A/B) Inputs - for easy displaying of two separate signal sources on the TV. An A/B button on the remote control switches the TV's Main screen between the two Antenna (A & B) Input options.

Audio/Video Jacks - for direct connections with VCRs (and other accessories) for quality TV picture and sound playback.

Surround Sound - this TV set is equipped for connections with external audio equipment (such as a Dolby ProLogic Amplifiers) for more dynamic sound replay and audio effects.

Sleep-Timer - automatically turns the TV OFF at preset time intervals.

Smart Button - for the control of TV Sound and the Picture levels. Use the Smart Button on the remote to quickly adjust Smart Sound (to set TV Volume levels during program changes or commercial breaks); Smart Picture (for programmed video level adjustments on a variety of program sources); and Smart Surf (for quick one button channel selection of up to 10 of your favorite channels).

As you unpack your TV please note that the following items have been included with your set:

- Owner's Manual
 - Safety Tip Information
 - Factory Service Center Locations
- Warranty Registration Card
- Remote Control Transmitter
- Batteries for Remote Control Use

Please take a few minutes to complete your registration card. The serial number for the TV is on the back of the set.

Refer to the back of this manual for instructions on the cleaning and care of the TV.

End-of-Life disposal

Your new projection television and its packaging contain materials that can be recycled and reused. Specialized companies can recycle your product to increase the amount of reusable materials and minimize the amounts which need to be properly disposed.

Your product also uses batteries which should not be thrown away when depleted, but should be handed in and disposed of as small chemical waste.

Please find out about the local regulations on how to dispose of your old television, batteries, and packaging materials whenever you replace existing equipment.

NOTE: Your Projection Television's Menu (or On-Screen Control system) is used with several different television models. Not all of the feature controls described within this owner's manual will necessarily be present or operable with your set. This is normal and does not require you contacting your dealer or requesting service.

PICTURE MENU CONTROL ADJUSTMENTS

COLOR, BRIGHTNESS, SHARPNESS, TINT, PICTURE

To adjust your TV color and picture controls, select a TV channel and follow the steps shown below:

BEGIN

- 1 Select **BRIGHTNESS, PICTURE, COLOR, TINT, or SHARPNESS** picture control.

With the PICTURE MENU on screen, move the RED highlight with the MENU (M)  buttons. Then press the MENU button.

- 2 Press the (+) or (-) buttons to adjust the selected control.

- 3 Press the STATUS button to clear the screen.



SMART HELP



Remember. When the bar scale is centered, control settings are at normal mid-range levels.

BRIGHTNESS Press (-) or (+) until dark parts of the picture show good detail.

PICTURE Press (-) or (+) until whitest parts of the picture are as bright as you prefer.

COLOR Press (-) or (+) to add or eliminate color.

TINT Press (-) or (+) to obtain natural skin tones. (Also see Flesh Correction on page 9 for more information).

SHARPNESS Press (-) or (+) to improve detail in the picture.

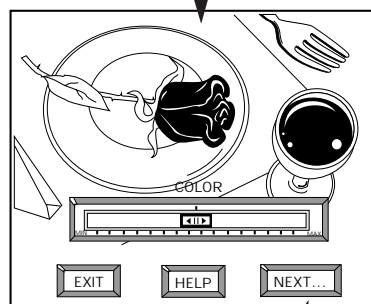
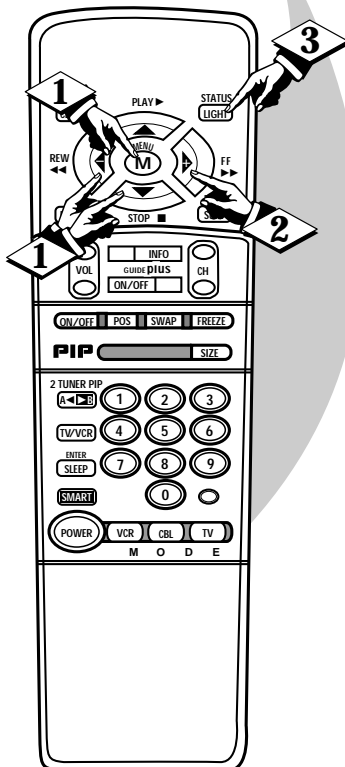
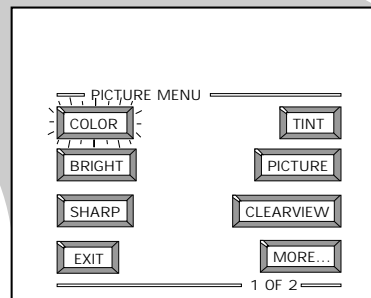
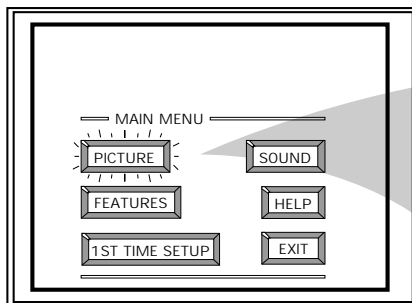



Select and then press MENU (M) button to view an explanation of the selected feature.

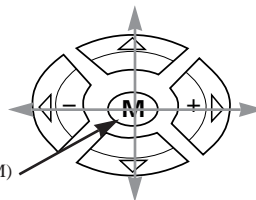

Select and then press MENU (M) button to view additional controls grouped under same feature heading. For Example: Tint, Brightness, Picture, etc.

HOW TO SELECT FEATURES (WITH BUTTONS ON THE REMOTE)



Press MENU (M) to select RED highlighted

Press MENU (M)   to move Up and Down within the Menu.

Press MENU (M)   to move from Side-to-Side within the Menu.



CLEARVIEW

Clearview is a sharpness feature which smoothes out background snow (or picture noise) without losing picture image detail or crispness.

BEGIN

- 1 Select **CLEARVIEW** control.

With the PICTURE MENU on screen, move the RED highlight with the MENU (M) buttons. Then press the MENU button.

- 2 Press the MENU buttons to move the RED highlight. Press the MENU button to select (✓) the ENHANCED mode.

- 3 Press the STATUS button to clear the screen.

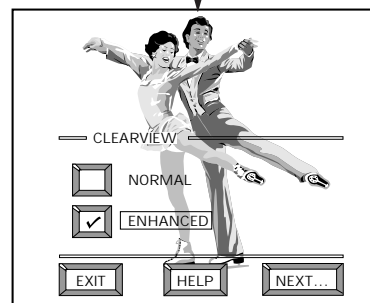
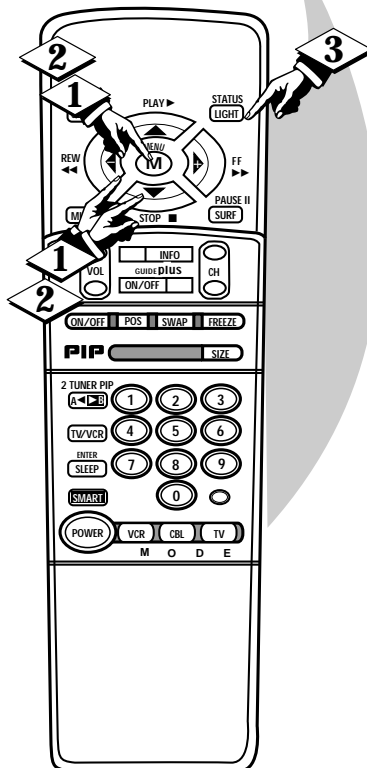
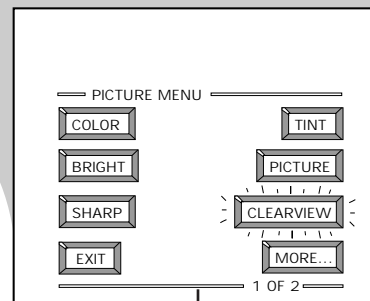
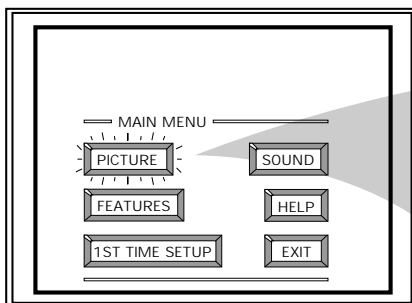

RED/BLUE CONVERGENCE

Convergence is the correct lining up of the red and blue light paths on the TV screen.

NOTE: If no color fringing (see Smart Help) shows, then no Convergence adjustments are necessary for your TV.

BEGIN

- 1 Select **CONVERGENCE** control.

With PICTURE MENU (2 of 2) on screen, move the RED highlight with the MENU (M) and arrow buttons. Then press the MENU button.

- 2 If there is **RED or BLUE** color fringing on the White cross, press the MENU button to continue.

- 3 Press the MENU and arrow buttons to move the red or blue cross directly over the white cross on the TV screen.

The red or blue cross is properly adjusted when it is completely merged with the white cross. (No color appears around the edge of the white cross).

- 4 Press the **STATUS** button to clear the screen when convergence adjustments are complete.



SMART HELP



Remember. Convergence has been set at the factory for best viewing, but if one or more of the (red or blue) colors appear around the edges of objects (color fringing) follow the steps given in this section.

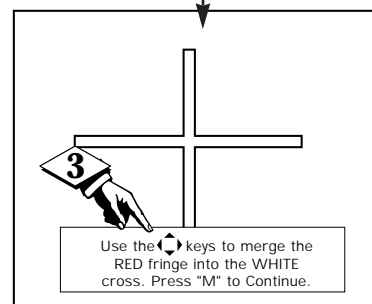
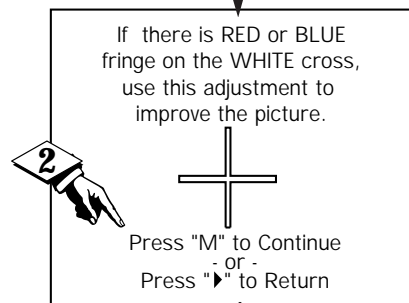
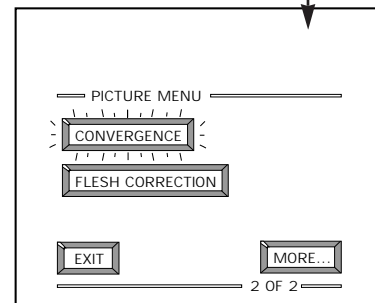
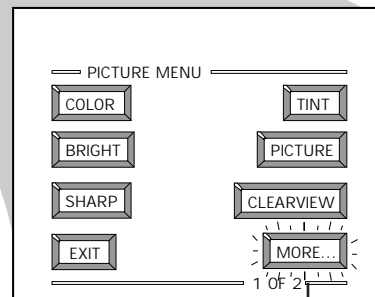
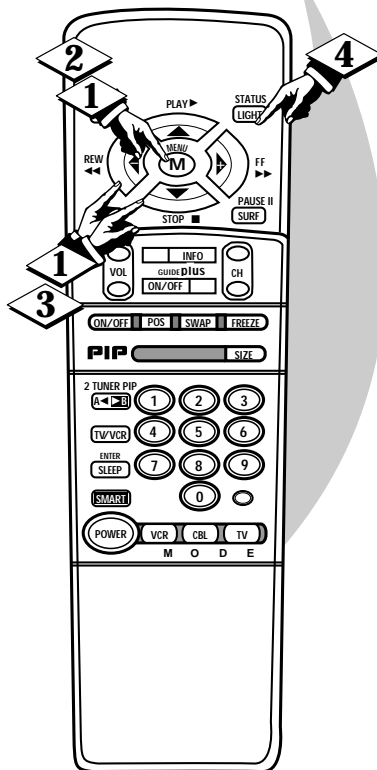
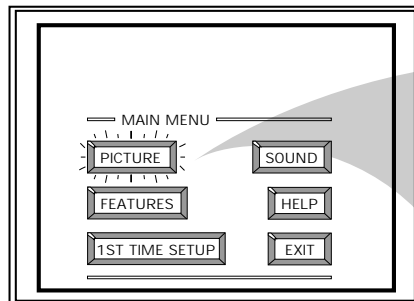



FLESH CORRECTION

Use the *Flesh Correction* control to keep skin tone hues (or facial tint) from varying from TV channel to TV channel.

BEGIN

- 1 Select **FLESH CORRECTION** control.

With PICTURE MENU (2 of 2) on screen, move the RED highlight with the MENU (M)  buttons. Then press the MENU button.

- 2 Press the MENU   buttons to move the RED highlight. Press the MENU button to turn (✓) the FLESH CORRECTION control ON.

- 3 Press the STATUS button to clear the screen.

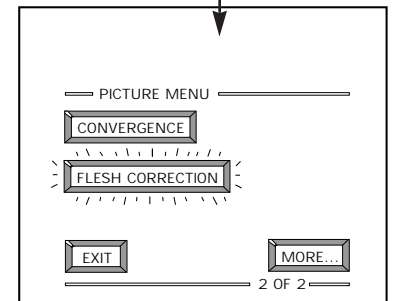
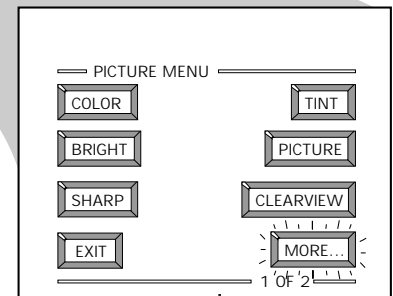
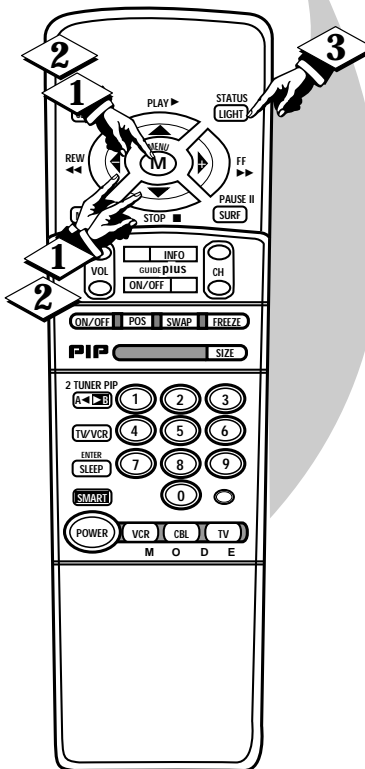
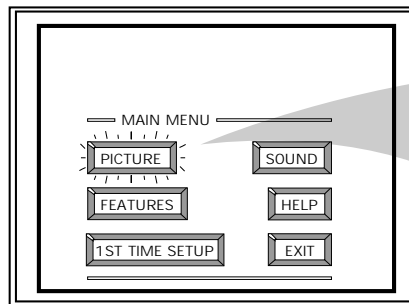

PICTURE SOURCE

The picture for the TV can come through either the ANTENNA plug or the AUDIO/VIDEO Input jacks (on the rear of the TV). The Picture Source control simply tells the TV which one of these picture sources it is to show on the TV screen.

BEGIN

1 Select PICTURE SOURCE SELECT control.

With the FEATURES MENU on screen, move the RED highlight with the MENU (M) buttons. Then press the MENU button.

2 Press the MENU ▲▼ buttons to move the RED highlight. Press the MENU button to turn the desired PICTURE SOURCE control ON (✓).

ANT A or B- for a picture signal coming from either the ANT(enna) A or B Input plugs on the TV.

AUX 1- for a picture signal coming from the AUX 1 Video Input jack on the rear of the TV.

AUX 2- for a picture signal coming from the AUX 2 Video Input jack on the rear of the TV.

AUX 3- for a picture signal coming from the Video Input jack on the front of the TV.

3 Press the STATUS button to clear the screen.



SMART HELP

Remember, the AUX 1, AUX 2, and AUX 3 modes must have a video signal source connected (to their INPUT plug) or the TV screen will be blank. (See page 30 for connection details).

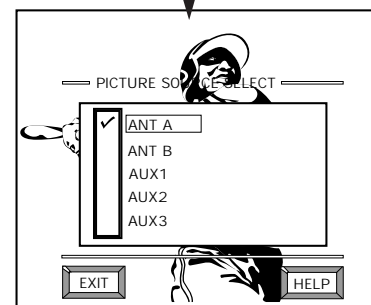
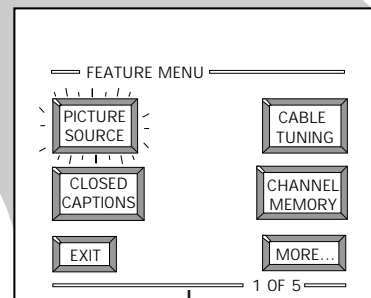
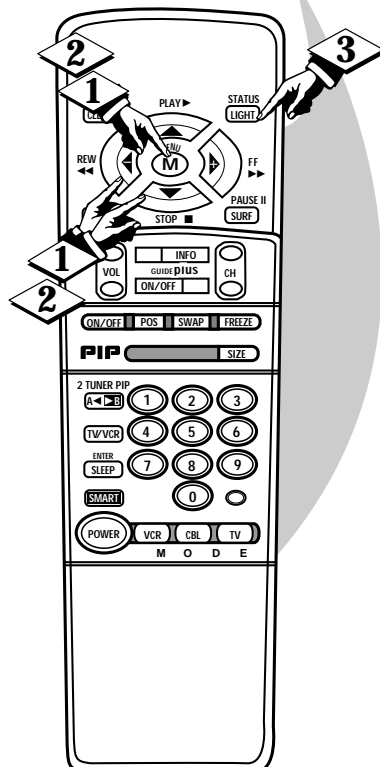
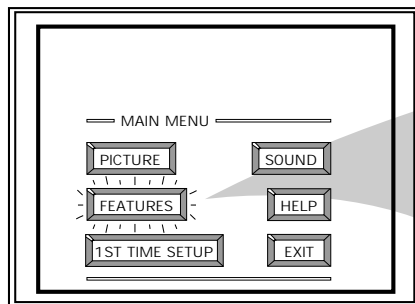

Note: A "S-VIDEO 1" (or 2) Input will appear as a PICTURE SOURCE SELECT(ion) in place of the AUX 1 (or AUX 2) position when the S-VIDEO plugs (on the rear of the TV) are connected. See page 32 for operating details on S-VIDEO.

CLOSED CAPTION

Closed Captioning (CC) allows you to read the voice content of television programs on the TV screen. Designed to help the hearing impaired this feature uses on-screen "text boxes" to show dialogue and conversations while the TV program is in progress.

BEGIN

- 1 Select **CLOSED CAPTIONING** control.

With the FEATURES MENU on screen, move the RED highlight with the MENU (M) buttons. Then press the MENU button.

- 2 Press the MENU ▲▼ buttons to move the RED highlight. Press the MENU button to select (✓) the desired Closed Caption mode - For Example: "ALWAYS ON" and "CAPTION 1".

CAPTION 1, 2, 3, 4:

dialogue (and descriptions) for the action on the captioned TV program shows on-screen. (See Important Note on this page.)

TEXT 1, 2, 3, 4:

often used for channel guide, schedules, or bulletin board information for CC programs.

- 3 After making your Caption mode selection, press the **STATUS** button to clear the TV screen. The selected Closed Caption mode will be active.

To cancel, set the Closed Captioned feature to OFF when finished.



SMART HELP



Remember. Broadcast stations will often use spelling abbreviations, symbols, dropouts and other grammatical shortcuts in order to keep pace with the on-screen action. These type factors vary upon the source of the captioned text material and do not indicate a need for service on the part of the TV.

NOTE: Not all TV programs and product commercials are made for broadcast with Closed Caption (CC) information included. Neither are all Closed Caption modes (CAPTION 1-4; or TEXT 1-4) necessarily being used by a broadcast station during the transmission of a closed caption program. Usually "CAPTION 1" is the most used mode to view captioned material. Refer to your area's TV program listings for the stations and times of Closed Caption shows.

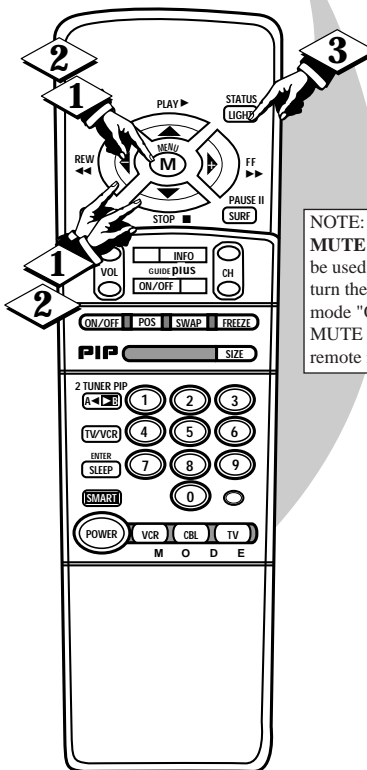
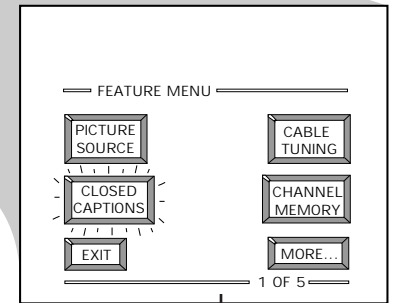
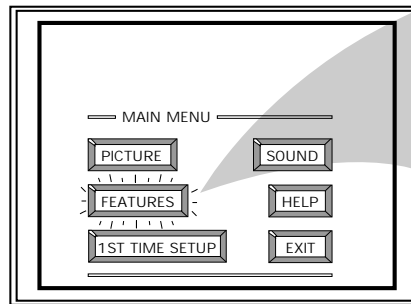

NOTE: The ON DURING MUTE ONLY control can be used to set the TV to turn the Closed Caption mode "ON" whenever the MUTE button on the remote is pressed.

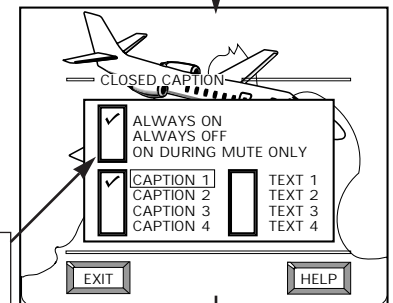

CAPTION 1 mode
Example Screen Display

Closed Caption information will usually appear in black and white (although some broadcasters or networks may occasionally use color to highlight or draw attention to certain areas.)

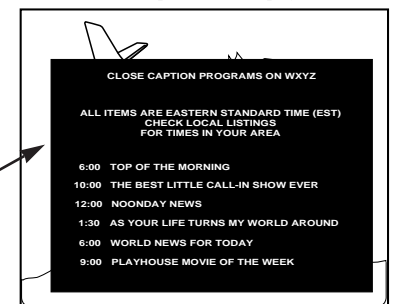

FULL SCREEN TEXT
will block TV screen from viewing

CABLE TUNING

You need to make sure the TV is set to pick up either Cable TV or Antenna signals. In other words, the TV needs to know if you connected a Cable TV signal or a normal antenna to its ANTENNA plug.

NOTE: If you went through First Time Setup (in your Quick Use Guide), this task has already been completed for you.

BEGIN

1 Select CABLE CHANNEL TUNING control.

With the FEATURES MENU on screen, move the RED highlight with the MENU (M) buttons. Then press the MENU button.

2 Press the MENU ▲▼ buttons to move the RED highlight. Press the MENU button to select (✓) the desired mode - For Example: CABLE.

CABLE- If you DO have Cable TV connected to the TV. Channels 1-125 available.

NORMAL- If you have an Antenna connected to the TV. Channels 2-69 available.

3 Press the STATUS button to clear the screen.

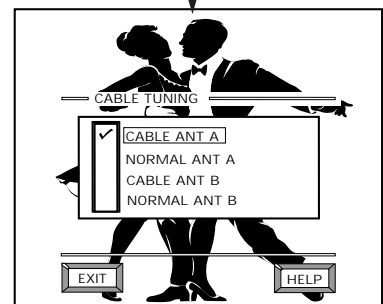
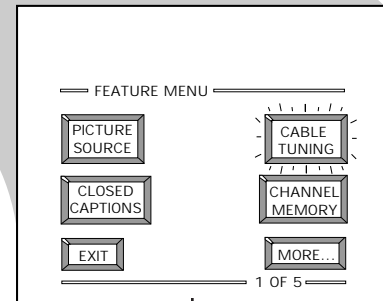
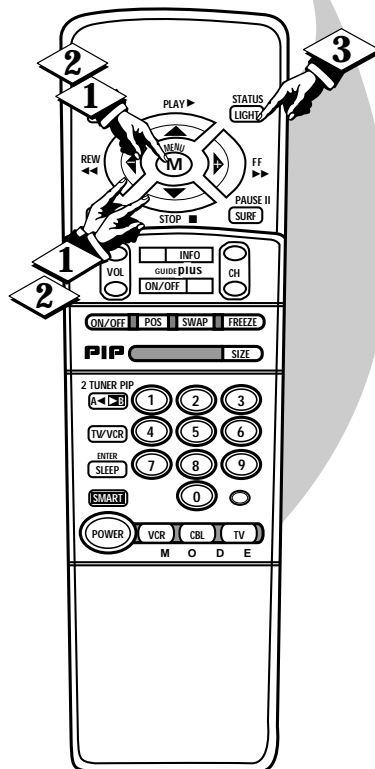
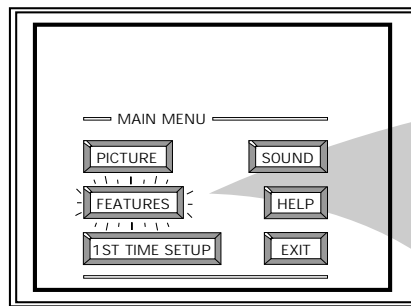

Note: Both ANT(enna) A and ANT B inputs on the rear of the TV can be set for the correct connected signal (either an Antenna or Cable TV source).

CHANNEL MEMORY AUTO-PROGRAMMING

Your TV can automatically set itself for local area (or Cable TV) channels. This makes it easy for you to select only the TV stations in your area when the CHANNEL ▲▼ buttons are pressed.

NOTE: If you went through First Time Setup (in your Quick Use Guide), this task has already been completed for you.

(BEGIN)

- 1 Select **CHANNEL MEMORY (START AUTO-PROGRAMMING)** control.

With the FEATURES MENU on screen, move the RED highlight with the MENU (M) buttons. Then press the MENU button.

- 2 Press the **MENU** button to turn **AUTO-PROGRAMMING ON**.

The TV shows which channel numbers are "SAVED" (✓) as they are added into memory.

"Auto-programming CHANNEL MEMORY is finished" shows when the TV is through adding channels.

- 3 Press the **STATUS** or **Menu (M)** button to clear the screen.



SMART HELP



Try it out. Press the **CHANNEL ▲▼** buttons and see which channels you can select.

Remember, an Antenna or Cable TV signal must first be connected to your TV so that channels can be saved.

If you want to delete any unwanted channels from the TV's memory, see "ADD/DELETE CHANNELS" on the next page.

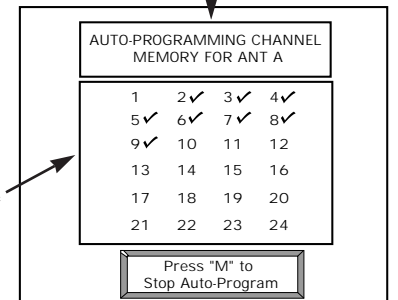
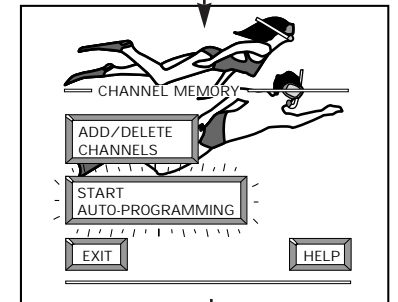
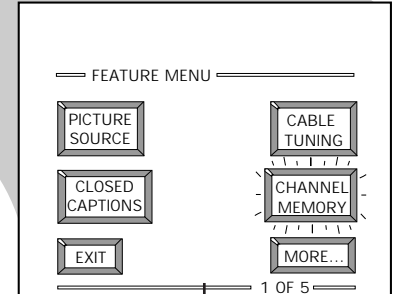
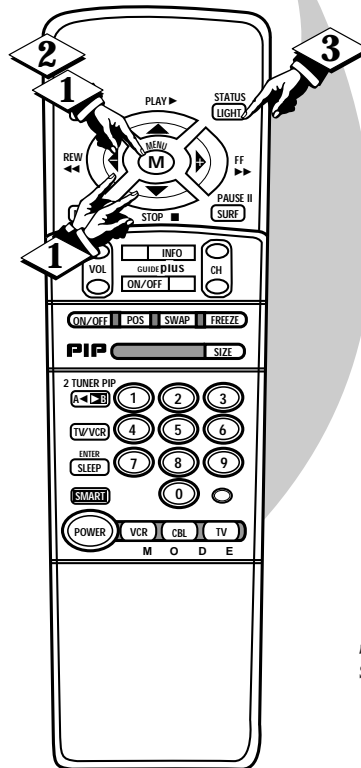
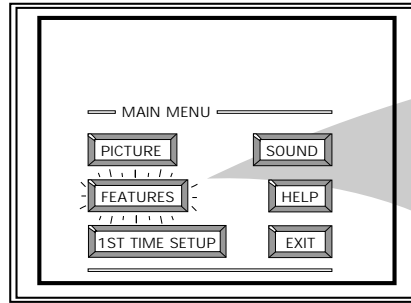

✓ Channel Numbers are Saved in Memory

ADD/DELETE CHANNELS

Auto-Programming (see *previous page*) adds all the channels it can find (on your Antenna or Cable TV system) into the TV's memory. Add/Delete Channels makes it easy for you to add other channels, or drop unwanted channels, from the list of channels in the TV's memory.

BEGIN

- 1 Select **CHANNEL MEMORY (ADD/DELETE CHANNELS)** control.

With the FEATURES MENU on screen, move the RED highlight with the MENU (M) ◀▶ buttons. Then press the MENU button.

- 2 Press the **CHANNEL ▲▼** or **number** buttons to select the channel you want to add or delete.

- 3 Press the **MENU ▶** button to ADD the channel into the TV's memory.

Press the **MENU ◀** button to DELETE the channel from memory.

Repeat steps 2 and 3 for each channel you wish to add or delete.

- 4 Press the **STATUS** or **MENU** button to clear the screen when through.

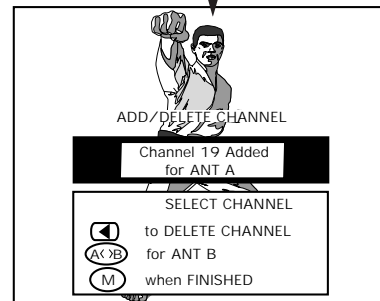
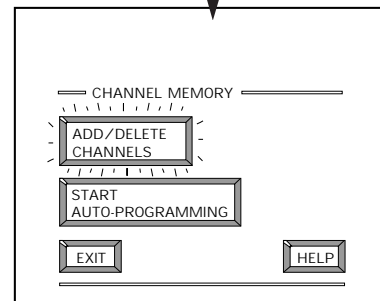
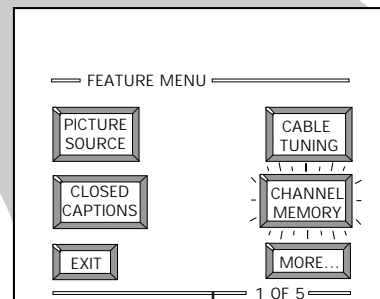
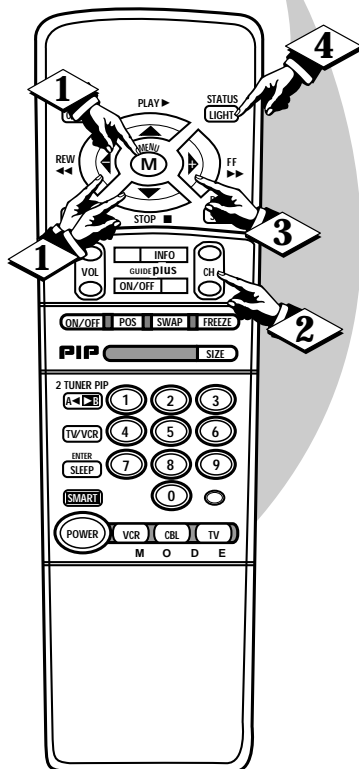
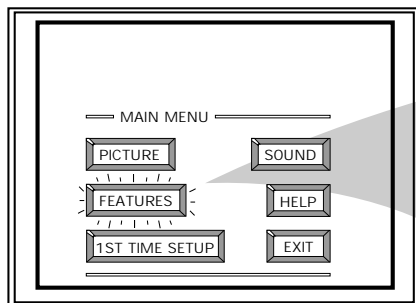

SMART HELP

Remember. You can also add the AUX 1, AUX 2, or AUX 3 modes just like a channel. Then by pressing the CHANNEL ▲▼ buttons the AUX(iliary) mode can quickly be selected to use the desired set of Input jacks on the TV (see page 30).

Note: AUX 1, AUX 2, and AUX 3 modes are located between the lowest and highest channel numbers within the ADD/DELETE CHANNEL control screen.

NOTE: A separate ADD/DELETE CHANNEL memory may also be created for the ANT(enna) B Input on the rear of the set (if an Antenna or Cable TV signal has been connected). Just press the ◀▶ button on the remote, while in the ADD/DELETE CHANNEL mode, to switch between the ANT A and ANT B channel memory lists. Then follow steps 2 and 3 as shown to the left to add or delete the desired channels.

SET CLOCK

Your TV comes with an on-screen clock. During normal operation the clock appears on the screen with every channel change (and when the STATUS button is pressed).

BEGIN

- 1 Select SET CLOCK control.

With FEATURES MENU (2 of 5) on screen, move the RED highlight with the MENU (M) buttons. Then press the MENU button.

- 2 Press the remote's number buttons to set the time clock.

- 3 Press the STATUS button to set the clock in operation and clear the screen.



SMART HELP



Remember, be sure to press "0" first and then the hour number for single digit entries.

The remote's MENU (M) buttons can also be used to set the hours, minutes and AM/PM portions of the clock.

TV Clock settings may be lost when the TV is unplugged (or AC power to the set is interrupted.)

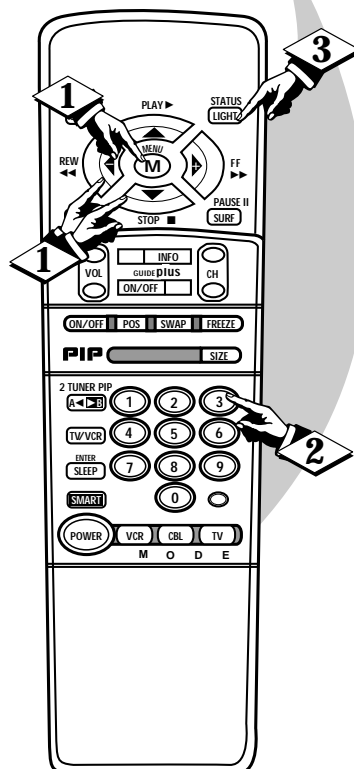
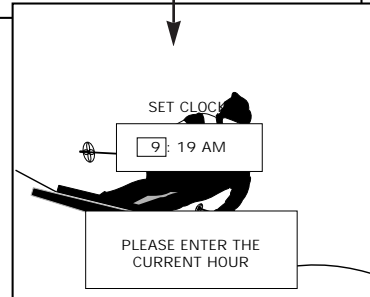
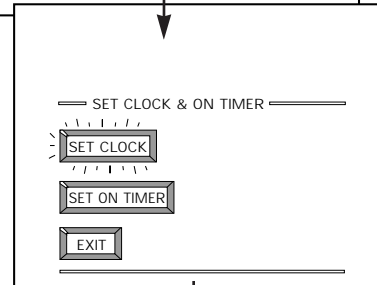
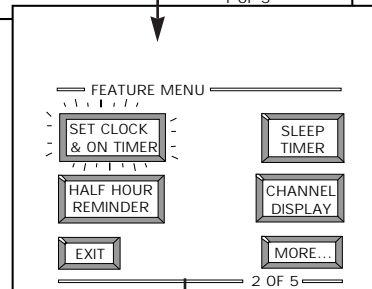
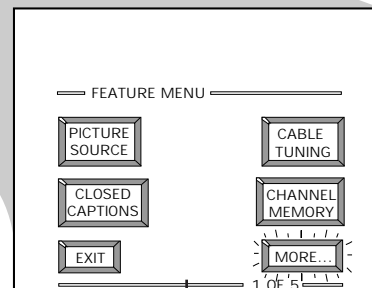
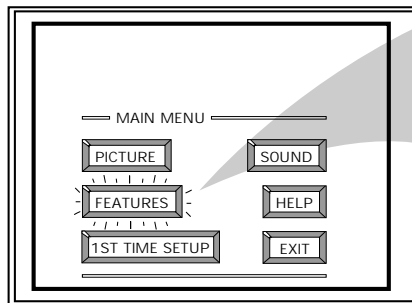



SET ON TIMER

Just like an alarm clock you can set the TV to turn itself on at the same time everyday.

BEGIN

- 1 Select SET ON TIMER** control.

With FEATURES MENU (2 of 5) on screen, move the RED highlight with the MENU (M)  buttons. Then press the MENU button.

- 2 Press the MENU  and MENU (M) buttons to highlight and select "ON" ().**

- 3 Press the MENU  and then the MENU (M) buttons to select "SET ON TIME".**

- 4 Press the remote's number buttons to set the "TURN ON" time for the TV. (Press MENU  for AM or PM.)**

- 5 Press the STATUS button to set the "ON TIME" and clear the screen.**

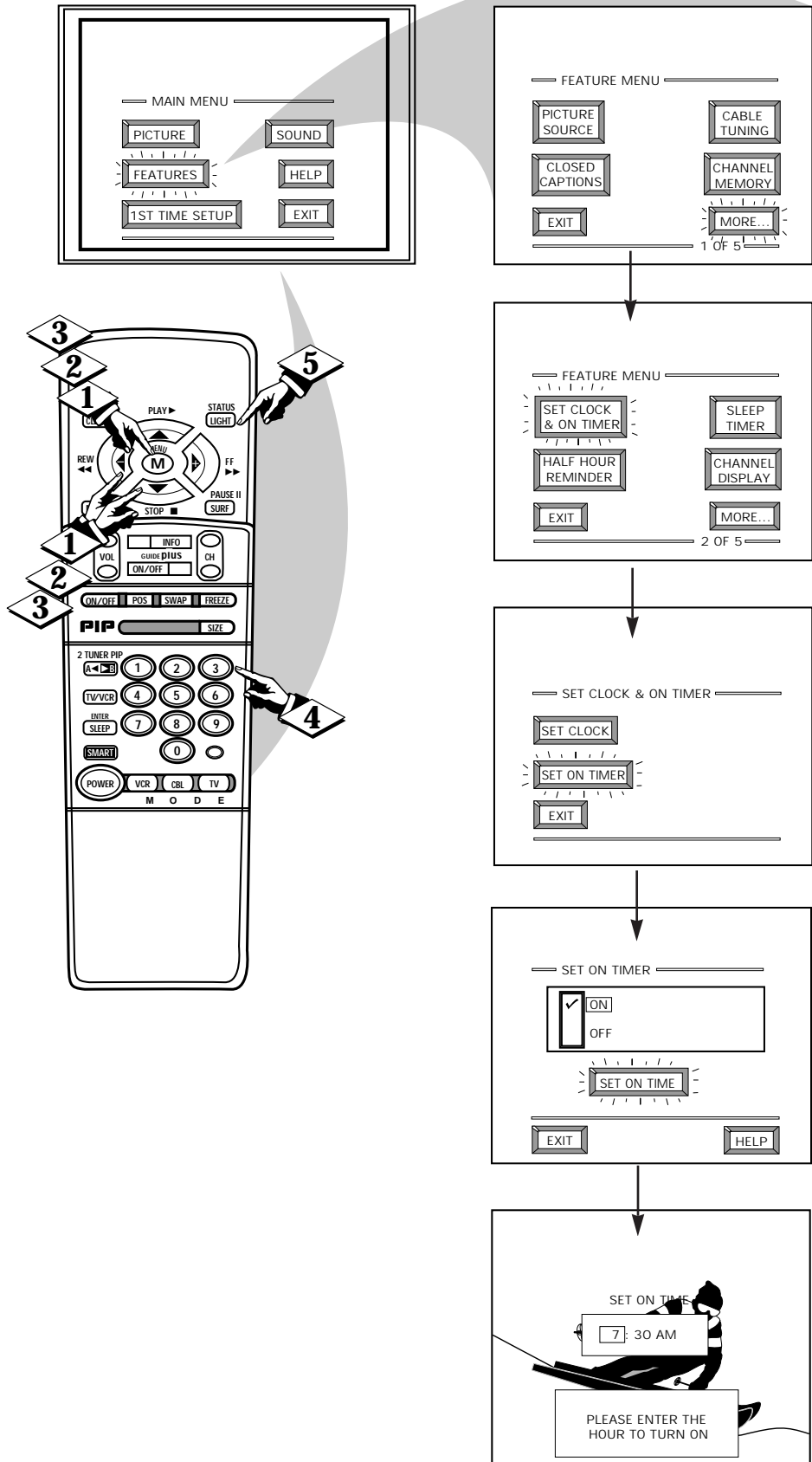

SLEEP TIMER

Have you ever fallen asleep in front of the TV only to have it wake you up at two in the morning with a test pattern screeching in your ears? Well, your TV can save you all that trouble by automatically turning itself off.

BEGIN

- 1 Press the **SLEEP** button on the remote control.

Note: you can also select the SLEEP control with the TV's on-screen FEATURES MENU (2 of 5). Move the RED highlight with the MENU (M) buttons. Then press the MENU button.

- 2 Press the **SLEEP** button repeatedly to pick the amount of time (15 minutes to 2 hours ahead) before the TV will turn itself off.

The (+), (-) buttons can also be used to set the amount of time.

- 3 Press the **STATUS** or **MENU (M)** button to clear the screen after you have set the time for the TV to turn off.



SMART HELP



Remember, to see how many minutes are left before the TV shuts itself off, reselect the SLEEP TIMER control screen.

To stop a SLEEP TIMER setting, reset the timer back to OFF.

(Turning the TV off and on, or pressing a button during the last minute of a timer setting, will also cancel a setting.)

A few seconds before the TV is to shut off a message will come on the screen telling you *GOOD NIGHT*.

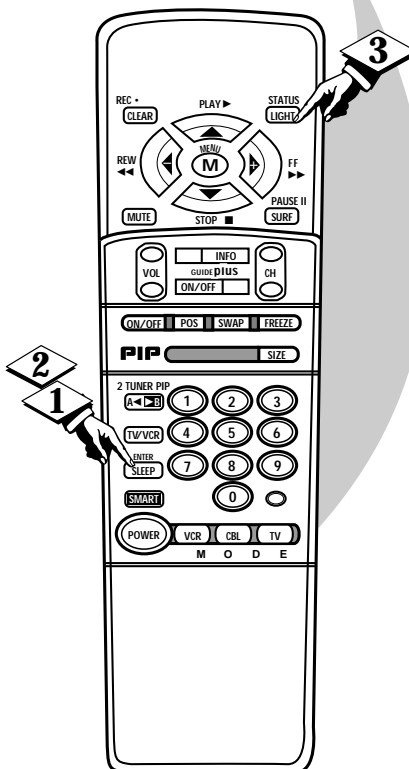
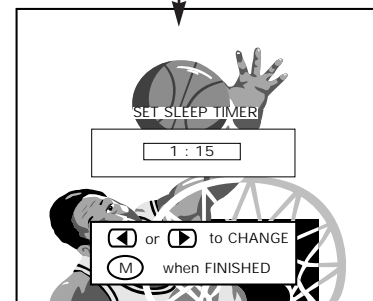
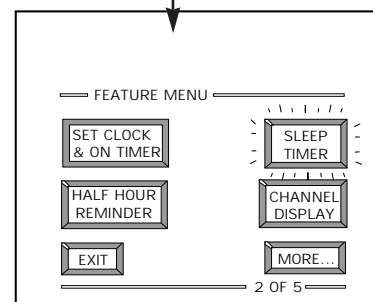
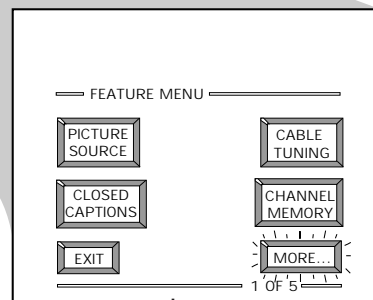
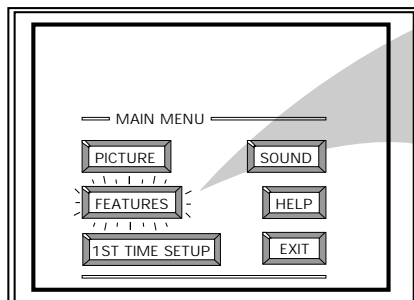

CHANNEL DISPLAY

With the Channel Display control you can change the size and location of the on screen channel and clock information.

BEGIN

- 1 Select CHANNEL DISPLAY control.

With FEATURES MENU (2 of 5) on screen, move the RED highlight with the MENU (M) buttons. Then press the MENU button.

- 2 Press the MENU ▲▼ and MENU (M) buttons to highlight and select (✓) the LARGE or SMALL display control.

- 3 Press the STATUS button to clear the screen.



SMART HELP

Try it out. Press the CHANNEL ▲▼ buttons and you should see the Display Size you selected.

Remember. The SMALL SIZE display shows only the channel number, not the time (or clock).

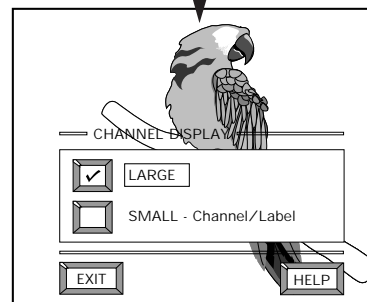
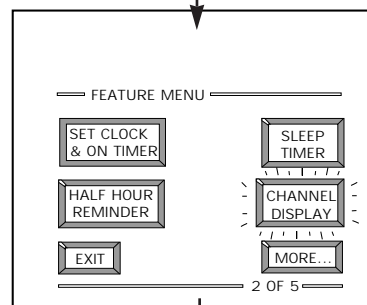
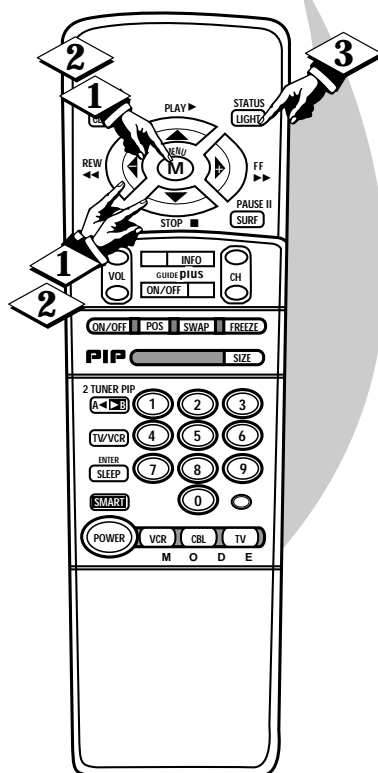
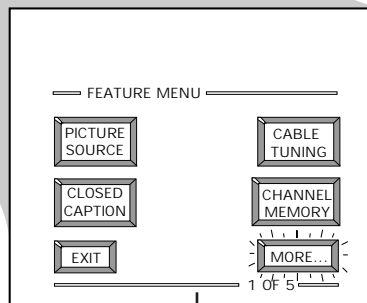
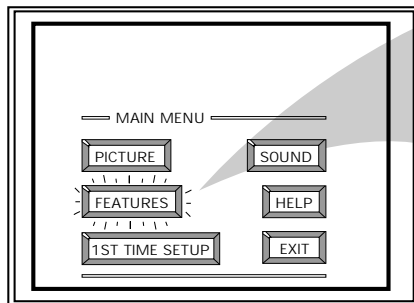

HALF HOUR REMINDER

With the Half Hour Reminder control the TV automatically shows you the current time and channel every thirty minutes.

BEGIN

- 1 Select **HALF HOUR REMINDER** control.

With FEATURES MENU (2 of 5) on screen, move the RED highlight with the MENU (M) buttons. Then press the MENU button.

- 2 Press the MENU ▲▼ and MENU (M) buttons to highlight and select (✓) the EVERY HALF HOUR item.

- 3 Press the STATUS button to clear the screen.



SMART HELP



Remember. The Time and Channel Reminders will show on the hour and the half-hour for about five seconds.

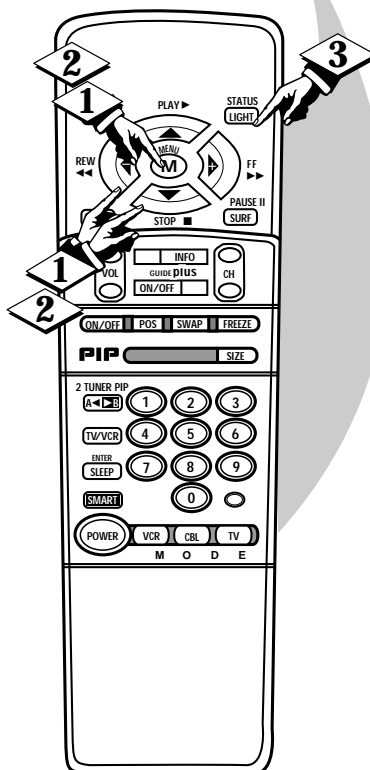
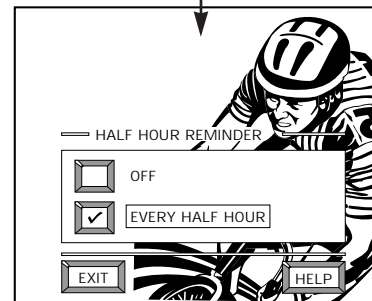
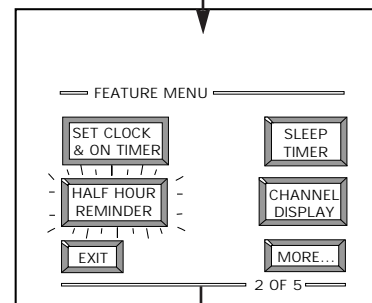
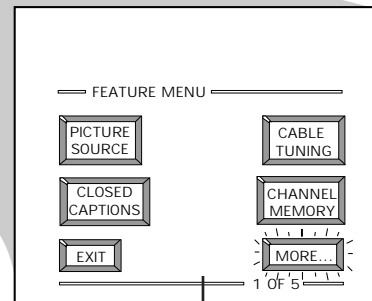
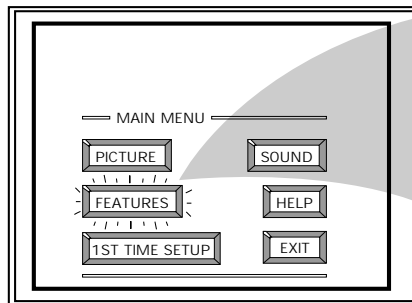

PARENTAL CONTROL

Parental Control allows parents to block out, or "censor", any channels they think children should not watch. A channel placed under Parental Control cannot be viewed until a correct access code is used to unlock the channel for viewing.

First let's set your Parental Code:

BEGIN

1 Select the PARENTAL CONTROL.

With FEATURES MENU (3 of 5) on screen, move the RED highlight with the MENU (M) buttons. Then press the MENU button.

"BLOCK CHANNELS" and "SETUP CODE" show on screen.

2 Press the MENU and MENU (M) buttons to highlight and select the SETUP CODE item.

3 Press 0, 7, 1, 1 on the remote.

"XXXX" shows on the ACCESS CODE SETUP screen as you press the number buttons.

"INCORRECT ACCESS CODE - TRY AGAIN" will also show on the screen.

4 Press 0, 7, 1, 1 on the remote again.

"Next Enter Your New Access Code" shows on the screen.

5 Enter a new four digit number code using the remote.

"Access Code Changed" shows on the screen to let you know the new code has been set.

Continue to the next page to find out how to "block" channels from viewing.

NOTE: Your TV left the factory with the Parental Code set to "0000". If you are using your TV and the Parental Control for the first time, and don't want to SETUP a new Access code number, you can use the "0000" number to block channels - see next page. The "0711" Parental Code (shown on this page) is given as a default or way to reset the Code when the current Access number is not known.

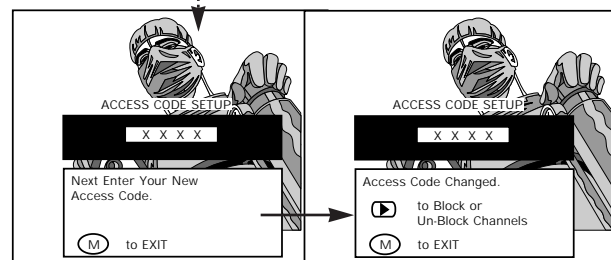
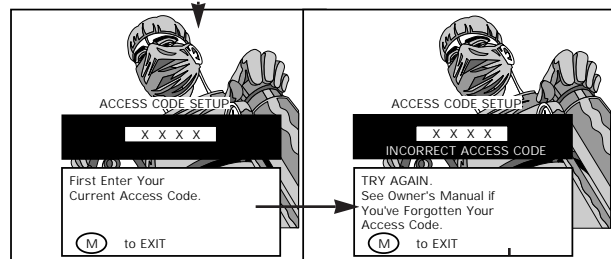
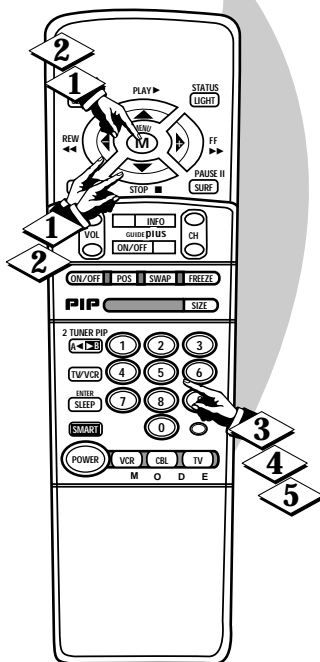
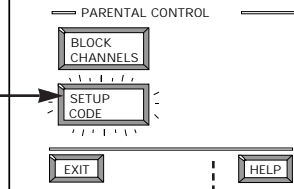
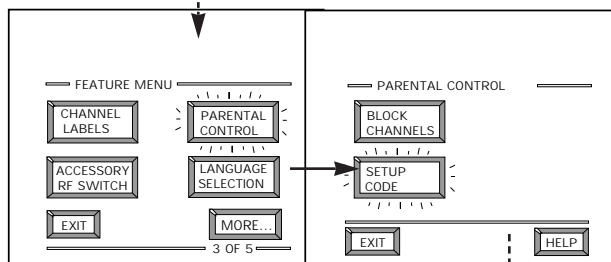
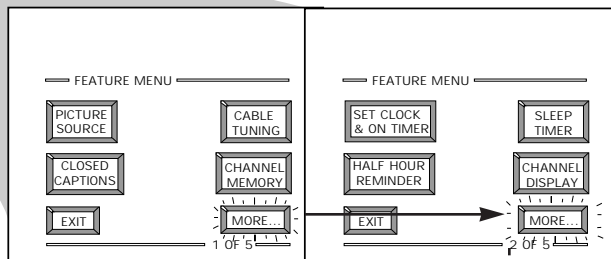
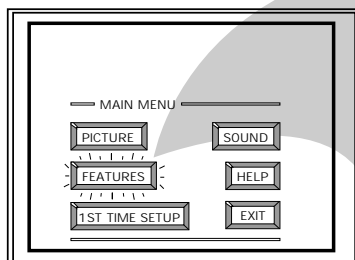

- Press MENU to go on and start to "block" channels
- Press MENU to return to the Parental Control Menu screen.
- Press STATUS to clear the screen.

SMART HELP

Parents - it isn't possible to unlock or defeat your Censor Code without changing to a new code number. So if your Code number changes, and you didn't change it yourself, then you will know that someone has altered the code and the blanked out channel has been viewed.

PARENTAL CONTROL

After your personal Parental Code number has been set (see previous page), you are now ready to select the channels you want to block out or censor.

BEGIN

1 Select the **BLOCK CHANNELS** control.

With FEATURES MENU (3 of 5) on screen, move the RED highlight with the MENU (M) \blacktriangle \blacktriangledown buttons. Then press the MENU button.

2 Press the MENU \blacktriangle \blacktriangledown and MENU (M) buttons to highlight and select the **BLOCK CHANNELS** item.

3 Enter the correct Parental Code number.

4 Press Channel \blacktriangle \blacktriangledown or Channel Number buttons to select the channel you want to block.

5 Press the MENU \blacktriangleright button to "BLOCK VIEWING" on the selected channel. Press the MENU \blacktriangleleft button to "ALLOW VIEWING" on a blocked channel.

Repeat steps 3 and 4 for any other channels you wish to block out.

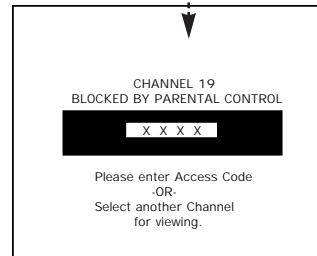
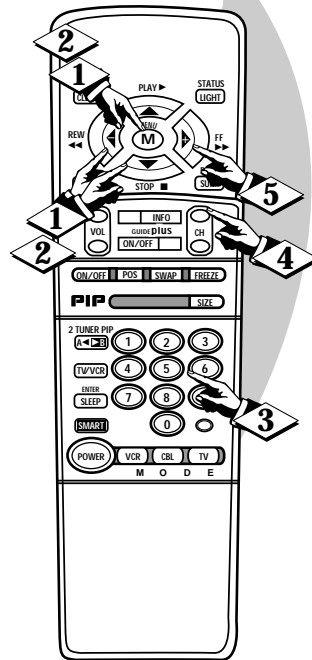
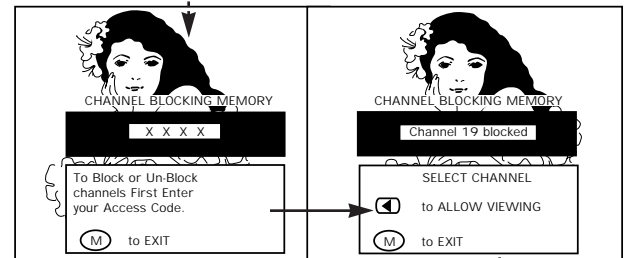
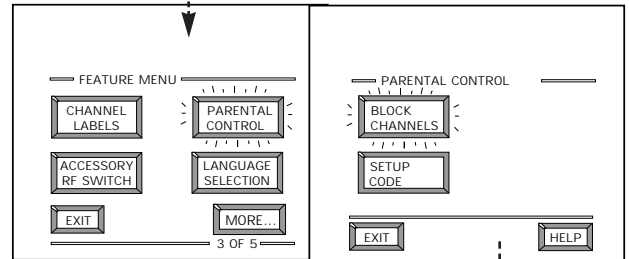
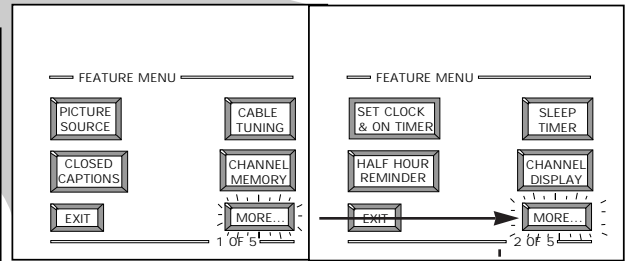
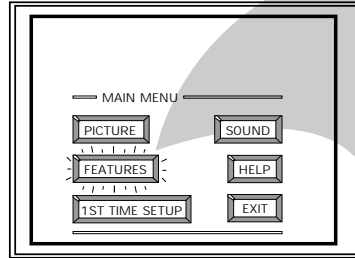

Note: You can also block out the use of the Audio/Video Input jacks on the TV. This stops the viewing of VCR programs which can be shown through the A/V IN jacks. Just select VCR/AUX 1, AUX 2, or AUX 3 (located between the lowest and highest channel numbers) on the Channel Blocking screen, and select "blocked".

BLOCKED CHANNEL SCREEN MESSAGE
(Appears when an attempt to select a blocked channel is made and Parental Control is ON.)

SMART HELP



Remember, once set Parental Control blocks out the selected channel number on both the ANT A and ANT B channel rings. Also, to make TV viewing easier all channels (for both ANT A/B and Audio/Video Input jacks) will be unblocked, once the correct Parental Code number has been entered. When the TV is turned OFF and then back ON again, is when Parental Control is back in place for all blocked out channels.

CHANNEL LABELS

Do you ever have trouble remembering on which channel a particular station or network is located? The Channel Labels Control is a quick way to view and select channels from a list of Labelled channels.

A Label is a four letter callout you can set to appear with the on screen channel number. Example Label: WXYZ - for a TV station's call letters.

To select channels from the Channel Labels Control:

BEGIN

- 1** With the FEATURE MENU screen (3 of 5) on the TV's screen, move the RED highlight using the MENU (M) buttons to select CHANNEL LABELS. Press the MENU (M) button.
- 2** Press the MENU and MENU (M) buttons to highlight and select either:
 - "MANUAL" to create your own label for a channel.
 - "PRESETS" to choose from a list of prewritten channel labels.
 (See instruction details on this page.)
- 3** Press the STATUS button to clear the screen.

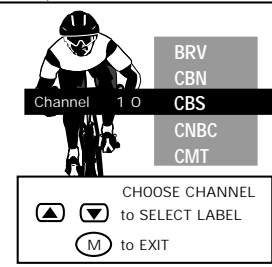
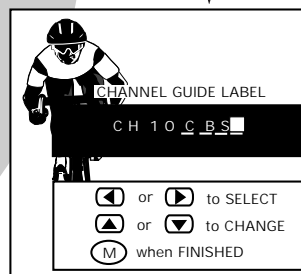
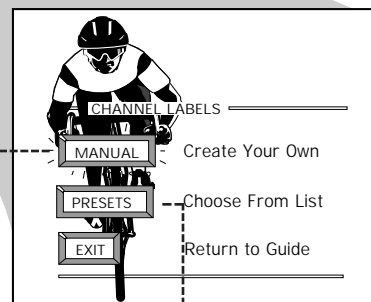
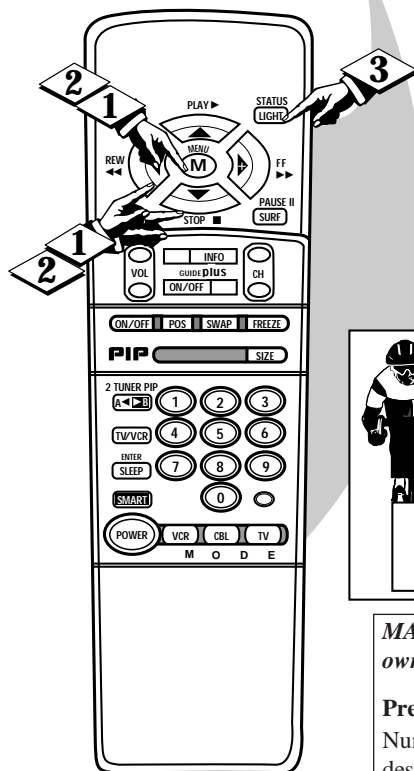
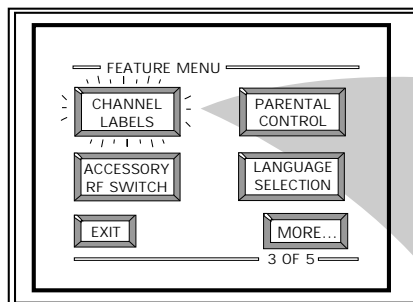

MANUAL- To create your own Channel Label:

Press the Channel or Number buttons to select desired station.

A red highlight shows the active letter space for the channel label.

Press the MENU buttons to pick any of the letters or symbols that are given for your use.

Press the MENU buttons to move the red highlight to the other letter spaces and repeat.

Press the STATUS button to clear the screen when finished.

PRESETS - To pick a Label from the "LABEL" list:

Press the Channel or Number buttons to select desired station.

Press the MENU buttons to move up and down the Channel Label list.

Just stop on any label you might want to use.

The selected label automatically appears with channel changes and when the STATUS button is pressed.

Press the STATUS button to clear the screen when finished.

LANGUAGE

Note: If you went through First Time Setup, This task has already been completed for you.

For our Spanish and French speaking TV owners an on-screen LANGUAGE option is present. With the LANGUAGE control you can set the TV's on-screen features to be shown in either English, Spanish or French.

BEGIN

1 Select the LANGUAGE DISPLAY control.

With FEATURES MENU (3 of 5) on screen, move the RED highlight with the MENU  buttons. Then press the MENU (M) button.

2 Press the MENU and MENU (M) buttons to highlight and select English, Spanish (ESPAÑOL), or French (FRANCAIS) on the display control.

Text for the on-screen Menu will change to the selected language.

3 Press the STATUS button to clear the screen.



SMART HELP



Remember, the Language control only makes the TV's on-screen (MENU) items appear in English, Spanish, or French text. It does not change the other on-screen text features such as Closed Captioned (CC) TV shows.

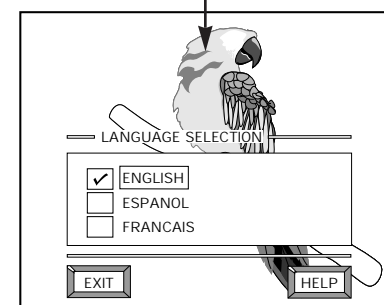
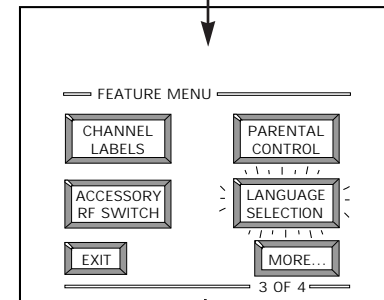
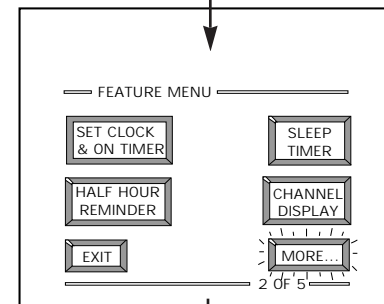
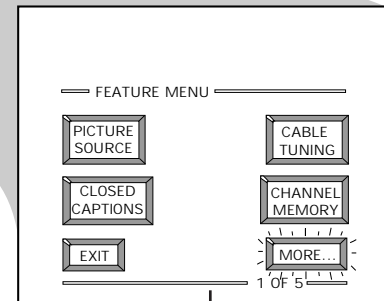
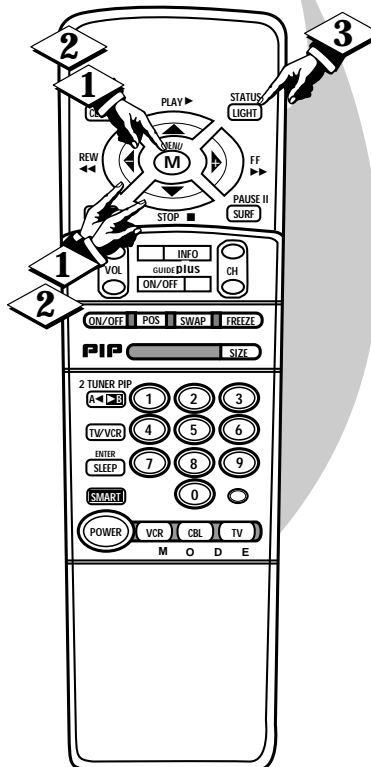
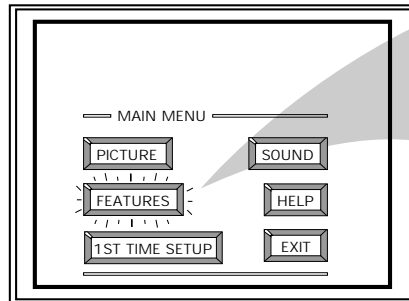

SOUND MENU CONTROL ADJUSTMENTS

BASS, TREBLE, BALANCE

Your TV also has individual sound adjustment controls. The **BASS** (low frequency), **TREBLE** (high frequency), and **Speaker BALANCE** may all be used to adjust the sound playback of TV programs.

(BEGIN)

- 1 Select **BASS**, or **TREBLE**, or **BALANCE** sound control.

With the **SOUND MENU** on the screen, move the **RED** highlight with the **MENU (M)** buttons. Then press the **MENU** button.

- 2 Press the **(+)** or **(-)** buttons to adjust the sound control to levels you prefer.

- 3 Press the **STATUS** button to clear the screen.

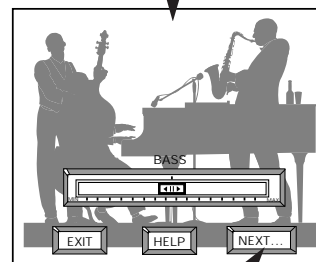
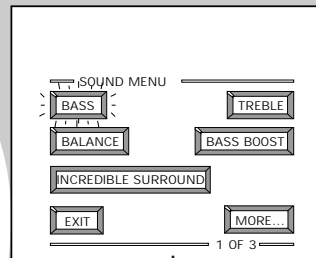
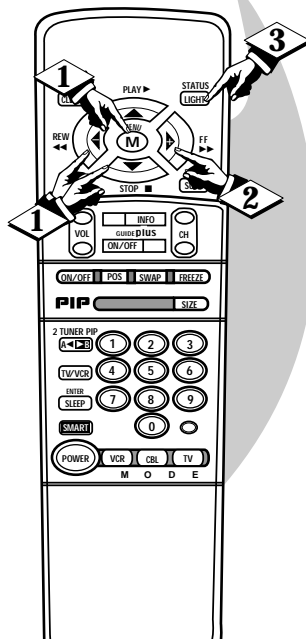
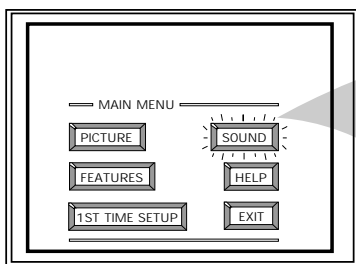

Select and then press **MENU (M)** button to view additional controls grouped under same feature heading. For Example: Treble, Balance, Bass Boost, Stereo, etc.

BASS BOOST

The **BASS BOOST** control increases the low frequency audio range of the TV. This creates a deeper, fuller playback sound which can be heard through the TV's speakers.

(BEGIN)

- 1 Select **BASS BOOST** sound control.

With the **SOUND MENU** on the screen, move the **RED** highlight with the **MENU (M)** buttons. Then press the **MENU** button.

- 2 Press the **MENU ▲▼** and **MENU (M)** buttons to highlight and turn **ON** (✓) the **BASS BOOST** control.

- 3 Press the **STATUS** button to clear the screen.

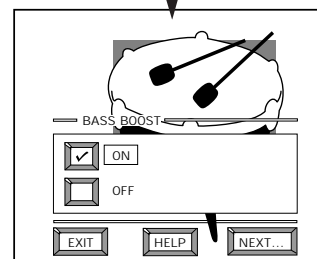
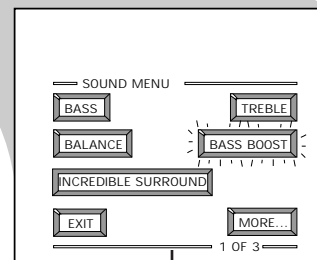
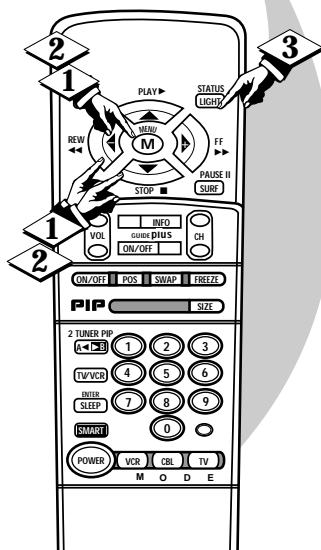
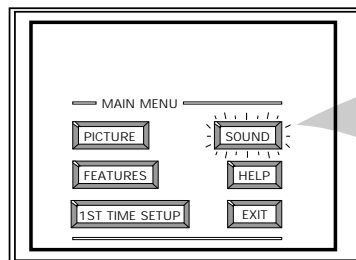

STEREO

Your TV is able to receive broadcast stereo TV programs. The TV is equipped with an amplifier and twin speaker system through which the stereo sound can be heard.

A RED stereo light (on the front of the TV) will come on when a stereo broadcast is received.

BEGIN

1 Select STEREO sound control.

With the SOUND MENU on the screen, move the RED highlight with the MENU (M)  buttons. Then press the MENU button.

2 Press the MENU and MENU (M) buttons to highlight and turn ON (✓) the STEREO mode.

3 Press the STATUS button to clear the screen.

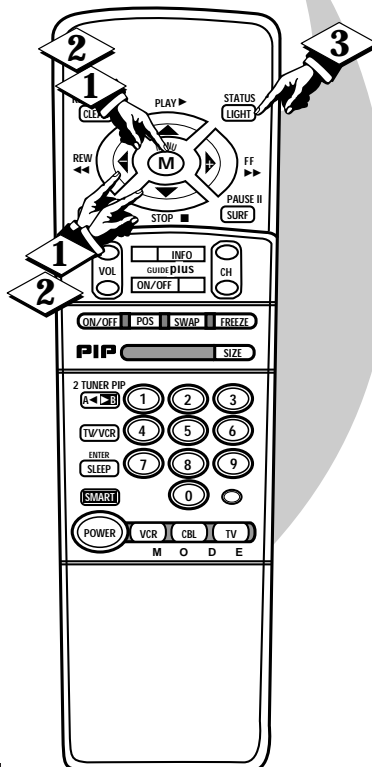
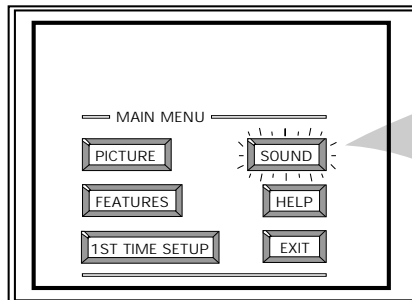

SMART HELP



Remember. If a stereo signal is not available and the TV is placed in the STEREO mode, sound coming from the TV will remain monaural (mono).

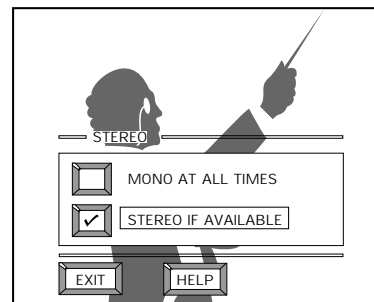
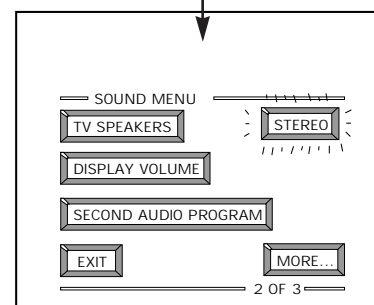
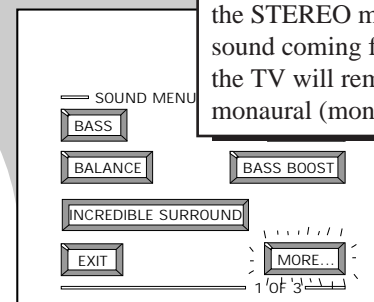

SECOND AUDIO PROGRAM

Second Audio Program (SAP) is part of the stereo broadcast system. Sent as an additional audio channel SAP can be heard apart from the current TV program sound. TV stations are free to use SAP for any number of purposes, but many experts believe it will be used for foreign language translations of TV shows (or for weather and news bulletins.)

NOTE: If a SAP signal is not present with a selected program, the SAP option can not be selected. "This program does not contain SAP information" will show on the TV screen.

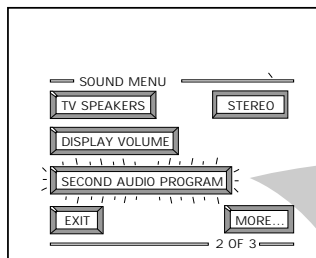

SECOND PROGRAM SOUND CAN ONLY BE SELECTED (✓) WHEN SAP INFORMATION IS PRESENT ON CURRENT CHANNEL.

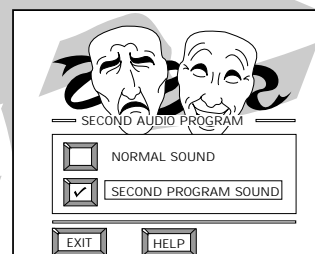

news and today's

news and today's

INCREDIBLE SURROUND

The Incredible Surround control can be used to add greater depth and dimension to both monaural (MONO) and STEREO TV sound.

BEGIN

- 1 Select the Incredible Surround control.

With the SOUND MENU on the screen, move the RED highlight with the MENU (M) buttons. Then press the MENU button.

- 2 Press the MENU and MENU (M) buttons to highlight and turn ON the INCREDIBLE SURROUND mode.

- 3 Press the STATUS button to clear the screen.

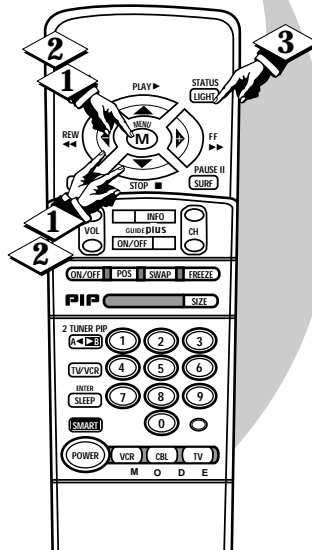
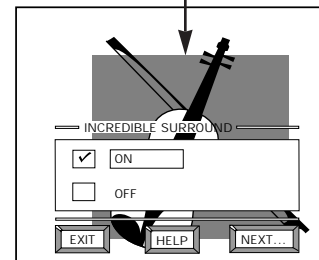
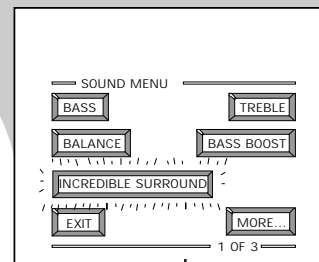
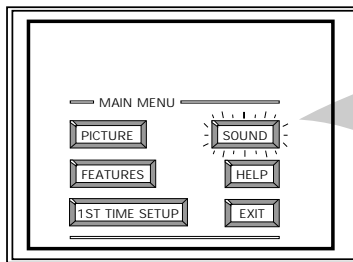

DISPLAY VOLUME

Use the DISPLAY VOLUME control to see the TV's volume level settings on the TV screen. Once set the Volume Display will be seen each time the VOLUME buttons (on the TV or remote) are pressed.

BEGIN

- 1 Select DISPLAY VOLUME control.

With SOUND MENU (2 of 3) on screen, move the RED highlight with the MENU (M) buttons. Then press the MENU button.

- 2 Press the MENU and MENU (M) buttons to highlight and turn ON the DISPLAY VOLUME control.

- 3 Press the STATUS button to clear the screen.

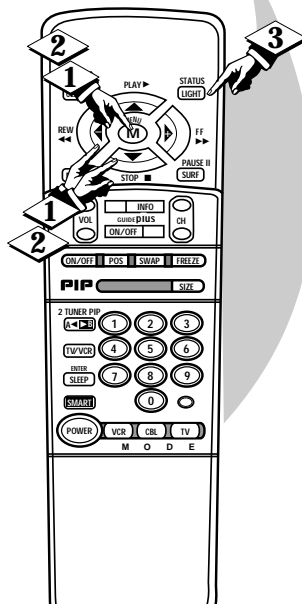
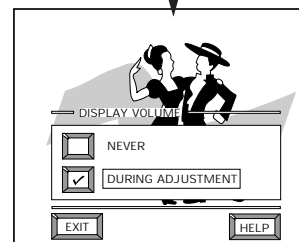
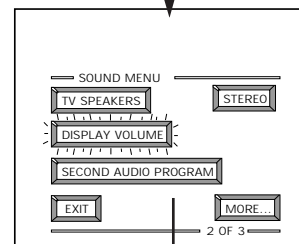
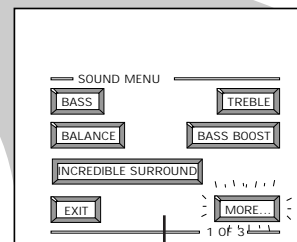
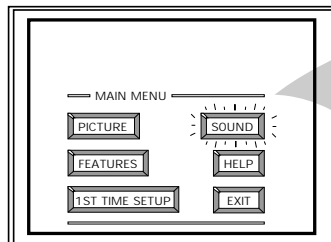

SMART HELP



Remember, "DURING ADJUSTMENT" means the volume level will be on screen whenever the Volume buttons are pressed.

TV SPEAKERS

Would you like to hear TV programs through your audio hi-fi system? The TV's Variable Audio Output jacks and TV Speaker On/Off control work together to offer you this TV sound option.

BEGIN

- 1 Connect the R(ight) and L(eft) VARIABLE AUDIO OUT jacks on the TV to the R and L Audio Input jacks on your amplifier or sound system.

Set the audio system's volume to normal listening level.

- 2 Turn the TV and audio system ON. You can now adjust the sound level coming from the audio system with the Volume ▲▼ buttons on the TV or remote.

- 3 To hear the TV sound from only the audio system speakers, select TV SPEAKERS control.

With SOUND MENU (2 of 3) on screen, move the RED highlight with the MENU (M) buttons. Then press the MENU button.

- 4 Press the MENU ▲▼ and MENU (M) buttons to highlight and turn OFF (✓) the TV SPEAKERS control.

You should now only hear TV sound coming from the audio system speakers.

- 5 Press the STATUS button to clear the screen.



SMART HELP



Remember, the audio system may have to be in AUX(iliary) mode to play sound from the TV (Outputs).

Note: When the TV SPEAKER control is set to "NORMAL" (for TV speaker operation) make sure the VARIABLE AUDIO OUTPUT control (see next page) is also set to "STEREO" in order for the TV's AUDIO OUTPUT jacks to work properly.

NOTE: The TV's PIP AUDIO OUTPUT jacks can also be used for additional stereo playback options such as wireless transmitter headphone hook-up, or as an external amplifier connection source. However, with normal PIP feature operations (when the ANT A and ANT B Input sources are connected for use), the PIP AUDIO OUTPUTS will switch from stereo to monaural (mono) sound. Stereo sound will only be available with the TV's Main screen (or ANT A supplied signal) at that time.

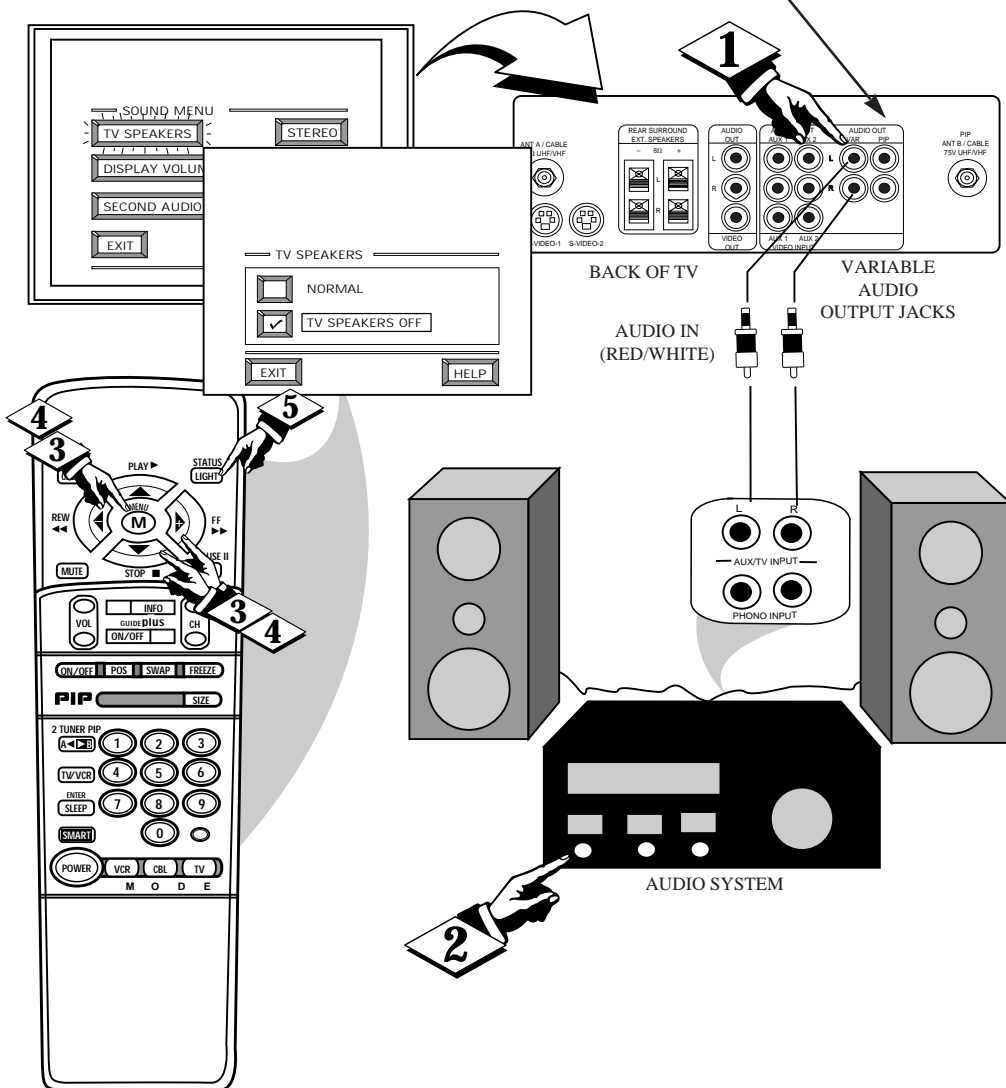

SURROUND SOUND

By adding optional external speakers to the TV's sound system, you can create the feeling of reflected sound that surrounds you at a movie theater or concert hall.

BEGIN

- 1 Connect both external speakers to the speaker wire terminals on the TV.

Recommended speakers: 8ohm, 15 watt minimum. Be sure the (+) and (-) speaker wires are connected to the correct R(ight) and L(ef) speaker terminals on the TV.

- 2 Place the speakers so the viewing area is between the TV and the rear surround speakers. (See overhead view drawing.)

- 3 Turn TV ON and place the STEREO control to the "STEREO IF AVAILABLE" (✓) position.

After setup whenever a stereo signal is received the audio will be heard in Surround Sound.

STOP

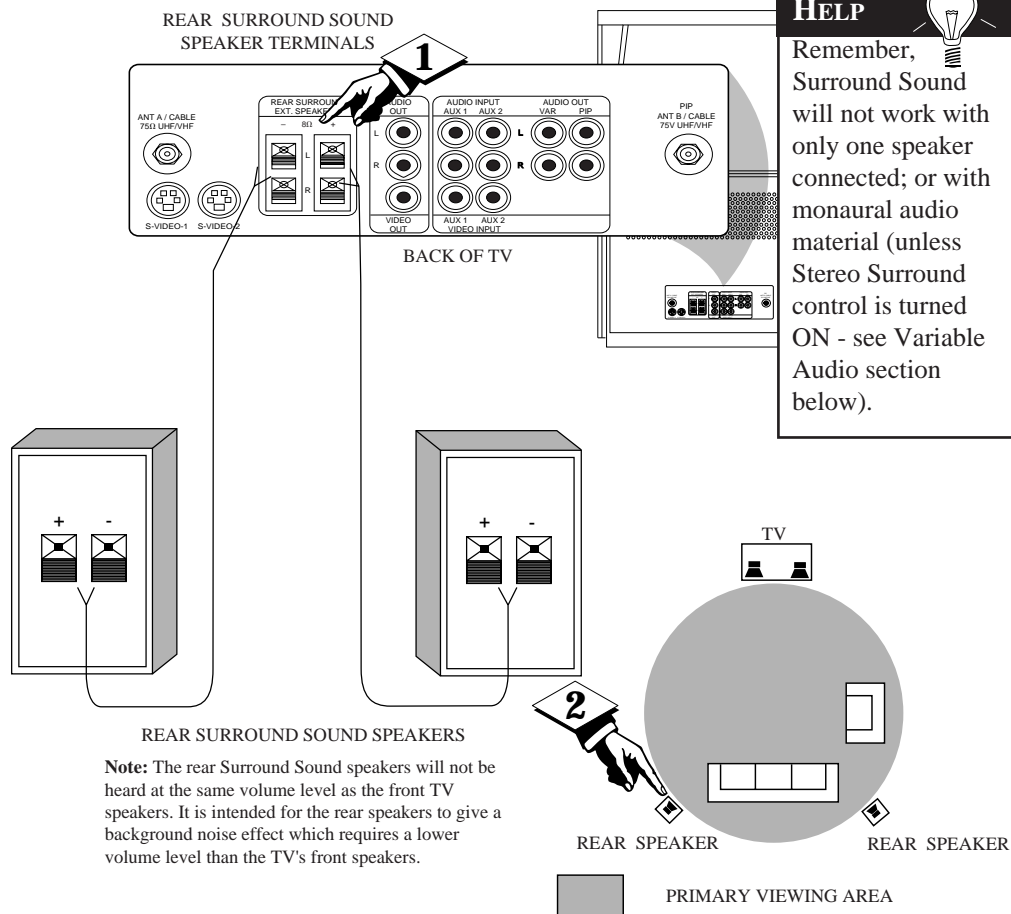

SMART HELP



Remember, Surround Sound will not work with only one speaker connected; or with monaural audio material (unless Stereo Surround control is turned ON - see Variable Audio section below).

VARIABLE AUDIO OUTPUT

The TV's Variable Audio Output jacks can also be used for Surround Sound. Once they are connected to an external hi-fi system its speakers can be used for the playback of Surround Sound.

BEGIN

- 1 Connect the R(ight) and L(ef) VARIABLE AUDIO OUT jacks on the TV to the R and L Audio Input jacks on your amplifier or sound system.

- 2 Turn TV ON and place the VARIABLE AUDIO OUTPUT on screen control to the SURROUND (✓) position. (Sound Menu 3 of 3).

Note: The Left/Right channel audio line level signal at the Audio Output jacks will be the same information heard as on the TV's side panel speakers.

STOP

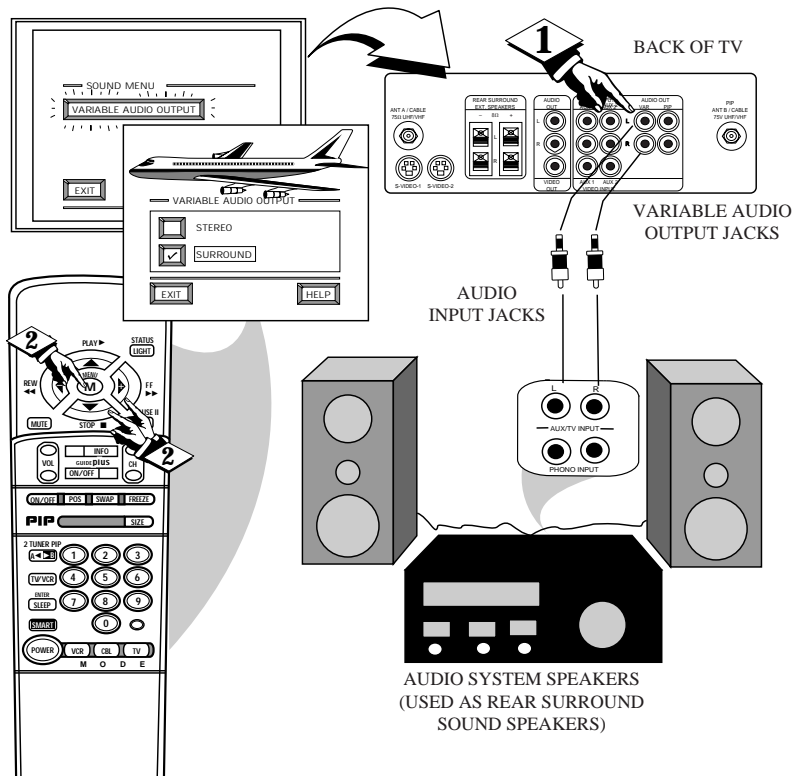



Extra speaker connections have been supplied on the rear of the TV. These extra connections are especially important for some of the optional Amplifier and multi-speaker arrangements that are possible with Dolby Pro Logic Surround Sound audio features.

For example: With the Surround mode six speakers are needed to complete the setup for proper DOLBY SURROUND sound playback-

- 2 Front Left/Right Speakers
- 1 Center Channel Speaker
- 2 Rear Surround Speakers

The Front Left/Right, Center, and Rear Surround Speakers have their signals supplied by the connections located on the back of the Dolby ProLogic Audio Receiver.

Note: A CENTER CHANNEL AMP(plifier) INPUT is also located on the TV. This input can be used to connect the external Audio Receiver's Center Channel Output in order to play Center Channel sound through the internal TV speakers.

When an Audio Receiver is used as the audio source for the CENTER CHANNEL AMP INPUT:

- Place the TV's AMP SWITCH to the EXTERNAL position

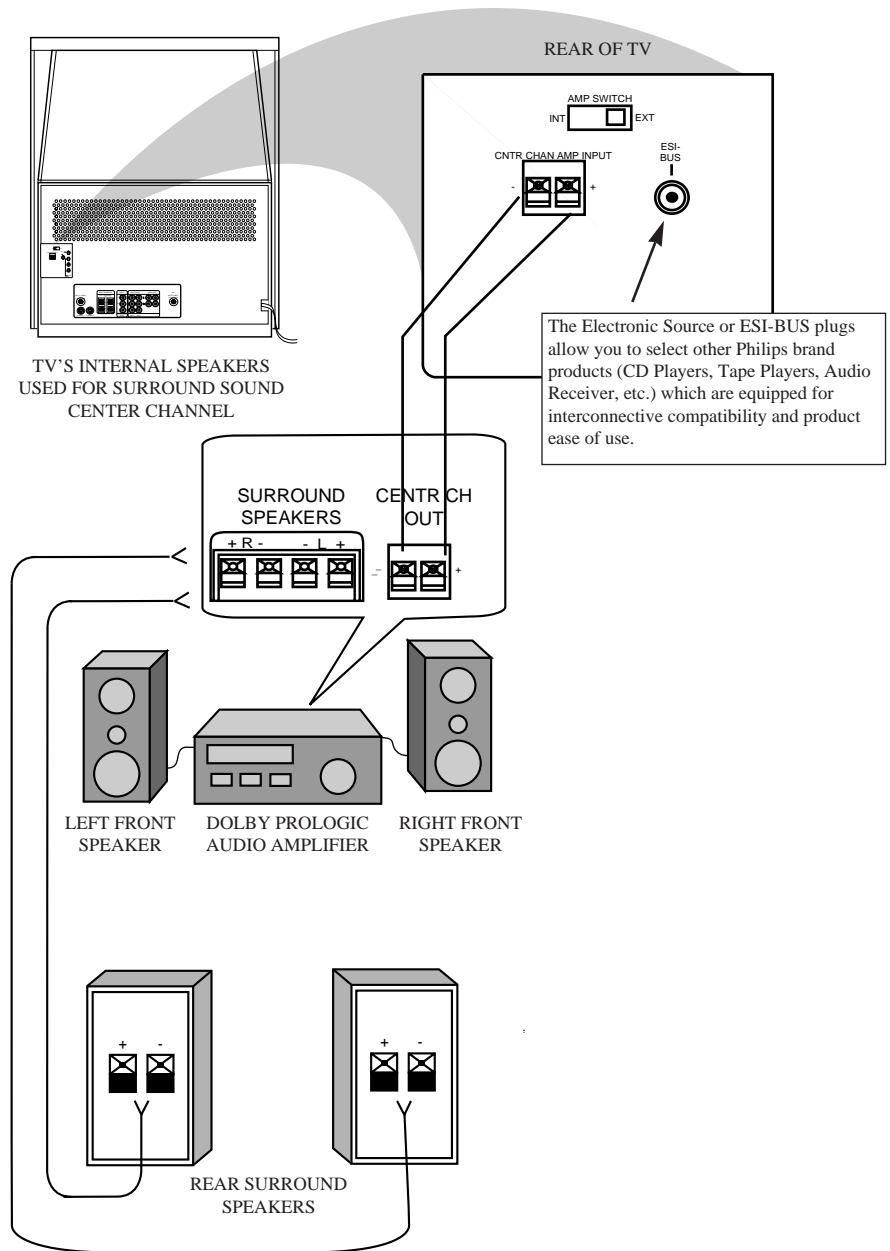

USING THE AUDIO/VIDEO INPUT JACKS

VCR/AUX INPUTS

The TV's Audio/Video Input jacks are for direct picture and sound connections between the TV and a VCR (or Video Disc Player, etc.) that has Audio/Video Output jacks.

To view the playback of a VCR tape by using the Audio/Video Input jacks on the TV:

BEGIN

- 1 Connect the VIDEO OUT jack from the VCR to the AUX 1 VIDEO IN jack on the TV.
- 2 Connect the AUDIO OUT jacks R(ight) and L(eft) from the VCR to the AUX 1 AUDIO IN jacks on the TV.
- 3 Select the "VCR/AUX 1" PICTURE SOURCE SELECT control on the TV.
With the FEATURES MENU on screen, move the RED highlight with the MENU (M) buttons. Then press the MENU button.
- 4 Press the MENU ▲▼ and MENU (M) buttons to highlight and select (↵) the AUX 1 mode.
- 5 Turn the VCR ON and press PLAY to view the tape on the TV.



SMART HELP

Remember, after it is connected an easy way to select the AUX 1 mode is to press the VCR button on the front of the TV (or the TV/VCR button on the remote.) Channels 3/4, ANT A/B, AUX 2/3, and the last channel viewed can also be selected in this way.

If you have added AUX 1 to the TV's channel memory (see page 14), just press the CHANNEL ▲▼ buttons to select the AUX 1 mode.

PICTURE AND SOUND FROM
PLAYBACK OF VCR TAPE

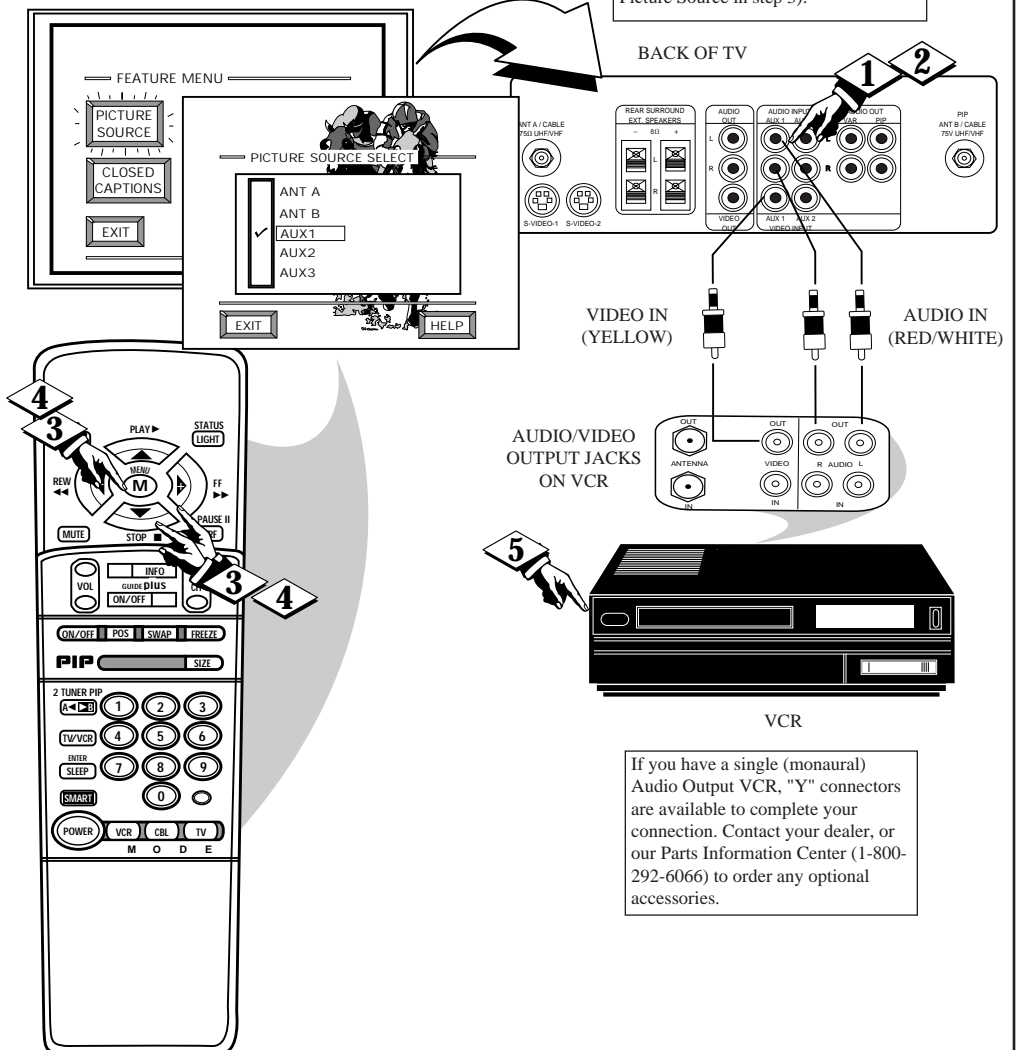

If you have a single (monaural) Audio Output VCR, "Y" connectors are available to complete your connection. Contact your dealer, or our Parts Information Center (1-800-292-6066) to order any optional accessories.

AUX 3 INPUTS

For more convenient Direct playback connections the TV's Front Audio/Video Input panel can be used. Located next to the TV's front control panel (under a small cover door) these Input jacks allow for quick and easy connections, particularly for the playback of Camcorder tape recordings.

To view the playback of a Camcorder recording using the Audio/Video Input jacks on the front of the TV:

BEGIN

- 1 Connect the VIDEO OUT jack from the Camcorder to the Front VIDEO IN jack on the TV.
- 2 Connect the AUDIO OUT jacks R(ight) and L(eft) from the Camcorder to the Front AUDIO IN jacks on the TV.
- 3 Select the "AUX 3" PICTURE SOURCE SELECT control on the TV. With the FEATURES MENU on screen, move the RED highlight with the MENU (M) buttons. Then press the MENU button.
- 4 Press the MENU ▲▼ and MENU (M) buttons to highlight and select (✓) the AUX 3 mode.
- 5 Turn the Camcorder ON and press PLAY to view the tape on the TV.

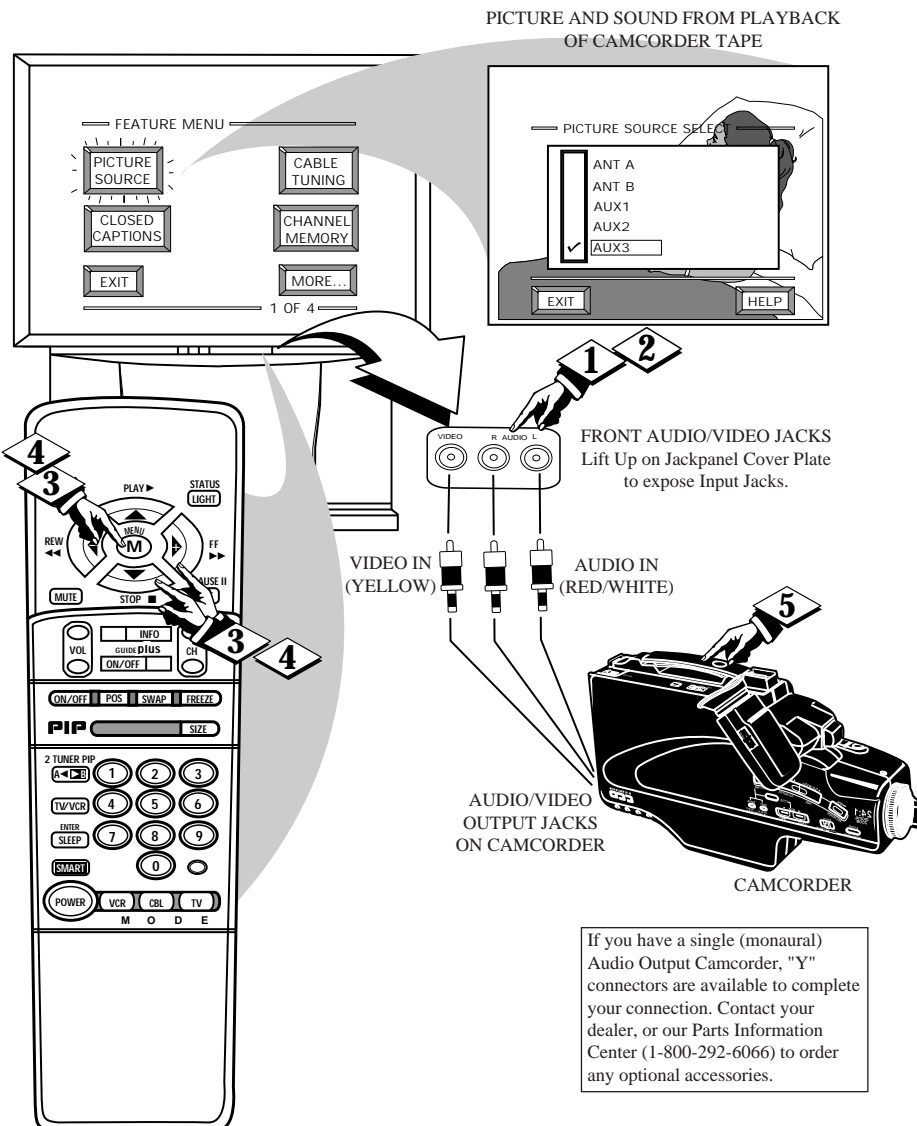

SMART HELP

Remember, after it is connected an easy way to select the AUX 3 mode is to press the VCR button on the front of the TV (or the TV/VCR button on the remote). Channels 3/4, ANT A/B, AUX 2/3, and the last channel viewed can also be selected in this way.

If you have added AUX 3 to the TV's channel memory (see page 14), just press the CHANNEL ▲▼ buttons to select the VCR/AUX mode.

AUX1 - S-VIDEO INPUTS

The S(uper)-Video connection on the rear of the TV can give you better picture detail and clarity, for the playback of S-VHS VCR tapes or Video Discs, than the normal antenna picture connections.

Note: The VCR (or Video Disc Player) must have a S-VIDEO OUT(put) jack in order for you to complete the connections shown on this page.

BEGIN

- 1 Connect the S-VIDEO (S-VHS) OUT jack from the VCR to the S-VIDEO 1 jack on the TV.

The S-VIDEO connecting cable will be supplied with the S-VHS VCR (or Video Disc Player).

- 2 Connect the AUDIO OUT jacks R(right) and L(left) from the VCR to the AUDIO AUX IN 1 jacks on the TV.

- 3 Select the "S-VIDEO" PICTURE SOURCE control.

With the FEATURES MENU on screen, move the RED highlight with the MENU (M) buttons. Then press the MENU button.

The "S VIDEO" picture source option appears only when a S-VIDEO cable has been connected to the TV.

- 4 Turn the VCR ON and place it in the S-VIDEO (or S-VHS) playback mode. Insert S-VHS cassette tape and playback in a normal manner.



SMART HELP

Remember, after it is connected an easy way to select the S-VIDEO mode is to press the VCR button on the front of the TV (or the TV/VCR button on the remote.)

If you have added AUX 1 to the TV's channel memory, just press the CHANNEL ▲▼ buttons to select the S-VIDEO mode.

PICTURE AND SOUND FROM PLAYBACK OF S-VHS VCR TAPE PLAYBACK

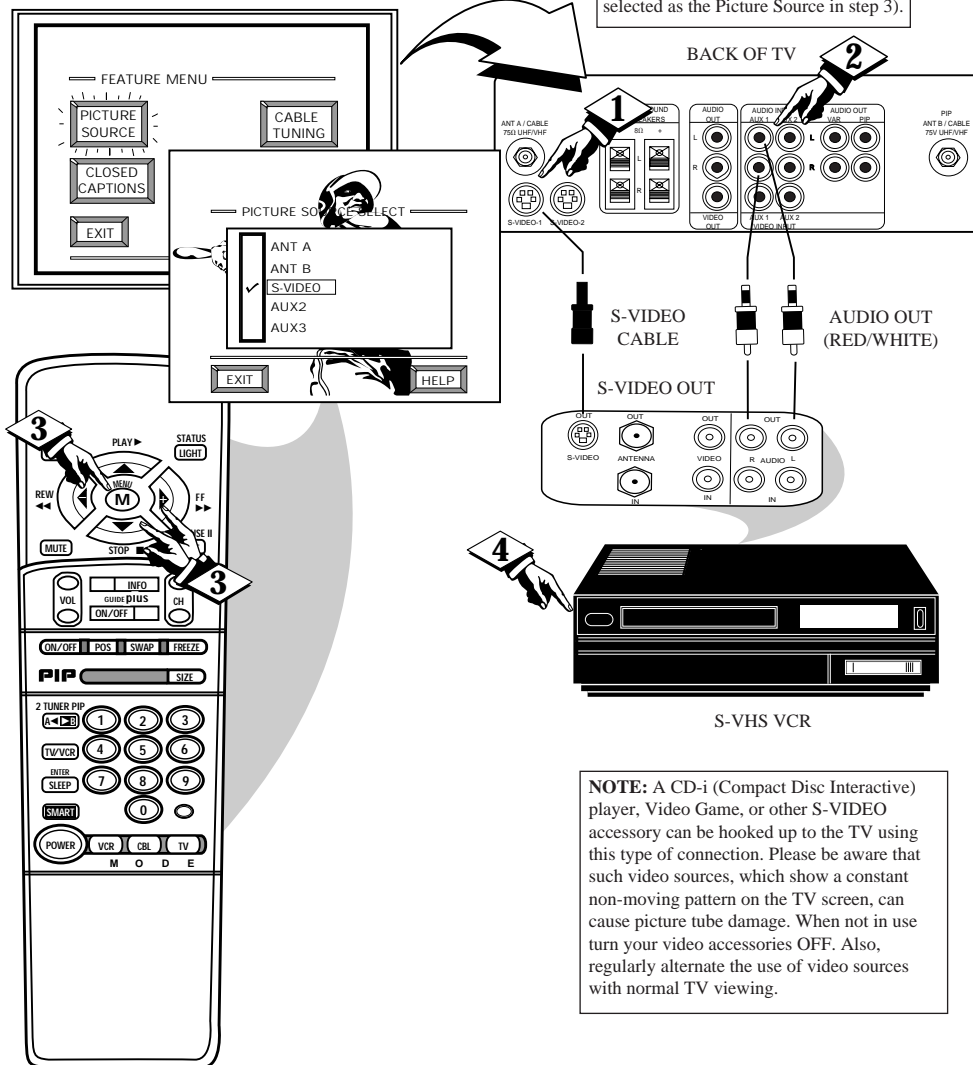

AUDIO/VIDEO OUTPUTS

The Audio/Video Output jacks on the TV can be used to record TV programs on VCRs which have Audio/Video Input jacks.

To record TV programs by using the Audio/Video jacks on the TV:

BEGIN

1 Connect the VIDEO OUT jack from the TV to the VIDEO IN jack on the VCR.

2 Connect the AUDIO OUT jacks R(ight) and L(ef) from the TV to the AUDIO IN jacks on the VCR.

3 Select the "ANTENNA" PICTURE SOURCE control on the TV.

With the FEATURES MENU on screen, move the RED highlight with the MENU (M) buttons. Then press the MENU button.

Select the channel on the TV that you want to record.

4 Turn the VCR ON. Put a cassette tape in the unit and place the VCR in the RECORD mode.



SMART HELP

Remember, If the VCR has an INPUT SELECTOR switch, place it in the LINE or CAMERA position.

Unattended Timer Recordings with a VCR are possible, but not recommended with this connection since the TV must be left ON for the VCR to record.

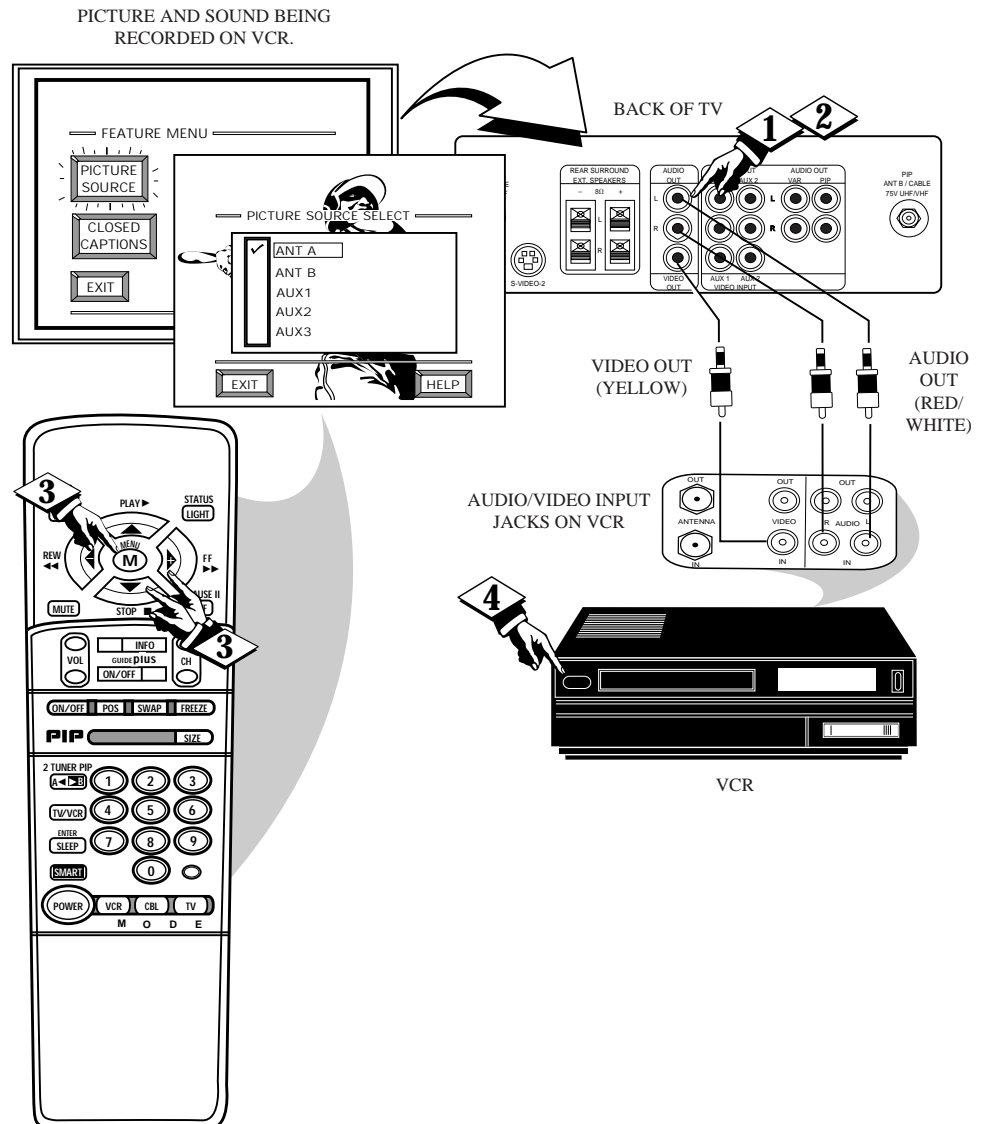

Have you ever played hide and seek with your remote control? Are you tired of tearing the house apart trying to find if someone has stuffed the remote under the couch, put it on the shelves, or hid it in the desk? Well, your TV remote can save you all that looking by automatically signaling its location to you.

Here's how it works:

BEGIN

- 1 Press the POWER button** on the set to turn the TV ON.

Note: Normally you can press any button on the front of the TV to turn the set ON. But for the remote locator to work you need to be sure to use the Power button at the TV.

A "locating remote" message shows on the TV screen.

- 2 Within a few seconds a chirping or beeping sound** will begin to come from the remote control hand unit.

The remote will continue to signal its location for around 30 seconds. Normal TV program sound will not be heard while the remote locator is working.

- 3 Once you find the remote** just press any button on the remote and the beeping sound will stop.

The remote is now ready for normal TV feature use.



SMART HELP



Remember, the remote locator may not properly receive its "homing" signal from the TV if it has been placed on a metal shelf or counter material.

Also, since there's a special type of radio frequency "homing" signal receiver inside the remote we are required to notify you that any changes or modifications not expressly approved by Philips Consumer Electronics Company could void the user's authority to operate the remote equipment.

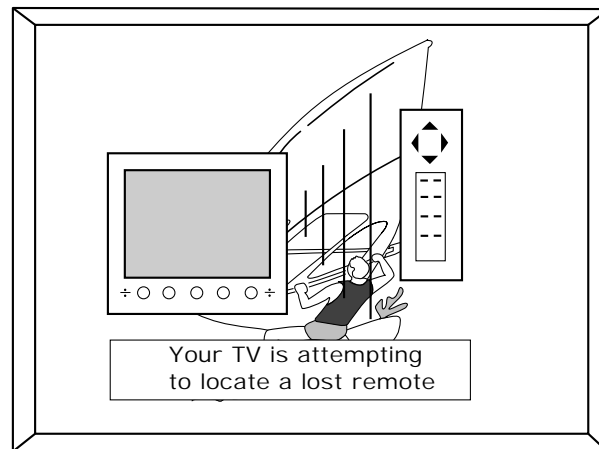

Remote Locator "homing" range is around 30 Feet.

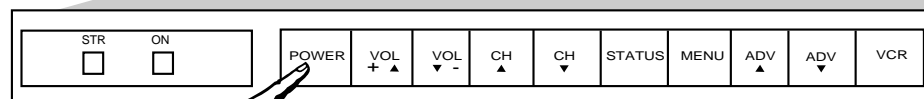

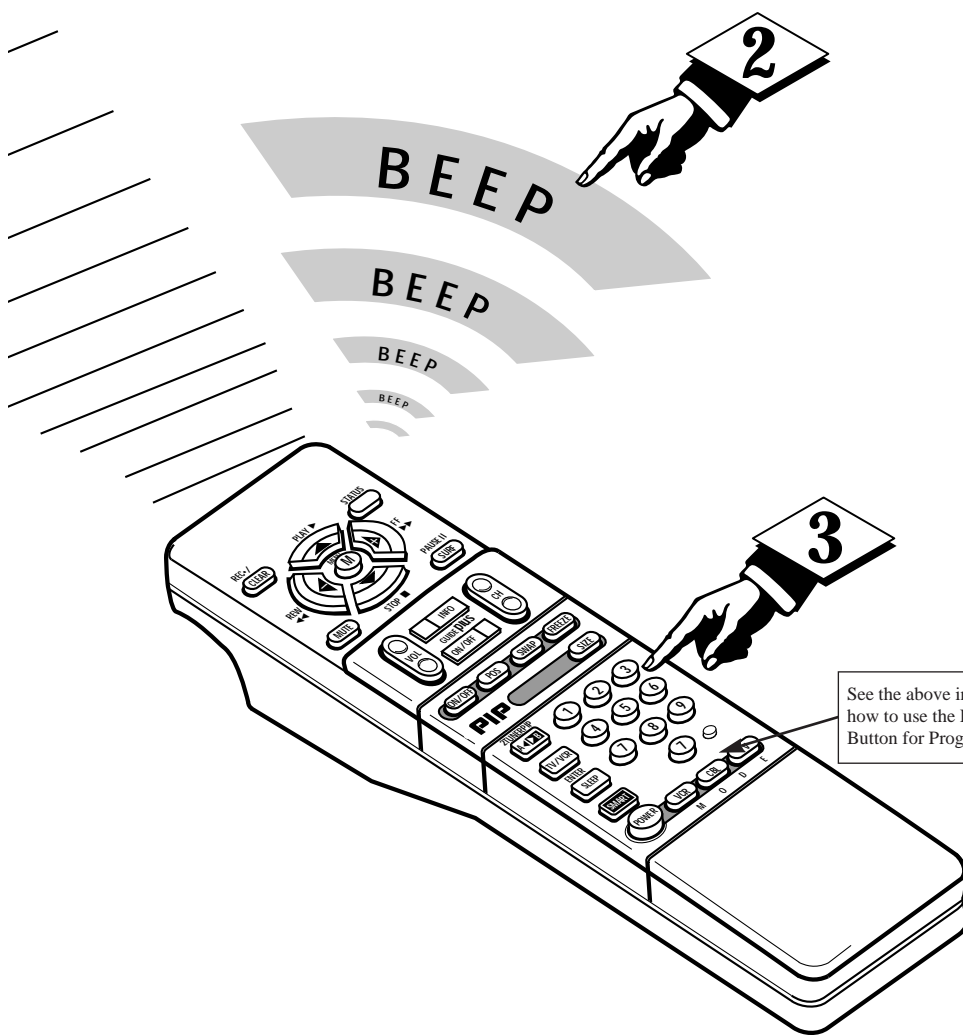

ADDRESS CODE PROGRAMMING OF REMOTE

For most homes this step would not be needed but for your information:

Up to 9 different remote locator address codes can be set on which the TV can send out its "homing" signal.

*This is done in case there is more than one TV (with a remote locator) present, and you want only one specific remote to be signaled when the TV is turned ON.**

To set a Locator Address Code:

BEGIN

- 1 With TV turned ON, press the **LOCATOR CODE** button on the remote. (Also be sure the TV SYSTEM button on the remote has been pressed.)

You will need a pencil or pen to press the recessed button.

The TV shows the present Remote Locator Code.

Remote Locator Code
is set to 1
Press Any Number
Button to Change Code

- 2 Press any number button (0-9) on the remote to set or change the Locator Code.

Remote Locator Code
Has Been Changed
New Code Is 2

The remote will beep to let you know it has received the new Locator Code and then return to its normal operating mode.

SMART HELP



Remember, if batteries are replaced the Locator Code will need to be reentered.

When setting the Locator Code if any button, other than the number buttons, are pressed the remote will return to its normal operation mode.

*For owners who live in an apartment (townhouse or condominium) complex, this task may be necessary since the remote locator's signal can be sent and detected directly through adjoining walls.

SMART PICTURE

Regardless of what type of program you are watching, your TV has automatic video control settings matched for your current program source or content. The Smart Picture feature quickly resets your TV's video controls for a number of different types of programs and viewing conditions you may have in your home.

BEGIN

- 1** Press the **SMART** button on the remote.
- 2** Press the **MENU (M)** button to select the Smart Picture feature (highlighted in RED).
- 3** Press the **MENU ▲ or ▼** buttons to choose any of the preset viewing categories (Example: Cartoons, Movies, etc.). Then press the Menu (M) button to select the highlighted control.
- 4** Press the **STATUS** button on the remote to clear the screen.



SMART HELP



Remember, with Smart Picture "Custom" mode selected you can set a number of video controls to your own preference. Use the remote's Smart button to reselect these personally adjusted Custom settings contained within the Smart Picture feature. (See the next page for more detailed instructions.)

The video control settings for the Smart Picture categories (except CUSTOM) are memorized into the TV at the factory and can only be reset by field and service technicians.



SMART PICTURE

To use the Smart Picture settings you placed in memory (see previous page):

BEGIN

- 1 Press the **SMART** button on the remote and then press the **MENU (M)** to select the SMART PICTURE control.

List of "SMART PICTURE" categories show on the TV screen.

- 2 Press the **MENU (M) ▲▼** buttons to highlight the "CUSTOM" Smart Picture category.

- 3 Press the **MENU (M)** button to select "CUSTOM."

- 4 Press the **MENU (M) ◀▶** buttons to move the RED highlight to the control you wish to adjust, then press the **MENU (M)**.

- 5 Press the **STATUS** button after you have finished your adjustments to clear the screen.



CHANGE LABEL

The "CHANGE LABEL" control can be used to change the title of a SMART PICTURE setting into a name or label that may be easier for you to remember.

BEGIN

- 1 With the "SMART PICTURE LABEL" control on the screen, **press the MENU ▲▼** buttons to spell out a new label or title for the selected SMART PICTURE.

- 2 Press the **MENU (M) ◀▶** buttons to move the red highlight to each letter space.

- 3 Press the **STATUS** button to clear the screen when the new label is finished.

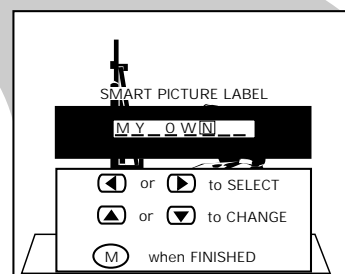
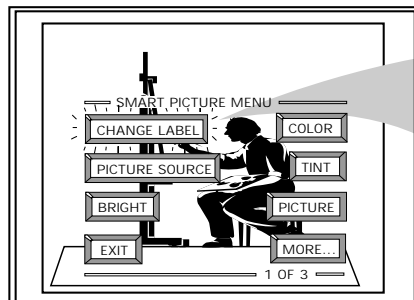





SMART SOUND

Are you tired of the sound of commercials following you into the next room or all through the house? Smart Sound allows you to preset a desired volume level that the TV sound will not go above. This makes for an even, more consistent sound by reducing the “peaks” and “valleys” that can occur during program changes or commercial breaks.

BEGIN

- 1** Press the **SMART** button on the remote.
- 2** With the **SMART Menu** on the screen, move the **RED** highlight with the **MENU**  buttons. Then press the **MENU (M)** button to select the highlighted Smart Sound control.
- 3** Press the **MENU**  or  and then the **MENU (M)** button to turn the Smart Sound control **ON** (or **OFF**).
- 4** Press the **STATUS** button to clear the screen when completed.



SMART HELP



Remember, Smart Sound works for sound levels coming from either the Antenna/Cable input on the rear of the TV (RF audio); or the Auxiliary (VCR/AUX IN) audio inputs.

2-CHANNEL SURF/SMART SURF

A "list" or series of previously viewed channels can be selected with the SURF button on your remote control. With this feature you can easily switch between different TV programs that currently interest you. The Smart Surf control allows you to set up to 10 channels in its quick viewing "list".

BEGIN

- 1 Press the **Smart** button on the remote.
- 2 With the **SMART Menu** on screen, move the **RED** highlight with the Menu (M) buttons. Press the **MENU** button to select the highlighted Smart Surf control.
- 3 Press the **Menu** or , then the Menu (M) button to select either Smart Surf or 2-Channel Surf. (See explanation of Surf options with the illustration on this page.)
- 4 Press **STATUS** button on the remote control to clear the screen.



HOW TO USE SMART SURF

BEGIN

- 1 With the **Smart Surf control ON** (see above), select a desired **channel** for viewing. You can use the number buttons on the remote (or the Channel buttons).
- 2 Press the **SURF** button on the remote. (Some channel numbers may already appear within the Surf channel list.)
- 3 Press the **Menu** button to "ADD" the selected channel to the Surf list. Select the next desired channel and repeat steps 2 and 3. Continue until all desired channels are on the Surf list.
- 4 Press the **SURF** button on the remote to quickly review current action on channels contained within the Surf list.

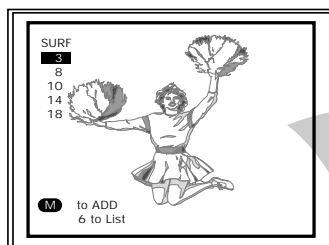

Note: To Delete a channel from the Surf list just press the SURF button to select the desired channel. Then press the Menu button and the channel will be immediately dropped from the on screen Surf list.

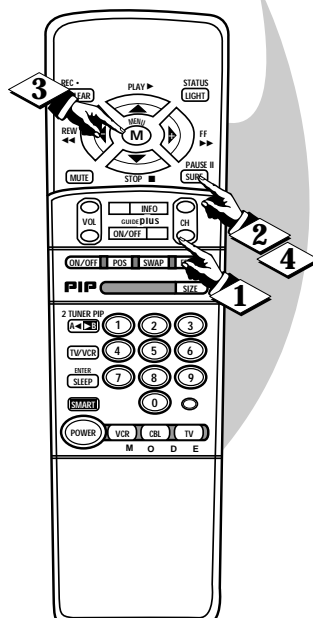
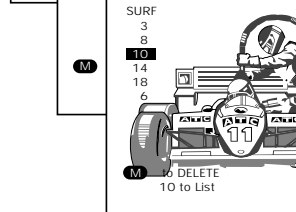
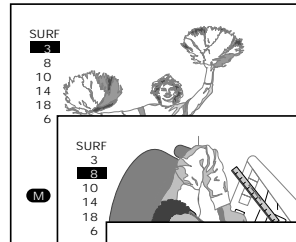
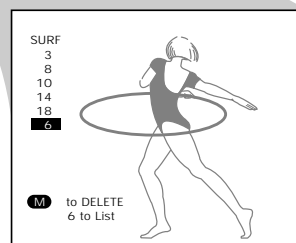

SMART HELP



To Use 2-Channel Surf:

With the **2-Channel Surf control ON**, select the **two desired channels** for viewing with the number buttons on the remote control.

Press the **SURF** button on the remote to "toggle" between the two selected channels.

2 CHANNEL SURF - Current and one previous channel in the ring.

SMART SURF - Current and up to nine additional channels available in the ring. Note: The Channel Surf ring can be used with fewer than ten channels. In this way, the number of Surf channels can match or fit your present viewing interests.

SETTING THE REMOTE TO WORK VCRs

Your remote control is set to work your TV and many infrared remote (IR) control VCRs. However, an easy one-time step may be necessary before the remote will work your VCR.

Try this initial check to see if going on to the following section is necessary.

BEGIN

- 1 Press the VCR System button on the remote.
- 2 Point remote toward VCR and press the POWER button.
- 3 Does the remote turn the VCR ON?
IF YES,  and try the other VCR buttons on the remote. If they also work the VCR, then the remote is ready and no further steps are needed.
If NO, continue...

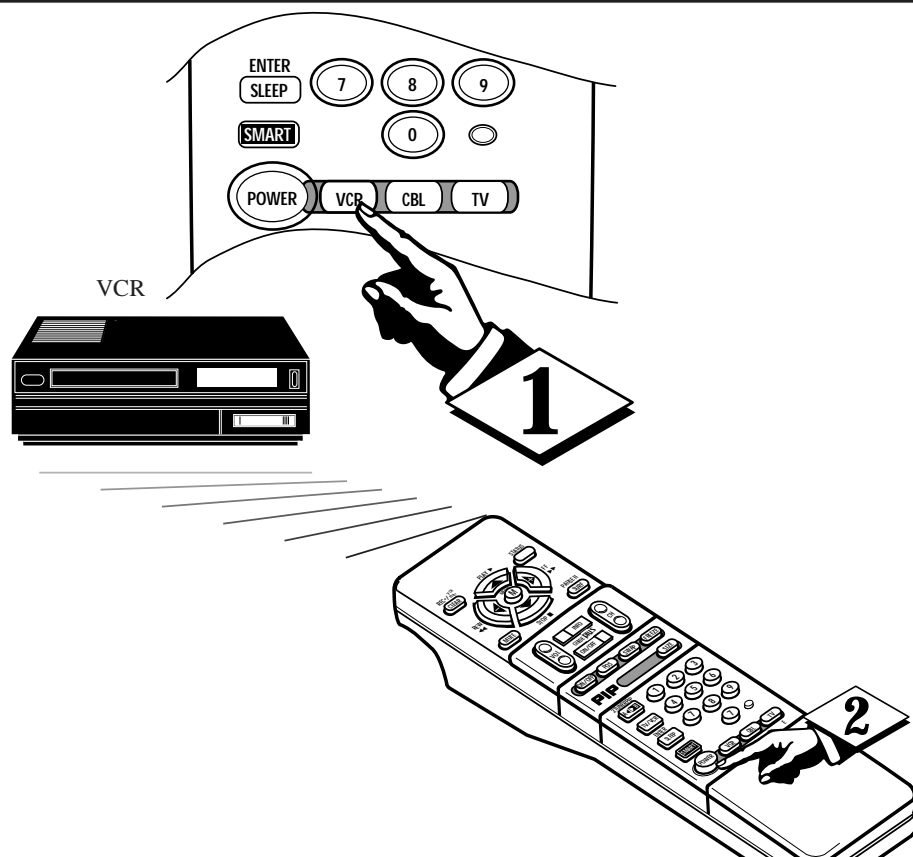

- 1 First look up a **TWO-DIGIT remote code number** for your brand VCR before going through the simple "1,2,3" steps (on the following page).

continue to next page

SMART HELP

 Remember, if more than one number is listed, you may have to try more than the first two-digit code given in order to locate your VCR's remote code.

VCR BRAND	REMOTE CODE NO.	VCR BRAND	REMOTE CODE NO.
Akai	24, 25, 36	Panasonic	01, 02, 52
Capehart	33	Philips	00, 05
Conoid	13	Philips Video CD	37
Curtis Mathes	42	RCA	04, 32, 42, 43, 44
Daewoo	33	Samsung	22, 30
Emerson	20, 31, 34, 40	Sansui	49
Fisher	06, 07	Sanyo	13
Goldstar	23	Sears	08
Go Video	45, 46	Sharp	11, 12
Hitachi	03, 51	Shintom	35
JVC	14, 47, 48	Sony	09, 10, 41
Magnavox	00, 05	Teknika	26
Matsushita	01, 02	Toshiba	18, 19
Mitsubishi	16, 17, 38, 39, 50	Video Concepts	29
Multitech	27, 28	Zenith	15
NEC	21		

SETTING THE REMOTE TO WORK VCRs (CONTINUED)



Now that you have looked up the two-digit Remote Code Number for your brand of VCR (on previous page), you are ready to follow the four simple steps below.

Please read through steps 1-4 before beginning.

BEGIN

- 1** Press and release the REC (RECORD) button.
- 2** Within **thirty seconds** after releasing the REC button, **press and release the VCR System** button.
- 3** Within **thirty seconds** after releasing the VCR System button, **ENTER THE TWO DIGIT CODE NUMBER** for the desired VCR. The remote is now ready to send commands to the VCR.
- 4** **Point the remote** at the VCR. Press the **POWER** button on the remote to turn the VCR ON.

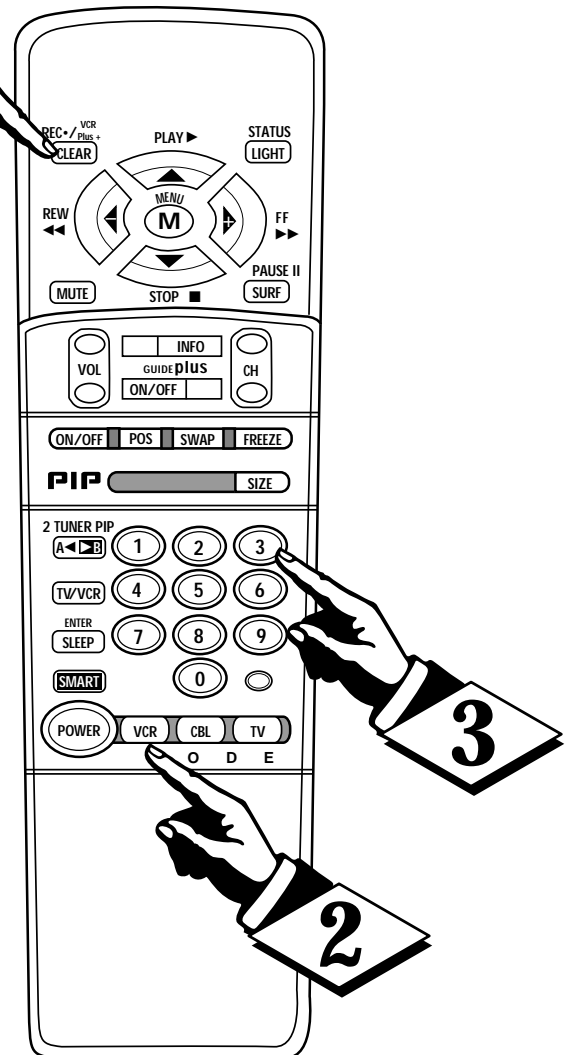
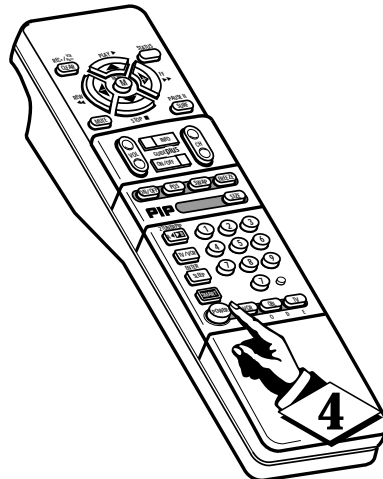
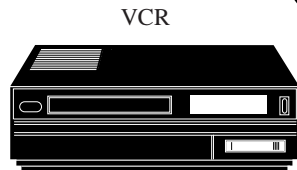

SMART HELP



Try it out. The Channel and VCR buttons on the remote should now operate the VCR.

Remember, if this doesn't work the first time, repeat steps using the same remote code number.

If after a second try the remote does not operate your VCR, and there are more code numbers listed for your brand VCR, use the next listed code number.

If after repeated attempts the code number method does not work your VCR, try the "VCR SEARCH" method on page 44.

SETTING THE REMOTE TO WORK CABLE TV CONVERTERS

Your remote control is set to work your TV and many infrared remote (IR) control Cable Converters. However, an easy one-time step may be necessary before the remote will work your Converter.

Try this initial check to see if going on to the following section is necessary.

BEGIN

- 1** Press the CBL System button on the remote.
- 2** Point remote toward Cable Converter and press the POWER button.
- 3** Does the remote turn the Converter ON?
IF YES,  and try the CH ▲▼ and CH number buttons on the remote. If they also work the Converter then the remote is ready and no further steps are needed.
IF NO, continue...

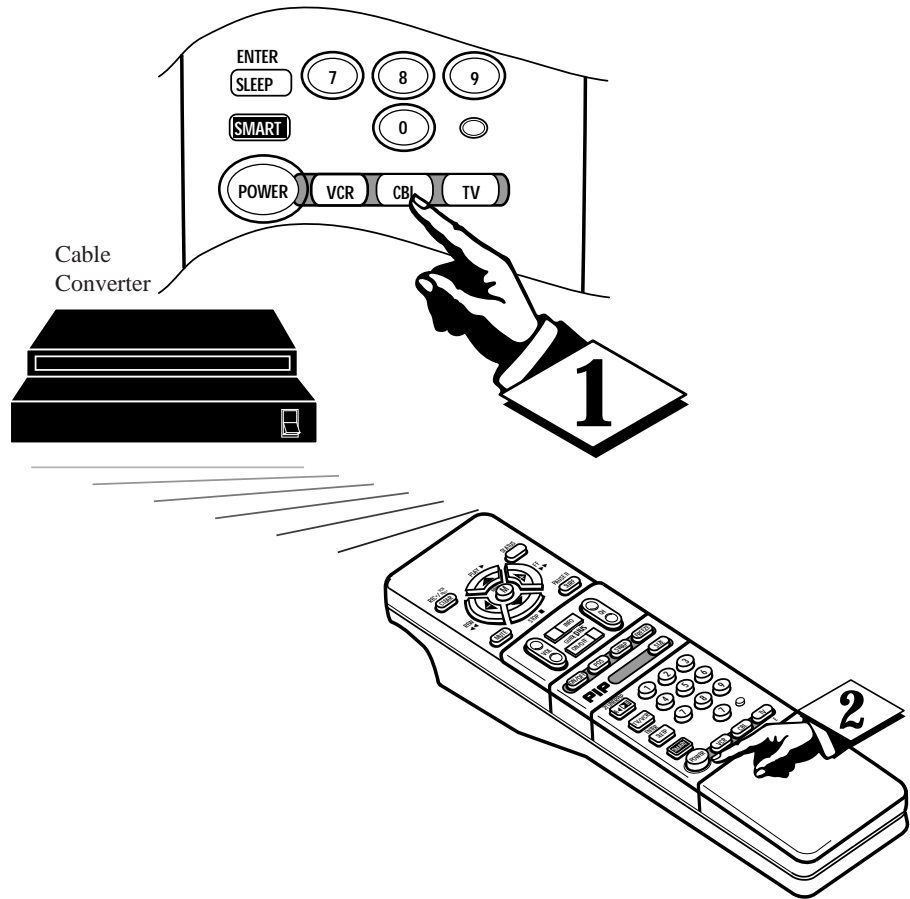

- 1** First look up a **TWO-DIGIT remote code number** for your brand Converter before going through the simple "1,2,3" steps (on the following page).

continue to next page

SMART HELP

 Remember, if more than one number is listed, you may have to try more than the first two-digit code given in order to locate your Converter's remote code.

<u>CONVERTER BRAND</u>	<u>REMOTE CODE NO.</u>	<u>CONVERTER BRAND</u>	<u>REMOTE CODE NO.</u>
Archer	28	Rembrandt	33
Diamond	23	Salora	52
Drake	37	Scientific Atlanta	08, 22, 47
Gemini	45	Sheritech	34
Hamlin	14, 15	Starcom	30
Hitachi	25	Sylvania	16
Jerrold	00,01,02,03,04,05,46,55	Texscan	48
Macom	29, 38	Tocom	12,13, 53
Magnavox	17, 31	Toshiba	43
NSC	49	Uniden Satellite	44
Oak	06, 27, 39	Unika	50
Panasonic	18, 35	United Satellite	54
Philips	19, 20, 21, 24, 26	Universal	36
Pioneer	09, 32	Video Tech	40
Regency	10, 11	Video Way	51
		Zenith	07, 41, 42



Now that you have looked up the two-digit Remote Code Number for your brand of Cable Converter (on previous page), you are ready to follow the four simple steps below.

Please read through steps 1-4 before beginning.

BEGIN

- 1** Press and release the REC (RECORD) button.
- 2** Within thirty seconds after releasing the REC button, press and release the CBL System button.
- 3** Within thirty seconds after releasing the CBL System button, ENTER THE TWO DIGIT CODE NUMBER for the desired Converter. The remote is now ready to send commands to the Converter.
- 4** Point the remote at the Converter. Press the POWER button on the remote to turn the Converter ON.

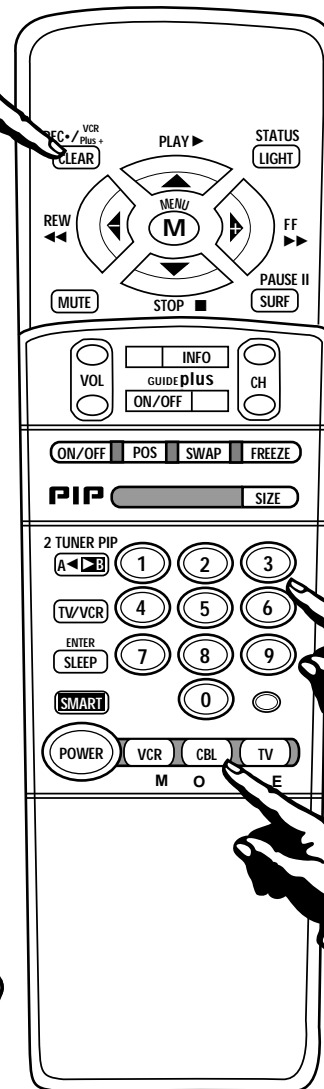
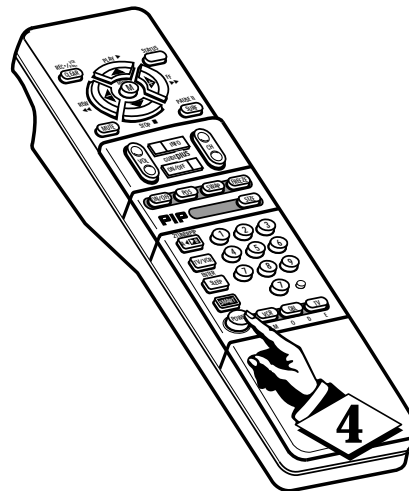
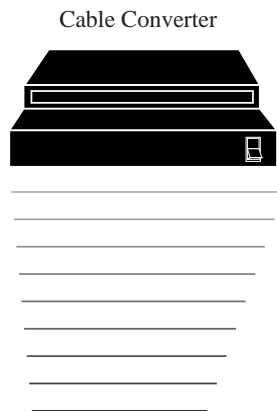

SMART HELP



Try it out. The Channel and POWER buttons on the remote should now operate the Converter.

Remember, if this doesn't work the first time, repeat steps using the same remote code number.

If after a second try the remote does not operate your Converter, and there are more code numbers listed for your brand Converter, use the next listed code number.

If after repeated attempts the code number method does not work your Converter, try the "CONVERTER SEARCH" method on page 44.



SETTING YOUR REMOTE TO WORK VCRs, CONVERTERS - SEARCH

Your TV remote can be set to work your VCR or Cable Converter by what is called the **SEARCH** method.

If the "REMOTE CODE" number method shown in the previous section did not set your remote to work your VCR or Converter, then follow the easy steps listed below.

Please read through steps 1-4 before beginning.

BEGIN

- 1** Press the **POWER** button on the VCR or Converter to turn the unit ON.
- 2** Stand at least six feet away from the front of the VCR or Converter. **Point the remote** toward the unit. **HOLD DOWN** the **SURF** and the desired **System (VCR or CBL-Converter)** buttons at the same time. **KEEP HOLDING** **BUTTONS DOWN**.
- 3** Watch the **Channel Indicator** on the unit. Channel Numbers will **SCAN UP** when the unit has been identified. This may take up to two minutes.
- 4** Release the **SURF** and **System (VCR or CBL)** buttons as soon as channel numbers start to scan up. The code has been identified and the remote is ready to operate with the VCR or Converter.



SMART HELP



Remember, a minute or two can seem very long, but the code should be located within two minutes.

Don't let the VCR or Converter scan up more than five channels. The remote may pass up the right code and another two minute search cycle will have to be repeated.

If no channel change happens within two minutes, repeat steps 1-4. Should a channel change still not occur, the remote will not work with the desired unit.

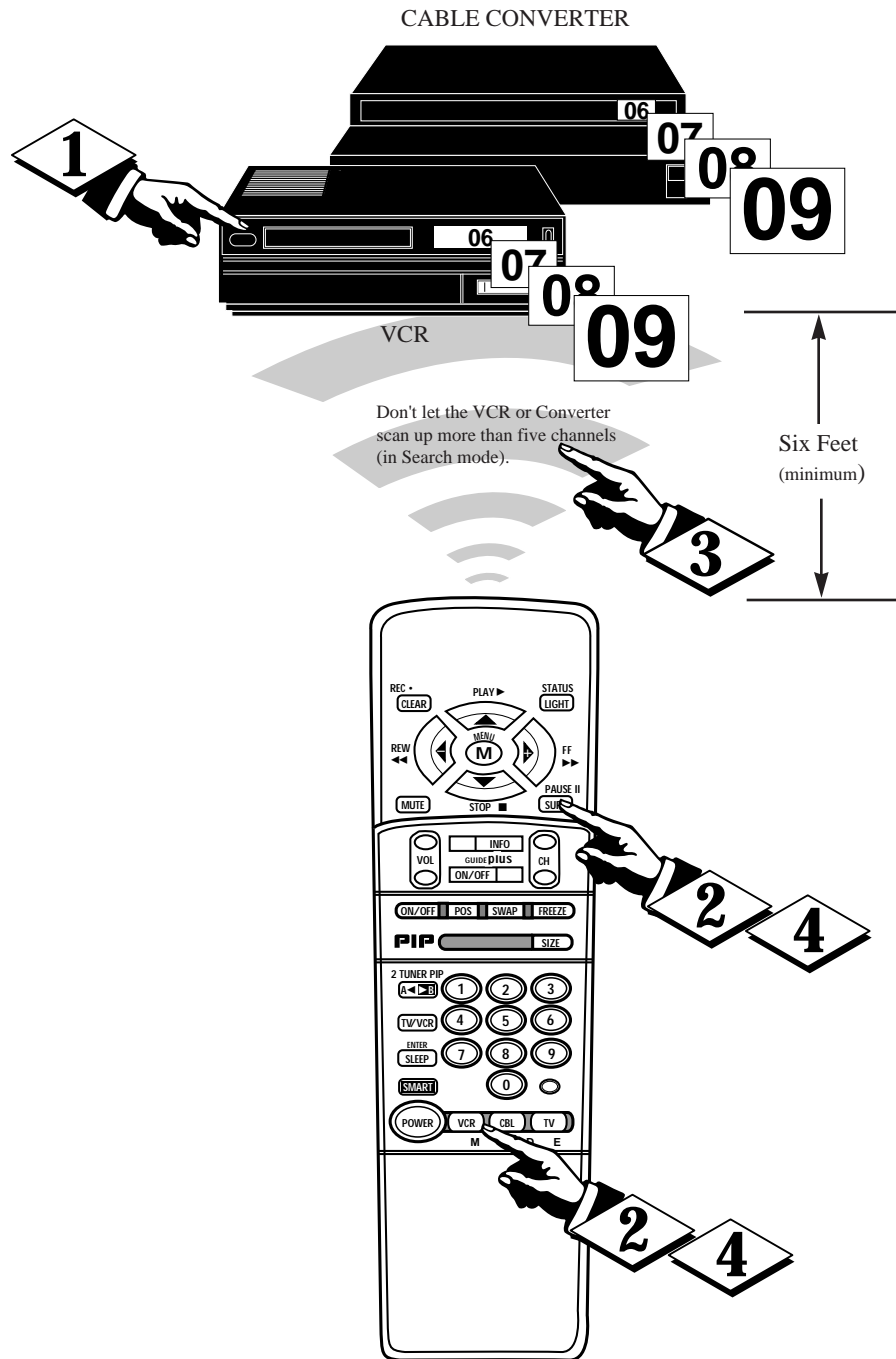



When using the TV remote with a VCR, first make certain it is set to control your VCR (by the REMOTE CODE or SEARCH method - see earlier section).

BEGIN

- 1 Press the VCR System button on the remote.
- 2 Point the top of the remote toward the front of the VCR (remote sensor window) when pressing buttons.



Record/Clear Button

Hold the RECORD button down, and then press the PLAY button to begin a VCR recording. Press to Clear or erase an incorrect VCR button entry (i.e. Timer Program). Also could be used to set a VCR Plus+ Timer Recording.

Rewind Button

Press to rewind tapes. For some VCRs you may need to press STOP button first then REWIND. In playback mode. hold button down to view picture moving rapidly in reverse.

Pause Button

Press to temporarily stop the tape during a playback, or recording. Press again to release Pause.

TV-VCR Button

Press to the VCR position ("VCR" indicator on the VCR will light) to view the playback of a tape. Press again to place in the TV position ("VCR" indicator on the VCR will go OFF) to view one program while recording another program. When used with the TV the TV/VCR button works as a source button. Each press cycles the TV between channels 3/4; the last view channel; ANT A/B inputs, and any AUX(iliary) Input mode (if it has been connected.) It is a quick one-button way to select these channels and modes (without directly entering the TV's Menu system.)

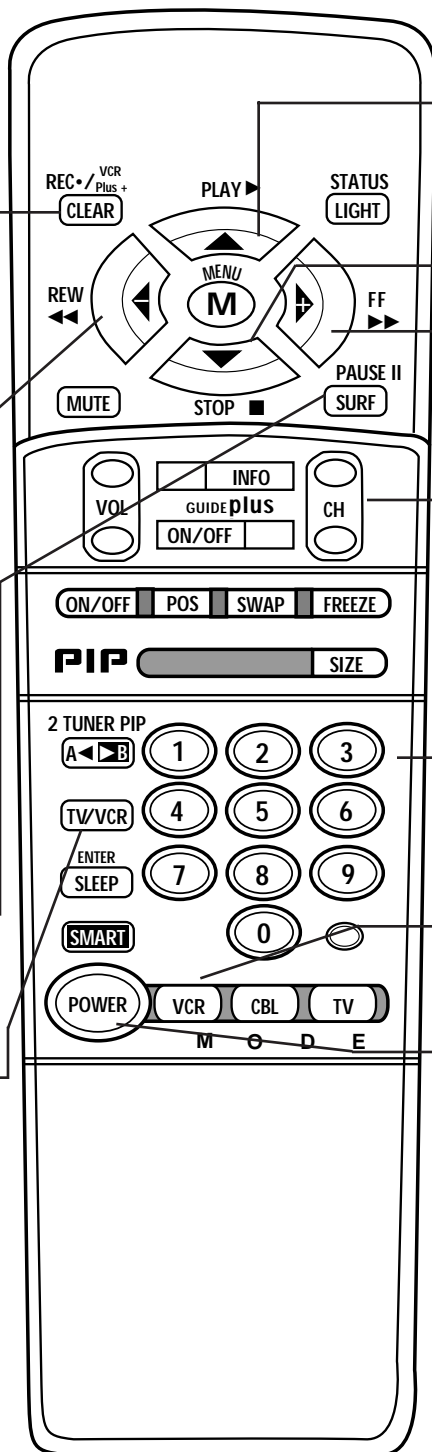

Play Button

Press to playback a tape. Hold down after pressing the RECORD button to start a recording.

Stop Button

Press to stop the tape.

Fast Forward Button

Press to rapidly advance the tape. For some VCRs you may need to press STOP first then FF. In Playback mode hold button down to view the picture moving rapidly in the forward direction.

Channel Scan Buttons

Press to scan up or down through VCR channel numbers.

Number Buttons

Press buttons for direct VCR channel selections.

VCR System Button

Press to send remote commands to the VCR.

Power Button

Press to turn the VCR ON and OFF.

SMART HELP

 Remember, the VCR buttons on the remote will not operate your VCR if those features are not already found on your VCR remote control. Note: All VCR functions (particularly Search, Rewind, Fast Forward, etc.) will operate the same as with the original VCR remote control provided with the VCR.

HOW TO USE THE PICTURE-IN-PICTURE (PIP) FEATURE

Picture-in-Picture (PIP) is the showing of two pictures on the TV screen at the same time. (One main screen picture and one small inset picture - or PIP). For your ease and convenience this TV has two separate inputs (ANTenna A and ANTenna B) for your home's Antenna and/or Cable TV system signal.

The ANT A input is primarily for the TV's main screen picture. The ANT B input is provided as a second, dedicated source option for the TV's PIP "window" and its feature operations. The signal connected to the ANT B input can be either a Split Signal Input (as described in the section on this page), or another type of external signal source (such as a satellite dish system, additional home antenna, video accessory, etc.).

See the following steps on how channels connected to the ANT(enna) B Input can be shown and used within the PIP window:

BEGIN

1 Connect your Antenna or Cable TV signal to the single 75 ohm INPUT plug on a two-way Signal Splitter (not supplied).

Connect two lengths of RF Coaxial Cable (F-type connectors on both ends) to the two OUTPUT plugs on the two-way Signal Splitter.

2 Connect the twin OUTPUT plugs on the Signal Splitter to the ANT A and ANT B Inputs on the rear of the TV.

continue to next page

SMART HELP

For other possible PIP connections see page 49 for the "More PIP Connections" section.

If you need any accessories or parts to complete the described PIP connections, contact your dealer, or our Parts Information Center at (1-800-292-6066), for details.

- MAIN SCREEN -
Display signal supplied primarily through ANT A Input on rear of TV.

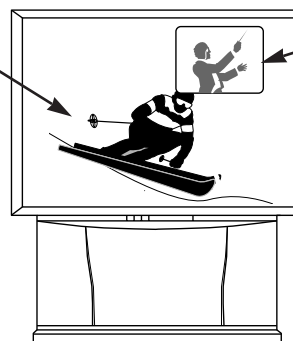

- PIP WINDOW -
Display signal supplied primarily through ANT B Input on rear of TV.

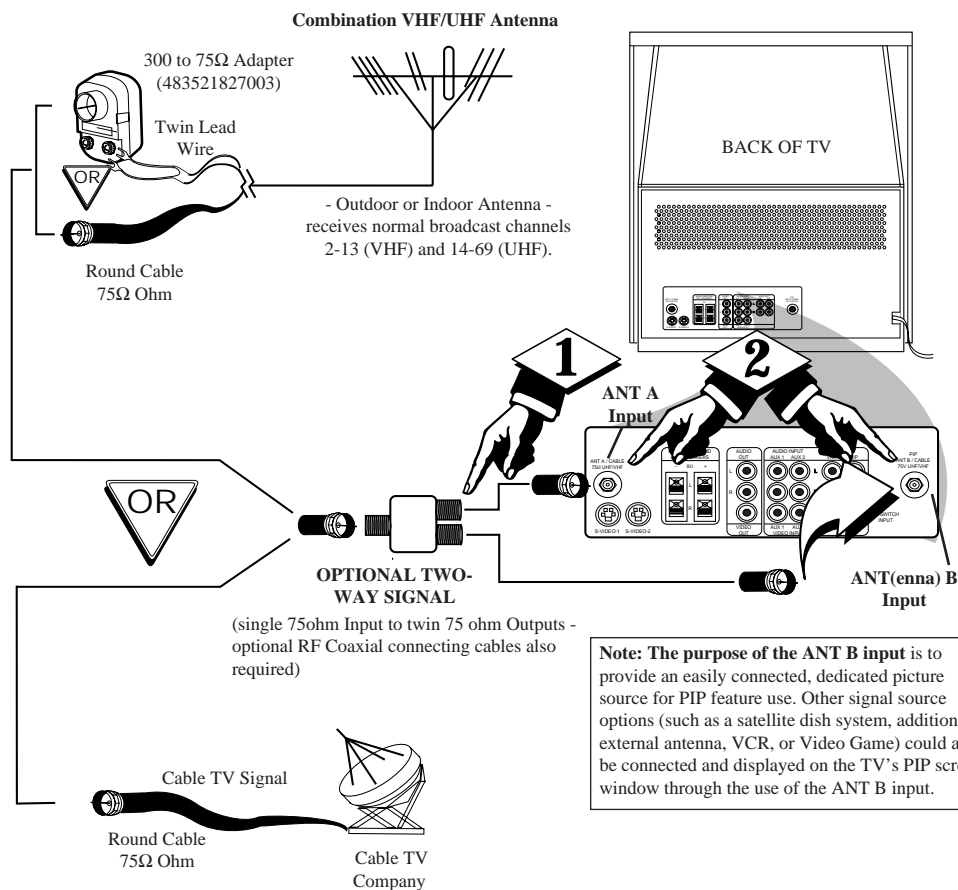

See the Set-Up Guide also provided with your TV set for further Cable TV connection options and accessories.



Now that you have completed the required connections on the previous page you are ready to follow the simple steps shown below.

3 Turn the TV ON.

Place the TV's PIP SOURCE SELECT control to "ANT B"-

- With FEATURES MENU (4 of 5) on screen, move the RED highlight with the MENU (M) buttons. Then press the MENU button.

- Press the MENU ▲▼ and MENU (M) buttons to highlight and select the ANT B" (✓) item.

Also place the TV's Main screen PICTURE SOURCE SELECT control to "ANT A"-

- See the Picture Source option FEATURES MENU (1 of 5).

Press the STATUS button to clear the screen when the above Menu items have been set.

4 Press the PIP ON/OFF button on the remote.

The PIP window should show in one of the corners of the TV screen.

5 Press the SWAP (or A◀▶B) buttons on the remote to move the ANT B and ANT A Input pictures between the PIP window and Main screen.

Use the Channel Number or CH ▲▼ buttons to select desired programs for viewing. Program Sound occurs with the channels displayed on the Main screen

Use the Channel Number or CH ▲▼ buttons to select desired programs for viewing. Program Sound occurs with the channels displayed on the Main screen

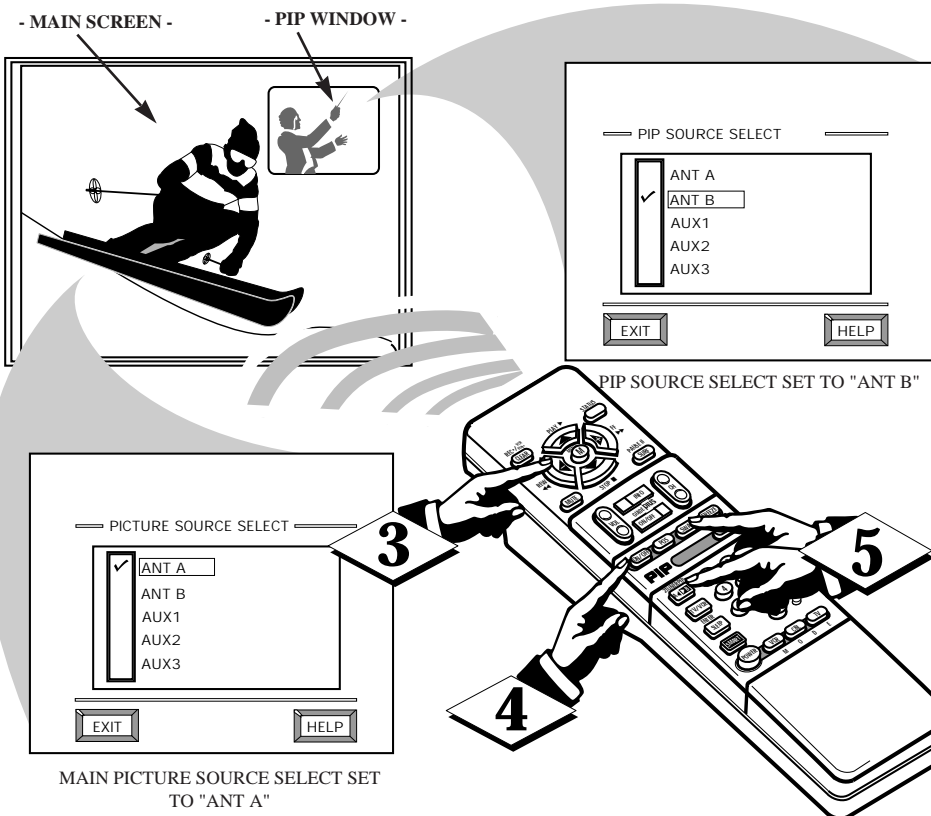

BLACK frame around the PIP window appears when the ANT A Input is on the Main screen.

WHITE frame around the PIP window appears when the ANT B Input is on the Main screen.

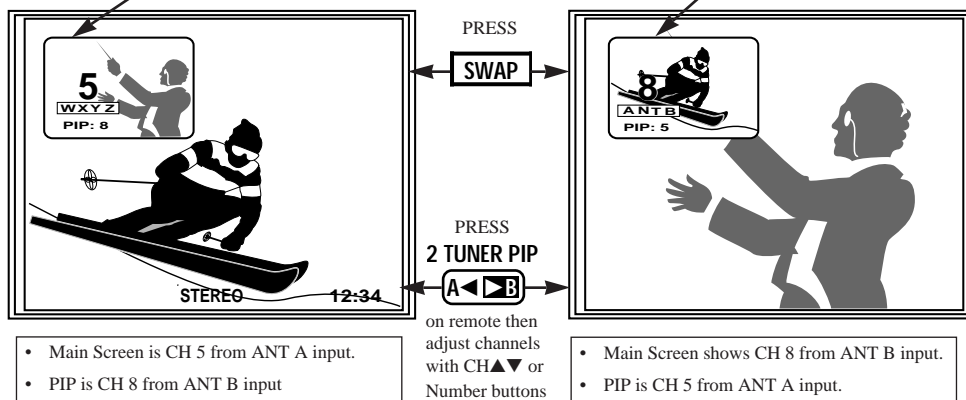

SMART HELP



Remember, if you see the same picture on the main screen and in the PIP window, check to be sure the TV's PIP Source Select and Main screen Picture Source select are set for ANT B and ANT A respectively. See the following page on how to operate other PIP features with the TV's remote control.

NOTE: Sound for TV programs displayed in the PIP window can also be heard through the use of PIP AUDIO OUT jacks on the rear of the TV. Just connect the TV's Left/Right PIP AUDIO OUTPUTS to the correct AUX(iliary) Inputs on an external stereo sound system (through which the PIP audio will be played).

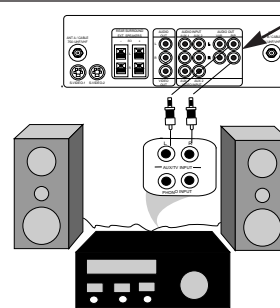

PIP AUDIO OUTPUT will be monaural (mono) when both ANT A and ANT B are being used for normal PIP operation. See page 26 for details on other stereo sound uses for the PIP Audio Output jacks.

By using the PIP buttons on the remote the PIP picture can be moved and swapped with the main screen. The main screen picture can also be frozen in the PIP window.

BEGIN

- 1 Press the **PIP ON/OFF** button to show the PIP picture.

PIP appears in a corner of TV screen. Press PIP ON/OFF again to remove PIP from the main screen.

- 2 Press the **PIP POSITION** button to move the PIP picture (from corner-to-corner on the TV screen.)

This feature allows you to move PIP and avoid blocking off any main screen action.

- 3 With PIP on the TV screen, press the **SWAP** button to swap the main screen picture with the PIP picture. See "Smart Help" note on this page.

- 4 Press **FREEZE** to hold the current MAIN screen picture in the PIP window (Main picture is still active).

If PIP is currently OFF, the PIP window will automatically appear.

Press FRZ repeatedly to update the frozen PIP with current pictures from the Main screen.

You cannot reposition a frozen PIP picture.

Press the PIP ON/OFF button to drop the frozen PIP picture from the screen.

- 5 Press the **PIP SIZE** button to change the size of the PIP window shown on the TV screen.

Press the PIP SIZE button again to see and compare the large and small size PIP windows.

You cannot change the size of a frozen PIP picture.



SMART HELP



Remember, if the TV is showing a "VCR/AUX" supplied picture on the main screen (when the TV and VCR are turned OFF), a blank screen will appear when the TV is turned back ON again.

If this happens, just press the CH(annel) ▲ or ▼ buttons to select a TV station for normal viewing.

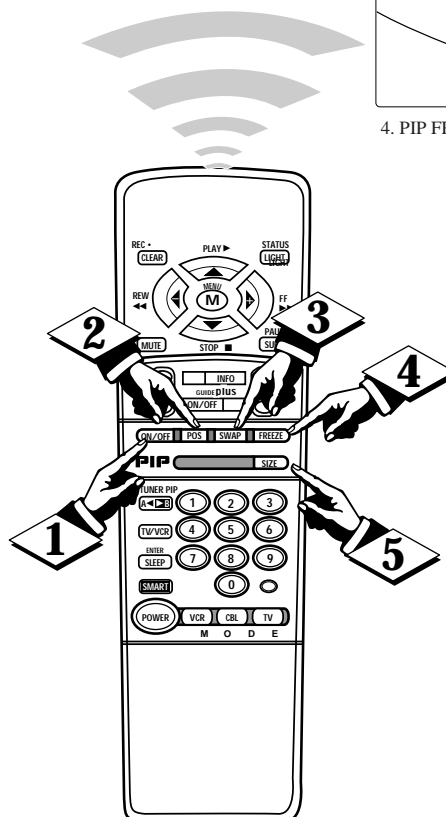
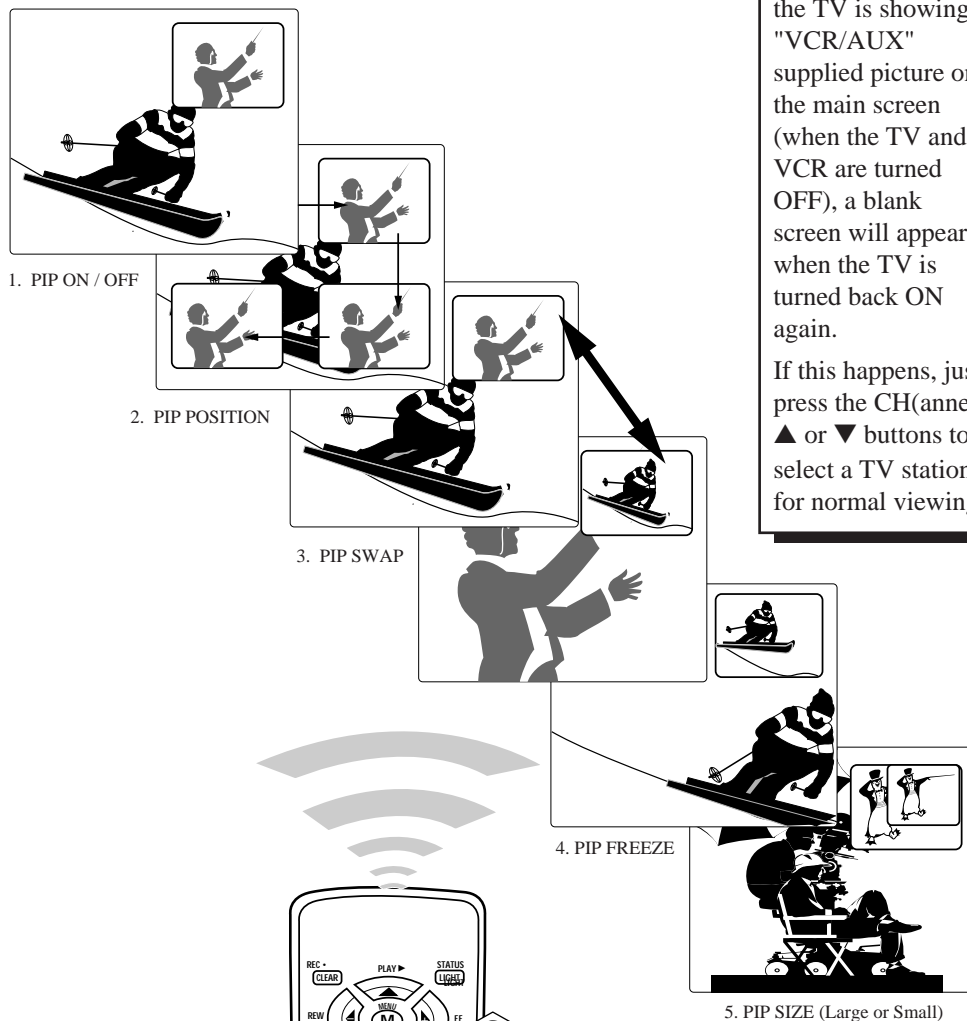

SELECTING THE PICTURE SOURCE FOR PIP

PIP SOURCE

The picture for the PIP window can come through either the ANT(enna) A / B Inputs or the AUX 1/2/3 Inputs (on the front and rear of the TV). PIP Picture Source simply tells the TV which one of these sources it is to show in the PIP window.

BEGIN

1 Select PIP SOURCE control.

With FEATURES MENU (4 of 5) on screen, move the RED highlight with the MENU (M)  buttons. Then press the MENU button.

2 Press the MENU and MENU (M) buttons to highlight and select the desired (✓) PIP Picture Source.

ANT A or B- for a picture signal coming from either the ANT(enna) A or B Input plug on the TV.

Note: The remote control's  button can also be used to quickly swap between the picture sources for the TV's Main screen and the PIP window.

AUX 1- for a picture signal coming from the AUX IN 1 Video Input jack on the rear of the TV.

AUX 2- for a picture signal coming from the AUX IN 2 Video Input jack on the rear of the TV.

AUX 3- for a picture signal coming from the Video Input jack on the front of the TV.

3 Press the STATUS button to clear the screen.



SMART HELP



Remember, the PIP window will be blank unless a signal is connected to the selected PIP Picture Source (ANT B, AUX 1/2/3, etc.) on the rear of the set.

If you see the same picture on the main screen and in the PIP window, you may have the Main Screen and PIP window set to the same video input source.

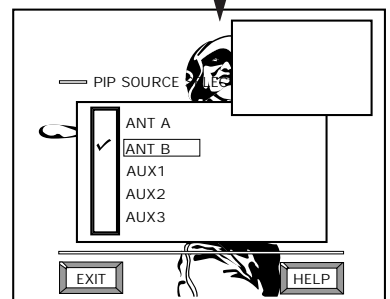
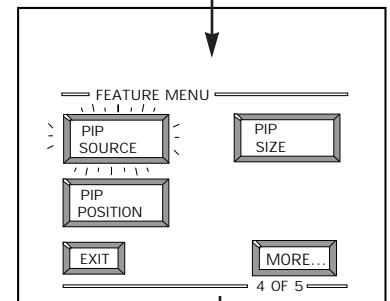
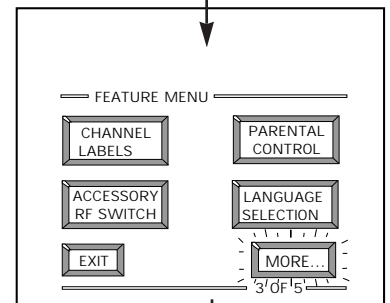
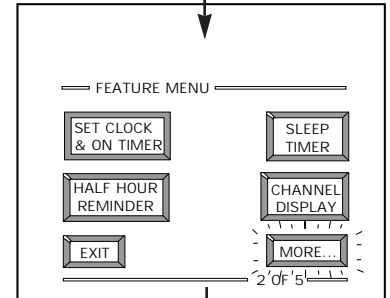
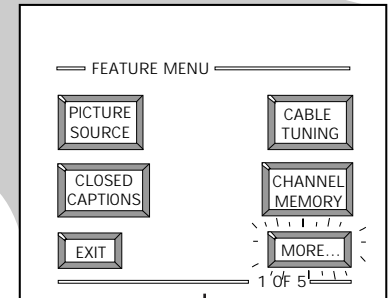
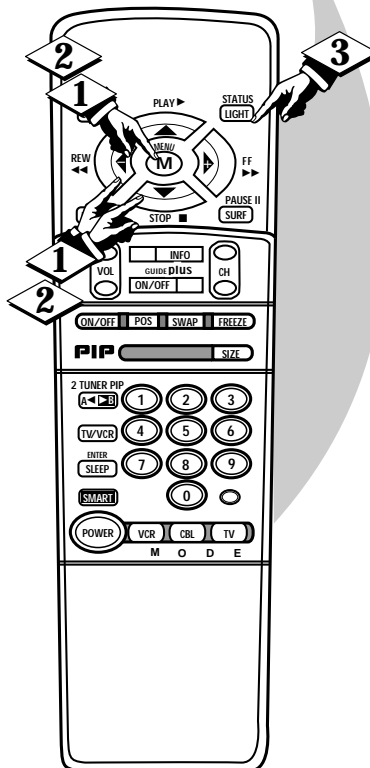
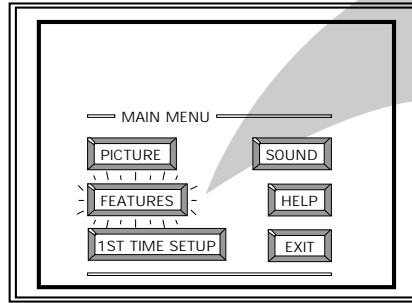



PIP COLOR / PIP TINT

The Picture-In-Picture (PIP) Color and Tint controls are used to make fine tune adjustments to the color settings for PIP (when it is shown on the TV screen).

BEGIN

- 1 Select PIP COLOR (or PIP TINT) control.

With FEATURES MENU (5 of 5) on screen, move the RED highlight with the MENU (M) buttons. Then press the MENU button.

- 2 Press the MENU buttons to move the RED highlight. Press the MENU button to turn the PIP COLOR or TINT control ON.

The PIP automatically comes on to show the PIP window on the TV screen.

- 3 Press the (+) and (-) buttons to adjust the PIP for Color (or Tint) levels you prefer.

- 4 Press the STATUS button to clear the screen.



SMART HELP



Remember. Although there are separate COLOR and TINT controls for PIP, the adjustment levels for these controls depend on the TV's main picture. For example: If the main screen is showing a black and white picture, PIP would also be in black and white (even though its source is in color).

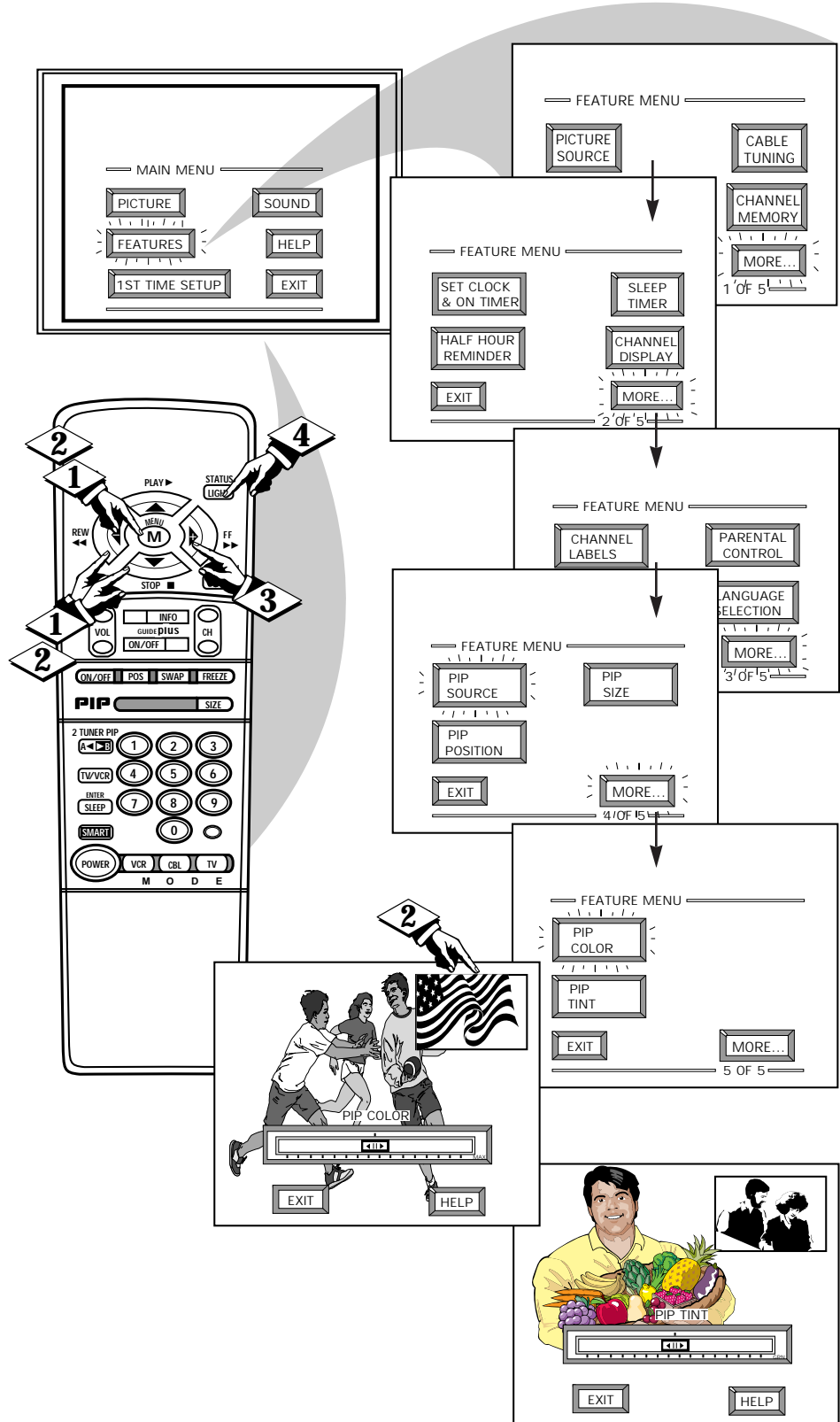



PIP hookup with Cable Converter Box and VCR.

BEGIN

1 First use an optional signal splitter and connect the original cable TV signal to both the CABLE IN on the Cable Converter and the ANTENNA plug on the rear of the TV.

2 Connect the CABLE OUT on the Converter to the ANT. IN on the VCR.

3 Connect the VIDEO OUT jack on the VCR to the VIDEO IN jack on the TV.

Also connect the AUDIO OUT (R and L) jacks from the VCR to the AUDIO IN jacks on the TV.



SMART HELP



Remember to use the Cable TV Converter Box to select channels for PIP, the VCR must be set to the same channel as the channel selection switch on the rear of the Cable Converter (either channel 3 or 4).

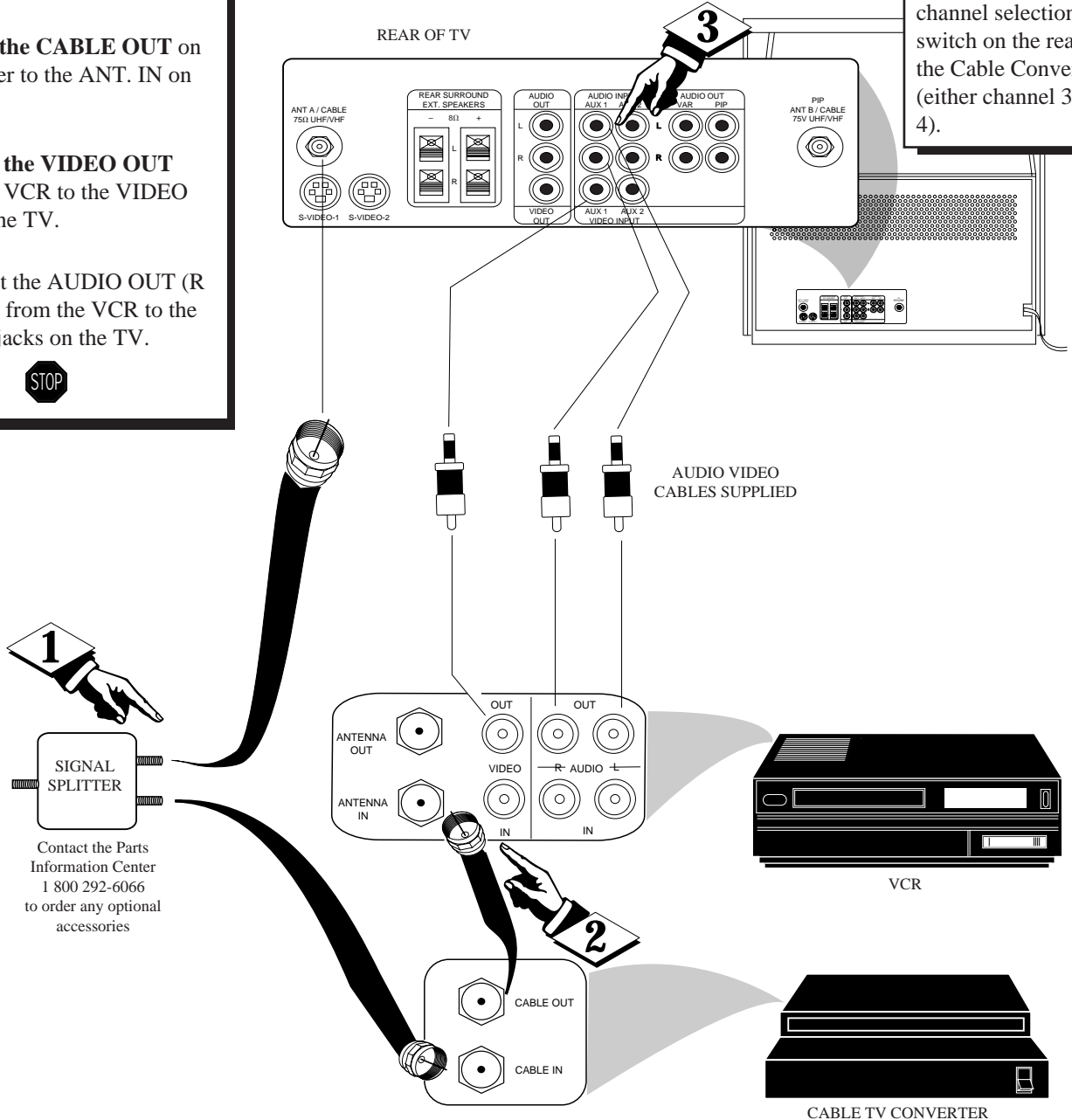

Contact the Parts Information Center
1 800 292-6066
to order any optional accessories



The on screen **HELP** menu offers both **Operating Tips** and a list of **Glossary** definitions for different features on your TV. These items are given to provide you with more information and details on a select group of feature operations.

(BEGIN)

1 Select "**HELP**" on the TV's Main Menu.

Press the remote's **Menu** buttons to move UP/DOWN and from SIDE-TO-SIDE within the list of on-screen features.

Press **MENU (M)** to select the highlighted "**HELP**" item.

2 Press the **MENU** **▲▼** and then the **MENU (M)** buttons to select either the **OPERATING TIPS** or **GLOSSARY** item.

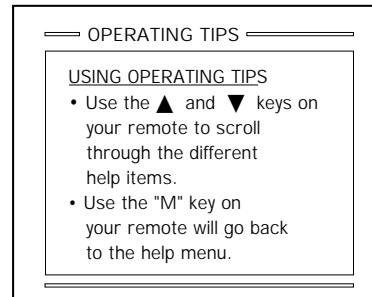
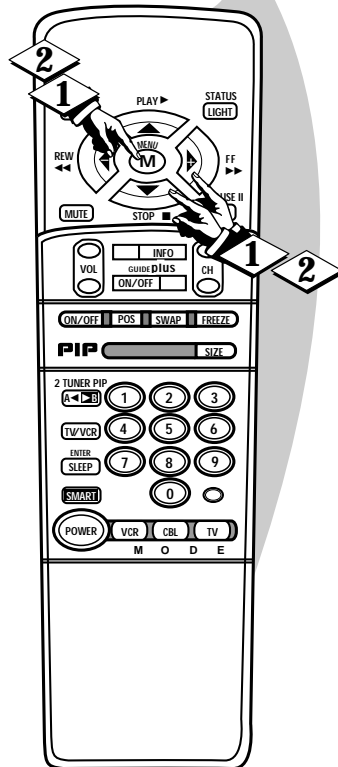
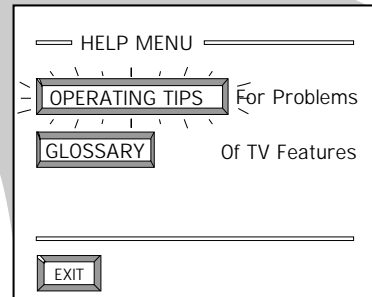
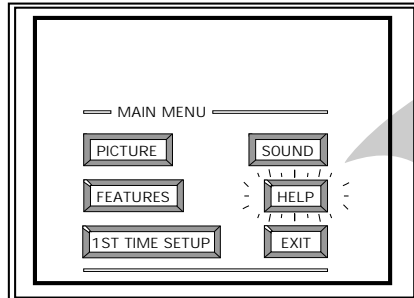

FOLLOW THE ON SCREEN DIRECTIONS TO VIEW OPERATING TIPS



Please make these simple checks before calling for service. These tips can save you time and money since charges for TV installation and adjustment of customer controls are not covered under your warranty.

No Power

CAUTION: A video source (such as a video game, Compact Disc Interactive - CDI, or TV information channel) which shows a constant non-moving pattern on the TV screen, can cause picture tube damage. When your TV is continuously used with such a source the pattern of the non-moving portion of the game (CDI, etc.) could leave an image permanently on the picture tube. When not in use, turn the video source OFF. Regularly alternate the use of such video sources with normal TV viewing.

- Check the TV power cord. Unplug the TV, wait 1 minute, then reinsert plug into outlet and push POWER button again.
- Check to be sure outlet is not on a wall switch.

No Picture

- Check antenna connections on the rear of the TV. Are they properly secured to the antenna plug on the TV?
- Check the CABLE TUNING control for correct position.
- Check PICTURE SOURCE control for correct position VCR/AUX, AUX 2, AUX 3 or S-VIDEO position without a signal source will result in a blank screen.
- Check the CLOSED CAPTIONS control. Some TEXT modes could block the screen.

No Sound

- Check the VOLUME and MUTE buttons on the TV and remote.
- Check the TV SPEAKER NORMAL/OFF control for the correct position.
- If attempting auxiliary equipment hook-ups, check audio jack connections and that the auxiliary equipment is on and in the proper operating modes.
- Check AMP SWITCH (on rear of TV). Place in INTERNAL position for normal TV sound (through the TV's internal speaker system). EXTERNAL for optional Dolby ProLogic Surround Sound connections using the TV's speakers as Center Channel.

Remote Does Not Work

- Check TV-VCR-CBL "System" buttons on the remote. Press the remote's TV System button to send commands to the TV; VCR System to sent to VCR; etc.
- Check batteries. Replace with AA Heavy Duty (Zinc Chloride) or Alkaline batteries if necessary.
- Clean the remote and the remote sensor window on the TV.

TV Displays Wrong Channel or No Channels Above 13

- Repeat channel selection.
- Add desired channel numbers (ADD/DELETE CHANNELS control) into TV memory.
- Check CABLE TUNING control for correct position.

This TV is equipped with protective circuitry that shuts the TV off in case of moderate power surges. Should this occur turn the TV back on by pressing the POWER button once or twice, or unplug and then replug the power cord at the AC outlet. This feature is NOT designed to prevent damage due to high power surges such as those caused by lightning, which is not covered by your warranty.

Cleaning and Care

- To avoid possible shock hazard be sure the TV is unplugged from the electrical outlet before cleaning.
- When cleaning the TV screen take care not to scratch or damage the screen surface (avoid wearing jewelry or using anything abrasive- do not use household cleaners). Wipe the front screen with a clean cloth dampened with water. Use even, easy, vertical strokes when cleaning.
- Specially designed screen cleaning kits are also available which contain anti-static cleaners and cloths designed to get into the ridges of the TV screen. If interested, ask your dealer about the MAG4600 Projection TV Screen Cleaning Kit or call our toll-free Accessory Parts ordering number 1-800-292-6066.
- Gently wipe the cabinet surfaces with a clean cloth or sponge dampened in a solution of cool clear water and a mild soap or detergent. Use a clean dry cloth to dry the wiped surfaces.
- Occasionally vacuum the ventilation holes or slots in the cabinet back.
- Never use thinners, insecticide sprays, or other chemicals on or near the cabinet, as they might cause permanent marring of the cabinet finish.



A/V Inputs * Connector plugs which allow the introduction of distinct audio and video signals into the TV from accessory VCRs, camcorders, etc. These plugs bypass the normal tuner or RF/Antenna signal circuitry.

Coaxial Cable * A single solid antenna wire normally matched with a metal plug (F-type) end connector that screws (or pushes) directly onto a 75 Ohm input found on the Television or VCR.

Display * An on screen message or graphics that help the user operate and adjust his Television feature controls. See On Screen Displays (OSD).

Direct Audio/Video Inputs * Located on the rear of the TV these connectors (RCA phono type plug) are used for the input of audio and video signals. Designed for use with VCRs (or other accessories) in order to receive higher picture resolution and offer sound connection options.

Identify * Method by which a remote control searches and finds an operating code for another product (such as a VCR or Cable Converter). Once the code has been "identified" then the TV remote can operate and send commands to the other product.

Multichannel Television Sound (MTS) * The broadcast standard that allows for stereo sound to be transmitted with the TV picture.

On Screen Displays (OSD) * Refers to the wording or messages generated by the television (or VCR) to help the user with specific feature controls (color adjustment, programming, etc.).

Menu * An on-screen listing of feature controls shown on the Television screen that are made available for user adjustments.

Picture -In-Picture (PIP) * Term used when two pictures are shown on the TV screen at the same time. The smaller PIP picture is supplied by a VCR (or other tuner/video playback source). The PIP picture can also be moved and swapped with the TV's main screen picture.

Pre-Amplifier * The control center of a hi-fi system. Not only amplifies source inputs, but also allows for source selection, volume, tone, balance and all other controls that affect the sound.

Programming * The procedure of adding or deleting channel numbers into the Television's memory circuits. In this way the Television "remembers" only the locally available or desired channel numbers and skips over any unwanted channel numbers.

Remote Sensor Window * A window or opening found on the Television control panel through which infrared remote control command signals are received.

Second Audio Program (SAP) * Another or additional audio channel provided for in the Multichannel Television Sound (MTS) broadcast standard. The most frequently proposed use for SAP is the simultaneous bilingual broadcast of TV program material.

Status * Allows the user to quickly confirm what channel number is currently being viewed. Status can also be used to clear the Television of on screen displays or information (rather than waiting for the displays to "time out" or automatically disappear from the screen).

S-Video Input * Allows direct connection of high-resolution video sources, such as a Super VHS videocassette recorder, Laser Disc player, etc. Provides optimum picture resolution, sharpness, and clarity.

Twin Lead Wire * The more commonly used name for the two strand 300 Ohm antenna wire used with many indoor and outdoor antenna systems. In many cases this type of antenna wire requires an additional adapter (or balun) in order to connect to the 75 Ohm Input terminals designed into the more recent Televisions and VCRs.

Variable Audio Output * An adjustable audio output which allows for volume variations at the source.



Accessories/Optional.....	10, 27, 28, 29, 30-33, 46, 51 *Q/U-1	Parental Control.....	20-21
Adapter Connector.....	46, 51, *Q/U-1	Picture-In-Picture (PIP).....	46-51, *Q/U-2
Add/Delete Channels	13-14, *Q/U-2	Power Light Indicator.....	*Q/U-3
Advance Buttons	*Q/U-2, 4	Precautions/Safety	2, 3, 53, *Q/U-1
Audio Controls	24-28	Programming Channels	13, *Q/U-2
Audio/Video Input	30-33, 46, 51 *Q/U-2	Remote Control	34-45, 48, *Q/U-2, 3, 4
Automatic Programming	13, *Q/U-2	Remote Locator	34-35
Battery Installation	*Q/U-3	Remote with VCRs	40-41, 44-45
Cable TV Connections/Settings	12, 46, 51 *Q/U-1, 2	Requesting Service.....	53, 56-57, 58
Channel/Time Display.....	18, 19, 22, *Q/U-3	RF Coaxial Cable	46, 51, *Q/U-1
Channel Memory.....	13-14, *Q/U-2	Reminder/Time and Channel.....	19
Channel/Time Reminder.....	19	Safety/Precautions	2, 3, 53, *Q/U-1
Clock Setting	15	Second Audio Program (SAP).....	25
Clock Timer	16	Sensor Remote.....	*Q/U-3
Closed Captioning	11	Sleep Timer.....	17
Color Controls	6,*Q/U-4	Smart Picture	36-37
Convergence	8	Smart Sound.....	38
Controls/TV	*Q/U-2, 3, 4	Status Button	*Q/U-3, 4
Controls/Remote	34-45, 48, *Q/U-2, 3, 4	Surround Sound.....	26, 28-29
ESI BUS.....	29	Time/Channel Display.....	19, 22, *Q/U-3
Exit	*Q/U-4	Timer (Turn On)	16
Features.....	5	VCR Button	30, 45
First Time Set Up	*Q/U-2	VCR/TV Connections	30-33, 46, 51, *Q/U-1
Glossary/TV Terms	54	Tips for Service	53, 56-57
Help Menu	52, *Q/U-2, 4	TV Speaker Control.....	27
Inputs/Audio and Video	30-33, 46, 51	Variable Audio Output	28
Menu.....	*Q/U-2, 4	Volume Display	26
Minus(-)/Plus (+) Buttons.....	*Q/U-3, 4	Warranty	60

* Information contained in Quick-Use (Q/U) Guide - page listed

Philips Consumer Electronics Company Factory Service Center Locations

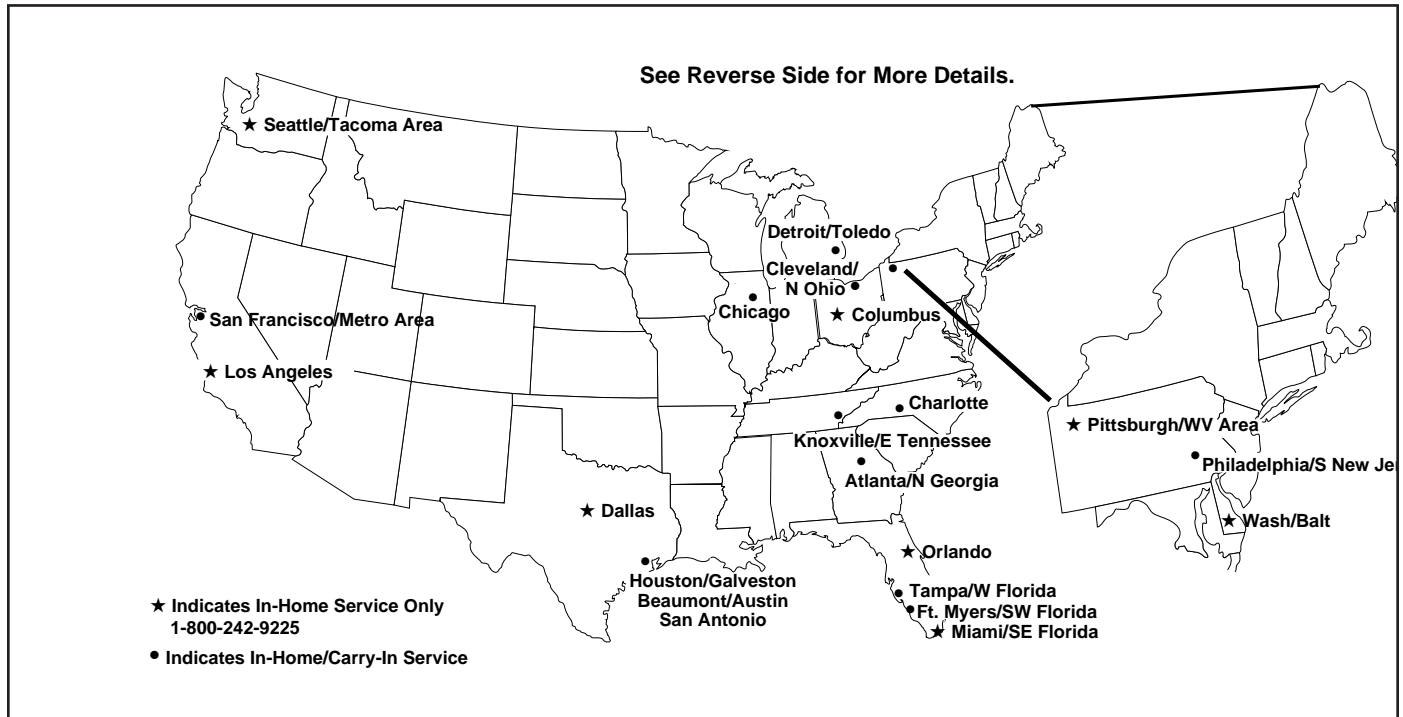

NOTE: If you reside in one of our Philips Factory Service Branch areas (see directory on back), you can contact the nearest Service Branch to obtain efficient and expedient repair for your product. If your product is In-Warranty, you should have proof-of-purchase to ensure No Charge Service. For Out-of-Warranty service, call the location nearest you.

NOTA: Si vous résidez dans une des régions desservies par une succursale de service après vente du fabricant Philips (voir liste ci-dessous), vous pourrez contacter la branche de service après vente la plus près de chez vous pour obtenir un service après vente rapide et efficace. Si le produit est sous garantie, il suffira de présenter une preuve d'achat pour bénéficier d'un service sans frais. Pour les produits non couverts par la garantie, contactez le centre le plus près de chez vous.

NOTA: Si Ud. reside en una de nuestras zonas para sucursales Philips de servicio al de fábrica (ver directorio más abajo), Ud. puede comunicarse con la sucursal de servicio más cercana para obtener una reparación oportuna y eficaz de su producto. Si su producto está todavía bajo garantía, Ud. debe presentar comprobante de compra para no ocasionar ningunos cargos por servicio. Para servicio después del vencimiento de la garantía, llame al lugar más cercano de los abajo indicados.

In Canada

How you can obtain efficient and expedient carry-in, mail-in, or in-home service for your product

Please contact Philips at

1-800-661-6162 (French speaking)

1-800-363-7278 (English speaking)

Au Canada

Comment obtenir le service après-vente pour les produits apportés ou envoyés par la poste à notre centre de service ou le service à domicile

Veillez contacter philips à:

1-800-661-6162 (Francophone)

1-800-363-7278

En el Canadá

Cómo recibir servicio eficiente para su producto, en persona, por correo o a domicilio

Favor de comunicarse con Philips al:

1-800-661-6162 (francófono)

1-800-363-7278 (anglófono)

QUALITY SERVICE IS AS CLOSE AS YOUR TELEPHONE! SIMPLY LOOK OVER THE LIST BELOW FOR THE NUMBER OF A FACTORY SERVICE CENTER NEAR YOU. YOUR PRODUCT WILL RECEIVE EFFICIENT AND EXPEDIENT CARRY-IN, MAIL-IN, OR IN-HOME SERVICE, AND YOU WILL RECEIVE PEACE OF MIND, KNOWING YOUR PRODUCT IS BEING GIVEN THE EXPERT ATTENTION OF PHILIPS' FACTORY SERVICE. AND, IF THE PHONE NUMBER LISTED FOR YOUR AREA IS LONG DISTANCE, CALL 1-800-242-9225 FOR FACTORY SERVICE.

COMMENT OBTENIR NOTRE SERVICE APRÈS VENTE RAPIDE ET EFFICACE SOIT PAR COURRIER, À DOMICILE, OU EN SE PRÉSENTANT À UN CENTRE DE SERVICE PHILIPS. PLUS DE 600 CENTRES DE RÉCEPTION DE PRODUITS À RÉPARER À TRAVERS LE PAYS: CONTACTER LE CENTRE DE SERVICE AUX CONSOMMATEURS LE PLUS PROCHE POUR SAVOIR L'EMPLACEMENT DE CES DÉPÔTS DANS UN RAYON DE 50 À 75 MILES (80 KM À 120 KM) DU CENTRE DE SERVICE LOCAL.

CÓMO OBTENER UN SERVICIO OPORTUNO Y EFICIENTE POR CORREO, EN CASA O EN PERSONA PARA SU PRODUCTO A TRAVÉS DE UN CENTRO PHILIPS DE SERVICIO. MAS DE 600 SITIOS POR TODO EL PAIS PARA LA RECEPCION DE PRODUCTOS NECESITADOS DE REPARACIONES: COMUNICARSE CON EL CENTRO DE SERVICIO DE FABRICA MAS CERCANO PARA ESTOS LUGARES DENTRO DE UN RADIO DE 80 A 120 KM (50 A 75 MILLAS) DEL CENTRO DE SERVICIO LOCAL.

**Atlanta–Athens–Macon–Chattanooga,
TN–North Georgia Area**

200 North Cobb Parkway
Building 100, Suite 120
Marietta, GA 30062
(770) 795-0085

**Charlotte–Winston Salem–
Greensboro**

520-G Clanton Road
Charlotte, NC 28217
(704) 529-6330

Chicago–Gary Area

1360 W. Hamilton Parkway
Itasca, IL 60143
(630) 775-0990

Cleveland–Akron–Youngstown Area

24090 Detroit Road
Westlake, OH 44145
(216) 899-2040

Columbus–Dayton–Cincinnati Area

6333 Busch Blvd.
Columbus, Ohio 43229
(614) 781-2605

Dallas–Ft. Worth Area

13375 Stemmons Freeway,
Suite 200
Dallas, Texas 75234
(214) 243-4775

Detroit/Toledo Area

25173 Dequindre
Madison Heights, MI 48071
(810) 544-2110

**Knoxville–Greeneville–
Tri Cities–East Tennessee Area**

6700 D. Papermill Road
Papermill Plaza
Knoxville, TN 37919
(423) 584-6614

**Ft. Myers–Naples–
Southwest Florida Area**

11601 Cleveland Ave., Suite 15
Ft. Myers, FL 33907
(941) 278-4242

**Houston–Galveston–Beaumont–Austin–
San Antonio Area**

1110 North Post Oak Road
Suite 100
Houston, TX 77055
(713) 682-3990

Miami–Southeast Florida Area

2099 W. Atlantic Blvd.
Pompano Beach, FL 33069
(954) 978-0467

New York Metro Area

116 Charlotte Avenue
Hicksville, NY 11801
(516) 933-1780 Nassau County

**Orlando–Jacksonville–North
Florida–Southeast Georgia Area**

2452 Sand Lake Road
Orlando, FL 32809
(407) 857-8998

Philadelphia/S. New Jersey Area

352 Dunks Ferry Road
Bensalem, PA 19020
(215) 638-7500

**Pittsburgh, PA–Steubenville, OH–
Wheeling/Morgantown, WV Area**

2891 Banksville Road
Pittsburgh, PA 15216
(412) 563-8020

San Francisco–Oakland–San Jose Area

3370 Montgomery Drive
Santa Clara, CA 95054
(408) 492-9013

Seattle–Tacoma/Olympia Area

1055 Andover Park East
Tukwila, WA 98188
(206) 575-6288

Tampa–St. Petersburg–Sarasota Area

Center Point Business Park, Building B-1,
Suite 100
1911 U.S. Hwy. 301 North
Tampa, FL 33619
(813) 621-8181



NOTES

LIMITED WARRANTY

PROJECTION TELEVISION

One Year Free Labor

One Year Free Service on Parts

Two Years Free Service on Cathode Ray Tube Parts / 30 days Free Service on Projection TV Screen

This product can be repaired in-home.

WHO IS COVERED?

You must have proof of purchase to receive warranty service. A sales receipt or other document showing that you purchased the product is considered proof of purchase.

WHAT IS COVERED?

Warranty coverage begins the day you buy your product. For one year thereafter (30 days for the projection TV screen), all parts will be repaired or replaced, and labor and transportation are free. From one to two years from the day of purchase, you pay for the replacement or repair of all parts except the cathode ray tube and the "Clear-Vu" lens, and for all labor and transportation charges. After two years from the day of purchase, you pay for the replacement or repair of all parts except the "Clear-Vu" lens (which is guaranteed against manufacturer's defects for the life of the product), and for all labor and transportation charges.

All parts, including repaired and replaced parts, are covered only for the original warranty period. When the warranty on the product expires, the warranty on all replaced and repaired parts also expires.

WHAT IS EXCLUDED?

Your warranty does not cover:

- labor charges for installation or setup of the product, adjustment of customer controls on the product, and installation or repair of antenna systems outside of the product.
- product repair and/or part replacement because of misuse, accident, unauthorized repair or other cause not within the control of Philips Consumer Electronics Company.
- reception problems caused by signal conditions or cable or antenna systems outside the unit.
- a product that requires modification or adaptation to enable it to operate in any country other than the country for which it was designed, manufactured, approved and/or authorized, or repair of products damaged by these modifications.
- incidental or consequential damages resulting from the product. (Some states do not allow the exclusion of incidental or consequential damages, so the above exclusion may not apply to you. This includes, but is not limited to, prerecorded material, whether copyrighted or not copyrighted.)
- a product used for commercial or institutional purposes.

WHERE IS SERVICE AVAILABLE?

Warranty service is available in all countries where the product is officially distributed by Philips Consumer Electronics Company. In countries where Philips Consumer Electronics Company does not distribute the product, the local Philips service organization will attempt to provide service (although there may be a delay if the appropriate spare parts and technical manual(s) are not readily available).

MAKE SURE YOU KEEP...

Please keep your sales receipt or other document showing proof of purchase. Attach it to this owner's manual and keep both nearby. Also keep the original box and packing material in case you need to return your product.

BEFORE REQUESTING SERVICE...

Please check your owner's manual before requesting service. Adjustments of the controls discussed there may save you a service call.

TO GET WARRANTY SERVICE...

Repair must be performed by an authorized service center or a factory service center. *If you do not live near a factory service center, contact your dealer.* If your dealer is an authorized service center, he will arrange repair. If your dealer is not an authorized service center, he will direct you to the authorized service center engaged by him to service the products he sells.

(In U.S.A., Puerto Rico and U.S. Virgin Islands, all implied warranties, including implied warranties of merchantability and fitness for a particular purpose, are limited in duration to the duration of this express warranty. But, because some states do not allow limitations on how long an implied warranty may last, this limitation may not apply to you.)

(In Canada, this warranty is given in lieu of all other warranties. No other warranties are expressed or implied, including any implied warranties of merchantability or fitness for a particular purpose. Philips is not liable under any circumstances for any direct, indirect, special, incidental or consequential damages, howsoever incurred, even if notified of the possibility of such damages.)

IF YOU HAVE QUESTIONS...

Please contact Philips at:

1-800-661-6162 (French Speaking)

1-800-363-7278 (English Speaking)

REMEMBER...

Please record the model and serial numbers found on the product below. Also, please fill out and mail your warranty registration card promptly. It will be easier for us to notify you if necessary.

MODEL # _____

SERIAL # _____

This warranty gives you specific legal rights. You may have other rights which vary from state/province to state/province.

Philips Service Company, P.O. Box 555, Jefferson City, Tennessee 37760, (423) 475-8869



First Time Set Up - automatically sets the TV for local channels and the correct picture signal (antenna or cable). It even helps you make the necessary connections for the Picture-In-Picture (PIP) feature.

Infrared Remote Control - operates your TV set and a variety of wireless remote control VCRs and Cable TV Converters. A special "Locator" feature can also help you find the remote when it has been stuck out of sight or misplaced.

Standard TV broadcast (VHF/UHF) or Cable TV (CATV) channel capability.

Closed Captioning - allows the viewer to read TV program dialogue or voice conversations as on-screen text.

Automatic Programming of channels - for quick and easy selection of favorite stations available in your area.

Picture-In-Picture (PIP) - can show a TV program and the direct video output from an accessory (VCR, etc.) onto the TV screen at the same time.

Parental Control for "Censoring" - this feature can block out channels to keep children from watching undesirable programming.

Stereo-Ready TV - with a built-in audio amplifier and a twin speaker system, reception of TV programs in both broadcast stereo sound or (SAP) bilingual broadcast are available.

On-Screen Features - display helpful information for the setting of TV controls (such as help messages, operating tips and glossary).

Audio/Video Jacks - for direct connections with VCRs (and other accessories) for quality TV picture and sound playback.

Surround Sound - this TV set contains external; audio speaker connections for a more dynamic sound effect.

Sleep-Timer - automatically turns the TV OFF at preset time intervals.

Smart Button - for the control of TV Sound and the Picture levels. Use the Smart Button on the remote to quickly adjust Smart Sound (to set TV Volume levels during program changes or commercial breaks); Smart Picture (for programmed video level adjustments on a variety of program sources); and Smart Surf (for quick one button channel selection of up to 10 of your favorite channels).

As you unpack your TV please note that the following items have been included with your set:

- Owner's Manual
 - Safety Tip Information
 - Factory Service Center Locations
- Warranty Registration Card
- Remote Control Transmitter
- Batteries for Remote Control Use
- Audio/Video Cables for Direct Input and Output Connections.

Please take a few minutes to complete your registration card. The serial number for the TV is on the back of the set.

Refer to the back of this manual for instructions on the cleaning and care of the TV.

ACCESSORY SHELF COMPARTMENT

An accessory storage shelf compartment has been designed into your TV for the placement of such items as VCRs, CD-i (Compact Disc Interactive) Players, or other pieces of audio/video equipment.

Use the connection tunnel (located on the rear wall of the storage compartment) to route Antenna, Cable, or other signal supply wires from the accessories to the TV's rear cabinet jackpanel.

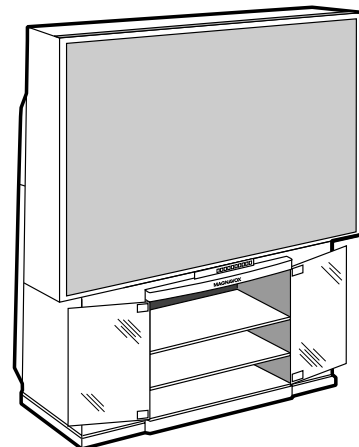

3135 015 07470

Free Manuals Download Website

<http://myh66.com>

<http://usermanuals.us>

<http://www.somanuals.com>

<http://www.4manuals.cc>

<http://www.manual-lib.com>

<http://www.404manual.com>

<http://www.luxmanual.com>

<http://aubethermostatmanual.com>

Golf course search by state

<http://golfingnear.com>

Email search by domain

<http://emailbydomain.com>

Auto manuals search

<http://auto.somanuals.com>

TV manuals search

<http://tv.somanuals.com>