

# *Philips Multimedia projector Hopper 20 series*



***English***

**IMPORTANT NOTE FOR USERS IN THE U.S.A.**

The responsible party of this multi media projector is the following:

**Philips Consumer Electronics Company  
One Philips Drive  
Knoxville, TN 37914  
Telephone 1888 873 4672**

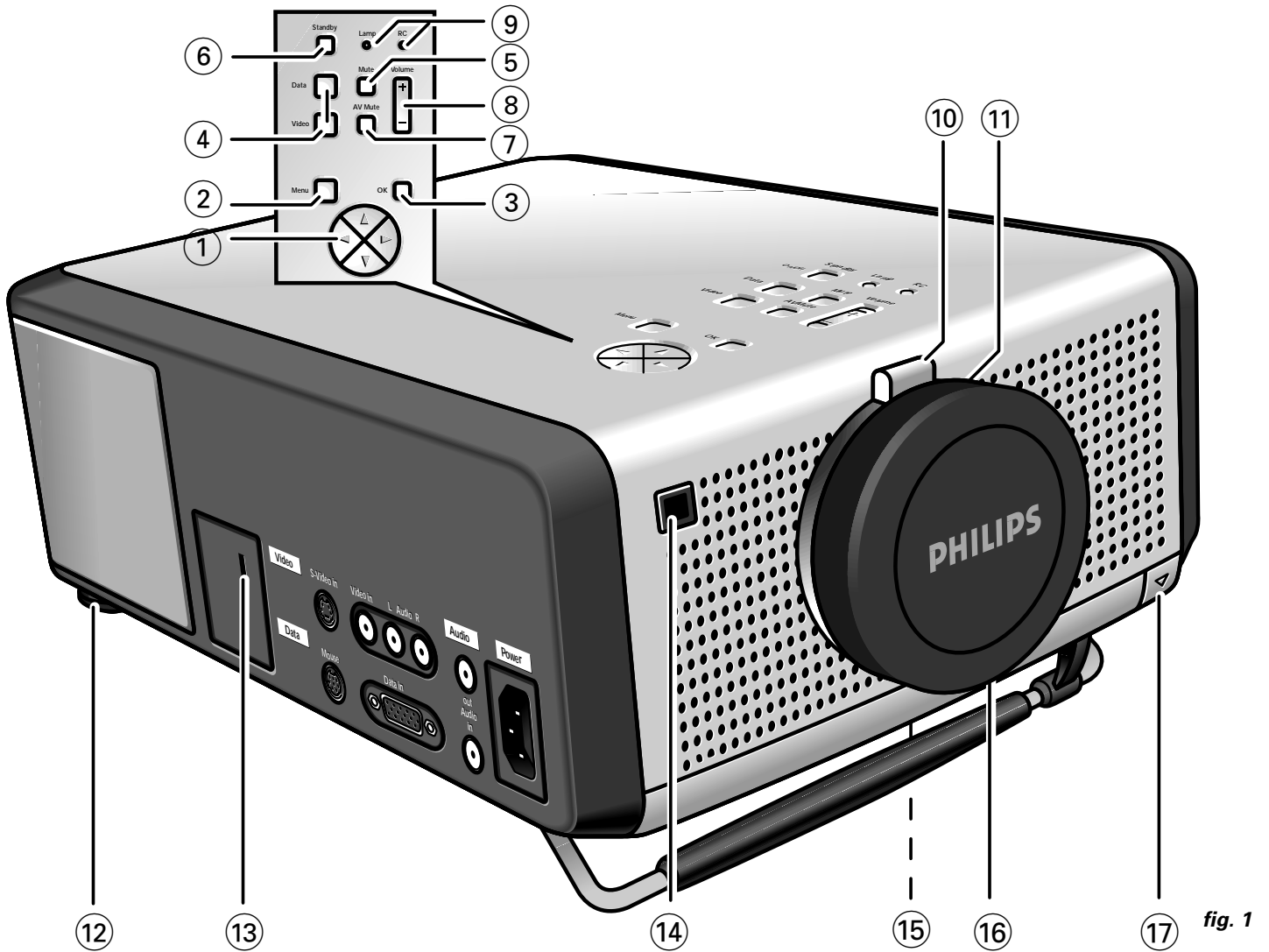

fig. 1



fig. 2

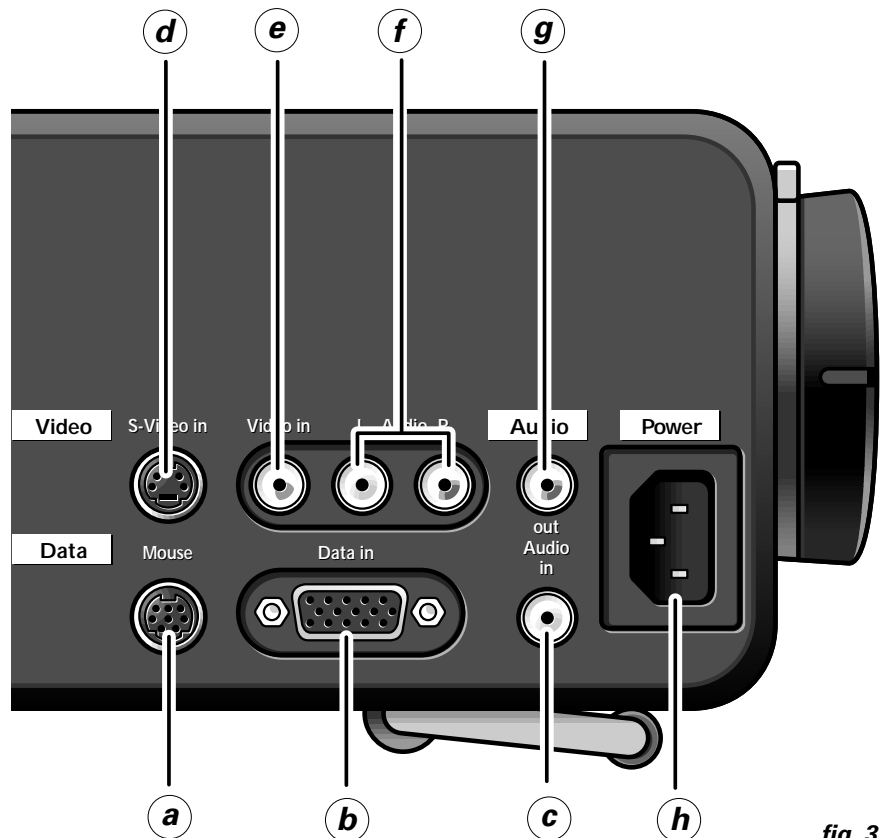

fig. 3

## TABLE OF CONTENTS

<b>1. INTRODUCTION</b> .....	<b>4</b>
<b>2. THINGS YOU SHOULD KNOW</b> .....	<b>4</b>
<b>3. IMPORTANT SAFEGUARDS</b> .....	<b>5</b>
<b>4. PROJECTOR FEATURES</b> .....	<b>6</b>
<b>5. FUNCTIONAL OVERVIEW</b> .....	<b>7</b>
Controls .....	7
Connections .....	7
<b>6. SET UP</b> .....	<b>8-9</b>
Positioning the projector and screen .....	8
Mains supply .....	8
Adjusting the focus and size of the image .....	8
Adjusting the vertical and horizontal angle of the projector .....	8
Moving the projector .....	9
Inserting the batteries in the remote control .....	9
<b>7. INSTALLATION</b> .....	<b>10-13</b>
Video/computer cables and adaptor .....	10
Connecting to a computer .....	11
Connecting to video equipment .....	12
Connecting to audio equipment .....	13
Connecting to an external monitor .....	13
<b>8. OPERATION</b> .....	<b>13-18</b>
Preparation .....	13-14
Picture control .....	14-15
Audio control .....	16
Personal Preferences .....	16-17
Other settings .....	17-18
<b>9. ADDITIONAL INFORMATION</b> .....	<b>19-21</b>
Installing the remote control software .....	19
RS-232C PC Control Interface .....	19
Maintenance .....	19-21
<b>10. TROUBLESHOOTING</b> .....	<b>22</b>
<b>ILLUSTRATIONS</b> .....	<b>3</b>

## INTRODUCTION

Congratulations on your purchase of one of the most sophisticated and reliable products on the market today. We are sure that, used properly, it will bring you years of enjoyment. You will want to keep this manual handy, as it is a convenient source of information about your projector. For your own protection and prolonged operation of your projector, please read the 'Important Safeguards' section before use.

## PACKAGING CONTENTS

Please confirm that the following items are packed in the projector box. They are provided to help you use or set up your projector.

- Projector
- 3 LR 6/AA/1,5 V Batteries
- Mains lead
- VGA Cable
- Video/Audio RCA Cable
- Scart/RCA Audio Video adaptor
- Mouse Cable 8-pin mini Din to RS232
- Mouse Cable 8-pin mini Din to ADB
- CD-ROM & Quick Reference Guide
- Remote control
- Portable soft bag

### Note:

This equipment has been tested to comply with the limits for a class A digital device in accordance with Part 15 of the FCC Rules as well as the European CE marking.

Operation is subject to the following two conditions:

1. This device may not cause harmful interference, and
2. This device must accept any interference received, including interference that may cause undesired operation.

These limits are designed to provide reasonable protection against harmful interference when the equipment is operated in a commercial environment.

This equipment generates, uses, and can radiate radio frequency energy and, if not installed and used in accordance with the user's guide, may cause harmful interference to radio communications.

Operation of this equipment in a residential area is likely to cause harmful interference in which case the user will be required to correct the interference at his own expense.

If this equipment does cause harmful interference to radio or television reception, which can be determined by turning the equipment off and on, the user is encouraged to try to correct the interference by one or more of the following measures:

- Reorientate or relocate the receiving antenna.
- Increase the distance between the equipment and receiver.
- Connect the equipment into an outlet on a circuit different from that to which the receiver is connected.
- Consult the dealer or an experienced radio/TV technician for help.

### FCC Warning:

To assure continued compliance, use only the provided grounded power supply cord and shielded interface cables when connecting this device to a computer. Also, any unauthorized changes or modifications to this equipment could void the user's authority to operate this device.

### Note:

**SAVE ENERGY!** To save energy, please put the projector in the **STANDBY** position if you are not going to use the projector for more than 15 minutes.

### 3. IMPORTANT SAFEGUARDS



**CAUTION: Please read all of these instructions before you operate your projector. Save these instructions for future reference.**

English

Electrical energy can perform many useful functions.

This projector has been engineered and manufactured to meet applicable safety standards. IMPROPER USE CAN RESULT IN POTENTIAL ELECTRICAL SHOCK OR FIRE HAZARDS. In order not to defeat the safeguards incorporated into this projector, observe the following basic rules for its installation, use and servicing.

1. Unplug the projector from the wall outlet before cleaning or lamp replacement.
2. Do not use liquid cleaners or aerosol cleaners. Use a soft dry cloth to clean the projector unit. If the unit is very dirty, wet a cloth with neutral detergent, squeeze it tight, wipe the unit with it, and finish by wiping with a dry cloth. Do not use a chemical duster or polisher-cleaner because it can adversely affect the unit and peel the paint.
3. Do not use attachments not recommended by PHILIPS, as they may cause hazards.
4. Do not use the projector near water- for example, near a bathtub, washbowl, kitchen sink, or laundry tub, in a wet basement, near a swimming pool, etc. Never spill liquid into the projector.
5. Do not place the projector on an unstable cart, stand, or table. The projector may fall, which may cause serious injury to a child or an adult and/or serious damage to the unit. Use only with a cart or stand recommended by its manufacturer as being suitable for use with a projector.
6. Ceiling, wall or shelf mounting should be done with a mounting kit approved by the manufacturer for use with a projector and should follow the manufacturer's instructions.
7. Projector equipment and cart combinations should be moved with care. Quick stops, excessive force, and uneven surfaces may cause the equipment and cart combination to overturn.
8. Slots and openings in the sides and bottom of the cabinet are provided for ventilation. To ensure reliable operation of the projector and to protect it from overheating, these openings must not be blocked or covered. These openings should never be covered with cloth or other material. The bottom opening should not be blocked by placing the projector on a bed, sofa, rug, or other similar surface. The projector should not be placed near or over a radiator or heating vent. The projector should not be placed in a built-in installation such as a bookcase unless proper ventilation is provided.
9. The projector should be operated only from the type of power source indicated on the side of the projector or in the specifications and with the appropriate mains lead. If you are not sure of the type of power supplied to your business or the right type of mains lead, consult your projector dealer or local power company.
10. Do not allow anything to rest on the power cord. Do not place the projector where the cord will be walked on.
11. Follow all warnings and instructions marked on the projector.
12. As a safety feature, this projector is equipped with mains lead with a 3-pin grounded plug (for USA-versions only) or a 2-pin grounded plug (for European versions only). The 3-pin/2-pin grounded plug will fit only into a grounding type power outlet. If the plug does not fit, use an adaptor that is properly grounded or have an electrician install a grounded type outlet. Do not attempt to modify this AC plug.
13. For added protection of the projector during a lightning storm, or when it is left unattended or not in use for long periods of time, unplug it from the wall outlet and disconnect any cable systems. This will prevent damage to the projector due to lightning and power-line surges.
14. Do not overload wall outlets and extension cords with too many products, because this can cause a fire or electric shock.
15. Never push objects of any kind into the projector through cabinet slots as they may touch dangerous voltage points or short cut parts, which could result in a fire or electric shock.
16. Do not attempt to service the projector yourself other than maintenance issues presented in chapter 'Maintenance'. Opening or removing covers may expose you to dangerous voltage or other hazards. Refer all servicing to qualified service personnel.
17. Unplug the projector from the wall outlet and refer servicing to qualified service personnel under the following conditions:
  - A. When the power cord or plug is damaged or frayed.
  - B. If liquid has been spilled into the projector.
  - C. If the projector has been exposed to rain or water.
  - D. If the projector does not operate normally when you follow the operating instructions. Adjust only those controls that are covered by the operating instructions; improper adjustment of other controls may cause damage and will often require extensive work by a qualified technician to restore the projector to normal operation.
  - E. If the projector has been dropped or the cabinet has been damaged.
  - F. When the projector exhibits a distinct change in performance – (this indicates a need for service).
18. Upon completion of any service or repairs to the projector, ask the service technician to perform a routine safety check to check that the projector is in safe operating condition.
19. When replacement parts are required, be sure the service technician has used replacement parts specified by the manufacturer that have the same characteristics as the original parts. Unauthorized substitutions may result in fire, electric shock, or other hazards.
20. It is recommended to clean the air filter after every 100 lamp hours. The projector may become too hot if the filter is not cleaned when required.
21. If the lens becomes dirty or smudged, clean it with a clean, dampened cloth. Never touch the lens with your fingers.
22. Do not look directly into the aperture and lens while operating the projector as this may damage your eyes.

# 4. PROJECTOR FEATURES

## 1. Fully compatible with PC and MAC

The Philips Limesco solution enables perfect interfacing with all sorts of PC and MAC standards. Optimum picture quality is guaranteed in all modes. The projector will adapt automatically to the proper data source. Signals from PC and MAC compatible computers will be accepted without additional hardware.

## 2. High reliability and excellent brightness

The Philips UHP lamp guarantees long life, excellent brightness over the lamp's lifetime and excellent colour reproduction. Furthermore, the projector has an excellent uniformity of brightness over the whole screen.

## 3. Excellent video quality

The Philips line doubling technology ensures excellent video quality. The projector accepts the input signal of all major video formats, including PAL, SECAM, NTSC and the higher quality S-Video signals. The projector will recognize these standards and adapt to them automatically.

## 4. Very easy to install and operate

The **OSD** (On Screen Display: information screens and menus) in 6 languages provides you with additional information to help you make the right choices about installation and operation, and to perform the correct actions.

The standard OSD language is English. In addition you can select French, Spanish, German, Italian and Portuguese.

The sensor of the ergonomic, wireless **Remote Control** allows you to operate both your computer as well as your projector from almost anywhere in the room. The **trackball** on the remote control and the **directional shuttle** on the projector function as **Cursor Control** and are used to manipulate the mouse cursor on the connected computer as long as the menu is not active. When the menu is active the Cursor Control controls the menu cursor.

The remote and local keyboard provides direct access buttons for those functions that are most often used during presentations:

### Source selection buttons

With the VIDEO and DATA buttons you can directly select the required source: S-video, video or Data.

### Standby/On/Off

Switches the projector in the Power Standby mode.

### Mute

Mutes the sound of the projector (or an externally connected sound amplifier).

### A/V (Audio/Video) Mute

Blanks out the screen and mutes the sound of the projector (or an externally connected sound amplifier).

### - VOLUME +

For adjusting the volume.

### Further functions which can be addressed via the menu are:

#### PP-save

This feature allows you to save sound and picture settings as a Personal Preference.

#### PP-recall

This feature allows you to recall the saved sound and picture settings (Personal Preference) as well as the factory presets.

#### White point

Using the 'white point' feature you can change the overall picture impression from warm white to cool white.

## 5. Stereo Audio Output

Line output for connecting external audio equipment.

## 6. Adjustable Screen Capability

The diagonal picture size of the display can be set from 21" (0.53 m) to 262" (6.6 m).

## 7. Ceiling Mount and Rear Screen projection

The projector is equipped with a full mirror scan conversion function ('vertical/horizontal mirror'), which allows the image to be reversed for ceiling mount as well as for rear projection applications.

## 8. Compact and lightweight

Completely portable, you can give attractive presentations at any location by connecting the projector to a notebook, video source etc.

## 9. PC Control Interface

This projector is equipped with PC Control Interface functionality. By connecting the PC to the serial port of the projector (by means of an optional cable), this feature allows the control of the projector by a computer or a dedicated environment control system.

## 10. External monitor connection

A separate external monitor (or a second projector) can be connected to the projector. The image projected is simultaneously shown on the monitor.

## 11. Coffee Break Counter

The Coffee Break Counter is a meeting productivity tool which, when activated, will project a countdown clock during a break in a meeting. This feature helps keep meetings on-time and efficient, making the most of your valuable time.

**CONTROLS (fig. 1 and 2)****On projector and remote control****① Cursor Control**

For manipulating the mouse cursor on the connected computer as long as the menu is not active. When the menu is active the Cursor Control controls the menu cursor. The cursor control, by means of the local keyboard, works with up/down and left/right button operation.

**Notes:**

- The Cursor Control only functions when the Mouse socket of the projector is connected to the serial port of a PC or the ADB terminal of an Apple Macintosh computer.
- Installation of dedicated RC mouse driver software on the computer used is necessary.
- A cursor control requires the presence of data signal.
- The computer in use needs to be reset before the projector is detected.

**② MENU**

For activating and deactivating the menu.

**③ OK (projector) and – / – – (remote control)**

For action confirmation in the menu when the menu is on screen. When the menu is not on screen the – / – – buttons on the remote control function as the Left and Right mouse buttons of your PC.

**④ Source selection buttons**

**VIDEO** – For selecting the video signal or S-video signal as the current projection source.

The button toggles between video and S-video signal.

**DATA** – For selecting the DATA signal as the current projection source.

**⑤ MUTE**

For muting the sound of the projector (or an externally connected sound amplifier).

**⑥ STANDBY/ON/OFF**

For switching the projector in the power standby mode.

**⑦ A(audio)/V(video)-MUTE**

For muting the sound of the projector (or an externally connected sound amplifier) and for muting the picture.

**⑧ – VOLUME +**

For adjusting the volume.

**On projector only****⑨ Indicators****Lamp indicator**

- Flashes green when the lamp is starting up.
- Lights up green when the lamp is on.
- Flashes orange when the remaining lamp life is less than 100 hours.
- Lights up orange when the lamp life is expired.
- Lights up red when
  - the temperature, measured in the set, is too high, or
  - lamp start has failed.

**Remote Control indicator**

Flashes green when the remote control is operated and the projector responds to this operation.

**⑩ ZOOM ring**

For adjusting the size of the projected image.

**⑪ FOCUS ring**

For adjusting the focus of the projected image.

**⑫ Horizontal adjusters**

For adjusting or correcting a possible oblique displayed picture.

**⑬ Lock slit**

For inserting an optional locking device (Kensington lock).

**⑭ IR sensor**

Receive the signals from the remote control.

**⑮ Dust filter****⑯ Lens cap****⑰ HEIGHT/LEVEL adjuster**

For adjusting the vertical angle of the projector.

**On remote control only****⑱ On/off button**

For switching the remote control on and off.

**Note:** The remote control will always use some power, even when not in use. Therefore always switch off the remote control after use.

**⑲ Light button**

For switching on the button illumination

The back-light will switch off automatically after 5 seconds.

**CONNECTIONS (fig. 3)****Data source connections****a MOUSE**

In-/output socket for connecting to:

- the serial port of a PC;
- the ADB terminal of an Apple Macintosh computer;
- an optional RS-232C cable for external PC control.

**b DATA IN**

Input socket for connecting to the DATA OUT terminal of a computer.

**c AUDIO IN**

Input socket for connection to the AUDIO OUT socket of a computer.

**g AUDIO OUT (audio output connection)**

Output socket for connecting to the Line Input sockets of an amplifier or stereo system.

**Video source connections****d S-VIDEO IN**

Input socket for connecting to the S-VIDEO OUT socket of a S-VHS video recorder, a VCR, Laser Disc player, video camera or TV with AV output socket.

**e VIDEO IN**

Input socket for connecting to the VIDEO OUT socket of a video recorder, Laser Disc player, video camera or TV with AV output socket (PAL, NTSC, SECAM).

**f AUDIO IN L/R**

Input sockets for connection to the AUDIO OUT sockets of a video recorder (S-VHS, PAL, NTSC, SECAM).

**g AUDIO OUT (audio output connection)**

Output socket for connecting to the Line Input sockets of an amplifier or stereo system.

**Other connections****h POWER**

For connecting the projector to the mains.

## 6. SET UP

### POSITIONING THE PROJECTOR AND SCREEN

- Place the projector on a stable, level surface, out of direct sunlight and away from sources of excessive dust, dirt, heat, water, moisture, vibration and strong magnetic fields. Face the projector towards the screen for the best picture results. To determine the distance for the desired size, please refer to the Projection Assistant, a calculation programme included on the CD-ROM.

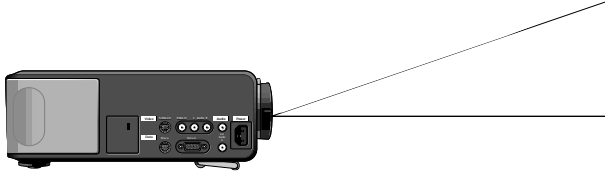

- The screen should be positioned so that it is not directly touched by sunlight or artificial light, as this will wash out the colours of the picture, making it hard to see.
- The projector can be used for both front projection, rear projection and ceiling projection applications. As default factory setting, the projector has been set up for front projection. You can change to rear or ceiling projection via the OSD menu. See 'Rear screen projection' and 'Upside-down (ceiling) projection' under 'Other settings' for further instructions.
- Choose a screen size suitable for the number of viewers and the size of the room.
- Picture quality is best when you sit directly in front of the projector screen.

### MAINS SUPPLY

- Insert the mains lead into the projector's POWER socket and connect it to the wall socket.

**Note:** The standby indicator lights up red, the projector is now in the Power/Standby mode.

- Remove the lens cap.



- Press the STANDBY ON/OFF button to switch on the projector.
  - The lamp indicator flashes green and the start-up screen appears for 5 seconds.
  - When the projection lamp is on, the lamp indicator lights up green.
  - The start-up position of the projector depends on when the projector has been switched off before. The factory default position is Power/Standby.
- To switch off the mains supply completely, pull the mains plug out of the wall socket.



**Note:** Before disconnecting the mains lead, make sure that the cooling fan has stopped (about 3 minutes after the projector has been switched to Power Standby).

### ADJUSTING THE FOCUS AND SIZE OF THE IMAGE

- Use the ZOOM ring to adjust the size of the image.
- Use the FOCUS ring to adjust the focus of the image.



### ADJUSTING THE VERTICAL AND HORIZONTAL ANGLE OF THE PROJECTOR

#### Vertical angle

- Use the Height/Level Adjuster to adjust the vertical angle of the projector as specified under 'Positioning the projector and screen'.

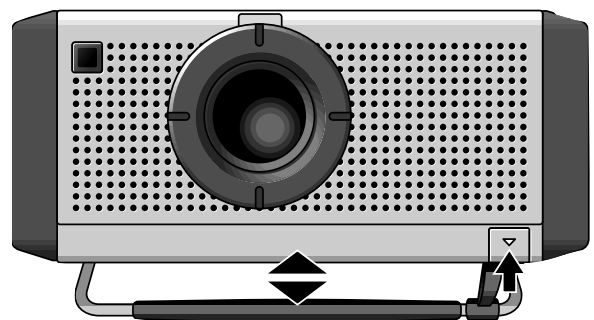

**To Raise:** press the adjuster carefully and lift to raise the projector.

**To Lower:** press the adjuster carefully again to lower the projector.

- Use the FOCUS Ring and ZOOM Ring to readjust the focus and size of the image.



**Horizontal angle (horizon)**

- Adjust or correct a possible oblique displayed picture by turning the horizontal adjusters to the desired position.



**Up:** turn the adjuster(s) to the left.

**Down:** turn the adjuster(s) to the right.

- Use the FOCUS Ring and ZOOM Ring to readjust the focus and size of the image.

**Notes:**

- When adjustments are not properly made, the picture may become distorted, depending on the relative positions of the projector and the screen.
- If the projector and the screen are not properly placed, the picture will be distorted, producing a keystone image as shown at right.

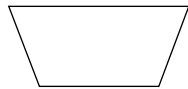
**Keystoned Image****CAUTION!**

When all required adjustments have been made, switch off the projector before making any other connections (see 'Installation').

**MOVING THE PROJECTOR**

- Press the STANDBY/ON/OFF button to switch off the projector. The standby indicator lights up red.
- Wait until the cooling fan has stopped (about 3 minutes after the projector has been switched off) and disconnect the mains lead and all other cables.
- Make sure the lens is turned back in to prevent damage to the lens.
- Put the lens cap back in place to prevent dust, dirt or other contamination from harming or damaging the front of the projector lens when moving the projector.

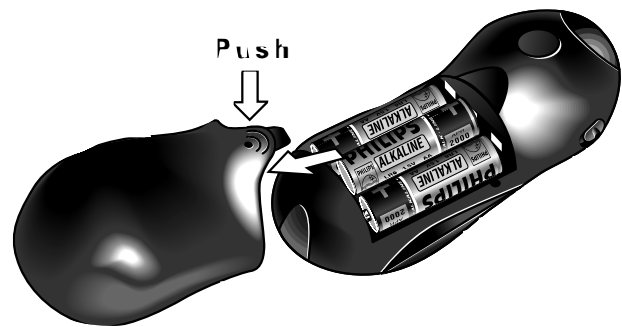

**Note:** Never place the projector on the side where the connections are located.

**INSERTING THE BATTERIES IN THE REMOTE CONTROL**







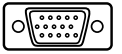

- Push and slide the lid in the direction of the arrow.
- Install three 'AA' batteries as indicated inside the battery compartment.
- Replace the lid and snap into place.

**Caution:** Do not mix old and new batteries (also never mix alkaline and manganese batteries).

**Note:** The maximum range of the remote control is 20 m ( $\pm$  65 feet).

### VIDEO/COMPUTER CABLES AND ADAPTOR

These accessories are supplied for connecting the projector to computer/AV equipment. The numbers in the left-hand column correspond with the numbers in the connection diagrams on the following pages.

No.	CABLE/ADAPTOR	CONNECTIONS		LENGTH
		Projector side	Computer/AV products side	
1	VGA Cable	D-Sub M 15P (male) 	 D-Sub M 15P (male)	2.0 m
2	Video/Audio Stereo RCA Cable	RCA pin (male) x 3 	 RCA pin (male) x 3	2.0 m
3	Scart/RCA-AV Adaptor			--
4	Mouse cable 8-mini Din to RS232	Mini Din 8P (male) 	 D-Sub M 9P (female)	2.0 m
5	Mouse cable 8-mini Din to ADB	Mini Din 8P (male) 	 Mini Din 4P (male)	2.0 m

**Optional cables and adaptor:** – Audio cable for PC/MAC computers

- S-video cable
- Audio RCA cable
- Programmable VGA MAC adaptor
- VGA Y-cable for external monitor: D-Sub M 15P (male) to D-Sub M 15P (female)
- RS-232C cable for external projector control: 8 Mini Din (male) to 9 D-Sub (female).

## CONNECTING TO A COMPUTER

### General

- **Caution:** Always switch off the projector before making any connections!
- The data input is suitable for both Apple Macintosh computers (Power Book and Power Mac) as well as for IBM compatible PCs.
- The data output of IBM compatible PCs can be connected directly to the projector using standard data cables.  
Apple Macintosh computers may need a conversion plug (optional) added to the standard data cable.
- The figures in brackets **(1)** correspond to the figures in the diagram on page 10.  
The characters in brackets **(a)** correspond to the characters in **fig. 2** on page 3.

### PC (Desk Top/Lap Top)

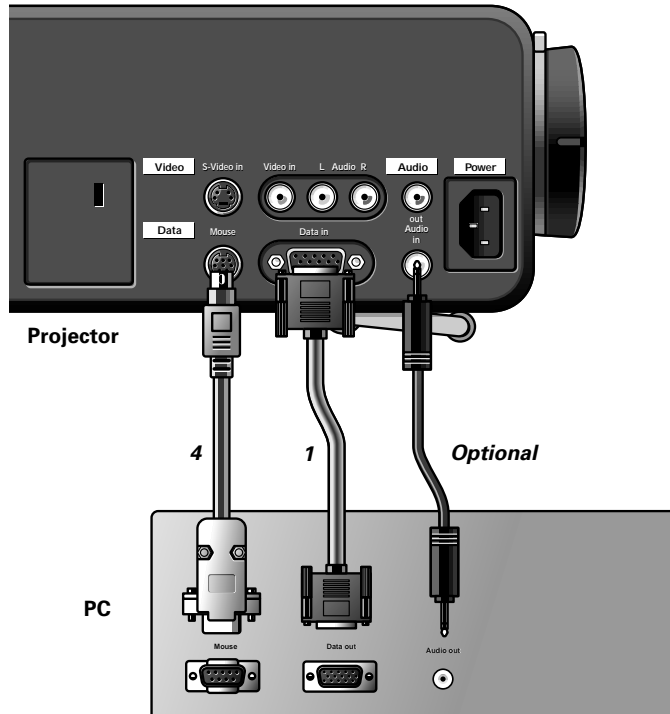

1. Connect the DATA OUT terminal of the computer to the DATA terminal **(b)** of the projector and secure the plugs by tightening the thumb screws.  
For this, use the VGA cable **(1)** supplied.
  2. Connect the serial port of the computer to the MOUSE terminal **(a)** of the projector.  
For this, use the mouse cable **(4)** supplied.
- You can now manipulate the mouse cursor on the computer and on the screen, using Cursor Control.
3. If you wish to use audio, connect the AUDIO OUT socket of the computer to the AUDIO IN socket **(c)** of the projector.  
For this, use an optional audio cable.

#### Notes:

- If the mouse cursor does not react when moving the **track ball** on the remote control:
    - check that the Remote Control indicator on the projector flashes green when you move the trackball.
    - **If it does not:** Check that you have switched on the remote control. If you have, check that the batteries are installed properly and/or replace the batteries.
    - **If it does:** Install the proper remote control software on your computer as described in the chapter 'Additional information'.
  - If the mouse cursor does not react when moving the **directional shuttle** on the projector:
    - Install the proper remote control software on your computer as described in the chapter 'Additional information'.
  - **For computers with a PS2 mouse port:**  
The projector does not support the PS2 mouse protocol. To operate the mouse function:
    - connect the projector to the serial port of the computer as indicated above.
    - Install the proper remote control software on your computer as described in the chapter 'Additional information'.
- Sometimes your computer will require that the serial port is enabled separately. Please check the documentation of your computer for details.

### MACINTOSH (Desk Top/Power Book/Power Mac)

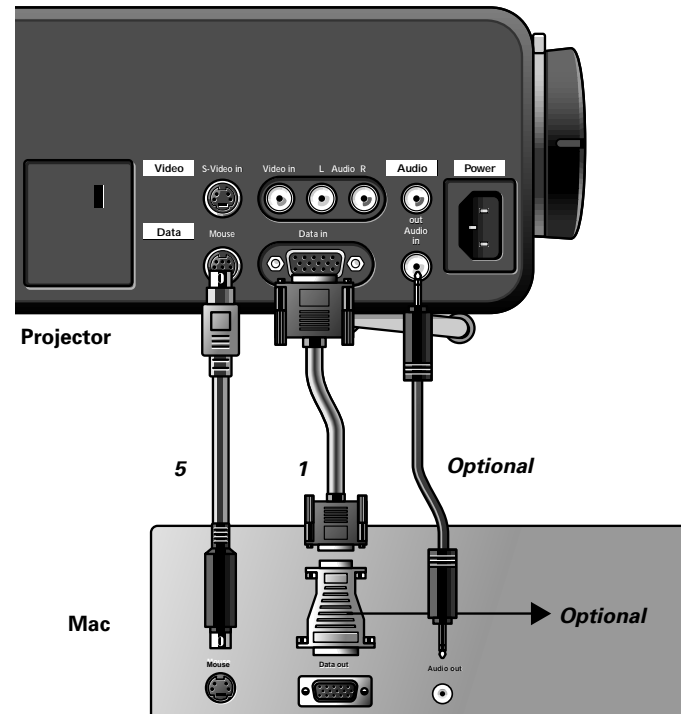

1. Connect the DATA OUT terminal of the computer to the DATA IN terminal **(b)** of the projector and secure the plugs by tightening the thumb screws.  
For this, use the VGA cable **(1)** supplied.
  2. Connect the ADB port of the computer to the MOUSE terminal **(a)** of the projector.  
For this, use the mouse cable **(5)** supplied.
- You can now manipulate the mouse cursor on the computer and on the screen, using Cursor Control.
3. If you wish to use audio, connect the AUDIO OUT socket of the computer to the AUDIO IN socket **(c)** of the projector.  
For this, use an optional audio cable.

#### Notes:

- For older versions of Apple Macintosh computers an optional VGA/MAC adaptor may be needed. In this case:
  - Connect the optional VGA/MAC adaptor to the DATA OUT terminal of the computer and secure the plugs by tightening the thumb screws.
  - Select the required resolution for your monitor in the diagram on the back of the adaptor and adjust the dipswitches accordingly.
  - Plug the VGA cable **(1)** supplied into both the adaptor and the DATA IN terminal **(b)** of the projector and secure the plugs by tightening the thumb screws.
  - Proceed with step **2.** (see above).
- If the mouse cursor does not react when moving the **track ball** on the remote control:
  - Check that the Remote Control indicator on the projector flashes green when you move the trackball.
  - **If not:** Check that you have switched on the remote control. If you have, check if the batteries are installed properly and/or replace the batteries.

### CONNECTING TO VIDEO EQUIPMENT

#### General

- The figures in brackets **(1)** correspond to the figures in the diagram on page 10.
- The characters in brackets **(a)** correspond to characters in **fig. 2** on page 3.
- **Caution:** Always switch off the projector before making any connections.

#### PAL, NTSC, SECAM

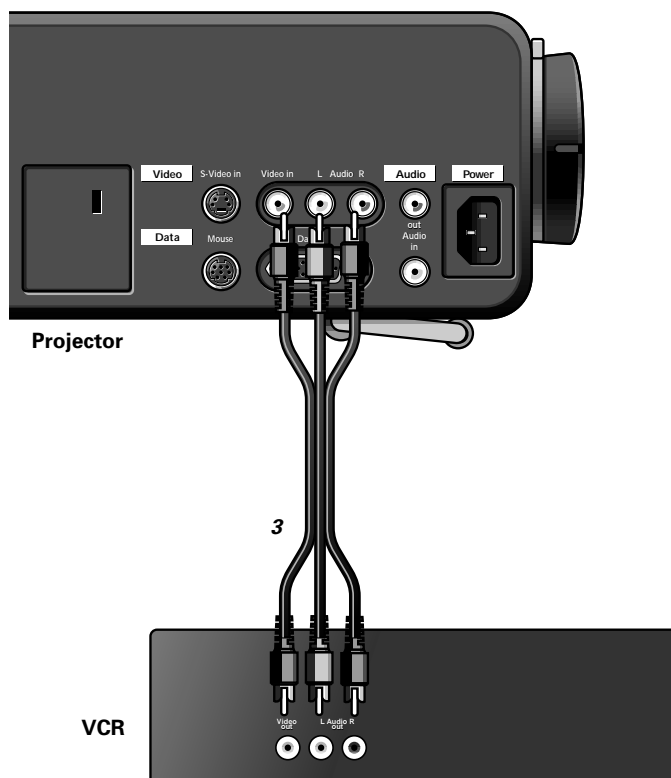

1. Connect the VIDEO OUT socket of a VCR, Laser Disc player, video camera or TV to the VIDEO IN socket **(e)** of the projector.  
For this, use the video/audio connection cable **(2)** supplied.
2. Connect the AUDIO OUT L/R sockets of the VCR, Laser Disc player, video camera or TV to the AUDIO L/R sockets **(f)** of the projector.  
For this, use video/audio connection cable **(2)** supplied.  
Insert the white plug into the L socket and the red plug into the R socket.

#### In case your VCR, Laser Disc player, video camera or TV is equipped with a Scart connector:

1. Connect the Scart/RCA Audio Video adaptor **(3)** supplied to the Scart connector of the VCR, Laser Disc player, video camera or TV.
2. Plug the video/audio connection cable **(2)** supplied into both the adaptor and the VIDEO IN **(e)** and AUDIO L/R sockets **(f)** of the projector.

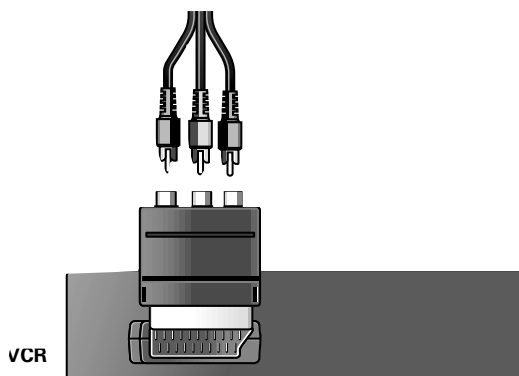

#### S-VHS

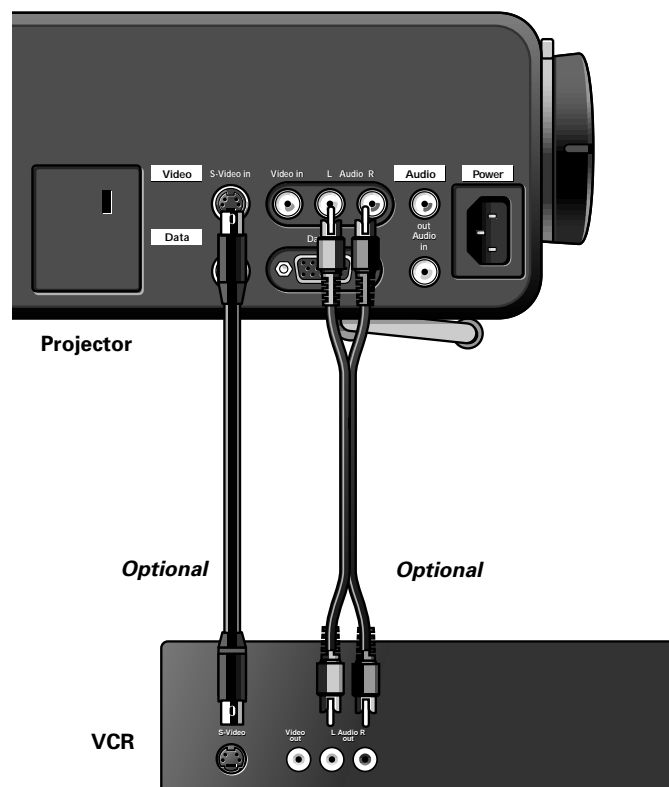

1. Connect the S-VIDEO OUT socket of a S-VHS video recorder, Laser Disc player, video camera or TV to the S-VIDEO IN socket **(d)** of the projector.  
For this use an *optional* S-video connection cable.
2. Connect the AUDIO OUT L/R sockets of the S-VHS video recorder, Laser Disc player, video camera or TV to the AUDIO L/R sockets **(f)** of the projector.  
For this, use an *optional* audio connection cable.  
Insert the white plug into the L socket and the red plug into the R socket.

#### In case your VCR, Laser Disc player, video camera or TV is equipped with a Scart connector:

1. Connect the Scart/RCA Audio Video adaptor **(3)** supplied to the Scart connector of the VCR, Laser Disc player, video camera or TV.
2. Plug an *optional* audio connection cable or the video/audio connection cable supplied into both the adaptor and the AUDIO L/R sockets **(f)** of the projector.  
Insert the white plug into the L socket and the red plug into the R socket.
3. Plug an *optional* S-Video connection cable into the VCR and the S-VIDEO in socket **(d)** of the projector.

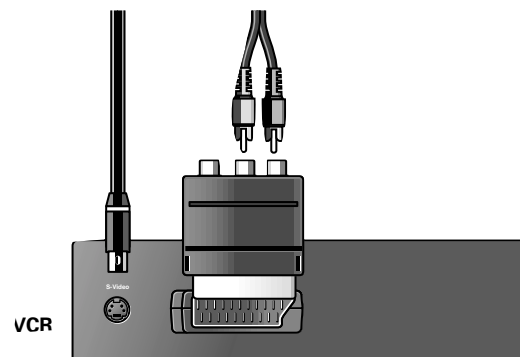

## CONNECTING TO AUDIO EQUIPMENT

### General

- The figures in brackets **(1)** correspond to the figures in the diagram on page 10.
- The characters in brackets **(a)** correspond to characters in **fig. 2** on page 3.
- **Caution:** Always switch off the projector before making any connections.

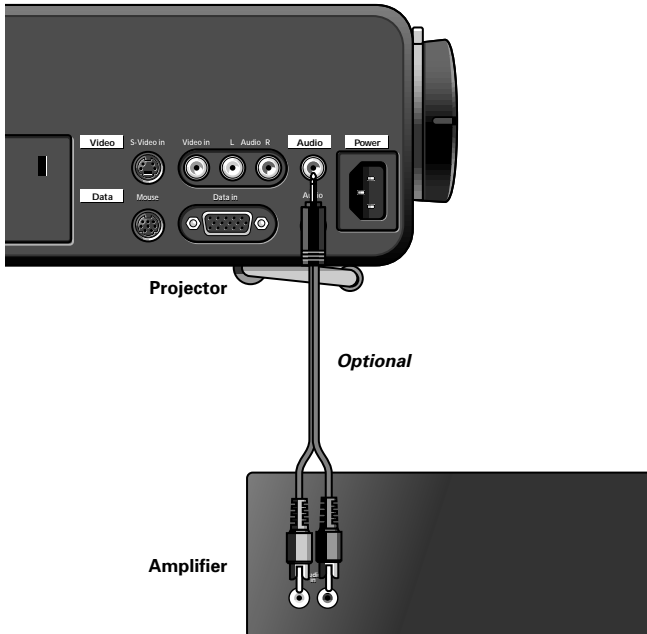

- Connect the AUDIO IN L/R sockets of an amplifier or stereo system to the AUDIO OUT socket **(g)** of the projector. For this, use an *(optional)* audio connection cable. Insert the white plug into the L socket and the red plug into the R socket.

**Note:** When the projector is connected to an external audio amplifier, you cannot control the volume via the projector or the remote control. However, the sound can still be muted via the projector or the remote control.

## CONNECTING TO AN EXTERNAL MONITOR

### General

- The characters in brackets **(a)** correspond to characters in **fig. 2** on page 3.
- **Caution:** Always switch off PC, external monitor and projector before making any connections.

1. Connect the single end of the optional (VGA) Y-cable to the data in socket **(b)** of your projector.
2. Connect the VGA cable between the PC and one of the free Y-cable connectors.
3. Connect the last Y-cable connector to the VGA cable of the monitor.
4. Switch on your PC.
5. Switch on the projector.
6. Press DATA to select data input.
  - DATA appears on the screen.
7. Press MENU.
  - The menu bar appears on the screen.

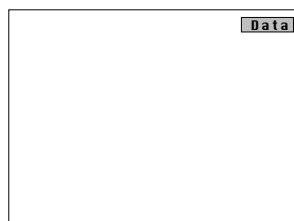

8. Use Cursor Control to select SOURCE in the menu bar.
  - DATA is highlighted.

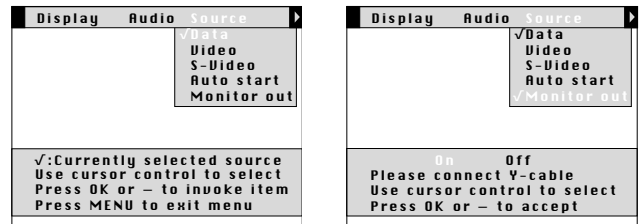

9. Use Cursor Control to select MONITOR OUT.
10. Press OK **(-/- -)** to activate the MONITOR OUT item.
11. Use Cursor Control to select ON.
12. Press OK **(-/- -)** to activate.
  - The projector will indicate the necessity to connect the Y-cable.
13. Switch on the external monitor.

To obtain the audio signal on the monitor instead of on the projector:

- Connect the AUDIO IN sockets of the monitor to the AUDIO OUT socket **(g)** of the projector. Insert the white plug of the *(optional)* audio connection cable into the L socket and the red plug into the R socket. Some monitors have a single AUDIO IN socket for which a different audio connection cable with a 3,5 mm mini jack is required.

### Notes:

- One external monitor or projector can be connected at a time.
- For further details on the operation with On Screen Displays see chapter '8 OPERATION'.

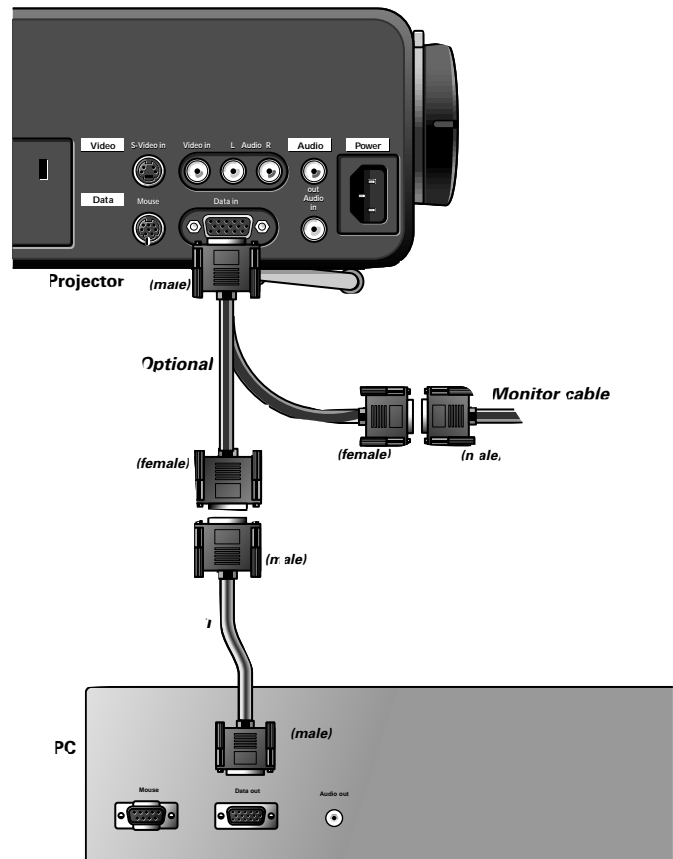

## PREPARATION

### General

- Press the STANDBY/ON/OFF button to switch on the projector.
  - The lamp indicator flashes green and the start up screen appears for 5 seconds.
  - When operation time reaches 3901 hours, the message 'WARNING: Lamplife expires in 99 hours' will be displayed on the screen when switching the projector on. For this refer to the chapter 'Lamp' under 'Additional information'.
  - When the lamp is on, the lamp indicator lights up green.
- Set the ON/OFF switch of the remote control to ON in order to switch on the remote control.



**Note:** Always switch off the remote control after use.

- If required, press the light button of the remote control.
  - When this button is pressed the button illumination is switched on for 5 seconds. Every time one of the buttons is pressed within these 5 seconds, the illumination time is extended (by a further 5 seconds).

- Select the required source (Video, S-Video or Data) by pressing the corresponding source selection button.

**Note:** The source selection button VIDEO toggles between Video and S-video.

- Switch on the computer or start video playback.
  - The following messages may appear on the screen when selecting a source:

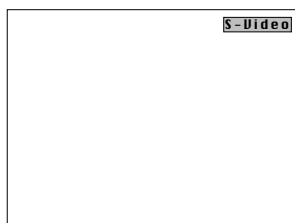

S-Video selected as source.

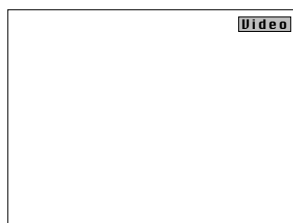

Video selected as source.

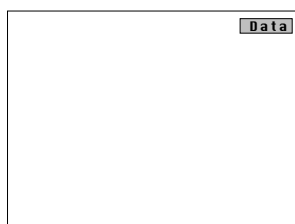

Data selected as source.

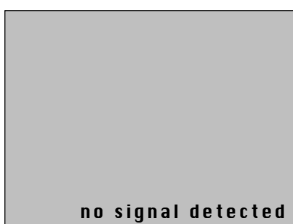

No input signal.

### On Screen Display menu - General explanation

All video and data adjustments and settings (except A/V Mute) are done via On Screen Displays and with help of the following controls:

MENU, OK (–/–) and Cursor Control on the projector or the remote control.

- Press MENU.
  - The menu bar appears on the screen. The first item is highlighted and its sub menu is shown.

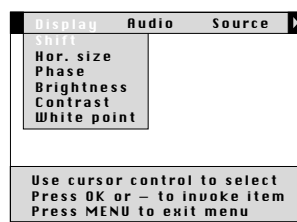

- Use Cursor Control to move the cursor to any other item in the menu bar.
  - When the cursor is moved to < or >, the menu bar will scroll to the left or the right.

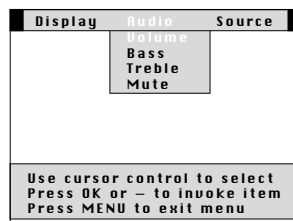

- Select the sub menu item to be adjusted using Cursor Control.
- Press OK (–/–) to activate the item.
- Adjust the selected item in the action window at the bottom of the screen, using Cursor Control.

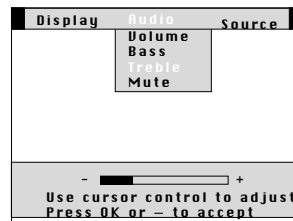

- Press OK (–/–) to confirm and store the adjustment.
- Select the next item to be adjusted in the sub menu and adjust as described above.
- Pressing MENU will also confirm and store the adjustment. In this case the On Screen Display will be closed.

### Language selection

The projector can display menus in one of six different languages.

- Press MENU.
  - The menu bar appears on the screen.
- Use Cursor Control to select MISC(ellaneous) in the menu bar.
- Use Cursor Control to select LANGUAGE from the sub menu.

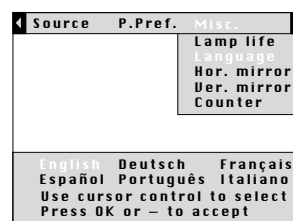
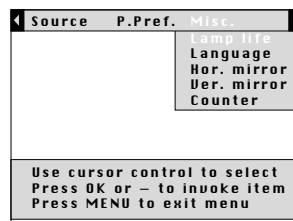

- Press OK (–/–) to activate the LANGUAGE item.
- Use Cursor Control to select the required language in the action window.
- Press OK (–/–) to confirm and store the selected language.
- If required, select the next item to be adjusted or press MENU to exit.

### PICTURE CONTROL

- The projector's picture is set to standard specifications at the factory. However, you can adjust the image to suit your own preferences by using the VIDEO or DATA ADJUST feature. The projector will store the last used settings for every source. So when you switch from one source to another, the settings of the source switched from will be stored and the settings of the source switched to will be recalled. When the projector is switched off and on again the settings for the selected source will be recalled again.
- Three memory modes allow you to adjust and save up to three sets of settings (see 'Personal Preferences').

### Data display adjustments

- For data signal input, the following adjustments can be made:
- **shift** - adjusts the computer image in horizontal and vertical direction to centre it on the screen;
  - **horizontal size** - adjusts the computer image in a horizontal direction to make the image completely fill the screen;
  - **phase** - when connecting the projector to your PC for the first time, be sure to adjust the phase control for optimal readability of the projected text;
  - **brightness** - adjusts the black level to the room brightness;
  - **contrast** - adjusts the overall contrast intensity;
  - **white point** - adjusts the overall picture impression from warm white to cool white.

#### Tip for Windows users:

To adjust horizontal size and phase correctly:

1. Select 'Start' and then 'Shut down'.
2. Adjust the projectors horizontal size control, so that no vertical bars are visible.
3. Now adjust the projectors phase control for optimal readability.
4. Press 'No' in the Windows shutdown screen to cancel the shutdown action.

1. Press DATA to select data input.
- DATA appears on the screen.

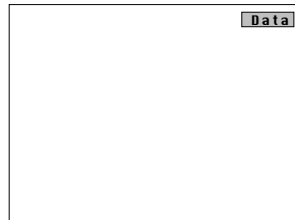

2. Press MENU.
- The menu bar appears on the screen; DISPLAY is highlighted and its sub menu is shown.
3. Use Cursor Control to select the item to be adjusted.

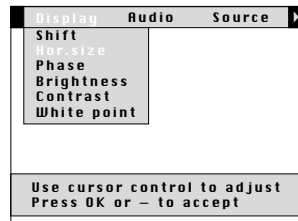
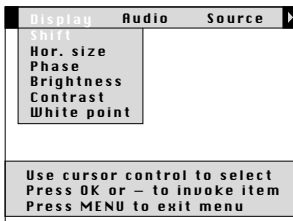

4. Press OK (←/→) to activate the selected item.
5. Use Cursor Control to make the required adjustment in the action window.
6. Press OK (←/→) to confirm and store the adjustment.
7. If required, select the next item to be adjusted or press MENU to exit.

#### Notes:

- When you have selected the menu mode, you cannot use the source selection buttons on the projector or on the remote control to select another input. You can only change to another input via the SOURCE menu.
- **A(audio)/V(video)-mute** can only be selected with the A/V MUTE button on the projector or on the remote control. A/V mute then appears on the screen.



### Data mode selection

When set to AUTO, the projector can automatically identify the signal type of the connected computer. However, if the signal does not match the known computer signal standards, automatic identification can be overruled. The required data mode can then be selected as described below:

1. Select Data.
  2. Press MENU.
  3. Use Cursor Control to select SOURCE in the menu bar.
- DATA is highlighted.



4. Press OK (←/→) to activate the DATA item.
5. Use Cursor Control to select the required data mode in the action window.
6. Press OK (←/→) to confirm and store the adjustment.
7. If required, select another item you wish to adjust or press MENU to exit.

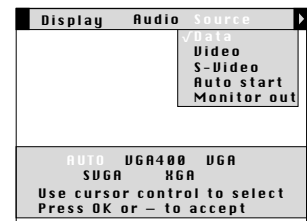

### Video display adjustments

For video signal input, the following adjustments can be made:

- **brightness** - adjusts the black level to the room brightness;
- **contrast** - adjusts the overall contrast intensity;
- **saturation** - adjusts the colour saturation of the projected image;
- **hue** (only for NTSC) - adjusts the tint of the projected image;
- **white point** - adjusts the overall picture impression from warm white to cool white.

1. Press VIDEO to select video signal or S-video signal as the current projection source.
- The button toggles between video and S-video signal.
  - VIDEO or S-VIDEO appears on the screen.

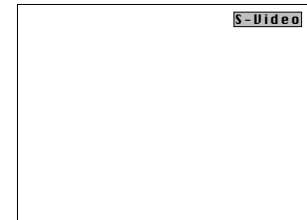
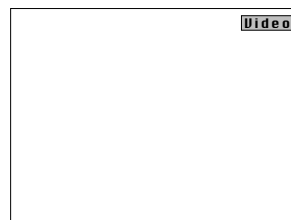

2. Press MENU.
- The menu bar appears on the screen; DISPLAY is highlighted and its sub menu is shown.
3. Use Cursor Control to select the item to be adjusted.

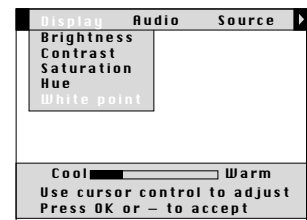
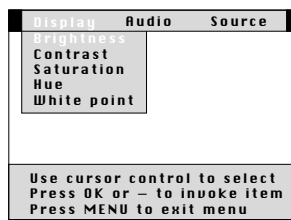

4. Press OK (←/→) to activate the selected item.
5. Use Cursor Control to make the required adjustment in the action window.

6. Press OK (–/– →) to confirm and store the adjustment.
7. If required, select the next item to be adjusted or press MENU to exit.

**Notes:**

- When you have selected the menu mode, you cannot use the source selection buttons on the projector or on the remote control to select another input. You can only change to another input via the SOURCE menu.
- **A(audio)/V(video)-mute** can only be selected with the AV MUTE button on the projector or on the remote control. AV mute then appears on the screen.



**Video system selection**

The Projector is equipped with full NTSC, PAL and SECAM video support. When set to AUTO, the broadcast format is automatically switched according to the video standard connected. If you experience poor colour however, you may have to set to NTSC, PAL, or SECAM as described below.

1. Press VIDEO to select video signal or S-video signal as the current projection source.  
The button toggles between video and S-video signal.
- VIDEO or S-VIDEO appears on the screen.

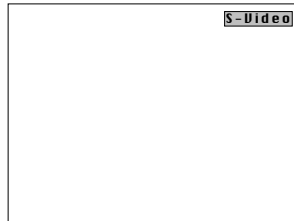
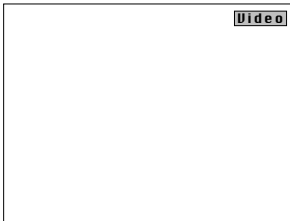

2. Press MENU.
- The menu bar appears on the screen.
3. Use Cursor Control to select SOURCE in the menu bar.
4. Use Cursor Control to select VIDEO or S-VIDEO from the sub menu.
5. Press OK (–/– →) to activate the VIDEO or S-VIDEO item.
6. Use Cursor Control to select the required video system in the action window: AUTO, PAL, SECAM or NTSC.
7. Press OK (–/– →) to confirm and store the selected video system.
8. If required, select another item you wish to adjust or press MENU to exit.

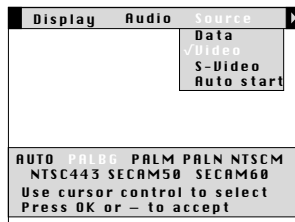

**AUDIO CONTROL**

The projector's sound is set to standard specifications at the factory. However, you can adjust the sound to suit your own preferences by using the SOUND CONTROL feature.

The following adjustments can be made:

- **volume** – adjusts the sound level;
- **bass** – adjusts the bass tones;
- **treble** – adjusts the high tones;
- **mute** – mutes the sound of the projector (or an externally connected loudspeaker);

1. Select the required input (Video, S-Video or Data).
2. Press MENU.
- The menu bar appears on the screen.
3. Use Cursor Control to select AUDIO in the menu bar.
4. Use Cursor Control to select the item to be adjusted.

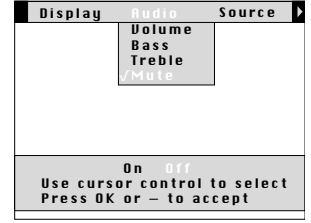
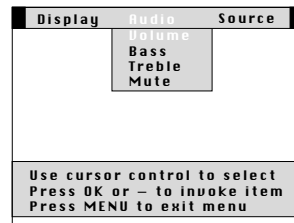

5. Press OK (–/– →) to activate the selected item.
6. Use Cursor Control to make the required adjustment in the action window.
7. Press OK (–/– →) to confirm and store the adjustment.
8. If required, select the next item to be adjusted or press MENU to exit.

**Notes:**

- The volume can also be adjusted with the – VOLUME + buttons on the projector or on the remote control.
- When the projector is connected to an amplifier or stereo system, the volume must be adjusted on the amplifier or stereo system.
- Mute can also be selected with the MUTE button on the projector or on the remote control. Mute then appears on the screen.
- **A(audio)/V(ideo)-mute** can only be selected with the AV MUTE button on the projector or on the remote control. AV mute then appears on the screen.



**PERSONAL PREFERENCES**

You can store up to three sets of settings. These settings can be called up at any time so you can use different sets of settings for different sources.

The following settings can be stored:

- vertical mirror
- audio volume
- bass
- horizontal mirror
- treble
- brightness
- white point
- contrast
- hue
- saturation
- AV source (Data/Video/S-Video)

**Storing Personal Preferences**

1. Select the required input (Video, S-Video or Data).
2. Make the required adjustments, as described under 'Picture Control' and 'Audio Control'.
3. Press MENU.
- The menu bar appears on the screen.
4. Use Cursor Control to select P. PREF (Personal Preferences) in the menu bar.
5. Use Cursor Control to select STORE from the submenu.



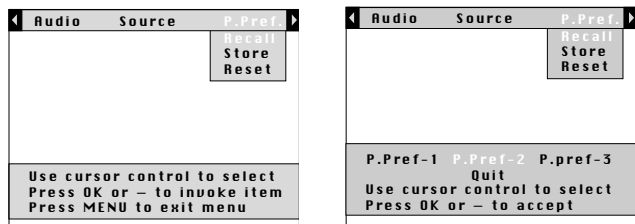

6. Press OK (–/– →) to activate the STORE item.
7. Use Cursor Control to select P. PREF 1, 2 or 3 in the action window.  
*Note: If you select Quit, you will exit the action window and your settings will not be stored in the P. Pref. memory*
8. Press OK (–/– →) to confirm and store the Personal Preferences.
9. If required, select another item you wish to adjust or press MENU to exit.

### Calling up Personal Preferences

1. Select the required input (Video, S-Video, Data).
2. Press MENU.  
– The menu bar appears on the screen.
3. Use Cursor Control to select P. Pref (Personal Preferences) in the menu bar.
4. Use Cursor Control to select RECALL from the submenu.

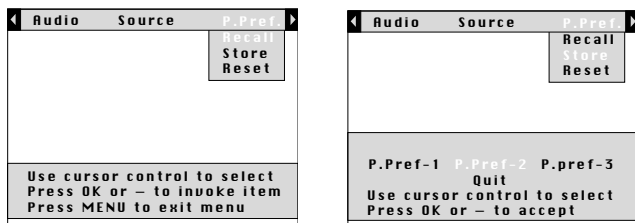

5. Press OK (–/– →) to activate the RECALL item.
6. Use Cursor Control to select the required Personal Preference (P. Pref 1, 2 or 3) in the action window.  
*Note: If you select Quit, you will exit the action window and your settings will not be stored in the P. Pref. memory*
7. Press OK (–/– →) to confirm and store the selection.
8. If required, select another item you wish to adjust or press MENU to exit.

### Changing Personal Preferences

1. Select the required input (Video, S-Video, Data).
2. Make the new adjustments, as described under 'Picture Control' and 'Audio Control'.
3. Press MENU.  
– The menu bar appears on the screen.
4. Use Cursor Control to select P(ersonal) PReF(erences) in the menu bar.
5. Use Cursor Control to select STORE from the submenu.

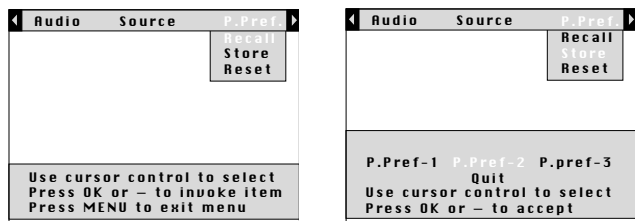

6. Press OK (–/– →) to activate the STORE item.
7. Use Cursor Control to select P. PREF 1, 2 or 3 in the action window.  
*Note: If you select Quit, you will exit the action window and your settings will not be stored in the P. Pref. memory.*

8. Press OK (–/– →) to confirm and store the new Personal Preferences.
9. If required, select another item you wish to adjust or press MENU to exit.

### Resetting to the factory set default settings

1. Select the required input (Video, S-video, Data).
2. Press MENU.  
– The menu bar appears on the screen.
3. Use Cursor Control to select P. PREF (Personal Preferences) in the menu bar.
4. Use Cursor Control to select RESET from the submenu.

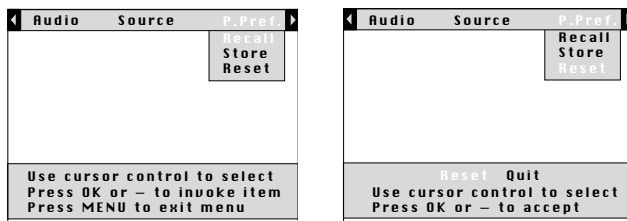

5. Press OK (–/– →) to activate the RESET item.
6. Use Cursor Control to select RESET if you wish to reset your Personal Preferences for the selected source to the factory set default settings.
7. Press OK (–/– →) to confirm and store the factory set default settings.
8. If required, select another item you wish to adjust or press MENU to exit.

*If you wish to keep the old settings after all:*

1. Use Cursor Control to select QUIT in the action window.
2. Press OK (–/– →) to confirm.
3. If required, select another item you wish to adjust or press MENU to exit.

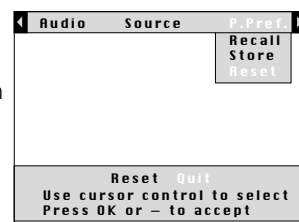

### OTHER SETTINGS

#### Default source selection

The Auto start command gives you the opportunity to define the input source with which your projector will start up.  
*For instance:* if you select Video as your default (Auto start) source, the projector will select Video as the source when the projector is switched on.

*Note: The factory set default for Auto start is Data.*

1. Press MENU.  
– The menu bar appears on the screen.
2. Use Cursor Control to select SOURCE in the menu bar.
3. Use Cursor Control to select AUTO START from the submenu.
4. Press OK (–/– →) to activate the AUTO START item.
5. Use Cursor Control to select the required default source in the action window (Data, Video or S-Video).
6. Press OK (–/– →) to confirm and store the default source.
7. If required, select another item you wish to adjust or press MENU to exit.

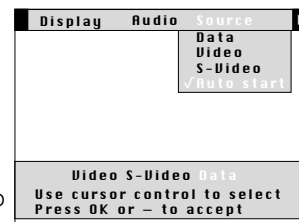

## Rear screen projection

The image can be flipped to a horizontal mirror image of the input signal for rear screen projection.

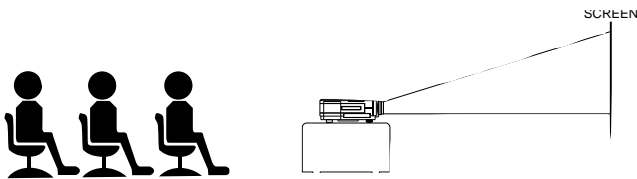

Front projection

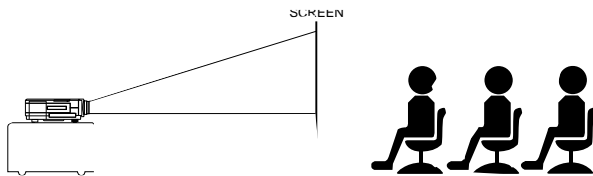

Rear projection

1. Press MENU.
  - The menu bar appears on the screen.
2. Use cursor control to select MISC(ellaneous) in the menu bar.
3. Use Cursor Control to select HOR.(horizontal) MIRROR from the sub menu.

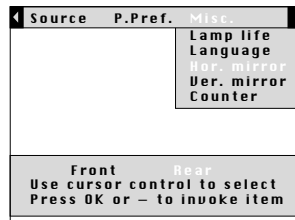
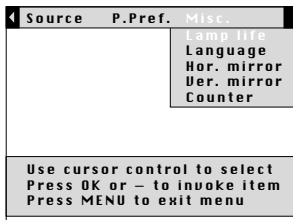

4. Press OK (–/–) to activate the HOR. MIRROR item.
5. Use Cursor Control to select REAR in the action window.
6. Press OK (–/–) to confirm and store the selection.
7. If required, select another item you wish to adjust or press MENU to exit.

## Upside-down (ceiling) projection

The projector is equipped with an upside-down scan function (vertical mirror), which allows the image to be flipped when the projector is mounted upside down to the ceiling.

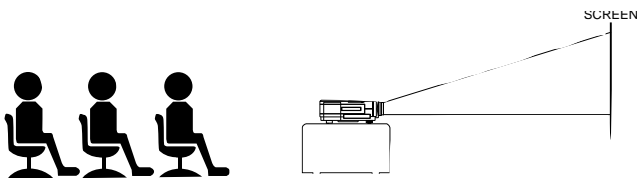
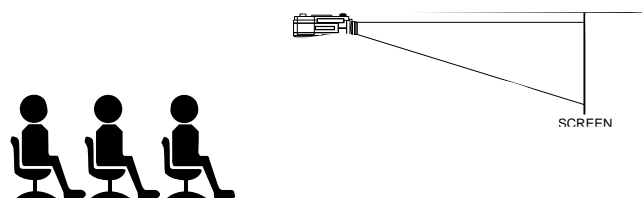
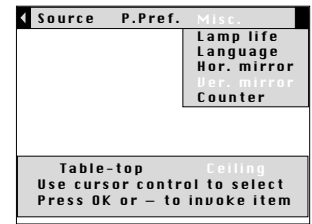
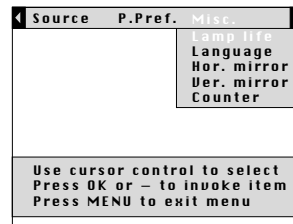

Table-top projection



Ceiling projection

1. Press MENU.
  - The menu bar appears on the screen.
2. Use Cursor Control to select MISC(ellaneous) in the menu bar.
3. Use Cursor Control to select VER.(vertical) MIRROR from the sub menu.



4. Press OK (–/–) to activate the VER. MIRROR item.
5. Use Cursor Control to select CEILING in the action window.
6. Press OK (–/–) to confirm and store the selection.
7. If required, select another item you wish to adjust or press MENU to exit.

## Coffee Break Counter

The Coffee Break Counter is a meeting productivity tool which, when activated, will project a countdown clock during a break in a meeting. This feature helps keep meetings on-time and efficient, making the most out of your valuable time.

1. Press MENU.
  - The menu bar appears on the screen.
2. Use Cursor Control to select MISC(ellaneous) in the menu bar.
3. Use Cursor Control to select COUNTER from the sub menu.

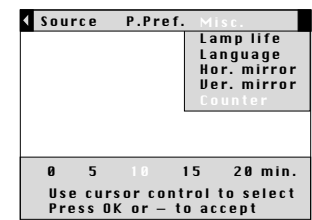
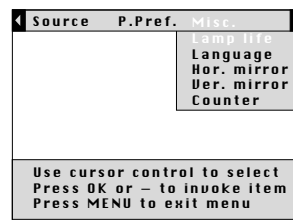

4. Use Cursor Control to select the desired countdown time (0, 5, 10, 15 or 20 minutes).
5. Press OK (–/–) to activate the countdown timer.
  - The time will be counted down on the screen.
  - Press any button to cancel the countdown timer.



## INSTALLING THE REMOTE CONTROL SOFTWARE

This chapter describes how to install and use your pointing device software. Installation is only necessary if the mouse cursor cannot be manipulated by the remote control Cursor Control, after making all necessary connections.

### For Macintosh users:

1. Turn off your computer and connect the supplied remote mouse cable (ADB) between the projector and the ADB port
2. Switch-on your computer; you can immediately operate your mouse via the Remote Control

### For PC users:

1. Turn off your PC and connect the supplied remote mouse cable (RS232) between the computer and the projector
2. Switch-on your PC; you can now operate your mouse via the remote control; *if not, please continue:*

*Please continue with the following instructions, if this is the first time that you use the Remote control mouse function with your PC.*

### For Windows users:

1. Double click on the remote control software file (ex. m83setup.exe)
2. Follow installation instructions.
3. Re-boot your computer.
  - A dialog box appears, asking to install a new hardware driver for a Logitech serial mouse.
4. Select the Windows default driver (click OK).
  - You should now be able to control your PC mouse via the remote control.

## RS-232C PC CONTROL INTERFACE SOFTWARE

The projector operation and settings can be remotely controlled by a computer or a dedicated environment control system, by connecting the controller to the serial port of the projector and using the RS-232C PC Control Interface.

This feature can, for instance, be useful in the following situations:

- dedicated conference environments, where lighting and sound conditions are controlled by a dedicated system,
- in situations where multiple projectors are used and the picture content or performance needs to be synchronised,
- in case the projector is mounted in a position where direct control or control via the infrared remote control is difficult.

*Please contact your dealer or local Philips representative for details.*

## CLEANING

**CAUTION:** Switch off and disconnect the projector before cleaning.

1. When the cabinet is dusty, clean it by gently wiping with a soft cloth.
2. A chamois leather slightly moistened with water is sufficient for cleaning the housing.
3. Do not use cleaning agents as they may harm the housing.

### Always keep the lens clean

1. When the lens is dirty or dusty, first blow the dust off and then gently wipe with a soft brush or lens cleaning paper. Never touch the lens with your fingers.
2. The lens is likely to become mouldy if left dirty.

## CLEANING THE DUST FILTER

1. Press the STANDBY ON/OFF button to switch off the projector.
  - The standby indicator lights up red.
2. Wait until the cooling fan has stopped (about 3 minutes after the projector has been switched off) and disconnect the mains lead and all other cables.
3. Turn the projector over. *Never place the projector on the side where the connections are located!*
4. Unscrew and remove both horizontal adjusters.
5. Unscrew the screws at the bottom of the cover and remove the cover.

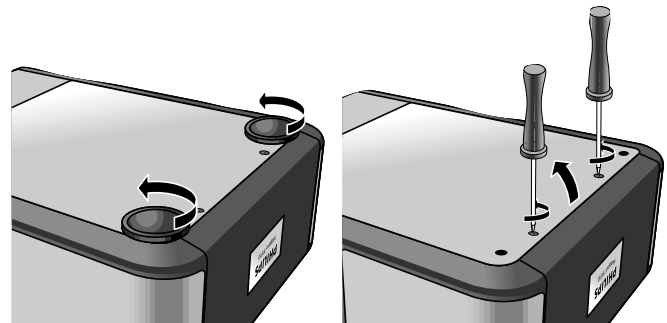

6. Remove the filter from its compartment.
  - Press both sides of the filter (**a**) until it comes loose from the clips (**b**).
  - Move the handle to the left (**c**).
  - Remove the handle from the catch and lift upwards (**d**).
  - Carefully lift the filter out of its compartment.

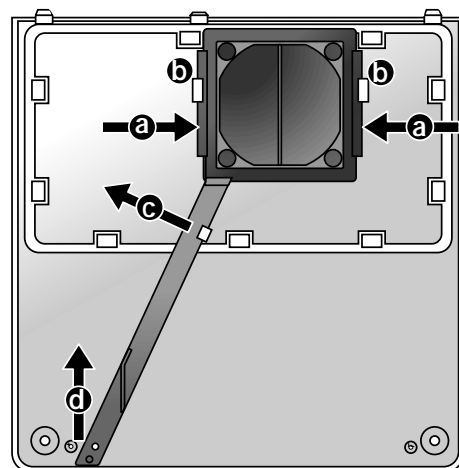

7. While firmly holding the filter, gently remove any accumulated dust with a vacuum cleaner.

8. Replace the filter:
- Press both sides of the filter **(a)** and place it back into its compartment.
  - Loosen the sides of the filter so it will fall back in position under the clips **(b)**.
  - Position the handle under the clip **(c)**.
  - Slide the handle over the catch and click it back in position **(d)**.

9. Replace the cover and tighten both the screws and the horizontal adjusters.

**Notes:**

- We advise you to clean the filter every 100 hours.
- Operating the projector with a torn or damaged filter may cause damage to the projector.
- When the filter is damaged replace it with a filter of the same type (12 nc: 4822 480 10229).
- The projector power cannot be switched on again unless the filter holder is installed correctly.

**MAINTENANCE OF YOUR REMOTE CONTROL**

Your trackball on the remote control is very durable and will provide years of use. It has a self-cleaning ball-cage that helps prevent dust and lint built-up around the ball. If the screen cursor jumps or moves abnormally, we recommend that you clean the trackball manually.

**To clean your trackball**

1. Turn the retainer ring counter-clockwise to remove the ball.
2. Wipe the ball with a clean, lint-free cloth.
3. Blow carefully into the ball cage to dislodge dust and lint.
4. Look for a built-up of dirt on the rubber rollers inside the ball cage. This build-up usually appears as a stripe running around the middle of the roller.
5. If dirty, clean the rollers using a cotton swab moistened lightly with isopropyl (rubbing) alcohol. After cleaning, make sure the rollers are still centered in their channels.
6. Make sure that fluff from the swab is not left on the rollers.
7. Replace the ball and retainer ring.

**LAMP**

- The projector lamp has a operating life of approximately 4000 hours. When operation time reaches 3901 hours, the message 'WARNING: Lamplife expires in 99 hours' will be displayed on the screen when switching the projector on.
- Then, each time the projector is switched on, the lamp indicator flashes orange and the lamplife remaining will be displayed for 10 seconds.
- When the lamplife is expired, the lampindicator lights up orange and the message 'WARNING: lamplife is expired' is displayed on the screen.



## LAMP REPLACEMENT

1. Press the STANDBY/ON/OFF button to switch off the projector.
  - The standby indicator lights up red.
2. Wait 5 minutes for the lamp to cool down and the cooling fan to stop and disconnect the mains lead and all other cables.
3. Turn the projector over. *Never place the projector on the side where the connections are located!*
4. Unscrew and remove both horizontal adjusters.
5. Unscrew the screws at the bottom of the cover and remove the cover.

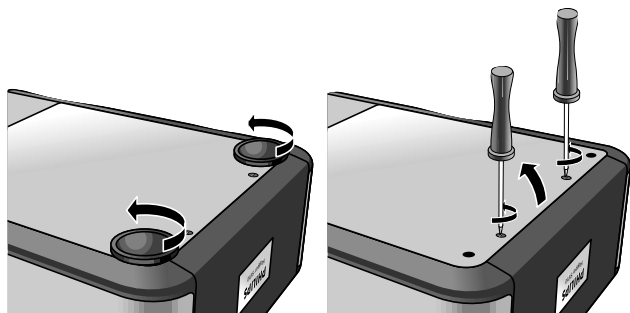

6. Read the caution and warning labels on the lamp cover.
7. Unscrew the lamp holder.



8. Grasp the lamp holder handle and carefully pull the lamp holder out of the projector.

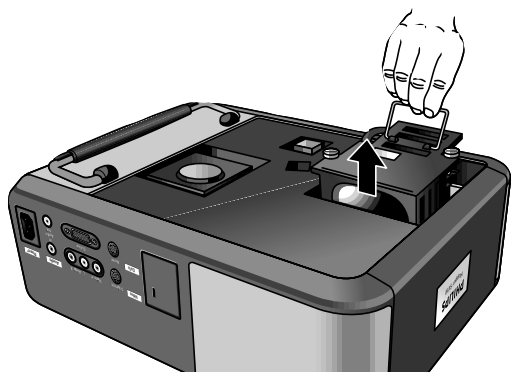

**Caution:** Be very careful. The lamp holder may still be too hot to touch.

Keep lamp holder opening to your right. Do not touch lamp or point lamp holder opening at anyone.

**Warning:** The lamp may be hot. Be careful when handling.

**Caution:** A high-pressure lamp may break if handled improperly.

9. Carefully remove the new lamp housing from its package. Do not touch lamp or point lamp housing opening at anyone. Do not drop, as the impact may cause the lamp to break.
10. Place the lamp holder in the guiding slots and insert into the lamp compartment.

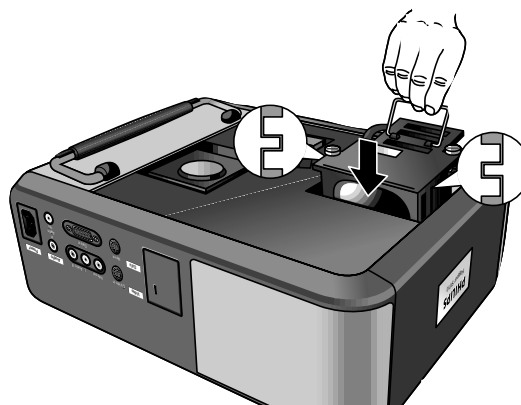

11. Tighten the screws.
12. Replace the cover and tighten both the screws and the horizontal adjusters.
13. Plug the projector back in by inserting the mains lead in the POWER socket.
14. Press the STANDBY/ON/OFF button to switch on the projector.
15. Reset the lamp life time (see 'Resetting the lamplife time').
16. Properly dispose of the old lamp.

**Note:** When replacing the lamp, always use the same type of lamp (LCA 3108/00, 12NC: 8670 931 08009).

## RESETTING THE LAMPLIFE TIME

1. Press MENU.
  - The menu bar appears on the screen.
2. Use cursor control to select MISC(ellaneous) in the menu bar.
3. LAMP LIFE is highlighted.

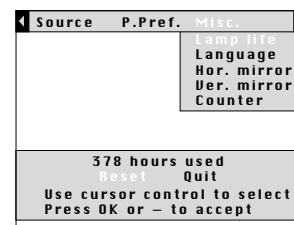
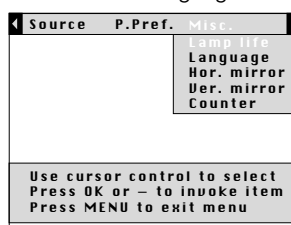

4. Press OK (–/–) to activate the LAMP LIFE item.
5. Use cursor control to select RESET in the action window.
 

**Note:** If you select Quit, you will exit the action window and the lamp life time will not be reset.
6. Press OK (–/–) to confirm.
  - A new action window will appear
7. Use cursor control to select YES or NO in the action window and press OK (–/–) to confirm.
8. If required, select another item you wish to adjust or press MENU to exit.

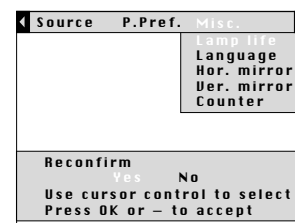

# 10. TROUBLESHOOTING

If a fault occurs, first check the points listed below before taking the projector for repair. If you are unable to remedy a problem by following these hints, consult your dealer or service organisation.

## WARNING

Under no circumstances should you try to repair the projector yourself as this could invalidate the warranty.

### PROBLEM

- POSSIBLE CAUSE
- SOLUTION

#### Image is not displayed

- Mains lead is not correctly connected.
- Correctly connect mains lead.
- The filter holder is not installed correctly or is damaged.
- Install the filter holder correctly (see 'Cleaning the dust filter' under Additional Information').
- Lamp holder cover is not closed correctly or the lamp holder is damaged.
- Close the cover correctly (see 'Lamp replacement' under Additional Information').
- Signal cable not correctly connected.
- Connect signal cable correctly.
- The projector is in OFF position.
- Press STANDBY/ON/OFF button to switch on the projector ON.

#### Lamp ceased to operate or does not light up at all (indicator lights up red)

- Lamp is still hot while the projector attempts to restart the lamp.
- Do not switch the set off; it will restart the lamp automatically within a few seconds.
- Lamp circuit failure or worn-out lamp.
- Take the projector to your nearest Service Centre, or
- Replace lamp (see 'Maintenance').
- Internal temperature of the projector is too high.
- Wait a few minutes and check to see if the air outlets are blocked.
- Disconnect and re-connect the mains cord to the projector. If the temperature in the meantime decreased sufficiently, the projector will start up in the standby mode.

#### Lamp indicator blinks orange

- Lamp life is almost expired (less than 100 hours to go).
- See lamp life counter on start up screen for details.

#### Lamp indicator lights up orange

- Lamp life is expired.

#### Poor colour

- Wrong video system has been selected.
- Select the correct video system (see 'Video system selection' under 'Picture Control').
- Adjust brightness, contrast, saturation or hue (see 'Video adjustments' under 'Picture Control').

#### Image is blurred

- Image is not focused.
- Adjust focus ring.
- Distance between projector and 'screen' is not correct.
- Adjust the distance between the projector and the screen.
- Signal cable is not correctly connected.
- Connect signal cable correctly.

#### Image does not match up with the projected screen

- Horizontal or vertical shift or horizontal size are not adjusted correctly.
- Adjust horizontal or vertical shift or horizontal size (See 'Data adjustments' under 'Picture Control').

#### Picture rolls

- Signal cable is not correctly connected.
- Connect signal cable correctly.

#### Picture too bright

- MONITOR OUT has been enabled, while no external monitor is connected.
- Disable the MONITOR OUT option. Press MENU and use cursor control to go to the SOURCE item on the menu bar. Choose MONITOR OUT and select OFF.

#### Picture too dark or bright with external monitor connected

- MONITOR OUT has been enabled, but the external monitor is not correctly connected. (The picture on both displays is too bright)
- Connect the (optional) Y-cable (See 'Connecting to an external monitor' under 'Installation').
- If the Y-cable is correctly connected, verify whether the input impedance of the monitor is correctly set on 75 Ohm.
- MONITOR OUT has not been enabled, but the external monitor is connected. (The picture on both displays is too dark)
- Enable the MONITOR OUT option. Press MENU and use cursor control to go to the SOURCE item on the menu bar. Select MONITOR OUT and select ON.

#### No sound

- Audio cable is not correctly connected.
- Connect audio cable correctly.
- Volume is not adjusted.
- Adjust volume.
- Mute or A/V-mute is active.
- Cancel mute or A/V-mute.

#### The projector does not react to commands from the remote control

- Remote control is not switched on.
- Switch on the remote control.
- Distance is too great.
- Reduce distance.
- Batteries are exhausted.
- Replace batteries (see 'Inserting the batteries in the remote control').
- IR sensor is obstructed.
- Remove obstacle.
- Proper mouse software has not been installed on your computer.
- Install proper mouse software.

## Free Manuals Download Website

<http://myh66.com>

<http://usermanuals.us>

<http://www.somanuals.com>

<http://www.4manuals.cc>

<http://www.manual-lib.com>

<http://www.404manual.com>

<http://www.luxmanual.com>

<http://aubethermostatmanual.com>

Golf course search by state

<http://golfingnear.com>

Email search by domain

<http://emailbydomain.com>

Auto manuals search

<http://auto.somanuals.com>

TV manuals search

<http://tv.somanuals.com>