

Philips Home Cinema Projector *Garbo*



English User guide

1. Introduction	4
Packaging contents	4
Optional accessories	4
2. Functional overview	5-8
Controls	5-6
Remote control	7
Connections	8
3. Set up	9-10
Positioning the projector and screen	9
Switching on the projector	9
Adjusting the focus and size of the image	10
Adjusting the vertical angle of the projector	10
Keystone correction	10
Moving/transporting the projector	10
Preparation	10
Moving/transporting the projector	10
Inserting the batteries in the remote control	10
4. Installation	11-16
General information	11
Video input	11
Computer input	11
Universal Serial Bus (USB)	11
External monitor connection	11
Connecting to video equipment	12-14
CVBS	12
S-VHS	12
Scart connection	12
Component/HDTV (Pr,Y,Pb/ Cr,Y,Cb)	13
Scart connection (RGBS)	14
Connecting to a computer	15-16
PC/Macintosh	15
Connection to an external monitor	16

- 5. Operation 17-26**
 - Preparation 17
 - General 17
 - Messages 17
 - General explanation 17
 - Feedback messages 17
 - Some examples 17
 - On Screen Display Menu 18-26
 - Menu tree 18-19
 - General explanation 20
 - Video/S-Video adjustments 21
 - Picture adjustments 21
 - Display adjustments 21
 - Computer adjustments 22-25
 - Picture adjustments 22
 - Display adjustments 22
 - Some examples 23
 - Picture Format 23
 - Vertical Shift 23
 - Digital Zoom/Magnification 24
 - Auto image 24
 - Horizontal size 24
 - Shift 25
 - General adjustments 26
 - Audio adjustments 26
 - General settings 26
- 6. Maintenance 27-29**
 - Cleaning 27
 - Cleaning the cabinet 27
 - Cleaning the lens 27
 - Cleaning the dust filter 27
 - Lamp 28
 - Lamp replacement 28-29
 - Resetting the lamp life time 29
- 7. Troubleshooting 30-33**

1. Introduction



Congratulations on your purchase of one of the most sophisticated and reliable products on the market today. We are sure that, used properly, it will bring you years of enjoyment. You will want to keep this manual handy, as it is a convenient source of information about your projector. For your own protection and prolonged operation of your projector, please read the enclosed Safety Sheet.

Packaging contents

Please confirm that the following items are packed in the projector box. They are provided to help you use or set up your projector.

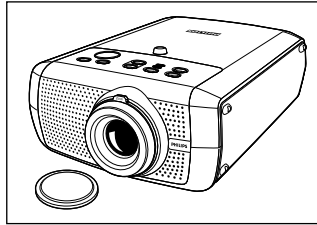

Projector
Lens cap - 3122 434 21540

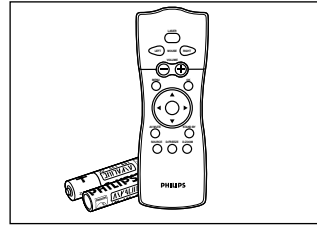

Remote control + batteries
2 x AAA Zinc Carbon, 1.5 V
3139 228 60500

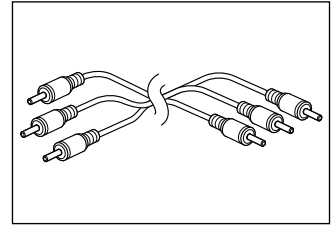

Audio/Video RCA Cable
4822 320 12281

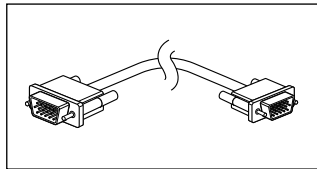

VGA Cable
3122 438 75110

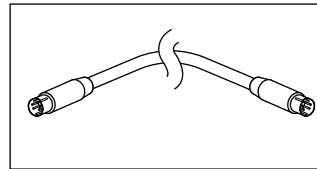

S-Video cable
3122 438 75140

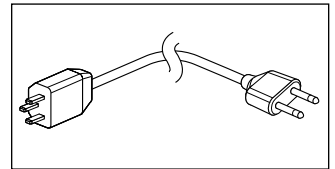

Mains Lead
Europe: 4822 321 11399
USA: 4822 321 11294
UK: 4822 321 11431

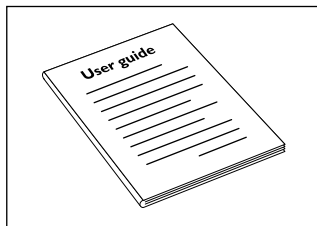

Printed User Guide
3103 435 90030

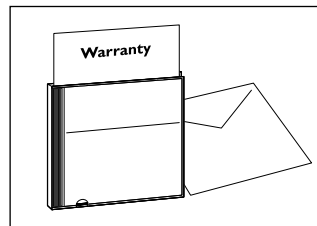

Cd-rom (with Projection Assistant, Warranty card, User Guide, Data sheet and more.)
3103 438 70060

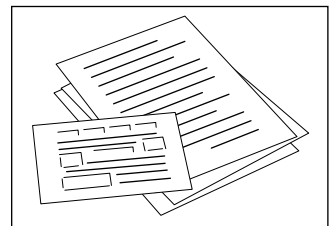

Quick set up Card and Safety Sheet
3103 435 9000

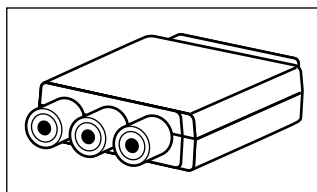

Scart/RCA Audio Video adapter (not for USA version)
2422 033 00345

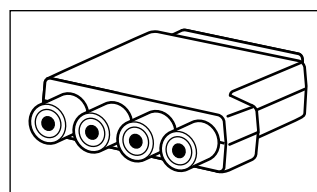

Scart/RCA component Video adapter (not for USA version)
3122 438 71170

Optional accessories

- LCA 1120/00 - Soft bag - 8670 911 20009
- LCA 3116/00 - 132 W replacement lamp - 8670 931 16009
- LCA 2211/00 - Ceiling mount - 8670 922 11009
- LCA 5310/00 - Monitor Y-cable - 8670 953 10009
- LCA 5300/00 - VGA extension cable (15 m) - 8670 953 00009

Note For further information on parts and accessories, please contact the dealer from which you purchased your Philips projector.

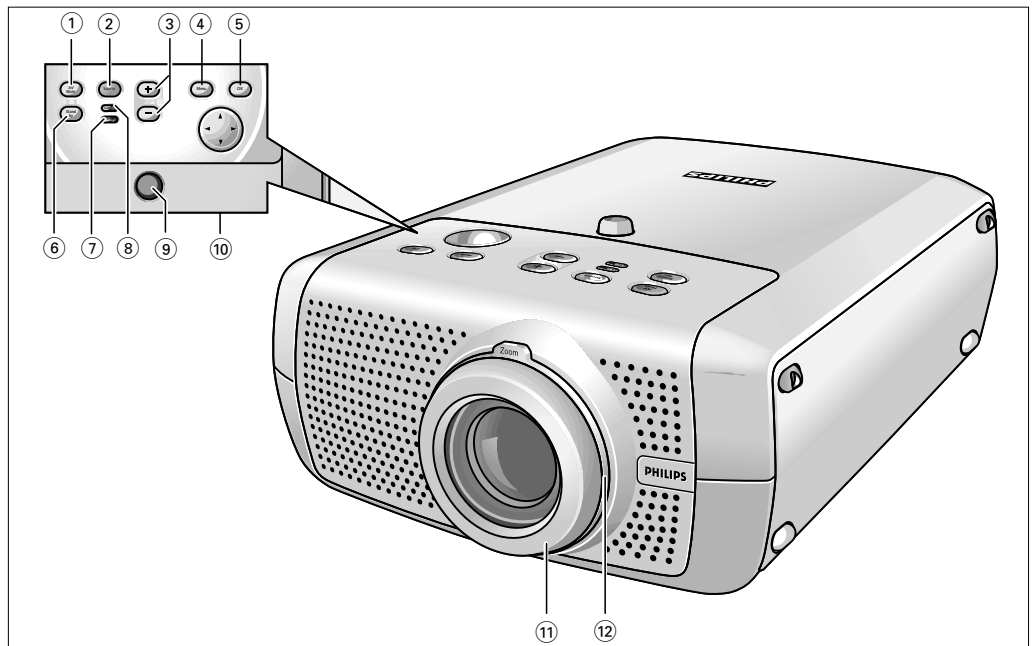

- A(udio)/V(ideo) Mute** ① To mute the sound of the projector and to mute the picture.
- Source** ② To select the current projection source (Computer, Component, S-Video or Video). The button toggles between the four signals.
- / +** ③ To adjust the volume.
- Menu** ④ To activate and deactivate the menu.
- OK** ⑤ To confirm actions in the menu when the menu is on screen.
- Standby/Standby indicator** ⑥ To switch the projector in or out of the Power/Standby mode. The Standby indicator (text on button/ring around button):
- lights up orange when the projector is warming up;
 - lights up red when the projector is in Power/Standby mode;
 - lights up green as when the projector is operating;
 - slowly blinks orange when the projector is cooling down.
- Temperature indicator** ⑦
- Lights up red in case of temperature error.
 - Flashes in case of fan error.
- Lamp indicator** ⑧
- Lights up green when the lamp is on.
 - Lights up orange when lamp life has almost expired.
 - Lights up red when lamp life has expired.
 - Fast blinks red when lamp start has failed.
- IR sensor** ⑨ To receive the signals from the remote control.
- Cursor Control** ⑩ When the menu is active the Cursor Control controls the menu cursor to navigate through the OSD menu. The cursor control works with up/down and left/right button operation.
- Focus ring** ⑪ To adjust the focus of the projected image.
- Zoomring** ⑫ To adjust the size of the projected image.

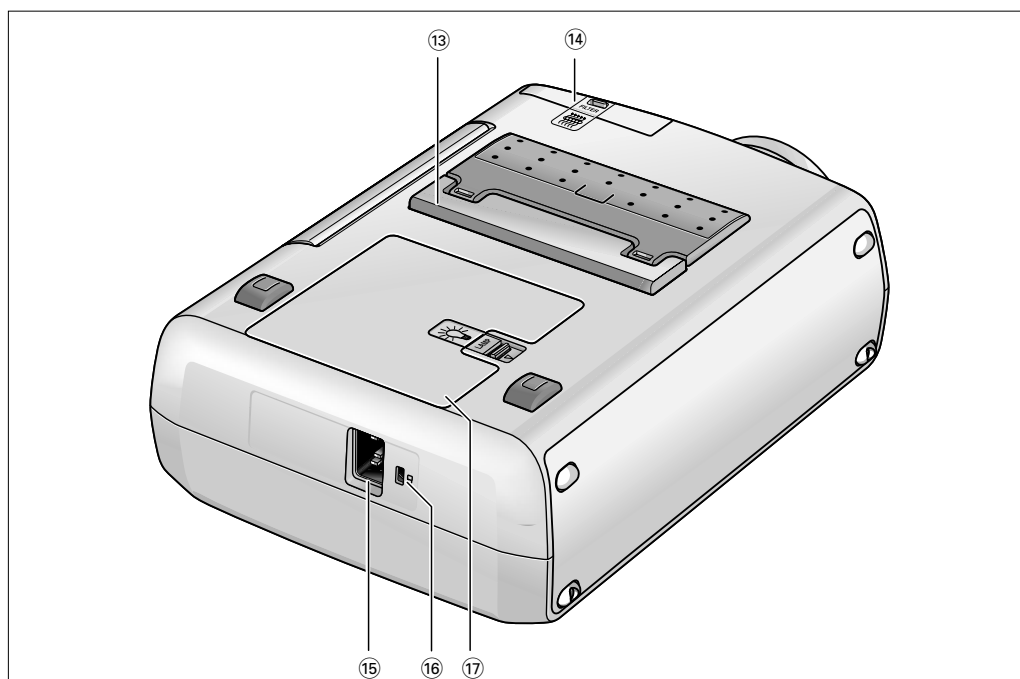

- Height/Level adjuster** ⑬ To adjust the vertical angle of the projector.
- Dust filter** ⑭
- Mains inlet socket** ⑮ To connect the projector to the mains.
- Lock slit** ⑯ To insert an optional locking device (Kensington lock).
- Lamp compartment** ⑰

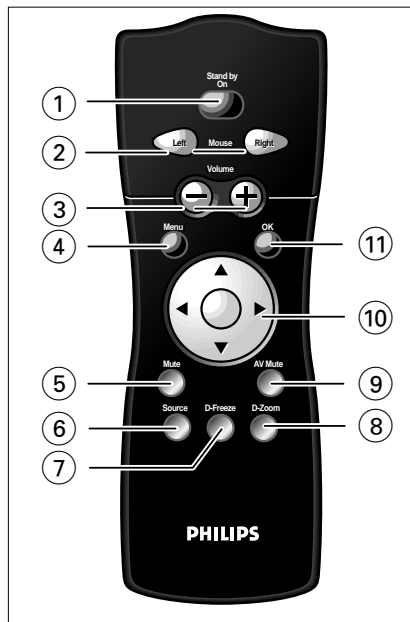

Stand by On ① To switch the projector in or out of the Power/Standby mode.

Mouse Left/Right ② Function as the Left and Right mouse keys of your PC when USB or PS/2 connection has been made.

- Volume + ③ To adjust the volume.

Menu ④ To activate and de-activating the menu.

Mute ⑤ To mute the sound of the projector.

Source ⑥ To select the current projection source (Computer, Component, S-Video or Video). The button toggles between the four signals.

D(igital)-Freeze ⑦ To capture a (moving) picture. The button toggles between the Freeze mode and the display situation.

D(igital)-Zoom ⑧ To switch the 'Digital Zoom' function 'On' or 'Off' (toggle button). In 'On' condition, the zoom centre can be selected using Cursor Control and the image is magnified with the zoom factor chosen under 'Magnification'.

A(udio)/V(ideo) Mute ⑨ To mute the sound of the projector and to mute the picture.

Cursor Control ⑩ To manipulate the mouse cursor on the connected computer as long as the menu is not active. When the menu is active the Cursor Control controls the menu cursor to navigate through the OSD menu. The cursor control works with up/down and left/right button operation.

Note *The Cursor Control can only function as a mouse cursor when projector and computer are connected via the USB or PS/2 connectors. Windows 98, Windows ME, Windows 2000 or Windows XP should be installed on the computer when you make the USB connection.*

OK ⑪ To confirm actions in the menu when the menu is on screen.

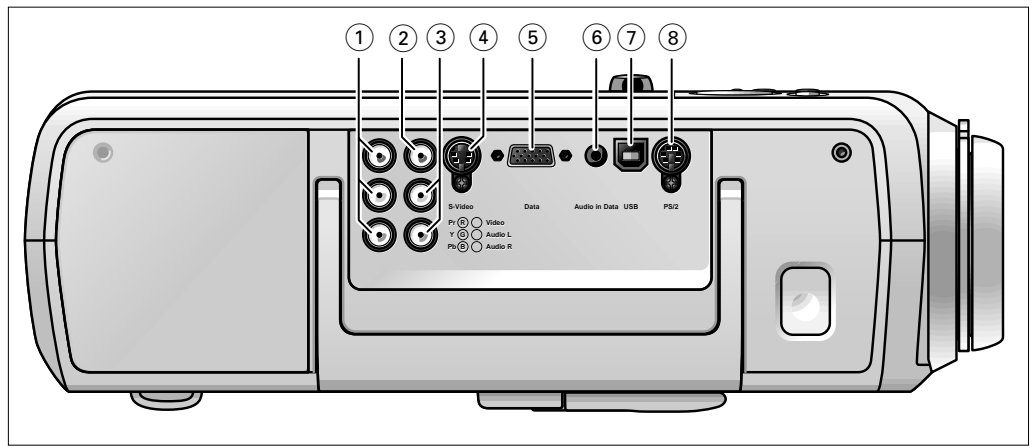
**Video source connections****Component in** ①

Input sockets to connect to DVD- and HDTV-video equipment

These sockets can be connected to the following output sockets: RGB-Y, YCbCr, YPbPr (480p, 720p, 1080 i).

Video ②

Input socket to connect to the Video out socket of a video recorder, Laser Disc player, video camera, DVD player, or TV with AV output socket.

This socket can be connected to CVBS output sockets.

Audio L/R ③

Input sockets to connect to the Audio out sockets of a video recorder, laser disc player, video camera or TV with A/V output socket.

S-Video ④

Input socket to connect to the S-Video out socket of a S-VHS video recorder, a VCR, Laser Disc player, DVD player, video camera or TV with AV output socket.

This socket can be connected to a S-Video/S-VHS (Y/C) output socket.

Data source connections**Computer** ⑤

Input socket to connect to the Data out terminal of a computer.

Audio in Computer ⑥

Input socket to connect to the Audio out terminal of a computer.

USB (upstream) ⑦

In-/Output socket to connect a PC or Apple Macintosh computer equipped with a USB downlink connection. When USB connection is used the mouse cursor on the connected computer can be controlled via the projector remote control. Make sure Windows 98, Windows ME, Windows 2000 or Windows XP is installed on the computer.

PS/2 ⑧

In-/Output socket to connect a PC or Apple Macintosh computer equipped with a PS/2 connection. When PS/2 connection is used the mouse cursor on the connected computer can be controlled via the projector remote control.

3. Set up



Positioning the projector and screen

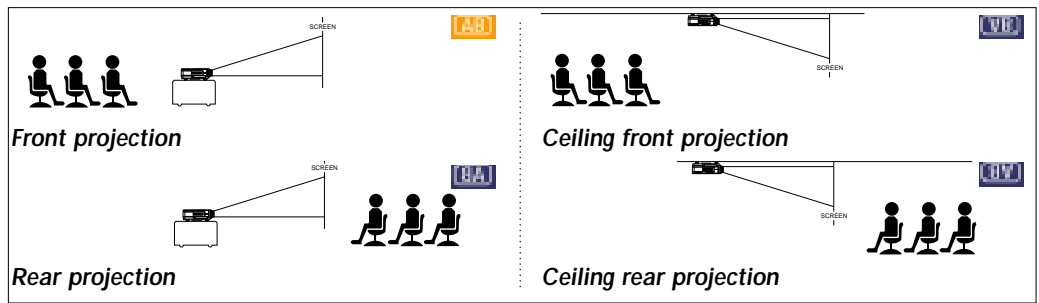

- Place the projector on a stable, level surface, out of direct sunlight and away from sources of excessive dust, dirt, heat, water, moisture, vibration and strong magnetic fields.
- Allow sufficient cooling of the product by keeping all air inlets and outlets clear from obstructions.
- Position the projector in such way that the viewers cannot watch into the projector light beam.
- Choose a screen size suitable for the number of viewers and the size of the room.
- Picture quality is best when you sit directly in front of the projector screen.
- The projector can be used for both front projection, rear projection and ceiling projection applications. As default factory setting, the projector has been set up for front projection. You can change to rear or ceiling projection via the 'Mirror' function in the 'Picture' menu.

Switching on the projector

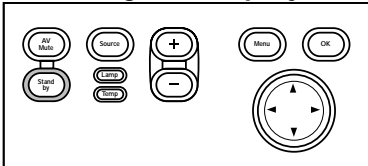

- 1 Insert the mains lead into the projector's Mains inlet socket and connect it to the wall socket.
 - The Standby indicator lights up red, the projector is now in the Power/Standby mode.
- 2 Remove the lens cap.
- 3 Press any button on projector or remote control to switch on the projector.
 - The Standby indicator lights up orange.

- When the projection lamp is on, the Standby indicator lights up green and the start-up screen appears for several seconds.

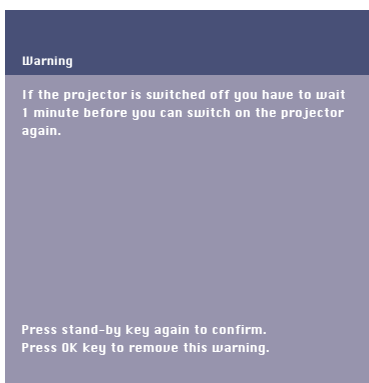

- 4 Press the Standby button to switch the projector back into the Power/Standby mode.
 - The Standby Warning screen will appear for 20 seconds.
 - The Standby Warning screen can be removed by pressing the OK button.
- 5 Press the Standby button again to confirm.
 - The projector will now go into Power/Standby mode.

You can also press the Standby button twice in succession to switch the projector into Power/Standby mode immediately.

- 6 To switch off the mains supply completely, disconnect the mains lead.

Notes

Save energy! Please put the projector in the Power/Standby position if you are not going to use the projector for more than 15 minutes.

When no signal inputs are detected for 30 minutes, the projector automatically switches to Power/Standby (Auto Standby). This setting can be changed in the 'Settings' menu

Before disconnecting the mains lead, make sure that the cooling fan has stopped (about 3 minutes after the projector has been switched to Power/Standby).

3. Set up



Adjusting the focus and size of the image

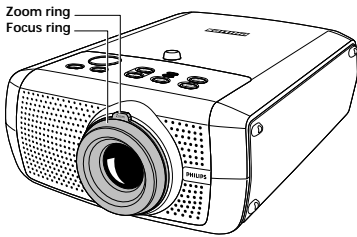

- Use the Zoom ring to adjust the size of the image.
- Use the Focus ring to adjust the focus of the image.

Adjusting the vertical angle of the projector

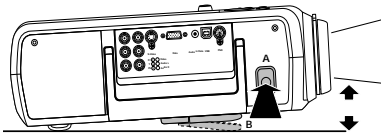

To raise:

- Keep knob A pressed and lift to raise the projector.
- The Height/Level Adjuster B will come out.

To Lower:

- Keep knob A pressed and gently lower the projector.
- Use the Focus Ring and Zoom Ring to readjust the focus and size of the image.

Keystone correction



If projector and screen are not properly placed, the picture will be distorted, producing a keystone image (picture top width larger than picture bottom width or vice versa). When a keystone image occurs the image ratio (4:3, 16:9) will still be guaranteed. This is especially important when the projector is being used together with an 'intelligent whiteboard'. 'Keystone correction' allows you to correct picture distortion of the vertical keystone type by internal scaling. This correction function is accessible through the 'Keystone Correction' option in the 'Settings' menu of the On Screen Display (OSD) menu.

Moving/transporting the projector

Preparation

- 1 Press the Standby button *twice* to put the projector in Power/Standby.
 - The Standby indicator starts blinking orange.
- 2 Wait until the cooling fan has stopped (about 3 minutes after the projector has been put in Standby) and disconnect the mains lead and all other cables.
- 3 Put the lens cap back in place to prevent dust, dirt or other contamination from harming or damaging the front of the projector lens when moving the projector.

Note

Never place the projector on the side where the connections are located.

Moving/transporting the projector

The projector contains many glass and precision parts. If you need to transport the projector, please follow these packing instructions to prevent accidental damage to the projector.

- When you are hand-carrying the projector, be sure to use a carrying case like the optional softbag.
- When shipping the projector, use the original packaging material if possible. If you do not have the original packaging, use equivalent materials, placing plenty of cushioning around the projector.
- When transporting the projector as freight or checked luggage, first put it in a carrying case, then pack it in a firm box, using cushioning around the case.

Inserting the batteries in the remote control

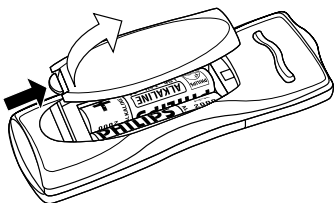

- 1 Push and slide the lid in the direction of the arrow.
- 2 Install two 'AAA' batteries as indicated inside the battery compartment.
- 3 Replace the lid and snap it into place.

Note

The maximum range of the remote control is approximately 15 m (± 50 feet).

General information**Video input**

The projector accepts the input signal of all major video formats, including NTSC 3.58, 4.43, PAL B, G, D, H, I, N, M and SECAM signals. The projector will recognize these standards and adapt to them automatically. With the 'Picture Format' feature you can select one of six picture format options: wide screen, super zoom 4:3, 4:3, movie expand 14:9, movie expand 16:9, 16:9 subtitles.

Computer input

The computer input is suitable for both Apple Macintosh computers (Power Book and Power Mac) as well as for IBM compatible PCs. The projector is Microsoft (R), Windows (R) 95/98/ME/2000/XP compatible and accepts input signals from all computers that meet following specifications:

- Multi scan VGA-SXGA
- Horizontal scan rate: 15-108 kHz
- Vertical refresh rate: 50-120 Hz
- Bandwidth: 140 MHz
- Display Data Channel DDC: 1/2B

The data output of IBM compatible PCs can be connected directly to the projector using standard data cables. When connecting the projector to a Macintosh computer equipped with a 2 row, 15 pin connector a VGA/MAC adaptor (available at your PC store) is required. If your computer is equipped with a 3 row connector no adaptor is needed.

Universal Serial Bus (USB)

The Universal Serial Bus (USB) connector allows you to connect to computers equipped with a USB interface, resulting in real hot plug and play presentation.

Mouse control:

By connecting USB, the mouse function on the Remote Control automatically gets installed. You can now manipulate the mouse cursor on the computer and on the screen, using Cursor Control on the remote control. The Mouse Left/Right keys on the remote control function as Left and Right mouse keys of your pc.

Drag and drop facility

Drag and drop via the remote control works slightly different than via the pc mouse. Here' how:

- Use Cursor Control to select the item to be moved.
- Press and keep pressed Mouse Left.
- Use Cursor Control to move the selected item. Then release Mouse Left.
 - The item will now be moved.
- Press Mouse Left when the item reaches the required location.
 - The item will now be dropped.

Note *Mouse control and 'drag and drop' is also possible when PS/2 connection has been made.*

Note *Based on the specific hardware and software configuration available, Apple Macintosh computer users could experience incomplete or erratic USB -functionality. These problems are not related to the performance of your projector.*

External monitor connection

A separate external monitor (or a second projector) can be connected to the projector. The image projected is simultaneously shown on the monitor, even when the projector is in Power/Standby or Off mode.

CAUTION *Always switch off projector and external equipment before making any connections.*

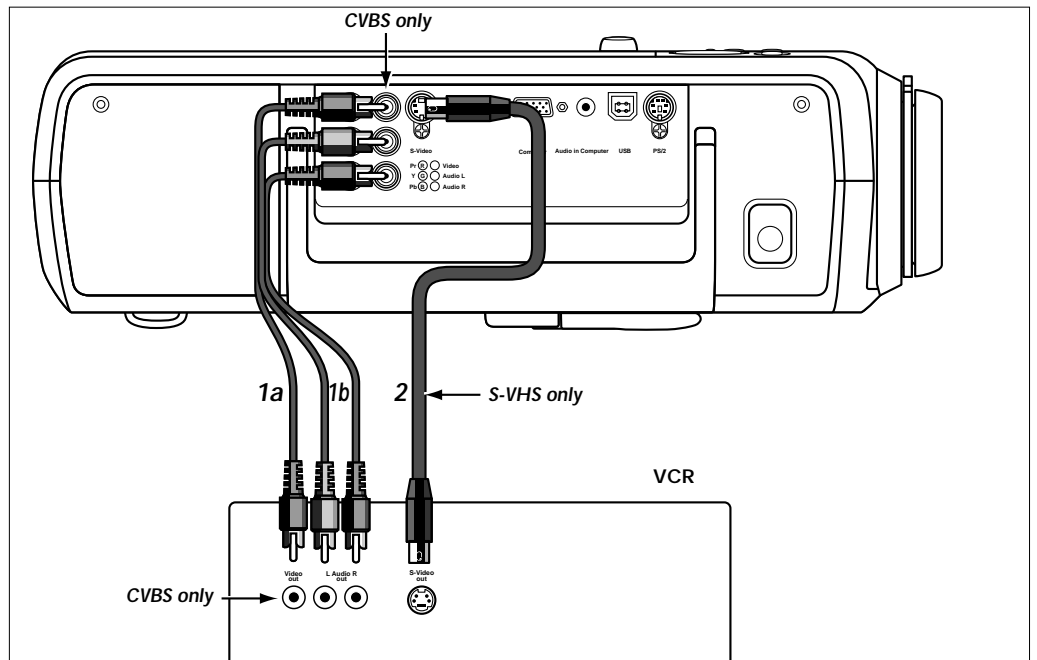

- CVBS**
- 1 Connect the Video (out) socket of a VCR, Laser Disc player, video camera or TV to the Video (in) socket of the projector.
For this, use the video/audio connection cable **(1a)** supplied.
 - 2 Connect the Audio out L/R sockets of the VCR, Laser Disc player, video camera or TV to the Audio (in) L/R sockets of the projector.
For this, use the audio/video connection cable supplied **(1b)**.

- S-VHS**
- 1 Connect the S-Video (out) socket of a S-VHS video recorder, Laser Disc player, video camera or TV to the S-Video (in) socket of the projector.
For this, use optional S-Video connection cable supplied **(2)**.
 - 2 Connect the Audio out L/R sockets of the S-VHS video recorder, Laser Disc player, video camera or TV to the Audio (in) L/R sockets of the projector.
For this, use audio/video connection cable supplied **(1b)**.

Scart connection

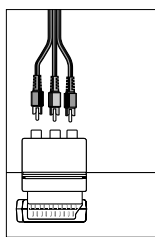

Scart adapter
(not for USA version)

- CVBS**
- 1 Connect the Scart/RCA Audio Video adapter supplied to the Scart connector of the VCR, Laser Disc player, video camera or TV.
 - 2 Plug the video/audio connection cable supplied into both the adapter and the Video and Audio (in) L/R sockets of the projector.

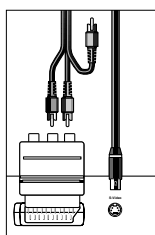

Scart adapter
(not for USA version)

- S-VHS**
- 3 Plug the S-Video connection cable supplied into the VCR and the S-Video socket of the projector.

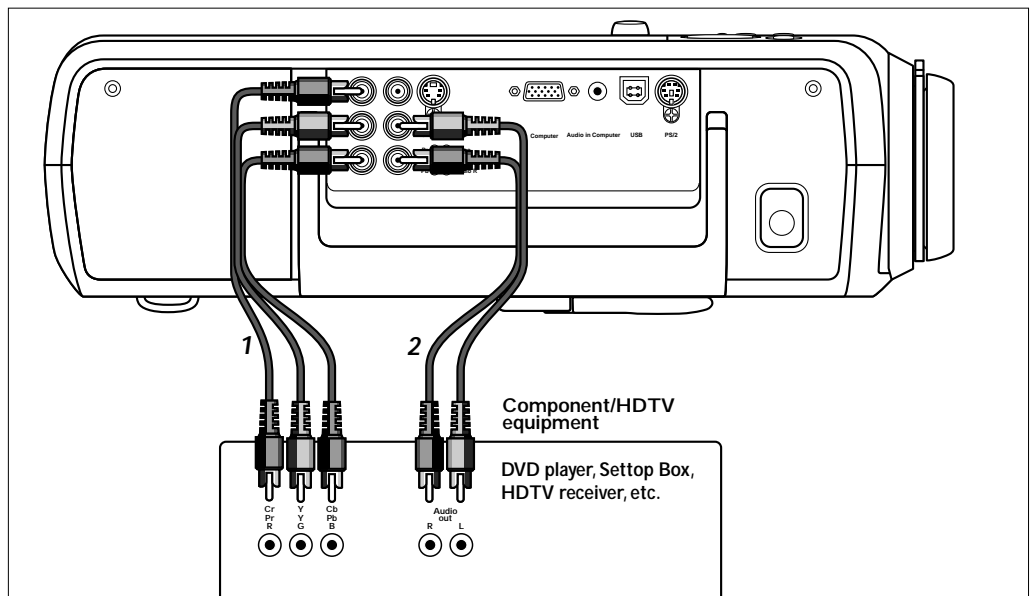

Component/HDTV *Pr, Y, Pb/Cr, Y, Cb*

- 1** Connect the Component in sockets of the projector to the appropriate output sockets of your Component- or HDTV-video equipment (Pr, Y, Pb / Cr, Y, Cb).
For this, use the audio/video connection cable supplied **(1)**.
- 2** If required you can connect the Audio out L/R sockets of the Component- or HDTV-video equipment to the Audio (in) L/R sockets of the projector.
For this, use an optional audio connection cable **(2)**.
 - Audio information from the Component- or HDTV-video equipment will be played via the projector speaker.

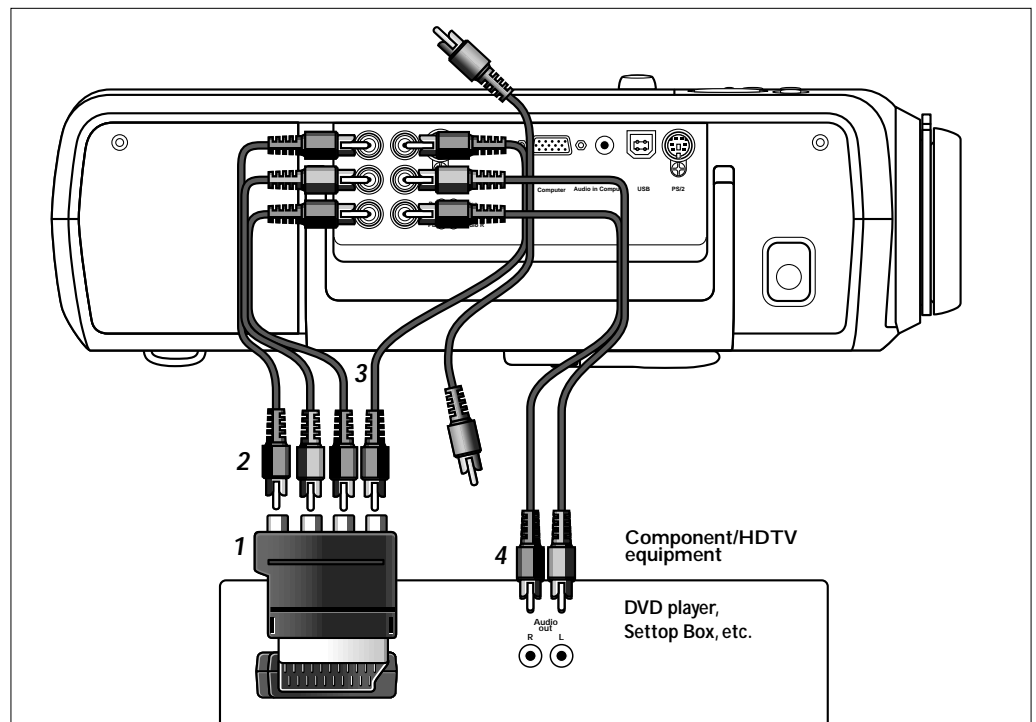

Scart connection **RGBS**

- 1 Connect the Scart/RCA Component Video adapter **(1)** to the Scart connector of your Component- or HDTV-video equipment
- 2 Connect the Component in sockets of the projector to the R, G and B outputs of the adapter.
For this, use the audio/video connection cable supplied **(2)**.
- 3 Connect the Video input of the projector to the Y output of the adapter.
For this, use an optional audio/video connection cable **(3)**.
- 4 Select 'Component' input by pressing the Source button.
 - 'Component' appears on the screen.

Component

- 5 If required you can connect the Audio out L/R sockets of the Component- or HDTV-video equipment to the Audio (in) L/R sockets of the projector.
For this, use an optional audio connection cable **(4)**.
 - Audio information from the Component- or HDTV-video equipment will be played via the projector speaker.

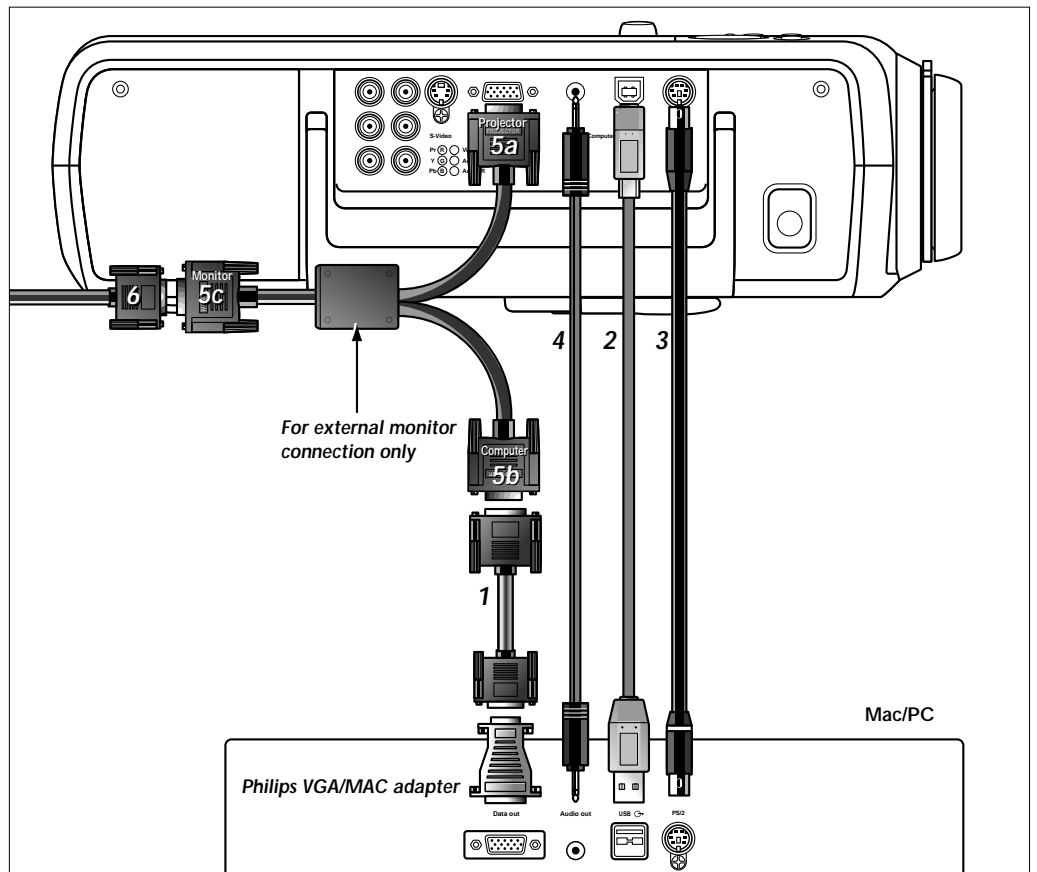

PC/Macintosh

- 1 Connect the Data (out) socket of the computer to the Computer (in) socket of the projector and secure the plugs by tightening the thumb screws.
For this, use the VGA cable supplied **(1)**.
 - 2 Connect the USB (upstream) socket of the projector to the USB downstream port of the computer.
For this, use an optional USB cable **(2)**.
- or:
- 2 Connect the PS/2 (out) socket of the projector to the PS/2 (in) socket of the computer.
For this, use an optional PS/2 cable **(3)**.
- When switching on, *first* switch on the projector and *then* the PC.
 - You can now manipulate the mouse cursor on the computer and on the screen, using Cursor Control on the remote control. When using the USB connection, make sure Windows 98, Windows ME, Windows 2000 or Windows XP is installed on the computer.
 - The display settings of the computer will be changed to fit the capability of the projector.
- 3 If required you can connect the Audio out socket of the computer to the Audio in Computer socket of the projector.
For this use an optional audio cable **(4)**.
 - Audio information from the Computer will then be played via the projector speaker.

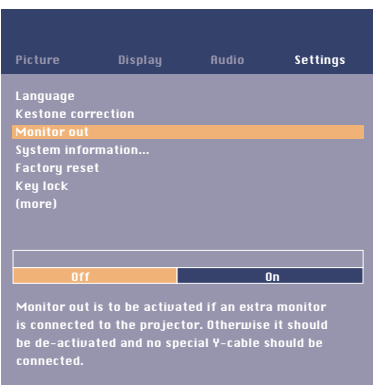
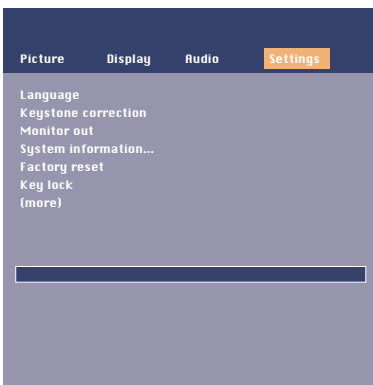
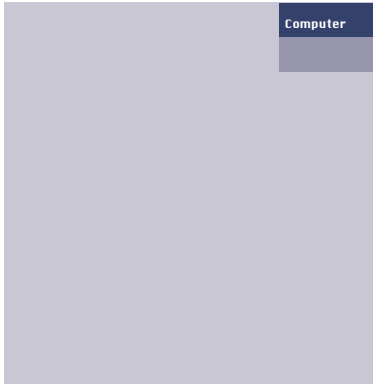
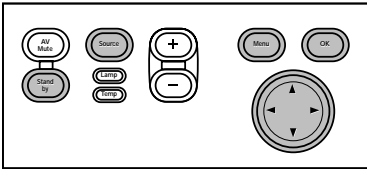

Connecting to an external monitor

- 1 Connect the VGA Y connector marked 'Projector' **(5a)**, of an optional VGA Y-cable, to the Computer (in) socket of your projector.
- 2 Connect the VGA cable supplied **(1)** between the computer and the VGA Y connector marked 'Computer' **(5b)**.
- 3 Connect the VGA Y connector marked 'Monitor' **(5c)** to the VGA cable **(6)** of the monitor.
- 4 Switch on your Computer.
- 5 Switch on the projector.
- 6 Select 'Computer' input, using the Source button.
 - 'Computer' appears on the screen.

- 7 Press Menu.
 - The menu bar appears on the screen.
- 8 Use Cursor Control to select 'Settings' in the menu bar.

- 9 Use Cursor Control to select 'Monitor out'.
- 10 Use Cursor Control to select 'On'.
 - The projector will indicate the necessity to connect the Y-cable.
- 11 Switch on the external monitor.
 - The image projected is simultaneously shown on the monitor.

5. Operation

General

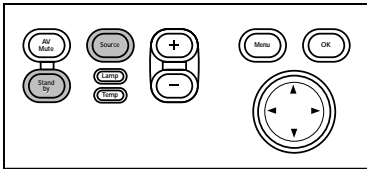

PHILIPS
Home Cinema Projectors

- 1 Press the Standby button to switch on the projector.

- The Standby indicator lights up orange.
- When the projection lamp is on, the Standby indicator lights up green and the start-up screen (when enabled) appears for several seconds.

- 2 Select the required source (Computer, Component, S-Video or Video) by pressing the Source button.

Note When only one input source is connected, this source will automatically be selected (Auto Source). When more input sources are connected, the source with the highest priority will be selected (Computer, Component input, S-Video, Video). Source selection can be changed in the 'Settings' menu.

- 3 Switch on the computer or start video playback.

- A feedback message appears on the screen, indicating the selected source.

Messages



General explanation

Messages are displayed in the centre of the screen. The problem is described in the header of the message display. Suggestion(s) to solve the problem are displayed in the gray part of the message display.

These messages cannot be suppressed.

Feedback messages

Feedback messages are displayed in the top right corner of the screen. They are displayed when:

- a signal comes up or goes down;
- when an input source is changed;
- when Mute or A/V Mute is activated;
- when the Auto image function is set to On.

Some examples

These messages will only be displayed when the menu option 'Feedback' is set to 'On' in the 'Settings' menu. All messages will be removed automatically after 4 seconds.

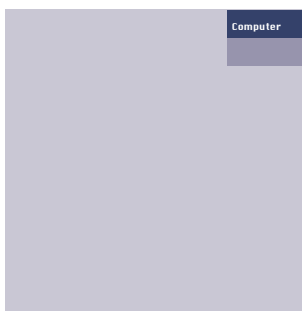

Computer selected as source



Video selected as source,
no input signal

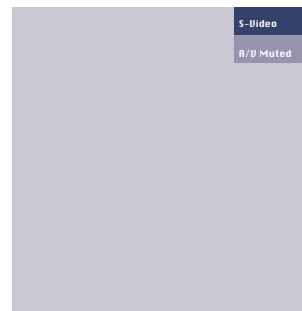

S-Video selected as source,
A/V muted

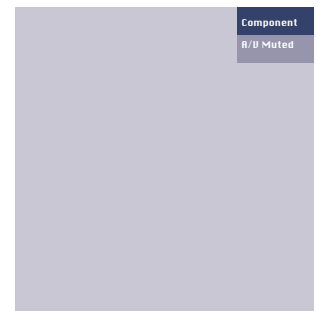

Component selected as
source A/V muted

5. Operation

On Screen Display Menu >

Menu tree

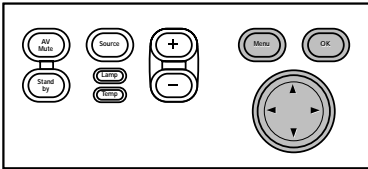

All video and data adjustments and settings (except A/V Mute) are done via *On Screen Displays* and with help of Menu, OK and Cursor Control on the projector or the remote control. The projector is set to standard specifications at the factory. However, you can adjust these specifications to suit your own preferences. The projector menu screens allow you to adjust the various projector settings (for both Computer and Video). For explanation and operation see next pages.

VIDEO/S-VIDEO MODE

Main menu	Sub menu	Setting	
Picture	Brightness	min max	
	Contrast	min max	
	Hue (NTSC only)	min max	
	Saturation	min max	
	Sharpness	sharp soft	
	Mirror	AB BA VB BV	
	Picture Format	wide screen	
		super zoom 4:3	
		4:3	
		movie expand 14:9	
		movie expand 16:9	
		16:9 subtitles	
	Colour tracking	vivid natural	
Colour temperature	warm cool		
	Red	min max	
	Green	min max	
	Blue	min max	
Display	Digital Freeze	Off On	
	Digital Zoom	Off On	
		Magnification	min max

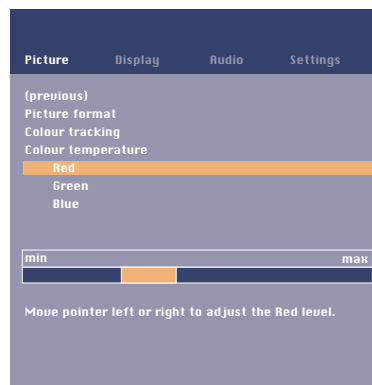

COMPUTER MODE

Main menu	Sub menu	Setting	
Picture	Brightness	min max	
	Contrast	min max	
	Mirror	AB BA VB BV	
	Picture Format	wide screen	
		super zoom 4:3	
		4:3	
		movie expand 14:9	
		movie expand 16:9	
		16:9 subtitles	
	Colour tracking	vivid natural	
	Colour temperature	warm cool	
		Red	min max
		Green	min max
Blue		min max	
Display	Digital Freeze	Off On	
	Digital Zoom	Off On	
		Magnification	min max
		Auto Image	Off On
	Horizontal Size		min max
	Phase		min max
Shift	Cursor controlled Shift		

Menu tree

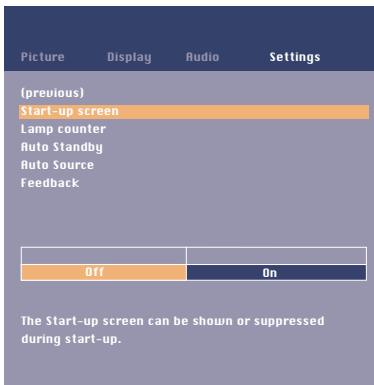
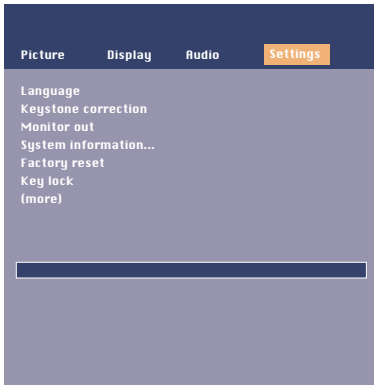
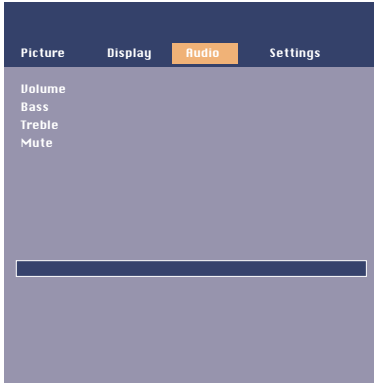

GENERAL ADJUSTMENTS/SETTINGS

Main menu	Sub menu	Setting
Audio	Volume	Min Max
	Bass	Min Max
	Treble	Min Max
	Mute	Off On
Settings	Language	Eng.
		Esp.
		Deu.
		Fra.
		Por.
		Ita.
		Chi.
	Keystone correction	Off On
	Monitor out	Off On
	System information	OK
	Factory reset	OK
Key lock	OK (3 sec.)	
Start-up screen	Off On	
Lamp counter	OK (3 sec.)	
Auto Standby	Off 15 30 45 60 120	
Auto Source	Off On	
Feedback	Off On	

General explanation

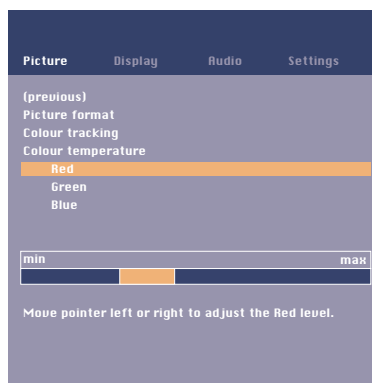
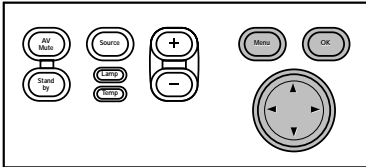

1 Press Menu.

- The menu bar appears on the screen.
The first item is highlighted and its sub menu is shown.

Depending on the selected source (Computer, Component, Video or S-Video) some options of the submenu may be greyed out. This indicates that these functions:

- are not available in a certain mode,
- have no function for the selected source.

For example:

- Horizontal size under menu 'Display' when Auto image is switched to ON.
- Hue under menu 'Picture' when signaltype is not NTSC.

- 2 Use Cursor Control left and/or right to move the cursor to any other item in the menu bar.
- 3 Select the sub menu item to be adjusted using Cursor Control up and/or down. When more items are available than can be shown in one screen, this will be indicated by 'more' at the bottom of the list. Move the cursor down to go to the next list of items. With 'previous' you can go back to the first list.
- 4 Adjust the selected item in the action window at the bottom of the screen, using Cursor Control left and/or right.
- 5 Select the next item to be adjusted in the sub menu and adjust as described above.
- 6 Press Menu to close the On Screen Menu Display.

Video/S-Video adjustments

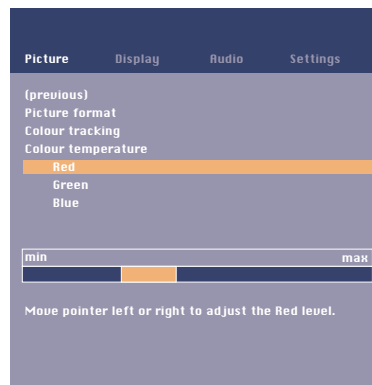
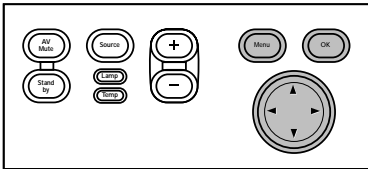

For Video/S-Video signal input, the following 'Picture' and 'Display' adjustments can be made:

Picture adjustments

- Press Menu and select 'Picture' in the menu bar. The following 'Picture' adjustments can now be made according to the instructions under 'General explanation'. For adjustment of 'Picture Format', see explanation under 'Computer adjustments'.
 - *Brightness*
adjusts brightness of the displayed picture;
 - *Contrast*
adjusts the overall contrast intensity;
 - *Hue (only for NTSC)*
adjusts the tint of the projected image;
 - *Saturation*
adjusts the colour saturation of the projected image;
 - *Sharpness*
controls the contour impression of the picture;
 - *Mirror*
mirrors the picture for use of the projector in various positions with respect to the user(s) and the projection screen;
 - *Picture Format*
selects one of six picture format options (wide screen, super zoom 4:3, 4:3, movie expand 14:9, movie expand 16:9, 16:9 subtitles);
 - *Colour tracking*
selects between 'Vivid' and 'Natural' representation of colours in the picture. 'Vivid' is automatically set when computer input is used; 'Natural' is automatically set when video input is used.
 - *Colour Temperature*
adjusts the overall colour impression from warm to cool. The various colours (red, green and blue) can also be adjusted individually.

Display adjustments

- Press Menu and select 'Display' in the menu bar. The following 'Display' adjustments can now be made according to the instructions under 'General explanation'. For adjustment of 'Digital Zoom/Magnification', see explanation under 'Computer adjustments'.
 - *Digital Freeze*
captures a moving picture (still picture);
 - *Digital Zoom*
enlarges a part of the picture;
 - *Magnification*
adjusts the zoom factor.

Computer adjustments

For computer signal input, the following 'Picture' and 'Display' adjustments can be made.

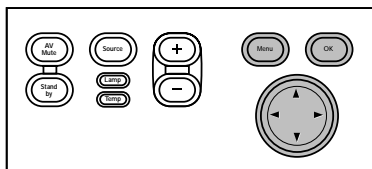
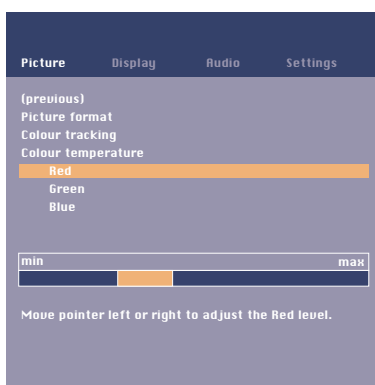

Tip for Windows users

To adjust size and phase correctly

- 1 Select 'Start' and then 'Shut down' from the Windows Taskbar.
- 2 Adjust the projector's size control, so that no vertical bars are visible.
- 3 Now adjust the projector's phase control for maximum brightness of the projected image.
- 4 Press 'No' in the Windows shutdown screen to cancel the shutdown action.

Picture adjustments

- Press Menu and select 'Picture' in the menu bar. The following 'Picture' adjustments can now be made according to the instructions under 'General explanation':
 - *Brightness*
adjusts brightness of the displayed picture;
 - *Contrast*
adjusts the overall contrast intensity;
 - *Mirror*
mirrors the picture for use of the projector in various positions with respect to the user(s) and the projection screen;
 - *Picture Format*
selects one of six picture format options (wide screen, super zoom 4:3, 4:3, movie expand 14:9, movie expand 16:9, 16:9 subtitles);
 - *Colour tracking*
selects between 'Vivid' and 'Natural' representation of colours in the picture. 'Vivid' is automatically set when computer input is used; 'Natural' is automatically set when video input is used.
 - *Colour Temperature*
adjusts the overall colour impression from warm to cool. The various colours (red, green and blue) can also be adjusted individually

Display adjustments

- Press Menu and select 'Display' in the menu bar. The following 'Display' adjustments can now be made according to the instructions under 'General explanation':
 - *Digital Freeze*
captures a moving picture (still picture);
 - *Digital Zoom*
enlarges a part of the picture;
 - *Magnification*
adjusts the zoom factor;
 - *Auto image*
automatically sizes and positions the image to fit optimally in the screen picture;
 - *Horizontal size*
adjusts the computer image in a horizontal direction to make the image completely fill the screen;
 - *Phase*
minimises picture imperfections. When connecting the projector to your PC for the first time, be sure to adjust the phase control for optimal readability of the projected text;
 - *Shift*
adjusts the computer image in horizontal and vertical direction to centre it on the screen.

Some examples

The following 'Display' adjustment procedures, follow a slightly different sequence of actions, or may need some further explanation.

Picture Format

'Picture Format' is used to select one of six picture format options (wide screen, super zoom 4:3, 4:3, movie expand 14:9, movie expand 16:9, 16:9 subtitles). Default mode for computer signal input at each start up of the projector is 4:3. For video signal input the picture format will be selected that was selected the last time the projector was switched on.

- 1 Press Menu.

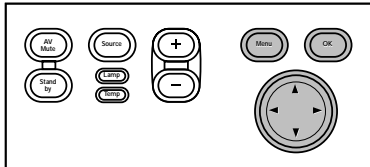

- The menu bar will appear.
 - 'Picture' is highlighted and its sub menu is shown.
- 2 Use Cursor Control to move the cursor to 'Picture Format'.
 - 3 Select the desired picture format.
- Selected picture format is activated. See also 'Vertical shift'.
- 4 If required, select the next item to be adjusted or press Menu to exit.

Vertical Shift**(after selecting picture format for video input signal)**

Due to the scaling of the image when the picture format is changed, it might be possible that a part of the actual image is missing at the top or the bottom of the screen. When one of the picture formats 'super zoom 4:3', 'movie expand 14:9', 'movie expand 16:9', '16:9 subtitles' is selected and confirmed by pressing OK, the Vertical Shift function is activated. This allows you to correct the position of the projected image upwards or downwards. ,

- 1 Use Cursor Control to move the projected image upwards or downwards.
- 2 Press OK to confirm and store the adjustment.
- 3 If required, select the next item to be adjusted or press Menu to exit.

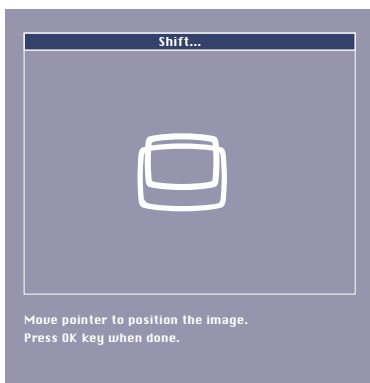

Note When the 'Vertical shift' window has been removed you can also the Cursor Control Up/Down buttons on the projector or the remote control to move the image upwards/downwards.

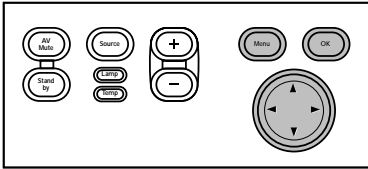

Digital Zoom/Magnification

'Digital Zoom' is used to enlarge a part of the picture.

- 1 Press Menu.
- The menu bar will appear.
- 2 Use Cursor Control to move the cursor to 'Display'.
- 3 Use Cursor Control to move the cursor to 'Digital Zoom'.
- 4 Select 'On' to switch 'Digital Zoom' on.
 - Press OK to continue, or
 - Press Menu to exit and continue with the previous Zoom settings.
- 5 Use the zoom target to select centre of the screen area you wish to enlarge.
 - Press OK to confirm.
- 6 Use the Magnification slider to adjust the Zoom factor.
 - Press OK to confirm and exit the menu.
- 7 Use Cursor Control to select another section of the enlarged area ('Panning').

Note By pressing the D(igital) Zoom button on the remote control you enter directly into the zoom centre selection screen (step 4). When Digital Zoom is already active, pressing the D(igital) Zoom button will show the Magnification slider; pressing the D(igital) Zoom button twice will turn off Digital Zoom.

Auto image

The Auto Image function automatically sizes and positions the image to fit optimally in the screen picture. In addition it takes care for phase adjustment. It does not affect the selected picture format. When Auto Image is set to On, the Horizontal size, Shift and Phase options are greyed out.

Horizontal size

The Horizontal size function is used to size a computer image to make it fit the projected picture. When the OSD menu is active and the horizontal size option is selected, the level will be indicated graphically on a linear scale (slider).

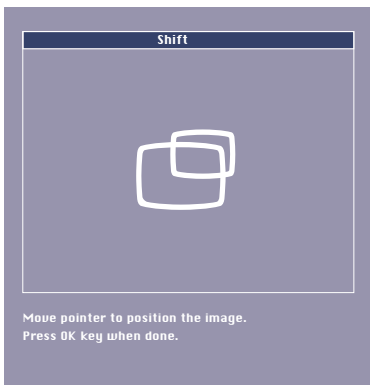
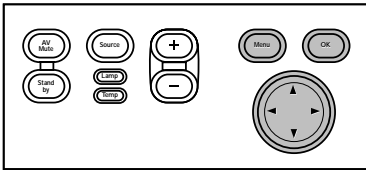
**Shift**

The Shift function adjusts the computer image in horizontal and vertical direction to centre it on the screen. This function is only active when 'Auto image' is set to 'Off'.

- 1 Press Menu.
 - The menu bar will appear.
- 2 Use Cursor Control to move the cursor to 'Display'.
- 3 Use Cursor Control to move the cursor to 'Shift'.
- 4 Press OK to activate Shift.
- 5 Use Cursor Control to position the computer image.
- 6 Press OK to confirm and store the adjustment.
- 7 If required, select the next item to be adjusted or press Menu to exit.

General adjustments

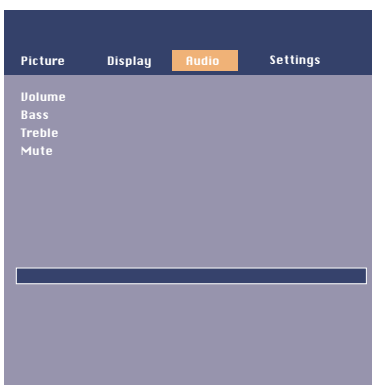
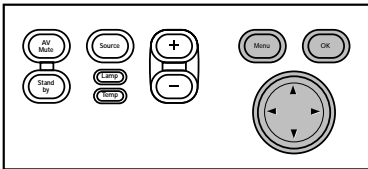

General settings

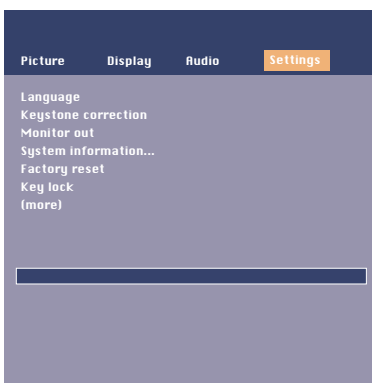
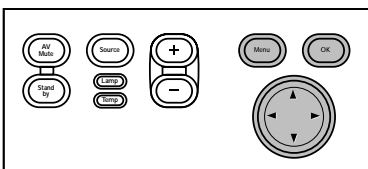

Audio adjustments

- Press Menu and select Audio in the menu bar. The following Audio adjustments can now be made for both Computer, Component and Video/S-video input, according to the instructions under 'General explanation':
 - *Volume*
adjusts the sound level;
 - *Bass*
adjusts the bass tones;
 - *Treble*
adjusts the high tones;
 - *Mute*
mutes the sound of the projector.

The volume can also be adjusted with the – Volume + keys on the remote control and local keyboard.

The projector is equipped with the following functions to optimize its use and handling:

- Press Menu and select Settings in the menu bar. The following settings/adjustments can now be made for both Computer, Component and Video/S-video input, according to the instructions under 'General explanation':
 - *Language*
To select the required menu language;
 - *Keystone correction*
To correct picture distortion of the vertical keystone type by internal scaling;
 - *Monitor out*
Enables image on second monitor connected;
 - *System information*
The System Information sub menu contains an overview of the most relevant projector settings, including information on the hardware and software configuration;
 - *Factory reset*
To reset all user settings to the default factory settings;
 - *Key lock*
To de-activate all remote and local controls. To disable the keylock function keep the OK button pressed for 10 seconds;
 - *Start-up screen*
To display or suppress the default Philips start-up screen upon the projector's start up;
 - *Lamp counter*
To show the operating time of the lamp, which can be reset after a new lamp has been installed;
 - *Auto Standby*
To switch off Auto Standby mode or to select the delay time after which the projector automatically switches to Standby;
 - *Auto Source*
To switch automatic source selection on or off;
 - *Feedback*
To suppress OSD messages. Warning or error messages however are never suppressed.

6. Maintenance



Cleaning Caution

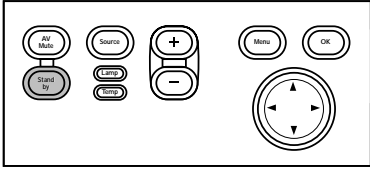

Switch off and disconnect the projector before cleaning.

- 1 Press the Standby button *twice* to switch off the projector.
 - The Standby indicator starts blinking orange.
- 2 Wait until the cooling fan has stopped (about 3 minutes after the projector has been put in Standby) and disconnect the mains lead and all other cables.

Cleaning the cabinet

- When the cabinet is dusty, clean it by gently wiping with a soft cloth.
- A chamois leather slightly moistened with water is sufficient for cleaning the housing.
- Do not use cleaning agents as they may harm the housing.

Cleaning the lens

- When the lens is dirty or dusty, first blow the dust off and then gently wipe with a soft brush or lens cleaning paper. Never touch the lens with your fingers.
 - The lens is likely to become mouldy if left dirty.

Cleaning the dust filter

Make sure to clean the dust filter regularly.

- 1 Switch off the projector and wait until the cooling fan has stopped before disconnecting the projector.
- 2 Turn the projector over. *Never place the projector on the side where the connections are located!*
- 3 Press tab A and remove filter holder B from the projector.
- 4 Press clamp C, open the holder and remove the filter.
- 5 While firmly holding the filter, gently remove any accumulated dust, from the dusty side, with a vacuum cleaner.
- 6 Press clamp C, put the filter back in place and release clamp C. Firmly press the filter edges in place.
- 7 Close the filter holder.
- 8 Press tab A and insert the filter B into the projector.

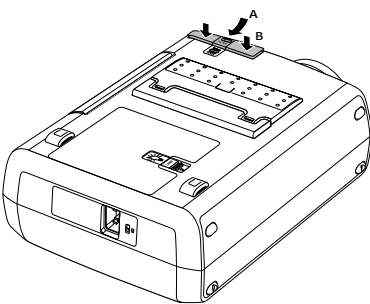
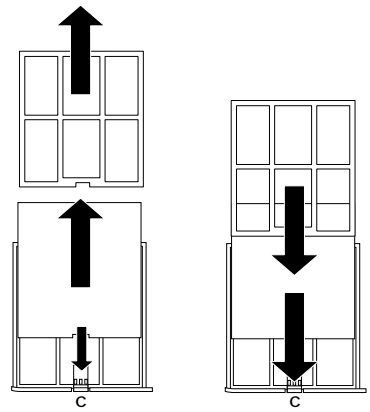
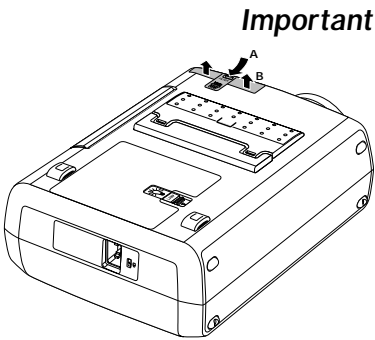

Notes

We advise you to clean the filter every 100 hours. Operating the projector without filter or with a torn or damaged filter may seriously damage the projector.

When the filter is damaged replace it with a filter of the same type (12 nc: 3122 434 0157 0).

The projector power cannot be switched on again unless the filter holder is installed correctly.

Lamp



When operation time reaches the last 100 hours of the average lamp life, the message 'Warning: lamp life has almost expired' will be displayed on the screen, each time the projector is switched on. The lamp indicator lights up orange.

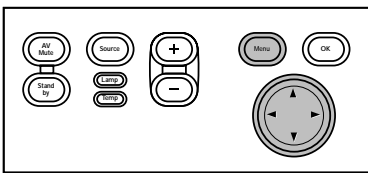

The lamp life remaining can be checked using the OSD menu.

- 1 Press Menu.
 - The menu bar appears on the screen.
- 2 Use Cursor Control to move the cursor to 'Settings'.
- 3 Use Cursor Control to select 'Lamp counter'.

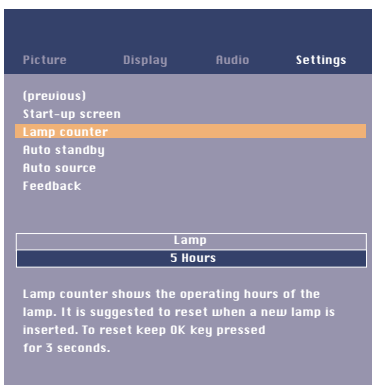

- The remaining lamp life hours are displayed in the action window at the bottom of the screen.

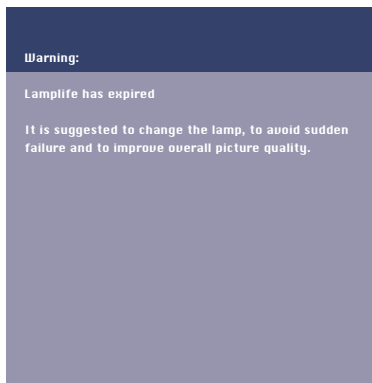

- When the lamp life has expired, the lamp indicator lights up red and the message 'Warning: lamp life has expired' is displayed on the screen.

Lamp Replacement

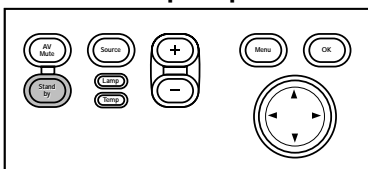

- 1 Switch off the projector and wait until the lamp has cooled down (about 5 minutes) before disconnecting the projector. Remove the mains lead from both projector and wall socket.

The mains lead must be disconnected from the projector otherwise the lamp door cannot be removed.

- 2 Turn the projector over. *Never place the projector on the side where the connections are located!*
- 3 Push tab A to the right and remove the lamp door.
 - When tab A is pressed the mains inlet socket will be partly closed. *The lamp door therefore cannot be removed if the mains lead is not disconnected from the projector.*
- 4 Read the caution and warning labels on the lamp holder.

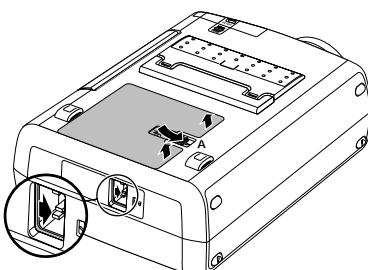

6. Maintenance



Lamp replacement

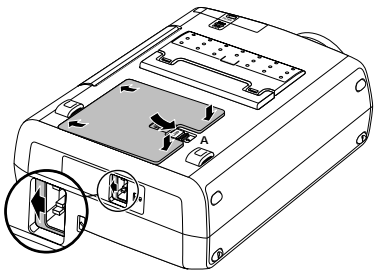
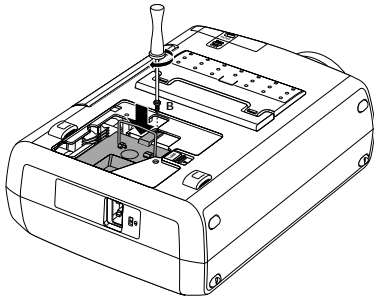
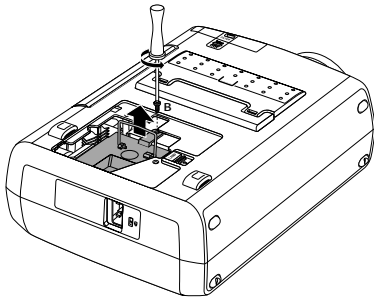

- 5 Unscrew screw B.
- 6 Grasp the lamp holder handle and carefully pull the lamp holder out of the projector.
 - Do not tilt. If the inner tube is broken glass particles may fall out.
 - Keep lamp holder opening to your right. Do not touch lamp or point lamp holder opening at anyone.
- 7 Carefully remove the new lamp housing from its package.
 - Always use the same type of lamp: LCA3116/00 (132 W), 12nc: 8670 931 16009.
 - Do not touch lamp or point lamp housing opening at anyone.
 - Do not drop, as the impact may cause the lamp to break.
- 8 Place the lamp holder in the guiding slots and insert into the lamp compartment.
- 9 Tighten screw B again.
- 10 Put the lamp door back in place and press tab A back in its original position.
 - The Mains inlet socket will open again.
- 11 Insert the mains lead into both the projector Mains inlet socket and the wall socket.
- 12 Press the Standby button to switch on the projector.
- 13 Reset the lamp life time (see 'Resetting the lamplife time').
- 14 Dispose of the old lamp in special chemical disposal bins.

Resetting the lamplife time

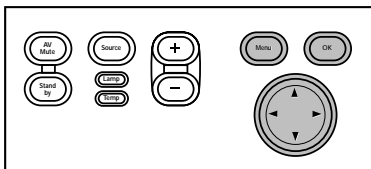

- 1 Press Menu.
 - The menu bar appears on the screen.
- 2 Use cursor control to select 'Settings' in the menu bar.
- 3 Use cursor control to select 'Lamp counter' in the sub menu.
- 4 Press OK for 3 seconds to reset the lamp counter.
- 5 If required, select another item you wish to adjust or press Menu to exit.

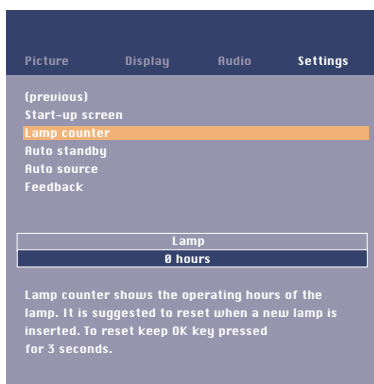

7. Troubleshooting



If a fault occurs, first check the points listed below before taking the projector for repair. If you are unable to remedy a problem by following these hints, consult your dealer or service organisation.

Warning *Under no circumstances should you try to repair the projector yourself as this could invalidate the guarantee.*

Read as follows

Problem	Possible cause Solution
Image is not or incorrectly displayed	General <ul style="list-style-type: none">– <i>Mains lead is not correctly connected.</i><ul style="list-style-type: none">• Correctly connect mains lead. – <i>The filter holder is not installed correctly or is damaged.</i><ul style="list-style-type: none">• Install the filter holder correctly (see 'Cleaning the dust filter' under 'Maintenance'). – <i>Lamp holder cover is not closed correctly or the lamp holder is damaged.</i><ul style="list-style-type: none">• Close the cover correctly (see 'Lamp replacement' under 'Maintenance'). – <i>Signal cable not correctly connected.</i><ul style="list-style-type: none">• Connect signal cable correctly. – <i>The projector is in Off position.</i><ul style="list-style-type: none">• Press Standby to switch on the projector. – <i>A/V Mute active.</i><ul style="list-style-type: none">• Cancel A/V Mute. – <i>'Shift' and/or 'Horizontal size' are not adjusted correctly.</i><ul style="list-style-type: none">• Adjust 'Shift' or 'Horizontal size' (see 'Display adjustment' under 'Operation' - 'On Screen Display Menu').• Activate the 'Auto-image' function via the On Screen Display menu. In Component Video mode <ul style="list-style-type: none">– <i>'Auto Image' has not selected the correct settings for 'Shift' and/or 'Horizontal Size'.</i><ul style="list-style-type: none">• Adjust 'Shift' or 'Horizontal size' (see 'Display adjustment' under 'Operation' - 'On Screen Display Menu').• Activate the 'Auto-image' function via the On Screen Display menu.• Reset all settings to the default factory settings with the 'Factory reset' option in the 'Settings' menu. – <i>Keystoning is applied on a high resolution component signal.</i><ul style="list-style-type: none">• Decrease keystoning until the image is correctly displayed. For this use the the 'Keystone correction' option in the 'Settings' menu.

In Data mode

- *Input resolution is too high (and keystoneing is applied).*
- If you wish to keep the keystone correction, decrease the input resolution until the image is correctly displayed. For this, refer to the User Guide or support information of the computer.
- If you wish to keep the input resolution as it is, decrease keystoneing until the image is correctly displayed. For this, use the 'Keystone correction' option in the 'Settings' menu.

- *Input resolution is too high (and no keystoneing is applied).*
- Decrease the input resolution until the image is correctly displayed. For this, refer to the User Guide or support information of the computer.

In case of RGBS (Scart) connection:

- *Component input will not be selected automatically in case of RGBS connection.*
- Select 'Component input' manually using the Source button on the projector or the remote control.

Poor colour

- Adjust 'Brightness', 'Contrast', 'Saturation' or 'Hue' (see 'Picture adjustment' under 'Operation' - 'On Screen Display Menu').
- Reset all projector settings in the 'Settings' menu ('Factory reset').

Image is blurred

- *Image is not focused.*
- Adjust focus ring.

- *Distance between projector and screen is not correct.*
- Adjust the distance between the projector and the screen.

- *Signal cable is not correctly connected.*
- Connect signal cable correctly.

Picture rolls

- *Signal cable is not correctly connected.*
- Connect signal cable correctly.

No sound

- *Audio cable is not correctly connected.*
- Connect audio cable correctly.

- *Volume is not adjusted properly.*
- Adjust volume.

- *(A/V-)Mute active.*
- Cancel (A/V-)Mute.

The projector does not react to commands from the remote control

- *Distance is too great.*
 - Reduce distance.
- *Batteries are exhausted.*
 - Replace batteries (see 'Inserting the batteries in the remote control').
- *IR sensor is obstructed.*
 - Remove obstacle.

Indicators

Lamp indicator

- green: normal lamp condition.
- orange: lamp life has almost expired (less than 100 hours to go).
 - See warning messages on the start up screen for details.
- red: lamp life has expired.
 - Replace lamp. See 'Maintenance'.
- red (fast blinking): lamp start has failed.
 - Disconnect projector from the mains. Reconnect and restart. If this does not resolve the problem, replace the lamp. See 'Maintenance'.

Temperature indicator

- red: temperature error.
 - The projector will go into Power/Standby mode. Allow the projector to cool down; this may take up to 30 minutes. When the LED goes out press any button to activate the projector again.
- fast blinking red: fan error.
 - The projector will go into Power Standby mode. Make sure the filter cover is closed properly; clean air inlets or dust filter and allow the projector to cool down; this may take up to 30 minutes. When the LED stops flashing press any button to activate the projector again.

Standby indicator (text on Standby button/ring around Standby button)

- red: standby mode.
- green: operation mode.
- orange: warming up.
- slow blinking (orange): cooling down.
 - Do not switch the projector off; it will restart the lamp automatically within a few seconds.

Picture too dark or bright with external monitor connected

- *'Monitor out' has been enabled, but the external monitor is not correctly connected (the picture on both displays is too bright).*
 - Connect the (optional) VGA Y-cable (See 'Connecting to an external monitor' under 'Installation').
 - If the VGA Y-cable is correctly connected, verify whether the input impedance of the monitor is correctly set on 75 Ohm.
- *'Monitor out' has not been enabled, but the external monitor is connected (the picture on both displays is too dark).*
 - Enable the 'Monitor out' option. Press Menu and use cursor control to go to 'Settings' in the menu bar. Select 'Monitor out' and select 'On'.

No reaction when pressing keys on local keyboard or remote control

- *'Keylock' active.*
 - Press OK for 10 seconds to cancel 'Keylock.'

The mouse cursor does not react when using the cursor control on the remote control

General:

- Check that the batteries are installed properly in the remote control and/or replace the batteries.
- Check that the projector receives the signals from the remote control.
- Check that the USB cable or PS/2 cable has been properly connected.
- Check that both projector and computer are switched on.
- Unplug the USB cable or PS/2 cable and then reconnect.

In case of PS/2 connection:

- *The PS/2 mouse of the connected laptop has priority over the projector mouse loop through connection.*
- Disable the PS/2 mouse of the laptop by selecting 'Disable in hardware profile' in the 'Windows Mouse Properties' of the laptop. Then restart 'Windows' on the laptop. The projector mouse loop through connection now has priority while the laptop mouse can still be used.
- Switch off all devices and then reconnect while you make sure that you:
 - connect the PS/2 cable to PC and projector *before* switching on the PC;
 - switch on the projector *before* switching on the PC;
 - *do not* connect the USB cable when making the PS/2 connection.
- Also refer to the User Guide or support information of your computer.

In case of USB connection:

- Connect another USB device (mouse, scanner, webcam, etc.) and see if it works. If it does not work there is a problem with the computer.
- Also refer to the User Guide or support information of the computer.
- *'Windows' did not manage to install the driver correctly. In this case the 'Device manager' will contain a category 'Other devices.'*
 - Disconnect the projector.
 - Remove all items listed under 'Other devices' in the 'Device manager'.
 - Restart the computer.
 - Reconnect the projector.

Computer asks for drivers

- In case the computer asks for monitor drivers, install the drivers on the CD-ROM supplied with the projector.
- In case the computer asks for a USB-device driver, install the required drivers on the CD-ROM supplied with the computer.

Note *The Philips Garbo Matchline projector uses three LCD (Liquid Crystal Display) panels. These panels contain a total of 1,200,000 pixels. As with any equipment, certain tolerances apply to the performance specification of the product. Philips' specifications for defective pixels is very severe. Only one bright blue pixel is allowed. This pixel will not affect the overall picture quality or the life expectancy of the projector.*

Free Manuals Download Website

<http://myh66.com>

<http://usermanuals.us>

<http://www.somanuals.com>

<http://www.4manuals.cc>

<http://www.manual-lib.com>

<http://www.404manual.com>

<http://www.luxmanual.com>

<http://aubethermostatmanual.com>

Golf course search by state

<http://golfingnear.com>

Email search by domain

<http://emailbydomain.com>

Auto manuals search

<http://auto.somanuals.com>

TV manuals search

<http://tv.somanuals.com>