

PHILIPS

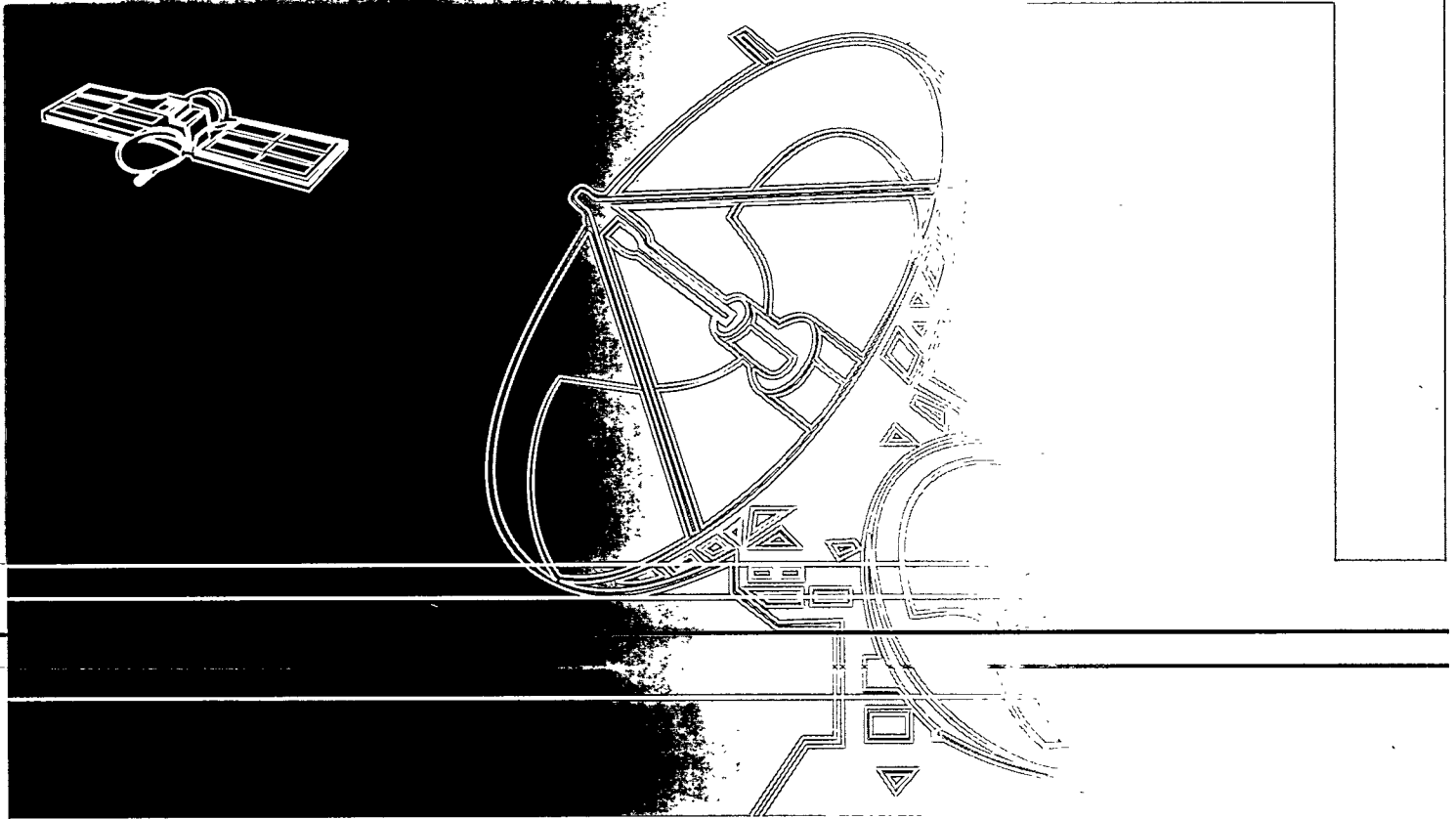

STU130A



PHILIPS

Pick location 2B2-K10-G4		Item 0070	Invoicenummer 5515886-0070		Jave 02	Sort location 04-002	
Cust.code 51522		Quantity 1	01668801500000		J000482273660314		
1958	Stock 74	Invoice and ship to 173637 170755		Order 016688		Date 472	
Qty. SPQ 1	Service code 4822 736 60314		Description GEBRUIKSAANWIJZING			SPQ 1	
					Made in: 407		

About this manual

This manual has been conceived in order to help you to install and use your Philips satellite receiver.

Carefully follow every instructions to ensure you are connecting and installing your equipment as described in sections 2.3.4. and 5.

Your satellite receiver has been factory-programmed along with programme numbers -Refer to programmes list supplied with this manual -

- This small dot in front of a sentence means that **you must do** something.
- This arrow in front of a sentence shows **the result** of your previous action.

Table of contents

Introduction	4
Connections and installation	5
Connecting an audio stereo appliance	5
Installing your modulator	5
Installing your decoder	6
Proceeding the satellite antenna connection.....	6
Using your receiver	7
Watching a satellite programme	7
Recording a programme: Select a satellite programme	7
Locking/Unlocking a programme	8
Modifying the initial programming	9
Modifying parameters	9
Video frequencies	9
Polarization	9
Audio frequencies	10
Decoder mode	11
Troubleshooting	12
Copy function	13

FRONT PANEL

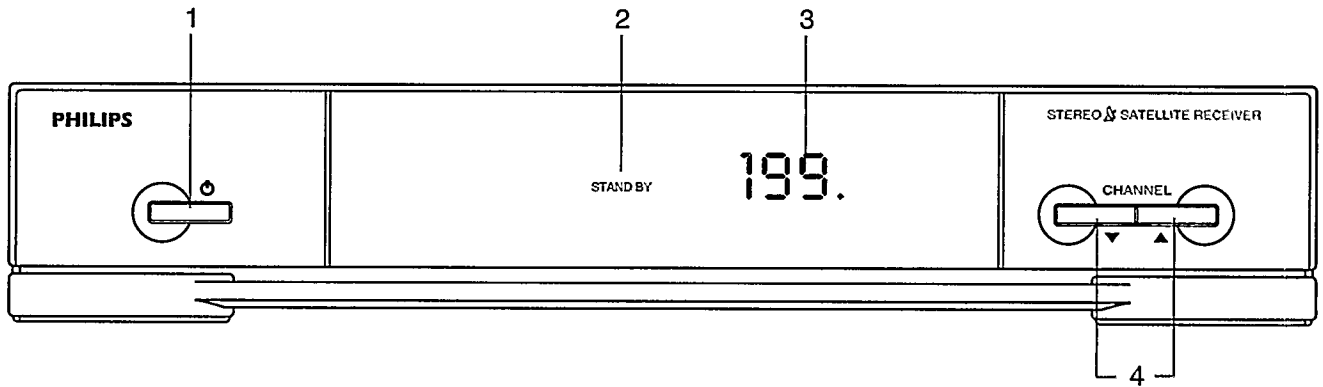

REAR PANEL

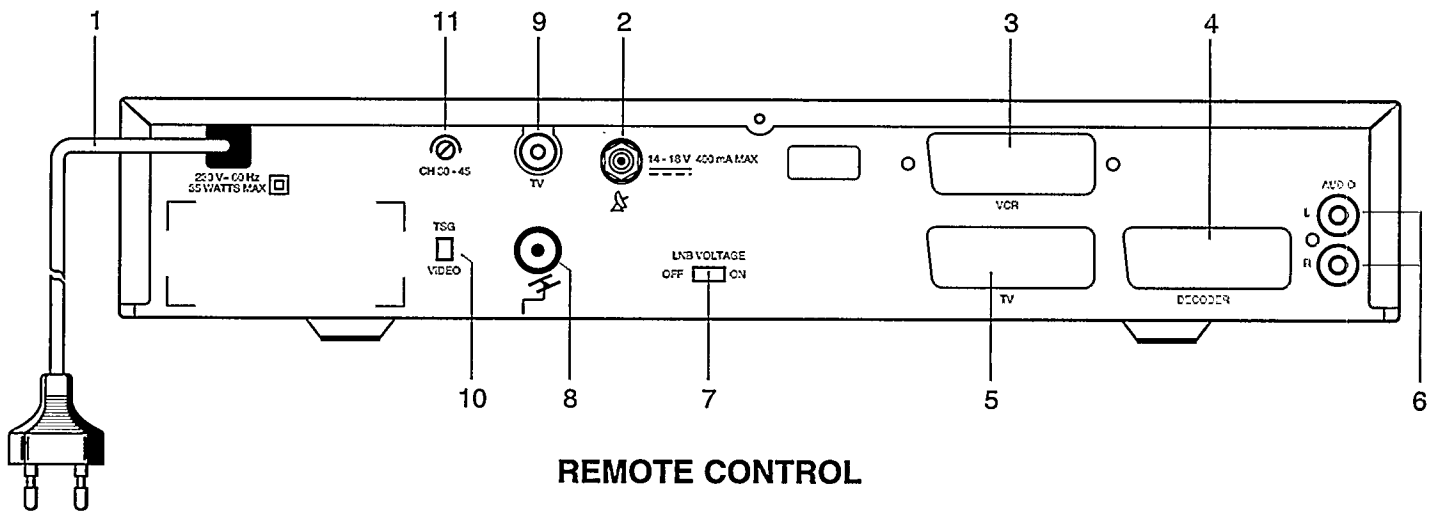

REMOTE CONTROL

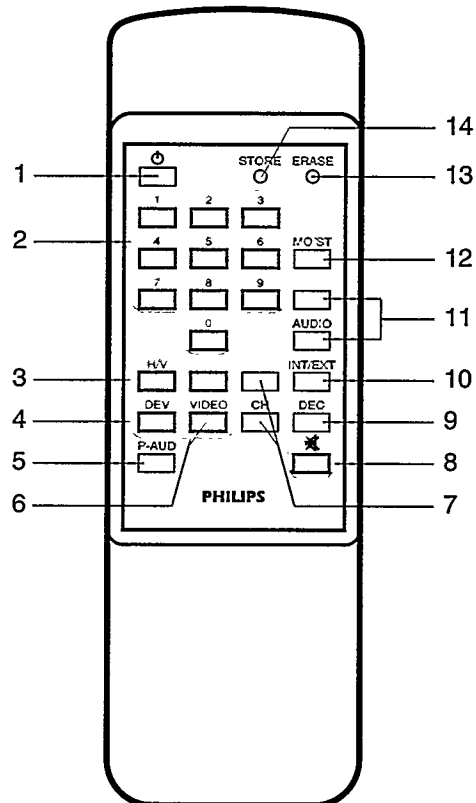

STU 130A

NUMBERS, PLUGS & DISPLAYS FUNCTIONS









FRONT PANEL

- | | |
|--|--|
| 1 - Stand-by key  | 3 - Main LED indicator |
| 2 - Stand-by light | 4 - Channel keys   |

REAR PANEL

- | | |
|---|---|
| 1 - 230 V ~ /50 Hz Power cord | 6 - Audio cinch connector to Hi-Fi System |
| 2 - Satellite antenna input | 7 - ON/OFF LNB Voltage |
| 3 - Euroconnector
for video-recorder | 8 - Terrestrial antenna input  |
| 4 - Euroconnector for
external decoder | 9 - Remodulator output |
| 5 - Euroconnector for TV-set | 10 - TSG/Video, test signal generate |
| | 11 - UHF output tuning channels 30 to 45 |

REMOTE CONTROL

- | | |
|---|--|
| 1 - Stand-by switch  | 9 - Decoder selection DEC |
| 2 - Numerical block | 10 - Internal or external INT/EXT
Selection of audio/video decoding |
| 3 - H/V Polarization switch | 11 - Audio sound frequencies setting   |
| 4 - DEV Contrast setting | 12 - Mono/Stereo MO/ST selection |
| 5 - Audio pre-programming P-AUD | 13 - ERASE - Erasing key |
| 6 - Video frequency setting   | 14 - STORE - Memory storage key |
| 7 - Programmes selection   | |
| 8 - Sound mute  | |

1

Introduction

Safety-related instructions

Dangerous voltage inside. Do not open the cabinet. Repairs should be carried out by qualified service personnel only.

To avoid short-circuits, which may cause fire or electric shock, do not expose this Philips satellite receiver to rain or moisture.

Before connecting the receiver to the mains, check that the mains supply voltage corresponds to the voltage printed on the label on the receiver base. If the mains voltage is different consult your dealer.

Ensure that no objects or fluids pass through the ventilation openings. If liquid is spilled into the receiver, disconnect the receiver from the mains and consult a qualified service technician.

Ensure that air can circulate freely through the ventilation openings of the receiver. Leave a space of at least 3 cm all around the receiver.

Do not place your receiver close to an external source of heat (radiator, etc.) or near appliances generating strong magnetic fields (e.g. motors, transformers).

Do not use your receiver in dusty places or where it may be subject to vibration. Avoid using your receiver immediately after moving from a cold to a warm location and vice versa, or under conditions of high humidity.

If you have to transport your receiver, avoid violent shocks.

For cleaning, use a damp chamois leather. Never use an abrasive.

Your receiver supplies 14 or 18 V DC voltage to your satellite dish antenna. Make sure you connect only your satellite dish to the satellite dish inputs, and nothing else.

Never connect or modify cables while the receiver is connected to the mains.

Do not connect your receiver to the mains yet, but continue reading these instructions.



2 Connections & installation

This chapter explain how to connect your satellite receiver to equipments you already have, such as TV-set and video-recorder.

- o According to your different possibilities, make the connections as follow:

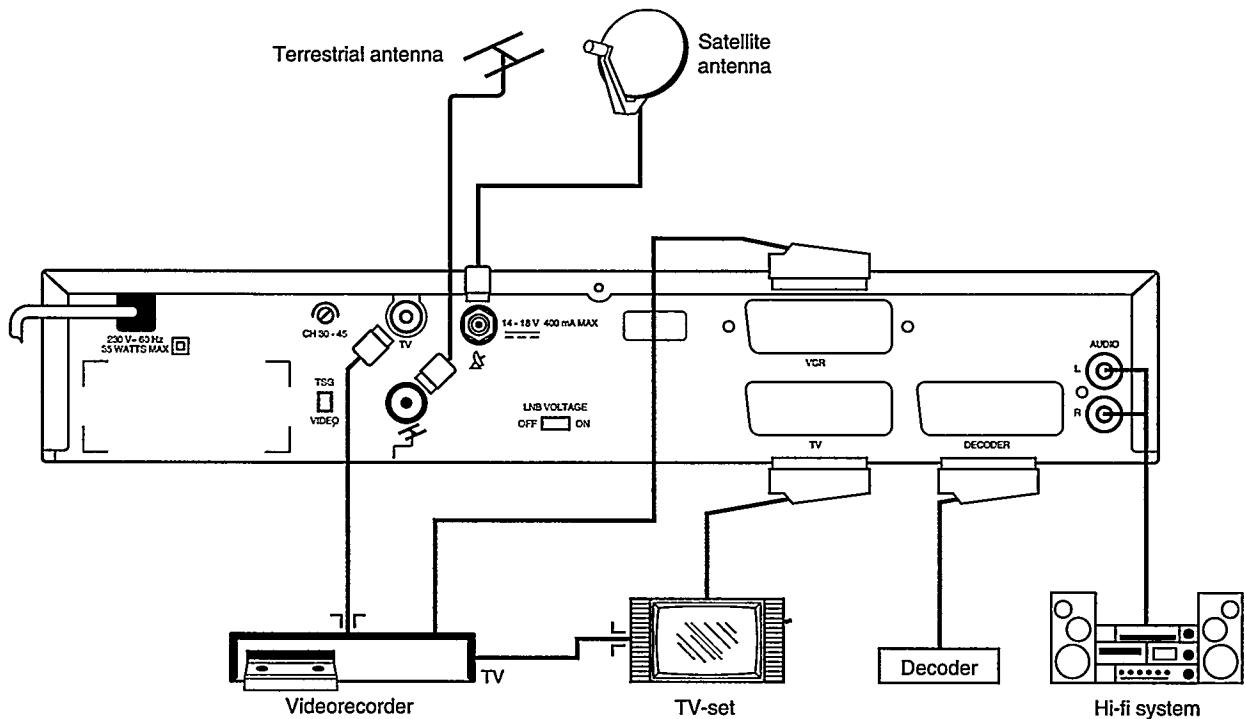

Once the connections are made, except the antenna connection, proceed as follow:

- o Connect your TV-set as well as your video-recorder on mains and switch them ON.
- o Connect your satellite receiver on mains.

How to connect your audio stereo equipment

If you wish to use your Hi-Fi system to listen to programmes, you must connect your stereo installation into the AUDIO cinch connectors on the rear panel of your receiver.

- o Connect the «AUDIO L» -Left channel- and the «AUDIO R» -Right channel- plugs into the right and left input cinch connectors of your stereo equipment.

Do not connect «AUDIO L/R» into the «PHONO» sockets of your stereo equipment.

Installing your remodulator

If you have made coaxial cables antenna connections only you must create a new programme. You must create a new programme on your TV-set -and your video-recorder- to be able to watch satellite programmes. To do that:

- o Place the switch «TSG» -on the rear panel- on the «ON» position.
- o Make sure on your TV-set that the reception of terrestrial channels as well as on your video recorder is not disturbed.

- In case you have interference, select an other frequency by setting the «channel» screw at the back of the receiver with a screwdriver.
- Repeat this operation until there is no more interference on the terrestrial channels as well as on your video-recorder.
- Select a programme number on your TV-set which will always be used for satellite programmes.
- Tune your TV-set until the test picture appears on the screen -black and white bars- .

If you have a video-recorder proceed as follow:

- Select the video-recorder programme number on your TV-set.
- Select a programme number that will always be used for recording satellite programmes. -for example, the same number as the one chosen for satellite programmes on your TV-set-.
- Set your video recorder until the test picture appears on the screen -black and white bars-.
- > The channels on your receiver are tuned.

Installing your decoder

If you have an external decoder, connect it to the euroconnector «Decoder» at the rear of the receiver. The receiver has been factory pre-programmed for some scrambled channels.

If you wish to program or change the type of installation of a decoder refer to Chapter 4 «Decoder Mode».

How to make the connection to the satellite antenna

If you are connected to a collective antenna

To prevent damage to some types of collective antenna, it is necessary to set the supply of your receiver before connecting it.

- If the collective antenna needs no power from the satellite receiver, place the «LNB Voltage» switch at the rear of the receiver to the «OFF» position before connecting the satellite input to the antenna.

Note: For an antenna needing power from a receiver the «LNB Voltage» switch must be on the «ON» position -individual antenna-.

Connection of your antenna

- Switch-off every appliance
- Connect your antenna to the satellite receiver according to the assembly diagrams in Chapter 2.
- Switch on all of your appliance.



Turning your antenna

- Press the ⏪ key on the front panel.
- Select the satellite programme you wish to watch by means of the numerical keys.
- Turn your antenna until the programme appears on your screen.
- Install your antenna according to the directions supplied with your satellite antenna.



3 Using your receiver

Watching a satellite programme

If your satellite receiver and TV-set are connected by a coaxial cable

- Select the channel on your TV-set which is reserved to satellite programmes.
- Press the  key on your remote control to activate your satellite receiver.
- Select a programme by using the   CH keys.
- A picture appears on the screen.





OR If your receiver and TV-set are connected by an euroconnector

- Press the  key on your remote control to activate your satellite receiver.
- Select a programme by using the   CH keys.
- A picture appears on the screen.

Selecting a satellite programme

Your Philips receiver has 199 satellite or radio channels that have been factory pre-programmed.

To select a programme

- Use the   keys on the front panel of the receiver to change programmes or use the CH   keys of the remote control or enter directly the chosen programme number by using the numerical block.
- The front panel display shows the number of the selected programme.

How to record a programme

You can record non satellite programmes as you have always done it. Meanwhile recording satellite programmes is a bit different.

You can use your video-recorder to record satellite programmes mainly in three main ways :

- Record a satellite programme while watching it.
- Record a satellite programme while watching another TV programme -and not another satellite programme-.
- Record a satellite programme while the TV-set is off.

In any case

- Select the satellite programme you wish to record on your receiver.
- If you have connected your equipment using a coaxial cable, select the channel reserved to satellite programmes on your video-recorder.

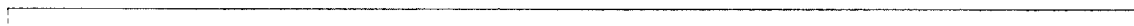

- If you have connected your equipment using an euroconnector cable, select the external mode -EXT- on your video-recorder.
- > You may now proceed with the usual recording procedure. If you wish you may watch another TV program - Terrestrial transmission - or switch off your TV-set.

Locking/Unlocking a programme

Locking

- Select the channel that will be inaccessible -ie: 10-
- > 010 is displayed
- Press the ERASE key of the remote control.
- > E - - is displayed
- Press twice on the «0» key of the remote control.
- > E is displayed then 010 blinks twice.
- > 010 is displayed

Note: Channel 010 is unaccessible at this time by using the CH Δ ∇ keys. The search can only be made by using the numerical block by keyboarding its number.

- Press 0-1-0
- > Display 010

Unlocking

- Enter the programme number on the numerical block -eg: Programme 10-
- > 010 is displayed
- Press «STORE».
- > 010 blinks twice. The programme is now accessible again with the CH Δ ∇ keys.

How to mute the sound

- Press on the \otimes key of the remote control.
- > A green dot blinks on the right of the display and the sound is muted.
- Press again on the \otimes key to reactivate the sound.

How to switch your receiver to stand-by mode ⏻

- Press the ⏻ key on the remote control or on the receiver.
- > A green light turns on and the receiver switches to stand-by.

4

How to modify the initial programming of your receiver

How to modify the parameters of a programme

Video frequencies

Use one of the keys of the remote control «VIDEO» Δ or ∇ . The selection of the frequency -from 920 to 2.050 MHz- is made by steps of 250 kHz. If the VIDEO FREQUENCY MODE is activated, the frequency may be entered by the numerical block from 0 to 9.

Note: By direct entry through the numerical keys, for frequency inferior to 1000 MHz, it is necessary to enter 0 first.

For example:

<u>Enter</u>	<u>Display</u>	<u>Frequency input (MHz)</u>	<u>Frequency band in (MHz)</u>
o 0950	> 950	950	920 to 999
o 1950	> 9.50	1950	1000 to 1999
o 2050	> 0.50	2050	2000 to 2050

Picture contrast -DEV-

- o Press the DEV key to adjust the picture contrast.
- > 2 positions «LO» video deviation of 16 MHz
- «HI» video deviation of 25 MHz

Polarization

The H/V key allows the choice of the LNC supply

	<u>Display</u>	<u>LNB voltage</u>	<u>Polarization</u>
o Press H/V	> (-H-)	18 V	Horizontal
o Press H/V	> (-V-)	14 V	Vertical

To chose the tone control -22 kHz-

- o Press H/V
- o Then on «0» key on the numerical block.
- > Display ON or OFF -Meaning 22 kHz «ON» or «OFF»

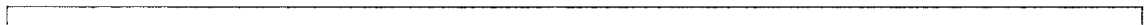

Audio frequencies

The user can chose between two modes:

1) Pre-programmed audio frequencies

- Press P-AUD on the remote control to obtain the chosen audio frequency.
- First press: Display P-A
- Next presses: Switch to pre-programmed frequencies
- Press «STORE» to memorize your choice.
- A01-A05 in MONO/LARGE
- A06-A013 in MONO/NARROW
- A14-A17 in STEREO

Refer to the following table

Display	Right Frequency MHz	Left Frequency MHz	Mode
A01	6.50	-	MONO 50 μ
A02	6.60	-	MONO 50 μ
A03	6.65	-	MONO 50 μ
A04	5.80	-	MONO J17
A05	6.60	-	MONO J17
A06	7.02	-	MONO 75 μ
A07	7.20	-	MONO 75 μ
A08	7.38	-	MONO 75 μ
A09	7.56	-	MONO 75 μ
A10	7.74	-	MONO 75 μ
A11	7.92	-	MONO 75 μ
A12	8.10	-	MONO 75 μ
A13	8.28	-	MONO 75 μ
A14	7.02	7.20	STEREO 75 μ
A15	7.38	7.56	STEREO 75 μ
A16	7.74	7.92	STEREO 75 μ
A17	8.10	8.28	STEREO 75 μ

2) Manual tuning of the audio frequency

- Press the AUDIO Δ ∇ key of the remote control.
- The corresponding frequency to the programme is displayed.
- Press once more on AUDIO Δ ∇ to adjust the audio frequency of your choice.
- Press «STORE» to memorize your choice.

It is also possible to enter directly the audio frequency through the numerical keyboard.

- Press AUDIO Δ ∇ .
- The corresponding frequency is displayed.
- Enter directly the 3 digits of the chosen frequency -eg: 6-5-0-
- Press «STORE» to memorize your choice.

3) Tuning MONO/STEREO

- Press MO/ST
- ▽ The corresponding programme mode is displayed.
- Press on MO/ST again, to switch to the chosen mode.

<u>Mode</u>	<u>Display</u>
Mono/large	- - 50 µs or J17 Press 9 to switch from 50 µs to J17 and vice versa
Mono/Etroit	- - 75 µs only
Stereo	□ - □ 75 µs only

- Press «STORE» to memorize your choice.

Decoder Mode

1) Choise of type of decoding

- Press DEC to select «DECODING».

DISPLAY	MEANING
d-1	Canal +, Canal satellite, Première, Vidéocrypt...
d-2	France Supervision, Canal + 16/9, Cine/cinema 16/9 Filmnet (Base band MAC)
d-3	Base band PAL

- Press «STORE» to memorize your choice.

2) The key INT/EXT allows to select the type of internal or external decoding of the AUDIO and VIDEO sources.

- Press on the INT/EXT key to switch from one mode to the other one.

	DISPLAY	AUDIO	VIDEO
▽	I - I	Internal	Internal
▽	E - I	External	Internal
▽	I - E	Internal	External
▽	E - E	External	External

- Press «STORE» to memorize your choice.



5

Troubleshooting

PROBLEM	POSSIBLE CAUSE	CORRECTION
No picture, no sound and no display	Receiver off.	Check mains plug
No picture, no sound. Correct display.	If you use the coaxial cable connection only, TV-set and receiver are not tuned on the same UHF channel.	Check your equipment and refer to the Installation Chapter.
	Faulty cables connections -broken or corroded cable-.	Check every connection.
	The antenna does not pick up the satellite signal	Check if the programme corresponds to the wanted satellite.
	The converter power supply is shut off.	Check the coax link between the receiver and the converter. Check if the «LNB Voltage» switch on the rear panel is «ON».
	The converter power supply is shorted.	Switch to stand-by mode during few seconds before resetting.
Correct picture. Poor sound or no sound	Audio programming parameters are wrong.	Check the audio programming parameters.
No picture, correct sound quality.	The decoder programming parameters are wrong.	Check the audio programming parameters.
Poor picture quality.	The antenna is improperly pointed.	Point the antenna.
	The transmitted signal is too weak.	Install a larger antenna.
Wave effect on picture during satellite reception ; Correct terrestrial reception.	Interference on the UHF channel on which the receiver is transmitting. (eg: terrestrial stations or video-recorder on the same channel.	Set receiver and TV-set on another interference-free channel.
Satellite receiver is not activated by the remote control unit.	No or low batteries inside the remote control unit.	Check and replace if necessary.

6 Copy function

Important

The «COPY FUNCTION» is described below. You will use it to «program» another receiver, in other words, to transfer all data within the receiver's internal memory. This includes all tunings done.

The data transfer will be operated from the MASTER to the SLAVE receiver.

Copy function

- Disconnect the equipment from mains.
- Connect the DECODER euroconnector of the MASTER receiver to the TV euroconnector of the SLAVE receiver by means of a full scart cable.
- Connect the equipments to the mains and switch them ON.
- Make sure that both equipments are set on programme 001.
- Switch both receivers back to stand-by mode.
- Shortly press Δ programme key on SLAVE receiver.
 - -r- is displayed.
- Shortly press ∇ programme key on MASTER receiver.
 - -t - is displayed.
- The display on each receiver blinks and the copy functions starts.
 - 001 --> 002 --> 003 --> ... --> 199 displays in sequence.
 - At the transmission end, the figures CXX on the displays must be identical.
 - After few seconds both equipments return to the stand-by mode.

Note :

Repeat this operation if the figures CXX are different when transmission ends.

Press \odot key to quit the copy function mode before the transmission starts. If the transmission is already started, disconnect the equipment from the mains to quit.

STU 130A

PAL/SECAM Satellite receiver

PICTURE QUALITY

- PAL & SECAM Satellite signal reception.
- Compatible for reception of MAC signals with MAC Decoder.
- MAC signals transferred to TV-set by RVB for better picture quality.
- Compatible with external decoder.

AUDIO

- 4 stereo selections.
- 13 Mono selections.
- Possible tuning for non-standard stereo and mono channels.
- Deemphasis selection.
- ASTRA Compatible.

FUNCTIONS

- 199 Pre-programmed channels.
- RADIO programmes listening.
- All functions activated by remote control unit.
- Multifunction display.
- Programmes locking.

VIDEO

- PAL/SECAM : 5 MHz

AUDIO

Frequency response
(DIN 45500) : 20 Hz to 15 kHz

- MONO : Tunable from 5.6 to 9.90 MHz (13 preselected)
- STEREO : Tunable from 5.6 to 9.90 MHz by steps of 180 kHz -4 preselected-

Deemphasis selection : 50 μ s, J17, 75 μ s
Bandwidth : 130/280 kHz

RECEPTION

- Frequency band : 920-2050 MHz
- Input level : 47 to 77 dB μ V (75 Ω)
- Input bandwidth : 27 MHz
- Demodulator : CCIR/G
- Frequency shift : 16/25 MHz/V
- Band : Ku band

INTERFACE FOR SATELLITE ANTENNA

Input : Type F Connector
LNB Voltage : 0V/14 V/18V (400mA)
Selected by user

Polarization command : «MARCONI Type»
14/18

Tone : 22 kHz -ON/OFF-

MISCELLANEOUS

Environmental temperature : +5 to 45°C - 41 to 113°F-
Power supply : 230 V ~ -10% +6% 50 Hz
Consumption : \leq 35 W
Standby Consumption : \leq 16 W
Gross weigh : 4 kg - 18 lbs -
Dimensions (H x L x D) : 70 x 375 x 275 mm
Package dimensions : 100 x 430 x 360 mm

CONNECTIONS

- TV : Euroconnector (RVB & CVBS)
- Video-recorder : Euroconnector (CVBS)
- Décodeur : Euroconnector (base band CVBS output ; RVB & CVBS inputs).
- Audio : Cinch (RCA) plug -left and right- 500 mV.
- UHF Modulator : Tunable from 30 to 45 - set on channel 43-
: Terrestrial antenna input - female IEC-
: Terrestrial antenne output - male IEC-

ACCESSORIES

Remote control unit : 2 x 1.5V AAA batteries.
User's Manual.
European warranty booklet.

PROGRAMME LIST PROGRAMMLISTE

STU 130 A/00G

The STU130A satellite receiver allows access to all TV or RADIO programmes listed below. This list is also stored in your receiver to facilitate the receiver installation. Assumption has been made that you have connected an FSS or a TELECOM LNB on the antenna input. If this is not the case you should have to modify some settings in your receiver.
(please refer to the user manual for more instructions)

Ihr STU130A Satellitenempfänger ermöglicht Ihnen den direkten Zugang der nachfolgenden TV- oder Radioprogrammen. Um Ihnen die Installation zu erleichtern, sind die Daten dieser Programmen im Empfänger vorprogrammiert. Dazu wurde angenommen das am Antenneneingang ein FSS LNC-Typ, oder ein Telecom LNC-Typ angeschlossen ist. Ist dies nicht der Fall, müssen betreffende Systemwerte geändert werden. Bitte folgen Sie dazu sorgfältig die Anweisung in der Bedienungsanleitung.

PROGRAMMES

Programme	DEV.video	Sat Freq	Int Freq	Pol.	Audio Mode	Audio freq.	Deemph.	Pay TV	
Programme	DEV.video	Sat Freq	Int Freq	Pol.	Audio Mode	Audio freq.	Deemph.	Verschlüsselt	
Programme	DEV.video	Sat Freq (MHz)	Int Freq (MHz)	Pol.	Mode Audio	Freq. audio (MHZ)	Deemph.	TV payante	
ASTRA 1A-1B-1C-1D (19,2° E)					LNB LOCAL OSCILLATOR = 9.75 GHz				
1	ARD (D)	LOW	11494	1744	H	STEREO	7.02 / 7.20	75-µs	
2	ZDF (D)	LOW	10964	1214	H	STEREO	7.02 / 7.20	75-µs	
3	Nord-3 (D)	LOW	11582	1832	H	STEREO	7.02 / 7.20	75-µs	
4	RTL (D)	LOW	11229	1479	V	STEREO	7.02 / 7.20	75-µs	
5	SAT-1 (D)	LOW	11288	1538	V	STEREO	7.02 / 7.20	75-µs	
6	RTL-2 (D)	LOW	11214	1464	H	STEREO	7.02 / 7.20	75-µs	
7	PRO-7 (D)	LOW	11406	1656	V	STEREO	7.02 / 7.20	75-µs	
8	VOX (D)	LOW	11273	1523	H	STEREO	7.02 / 7.20	75-µs	
9	DSF (D)	LOW	11523	1773	H	STEREO	7.02 / 7.20	75-µs	
10	n-tv (D)	LOW	11641	1891	H	STEREO	7.02 / 7.20	75-µs	
11	3-sat (D)	LOW	11347	1597	V	STEREO	7.02 / 7.20	75-µs	
12	MDR (D)	LOW	11112	1362	H	STEREO	7.02 / 7.20	75-µs	
13	West-3 (D)	LOW	11053	1303	H	STEREO	7.02 / 7.20	75-µs	
14	Sud-West-3 (D)	LOW	11186	1436	V	STEREO	7.02 / 7.20	75-µs	
15	Bayern-3 (D)	LOW	11141	1391	H	STEREO	7.02 / 7.20	75-µs	
16	Premiere (D)	LOW	11464	1714	H	STEREO	7.02 / 7.20	75-µs	
17	Teleclub (CH)	LOW	11332	1582	H	STEREO	7.02 / 7.20	75-µs	
18	MTV EUROPE (GB)	LOW	11421	1671	H	STEREO	7.02 / 7.20	75-µs	
19	Cartoon-network (GB)	LOW	11023	1273	H	STEREO	7.02 / 7.20	75-µs	
20	CNN (USA)	LOW	11627	1877	V	STEREO	7.02 / 7.20	75-µs	
21	Eurosport (D)	LOW	11259	1509	V	MONO NARROW	7.20	75-µs	
22	Sky-news (GB)	LOW	11377	1627	V	STEREO	7.02 / 7.20	75-µs	
23	Sky-one (GB)	LOW	11318	1568	V	STEREO	7.02 / 7.20	75-µs	
24	Children Channel (GB)	LOW	10994	1244	H	STEREO	7.02 / 7.20	75-µs	
25	UK-Living (GB)	LOW	10979	1229	V	STEREO	7.02 / 7.20	75-µs	
26	UK-gold	LOW	11553	1803	H	STEREO	7.02 / 7.20	75-µs	
27	Movie Channel (GB)	LOW	11479	1729	V	STEREO	7.02 / 7.20	75-µs	
28	Sky-Movies (GB)	LOW	11436	1686	V	STEREO	7.02 / 7.20	75-µs	
29	Sky-Sports (GB)	LOW	11509	1759	V	STEREO	7.02 / 7.20	75-µs	
30	Bravo/adult (GB)	LOW	11097	1347	V	STEREO	7.02 / 7.20	75-µs	
31	Nickelodeon	LOW	11597	1847	V	STEREO	7.02 / 7.20	75-µs	
32	QVC	LOW	11038	1288	V	STEREO	7.02 / 7.20	75-µs	
33	Discovery	LOW	11082	1332	H	STEREO	7.02 / 7.20	75-µs	
34	Filmnet movies	LOW	10921	1171	H	STEREO	7.02 / 7.20	75-µs	
35	RTL-4 (NL)	LOW	11391	1641	H	STEREO	7.02 / 7.20	75-µs	
36	RTL-5 (NL)	LOW	10936	1186	V	STEREO	7.02 / 7.20	75-µs	
37	Galavision (E)	LOW	11127	1377	V	STEREO	7.02 / 7.20	75-µs	
38	Documania(E)	LOW	11686	1936	V	STEREO	7.02 / 7.20	75-µs	
39	Cinemanla (E)	LOW	11656	1906	V	STEREO	7.02 / 7.20	75-µs	
40	Cineclassics (E)	LOW	11068	1318	V	STEREO	7.02 / 7.20	75-µs	
41	MINIMAX (E)	LOW	11009	1259	V	STEREO	7.02 / 7.20	75-µs	
42	TV - 3 (S)	LOW	11244	1494	H	STEREO	7.02 / 7.20	75-µs	
43	TV - 3 (DK)	LOW	11612	1862	H	STEREO	7.02 / 7.20	75-µs	
44	TV - 3 (N)	LOW	11671	1921	H	STEREO	7.02 / 7.20	75-µs	
45	TV1000 (S)	LOW	11303	1553	H	DIGITAL	7.02 / 7.20	75-µs	
46	Filmnet + (GB)	LOW	11362	1612	H	DIGITAL	7.02 / 7.20	75-µs	
47	BBC 1 radio	LOW	10979	1229	V	STEREO	7.28 / 7.56	75-µs	
48	BBC 3 radio	LOW	10979	1229	V	STEREO	7.74 / 7.92	75-µs	
49	Sky radio	LOW	11318	1568	V	STEREO	7.38 / 7.56	75-µs	
50	BBC world	LOW	11553	1803	H	MONO NARROW	7.38	75-µs	

TV PROGRAMMES

Programme	DEV.video	Sat Freq	Int Freq	Pol.	Audio Mode	Audio freq.	Deemph.	Pay TV
Programme	DEV.video	Sat Freq	Int Freq	Pol.	Audio Mode	Audio freq.	Deemph.	Verschlüsselt
Programme	DEV.video	Sat Freq	Int Freq	Pol.	Mode Audio	Freq. audio	Deemph.	TV payante
		(MHz)	(MHz)			(MHz)		
ASTRA 1A-1B-1C-1D (19,2° E) LNB LOCAL OSCILLATOR = 10.000 GHz								
51	ARD (D)	LOW	11494	1494	H	STEREO	7.02 / 7.20	75-µs
52	ZDF (D)	LOW	10964	0964	H	STEREO	7.02 / 7.20	75-µs
53	Nord-3 (D)	LOW	11582	1582	H	STEREO	7.02 / 7.20	75-µs
54	RTL (D)	LOW	11229	1229	V	STEREO	7.02 / 7.20	75-µs
55	SAT-1 (D)	LOW	11288	1288	V	STEREO	7.02 / 7.20	75-µs
56	RTL-2 (D)	LOW	11214	1214	H	STEREO	7.02 / 7.20	75-µs
57	PRO-7 (D)	LOW	11406	1406	V	STEREO	7.02 / 7.20	75-µs
58	VOX (D)	LOW	11273	1273	H	STEREO	7.02 / 7.20	75-µs
59	DSF (D)	LOW	11523	1523	H	STEREO	7.02 / 7.20	75-µs
60	n-tv (D)	LOW	11641	1641	H	STEREO	7.02 / 7.20	75-µs
61	3-sat (D)	LOW	11347	1347	V	STEREO	7.02 / 7.20	75-µs
62	MDR (D)	LOW	11112	1112	H	STEREO	7.02 / 7.20	75-µs
63	West-3 (D)	LOW	11053	1053	H	STEREO	7.02 / 7.20	75-µs
64	Sud-West-3 (D)	LOW	11186	1186	V	STEREO	7.02 / 7.20	75-µs
65	Bayern-3 (D)	LOW	11141	1141	H	STEREO	7.02 / 7.20	75-µs
66	Premiere (D)	LOW	11464	1464	H	STEREO	7.02 / 7.20	75-µs
67	Teleclub (CH)	LOW	11332	1332	H	STEREO	7.02 / 7.20	75-µs
68	MTV EUROPE (GB)	LOW	11421	1421	H	STEREO	7.02 / 7.20	75-µs
69	Cartoon-network (GB)	LOW	11023	1023	H	STEREO	7.02 / 7.20	75-µs
70	CNN (USA)	LOW	11627	1627	V	STEREO	7.02 / 7.20	75-µs
71	Eurosport (D)	LOW	11259	1259	V	MONO NARROW	7.20	75-µs
72	Sky-news (GB)	LOW	11377	1377	V	STEREO	7.02 / 7.20	75-µs
73	Sky-one (GB)	LOW	11318	1318	V	STEREO	7.02 / 7.20	75-µs
74	Children Channel (GB)	LOW	10994	0994	H	STEREO	7.02 / 7.20	75-µs
75	UK-Living (GB)	LOW	10979	0979	V	STEREO	7.02 / 7.20	75-µs
76	UK-gold	LOW	11553	1553	H	STEREO	7.02 / 7.20	75-µs
77	Movie Channel (GB)	LOW	11479	1479	V	STEREO	7.02 / 7.20	75-µs
78	Sky-Movies (GB)	LOW	11436	1436	V	STEREO	7.02 / 7.20	75-µs
79	Sky-Sports (GB)	LOW	11509	1509	V	STEREO	7.02 / 7.20	75-µs
80	Bravo/adult (GB)	LOW	11097	1097	V	STEREO	7.02 / 7.20	75-µs
81	Nickelodeon	LOW	11597	1597	V	STEREO	7.02 / 7.20	75-µs
82	QVC	LOW	11038	1038	V	STEREO	7.02 / 7.20	75-µs
83	Discovery	LOW	11082	1082	H	STEREO	7.02 / 7.20	75-µs
84	Filmnet movies	LOW	10921	0921	H	STEREO	7.02 / 7.20	75-µs
85	RTL-4 (NL)	LOW	11391	1391	H	STEREO	7.02 / 7.20	75-µs
86	RTL-5 (NL)	LOW	10936	0936	V	STEREO	7.02 / 7.20	75-µs
87	Galavision (E)	LOW	11127	1127	V	STEREO	7.02 / 7.20	75-µs
88	Documania(E)	LOW	11686	1686	V	STEREO	7.02 / 7.20	75-µs
89	Cinermania (E)	LOW	11656	1656	V	STEREO	7.02 / 7.20	75-µs
90	Cineclassics (E)	LOW	11068	1068	V	STEREO	7.02 / 7.20	75-µs
91	MINIMAX (E)	LOW	11009	1009	V	STEREO	7.02 / 7.20	75-µs
92	TV - 3 (S)	LOW	11244	1244	H	STEREO	7.02 / 7.20	75-µs
93	TV - 3 (DK)	LOW	11612	1612	H	STEREO	7.02 / 7.20	75-µs
94	TV - 3 (N)	LOW	11671	1671	H	STEREO	7.02 / 7.20	75-µs
95	TV1000 (S)	LOW	11303	1303	H	DIGITAL	7.02 / 7.20	75-µs
96	Filmnet + (GB)	LOW	11362	1362	H	DIGITAL	7.02 / 7.20	75-µs
97	BBC 1 radio	LOW	10979	0979	V	STEREO	7.28 / 7.56	75-µs
98	BBC 3 radio	LOW	10979	0979	V	STEREO	7.74 / 7.92	75-µs
99	Sky radio	LOW	11318	1318	V	STEREO	7.38 / 7.56	75-µs
100	BBC world	LOW	11553	1553	H	MONO NARROW	7.38	75-µs
TELECOM 2B (5° W) LNB LOCAL OSCILLATOR = 11.475 GHz								
101	TF-1 (F)	HIGHT	12690	1215	V	MONO WIDE	5.80	J17
102	France-2 (F)	HIGHT	12564	1089	V	MONO WIDE	5.80	J17
103	TMC (F)	HIGHT	12648	1173	V	MONO WIDE	5.80	J17
104	RTL (F)	HIGHT	12732	1257	V	MONO WIDE	5.80	J17
105	ARTE (F)	HIGHT	12606	1131	V	MONO WIDE	5.80	J17
106	M6 (F)	HIGHT	12522	1047	V	MONO WIDE	5.80	J17
107	LCI (F)	HIGHT	12585	1110	H	MONO WIDE	6.60	50-µs
TELECOM 2A (8° W) LNB LOCAL OSCILLATOR = 11.475 GHz								
108	Canal Plus 4/3 (F)	HIGHT	12648	1173	V	STEREO	7.02 / 7.20	75-µs
109	MCM (F)	HIGHT	12543	1068	H	STEREO	7.02 / 7.20	75-µs
110	Eurosport (F)	HIGHT	12711	1236	H	MONO WIDE	6.60	50-µs
111	Planete (F)	HIGHT	12585	1110	H	MONO WIDE	6.60	50-µs
112	Canal Jimmy (F)	HIGHT	12732	1257	V	MONO WIDE	6.60	50-µs
113	Cine-Cinema (F)	HIGHT	12669	1194	H	MONO WIDE	7.20	50-µs
114	Cine-Cinefil (F)	HIGHT	12627	1152	H	MONO WIDE	7.20	50-µs
115	Paris Premiere (F)	HIGHT	12564	1089	V	MONO WIDE	7.20	50-µs
116	Supervision 16/9 (F)	HIGHT	12606	1131	V	MONO WIDE	7.02 / 7.20	75-µs
117	C +16/9 (F)	HIGHT	12522	1047	V	STEREO	7.02 / 7.20	75-µs
118	Cine-Cinema 16/9 (F)	HIGHT	12690	1215	V	STEREO	7.02 / 7.20	75-µs
119	RTL radio	HIGHT	12606	1131	V	MONO WIDE	6.85	J17
120	Europe 1	HIGHT	12522	1047	V	MONO WIDE	6.85	J17
TELECOM 2B (5° W) LNB LOCAL OSCILLATOR = 11.0 GHz								
121	TF-1 (F)	HIGHT	12690	1690	V	MONO WIDE	5.80	J17
122	France-2 (F)	HIGHT	12564	1564	V	MONO WIDE	5.80	J17
123	TMC (F)	HIGHT	12648	1648	V	MONO WIDE	5.80	J17
124	RTL (F)	HIGHT	12732	1732	V	MONO WIDE	5.80	J17
125	ARTE (F)	HIGHT	12606	1606	V	MONO WIDE	5.80	J17
126	M6 (F)	HIGHT	12522	1522	V	MONO WIDE	5.80	J17
127	LCI (F)	HIGHT	12585	1585	H	MONO WIDE	6.60	50-µs

Programme	DEV.video	Sat Freq	Int Freq	Pol.	Audio Mode	Audio freq.	Deemph.	Pay TV
Programme	DEV.video	Sat Freq	Int Freq	Pol.	Audio Mode	Audio freq.	Deemph.	Verschlüsselt
Programme	DEV.video	Sat Freq	Int Freq	Pol.	Mode Audio	Freq. audio	Deemph.	TV payante
		(MHz)	(MHz)			(MHz)		
TELECOM 2A (8° W)		LNB LOCAL OSCILLATOR = 11.0 GHz						
128 Canal Plus 4/3 (F)	HIGHT	12648	1648	V	STEREO	7.02 / 7.20	75-µs	DEC 1 I/E
129 MCM (F)	HIGHT	12543	1543	H	STEREO	7.02 / 7.20	75-µs	DEC 1 I/E
130 Eurosport (F)	HIGHT	12711	1711	H	MONO WIDE	6.60	50-µs	DEC 1 E/E
131 Planete (F)	HIGHT	12585	1585	H	MONO WIDE	6.60	50-µs	DEC 1 E/E
132 Canal Jimmy (F)	HIGHT	12732	1732	V	MONO WIDE	6.60	50-µs	DEC 1 E/E
133 Cine-Cinema (F)	HIGHT	12669	1669	H	MONO WIDE	7.20	50-µs	DEC 1 E1E
134 Cine-Cinefil (F)	HIGHT	12627	1627	H	MONO WIDE	7.20	50-µs	DEC 1 E1E
135 Paris Premiere (F)	HIGHT	12564	1564	V	MONO WIDE	7.20	50-µs	DEC 1 E1E
136 Supervision 16/9 (F)	HIGHT	12606	1606	V	MONO WIDE	7.02 / 7.20	75-µs	DEC 2 E1E
137 C +16/9 (F)	HIGHT	12522	1522	V	STEREO	7.02 / 7.20	75-µs	DEC 2 E1E
138 Cine-Cinema 16/9 (F)	HIGHT	12690	1690	V	STEREO	7.02 / 7.20	75-µs	DEC 2 E1E
139 RTL radio	HIGHT	12606	1606	V	MONO WIDE	6.85	J17	
140 Europe 1	HIGHT	12522	1522	V	MONO WIDE	6.85	J17	
EUTELSAT 2F3 (16° E)		LNB LOCAL OSCILLATOR = 9.75 GHz						
141 RTM	HIGHT	10972	1222	V	MONO WIDE	6.60	50-µs	
142 TV-7	HIGHT	11658	1908	V	MONO WIDE	6.60	50-µs	
143 ESC	HIGHT	11178	1428	V	MONO WIDE	6.60	50-µs	
144 TGRT	HIGHT	11095	1345	V	MONO WIDE	6.65	50-µs	
145 HBB-TV (TR)	HIGHT	11617	1867	V	STEREO	7.02 / 7.20	75-µs	
146 TV-POLONIA (PL)	HIGHT	11080	1330	H	MONO WIDE	6.65	50-µs	
147 POL-SAT (PL)	HIGHT	11638	1888	H	MONO WIDE	6.60	50-µs	
EUTELSAT 2F1 (13° E)		LNB LOCAL OSCILLATOR = 9.75 GHz						
148 TV5 Europe	HIGHT	11080	1330	V	MONO WIDE	6.60	J 17	
149 Quantum	HIGHT	10972	1222	H	MONO WIDE	7.02	50-µs	
150 Eurosport (GB)	HIGHT	10972	1222	H	MONO WIDE	7.20	50-µs	
151 Eurosport (D)	HIGHT	10972	1222	H	MONO WIDE	7.20	50-µs	
152 NBC-Super (GB)	HIGHT	10987	1237	V	MONO WIDE	6.65	50-µs	
153 NBC-Super (D)	HIGHT	10987	1237	V	MONO WIDE	7.02	50-µs	
154 EuroNews (GB)	HIGHT	11575	1825	V	MONO WIDE	7.02	50-µs	
155 EuroNews (D)	HIGHT	11575	1825	V	MONO WIDE	6.35	50-µs	
156 EuroNews (F)	HIGHT	11575	1825	V	MONO WIDE	7.38	50-µs	
157 TRT	HIGHT	11181	1431	H	MONO WIDE	7.02 / 7.20	75-µs	
158 MBC	HIGHT	11554	1804	H	STEREO	7.02 / 7.20	75-µs	
159 Dubal - TV (A)	HIGHT	11638	1888	H	STEREO	7.02 / 7.20	75-µs	
EUTELSAT 2F2 (10° E)		LNB LOCAL OSCILLATOR = 9.75 GHz						
160 RAI-UNO (I)	HIGHT	10972	1222	V	MONO WIDE	6.60	J 17	
161 RAI-DUE (I)	HIGHT	11095	1345	V	MONO WIDE	6.60	J 17	
162 TVE -INT	HIGHT	11149	1399	H	MONO WIDE	6.60	50-µs	
163 RTP - INT	HIGHT	11658	1908	V	MONO WIDE	6.60	50-µs	
164 A-TV (TR)	HIGHT	10987	1237	H	MONO WIDE	6.65	50-µs	
165 Show-TV (TR)	HIGHT	11575	1825	V	MONO WIDE	6.65	50-µs	
166 Inter Star (TR)	HIGHT	11617	1867	V	MONO WIDE	6.60	50-µs	
167 Cine 5 (TR)	HIGHT	11080	1330	H	MONO WIDE	6.60	50µs	
168 BBC-World1	HIGHT	10987	1237	V	MONO WIDE	7.38	50-µs	
169 BBC-World2	HIGHT	10987	1237	V	MONO WIDE	7.56	50-µs	
170 France Infos	HIGHT	11080	1330	V	MONO WIDE	7.20	J 17	
EUTELSAT 2F3 (16° E)		LNB LOCAL OSCILLATOR = 10.0 GHz						
171 RTM	HIGHT	10972	0972	V	MONO WIDE	6.60	50-µs	
172 TV-7	HIGHT	11658	1658	V	MONO WIDE	6.60	50-µs	
173 ESC	HIGHT	11178	1178	V	MONO WIDE	6.60	50-µs	
174 TGRT (TR)	HIGHT	11095	1095	V	MONO WIDE	6.65	50-µs	
175 HBB-TV (TR)	HIGHT	11617	1617	V	STEREO	7.02 / 7.20	75-µs	
176 TV-POLONIA (PL)	HIGHT	11080	1080	H	MONO WIDE	6.65	50-µs	
177 POL-SAT (PL)	HIGHT	11638	1638	H	MONO WIDE	6.60	50-µs	
EUTELSAT 2F1 (13° E)		LNB LOCAL OSCILLATOR = 10.0 GHz						
178 TV5 Europe	HIGHT	11080	1080	V	MONO WIDE	6.60	J 17	
179 Quantum	HIGHT	10972	0972	H	MONO WIDE	7.02	50-µs	
180 Eurosport (GB)	HIGHT	10972	0972	H	MONO WIDE	7.20	50-µs	
181 Eurosport (D)	HIGHT	10972	0972	H	MONO WIDE	7.20	50-µs	
182 NBC-Super (GB)	HIGHT	10987	0987	V	MONO WIDE	6.65	50-µs	
183 NBC-Super (D)	HIGHT	10987	0987	V	MONO WIDE	7.02	50-µs	
184 EuroNews (GB)	HIGHT	11575	1575	V	MONO WIDE	7.02	50-µs	
185 EuroNews (D)	HIGHT	11575	1575	V	MONO WIDE	6.35	50-µs	
186 EuroNews (F)	HIGHT	11575	1575	V	MONO WIDE	7.38	50-µs	
187 TRT	HIGHT	11181	1181	H	MONO WIDE	7.02 / 7.20	75-µs	
188 MBC	HIGHT	11554	1554	H	STEREO	7.02 / 7.20	75-µs	
189 Dubal - TV (A)	HIGHT	11638	1638	H	STEREO	7.02 / 7.20	75-µs	
EUTELSAT 2F2 (10° E)		LNB LOCAL OSCILLATOR = 10.0 GHz						
190 RAI-UNO (I)	HIGHT	10972	0972	V	MONO WIDE	6.60	J 17	
191 RAI-DUE (I)	HIGHT	11095	1095	V	MONO WIDE	6.60	J 17	
192 TVE -INT	HIGHT	11149	1149	H	MONO WIDE	6.60	50-µs	
193 RTP - INT	HIGHT	11658	1658	V	MONO WIDE	6.60	50-µs	
194 A-TV (TR)	HIGHT	10987	0987	H	MONO WIDE	6.65	50-µs	
195 Show-TV (TR)	HIGHT	11575	1575	V	MONO WIDE	6.65	50-µs	
196 Inter Star (TR)	HIGHT	11617	1617	V	MONO WIDE	6.60	50-µs	
197 Cine 5 (TR)	HIGHT	11080	1080	H	MONO WIDE	6.60	50µs	
198 BBC-World1	HIGHT	10987	0987	V	MONO WIDE	7.38	50-µs	
199 BBC-World2	HIGHT	10987	0987	V	MONO WIDE	7.56	50-µs	

Free Manuals Download Website

<http://myh66.com>

<http://usermanuals.us>

<http://www.somanuals.com>

<http://www.4manuals.cc>

<http://www.manual-lib.com>

<http://www.404manual.com>

<http://www.luxmanual.com>

<http://aubethermostatmanual.com>

Golf course search by state

<http://golfingnear.com>

Email search by domain

<http://emailbydomain.com>

Auto manuals search

<http://auto.somanuals.com>

TV manuals search

<http://tv.somanuals.com>