

PHILIPS **MAGNAVOX**

**Compact Disc Changer
CDC735
Owner's Manual**

IMPORTANT!

**Return Your Warranty Registration Card
Within 10 Days. See Why Inside.**

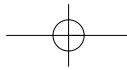

Return your Warranty Registration card today to ensure you receive all the benefits you're entitled to.

Once your PHILIPS MAGNAVOX purchase is registered, you're eligible to receive all the privileges of owning a PHILIPS MAGNAVOX product. So complete and return the Warranty Registration Card enclosed with your purchase at once. And take advantage of these important benefits.

Warranty Verification

Registering your product within 10 days confirms your right to maximum protection under the terms and conditions of your PHILIPS MAGNAVOX warranty.

Owner Confirmation

Your completed Warranty Registration Card serves as verification of ownership in the event of product theft or loss.

Model Registration

Returning your Warranty Registration Card right away guarantees you'll receive all the information and special offers which you qualify for as the owner of your model.

Congratulations on your purchase, and welcome to the "family!"

PHILIPS MAGNAVOX



Dear PHILIPS MAGNAVOX product owner:

Thank you for your confidence in PHILIPS MAGNAVOX. You've selected one of the best-built, best-backed products available today. And we'll do everything in our power to keep you happy with your purchase for many years to come.

As a member of the PHILIPS MAGNAVOX "family," you're entitled to protection by one of the most comprehensive warranties and outstanding service networks in the industry.

What's more, your purchase guarantees you'll receive all the information and special offers for which you qualify, plus easy access to accessories from our convenient home shopping network.

And most importantly you can count on our uncompromising commitment to your total satisfaction.

All of this is our way of saying welcome—and thanks for investing in a PHILIPS MAGNAVOX product.

Sincerely,

Robert Minkhorst
President and Chief Executive Officer

P.S. Remember, to get the most from your PHILIPS MAGNAVOX product, you must return your Warranty Registration Card within 10 days. So please mail it to us right now!

For Customer Use

Enter below the Serial No. which is located on the rear of the cabinet. Retain this information for future reference.

Know these safety symbols



⚡ This "bolt of lightning" indicates uninsulated material within your unit may cause an electrical shock. For the safety of everyone in your household, please do not remove product covering.

⚠ The "exclamation point" calls attention to features for which you should read the enclosed literature closely to prevent operating and maintenance problems.

WARNING: TO PREVENT FIRE OR SHOCK HAZARD, DO NOT EXPOSE THIS EQUIPMENT TO RAIN OR MOISTURE.

CAUTION: To prevent electric shock, match wide blade of plug to wide slot, and fully insert.

ATTENTION: Pour éviter les chocs électriques, introduire la lame la plus large de la fiche dans la borne correspondante de la prise et pousser jusqu'au fond.

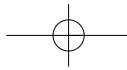

Introduction

Features

- Wireless Remote Control
- Automatic Search Music System
- Audible Search
- Repeat Play
- Random Play
- Programmed Play

Safety Precautions

FCC Warning: Any unauthorized changes or modifications to this equipment void the user's authority to operate it.

Warning: To prevent fire or shock hazard, do not expose this equipment to rain or moisture.

Philips Consumer Electronics Company recommends that you use only compact discs which are labeled with the  mark.

Warning: This unit uses a laser. Because of possible eye injury, only a qualified service person should remove the cover or attempt to service this device.

Caution: The use of controls or adjustments, or the performance of procedures other than specified herein, can result in hazardous exposure to laser light.

This digital apparatus does not exceed the Class B limits for radio noise emissions from digital apparatus.

Radio/TV Interference

This equipment has been tested and found to comply with the limits for a Class B digital device, pursuant to Part 15 of the Federal Communications Commission Rules. These limits are designed to provide reasonable protection against harmful interference in a residential installation. This equipment generates, uses, and can radiate radio frequency energy and, if not installed and used in accordance with the instructions, may cause harmful interference to radio communications. However, there is no guarantee that interference will not occur in a particular installation. If this equipment does cause harmful interference to radio or television reception, which can be determined by turning the equipment off and on, the user is encouraged to try to correct the interference by one or more of the following measures:

- 1) Reorient or relocate the receiving antenna.
- 2) Increase the distance between the equipment and the receiver.
- 3) Connect the equipment to an outlet on a circuit different from the circuit to which the receiver is connected.
- 4) Consult the dealer or an experienced radio/TV technician for help.

Copyright 1998 Philips Consumer Electronics Company. All rights reserved.

Welcome to your Compact Disc Changer owner's manual. This manual was designed for you. When looking through it, it will help you to keep several things in mind.

One, this manual is divided into four sections. The *Getting Started* section guides you through the initial setup of your Compact Disc Changer. The *Operating Your Compact Disc Changer* section shows you all of the controls of the Compact Disc Changer and remote control and guides you through the simple operations of your Compact Disc Changer. The *Doing More* section guides you through the more advanced features of your Compact Disc Changer. Finally, the *Information You May Need* section provides information you may or may not need – the warranty, for example, and trouble checks.

Two, the instructions follow a simple format. Detailed steps explaining operations are on the outside edges of pages. Illustrations accompanied by brief steps explaining operations are on the inside edges of pages. Additional information can be found in boxes labeled NOTES, which are along the lower edges of pages.

Finally, never be afraid to try a feature! **You cannot hurt your Compact Disc Changer by trying any of the features in this manual!**

So read on – and relax.

NOTE

- Before doing anything else, record the Compact Disc Changer's model and serial numbers in the spaces provided on page two. These numbers will help us assist you if you ever call for help.

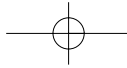

4

Table of Contents

Getting Started

| | |
|--|---|
| Introduction | 3 |
| Table of Contents | 4 |
| Before Using Your Compact Disc Changer | 5 |
| Hooking Up Your Compact Disc Changer | 6 |

Operating Your Compact Disc Changer

| | |
|----------------------------------|-------|
| Remote Control Buttons | 7 |
| Front Panel | 8 |
| Rear Panel | 9 |
| Playing | 10-11 |

Doing More

| | |
|----------------------------|-------|
| Playback Options | 12-13 |
| Special Playback | 14-15 |

Information You May Need

| | |
|---|----|
| Specifications/Care and Maintenance | 16 |
| Before Requesting Service | 17 |
| Warranty | 18 |
| Index | 19 |
| Accessories | 20 |

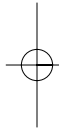

Before Using Your Compact Disc Changer

Putting Batteries in the Remote Control

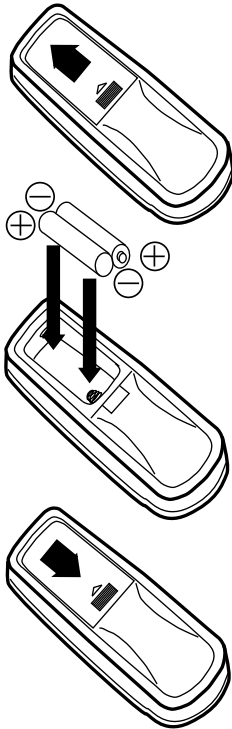

1
Remove the battery compartment cover on the bottom of the remote control by sliding it in the direction of the arrow.

2
Place two AA batteries inside the battery compartment with their + and - ends aligned as indicated.

3
Replace the battery compartment cover.

Using the Remote Control

Point the remote control at the Compact Disc Changer's remote sensor, making sure to stay within the angle shown. Do not put objects between the remote control and the Compact Disc Changer.

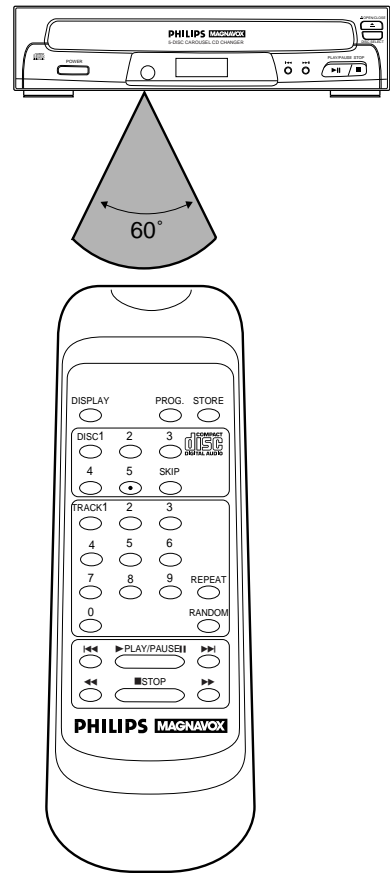

Handling discs

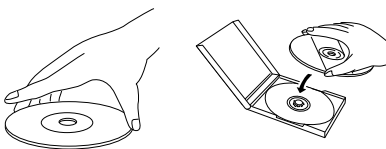

Always hold the disc by the edge, and keep it in its case when it is not in use. Fingerprints and scratches on the disc's surface can prevent the laser beam from correctly reading the digital information. For details on cleaning discs, see page 16.

NOTES

- The remote control and its batteries are supplied.
- Do not mix alkaline and manganese batteries.
- Do not mix old and new batteries.

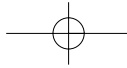

6

Hooking Up Your Compact Disc Changer

The Compact Disc Changer connection – an audio system to Compact Disc Changer – is shown below.

1

Select a location for your Compact Disc Changer that is near your receiver/amplifier and a standard AC outlet.

2

Plug one end of the supplied audio cable into the Compact Disc Changer's R(ight) and L(ef) OUTPUT jacks, matching the red plug to the red R(ight) jack and the white plug to the white L(ef) jack.

3

Plug the other end of the cable into the receiver/amplifier's corresponding left and right CD, AUX, or TAPE INPUT jacks.

4

Plug the Compact Disc Changer's power cord into a standard AC outlet.

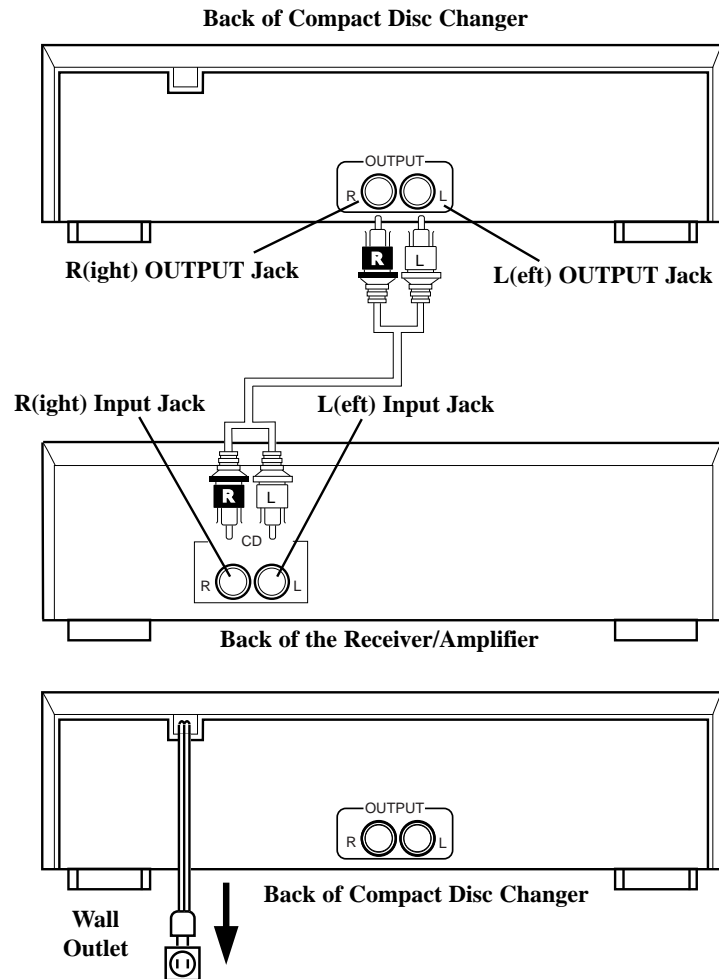

NOTES

- Do not place the Compact Disc Changer on top of the receiver/amplifier or on any component that emits heat.
- If you place the Compact Disc Changer near other audio components or their wires, you might hear a hum when you play a disc. Move the components or their wires to eliminate the noise.
- Do not use the receiver/amplifier's PHONO inputs. This could damage the receiver/amplifier.
- To prevent electric shock, do not use this polarized plug with an extension cord, receptacle, or other outlet unless the blades can be fully inserted to prevent blade exposure.

Remote Control Buttons

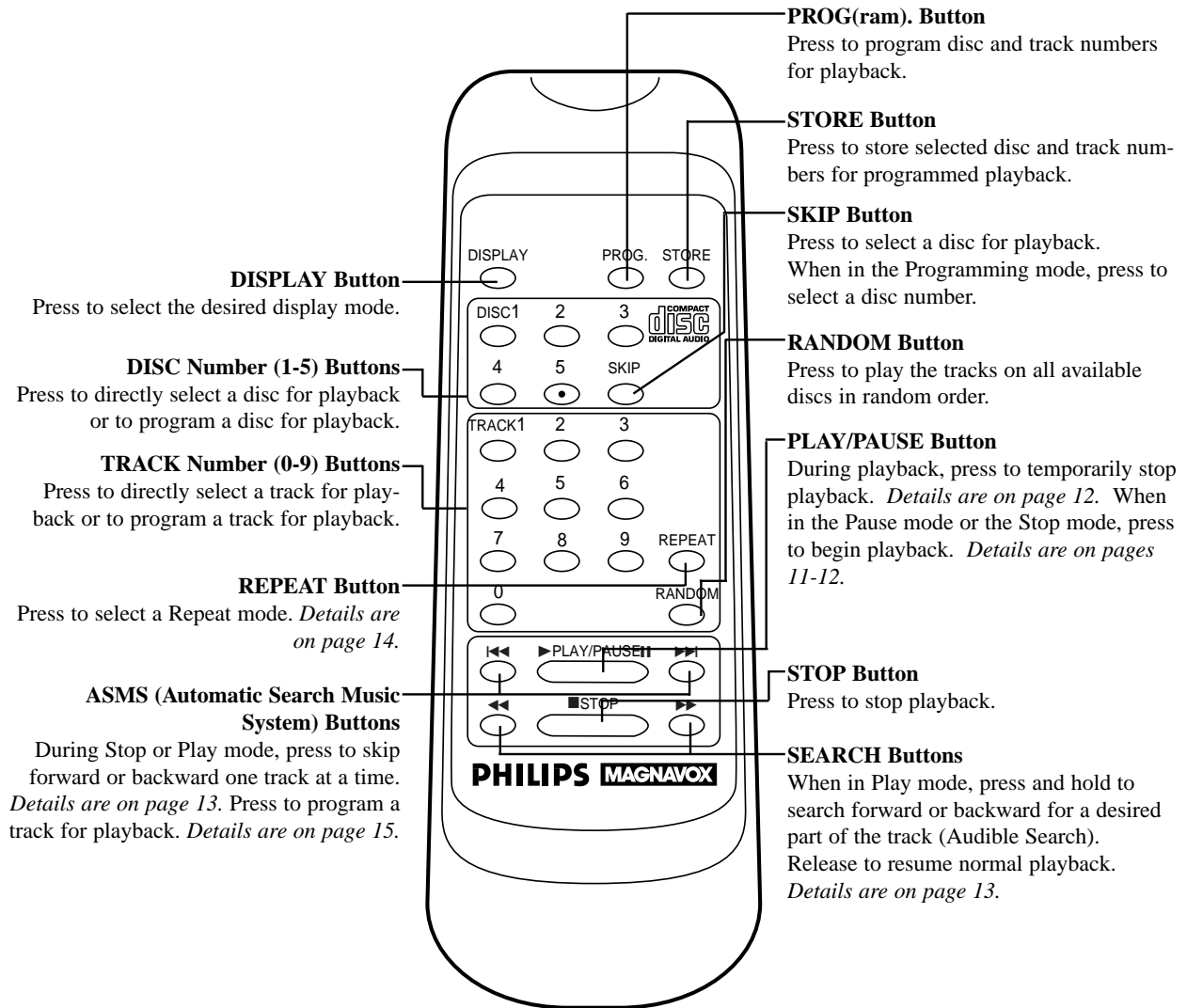

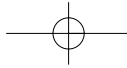

8

Front Panel

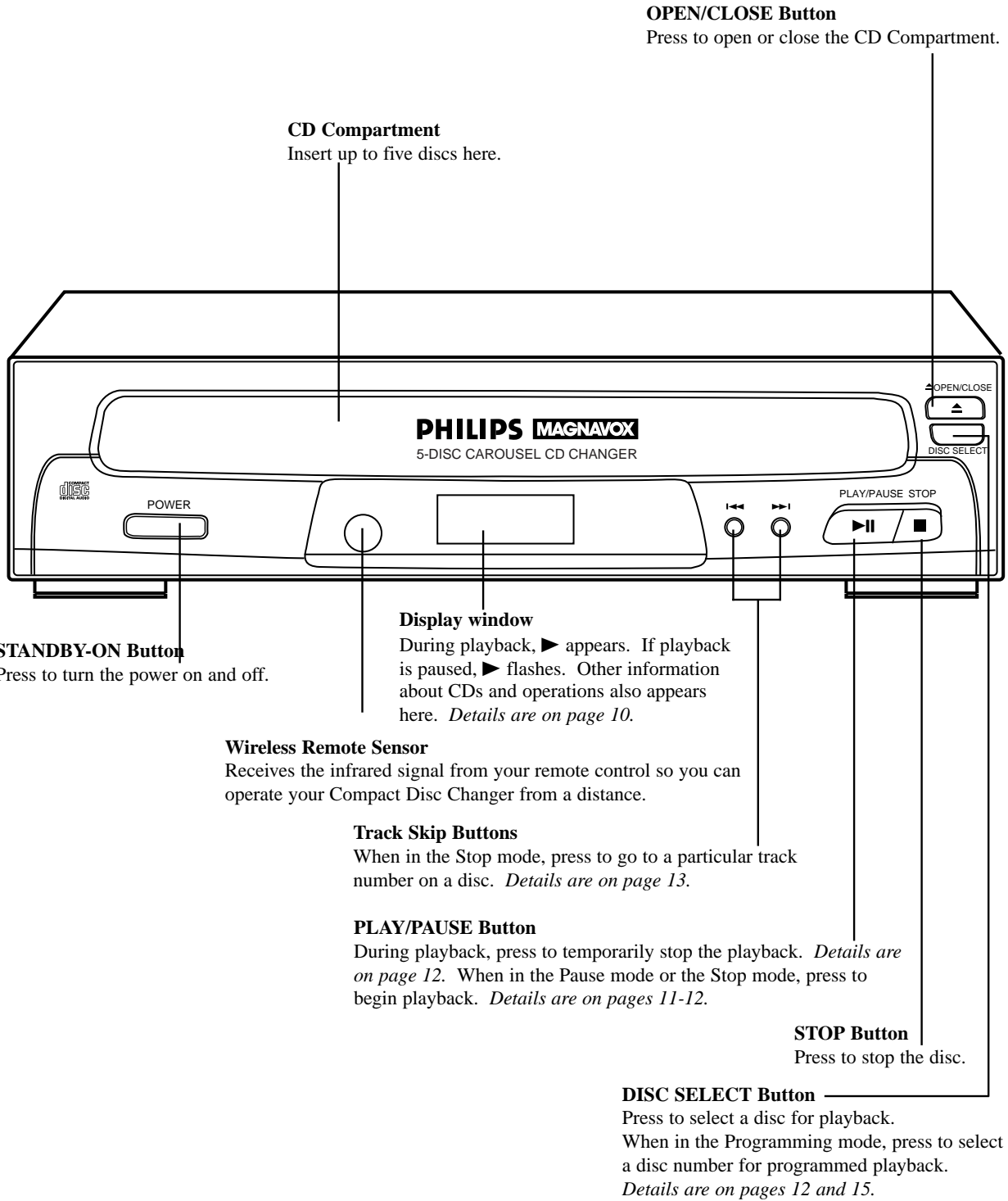

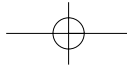

9

Rear Panel

OUTPUT R(ight) / L(eft) Jacks
Connect a cable going to the audio
input jacks of a receiver or amplifier
here. *Details are on page six.*

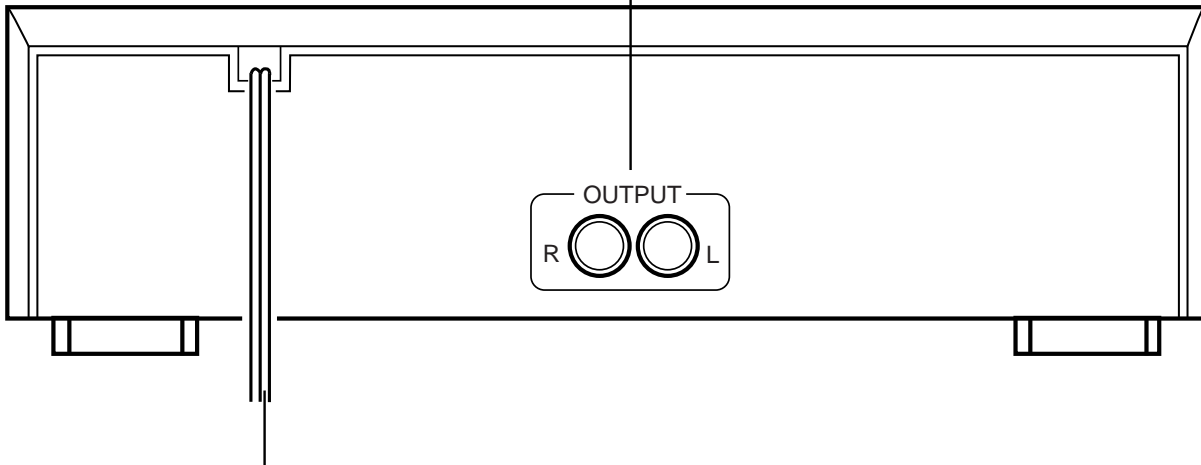

AC Power Cord
Connect to a standard AC (alternat-
ing current) outlet to supply power to
the Compact Disc Changer.

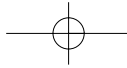

10

Playing

Display

- When you turn on the Compact Disc Changer, select a disc, or press the STOP button to stop playback, the number of the current disc in the play position and its total number of tracks appear on the display. The bottom row of the display shows the disc holder numbers; the holder(s) that contain(s) a disc are circled.

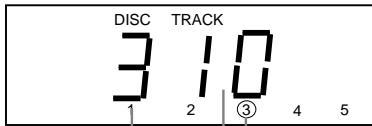

the number of the disc currently in play position

the holder(s) that contain(s) a disc

the total number of tracks

- If you press the DISPLAY button on the remote control while in Stop mode, the total playing time of the current disc appears on the display.

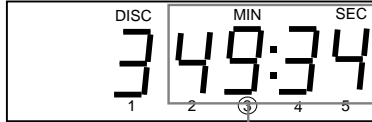

the total playing time of the disc

When you press the DISPLAY button again, the display shows the total number of tracks again.

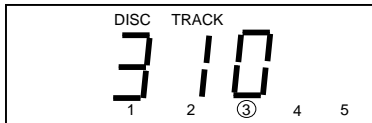

- During playback, the display shows the current disc and track numbers.

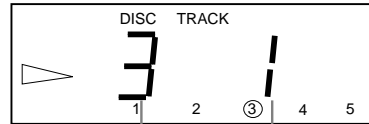

the track currently playing

the number of the current disc

When you press the DISPLAY button, the elapsed playing time of the current track appears on the display.

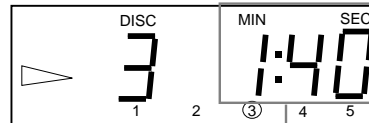

the elapsed playing time

When you press the DISPLAY button again, the display shows the current disc and track numbers again.

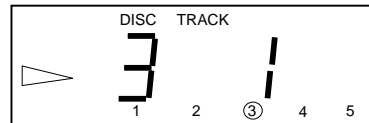

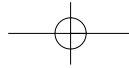

11 Playing (cont'd)

1 Turn on your receiver/amplifier and select the audio input to which you connected your Compact Disc Changer.

2 Press the STAND-BY-ON button.

5 With the label side up, carefully place the disc in the holder.

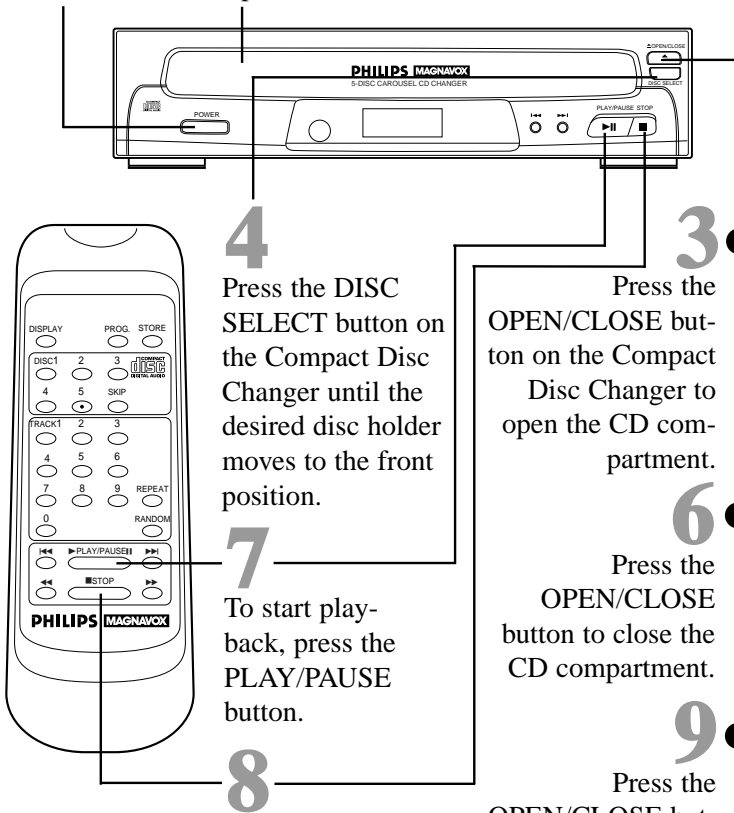

4 Press the DISC SELECT button on the Compact Disc Changer until the desired disc holder moves to the front position.

3 Press the OPEN/CLOSE button on the Compact Disc Changer to open the CD compartment.

7 To start playback, press the PLAY/PAUSE button.

6 Press the OPEN/CLOSE button to close the CD compartment.

8 To stop playback, press the STOP button.

9 Press the OPEN/CLOSE button to open the CD compartment and remove the disc.

Playing discs

Your Compact Disc Changer can play standard 5-inch or 3-inch CDs. Before playing a disc, make sure the Compact Disc Changer and the receiver/amplifier are connected (see

1 Turn on your receiver/amplifier and select the audio input to which you connected your Compact Disc Changer (CD, AUX, or TAPE).

2 Press the POWER button on the Compact Disc Changer. The display illuminates.

3 Press the OPEN/CLOSE button on the Compact Disc Changer to open the CD compartment.

4 Press the DISC SELECT button on the Compact Disc Changer until the desired disc holder (Disc 1, Disc 2, etc.) moves to the front position.

5 With the label side up, carefully place the disc in the holder. Repeat steps 4 and 5 to load more discs.

6 Press the OPEN/CLOSE button to close the CD compartment. The number of the disc in the play position and its total number of tracks appear on the display. Press the DISPLAY button on the remote control to display the total playing time of the disc.

7 Press the PLAY/PAUSE button to play the disc in the play position. Playback will begin with Track 1.

8 Press the STOP button to stop playback.

9 Press the OPEN/CLOSE button to open the CD compartment. Remove the disc and return it to its case.

NOTES

- Do not force the compartment to open or close. You might damage its loading mechanism.
- If you use 3-inch CDs, place the discs in the middle of the holders.
- After the Compact Disc Changer plays all tracks on the current disc, the Compact Disc Changer automatically loads the next disc and plays all of its tracks. After it plays all tracks on the last disc, playback stops.
- Do not touch the disc tray while it is rotating.
- Do not load more than one disc into each disc holder.

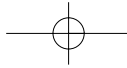

12

Playback Options

Changing discs during playback

- 1 During CD playback, press the OPEN/CLOSE button on the Compact Disc Changer to open the CD compartment without stopping playback. You can then change the CDs in the front disc holders. Do not press any buttons, or playback will be interrupted. Press the OPEN/CLOSE button to close the CD compartment when you are finished.

Stopping playback temporarily

- 1 During CD playback, press the PLAY/PAUSE button on the remote control or on the Compact Disc Changer.

- 2 Press the PLAY/PAUSE button again to resume playback.

Selecting a specific disc

- 1 To select a disc directly during playback, press the DISC number (1-5) button on the remote control. The selected disc starts to play automatically from Track 1.

- 1 **OR**, to have the Compact Disc Changer play the disc in the next disc holder, press the DISC SELECT button or the SKIP button. The Compact Disc Changer moves to the next disc holder that contains a disc and plays from its Track 1.

- 1 **OR**, when the Compact Disc Changer is stopped, press the DISC SELECT button or the SKIP button until you reach the desired disc holder.

- 2 Press the PLAY/PAUSE button to play the disc.

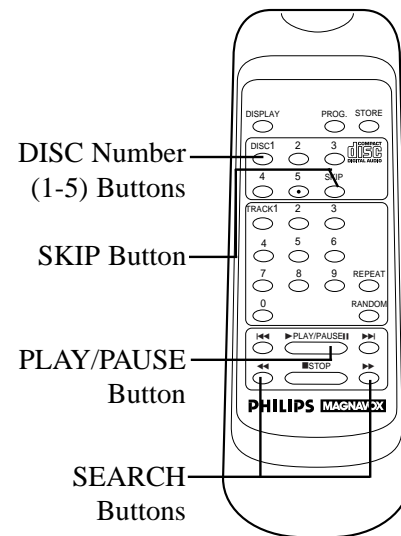
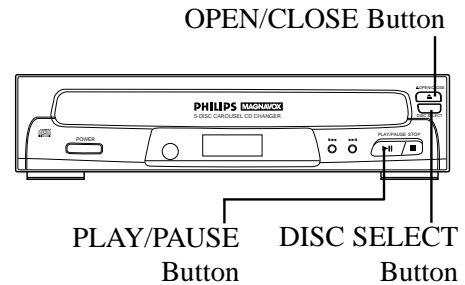

NOTES

- You cannot use the SKIP button, DISC number (1-5) buttons, or the DISC SELECT button during programmed playback. Details are on page 15.
- If you press the DISC SELECT button on the Compact Disc Changer or the SKIP button on the remote control to rotate the tray during playback, the Compact Disc Changer stops playing the current disc and starts playing the next disc (if another disc holder is loaded).

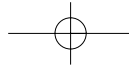

Playback Options (cont'd)

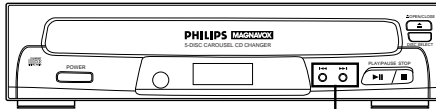

Track Skip Buttons

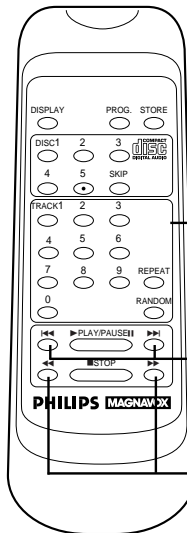

TRACK Number (0-9) Buttons

ASMS Buttons

SEARCH Buttons

Selecting a specific track

- 1 During Stop mode, enter the track number using the TRACK number (0-9) buttons on the remote control. To select a two-digit track number, press the second digit within five seconds of the first digit. Then, press the PLAY/PAUSE button to play the disc from the specified track number.
- 1 Or, when playback is stopped or paused, press the ASMS ◀◀ or ▶▶ button on the remote control or the Track Skip ◀◀ or ▶▶ button on the Compact Disc Changer to select a track. Press the PLAY/PAUSE button to begin playback.

Automatic Search Music System (ASMS)

- 1 During CD playback, press the ASMS ◀◀ button once to return to the beginning of the current track. Press the ASMS ▶▶ button to skip to the next track. If you try to advance past the disc's last track, the changer starts counting again from Track 1. If you try to go before Track 1, the changer starts counting backward from the last track on the disc.

Audible search

- 1 During CD playback, press and hold the SEARCH ◀◀ button on the remote control to search backward. Or, press and hold the SEARCH ▶▶ button to search forward. You can search forward or backward for a specific section of a track on a particular disc. The disc will play at a faster speed and a lower volume. When the end of the disc is reached during a forward search, the changer advances to the next available disc and starts searching. However, you cannot search backward past the beginning of a disc.
- 2 Release the button to resume normal play.

NOTE

- You cannot use the TRACK number (0-9) buttons during programmed playback. Details are on page 15.

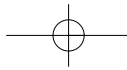

14

Special Playback

Repeat Playback

Follow the instructions below to program the Compact Disc Changer to play a track, disc, or program over and over.

Make sure:

- There is a disc in the Compact Disc Changer.

Repeat a Track

Before or during playback, repeatedly press the REPEAT button until REP. ONE appears on the display. At the end of the track, the Compact Disc Changer plays the track again.

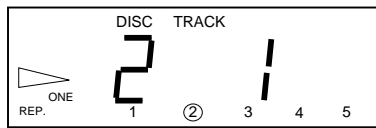

Repeat all loaded discs or repeat a program

Before or during playback, press the REPEAT button until REP. ALL appears on the display. When the end of the disc is reached, the Compact Disc Changer will play the next available disc. All discs will play repeatedly until you cancel repeat playback.

If a sequence of tracks has been programmed, press the REPEAT button until REP. ALL appears on the display. The Compact Disc Changer will play the programmed tracks. When the end of the program is reached, the Compact Disc Changer will play the program again.

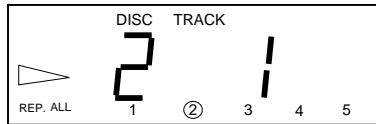

Random Playback

Follow the instructions below to set the Compact Disc Changer to select and play tracks at random from one or more discs.

Make sure:

- There is a disc in the Compact Disc Changer.

Before or during playback, press the RANDOM button until RAND. appears on the display. The Compact Disc Changer plays tracks at random from all of the discs available.

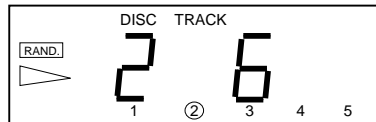

The Compact Disc Changer will randomly select and play tracks until you press the STOP button. RAND. disappears from the display.

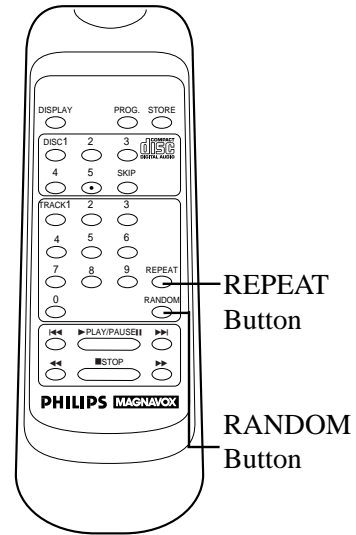

NOTES

- The Compact Disc Changer does not successively select the same track, but might select the same track during programmed playback.
- You cannot activate random playback if programmed playback is activated (PROG appears on the display). Press the STOP button, then the PROG button, to deactivate the program, then press the RANDOM button. Details are on page 15.
- To cancel repeat playback, repeatedly press the REPEAT button until neither REP. ALL nor REP. ONE appears on the display.

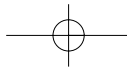

Special Playback (cont'd)

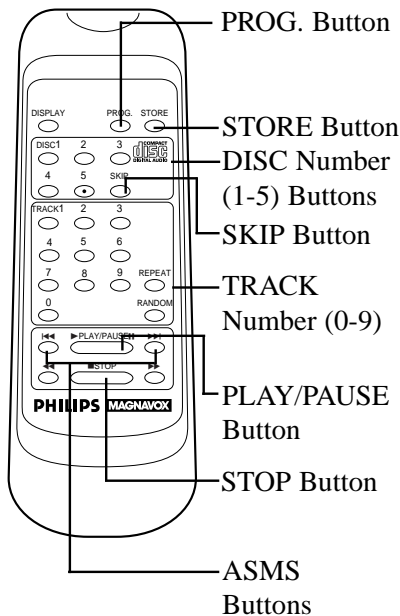
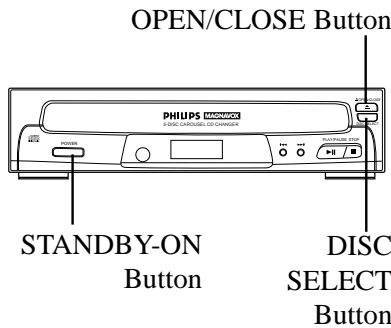

Program Tracks

You can program up to 32 tracks to play in any order you choose. You can program tracks while the disc compartment is open.

1

Press the STOP button to cancel the current function.

2

Press the PROG. button. The display shows PROG. and program step number (PROG. NO.) 1.

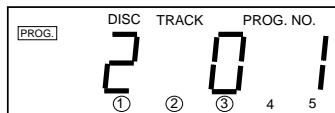

3

Press the DISC number (1-5) button or the SKIP button on the remote control or the DISC SELECT button on the Compact Disc Changer to select the disc that contains the first track you want to program. The display shows the selected disc. For example, disc number 3.

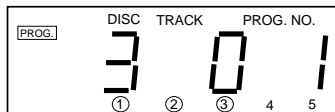

4

Press the TRACK number buttons or the ASMS **◀◀** or **▶▶** button to select the track you want to play. The display shows the selected track. For example, track

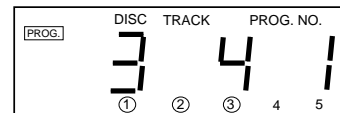

5

Press the STORE button to store the displayed disc and track numbers in the first memory position. The display changes to TRACK 0 and PROG. NO. 2, indicating you may store the next track. (The disc number will not change.)

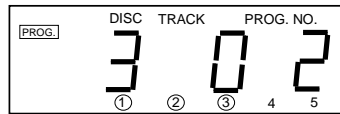

6

Repeat steps 3-5 for each track you want to program.

7

When you are finished storing tracks in the program, press the PLAY/PAUSE button. The Compact Disc Changer starts to play the programmed tracks in the order you entered.

NOTES

- Press the ASMS **◀◀** or **▶▶** button during programmed playback to move backward or forward through the programmed sequence. Press the PLAY/PAUSE button to resume playback of the program.
- You can use audible search during programmed play. Details are on page 13.
- You cannot use the DISC SELECT button, the SKIP button, the DISC number (1-5) buttons or the TRACK number (0-9) buttons during programmed playback.
- To stop programmed playback, press the STOP button, then press the PROG. button. PROG. disappears from the display. The program is stored until you turn off the Compact Disc Changer or open the CD compartment.
To play a stored program again, press the STOP button to cancel the current function. Then, press the PROG. button so PROG. appears on the display. Press the PLAY/PAUSE button to begin playback.
- During Stop mode, you may review the tracks stored in a program. Press the PROG. button so that PROG. appears on the display. Then, press the STORE button repeatedly to advance through a display of the tracks. You can not do this while the program is playing.
- To clear the program from memory, press the STANDBY-ON button to turn off the Compact Disc Changer, or press the OPEN/CLOSE button to open the CD compartment.

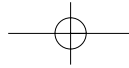

16

Specifications/Care and Maintenance

Specifications

Frequency Response

20 - 20,000Hz

Signal-to-Noise Ratio

100 dB (A -WTD)

Harmonic Distortion

20kHz Low Pass Filter 0.01%(1kHz)
Separation 83 dB

Wow and Flutter

Not measurable

Diameter

4-3/4 inch (120 mm), 3-1/8 inch (80 mm)

Sampling Frequency

44.1kHz

Oversampling

8 times

Quantization Number

16 Bit Linear

Transmission Bit Rate

4.3218 MHz

Type

Optical pick up

Object Lens Drive System

Two-dimensional parallel drive

Optical Source:

Semi conductor laser

Wavelength

770~795 nm

Tracking System

Three beam system

Power Requirement

120V \pm 10%, 60Hz \pm 5%,

Power Consumption

10 W

Operating Temperature

41°F (5°C) to 104°F (40°C)

Relative Humidity

10% to 80%

Weight

7.9 lbs. (3.6 kg.)

Dimensions

16-15/16" (W) x 4-1/16" (H) x 14-1/4" (D)
(430 mm x 104 mm x 363 mm)

NOTE: Designs and specifications are subject to change without notice.

Care and Maintenance

The Compact Disc Changer is an example of superior design and craftsmanship. The following suggestions will help you care for the Compact Disc Changer so that you can enjoy it for years.

- Use a soft cloth to wipe the disc. Wipe the disc in a straight line from the center to the edge.
- Wipe the Compact Disc Changer with a dampened cloth to keep it looking new. Do not use harsh chemicals, cleaning solvents, or strong detergents to clean the Compact Disc Changer.
- Keep the Compact Disc Changer dry. If it gets wet, dry it immediately. Liquids can contain minerals that can corrode the electronic circuits.
- Handle the Compact Disc Changer gently and carefully. Dropping it can damage circuit boards and can cause the product to work improperly.
- Use and store the Compact Disc Changer only in normal temperature environments. Temperature extremes can shorten the life of electronic devices, damage batteries, and distort or melt plastic parts.
- Keep the Compact Disc Changer away from dust and dirt.
- Modifying or tampering with the Compact Disc Changer's internal components can cause a malfunction and might invalidate the warranty.

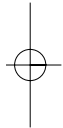

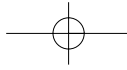

17

Before Requesting Service

.....

If you are having problems with your Compact Disc Changer, check the following list of problems and possible solutions before requesting service. You may be able to solve the problem yourself.

Power

No power

- Make sure the power plug is completely connected to an AC (alternating current) outlet.
- Make sure the power is turned on.

Remote Control

The Compact Disc Changer can not be controlled with the remote control.

- Aim the remote control directly at the Compact Disc Changer's remote sensor (page five).
- Remove all obstacles between the remote control and the Compact Disc Changer (page five).
- Inspect and/or replace the batteries in the remote control (page five).

Playback

Disc is inserted, but the total number of tracks is not displayed. DISC number does not appear on the display.

- Make sure the disc is in the Compact Disc Changer with its label side up.
- Clean the disc.
- Load a disc that has the standard compact disc label (page three).

No sound

A particular portion of the disc does not play correctly (sound cuts out, or same portion is repeated).

- Connect the audio cable properly (page six).
- Clean the disc.

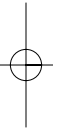
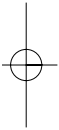

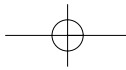

LIMITED WARRANTY

HOME AUDIO COMPACT DISC

One Year Free Exchange

This product must be carried in for an exchange.

WHO IS COVERED?

You must have proof of purchase to exchange the product. A sales receipt or other document showing that you purchased the product is considered proof of purchase. Attach it to this owner's manual and keep both nearby.

WHAT IS COVERED?

Warranty coverage begins the day you buy your product. For one year thereafter, a defective or inoperative product will be replaced with a new, renewed, or comparable product at no charge to you. A replacement product is covered only for the original warranty period. When the warranty on the original product expires, the warranty on the replacement product also expires.

WHAT IS EXCLUDED?

Your warranty does not cover:

- labor charges for installation or setup of the product, and adjustment of customer controls on the product.
- product repair and/or part replacement because of misuse, accident, unauthorized repair or other cause not within the control of Philips Consumer Electronics Company.
- reception problems caused by signal conditions or cable or antenna systems outside the unit.
- a product that requires modification or adaptation to enable it to operate in any country other than the country for which it was designed, manufactured, approved and/or authorized, or repair of products damaged by these modifications.
- incidental or consequential damages resulting from the product. (Some states do not allow the exclusion of incidental or consequential damages, so the above exclusion may not apply to you. This includes, but is not limited to, prerecorded material, whether copyrighted or not copyrighted.)
- a product that is used for commercial or institutional purposes.

WHERE IS EXCHANGE AVAILABLE?

You may exchange the product in all countries where the product is officially distributed by Philips Consumer Electronics Company. In countries where Philips Consumer Electronics Company does not distribute the product, the local Philips service organization will attempt to provide a replacement product (although there may be a delay if the appropriate product is not readily available).

BEFORE REQUESTING EXCHANGE...

Please check your owner's manual before requesting an exchange. Adjustments of the controls discussed there may save you a trip.

EXCHANGING A PRODUCT IN U.S.A., PUERTO RICO, OR U.S. VIRGIN ISLANDS...

Contact your dealer or the Consumer Access Center at (423) 475-8869 to arrange an exchange. Or, ship the product, insured and freight prepaid, and with proof of purchase enclosed, to the address listed below.

Small Product Service Center
 Philips Service Company
 1001 Snapps Ferry Road
 Plant 2, Building 6
 Greeneville, TN 37743

(In U.S.A., Puerto Rico, and U.S. Virgin Islands, all implied warranties, including implied warranties of merchantability and fitness for a particular purpose, are limited in duration to the duration of this express warranty. But, because some states do not allow limitations on how long an implied warranty may last, this limitation may not apply to you.)

EXCHANGING A PRODUCT IN CANADA...

Please contact Philips at:

1-800-661-6162 (French Speaking)
 1-800-363-7278 (English Speaking)

(In Canada, this warranty is given in lieu of all other warranties. No other warranties are expressed or implied, including any implied warranties of merchantability or fitness for a particular purpose. Philips is not liable under any circumstances for any direct, indirect, special, incidental or consequential damages, howsoever incurred, even if notified of the possibility of such damages.)

TO GET OUT-OF-WARRANTY EXCHANGE...

In U.S.A., Puerto Rico, or U.S. Virgin Islands, contact Philips Service Company at (800) 531-0039 to obtain the cost of out-of-warranty exchange. Then carefully pack the product and ship it to the Small Product Service Center (address listed above). In Canada, call the phone number listed under "Exchanging a Product in Canada" to obtain the cost of out-of-warranty exchange.

REMEMBER...

Please record below the model and serial numbers found on the product. Also, please fill out and mail your warranty registration card promptly. It will be easier for us to notify you if necessary.

MODEL # _____
 SERIAL # _____

This warranty gives you specific legal rights. You may have other rights which vary from state/province to state/province.

Philips Service Company, P.O. Box 555, Jefferson City, Tennessee 37760, (423) 475-8869

EL6274E001 / MAC 6271 / 7-97

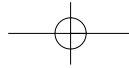

19

Index

| | |
|--|--|
| <p>accessories20</p> <p>ac power cord6, 9</p> <p>asms buttons7</p> <p>audible search13</p> <p>automatic search music system (asms)13</p> <p>batteries5</p> <p>care and maintenance16</p> <p>cd compartment8</p> <p>changing discs12</p> <p>connections6</p> <p>disc number (1-5) buttons7</p> <p>disc select button8</p> <p>display8, 10</p> <p>display button7</p> <p>introduction3</p> <p>open/close button8</p> <p>output r/l jacks6, 9</p> <p>playback options12 - 13</p> <p>playing10 - 11</p> <p>playing discs11</p> <p>prog(ram). button7</p> <p>programming tracks15</p> <p>random</p> | <p>button7</p> <p>playback14</p> <p>remote control5, 7</p> <p>remote sensor5, 8</p> <p>repeat</p> <p style="padding-left: 20px;">button7</p> <p style="padding-left: 20px;">playback14</p> <p>safety precautions3</p> <p>search buttons7</p> <p>selecting</p> <p style="padding-left: 20px;">a specific disc12</p> <p style="padding-left: 20px;">a specific track13</p> <p>skip button7</p> <p>special playback14 - 15</p> <p>standby-on button8</p> <p>stop button7, 8</p> <p>store button7</p> <p>table of contents4</p> <p>track number (0-9) buttons7</p> <p>track skip buttons8</p> <p>warranty18</p> <p>wireless remote sensor5, 8</p> |
|--|--|

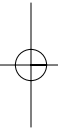

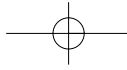

SUPPLIED ACCESSORIES

Check to be sure the items on this page are packed with your Compact Disc Changer. These accessories are provided to help you use or set up your Compact Disc Changer.

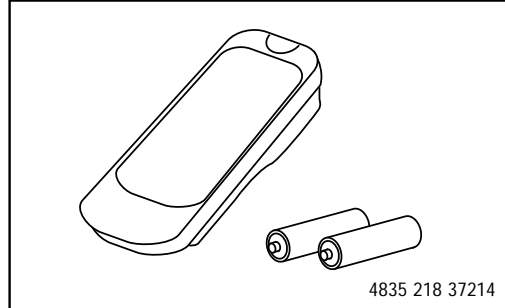

**Remote Control
Two AA Batteries (4835 138 17012)**

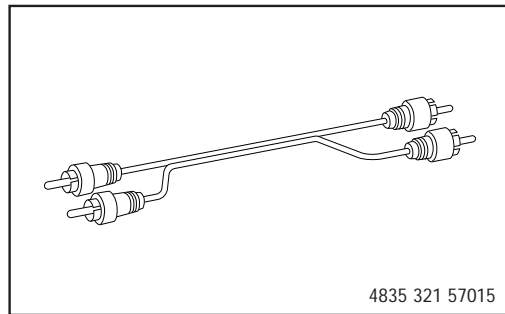

One-piece Audio Cable

If any of these items are not included, or if you need to replace an item, contact Philips Service Company at the address below.

***Philips Service Company
P.O. Box 967
Greenville, TN 37744-0967***

Or, call 1-800-851-8885.

IB8008E001
Compact Disc Changer
Printed In China
OVMN02073 / E7723UD * * * * *

Free Manuals Download Website

<http://myh66.com>

<http://usermanuals.us>

<http://www.somanuals.com>

<http://www.4manuals.cc>

<http://www.manual-lib.com>

<http://www.404manual.com>

<http://www.luxmanual.com>

<http://aubethermostatmanual.com>

Golf course search by state

<http://golfingnear.com>

Email search by domain

<http://emailbydomain.com>

Auto manuals search

<http://auto.somanuals.com>

TV manuals search

<http://tv.somanuals.com>