

Mini Hi-Fi System



Need help? Call us!

Philips representatives are ready to help you with any questions about your new product. We can guide you through Connections, First-time Setup, or any of the Features. We want you to start enjoying your new product right away!

**CALL US BEFORE YOU CONSIDER
RETURNING THE PRODUCT!**

1-800-531-0039

or

Visit us on the web at www.philips.com



PHILIPS

Canada

English:

This digital apparatus does not exceed the Class B limits for radio noise emissions from digital apparatus as set out in the Radio Interference Regulations of the Canadian Department of Communications.

This warning label is located on the rearside and inside this laser product.

CAUTION: INVISIBLE LASER RADIATION WHEN OPEN. DO NOT STARE INTO BEAM.
DANGER: INVISIBLE LASER RADIATION WHEN OPEN. AVOID DIRECT EXPOSURE TO BEAM.
VARO! AVATTAESSA JA SUOJALUKITUS OHITETTAESSA OLET ALTTIINANÄKYMÄTTÖMÄÄLLE LASERSATEILYLLE. ÄLÄ KATSO SATEESEEN.
WARNING! OSYNLIG LASERSTRÅLNING NÄR DENNA DEL ÄR ÖPPNAD. OCH SPÄRREN ÄR URKOPPLAD. BETRÄKTA EJ STRÅLEN.

or

DANGER - Invisible laser radiation when open.
AVOID DIRECT EXPOSURE TO BEAM.

CAUTION

Use of controls or adjustments or performance of procedures other than herein may result in hazardous radiation exposure or other unsafe operation.

ATENCIÓN

El uso de mando o ajustes o la ejecución de métodos que no sean los aquí descritos puede ocasionar peligro de exposición a radiación.

Energy Star

As an ENERGY STAR® Partner, Philips has determined that this product meets the ENERGY STAR® guidelines for energy efficiency.



This system complies with the FCC rules, Part 15 and with 21 CFR 1040.10. Operation is subject to the following two conditions:

- **This device may not cause harmful interference, and**
- **This device must accept any interference received, including interference that may cause undesired operation.**

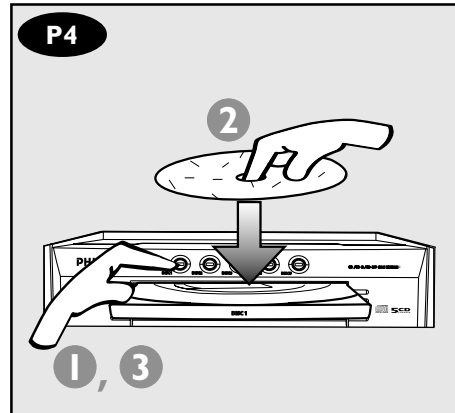
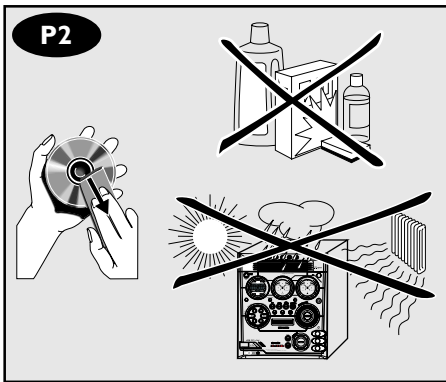
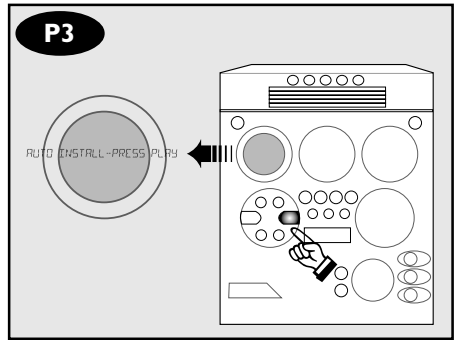
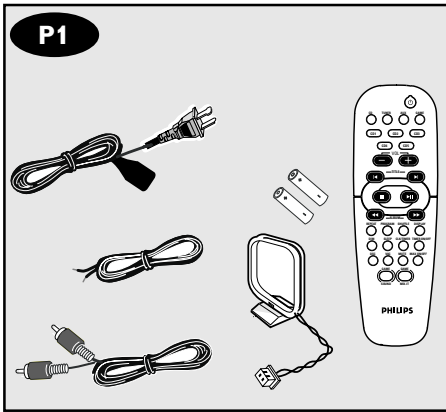

Return your **Warranty Registration** card today to ensure you receive all the benefits you're entitled to.

- Once your Philips purchase is registered, you're eligible to receive all the privileges of owning a Philips product.
- So complete and return the Warranty Registration Card enclosed with your purchase at once, and take advantage of these important benefits.

Warranty Verification

Registering your product within 10 days confirms your right to maximum protection under the terms and conditions of your Philips warranty.

Owner Confirmation

Your completed Warranty Registration Card serves as verification of ownership in the event of product theft or loss.

Model Registration

Returning your Warranty Registration Card right away guarantees you'll receive all the information and special offers which you qualify for as the owner of your model.

Know these *safety* symbols



 This "bolt of lightning" indicates uninsulated material within your unit may cause an electrical shock. For the safety of everyone in your household, please do not remove product covering.

 The "exclamation point" calls attention to features for which you should read the enclosed literature closely to prevent operating and maintenance problems.

For Customer Use

Enter below the Serial No. which is located on the rear of the cabinet. Retain this information for future reference.

Model No. _____

Serial No. _____

WARNING: TO PREVENT FIRE OR SHOCK HAZARD, DO NOT EXPOSE THIS EQUIPMENT TO RAIN OR MOISTURE.

CAUTION: To prevent electric shock, match wide blade of plug to wide slot, and fully insert.



PHILIPS

***Congratulations on your purchase,
and welcome to the “family!”***

Dear Philips product owner:

Thank you for your confidence in Philips. You've selected one of the best-built, best-backed products available today. And we'll do everything in our power to keep you happy with your purchase for many years to come.

As a member of the Philips “family,” you're entitled to protection by one of the most comprehensive warranties and outstanding service networks in the industry.

What's more, your purchase guarantees you'll receive all the information and special offers for which you qualify, plus easy access to accessories from our convenient home shopping network.

And most importantly you can count on our uncompromising commitment to your total satisfaction.

All of this is our way of saying welcome – and thanks for investing in a Philips product.

Sincerely,

Lawrence J. Blanford
President and Chief Executive Officer

P.S. Remember, to get the most from your Philips product, you must return your Warranty Registration Card within 10 days. So please mail it to us right now!

IMPORTANT SAFETY INSTRUCTIONS

1. Read these instructions.
2. Keep these instructions.
3. Heed all warnings.
4. Follow all instructions.
5. Do not use this apparatus near water.
6. Clean only with dry cloth.
7. Do not block any ventilation openings. Install in accordance with the manufacturer's instructions.
8. Do not install near any heat sources such as radiators, heat registers, stoves, or other apparatus (including amplifiers) that produce heat.

9. Do not defeat the safety purpose of the polarized or grounding-type plug.

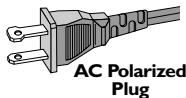

A polarized plug has two blades with one wider than the other. A grounding type plug has two blades and a third grounding prong. The wide blade or the third prong are provided for your safety. If the provided plug does not fit into your outlet, consult an electrician for replacement of the obsolete outlet.

10. Protect the power cord from being walked on or pinched, particularly at plugs, convenience receptacles, and the point where they exit from the apparatus.
11. Only use attachments/accessories specified by the manufacturer.

12.  Use only with the cart, stand, tripod, bracket, or table specified by the manufacturer or sold with the apparatus. When a cart is used, use caution when moving the cart/apparatus combination to avoid injury from tip-over.

13. Unplug this apparatus during lightning storms or when unused for long periods of time.
14. Refer all servicing to qualified service personnel. Servicing is required when the apparatus has been damaged in any way, such as power-supply cord or plug is damaged, liquid has been spilled or objects have fallen into the apparatus, the apparatus has been exposed to rain or moisture, does not operate normally, or has been dropped.

15. Battery usage **CAUTION** – To prevent battery leakage which may result in bodily injury, property damage, or damage to the unit:

- Install **all** batteries correctly, + and - as marked on the unit.
- Do not mix batteries (**old** and **new** or **carbon** and **alkaline**, etc.).
- Remove batteries when the unit is not used for a long time.

EL 6475-E004: 02/8

Class II equipment symbol



This symbol indicates that the unit has a double insulation system

Index

English 8

Español 30

English

Español

General Information

Supplied accessories	9
Environmental information	9
Care and safety information	9

Functional Overview

Main unit and remote control	10–11
Control buttons available on the remote only	11

Connections

Step 1: Connecting FM/AM antennas	13
Step 2: Connecting the speakers	13
Step 3: Connecting to game console	13
Step 4: Connecting the AC power cord	13
Step 5: Inserting batteries into the remote control	14
Using the remote control to operate the system	14

Gameport Operations

About Gameport	15
Preparation before use	15
Start operating	15

Basic Operations

Switching on/off	16
Switching to active mode	16
Switching to Eco Power standby mode	16
Switching to standby mode (view clock)	16
Demonstration mode	16
Setting the clock	16
Dimming system's display screen	17
Volume control	17
Sound control	17
MAX sound	17
Digital Sound Control	17
Virtual Ambience Control	17
Dynamic Bass Boost	17

Disc Operations

Playable discs	18
Loading discs	18
Basic playback controls	18–19
Repeat and Shuffle	19
Repeat play	19
Random play	19
Programming the disc tracks	19
Checking the program	20
Playing a disc without clearing the program	20
Clearing the program	20

Tuner Operations

Tuning to radio stations	21
Presetting radio stations	21
Using the Plug and Play	21
Automatic presetting	21
Manual presetting	21
Selecting a preset radio station	21
Deleting a preset radio station	21

Timer Operations

Timer setting	22
Activating/Deactivating the timer	22
Sleep timer setting	23

Other Connection

Listening to an external source	23
---------------------------------------	----

Specifications

.....	24
-------	----

Troubleshooting

.....	25
-------	----

Limited Warranty

.....	26
-------	----

Refer to the type plate on the rear or bottom of the system for identification and supply ratings.

Supplied accessories (page 3 - P1)

- Remote control and two AA batteries.
- AM loop antenna
- FM wire antenna
- Video cinch cable (yellow)
- AC power cord

Environmental information

All unnecessary packaging has been omitted. We have tried to make the packaging easy to separate into three materials: cardboard (box), polystyrene foam (buffer) and polyethylene (bags, protective foam sheet).

Your system consists of materials which can be recycled and reused if disassembled by a specialized company. Please observe the local regulations regarding the disposal of packaging materials, exhausted batteries and old equipment.

Care and safety information

(page 3 - P2)

Avoid high temperatures, moisture, water and dust

- Do not expose the system, batteries or discs to humidity, rain, sand or excessive heat (caused by heating equipment or direct sunlight). Always keep the disc tray closed to avoid getting dust on the lens.

Avoid condensation problem

- The lens may cloud over when the system is suddenly moved from cold to warm surroundings, making it impossible to play a disc. Leave the system in the warm environment until the moisture evaporates.

Do not block the vents

- In a cabinet, allows about 10cm (4 inches) of free space all around the system for adequate ventilation.

Care of disc

- To clean a CD, wipe it in a straight line from the center towards the edge using a soft, lint-free cloth. Do not use cleaning agents, as they may damage the disc!
- Write only on the printed side of a CDR(W) and only with a soft felt-tipped pen.
- Handle the disc by its edge, do not touch the surface.

Care of the cabinet

- Use a soft cloth slightly moistened with a mild detergent solution. Do not use a solution containing alcohol, spirits, ammonia or abrasives.

Finding a suitable location

- Place the system on a flat, hard, stable surface.

Built-in safety circuit

- Under extreme conditions, this system may switch to standby mode automatically. If this happens, let the system cool down before reusing it.

Power saving

- This system is designed to use less than 1W of electricity when switches to Eco Power standby. Disconnect the AC power cord from the power outlet when not in use.

Functional Overview

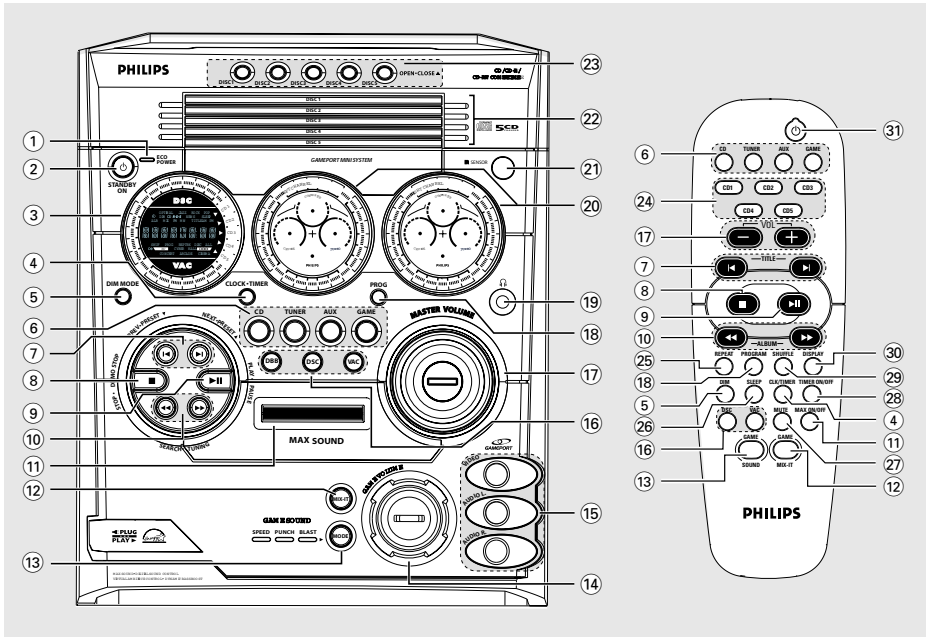

Main unit and remote control

① ECO POWER indicator

- Lights up when the system is in Eco Power standby mode.

② STANDBY ON

- Switches to Eco Power standby mode or turns on the system.
- *Switches to standby mode.

③ Display screen

④ CLOCK•TIMER (CLK/TIMER)

- *Enters clock or timer setting mode.

⑤ DIM MODE (DIM)

- Turns on/off the dim mode.

⑥ CD / TUNER / AUX / GAME

- Selects the relevant active mode : CD, TUNER, AUX or GAME.
- CD: toggles between DISC 1~5.
- TUNER: toggles between FM and AM band.

⑦ PREV•PRESET ▼ () / NEXT•PRESET ▲ (

- CD: selects a track.
- TUNER: selects a preset radio station.
- CLOCK: sets the minutes.

⑧ STOP•DEMO STOP

- Exits an operation.
- CD: stops playback or clears a program.
- TUNER: *erases a preset radio station.

(only on the main unit)

- *Turns on/off the demonstration mode.

⑨ PLAY•PAUSE II

- CD: starts/pauses playback.

(only on the main unit)

TUNER: *enters Plug & Play mode and/or starts preset radio station installation.

* = Press and hold the button for more than two seconds.

⑩ SEARCH·TUNING (◀◀▶▶)

- **CD:** *searches backward/forward.
- **TUNER:** tunes the radio frequency up/down.
- **CLOCK:** sets the hours.

⑪ MAX SOUND (MAX ON/OFF)

- Turns on/off the optimal mix of various sound features.

⑫ MIX IT (GAME MIX IT)

- Mixes the game sound with your favorite music from one of these music source (CD, TUNER or AUX).

⑬ MODE (GAME SOUND)

- Selects different type of equalizer setting for Gameport (SPEED, PUNCH or BLAST).

⑭ GAME VOLUME

- Adjusts the game's output volume level.

⑮ VIDEO

- Use a video cable to connect to your game console's video output.

AUDIO L. / AUDIO R.

- Use a audio cable to connect to your game console's left/right audio output.

⑯ DBB

- Selects different type of bass boost level settings (DBB 1, DBB 2, DBB 3 or DBB OFF).

DSC

- Selects different type of preset sound equalizer settings (OPTIMAL, JAZZ, ROCK or POP).

VAC

- Selects different type of environment ambience-based equalizer settings (HALL, CINEMA, CONCERT, CYBER or ARCADE).

⑰ MASTER VOLUME (VOL + -)

- Adjusts the volume level.

⑱ PROG (PROGRAM)

- **CD:** starts or confirms tracks programming.
- **TUNER:** starts *automatic/manual preset programming.
- **CLOCK:** selects 12- or 24-hour clock display.

⑲

- Plug in the headphones jack. The speakers output will be cancelled.

⑳ VU meters

- Indicates signal strength of left/right channel.

㉑ iR SENSOR

- Point the remote control towards this sensor.

㉒ Disc trays (1~5)

㉓ OPEN·CLOSE ▲ (DISC 1~5)

- Opens/closes the individual disc tray.

Control buttons available on the remote only

㉔ CD 1~5

- Selects a disc tray to playback.

㉕ REPEAT

- Repeats a track/disc/all discs/all programmed tracks.

㉖ SLEEP

- Sets the sleep timer function.

㉗ MUTE

- Mutes or restores the volume.

㉘ TIMER ON/OFF

- Turns on/off the timer function.

㉙ SHUFFLE

- Turns on/off the random play mode.

㉚ DISPLAY

- Displays disc remaining playback time.

㉛

- Switches to Eco Power standby mode.
- *Switches to standby mode.

* = Press and hold the button for more than two seconds.

Connections

English

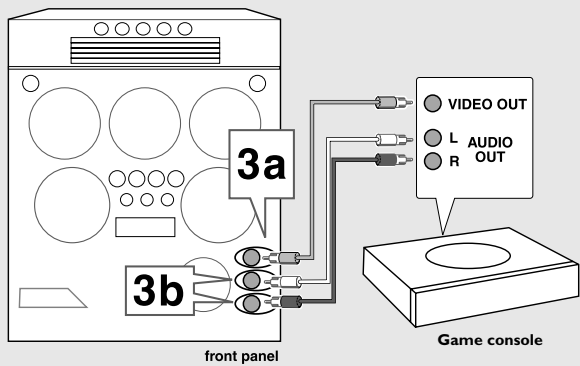
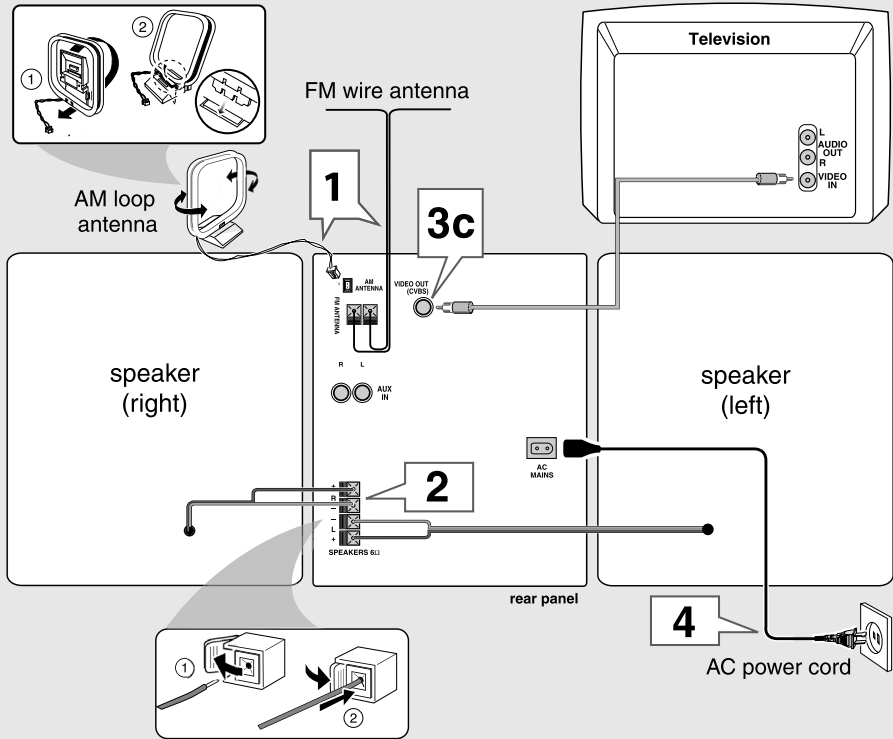

WARNING!

- Use only the supplied speakers. The combination of the main unit and speakers provide the best sound. Using other speakers can damage the unit and sound quality will be negatively affected.
- Never make or change connections with the power switched on.
- Connect the AC power cord to the power outlet only after you have finished hooking up everything.

Step 1: Connecting FM/AM antennas

- Place the AM loop antenna on a shelf or attach it to a stand or wall.
- Extend the FM antenna and fix its ends to the wall.
- Adjust the position of the antennas for optimal reception.
- Position the antennas as far as possible from a TV, VCR or other radiation source to prevent unwanted noise.
- For better FM stereo reception, connect external FM antenna.

Step 2: Connecting the speakers

Connect the speaker wires to the SPEAKERS terminals, right speaker to "R" and left speaker to "L", colored (marked) wire to "+" and black (unmarked) wire to "-". Fully insert the stripped portion of the speaker wire into the terminal as shown.

Notes:

- Ensure that the speaker cables are correctly connected. Improper connections may damage the system due to short-circuit.
- Do not connect more than one speaker to any one pair of + / - speaker terminals.

Step 3: Connecting to game console

IMPORTANT!

Gameport inputs are solely for game console only.

- a. Use the game console's video cable (not supplied) to connect its video output to the GAMEPORT-VIDEO terminal.
- b. Use the game console's audio cables (not supplied) to connect its audio outputs to the GAMEPORT-AUDIO L. / AUDIO R. terminals.
- c. Use a video cable (yellow) to connect the VIDEO OUT terminal to the video input on the TV for viewing.

Notes:

- On the TV, the Video Input jack is usually yellow and might be labeled A/V In, CVBS, Composite or Baseband.
- To avoid magnetic interference, do not position the front speakers too close to your TV.

Step 4: Connecting the AC power cord

"AUTO INSTALL - PRESS PLAY" may appear on the display panel when the AC power cord is plugged into the power outlet for the first time. Press ►|| on the main unit to store all available radio stations (page 3 - P3) or press ■ to exit (refer to "Tuner Operations").

Step 5: Inserting batteries into the remote control

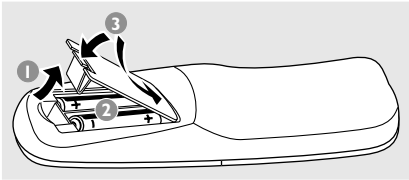

- 1 Open the battery compartment cover.
- 2 Insert two batteries type R06 or AA, following the indications (+ -) inside the compartment.
- 3 Close the cover.

Using the remote control to operate the system

- 1 Aim the remote control directly at the remote sensor (iR) on the main unit.
- 2 Select the source you wish to control by pressing one of the source select keys on the remote control (for example CD, TUNER).
- 3 Then select the desired function (for example ► II, ◀, ▶).

CAUTION!

- Remove batteries if they are exhausted or will not be used for a long time.
- Do not use old and new or different types of batteries in combination.
- Batteries contain chemical substances, so they should be disposed of properly.

About Gameport

Gameport allows you to connect your game console to this mini system which enables you to enjoy a total game immersion experience by having powerful sound output.

Preparation before use

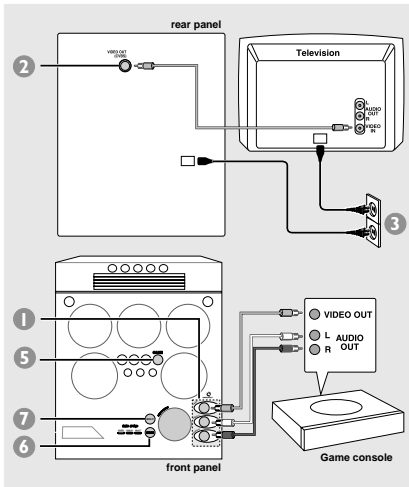

- 1 Connect your game console's video and audio output to the GAMEPORT video and audio inputs respectively (refer to "Connections - Connecting to game console").
- 2 Connect your TV's video input to the **VIDEO OUT (CVBS)** on the rear panel.
- 3 Connect all the AC power cord to the power outlet.

Start operating

- 4 Turn on the TV and set to the correct video-in channel.
The TV's video input channel may be called AUX(iliary) IN, AUDIO/VIDEO (A/V) IN, EXT 1, etc. These channels are often near channel 00 on your TV. Or, your TV remote control may have a button or switch that chooses different video modes. See your TV manual for details.

- 5 Press **GAME**.
→ "GAMEPORT" is displayed.
- 6 Press **MODE** (or **GAME SOUND** on remote) to select the type of sound setting that best suit the game : **SPEED, PUNCH, BLAST** or **OFF**.
- 7 If you like to mix your game sound to your favorite music, press **MIX-IT** to select the desired music source : **CD, TUNER, AUX** or **OFF**.
CD → "MIX-CD"
TUNER → "MIX-TU"
AUX → "MIX-AUX"
OFF → "MIX-OFF"
- 8 If necessary, start playback your chosen mixer source.
- 9 Start playing your favorite game.

To adjust the game console's volume level

- Adjust **GAME VOLUME**.

To change the mixer source

- Press **MIX-IT**.

To control the current active mixer source

- Press the respective source button (for example, CD, TUNER) on the remote, then select the desired function (for example ►, ◀, ▶).

For example, if CD is the mixer source and to change the disc tray, you have to press CD, then press CD 1~5 to select the desired disc tray.

Notes:

- You can only activate GAME VOLUME and MIX-IT while in game source mode.
- If your game console is switched on, the video image will always appear on the TV even though you are not in the gameport mode.

Basic Operations

Switching on/off

Switching to active mode

- Press **CD, TUNER, AUX** or **GAME**.

Switching to Eco Power standby mode

- Press **⏻**.
 - ECO POWER button lights up.
 - The display screen will go blank.

Switching to standby mode (view clock)

- Press and hold **⏻**.
 - The clock is displayed.
 - While in standby mode, pressing CLOCK•TIMER button will switch the system to Eco Power standby mode.

Note:

– Before switching the system to Eco Power standby or standby mode, make sure the demonstration mode has been deactivated.

Demonstration mode

If the demonstration mode is active, whenever you switch the system to Eco Power standby or standby mode, it will begin showing the various features offered by the system.

To activate the demonstration

- In Eco Power standby/standby mode, press and hold **■** on the main unit until "DEMO ON" is displayed.

To deactivate the demonstration

- Press and hold **■** on the main unit until "DEMO OFF" is displayed.

Setting the clock

The clock can be set in either 12-hour or 24-hour mode ("11:59 PM" or "23:59" for example).

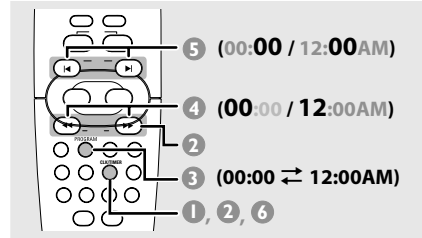

- 1 Press and hold **CLK/TIMER** (or **CLOCK•TIMER** on main unit) until "SELECT CLOCK OR TIMER" is displayed.
- 2 Press **▶** to change the display to "CLOCK" and press **CLK/TIMER (CLOCK•TIMER)** again to confirm.
- 3 Press **PROGRAM (PROG)** repeatedly to change between 12-hour and 24-hour clock mode.
- 4 Press **◀** or **▶** repeatedly to set the hour.
- 5 Press **◀** or **▶** repeatedly to set the minute.
- 6 Press **CLK/TIMER (CLOCK•TIMER)** to store the setting.
 - The clock will start working.

To view the clock time in any active mode

- Press **CLK/TIMER (CLOCK•TIMER)** **once**.
 - The clock is displayed for a few seconds.

Notes:

– The clock setting will be erased when the system is disconnected from the power supply.
 – The system will exit clock setting mode if no button is pressed within 90 seconds.

Dimming system's display screen

You can select the desired brightness for the display panel.

- In any active mode, press **DIM MODE** (or **DIM** on remote) repeatedly to turn on/off dim mode.
→ **DIM** is shown, except for DIM OFF mode.

Volume control

- Adjust **MASTER VOLUME** (or press **VOL + / -** on remote) to increase or decrease the sound level.
→ "**VOL MIN**" is the minimum volume level and "**VOL MAX**" is the maximum volume level.

To switch off the volume temporarily

- Press **MUTE** on the remote.
→ Playback will continue without sound and "**MUTE**" is displayed.
→ To restore the volume, press **MUTE** again or increase the volume level.

Sound control

MAX sound, DSC and VAC sound features cannot be activated on the same time.

While in game mode, all the sound control features are not available for selection, except DBB and Game Sound control.

MAX sound

MAX sound provides the best mixture of various sound features (DSC, VAC for example).

- Press **MAX SOUND** (or **MAX ON/OFF** on remote).
→ If activated, the MAX SOUND button lights up. All other sound effects (DSC, VAC or DBB) will be switched off automatically.

Digital Sound Control

DSC provides a different type of preset sound equalizer setting.

- Press **DSC** repeatedly to select : **OPTIMAL**, **JAZZ**, **ROCK** or **POP**.

Virtual Ambience Control

VAC provides a different type of environment-based equalizer setting.

- Press **VAC** repeatedly to select : **HALL**, **CINEMA**, **CONCERT**, **CYBER** or **ARCADE**.

Dynamic Bass Boost

DBB enhances the bass response.

- Press **DBB** repeatedly to select : **DBB 1**, **DBB 2**, **DBB 3** or **DBB OFF**.
→ Some discs might be recorded in high modulation, which causes a distortion at high volume. If this occurs, switch off DBB or reduce the volume.

Automatic DSC-DBB and VAC-DBB selection

The best DBB setting is generated automatically for each DSC, VAC or Game Sound selection. You can manually select the DBB setting that best suits your listening environment.

IMPORTANT!

- This system is designed for regular discs. Therefore, do not use any accessories such as disc stabilizer rings or disc treatment sheets, etc., as offered on the market, because they may jam the changer mechanism.
- Do not load more than one disc onto each tray.

Playable discs

This system is able to play :

- All pre-recorded audio CDs
- All finalized audio CDR and audio CDRW discs

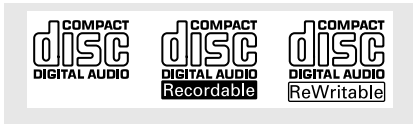

Loading discs (page 3 - P4)

- 1 Press **OPEN•CLOSE ▲ DISC 1** button on top of the main unit to open disc tray 1.
- 2 Load a disc with the label side facing up. For double-sided discs, load the side you want to play facing up.
- 3 Press **OPEN•CLOSE ▲ DISC 1** button again to close the disc tray.
→ "READING" is displayed. The selected disc tray, total number of tracks and the playing time will appear on the display.
- 4 Repeat **steps 1~3** for loading discs onto the **disc trays 2~5**.

Notes:

- To ensure good system performance, wait until the disc trays completely read the disc(s) before proceeding.
- Only one tray can be opened at each time. If you open the second tray before closing the first tray, the first tray will automatically close before the second tray opens.

Basic playback controls

Load discs (page 3 - P4).

To play all discs on the disc trays

- Press **▶||**
OR

In stop mode, press **CD** to select a disc tray to begin, then press **▶||**.

→ All the available discs will play once, then stop.

To play the selected disc only

- Press one of the **CD 1~5** on remote.
→ The selected disc will play once, then stop.

To select a desired track

- Press **◀** or **▶** repeatedly until the desired track is displayed.
→ To skip to the beginning of the current track during playback, press **◀ once**.
→ During random play (shuffle mode), pressing **◀** will cause the player to skip only to the beginning of the current track.

To search for a particular passage during playback

- Press and hold **◀◀** or **▶▶** and release it when the desired passage is located.
→ During searching, the volume will be reduced.

To replace discs without interrupting playback

- Press **OPEN•CLOSE ▲** buttons of the inactive disc trays (refer to "Loading discs"). For example, if currently disc tray 1 is playing, you can replace the discs on disc tray 2~5.

To check the disc remaining playing time

- Press **DISPLAY** on the remote.
→ During random play or program play, the total remaining time will not be shown.
→ To restore the display for elapsed playing time, repeat the above.

To interrupt playback

- Press **▶||**
→ To resume normal playback, repeat the above.

To stop playback

- Press **■**.
→ If the system remains in stop mode for 30 minutes, it will switch to Eco Power standby mode.

Repeat and Shuffle

You can select and change the various play modes before or during playback.

Repeat play

- 1 Press **REPEAT** on the remote repeatedly to select :

(A)	REP TRK	(D)	PROG REP TRK
(B)	REP DISC	(E)	PROG REP ALL
(C)	REP DISC ALL		

- (A) – to repeat playback of the current track.
 - (B) – to repeat playback of the current disc.
 - (C) – to repeat playback of all available discs.
 - (D) – to repeat playback of the current programmed track (only if the program mode is active)
 - (E) – to repeat playback of all the programmed tracks (only if the program mode is active)
- 2 To resume normal playback, press **REPEAT** until "OFF" is displayed.

Random play

- Press **SHUFFLE** on the remote to turn on/off the shuffling mode.
→ If activated, **SHUF** is shown and the repeat mode (if any) will be cancelled.
→ All the available discs or programmed tracks (if program is active) will be played in random order.

Note:

- Pressing the **OPEN•CLOSE** button will cancel all repeat and shuffling modes.

Programming the disc tracks

Programming tracks is possible when playback is stopped. Up to 40 tracks can be stored in the memory in any order.

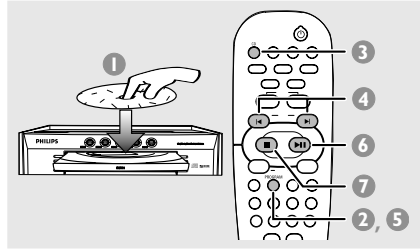

- 1 Load the desired discs on the disc trays (refer to "Loading discs").
- 2 Press **PROGRAM (PROG)** to start programming.
→ **PROG** starts flashing.
- 3 Press **CD** or one of the **CD 1-5** buttons to select a disc.
- 4 Press **◀** or **▶** repeatedly to select the desired track.
- 5 Press **PROGRAM (PROG)** to store.
- Repeat **steps 3-5** to select other discs and store the tracks.
→ Skip step 3 if you are selecting tracks from the same disc.
→ If you attempt to program more than 40 tracks, "PROGRAM FULL" is displayed.
- 6 To start program play, press **▶||**.
- 7 To stop playback or to end the programming, press **■** once.
→ **PROG** stays and the program mode remains active.

Notes:

- If the total playing time reached 100 minutes or if one of the programmed tracks has a number greater than 30, then "----:--" is displayed instead of the total playing time.
- The system will exit programming mode if no button is pressed within 20 seconds.

Disc Operations

Checking the program

1 Stop playback and press ◀ or ▶ repeatedly.

2 Press ■ to exit.

OR

Press ▶|| to start playback from the current programmed track

Playing a disc without clearing the program

- Press one of the **CD 1~5** buttons on the remote to select a disc for playback.
→ After the selected disc has been played, the program mode will resume.

Clearing the program

- Stop playback, then press ■ to clear the program.

OR

Press the **OPEN•CLOSE ▲** button of the programmed disc tray.

→ **PROG** disappears and "PROGRAM CLEARED" is displayed.

Note:

- The program will be erased if the system is disconnected from the power supply.

IMPORTANT!

Make sure the FM and AM antennas are connected.

Tuning to radio stations

- 1 Press **TUNER** to enter tuner mode. To select another waveband (FM or AM), press TUNER again.
 - 2 Press and hold ◀◀ or ▶▶ until the frequency indication starts to change, then release.
 - The system automatically tunes to the next strong signal radio reception.
 - ∞ lights up for FM stereo reception.
- For tuning to a weak signal station,**
- Press ◀◀ or ▶▶ briefly and repeatedly until an optimal reception is found.

Presetting radio stations

You can store up to 40 preset radio stations in the memory, starting from FM and followed by AM bands.

Notes:

- The system will exit presetting mode if no button is pressed within 20 seconds.
- If no stereo frequency is detected during Plug and Play, "CHECK ANTENNA" is displayed.

Using the Plug and Play (page 3 - P3)

Plug and Play allows you to store all available radio stations automatically.

- 1 **Connect the system to the power supply,** "AUTO INSTALL -- PRESS PLAY" is displayed.
OR
In Eco Power standby/standby mode, press and hold ▶▶ on the main unit until "AUTO INSTALL -- PRESS PLAY" is displayed.
- 2 Press ▶▶ on the main unit to start installation.
 - "INSTALL TUNER" is displayed.
 - All previously stored radio stations will be replaced.
 - Once completed, the last tuned radio station will be played.

Automatic presetting

You can start the automatic presetting from a selected preset number.

- 1 In tuner mode, press ◀ or ▶ to select a preset number.
- 2 Press and hold **PROGRAM (PROG)** until "AUTO" is displayed.
 - If a radio station has been stored in one of the presets, it will not be stored again under another preset number.
 - If no preset number is selected, automatic preset will begin from preset (1) and all your former presets will be overridden.

Manual presetting

You can choose to store only the favorite radio stations.

- 1 Tune to your desired radio station (refer to "Tuning to radio stations").
- 2 Press **PROGRAM (PROG)**.
 - The preset number starts flashing. If you want to store the radio station in another preset number; press ◀ or ▶.
- 3 Press **PROGRAM (PROG)** again to store.
- Repeat **steps 1–3** to store other radio stations.

Selecting a preset radio station

- In tuner mode, press ◀ or ▶.
 - The preset number, radio frequency, and waveband are displayed.

Deleting a preset radio station

- Press and hold ■ until "PRESET DELETED" is displayed.
 - The current preset radio station will be deleted.
 - All other preset radio stations with higher numbers are decreased by one.

Timer Operations

Timer setting

The system can switch on to CD or TUNER mode automatically at a preset time, serving as an alarm to wake you up.

IMPORTANT!

- Before setting the timer, ensure that the clock is set correctly.
- The volume of the timer will increase gradually to the last tuned volume level. If the last tuned volume level is too low, the set will then increase to a predetermined minimum audible level.

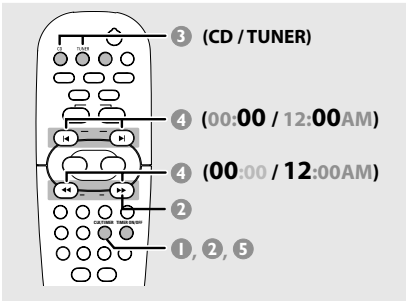

- 1 Press and hold **CLK/TIMER** (or **CLOCK•TIMER** on main unit) until "SELECT CLOCK OR TIMER" is displayed.
- 2 Press **▶** to change the display to "TIMER" and press **CLK/TIMER** again to confirm.
- 3 Press **CD** or **TUNER** to select the wake-up source.
CD → "CD XX:XX"
TUNER → "TU XX:XX"
- 4 Press **◀◀** or **▶▶** (for hours) and **◀** or **▶** (for minutes) repeatedly to set the wake up time.
- 5 Press **CLK/TIMER** to store the setting.
→ The timer will always be switched on after it has been set.
→  icon remains on the display. It indicates the timer is activated.

- **At the preset time, the selected sound source will be played for 30 minutes before it switches to Eco Power standby mode** (if no button is being pressed within the time frame).
→ **CD** – playing the first track of the last selected disc or programmed track (if program mode is active). If the last selected disc tray is empty, it will switch to the next available disc. If all the disc trays are not available, it will switch to Tuner mode.
→ **TUNER** – playing the last tuned radio station.

Activating/Deactivating the timer

- Press **TIMER ON/OFF** on the remote to turn off the timer or turn on to the last setting again.
→ If activated, the timer information will display for a few seconds, then the system resumes to the last active source or stays in standby mode.
→ If deactivated, "OFF" is displayed.

Note:

- The system will exit timer setting mode if no button is pressed within 90 seconds.

Sleep timer setting

The sleep timer enables the system to switch to Eco Power standby mode automatically at a preset time.

- 1 Press **SLEEP** repeatedly until it reaches the desired preset turn-off time.
 - The selections are as follows (time in minutes):
 15 → 30 → 45 → 60 → 90 → 120 →
 OFF → 15 ...
 - **SLEEP** is shown, except for "OFF" mode.
 - To view or change the setting, repeat the above.
- 2 Before the system switches to Eco Power standby mode, a countdown of 10 seconds is displayed.
 "SLEEP 10" → "SLEEP 9"... → "SLEEP 1"
 → "SLEEP"

To cancel the sleep timer function

- Press **SLEEP** repeatedly until "OFF" is displayed, or press the **STANDBY ON**  button.

Listening to an external source

You can listen to the sound of the connected external device through your system's speakers.

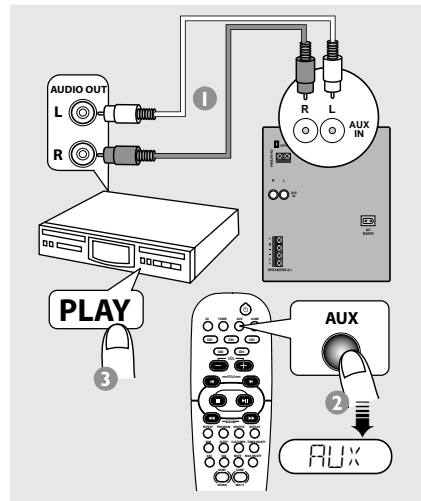

- 1 Use the red/white audio cables to connect the system's **AUX IN (R/L)** terminals to the AUDIO OUT terminals on the other audio/visual device (such as a TV, VCR, Laser Disc player, DVD player or CD recorder)
 - If the connecting device has only a single audio out terminal, connect it to the AUX IN left terminal. Alternatively, you can use a "single to double" cinch cable, but the output sounds still remain monaural.
- 2 Press **AUX**.
 - "AUX" is displayed.
- 3 Press **PLAY** on the connected device to start playback.

Notes:

- All the sound control features (DSC, VAC for example) are available for selection.
- Always refer to the owner's manual of the other equipment for complete connection and use details.

Specifications

AMPLIFIER

Output power	280 W total power 2 × 140 W RMS ⁽¹⁾ 2 × 130 W FTC ⁽¹⁾
Signal-to-noise ratio	≥ 75 dBA (IEC)
Frequency response	50 – 18000 Hz, –3 dB
Input sensitivity	
AUX In	640 mV
Gameport	310 mV
Output	
Speakers	≥ 6 Ω
Headphones	32 Ω – 1000 Ω

(1) (6 Ω, 60 Hz – 12.5 kHz, 10%THD)

DISC PLAYER

Programmable tracks	40
Frequency response	20 – 20000 Hz, –3 dB
Signal-to-noise ratio	≥ 76 dBA
Channel separation	≥ 60 dB (1 kHz)

TUNER

FM wave range	87.5 – 108 MHz
AM wave range	530 – 1700 kHz
Number of presets	40
Antenna	
FM	300 Ω dipole wire
AM	Loop antenna

SPEAKERS

System	3 way, Bass reflex
Impedance	6 Ω
Woofer	1 × 6.5"
Tweeter	1 × 2" Ferrofluid cooled
Dimensions (w × h × d)	310 × 325 × 240 (mm) 12.20" × 12.80" × 9.45"
Weight	4.35 kg each / 9.57 pounds each

GENERAL

Material/finish	Polystyrene/Metal
AC Power	120 V / 60 Hz
Power Consumption	
Active	175 W
Standby	< 25 W
Eco Power Standby	< 1 W
Dimensions (w × h × d)	265 × 390 × 322 (mm) 10.43" × 15.35" × 12.68"
Weight (without speakers)	4.3 kg / 9.46 pounds

Specifications and external appearance are subject to change without notice.

WARNING

Under no circumstances should you try to repair the system yourself, as this will invalidate the warranty. Do not open the system as there is a risk of electric shock.

If a fault occurs, first check the points listed below before taking the system for repair. If you are unable to remedy a problem by following these hints, please call **1-800-531-0039** for help.

Problem	Solution
Radio reception is poor.	<ul style="list-style-type: none"> ✓ If the signal is too weak, adjust the antenna or connect an external antenna for better reception. ✓ Increase the distance between the system and your TV or VCR.
“NO DISC” is displayed or the disc cannot be played.	<ul style="list-style-type: none"> ✓ Insert a disc. ✓ Load in the disc with label facing right. ✓ Replace or clean the disc, see "Care and safety information".
“DISC NOT FINALIZED” is displayed.	<ul style="list-style-type: none"> ✓ Use a finalized CD-R(W) or a correct format disc.
The system does not react when buttons are pressed.	<ul style="list-style-type: none"> ✓ Remove and reconnect the AC power cord and switch on the system again.
Sound cannot be heard or is of poor quality.	<ul style="list-style-type: none"> ✓ Adjust the volume. ✓ Disconnect the headphones. ✓ Check that the speakers are connected correctly. ✓ Check that the AC power cord is connected properly.
The remote control does not function properly.	<ul style="list-style-type: none"> ✓ Select the source (CD or TUNER, for example) before pressing the function button (▶ , ◀◀, ▶▶). ✓ Reduce the distance between the remote control and the system. ✓ Replace the battery. ✓ Point the remote control directly toward the IR sensor.
The timer is not working.	<ul style="list-style-type: none"> ✓ Set the clock correctly. ✓ Press TIMER ON/OFF to switch on the timer.
The system displays features automatically and buttons start flashing.	<ul style="list-style-type: none"> ✓ Press and hold DEMO STOP on the main unit to switch off the demonstration mode.

LIMITED WARRANTY

AUDIO SYSTEM

One Year Free Labor

One Year Free Service on Parts

This product must be carried in for repair.

WHO IS COVERED?

You must have proof of purchase to receive warranty service. A sales receipt or other document showing that you purchased the product is considered proof of purchase.

WHAT IS COVERED?

Warranty coverage begins the day you buy your product. For one year thereafter, all parts will be repaired or replaced, and labor is free. After one year from the day of purchase, you pay for the replacement or repair of all parts, and for all labor charges.

All parts, including repaired and replaced parts, are covered only for the original warranty period. When the warranty on the product expires, the warranty on all replaced and repaired parts also expires.

WHAT IS EXCLUDED?

Your warranty does not cover:

- labor charges for installation or setup of the product, adjustment of customer controls on the product, and installation or repair of antenna systems outside of the product.
- product repair and/or part replacement because of misuse, accident, unauthorized repair or other cause not within the control of Philips.
- reception problems caused by signal conditions or cable or antenna systems outside the unit.
- a product that requires modification or adaptation to enable it to operate in any country other than the country for which it was designed, manufactured, approved and/or authorized, or repair of products damaged by these modifications.
- incidental or consequential damages resulting from the product. (Some states do not allow the exclusion of incidental or consequential damages, so the above exclusion may not apply to you. This includes, but is not limited to, prerecorded material, whether copyrighted or not copyrighted.)
- a product that is used for commercial or institutional purposes.

WHERE IS SERVICE AVAILABLE?

Warranty service is available in all countries where the product is officially distributed by Philips. In countries where Philips does not distribute the product, the local Philips service organization will attempt to provide service (although there may be a delay if the appropriate spare parts and technical manual(s) are not readily available).

MAKE SURE YOU KEEP..

Please keep your sales receipt or other document showing proof of purchase. Attach it to this owner's manual and keep both nearby. Also keep the original box and packing material in case you need to return your product.

BEFORE REQUESTING SERVICE...

Please check your owner's manual for assistance. If you have additional questions, call us at 1-800-531-0039.

TO GET WARRANTY SERVICE IN U.S.A., PUERTO RICO, OR U.S. VIRGIN ISLANDS...

Take the product to a Philips factory service center (see enclosed list) or authorized service center for repair. When the product has been repaired, you must pick up the unit at the center. Centers may keep defective parts.

(In U.S.A., Puerto Rico, and U.S. Virgin Islands, all implied warranties, including implied warranties of merchantability and fitness for a particular purpose, are limited in duration to the duration of this express warranty. But, because some states do not allow limitations on how long an implied warranty may last, this limitation may not apply to you.)

TO GET WARRANTY SERVICE IN CANADA...

Please contact Philips at:

1-800-661-6162 (French Speaking)
1-800-531-0039 (English or Spanish Speaking)

(In Canada, this warranty is given in lieu of all other warranties. No other warranties are expressed or implied, including any implied warranties of merchantability or fitness for a particular purpose. Philips is not liable under any circumstances for any direct, indirect, special, incidental or consequential damages, howsoever incurred, even if notified of the possibility of such damages.)

REMEMBER...

Please record below the model and serial numbers found on the product. Also, please fill out and mail your warranty registration card promptly. It will be easier for us to notify you if necessary.

MODEL # _____

SERIAL # _____

This warranty gives you specific legal rights. You may have other rights which vary from state/province to state/province.

Philips, P.O. Box 520890, Miami, FL 33152, USA, (402) 536-4171

EL4965E007 / 8-02

Free Manuals Download Website

<http://myh66.com>

<http://usermanuals.us>

<http://www.somanuals.com>

<http://www.4manuals.cc>

<http://www.manual-lib.com>

<http://www.404manual.com>

<http://www.luxmanual.com>

<http://aubethermostatmanual.com>

Golf course search by state

<http://golfingnear.com>

Email search by domain

<http://emailbydomain.com>

Auto manuals search

<http://auto.somanuals.com>

TV manuals search

<http://tv.somanuals.com>