

PHILIPS

FW-D5
Mini Hi-Fi System
with DVD and 3 CD changer



Toll Free Help Line
Ligne d'assistance en service libre
Línea de ayuda telefónica sin cargo
800-531-0039



PHILIPS

Let's make things better.

Return your Warranty Registration card today to ensure you receive all the benefits you're entitled to.

- Once your Philips purchase is registered, you're eligible to receive all the privileges of owning a Philips product.
- So complete and return the Warranty Registration Card enclosed with your purchase at once. And take advantage of these important benefits.

Warranty Verification

Registering your product within 10 days confirms your right to maximum protection under the terms and conditions of your Philips warranty.

Owner Confirmation

Your completed Warranty Registration Card serves as verification of ownership in the event of product theft or loss.

Model Registration

Returning your Warranty Registration Card right away guarantees you'll receive all the information and special offers which you qualify for as the owner of your model.

Know these safety symbols



This "bolt of lightning" indicates uninsulated material within your unit may cause an electrical shock. For the safety of everyone in your household, please do not remove product covering.



The "exclamation point" calls attention to features for which you should read the enclosed literature closely to prevent operating and maintenance problems.

For Customer Use

Enter below the Serial No. which is located on the rear of the cabinet. Retain this information for future reference.

Model No. _____

Serial No. _____

WARNING: TO PREVENT FIRE OR SHOCK HAZARD, DO NOT EXPOSE THIS EQUIPMENT TO RAIN OR MOISTURE.

CAUTION: To prevent electric shock, match wide blade of plug to wide slot, and fully insert.

PHILIPS

***Congratulations on your purchase,
and welcome to the "family!"***

Dear Philips product owner:

Thank you for your confidence in Philips. You've selected one of the best-built, best-backed products available today. And we'll do everything in our power to keep you happy with your purchase for many years to come.

As a member of the Philips "family," you're entitled to protection by one of the most comprehensive warranties and outstanding service networks in the industry.

What's more, your purchase guarantees you'll receive all the information and special offers for which you qualify, plus easy access to accessories from our convenient home shopping network.



And most importantly you can count on our uncompromising commitment to your total satisfaction.

All of this is our way of saying welcome—and thanks for investing in a Philips product.

Sincerely,

Robert Minkhorst
President and Chief Executive Officer

P.S. Remember, to get the most from your Philips product, you must return your Warranty Registration Card within 10 days. So please mail it to us right now!

IMPORTANT SAFETY INSTRUCTIONS – Read before operating equipment

English

This product was designed and manufactured to meet strict quality and safety standards. There are, however, some installation and operation precautions which you should be particularly aware of.

1. **Read these instructions** – All the safety and operating instructions should be read before the appliance is operated.
2. **Keep these instructions** – The safety and operating instructions should be retained for future reference.
3. **Heed all warnings** – All warnings on the appliance and in the operating instructions should be adhered to.
4. **Follow all instructions** – All operating and use instructions should be followed.
5. **Do not use this apparatus near water** – for example, near a bathtub, washbowl, kitchen sink, laundry tub, in a wet basement or near a swimming pool, etc.
6. **Clean only with a damp cloth.** The appliance should be cleaned only as recommended by the manufacturer.
7. **Install in accordance with the manufacturers instructions. Do not block any of the ventilation openings.** For example, the appliance should not be situated on a bed, sofa, rug, or similar surface or placed in a built-in installation, such as a bookcase or cabinet that may impede the flow of air through the ventilation openings.
8. **Do not install near any heat sources** such as radiators, heat registers, stoves, or other apparatus (including amplifiers) that produce heat.

9. **Do not defeat the safety purpose** of the polarized or grounding-type plug.

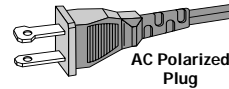

AC Polarized Plug

A polarized plug has two blades with one wider than the other. A grounding type plug has two blades and a third grounding prong. The wide blade or the third prong are provided for your safety. When the provided plug does not fit into your outlet, consult an electrician for replacement of the obsolete outlet.

10. **Protect the power cord** from being walked on or pinched particularly at plugs, convenience receptacles, and the point where they exit from the apparatus.
11. **Only use attachments/accessories** specified by the manufacturer.
12.  **Use only with a cart**, stand, tripod, bracket, or table specified by the manufacturer, or sold with the apparatus. When a cart is used, use caution when moving the cart/apparatus combination to avoid injury from tip-over.
13. **Unplug this apparatus** during lightning storms or when unused for long periods of time.
14. **Refer all servicing** to qualified service personnel. Servicing is required when the apparatus has been damaged in any way, such as power-supply cord or plug is damaged, liquid has been spilled or objects have fallen into the apparatus, the apparatus has been exposed to rain or moisture, does not operate normally, or has been dropped.



This symbol warns the user that uninsulated voltage within the unit may have sufficient magnitude to cause electric shock. Therefore, it is dangerous to make any kind of contact with any inside part of this unit.



This symbol alerts the user that important literature concerning the operation and maintenance of this unit has been included. Therefore, it should be read carefully in order to avoid any problems.

WARNING

To reduce the risk of fire or electric shock, do not expose this appliance to rain or moisture.

CAUTION

Use of controls or adjustments or performance of procedures other than herein may result in hazardous radiation exposure.

The set complies with the FCC-Rules, Part 15 and with 21 CFR 1040.10.

Canada

This digital apparatus does not exceed the Class B limits for radio noise emissions from digital apparatus as set out in the Radio Interference Regulations of the Canadian Department of Communications.

CAUTION: INVISIBLE LASER RADIATION WHEN OPEN. DO NOT STARE INTO BEAM.
DANGER: INVISIBLE LASER RADIATION WHEN OPEN. AVOID DIRECT EXPOSURE TO BEAM.

EL 4562-E004: 99/3



INDEX

English 7

English

Français 47

Français

Español 89

Español



**CLASS 1
LASER PRODUCT**

LASER SAFETY

This unit employs a laser. Only a qualified service person should remove the cover or attempt to service this device, due to possible eye injury.

USE OF CONTROLS OR ADJUSTMENTS OR PERFORMANCE OF PROCEDURES OTHER THAN THOSE SPECIFIED HEREIN MAY RESULT IN HAZARDOUS RADIATION EXPOSURE.

LASER

Type	Semiconductor laser GaAlAs
Wave length	650 nm (DVD) 785 nm (VCD/CD)
Output Power	7 mW (DVD) 10 mW (VCD/CD)
Beam divergence	60 degree.

This product incorporates copyright protection technology that is protected by method claims of certain U.S. patents and other intellectual property rights owned by Macrovision Corporation and other rights owners. Use of this copyright protection technology must be authorized by Macrovision Corporation, and is intended for home and other limited viewing uses only unless otherwise authorized by Macrovision Corporation. Reverse engineering or disassembly is prohibited.

Manufactured under license from Dolby Laboratories. "Dolby", "AC-3" and the double-D symbol are trademarks of Dolby Laboratories. Confidential Unpublished Works. ©1992-1997 Dolby Laboratories, Inc. All rights reserved.

TruSurround and the SRS symbol are trademarks of SRS Labs., Inc. TruSurround technology is manufactured under license from SRS Labs., Inc.

TruSurround™
with **SRS (●)®**

Dolby Surround and the double-D symbol  are trademarks of Dolby Laboratories Licensing Corporation. Manufactured under license from Dolby Laboratories Licensing Corporation.

 DOLBY
D I G I T A L

NEVER MAKE OR CHANGE CONNECTIONS WITH THE POWER SWITCHED ON.

CAUTION

VISIBLE AND INVISIBLE LASER RADIATION WHEN OPEN AVOID EXPOSURE TO BEAM (WARNING LOCATION: INSIDE ON LASER COVERSIELD)



The region code for this set is 1.

Since it is usual for DVD movies to be released at different times in different regions of the world, all players have region codes and discs can have an optional region code. If you load a disc of a different region code to your player, you will see the region code notice on the screen. The disc will not play, and should be unloaded.

For Customer Use:

Read carefully the information located at the bottom of your DVD-VIDEO player and enter below the Serial No. Retain this information for future reference.

Model No. _____

Serial No. _____



INDEX

English

General Information	8
Safety Information	8
Preparation	9 - 11
Controls	12 - 14
Operating The System	15 - 17
DVD-VIDEO	18 - 32
CD	33 - 35
Tuner	36 - 37
AUX/CDR	37
Clock	38
Timer	38 - 39
Sleep Timer	39
Specifications	40
Maintenance	41
Troubleshooting	41 - 42



GENERAL INFORMATION

English

General Information

- **The typeplate (which contains the serial number) is located at the rear of the system.**
- **Recording is permissible if copyright or other rights of third parties are not infringed.**
- **This device complies with the Federal Communications Commission (FCC) rules, part 15 and with 21 CFR 1040.10. Operation is subject to the following two conditions:**
 - **This device may not cause harmful interference, and**
 - **This device must accept any interference received, including interference that may cause undesired operation.**

Environmental Information

All unnecessary packaging has been omitted. We have tried to make the packaging easy to separate into three materials: cardboard (box), polystyrene foam (buffer) and polyethylene (bags, protective foam sheet).

Your system consists of materials which can be recycled and reused if disassembled by a specialized company. Please observe the local regulations regarding the disposal of packaging materials, exhausted batteries and old equipment.

Energy Star



As an ENERGY STAR® Partner, Philips has determined that this product meets the ENERGY STAR® guidelines for energy efficiency.

Accessories (Supplied)

- Remote control
- Batteries (two AA size) for remote control
- AM loop antenna
- FM wire antenna
- AC power cord
- CS-05 speaker package (includes one pair of surround speakers and one center speaker)
- CVBS cable cinch

SAFETY INFORMATION

Safety Information

- Before operating the system, check that the operating voltage indicated on the typeplate (or the voltage indication beside the voltage selector) of your system is identical with the voltage of your local power supply. If not, please consult your dealer. The typeplate is located at the rear of your system.
 - When the system is switched on, do not move it around.
 - Place the system on a solid base (e.g. a cabinet).
 - Place the system in a location with adequate ventilation to prevent internal heat build-up in your system. Allow at least 10 cm (4 inches) clearance from the rear and the top of the unit and 5 cm (2 inches) from each side.
 - Do not place the system on soft carpet that will cover the ventilation hole at the bottom.
 - The system incorporates a built-in safety feature that prevents overheating.
 - Do not expose the system to excessive moisture, rain, sand or heat sources.
 - Under no circumstances should you repair the system yourself, as this will invalidate the warranty!
- If the system is brought directly from a cold to a warm location, or is placed in a very damp room, moisture may condense on the lens of the CD/DVD unit inside the system. Should this occur, the player will not operate normally. Leave the power on for about one hour with no disc in the system until normal playback is possible.
 - Electrostatic discharge may cause unexpected problems. See whether these problems disappear if you unplug the AC power cord and plug it in again after a few seconds.
 - **To disconnect the system from the power supply completely, remove the AC power plug from the wall socket.**

PREPARATION

Rear Connections

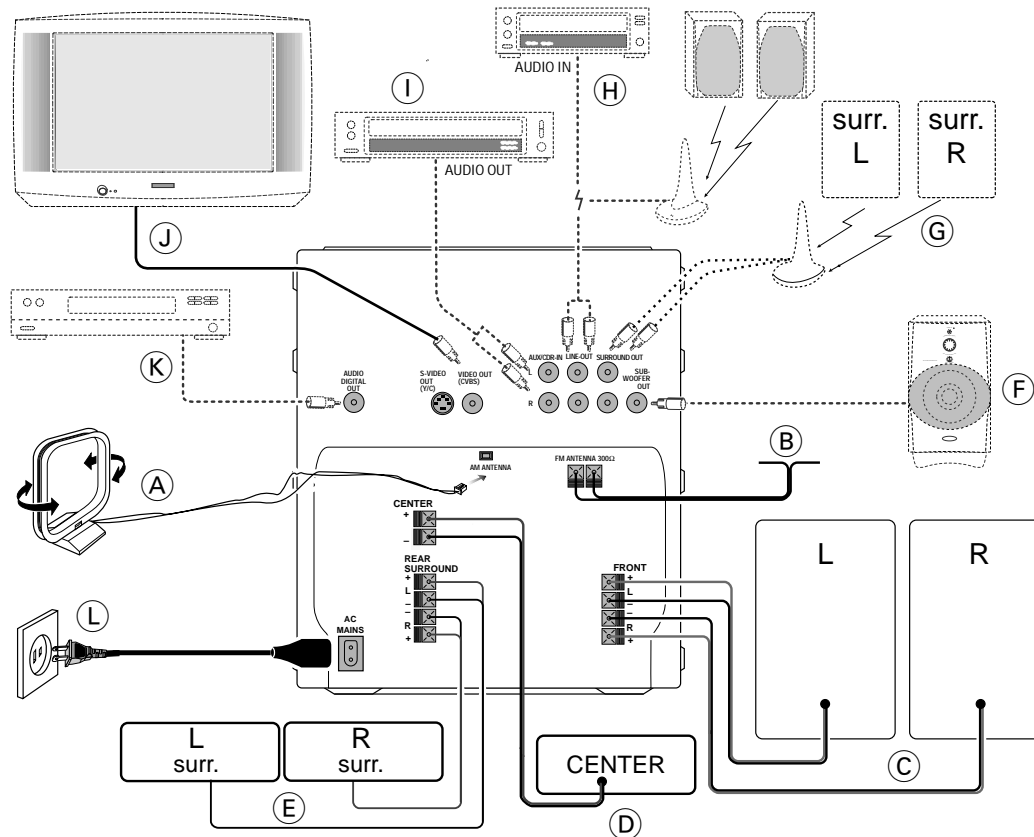

(A) AM Loop Antenna Connection

Connect the supplied loop antenna to the AM ANTENNA terminal. Place the AM loop antenna far away from the system and adjust its position for the best reception.

(B) FM Wire Antenna Connection

Connect the supplied FM wire antenna to the FM ANTENNA 300 Ω terminal. Adjust the position of the FM antenna for the best reception.

Outdoor Antenna

For better FM stereo reception, connect an outdoor FM antenna to the FM ANTENNA 300 Ω terminal using a 300 Ω dipole wire.

English

9

PREPARATION

English

C Speakers Connection

- Connect the right speaker to Front terminal R, with the colored wire to + and the black wire to -.
- Connect the left speaker to Front terminal L, with the colored wire to + and the black wire to -.
- Clip the stripped portion of the speaker wire as shown.

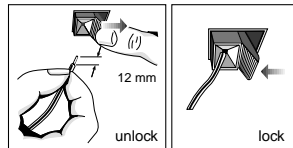

CAUTION:

- For optimal sound performance, it is recommended to use the supplied speakers.
- Do not connect more than one speaker to any one pair of + / - speaker terminals.
- Do not connect speakers with impedance lower than the speakers supplied. Please refer to the SPECIFICATIONS section of this manual.

D Center Speaker Connection

Connect the black (non-marked) wires to the black CENTER terminal and the blue (marked wires) to the blue CENTER terminal.

E Rear Surround Speakers' Connection

Connect the black (non-marked) wires to the black REAR SURROUND terminals and the colored (marked) wires to the grey REAR SURROUND terminals.

F Subwoofer Out Connection

Connect the optional active subwoofer to the SUBWOOFER OUT terminal. The subwoofer reproduces just the low bass sound effect (e.g. explosions, the rumble of spaceships, etc.). Be sure to follow the instructions supplied with the subwoofer.

G Wireless Surround Out Connection

You may connect the transmitter of the wireless rear speakers (not supplied) to the SURROUND OUT terminal. Be sure to follow the instructions supplied with the wireless surround speakers.

Note:

- Availability of a wireless transmitter and its peripherals are subjected to the approval of local authorities. Please check with the respective local safety or approving authority.

H Line Out Connection

(wireless ready)

You can connect the audio left and right LINE OUT terminals to a optional CD Recorder's ANALOG IN terminals. This allows you to record in an analog format.

You can also install additional optional front active speakers away from the system (e.g. in another room) to reduce the inconvenience of running long speaker wires across rooms. You can place as many remote speakers as you like provided they operate at the same radio frequency.

Connect the wireless radio frequency transmitter to the LINE OUT terminals. Place the active speakers at your preferred location. Be sure to follow the instructions supplied with the active speakers.

I Connecting other equipment to your system

You can connect the audio left and right OUT terminals of a TV, VCR, Laser Disc player, DVD player or CD Recorder to the AUX/CDR IN terminals at the rear of the system.

J Video Out Connection

Connect the VIDEO OUT (CVBS) terminal at the rear of the system to the TV or VCR VIDEO IN terminal for viewing or recording.

Note:

- You can also choose to connect the S-VIDEO OUT (Y/C) terminal at the rear of the system to the S-VIDEO IN of the TV using an optional S-VIDEO cable.

K Audio Digital Out Connection

You can record the digital sound from the CD/DVD, through this output, on any audio equipment with digital input (e.g. CD Recorder, Digital Audio Tape (DAT) deck, Digital to Analog Converter and Digital Signal Processor).

Connect one end of the cinch cable (not supplied) to the DIGITAL OUT socket and the other end to the audio equipment's digital input. When connecting the cinch cable, make sure it is fully inserted.

L AC Power Supply

After all other connections have been made, connect the AC power cord to the system and to the wall outlet.

Inserting batteries into the Remote Control

- Insert the batteries (Type R06 or AA) into the remote control as shown in the battery compartment.

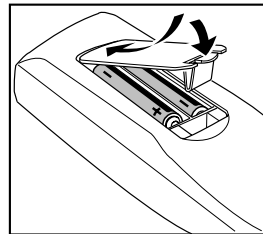

- To avoid damage from possible battery leakage, remove dead batteries or batteries that will not be used for a long time. For replacement, use type R06 or AA batteries.

CONTROLS

English

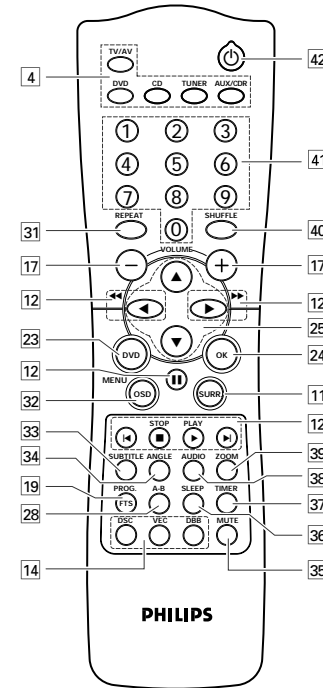
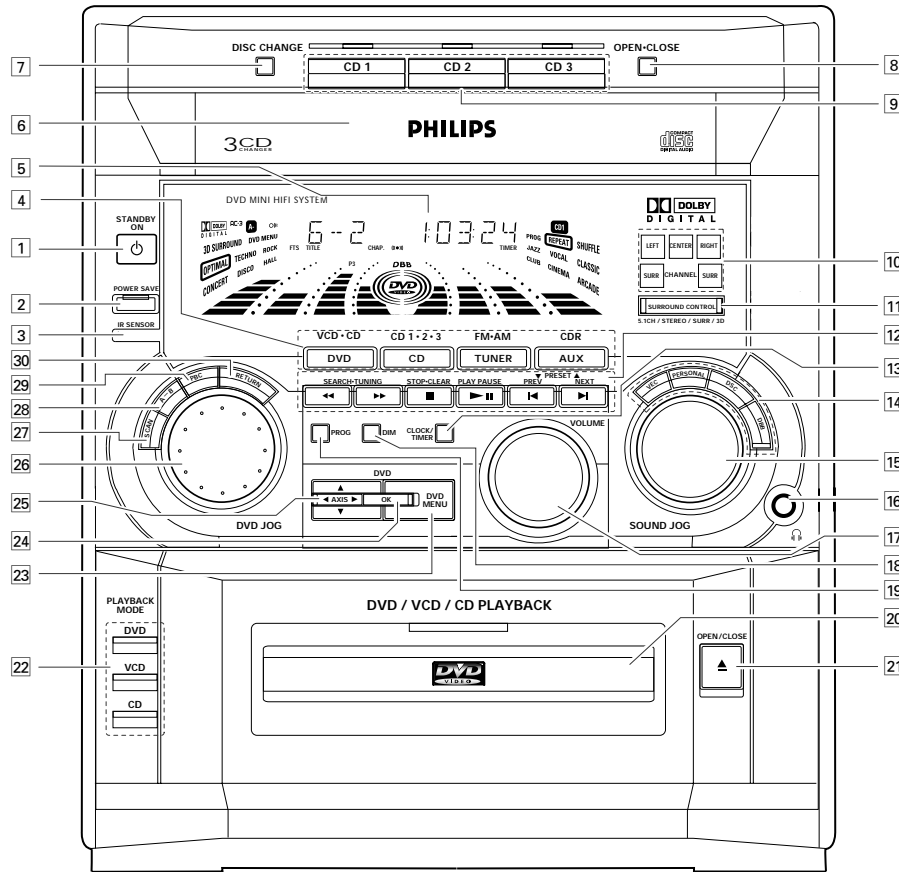

CONTROLS

English

Controls on the system and remote control

- 1** **STANDBY ON**
 - to switch the system on or to standby mode.
 - to use for EASY SET.
- 2** **POWER SAVE**
 - to switch the system to energy saving mode.
- 3** **IR SENSOR**
 - sensor for the infrared remote control.
- 4** **SOURCE** – to select the following:
 - DVD / (VCD•CD)**
 - to select DVD mode. When in DVD mode, you can play DVD, VCD or CD.
 - CD / (CD 1•2•3)**
 - to select CD mode. When CD playback is stopped, press to select disc tray 1, 2 or 3.
 - TUNER / (FM•AM)**
 - to select Tuner mode. When in tuner mode, press to select the waveband: FM or AM.
 - AUX / (CDR)**
 - to select sound from an external source (e.g. TV, VCR, Laser Disc player, DVD player or CD Recorder). When in AUX mode, press to select either AUX or CDR.

TV/AV *(only on the remote control)*

- to select TV or Video mode.
- 5** **DISPLAY SCREEN**
 - to view the current setting of the system.
- 6** **CD CAROUSEL TRAY**
- 7** **DISC CHANGE**
 - to change CD(s).
- 8** **OPEN•CLOSE**
 - to open or close the CD carousel tray.
- 9** **CD 1 / CD 2 / CD 3 (CD DIRECT PLAY)**
 - to select a CD tray for playback.
- 10** **SURROUND SOUND DISPLAY PANEL**
 - to view the selected Surround setting.
- 11** **SURROUND CONTROL (SURR)**
 - to select Multichannel Sound, Stereo, Surround or 3D Sound mode *(in DVD mode only)*.
- 12** **MODE SELECTION SEARCH•TUNING ◀◀ ▶▶ (◀ ▶)**
 - for DVD/VCD/CD
 - to search backward/forward *(except for CD playback in DVD mode)*.
 - for TUNER
 - to tune to a lower or higher radio frequency.
 - for CLOCK *(on the system only)*
 - to set the hour.

for TVVOL.

- to adjust the TV volume if the remote operates your TV.

STOP•CLEAR ■

- for DVD/VCD/CD
 - to stop playback *(in DVD mode only)*.
- for CD
 - to stop playback or to clear a program *(in CD mode only)*.
- for TUNER
 - to stop programming.
- for DEMO *(on the system only)*
 - to start or stop demonstration mode.

PLAY PAUSE ▶ II

- for DVD/VCD/CD
 - to start or interrupt playback.
 - for DVD/VCD
 - to watch a still picture.
- ◀ PREV / NEXT ▶ (PRESET)**

- for DVD/VCD/CD
 - to skip to the beginning of the current, previous, or next title or track.
- for VCD only
 - to select next or previous MENU *(for VCD with PBC on)*.
 - to select next or previous VCD track during playback *(for VCD with PBC off)*.
- for TUNER
 - to select a preset radio station in memory.

for CLOCK *(on the system only)*

- to set the minute.

13 **CLOCK/TIMER**

- to view the clock, set the clock or set the timer.

14 **SOUND CONTROL**

- to select the desired sound feature: VEC, PERSONAL, DSC or DBB.

15 **SOUND JOG** – to select the desired sound effect of VEC/ PERSONAL/DSC/DBB setting. You must select the respective sound feature first.

VEC

- to select the desired Virtual Environment Control effect : HALL, CLUB, DISCO, CINEMA, CONCERT or ARCADE.

PERSONAL

- to select up to 6 personal preferred Spectrum Analyzer settings : PERSONAL 1-6.

DSC

- to select the desired Digital Sound Control effect : OPTIMAL, CLASSIC, TECHNO, VOCAL, ROCK or JAZZ.

DBB

- to select a Dynamic Bass Boost level : BEAT, PUNCH or BLAST.

16 **🔊**

- to connect headphones.

17 **VOLUME**

- to increase or decrease the volume.

CONTROLS

English

- 18 DIM**
– to select brightness for the display screen : DIM 1, DIM 2, DIM 3 or DIM OFF.
- 19 PROGram (FTS - Favorite track selection)**
for DVD/VCD/CD
– to program disc tracks.
for TUNER
– to program preset radio stations.
for CLOCK (*on the system only*)
– to select 12 or 24 hour in clock setting mode.
- 20 DVD-VIDEO DISC TRAY**
21 OPEN/CLOSE ▲
– to open or close the DVD-VIDEO disc tray.
- 22 PLAYBACK MODE**
– to view the selected playback mode : DVD,VCD or CD.
- 23 DVD MENU**
– to access the DVD disc menu.
- 24 OK**
– to confirm the selection.
- 25 AXIS (◀▶▲▼)**
– to select the direction of cursor movement : up/down or left/right. (*on the remote control only*)
– to select movement of cursor: left, right, up or down.
- 26 DVD JOG**
– to move the cursor up/down or left/right. You must select the AXIS movement direction first.
- 27 SCAN**
for DVD
– to playback the first 10 seconds of each chapter within a title.
for VCD/CD
– to playback the first 10 seconds of each track.
- 28 A - B (*in DVD mode only*)**
– to playback a certain scene or passage of a disc repeatedly.
– to repeat playback a Chapter/Index, Title/Track or Disc.
- 29 PBC (PLAYBACK CONTROL)**
– to switch on or off PBC mode (*for VCD version 2.0 only*).
- 30 RETURN**
– to return to the previous MENU level during playback.
- 31 REPEAT (*in CD mode only*)**
– to repeat a disc track, a disc, or all available discs.
- 32 OSD MENU (ON SCREEN DISPLAY)**
– to switch on or off the on screen display on the TV screen.
- 33 SUBTITLE**
– to select different subtitle languages available in the DVD disc.
- 34 ANGLE**
– to select a camera angle available in the DVD disc.
- 35 MUTE**
– to switch off the sound temporarily.
- 36 SLEEP**
– to switch the system to standby mode at a selected time.
- 37 TIMER**
– to switch on or off the timer.
- 38 AUDIO**
– to select different audio languages available in the DVD disc.
- 39 ZOOM**
– to enlarge a still picture on the TV screen.
- 40 SHUFFLE**
– to play all the available discs and their tracks in random order.
- 41 DIGIT 0 – 9**
(*numbers consisting more than two figures must be keyed in within two seconds.*)
for DVD/VCD/CD
– to key in a disc title or track for playback or programming.
for VCD with PBC on only
– to select a track.
for TUNER
– to key in a preset radio station.
- 42** 
– to switch the system to standby mode.

Notes for remote control:

- **First select the source you wish to control by pressing one of the source select keys on the remote control (e.g. DVD,TUNER, etc.).**
- **Then select the desired function (▶, ◀, ▲, ▼, etc.).**

OPERATING THE SYSTEM

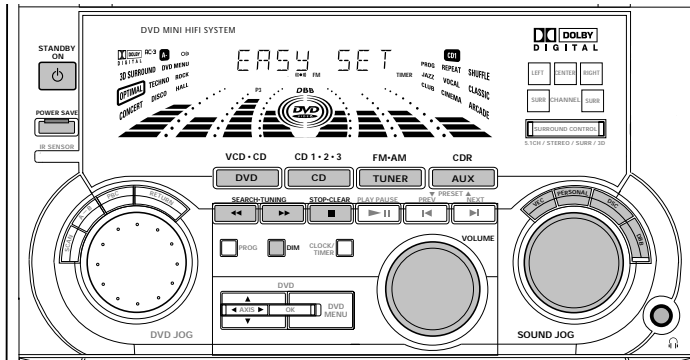

Important:
Before you operate the system, complete the preparation procedures.

Demonstration mode

The system has a demonstration mode that shows the various features offered by the system. **When the system is switched on for the first time, the demonstration mode will start automatically.**

Notes:

- During the demonstration, if you press any source (or standby-on) button, the system will switch to the respective mode (or standby).

- When the system is switched to standby or power save mode, the demonstration will resume five seconds later.

To stop the demonstration mode

- Press and hold **■** (on the system only) for **five seconds** when the system is in demonstration mode.
 - The demonstration will stop.
 - "DEMO OFF" will be displayed.
 - The system will switch to standby mode.

Notes:

- When the system is switched on from the main power outlet, the CD carousel tray may open and close again to initialize the set.
- Even though the AC power cord is removed from and reconnected to the wall socket, the demonstration will remain off until it is switched on again.

To start the demonstration mode

- Press and hold **■** (on the system only) for **five seconds** when the system is in standby mode.
 - The demonstration will begin.

Easy Set

EASY SET allows you to store all available radio stations automatically.

- Press and hold **STANDBY ON** (on the system only) for **five seconds** when the system is in standby or demonstration mode.
 - "EASY SET" will be displayed, and followed by "TUNER" and then "AUTO".
 - EASY SET will search for all radio stations on FM band and then search for radio stations on AM band.
 - All available radio stations with sufficient signal strength will be stored. Up to 40 presets may be stored.

Notes:

- EASY SET will start with the FM band, if there are still presets available, the system will continue to store the AM band.
- When EASY SET is used, all previously stored radio stations will be replaced.
- The last preset radio station will appear on the display when EASY SET is completed.

Switching the system ON

- Press **DVD, CD, TUNER** or **AUX**.

You can also switch on the system by pressing any one of the CD DIRECT PLAY buttons.

Switching the system to standby mode

- Press **STANDBY ON** or **⏻** on the remote control.
 - The system will switch to standby mode.

English

OPERATING THE SYSTEM

English

Switching the system to power save mode (when the Demonstration is stopped)

- Press **POWER SAVE** to switch to energy saving mode (< 2 watts).
→ "LOW POWER STANDBY ON" will be displayed, after which the display screen goes blank.
→ The low power STANDBY ON LED will be lit.

Note:

- if the demonstration mode has not been disabled, it will resume five seconds later.

Selecting the Source

- Press the desired source selection button: **DVD, CD, TUNER** or **AUX**.
→ The display indicates the selected source.

Note:

- For an external source, make sure you have connected the audio left and right OUT terminals of the external equipment (TV, VCR, Laser Disc player, DVD player or CD Recorder) to the AUX/CDR IN terminals.

Dim mode

You can select the desired brightness for the display.

- Press **DIM** to select DIM 1, DIM 2, DIM 3 or DIM OFF display mode.
→ The **DIM** appears on the display.
→ "DIM 1", "DIM 2", "DIM 3" or "DIM OFF" will be displayed depending on the mode selected.

DIM OFF - normal brightness with Spectrum Analyzer On



DIM 1 - normal brightness with Spectrum Analyzer Off



DIM 2 - half brightness with Spectrum Analyzer On



DIM 3 - half brightness with Spectrum Analyzer Off and all LEDs on the system will be switched off.



Volume Control

Adjust **VOLUME** to increase or decrease the sound level.

For Personal Listening

Connect the headphones plug to the socket at the front of the system. The speakers will be muted.

MUTE (on remote control only)

This feature allows you to temporarily switch off the sound without switching off the system when you require a moment of silence.

- Press **MUTE** on the remote control to switch off the sound.
→ "MUTE" will be displayed.
- Press **MUTE** again on the remote control or increase the **VOLUME** level to switch on the sound.

Sound Control

For Optimal sound listening, you can only select one of the following sound controls at a time : **VEC, PERSONAL** or **DSC**.

VIRTUAL ENVIRONMENT CONTROL (VEC)

The VEC feature enables you to adjust the system to select a type of environment.

- Press to select the **VEC** feature.
- Adjust the **JOG** to select the desired VEC setting : **HALL, CLUB, DISCO, CINEMA, CONCERT** or **ARCADE**.
→ The selected environment is encircled.
→ "HALL, CLUB, DISCO, CINEMA, CONCERT" or "ARCADE" will be displayed.

PERSONAL SOUND

You can store up to 6 personal settings.

- Press to select the **PERSONAL** feature.
- Adjust the **JOG** to select the desired Personal setting.
→ The selected personal setting number will appear on the display.
→ If no name has been stored previously, "PERSONAL X" will be displayed. "X" is the setting number.

OPERATING THE SYSTEM

English

Personal Setting

You can adjust the personal setting to your desired level with the JOG control.

- 1 Press and hold **PERSONAL** for about **five seconds** to switch on the personal setting mode.
→ "SELECT PRESET NUMBER" will be displayed.
- 2 Adjust the **JOG** to select the desired preset number for personal setting and press **▶▶** to confirm the selection.
→ "ADAPT LOW FREQ LEVEL" will be displayed.
- 3 Adjust the **JOG** to select the desired Spectrum Analyzer band level for low frequency.
→ The level will increase or decrease between **+3** and **-3**.
- 4 Press **▶▶** to confirm the selection.
→ "ADAPT MID FREQ LEVEL" will be displayed, followed by "ADAPT HIGH FREQ LEVEL".
 - Repeat **step 3 - 4** to select the desired middle and high frequencies of the Spectrum Analyzer band levels.
- 5 You can edit the name for the personal setting.
→ The first character of the setting name will be flashing.

- 6 Adjust the **JOG** to select the desired letter, number or symbol.
→ "A to Z", "0 to 9" or "*", "-", "+, \, /, _".
- 7 Press **▶▶** to confirm the selection.
→ The next character for editing will be flashing.
 - Repeat **steps 6 - 7** to store up to 10 characters.
- 8 To store the setting, press **PERSONAL** again.
 - **Before storing the setting, you can press ◀◀ to retrace the steps.**
 - **To exit without storing the setting, press ■ .**

Notes:

- During personal setting, if no button is pressed within 90 seconds, the system will exit personal setting mode automatically.
- It is not possible to adjust the DBB level during personal setting, "USE JOG" will be displayed.

DIGITAL SOUND CONTROL (DSC)

The DSC feature enables you to adjust the system to suit your type of music.

- 1 Press to select the **DSC** feature.
- 2 Adjust the **JOG** to select the desired DSC setting : OPTIMAL, CLASSIC, TECHNO, VOCAL, ROCK or JAZZ.
→ The selected digital sound is encircled.
→ "OPTIMAL, CLASSIC, TECHNO, VOCAL, ROCK or JAZZ" will be displayed.

Note:

- For a neutral setting, select CLASSIC.

DYNAMIC BASS BOOST (DBB)

There are three DBB settings to enhance the bass response.

- 1 Press to select the **DBB** feature.
- 2 Adjust the **JOG** to select the desired DBB level : BEAT, PUNCH or BLAST.
→ The DBB LED will be lit.
→ "BEAT", "PUNCH" or "BLAST" will be displayed.

To switch off DBB

- 1 Press **DBB** briefly.
- 2 Adjust the **JOG** until "DBB OFF" is displayed.

Note:

- Some CDs might be recorded in high modulation, which causes a distortion at high volume. If this occurs, switch off DBB or reduce the volume.

Automatic DSC-DBB / VEC-DBB selection

The best DBB setting is generated automatically for each DSC or VEC selection. You can manually select the DBB setting that best suits your listening environment.

DVD-VIDEO

English

General Information

- Digital video discs provide perfect digital, studio-quality pictures; three dimensional digital; multi-channel audio; story sequences screened from your choice of camera angle; sound tracks in as many as eight languages; and up to 32 subtitles if available on disc.
- DVD-Video uses state-of-the-art MPEG2 data compression technology to register an entire movie on the single 5-inch disc. DVD's variable bitrate compression, running up to 9.8 Mbits/second, captures even the most complex pictures in their original quality.
- The crystal-clear digital pictures have a horizontal resolution of over 500 lines, with 720 pixels (picture elements) to each line. This resolution is more than double that of VHS, superior to Laser Disc, and entirely comparable with digital masters made in recording studios.
- In addition to the DVD-Video discs, you will be able to play all Video CDs and Audio CDs (including finalized CD Recordable and CD Rewritable).

DVD-Video

You will recognize DVD-Video discs by the logo shown at right.



Depending on the material on the disc (a movie, video clips, a drama series, etc.) the disc may have one or more Titles. Each Title may have one or more Chapters. To make playback easy and convenient, your player lets you select Titles and Chapters.

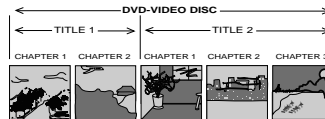

Video CD

You will recognize Video CDs by the logo shown at right. Depending on the material on the disc



(a movie, video clips, a drama series, etc.) the disc may have one or more tracks. Tracks may have one or more indexes, as indicated on the disc case. To make playback easy and convenient, your player lets you select tracks and indexes.

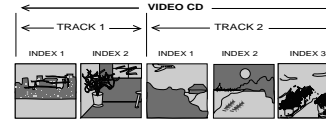

Audio CD

Audio CDs contain music tracks only.

You will recognize CDs by their logo which is shown at right. You can play them in conventional style through a stereo system, using the keys on the remote control and/or front panel, or via the TV using the On-Screen Display (OSD).



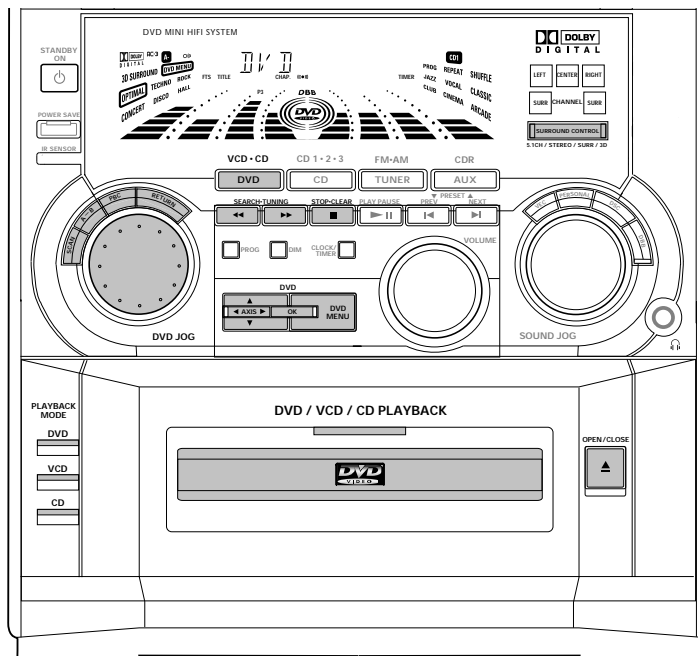

Surround Setup (for DVD only)

Multichannel sound

MULTICHANNEL SOUND gives you a completely new listening sensation. You will have the feeling of being in the middle of the action, because sound is coming from everywhere around you. Look for discs with the

Multichannel mark which indicates the material is encoded for multichannel surround sound.

Notice that DVDs do not always carry full multichannel surround. To be sure that a disc is multichannel encoded, consult your dealer.

Most ordinary DVDs can be replayed using surround sound settings with good results. If the reproduction is distorted in surround mode, switch to normal stereo mode.

The availability of the various surround sound modes described depends on the number of speakers used and the incoming sound information.

Setting up the Multichannel system

You must set up the system properly in order to enjoy the MULTICHANNEL to the fullest. First, connect the speakers.

5-Speaker Connection

- **Front speakers:** Connect the front speakers to the FRONT terminals.
- **Center speaker:** Connect the center speaker to the CENTER terminals.
- **Rear (surround) speakers:** Connect either the wired rear surround speakers or a pair of wireless rear speakers (not supplied) to the SURROUND OUT terminals.

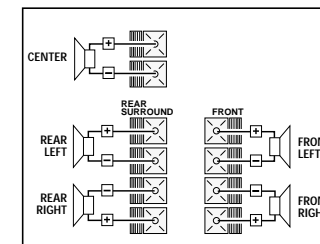

DVD-VIDEO

English

Positioning the Speakers

To get the best surround sound effect, place the speakers as follows.

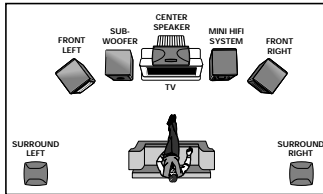

Front Left and Right Speakers

For the best sound, place the Left and Right speakers at an angle of approximately 45 degrees to the listener. If the speakers' magnetic field affects the television picture, increase the distance between the TV and the speakers.

Center Speaker

For the best sound, place the center speaker at the same height as the left and right speakers. Place the center speaker directly above or beneath the television.

Rear (surround) Speakers

The surround speakers should be placed at normal listening ear level or mounted on the wall at the back of the room. Most important, experiment when placing the surround speakers in order to obtain the best sound.

Switching Surround Control Sound

You can switch through the different surround modes. Note that the possibilities are related to speaker setup as defined.

- Press **SURROUND CONTROL** (or **SURR** on the remote control) to select : MULTICHANNEL, STEREO, SURROUND or 3D SURROUND mode.
→ The message "DOLBY DIGITAL AC3 5.1 CHANNEL, STEREO, SURROUND or 3D SURROUND" will be displayed.

Multichannel (5.1)

In addition to SURROUND, the surround mode used will be displayed. AC3 must be available on the source material.



Stereo

All sound is reproduced and played through the front left and right speakers. This enables standard stereo reproduction.



Surround

This surround mode enables normal surround sound reproduction with two speakers. Depending on the source material, Dolby Pro Logic or MPEG is reproduced (for connection to another Dolby Pro Logic decoder).

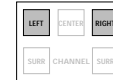

3D Surround

The sound of the rear channel is simulated by the front left and right speakers.

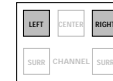

Note:

- Always refer to OSD when selecting surround control sound. When in stop mode, the player will not display the correct surround selection.

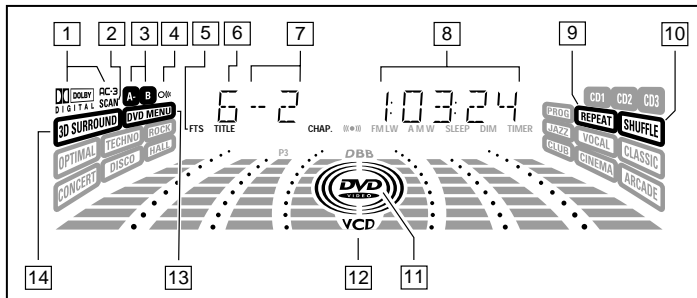

On Screen Display information

DISPLAY indications

- 1 AC-3
- AC-3 active
- 2 **SCAN**
- SCAN active
- 3 A-B
- Repeat A-B active
- 4 Remote control active (flashing)
- 5 **FTS**
- Favorite Track Selection active

- 6 DVD TITLE number
- 7 DVD CHAPTER number
- 8 TRACK/TOTAL TIME in hours, minutes and seconds
- 9 **REPEAT**
- REPEAT active
- 10 **SHUFFLE**
- SHUFFLE active
- 11 **DVD**
- DVD disc inserted
- 12 **VCD**
- (Video)CD disc inserted
- 13 **DVD MENU**
- DVD MENU active
- 14 **3D SURROUND**
- 3D SURROUND active

Menu bar/Status window

The status window displays the current status of the player and appears with the first part of the menu bar. (You must activate this in the Features Menu, see Personal Preferences for details).

General



Temporary feedback field icons

- Scan
- Repeat All
- Repeat Title
- Repeat Track
- Repeat Chapter
- Shuffle
- Shuffle Repeat
- Repeat A to end
- Repeat A-B

- Angle
- Child Lock On
- Child Safe
- Resume
- Action prohibited

Default screen

The default screen is displayed when the player is in STOP mode. It may contain a 'Status Window' and a 'Temporary Feedback Field'. This screen gives information concerning prohibited actions, playback modes, available angles, etc.



DVD-VIDEO

English

Preparation

NTSC/PAL Setting

Before viewing the DVD or VCD, ensure that the PAL or NTSC setting of the system matches your TV set.

- 1 Before connecting the system to the power source, press and hold **DVD** and **◀** (on the system only). While holding **DVD** and **◀**, plug in the power cord.
 - 2 After PAL or NTSC appears on the display, release **DVD** and **◀** at the same time.
 - The PAL or NTSC that appears on the display indicates the current setting.
- To change the setting, press **▶** within **three seconds**.
 - After selected, the set will automatically switch to the last NTSC or PAL setting everytime the DVD or VCD source is selected.

Turning On the power

- 1 Switch on the TV and select the video in channel to which you connected your DVD-Video player.
- 2 Press **DVD**.
 - The player display lights and the "Initial Setup" screen appears.

The 'Initial Setup' will only appear the **very first time** you turn on the player. In 'Initial Setup', you may have to set your personal preferences for some of the player's most relevant items. See 'Initial Setup'.

Initial Setup (not available for all versions)

Manual Operation

After switching on the player for the **very first time**, the 'Initial Setup Screen' will appear.

The menu for the first item to be set is displayed and the first option is highlighted.

- 1 Use the **▼** or **▲** keys to go through the options in the menu.
 - The icon of the selected option will be highlighted.
- 2 Press **OK** to confirm your selection and to go to the next menu.

Automatic setting

When settings will be taken from your TV or Home Cinema system, the message 'Auto configuring in process' will appear. Menus for which no settings are available will be displayed. They have to be set manually.

Notes:

- Preferences have to be set in the order in which the item menus will appear on the screen.
- The 'Initial Setup' screen will only disappear after the settings for the last item have been confirmed.
- If any keys other than **▼** or **▲** or **OK** are pressed, **✕** will appear on the screen.
- If the player is switched off while setting personal preferences, all preferences have to be set again after switching the player on again.

The following items may have to be set in (INITIAL SETUP):

Menu language

The On Screen Menus will be displayed in the language you choose. You can choose from different languages.

Audio language

The sound will be in the language you choose if it is available on the disc in play. If the language you select is not available, speech will revert to the first spoken language on the disc. You can choose from different languages.

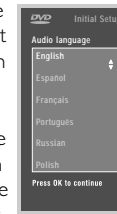

Subtitle language

The subtitles will be in the language you choose if it is available on the disc in play. If the language you select is not available, subtitles will revert to the first subtitle language on the disc. You can choose from different languages.

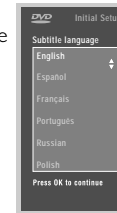

TV Shape

If you have a wide screen (16:9) TV, select 16:9.
 If you have a regular (4:3) TV, select 4:3.
 If you have a 4:3 TV, you can also select between:
 Letterbox for a 'wide-screen' picture with black bars top and bottom, or Pan Scan, for a full-height picture with the sides trimmed. If a disc has Pan Scan, the picture then moves (scans) horizontally to keep the main action on the screen.

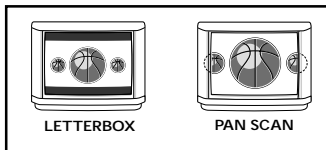

Country

Select your country. This also is used as input for the 'Parental Control' feature. (see 'Access Control')

Note:

- All these items may have to be set during 'Initial Setup'. After that, they can always be changed in the Personal Preferences Menu.

OSD Menu

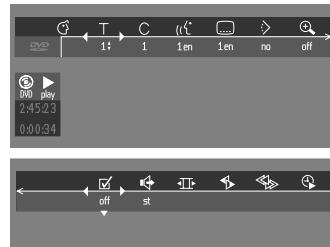

A number of operations can be carried out via the menu bar on the screen. The following functions are available via the menu bar:

- Personal preference
- Title/Track
- Chapter/Index
- Audio language
- Subtitle language
- Angle
- Zoom
- FTS-Video
- Sound
- Picture by Picture
- Slow motion
- Fast motion
- Time search

- The menu bar can be accessed by pressing any of the following keys on the remote control: **OSD MENU** and **AUDIO**.
- The various items can be selected by pressing the **OSD MENU** button, then the **▼** or **▲** keys or by pressing the relevant keys on the remote control.
- Pressing **OSD MENU** while the menu bar is displayed will clear the menu bar from the screen.
- When selecting an item in the menu bar; the selected item will be highlighted and the appropriate cursor keys to operate this item will be displayed below the icon.
- < or > indicates that more items are available at the left/right of the menu bar. Press **◀** or **▶** to select these items.

Personal preferences

You can set your personal preferences for some of the player features : PICTURE, SOUND, LANGUAGE and FEATURE.

General operation:

- 1 Press **OSD MENU** on the remote control.
- 2 Select in the menu bar.
 - The Personal Preferences menu appears.
- Use the **◀** or **▶** / **▲** or **▼** keys (or **DVD JOG**) to toggle through the menus, sub menus and submenu options.
 - When a menu item is selected, the cursor keys (on the remote control) to operate the item are displayed next to the item.
- 3 Press **OK** to confirm and return to the main menu.

Note:

- The DVD JOG can only move within one direction at a time, either up/down or left/right. Press **AXIS** on the system to select the movement direction before using DVD JOG.

DVD-VIDEO

English

The following items can be adapted:

Picture

- **TV Shape**
See 'Initial Setup'
- **Black level shift (NTSC only)**
Adapts the color dynamics to obtain richer contrasts. Select ON or OFF.

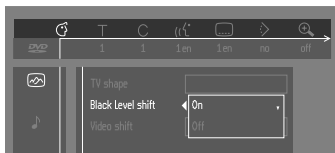

- **Video shift**

The factory centers the video on your screen. Use this setting to personalize the position of the picture on your TV by scrolling it to the left or right.

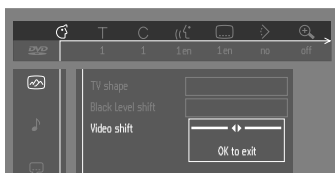

Sound

- **Digital output**

Factory setting: ALL. This means that coaxial output is switched on. If you are not connecting equipment with a digital input, change the setting to OFF.

If your equipment doesn't include a digital multi-channel decoder, set the digital output to PCM (Pulse Code Modulation). The coaxial output is switched on.

- **Analog output**

Select Stereo, Dolby Surround, 3D Sound or Multichannel.

Note:

- After selecting the desired Analog Output, if the message appeared on the TV OSD and the system display screen do not match with the setting, press SURROUND CONTROL (or SURR on the remote control) until the selected setting reached.

- **Night Mode**

Optimizes the dynamics of the sound with low volume playback.

- **Speaker**

Allows you to select speaker settings, volume balance and delay time and to test the speaker settings.

Speaker settings are only active on the Analog Multi-Channel Output. (see appendix - page 32).

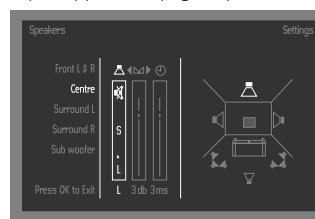

Language

Select the required Menu, Audio and Subtitle language. See 'Initial Setup'. Audio language and Subtitle language can also be adapted via the Menu bar on the screen.

Features

- **Access Control**

Access Control contains the following features:
Child Lock... When Child Lock is set to ON, a 4-digit code needs to be entered in order to play discs.

Parental control... Allows the conditional presentation of DVDs containing Parental Control information. (see 'Access Control')

- **Status Window**

Displays the current status of the player and is displayed with the menu bar. When disc playback is stopped, it is displayed with the 'Temporary Feedback Field' in the default screen.

Factory setting is ON. Select OFF to suppress display of the Status Window.

- **Low power Standby** (not applicable for this model)

- **PBC (Playback Control)**

The PBC can be set to ON or OFF (only applicable for Video CD playback).

Access control; child lock (DVD and VCD)



Activating/deactivating the child lock

- 1 When disc playback is stopped, select **ACCESS CONTROL** in the features menu using the ▼ or ▲ keys.
- 2 Enter a 4-digit code of your own choice.
- 3 Enter the code a second time.
- 4 Move to Child lock using the ▼ or ▲ keys.
- 5 Move to **LOCK/UNLOCK** icons using the ► key.
- 6 Select **LOCK** icon using the ▼ or ▲ keys.
- 7 Press **OK** or ◀ to confirm, then press ◀ again to exit the menu.
→ Now unauthorized discs will not be played unless the 4-digit code is entered.
- 8 Select **UNLOCK** icon to deactivate the Child Lock.

Note:

- Confirmation of the 4-digit code is necessary when the code is entered for the very first time, changed or cancelled.

Authorizing discs

- Insert the disc. See 'Loading disc'.
→ The 'child protect' screen will appear:

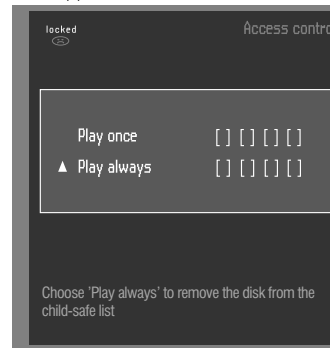

You will be asked to enter your secret code for 'Play Once' or 'Play Always'. If you select 'Play Once', the disc can be played as long as it is in the player and the player is ON. If you select 'Play Always', the disc will become child safe (authorized) and can always be played, even if the Child Lock is set to ON.

Notes

- The player memory maintains a list of 50 authorized ('Child safe') disc titles. A disc will be placed in the list when 'Play Always' is selected in the 'child protect' screen. Each time a 'child safe' disc is played, it will be placed on top of the list. When the list is full and a new disc is added, the last disc in the list will be removed from the list.
- Double sided DVDs may have a different ID for each side. In order to make the disc 'child safe', each side has to be authorized.
- Multi-volume VCDs may have a different ID for each volume. In order to make the complete set 'child safe', each volume has to be authorized.

Deauthorizing discs

- Insert the disc. See 'Loading disc'.
→ Playback starts automatically.
- Press ■ while ☺ is visible.
→ The ☺ will appear and the disc is now deauthorized.

Access control; Parental control (DVD-Video only)

Movies on DVDs may contain scenes not suitable for children. Therefore, disc may contain 'Parental Control' information which applies to the complete disc or to certain scenes on the disc. These scenes are rated from 1 to 8, and alternative, more suitable scenes are available on the disc. Ratings are country dependent. The 'Parental Control' feature allows you to prevent discs from being played by your children or to have certain discs played with alternative scenes.

Activating/Deactivating Parental Control

- 1 When disc playback is stopped, select **ACCESS CONTROL** in the Features menu using the ▼ or ▲ keys.
- 2 Enter your 4-digit code. If necessary, enter the code a second time.

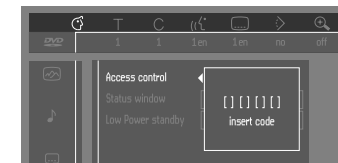

DVD-VIDEO

English

- 3 Move to Parental Control using the ▼ or ▲ keys.

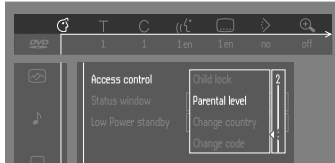

- 4 Move to VALUE ADJUSTMENT (1-8) using the ► key.
- 5 Then use the ▼ or ▲ keys or the digit keys (0-9) on the remote control to select a rating from 1 to 8 for the disc inserted.

Rating 0 (displayed as '- -):

Parental Control is not activated. The Disc will be played in full.

Ratings 1 to 8:

The disc contains scenes not suitable for children. If you set a rating for the player, all scenes with the same rating or lower will be played. Higher rated scenes will not be played unless an alternative is available on the disc. The alternative must have the same rating or a lower one. If no suitable alternative is found, play will stop and the 4-digit code has to be entered.

- 6 Press **OK** or ◀ to confirm, then press ◀ again to exit the menu.

Country

- 1 When disc playback is stopped, select **ACCESS CONTROL** in the Features menu using the ▼ or ▲ keys.
- 2 Enter the 4-digit code.
- 3 Move to **CHANGE COUNTRY** using the ▼ key.
- 4 Press the ► key.
- 5 Select a country using ▼ or ▲.
- 6 Press **OK** or ◀ to confirm, then press ◀ again to exit the menu.

Changing the 4-digit code

- 1 When disc playback is stopped, select **ACCESS CONTROL** in the Features menu using the ▼ or ▲ keys.
- 2 Enter the old code.
- 3 Move to **CHANGE CODE** using the ▼ key.
- 4 Press the ► key.
- 5 Enter the new 4-digit code.
- 6 Enter the code a second time and reconfirm by pressing **OK**.
- 7 Press ◀ to exit the menu.

If you forget your 4 digit code

- 1 Press ■ to exit 'Child Protect' screen.
- 2 Select **ACCESS CONTROL** in the Features menu using the ▲ and ▼ keys.
- 3 The 4-digit code can be cancelled by pressing ■ four times in the 'Access Control' dialog.

- 4 You can then enter a new code (twice!) as described above (Changing the 4 digit code).

Parental Control Disclaimer

This DVD player features the PARENTAL CONTROL system which is intended to activate when playing DVD discs made with certain software coding. This is according to technical standards adopted by the set maker and disc content industries.

Please note that the PARENTAL CONTROL system will not operate if the DVD disc does not have the appropriate software coding. Also note that at the time of release of this DVD player, certain aspects of the said technical standards had not been fully settled among the set maker and the disc content industries.

On this basis, Philips cannot warrant functioning of the PARENTAL CONTROL system and disclaims any liability of unintended watching of disc content.

If in doubt, please check the system with the disc before you allow children access or apply to the relevant disc publisher for more information.

Operation

Loading discs

- 1 Press **OPEN/CLOSE** ▲ on the front of the player. The disc tray opens.
- 2 Load your chosen disc in the tray, label side up (also when a double sided DVD is inserted). Make sure it is sitting properly in the correct recess.
- 3 Gently push the tray, or press **OPEN/CLOSE** ▲ to close the tray.
→ "READY" appears in the status window and on the player display, and playback starts automatically.

Notes:

- If 'Child Lock' is set to ON and the disc inserted is not in the 'child safe' list (not authorized), the 4-digit code must be entered and/or the disc must be authorized. (see 'Access Control')
- The DVD tray will open or close only when the system is in DVD mode.



DVD-VIDEO

English

Playing a DVD

Playing a title

- 1 After inserting the disc and closing the tray, playback starts automatically
 - The status window and the display show the type of disc loaded, as well as information about the disc's contents and playing time.
- The disc may invite you to select an item from a menu. If the selections are numbered, press the appropriate numerical key; if not, use the ◀ or ▶ / ▲ or ▼ keys to highlight your selection, then press **OK**.
 - The currently playing title and chapter number are shown in the menu bar and display.
 - The elapsed playing time is shown in the status window and the display.
- If required, you can use the **SURROUND CONTROL** (or **SURR** on the remote control) key to select Multichannel, Stereo, Surround or 3D-Surround. Play may stop at the end of the Title, and the player may return to the DVD menu. To go on to the next title, press ▶.
- 2 To stop play at any other time, press ■.
 - The default screen will appear, giving information about the current status of the player.

- You can RESUME play from the point at which you stopped play. Press ▶ (PLAY) on the remote control; when you see the RESUME icon ► on the screen, press ▶ (PLAY) again.
 - The RESUME feature applies not only to the disc in the player, but also to the last four discs you have played. Simply reload the disc, press ▶ (PLAY) on the remote control; when you see the RESUME icon ► on the screen, press ▶ (PLAY) again.

Note:

- Since it is usual for DVD movies to be released at different times in different regions of the world, all players have region codes. Discs can have an optional region code. If you load a disc of a different region code into your player, you will see the region code notice on the screen. The disc will not play and should be removed from the player.

Playing a VCD

Playing a disc

- 1 After inserting the disc and closing the tray, playback starts automatically.
 - The status window and the display show the type of disc loaded, as well as information about the disc's contents and playing time.
- The disc may invite you to select an item from a menu. If the selections are numbered.
 - The currently playing track number is shown in the menu bar and the display. The elapsed playing time is shown in the status window and the display.
- If required, you can use the **SURROUND CONTROL** (or **SURR** on the remote control) key to select Multichannel, Stereo, Surround or 3D-Surround.
- 2 To stop play at any time, press ■.
 - The default screen will then appear.
- You can RESUME play from the point at which you stopped play. Press ▶ (PLAY) on the remote control; when you see the RESUME icon ► on the screen, press ▶ (PLAY) again.

- The RESUME feature applies not only to the disc in the player, but also to the last four discs you have played. Simply reload the disc, press ▶ (PLAY) on the remote control; when you see the RESUME icon ► on the screen, press ▶ (PLAY) again.

Note:

- When PBC mode is switched on, RESUME play is not available.

General features

Note:

- Unless stated otherwise, all operations described are based on remote control operation. A number of operations can also be carried out via the menu bar on the screen. (see 'Menu bar operation')

Moving to another title/track

When a disc has more than one title or track (which you can see from both the menu bar and the display), you can move to another title as follows:

- 1 Select T (TITLE/TRACK) in the menu bar.
- 2 Press ► briefly during play to select the next title/track.



DVD-VIDEO

English

- Press **◀** briefly during play to return to the beginning of the current title/track. Press **◀** briefly again to step back to the previous title/track.
- 3 To exit, press **◀** or **▶**.

Moving to another chapter/index

When a title has more than one chapter or a track has more than one index (which you can see from the display and on the menu bar), move to another chapter/index as follows:

- 1 Select **C** (CHAPTER/INDEX) in the menu bar.
- 2 Press **▶** briefly during play to select the next chapter/index.
- Press **◀** briefly during play to return to the beginning of the current chapter/index. Press **◀** twice briefly to step back to the previous chapter/index.
- To go directly to any chapter or index, enter the number using the **digit keys (0-9)**.
- 3 To exit, press **◀** or **▶**.

Note:

- If the number has more than one digit, press the keys in rapid succession.

Still Picture and Frame-by-frame playback

- 1 Select **◀▶** (PICTURE BY PICTURE) in the menu bar.
- 2 Use the **▼** key to enter the picture by picture menu.
→ The player will go into PAUSE mode.
- 3 Use the cursor keys **◀** or **▶** to select the previous or next picture frame.
- 4 To exit Picture by picture mode, press **▶** (PLAY) or **▲** on the remote control.

Search

- 1 Select **◀▶** (FAST MOTION) in the menu bar.
- 2 Use the **▼** keys to enter the Fast Motion menu.
- 3 Use the **◀** or **▶** keys to select the required speed: **-32**, **-8** or **-4** (backward), or **+4**, **+8**, **+32** (forward).
- 4 Select **1** to play at normal speed again.
- 5 To exit Fast Motion mode, press **▶** (PLAY) or **▲** on the remote control.

To search forward or backward through different speeds, you can also hold down **◀◀** or **▶▶**.

Repeat A-B

To repeat a sequence in a title:

- Press Repeat **A-B** at your chosen starting point;
→ **A-** appears briefly on the screen.
- Press Repeat **A-B** again at your chosen end point;
→ **A-B** repeat appears briefly on the display, and the repeat sequence begins.
- To exit the sequence, press Repeat **A-B**.

Scan

Plays the first 10 seconds of each chapter/index on the disc.

- Press **SCAN**.
- To continue play at your chosen chapter/index, press **SCAN** again or press **▶** (PLAY) on the remote control.

Shuffle

DVDs

This shuffles the playing order of chapters within a title, if the title has more than one chapter:

- Press **SHUFFLE** during play.
→ **SHUFFLE** appears on the screen for about two seconds.
- To return to normal play, press **SHUFFLE** again.

VCDs

This shuffles the playing order of the tracks, if the disc has more than one track.

- Press **SHUFFLE** during play.
→ **SHUFFLE** appears on the screen for about two seconds.
- To return to normal play, press **SHUFFLE** again.

Time search

The Time Search function allows you to start playing at any chosen time on the disc.

- 1 Select **⏮** (TIME SEARCH) in the menu bar.
- 2 Press **▼**.
→ The player will go into PAUSE mode.
→ A time edit box appears on the screen, showing the elapsed playing time of the current disc.
- 3 Use the **digit keys (0-9)** to enter the required start time. Enter hours, minutes and seconds from right to left in the box.
→ Each time an item has been entered, the next item will be highlighted.
- 4 Press **OK** to confirm the start time.
→ The time edit box will disappear and play starts from the selected time position on the disc.

Zoom

The Zoom function allows you to enlarge the video image and to pan through the enlarged image.

- 1 press **ZOOM** key.
- 2 Press **▼** / **▲** to activate the ZOOM function and select the required zoom factor: **1.33** or **2** or **4**.
 - The player will go into PAUSE mode.
 - The selected zoom factor appears below the Zoom icon in the menu bar and 'Press OK to pan' appears below the menu bar.
 - The picture will change accordingly.
- 3 Press **OK** to confirm the selection.
 - The panning icons appear on the screen: **◀** or **▶** / **▲** or **▼** and **OK**.
- 4 Use the **◀** or **▶** / **▲** or **▼** keys to pan across the screen.
- 5 When **OK** is pressed only the zoomed picture will be shown on the screen.
- 6 If you wish to zoom at any moment, press **ZOOM** and select the required zoom factor as described above.
- 7 To exit Zoom mode, press **▶** (PLAY), **■** or **OSD MENU**.
 - If you press **▶** (PLAY), playback will resume.

FTS-Video

- The FTS-Video function allows you to store your favorite titles and chapters (DVD) and favorite tracks and indexes (VCD) for a particular disc in the player memory.
- Each FTS program can contain 20 items (titles, chapters).
- Each time an FTS program is played it will be placed on top of the list. When the list is full and a new program is added, the last program in the list will be removed from the list.
- The selections can be played at any time.
- For VCD, FTS program is not available whenever PBC mode is switched on.

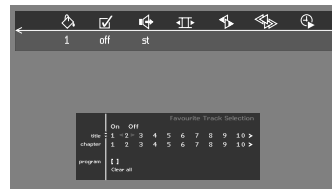
**Storing a FTS-Video Program**

- 1 In STOP mode, select FTS-Video in the menu bar.
- 2 Press **▼** to open the menu.
 - The FTS-Video menu appears.
- 3 Press **◀** or **▶** or **FTS** to select **ON** or **OFF**.

Storing titles/tracks

- 1 Press **▼** to select **TITLES/TRACK**.
- 2 Use **◀** or **▶** to select the required title/track.
- 3 Press **OK** if you wish to store the entire title/track.
 - The title/track number will be added to the list of selections.

Storing chapters/indexes

- 1 Press **▼** on the selected title/track number.
 - The title/track number will be marked and the highlight moves to the first available chapter/index number for this title/track.
- 2 Use **◀** or **▶** to select the required chapter/index number.
- 3 Press **OK** to confirm the selection.
 - The title-chapter/track-index selection will be added to the list of selections.
- 4 Press **OSD MENU** to exit the FTS-Video menu.

Erasing a FTS-Video Program

- 1 In STOP mode, select FTS-Video in the menu bar.
- 2 Use **▼** to select **PROGRAM**.
- 3 Use **◀** or **▶** to select the required selection number.
- 4 Press **OK** to erase the selection.
- 5 Press **OSD MENU** to exit.

If you wish to erase all selections:

- 1 In STOP mode, select FTS-Video in the menu bar.
- 2 Use **▼** to select **CLEAR ALL**.
- 3 Press **OK**.
 - All selections will now be erased.
- 4 Press **OSD MENU** to exit.

Special DVD-features**Checking the contents of DVD : Menus**

For titles and chapters, selection menus may be included on the disc. The DVD's menu feature allows you to make selections from these menus.

- Press the appropriate **digit keys (0-9)**; or use the **◀** or **▶** / **▲** or **▼** keys to highlight your selection, then press **OK**.

Title menus

- 1 Press **DVD MENU**.
 - If the current title has a menu, the menu will appear on the screen. If no menu is present in the title, the disc menu will be displayed.
- 2 The menu can list camera angles, spoken language and subtitle options, and chapters for the title.
- 3 To remove the title menu, press **DVD MENU** again.

DVD-VIDEO

English

Disc menu

- 1 Select **T** (TITLE/TRACK) in the menu bar; then press **DVD MENU**.
→ The disc menu is displayed.
 - To remove the disc menu, select **T** (TITLE/TRACK) in the menu bar; then press **DVD MENU** again.

Camera Angle

If the disc contains sequences recorded from different camera angles, the angle icon appears, showing the number of available angles and the angle being shown currently. You can then change the camera angle if you wish.

- 1 Press **ANGLE** on the remote control.
- 2 Use the **▼** or **▲** keys to select the required angle in the angle icon.
→ After a small delay, play changes to the selected angle. The angle icon remains displayed until multiple angles are no longer available.



Changing the audio language

- 1 Press **AUDIO** on the remote control.
- 2 Press **AUDIO** or **▼** / **▲** repeatedly to see the different languages.

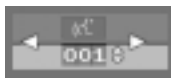

Subtitles

- 1 Press **SUBTITLE** on the remote control.
- 2 Press **SUBTITLE** or **▼** / **▲** repeatedly to see the different subtitles.

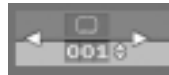

Special VCD-Features

Playback Control (PBC)

When PBC ON

- 1 Press **PBC** to switch on PBC mode.
- 2 Load a Video CD with PBC and press **▶** (PLAY).
→ The PBC menu appears on the TV screen.
 - Go through the menu with the keys indicated on the TV screen until your chosen passage starts to play. If a PBC menu consists of a list of titles, you can select a title directly.
- 3 Enter your choice with the **digit keys (0-9)**.
- 4 Press **RETURN** to go back to the previous menu.

When PBC OFF

- 1 Press **PBC** to switch off PBC mode.
- 2 Playback will resume when press **▶** (PLAY).
→ The PBC menu does not appear on the TV screen.

Notes:

- When PBC menu consists of more than one page, use **◀** or **▶** keys to go through the pages.
- When PBC mode is switched on, **RESUME play**, **Repeat A-B**, **SCAN** and **SHUFFLE** are not functional.

Playing an audio CD

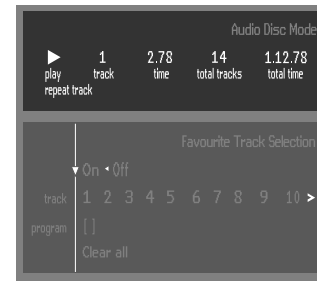

- 1 After loading the disc, playback starts automatically.
- If the TV is on, the Audio CD screen appears.
 - The number of tracks and the total playing time will be shown on the screen and on the player display.
 - During play, the current track number and its elapsed playing time will be shown on the screen and on the player display.

- 2 Playback will stop at the end of the disc.
 - To stop play at any other time, press **■**.

Pause

- Press **⏸** during play.
- To return to play, press **▶** (PLAY).

Moving to another track

- Press **▶** briefly during play to go to the next track.
- Press **◀** briefly during play to return to the beginning of the current track. Press **◀** briefly again to step back to the previous track.
- To go directly to any track, enter the track number using the **digit keys (0-9)**.

Shuffle

- Press **SHUFFLE** during play.
→ The order of the tracks is changed.
- To return to normal play, press **SHUFFLE** again.

Repeat A-B

To repeat a sequence:

- Press Repeat **A-B** at your chosen starting point;
 - **A-** appears briefly on the player display.
- Press Repeat **A-B** again at your chosen end point;
 - **A-B** appears briefly on the display, and the sequence begins to play repeatedly.
- To exit the sequence, press Repeat **A-B** again.

Scan

Plays the first 10 seconds of each track on the disc.

- Press **SCAN**.
- To continue play at your chosen track, press **SCAN** again or press **▶** (PLAY) .

FTS (Favorite Track Selection)

- The FTS feature allows you to store your favorite tracks for a particular disc in the player memory.
- Each FTS program can contain 20 tracks.
- Each time an FTS program is played it will be placed on top of the list. When the list is full and a new program is added, the last program in the list will be removed from the list.
- The selections can be played at any time.

**Storing an FTS Program**

- 1 Load a disc and stop playback.
- 2 Use **▼** to go to the list of available tracks.
- 3 Use **◀** or **▶** to select tracks from the list.

To go directly to any track, enter the track number using the **digit keys (0-9)**.

- 4 Store each track by pressing **OK**.

- The track numbers will be added to the list of selected tracks.
- The number of tracks and the playing time of the program will be shown on the screen and the player display.

When your FTS Program is complete, press **▶** (PLAY) to start play, or **■** to go back to Stop mode. In either case, the FTS Program will be automatically memorized.

Switching FTS ON/OFF

- 1 Use **▲** or **▼** to move to the top.
- 2 Use **◀** or **▶** to select either ON or OFF.

Erasing a track from an FTS-program

- 1 Use **▼** to go to the list of selected tracks in program.
- 2 Use **◀** or **▶** to select the track number you wish to erase.
- 3 Press **OK**.
 - The track number will be erased from the list of selected tracks.

Erasing the complete program

- Use **▼** to select **CLEAR ALL** and press **OK**.
 - The complete FTS program for the disc will be erased.

DVD-VIDEO

English

Appendix

6 Channel settings

Front speakers

- L (Large): When the front speakers can reproduce low frequency signals below 120Hz
- S (Small): When the front speakers cannot produce low frequency signals below 120Hz

Center speaker*

- L (Large): When the center speaker can reproduce low frequency signals below 120Hz
- S (Small): When the center speaker cannot produce low frequency signals below 120Hz
- Off: When the center speaker is not connected.

Surround speakers

- L (Large): When the surround speakers can reproduce low frequency signals below 120Hz
- S (Small): When the surround speakers cannot produce low frequency signals below 120Hz
- Off: When the surround speakers are not connected.

Subwoofer

- On: When you connect a subwoofer
- Off: When the subwoofer is not connected.

* You can use your TV as center speaker. When center speaker is turned on, the audio L/R as well as the audio from the scart will contain the center speaker audio.

Delay times

The DVD player is set to reproduce correctly synchronized Digital Surround Sound in a listening area where the surround speakers are about 150cm nearer to the listening position than the front speakers, and the center speaker is in line with the front speakers. To adjust for other listening area arrangements, certain delay times required.

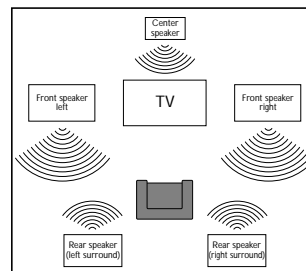

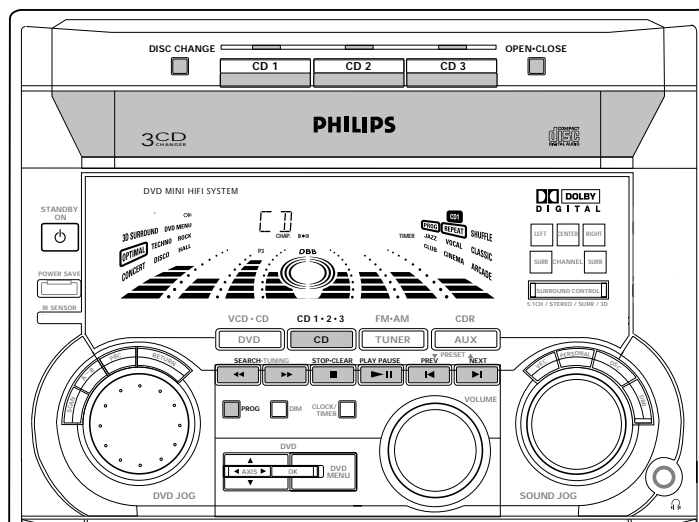
**Warning!**

- 1) This system is designed for conventional CDs. Do not use any accessories such as disc stabilizer rings or CD treatment sheets, etc., which may damage the CD mechanism.
- 2) Do not load more than one disc into each tray.
- 3) When the CD carousel tray is loaded with CDs, do not turn over or shake the system. This may jam the changer.

You may load three discs in the CD carousel tray for continuous playback without interruption.

Discs for playback

This system can play all digital audio CD, finalized digital audio CD-Recordable and finalized digital audio CD-Rewritable format discs.

**Loading the CD Changer**

- 1 Press **CD** to select CD mode.
- 2 Press **OPEN•CLOSE**.
→ The CD carousel tray slides out.
- 3 Load a CD with the printed side up in the right tray.
 - You can load another disc in the left tray.
 - To load the third disc, press the **DISC CHANGE** button.
→ The CD carousel will rotate until the empty tray is ready for loading.
- 4 Press **OPEN•CLOSE** to close the CD carousel tray.
→ The total number of tracks and the playing time of the selected disc appear on the display.

Note:

- To ensure good system performance, wait until the CD changer completely reads the disc(s) before proceeding.

CD Direct Play

- You can play a CD directly by pressing the **CD 1**, **CD 2** or **CD 3** button. The CD player will stop at the end of playback of the selected disc.
→ A lit button indicates that a disc is loaded in the disc tray.
→ The selected disc is encircled.

Playing a CD

- 1 Press **▶ (PLAY)** to start playback.
→ The disc tray, track number and elapsed playing time of the current track appear on the display.
 - To interrupt playback, press **⏏**.
→ The playing time flashes.
 - To resume playback, press **▶ (PLAY)** again.
- 2 To stop playback, press **■**.

Notes:

- All the available discs will play once, then stop.
- When the CD has stopped playing, the system will switch to standby mode after 30 minutes if no button is pressed.

CD

English

Disc Change

You can change the outer two discs while the third inner disc is stopped or is playing.

- 1 Press **DISC CHANGE**.
→ The CD carousel tray slides out.
- 2 Replace the discs in the left and right disc trays.
 - If you wish to change the inner disc during playback, press **DISC CHANGE** again.
→ "DISC CHANGE" will be displayed.
→ The CD will stop playing.
→ The CD carousel tray will close to retrieve the inner CD then open again with the inner CD accessible.
- 3 Press **OPEN•CLOSE** to close the CD carousel tray.

Selecting a desired track

Selecting a desired track when playback is stopped

- 1 Press **◀** or **▶** (or **Digit 0-9** on the remote control) until the desired track appears on the display.
- 2 Press **▶** (PLAY) to start playback.
→ The selected track number and elapsed playing time appear on the display.

Selecting a desired track during playback

- Press **◀** or **▶** (or **Digit 0-9** on the remote control) until the desired track appears on the display.
→ The selected track number and elapsed playing time appear on the display.
- If you press **◀** once it will skip to the beginning of the current track and play the track again.

Note:

- Pressing **◀** during shuffling can only skip to the beginning of the current track.

Searching for a particular passage during playback

- Press and hold **◀◀** or **▶▶** until the desired passage is located.
→ The volume will be reduced.
- Play returns to normal when **◀◀** or **▶▶** is released.

Programming Tracks

Programming tracks of a loaded CD is possible when playback is stopped. The display will indicate the total tracks stored in the program. Up to 40 tracks can be stored in the memory in any order. When 40 tracks are stored and you attempt to store another track, the display will show "PROGRAM FULL".

- 1 Load the desired discs in the disc trays.
- 2 Press **PROG** to start programming.
→ The **PROG** starts flashing.
- 3 Press the **CD** (CD 1•2•3) or **CD 1/2/3** button to select the disc.
- 4 Press **◀** or **▶** (or **Digit 0-9** on the remote control) to select the desired track.
- 5 Press **PROG** to store the track.
 - Repeat steps **3** to **5** to store other discs and tracks.
- 6 Press **■** once to end programming.
→ The total number of tracks programmed and total playing time appear on the display.

Notes:

- If the total playing time is more than "99:59" or if one of the programmed tracks has a number greater than 30, then "- : - : -" appears on the display instead of the total playing time.

- If the system is reading the disc, programming is not possible, "READING" will be displayed and followed by "DISC x" "x" is the current read disc number.
- During programming, if no button is pressed within 20 seconds, the system will exit program mode automatically.

Reviewing the program

Reviewing of the program is possible only when playback is stopped.

- 1 Press **◀** or **▶** repeatedly to review the programmed tracks.
- 2 Press **■** once to exit review mode.

Playing the program

- 1 Press **▶** (PLAY) to start program playback.
→ "PLAY PROGRAM" will be displayed.
→ The track number and elapsed playing time of the current track will appear on the display.
 - If you press **REPEAT** during program playback, the current track or all programmed tracks will be played repeatedly.
→ "TRACK" or "PROGRAM" will be displayed.
→ The **REPEAT** and **PROG** appear on the display.
- 2 Press **■** to stop program playback.



CD

English

Notes:

- If you press any of the CD DIRECT PLAY buttons, the system will play the selected disc or track and the stored program will be ignored temporarily. The PROG display also will disappear temporarily from the display. It will reappear when playback of the selected disc ends.
- REPEAT DISC mode is not available when program playback begins.

Erasing the program (when playback is stopped)

- Press ■ .
→ "PROGRAM CLEAR" will be displayed.

Note:

- The program will be erased when the system is disconnected from the power supply or when the CD carousel tray is opened.

Shuffle (only on remote control)

In shuffle mode, the system plays all the available discs and their tracks in random order. Shuffle may be used also when tracks are programmed.

To shuffle all the discs and tracks

- 1 Press **SHUFFLE**.
→ "SHUFFLE" will be displayed.
→ The **SHUFFLE**, the disc and the track selected at random appear on the display.
 - The discs and the tracks will be played in random order until you press ■ .
 - If you press **REPEAT** during shuffling, the current track or all available discs will be played repeatedly.
→ "TRACK" or "ALL DISC" will be displayed.
→ The **REPEAT** and **SHUFFLE** appear on the display.
- 2 Press **SHUFFLE** again to resume normal playback.
→ The **SHUFFLE** disappears from the display.

Note:

- REPEAT DISC mode is not available when shuffle is selected.

Repeat (only on remote control)

You can play the current track, a disc or all available discs repeatedly.

- 1 Press **REPEAT** on the remote control to select the various repeat modes.
→ "TRACK", "DISC", "ALL DISC" or "OFF" will be displayed.
→ The **REPEAT** appears on the display.
 - The selected track, selected disc or all available discs will now be played repeatedly until you press ■ .
- 2 Press **REPEAT** until the "OFF" mode is displayed to resume normal playback.
→ The **REPEAT** disappears from the display.

Notes:

- REPEAT DISC mode is not available during program play or shuffle mode.
- You can also repeat shuffling a program.
→ "TRACK" or "PROGRAM" will be displayed.
→ The **REPEAT**, **PROG** and **SHUFFLE** appear on the display.



TUNER

English

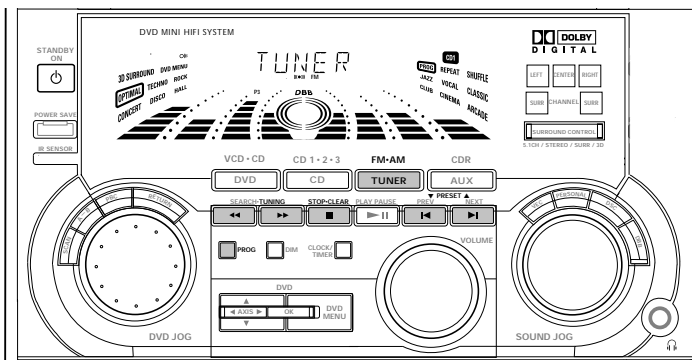

Note:
– For 'EASY SET' feature, please refer to page 15.

Tuning to radio stations

- 1 Press **TUNER** (FM•AM) to select TUNER mode.
→ "TUNER" will be displayed.
A few seconds later, the current radio frequency will be displayed.
- 2 Press **TUNER** (FM•AM) again to select the desired waveband : FM or AM.
- 3 Press **◀◀** or **▶▶** for more than one second, then release.
→ The display will show "SEARCH" until a radio station with sufficient signal strength is found.

- Repeat this procedure until the desired radio station is reached.
- To tune to a weak radio station, briefly press **◀◀** or **▶▶** repeatedly until the display shows the desired frequency and/or when the best reception has been obtained.

Storing Preset Stations

You can store up to 40 radio stations in the memory. When a preset radio station is selected, the preset number appears next to the frequency on the display.

Automatic programming

- 1 Press **TUNER** (FM•AM).
- 2 Press **PROG** for more than one second.
 - The **PROG** starts flashing and "AUTO" will be displayed.
 - The system will search for every available radio station in the FM waveband first, then search the AM waveband.
 - All available radio stations will be stored automatically. The frequency and preset number will be displayed briefly.
 - The system will stop searching when all the available radio stations are stored or when the memory for 40 preset radio stations is used.
 - The system will remain tuned to the last stored preset radio station.

Notes:

- You can cancel the automatic programming by pressing **PROG** or **■** (on the system only).

- If you want to reserve a section of preset numbers, for example preset numbers 1 to 9, select preset 10 before starting automatic programming, only the preset numbers 10 to 40 will be programmed.

Manual programming

- 1 Press **TUNER** (FM•AM).
- 2 Press **TUNER** (FM•AM) again to select the desired waveband : FM or AM.
- 3 Press **PROG** for less than one second.
 - The **PROG** starts flashing.
 - The next available preset number will be displayed for selection.
- 4 Press **◀◀** or **▶▶** to tune to the desired frequency.
 - If you wish to store the radio station to another preset number, press **◀** or **▶** (or **Digit 0-9** on the remote control) to select the desired preset number.
- 5 Press **PROG** again.
 - The **PROG** disappears and the radio station will be stored.
 - Repeat **steps 3 – 5** to store other preset radio stations.

TUNER

Notes:

- When 40 radio stations are stored and you attempt to store another radio station, the display will show "PROGRAM FULL". If you want to change an existing preset number, repeat steps 3 - 5.
- You can cancel manual programming by pressing **■** (on the system only).
- During programming, if no button is pressed within 20 seconds, the system will exit program mode automatically.

Tuning to Preset Radio Stations

- Press **◀** or **▶** (or *Digit 0-9* on the remote control) to select the desired preset number.
 - The preset number, radio frequency, and waveband appear on the display.

AUX/CDR

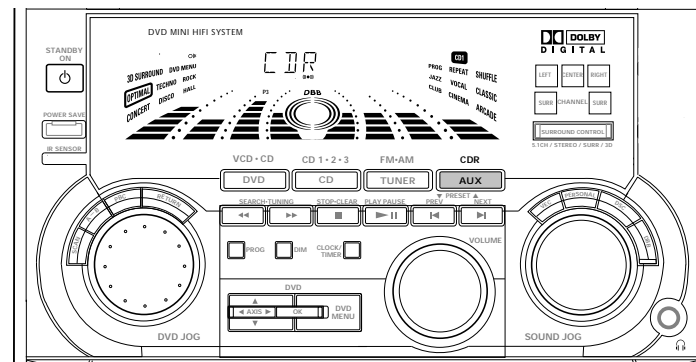

Selecting External Equipment

If you have connected the audio out terminals of the external equipment (TV, VCR, Laser Disc player, DVD player, or CD Recorder) to the AUX/CDR IN terminals, you can hear the enhanced sound from the system.

- 1 Press **AUX** (CDR) to select the CDR mode.
 - "CDR" will be displayed.
- 2 Press **AUX** (CDR) again to select external (normal AUX) mode.
 - "AUX" will be displayed.

Notes:

- There are two Auxiliary modes:
 - i. the normal AUX mode.
 - ii. the CDR mode, where the LINE OUT of this mini system is muted. You will not be able to record or listen to the sound from the LINE OUT.
- You are advised not to listen to and record from the same source simultaneously.
- All the sound control features (e.g. DSC, DBB, etc.) are available for selection.

English

CLOCK

English

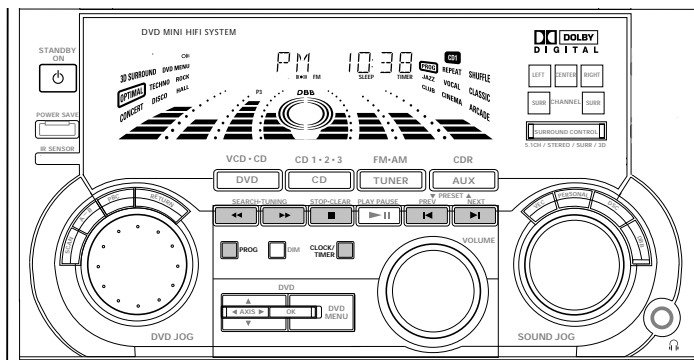

View Clock

You can view the clock (if it is set) if the system is in Standby mode or when any sound source is selected (CD, TUNER, etc.). The clock will be displayed for about seven seconds.

- Press **CLOCK/TIMER** briefly.
 - "PM 10:38 or 22:38" (the current time) will be displayed depending on whether you have selected 12- or 24-hour mode.
 - "----:--" will be displayed if the clock is not set.

Note:

- When the system goes into low power standby mode, the clock setting will not be displayed.

38

TIMER

- 5 Press **CLOCK/TIMER** again to store the setting.
 - The clock starts.
- To exit without storing the setting, press **■** on the system.

Notes:

- During clock setting, if no button is pressed within 90 seconds, the system will exit clock setting mode automatically.
- When a power interruption occurs, the clock setting is erased.

Timer Setting

- The system can switch on to CD or TUNER mode automatically at a preset time. It can serve as an alarm to wake you up.
- Before setting the timer, make sure the clock is set correctly.
- The timer will always be switched on once it is set.
- **The volume of the timer will increase from the minimum level until the volume level before the set is switched to standby mode.**

- 1 Press and hold **CLOCK/TIMER** for more than **two seconds** to select timer mode.
 - "PM 12:00" or "00:00" or the last timer setting starts flashing depending on whether you have selected 12- or 24-hour mode.
 - The **TIMER** starts flashing.
 - The selected source is lit while other available sources are flashing.
- 2 Press **CD** or **TUNER** to select the desired source.
 - Before selecting CD, make sure a CD is loaded in the CD tray.
- 3 Press **◀** or **▶** on the system to set the hour for the timer to start.
- 4 Press **◀** or **▶** on the system to set the minute for the timer to start.

TIMER

- 5 Press **CLOCK/TIMER** to store the start time.
 - The timer is now set.
 - The **TIMER** remains on the display.
- At the preset time, the timer will be activated.
 - The selected source will be played.

Notes:

- During timer setting, if no button is pressed within 90 seconds, the system will exit timer setting mode automatically.
- If the source selected is **TUNER**, the last tuned frequency will be switched on.
- If the source selected is **CD**, playback will begin with the first track of the selected disc or program. If the **CD** trays are empty, **TUNER** will be selected instead.

To switch off the **TIMER**

- Press **TIMER** on the remote control.
 - The timer is now switched off.
 - The display will show "CANCEL" and the **TIMER** disappears.

To start the **TIMER** again (for the same preset time and source)

- Press **TIMER** on the remote control.
 - The timer is now on.
 - The **TIMER** appears on the display.

SLEEP TIMER

Sleep (only on remote control)

This feature allows you to select a length of time after which the system will switch to the standby mode automatically.

- 1 Press **SLEEP** on the remote control repeatedly to select a period of time.
 - The selections are as follows (time in minutes):
60 → 45 → 30 → 15 → OFF → 60 ...
 - "SLEEP XX" or "OFF" will be displayed. "XX" is the time in minutes.
- 2 When you reach the desired length of time, stop pressing the **SLEEP** button.
 - After this amount of time passes, the system will switch to the standby mode.

To switch off the Sleep Timer

- Press **SLEEP** repeatedly until "OFF" is displayed, or press the **STANDBY ON** button.

English

SPECIFICATIONS

English

Specifications

AMPLIFIER

Output power	
Left/Right Channel	2 x 50 W FTC ⁽¹⁾
Center Channel	50 W, 6 Ω
Surround Channel	2 x 50 W, 6 Ω
Signal-to-noise ratio	≥ 75 dBA (IEC)
Frequency response	20 – 20000 Hz, ± 3 dB
Input sensitivity	
AUX In / CDR In	500 mV / 1V
Output	
Speakers	$\geq 6 \Omega$
Center Speaker	$\geq 6 \Omega$
Surround Speakers	$\geq 6 \Omega$
Headphones	32 Ω – 1000 Ω
Subwoofer Out	1.5 V ± 2 dB, $> 22000 \Omega$
Line Out	1 V ± 2 dB, $> 22000 \Omega$
Digital Out	1 coaxial
..... IEC 958 for CDDA / LPCM	
..... IEC1937 for MPEG1, MPEG2 and AC-3	
Surround Out (<i>wireless</i>)	750 mV
(¹)	(6 Ω , 60 Hz – 12.5 kHz, 10% THD)

DVD-VIDEO PLAYER

Playback System	DVD-Video/ Video CD / CD (CD-R & CD-RW)
Video	
DA converter	10 bits
Digital compression	MPEG 2 for DVD, SVCD / MPEG 1 for VCD
Video output	1 Vpp (75 Ω)
S-Video output	Y: 1 Vpp (75 Ω) C: 0.3 Vpp (75 Ω)

CD PLAYER

Number of programmable tracks	40
Frequency response	20 – 20000 Hz
Signal-to-noise ratio	≥ 76 dBA
Channel separation	≥ 79 dB (1 kHz)
Total harmonic distortion	$< 0.02\%$ (1 kHz)

TUNER

FM wave range	87.5 – 108 MHz
AM wave range	530 – 1700 kHz
Number of presets	40
Antenna	
FM	300 Ω dipole wire
AM	Loop antenna

SPEAKERS

System	Shielded 2-way; double port bass reflex
Impedance	6 Ω
Woofer	1 x 6.5"
Tweeter	1 x 2.5"
Dimensions (w x h x d)	9.45 x 12.20 x 12.40 (inch) 240 x 310 x 315 (mm)
Weight	8.47 pounds each 3.85 kg each

CENTER SPEAKER

System	shielded bass reflex
Impedance	6 Ω
Speaker Driver	1 x 3" full range
Dimensions (w x h x d)	9.06 x 5.12 x 6.10 (inch) 230 x 130 x 155 (mm)
Weight	2.86 pounds 1.3 kg

SURROUND SPEAKERS

System	closed satellite
Impedance	6 Ω
Speaker Driver	1 x 3" full range
Dimensions (w x h x d)	9.06 x 5.12 x 6.10 (inch) 230 x 130 x 155 (mm)
Weight	2.64 pounds each 1.2 kg each

GENERAL INFORMATION

Material/finish	Polystyrene/Metal
AC Power	120 V / 60 Hz
Power Consumption	
Active	280 W
Standby	< 22 W
Standby (energy saving mode)	< 2 W
Dimensions (w x h x d)	10.43 x 12.20 x 15.35 (inch) 265 x 310 x 390 (mm)
Weight (without speakers)	23.76 pounds 10.8 kg

Subject to modification

MAINTENANCE

Maintenance

Cleaning the Cabinet

- Use a soft cloth slightly moistened with a mild detergent solution. Do not use a solution containing alcohol, spirits, ammonia or abrasives.

Cleaning Discs

- When a disc becomes dirty, clean it with a cleaning cloth. Wipe the disc from the center out.
- Do not use solvents such as benzine, thinner, commercially available cleaners, or antistatic spray intended for analog records.



Cleaning the disc lens

- After prolonged use, dirt or dust may accumulate at the disc lens. To ensure good playback quality, clean the disc lens with Philips CD Lens Cleaner or any commercially available cleaner. Follow the instructions supplied with cleaner.

TROUBLESHOOTING

Warning! Under no circumstances should you try to repair the set yourself as this will invalidate the guarantee. Do not open the set as there is a risk of electric shock.

- If a fault occurs, check the points listed below before taking the system for repair.
- Should any problems persist after you have made these checks, consult your nearest dealer or service center.

DVD-VIDEO Player Operation

Distorted picture or no color with player menu.

- The disc format does not match your TV's video signal (PAL/NTSC).
→ *Replace a recommended disc (refer to the instruction of this manual).*
- The system setting is not correct.
→ *Make sure the NTSC/PAL setting at the player matches the video signal of your television (see NTSC/PAL setting).*
- Check the disc for fingerprints.
→ *Clean with a soft cloth, wiping from center to edge.*
- *Sometimes a small amount of picture distortion may appear. This is not malfunction.*

No return to start-up screen when disc is removed.

- Check to see if the program requires another disc to be loaded.
→ *Reload a disc.*
- *Reset by switching the player off, then on again.*

Player does not respond to all operating commands during playback.

- Operations are not permitted by the disc.
→ *Refer to the instruction of the disc.*

No audio at digital output.

- The digital connections are not properly connected or connected wrongly
→ *Check the digital connections.*
- Incorrect digital output settings.
→ *Check the settings menu to make sure the digital output is set to ALL or PCM.*
- *Check if the audio format of the selected audio language matches the receiver capabilities.*

No picture on TV screen.

- The video cable is not connected.
→ *Connect the cable between the system and TV.*

English

TROUBLESHOOTING

English

CD Player Operation

"NO DISC" is displayed.

- The disc is inserted upside down.
→ Place disc with printed side up.
- Moisture condensation at the lens.
→ Wait until lens has adjusted to normal room temperature.
- There is no disc in the CD tray.
→ Insert a disc.
- The disc is dirty, badly scratched or warped.
→ Clean or replace the disc.
- The disc lens is dirty or dusty.
→ See section under Maintenance (page 41).

"DISC NOT FINALIZED" is displayed.

- The CD-RW or CD-R disc is not properly recorded for use with a standard CD player.
→ Read the instruction booklet of your CD-Rewritable or CD-Recorder on how to finalize a recording.
- The CD is badly scratched or dirty.
→ Replace or clean CD.

Radio Reception

Poor radio reception.

- The signal is too weak.
→ Adjust the antenna.
- Connect an external antenna for better reception.
- The TV or VCR is too close to the stereo system.
→ Separate the stereo system from the TV or VCR.

General

System does not react when any button is pressed.

- Electrostatic discharge
→ Press **STANDBY ON** to switch the system off. Remove the AC power plug from the wall outlet, then reconnect the power plug and switch on the system again.

No or poor sound.

- Volume is not turned up.
→ Adjust **VOLUME**.
- The headphones are connected.
→ Disconnect the headphones.
- Speakers are not connected or are connected wrongly.
→ Check that the speakers are connected correctly.
- Make sure the stripped speaker wire is clamped.

Reversed left and right sound.

- Speakers are connected wrongly.
→ Check the speaker connections and location.

Lack of bass sound or apparently imprecise physical location of musical instruments.

- Speakers are connected wrongly.
→ Check the speaker connection for proper phasing, colored/black wires to colored/black terminals.

Remote control has no effect on the system.

- Wrong source is selected.
→ Select the source (CD, TUNER, etc.) before pressing the function button (▶, ◀, ▶, etc.).
- The distance to the system is too large.
→ Reduce the distance.
- Batteries are inserted incorrectly.
→ Insert the batteries with their polarities (+/- signs) as indicated.
- Batteries are exhausted.
→ Replace the batteries.

Timer is not working.

- Clock is not set.
→ Set the clock.
- Timer is not switched on.
→ Press **TIMER** to switch on the timer.

Clock setting is erased.

- There was a power failure.
→ Reset the clock.

System displays features automatically; buttons flash continuously.

- Demonstration mode is switched on.
→ Press and hold **■** (on the system) for five seconds to switch off the demonstration.

There is a howling sound at the external source.

- You hear feedback when you are listening in AUX mode.
→ Press **AUX** to select **CDR** mode.

All lighted buttons are not lit.

- Display is switch on in DIM 3 mode.
→ Press **DIM** until **DIM OFF** display mode is shown.



LIMITED WARRANTY

AUDIO SYSTEM

One Year Free Labor
One Year Free Service on Parts

This product must be carried in for repair.

WHO IS COVERED?

You must have proof of purchase to receive warranty service. A sales receipt or other document showing that you purchased the product is considered proof of purchase.

WHAT IS COVERED?

Warranty coverage begins the day you buy your product. For one year thereafter, all parts will be repaired or replaced, and labor is free. After one year from the day of purchase, you pay for the replacement or repair of all parts, and for all labor charges.

All parts, including repaired and replaced parts, are covered only for the original warranty period. When the warranty on the product expires, the warranty on all replaced and repaired parts also expires.

WHAT IS EXCLUDED?

Your warranty does not cover:

- labor charges for installation or setup of the product, adjustment of customer controls on the product, and installation or repair of antenna systems outside of the product.
- product repair and/or part replacement because of misuse, accident, unauthorized repair or other cause not within the control of Philips Consumer Electronics Company.
- reception problems caused by signal conditions or cable or antenna systems outside the unit.
- a product that requires modification or adaptation to enable it to operate in any country other than the country for which it was designed, manufactured, approved and/or authorized, or repair of products damaged by these modifications.
- incidental or consequential damages resulting from the product. (Some states do not allow the exclusion of incidental or consequential damages, so the above exclusion may not apply to you. This includes, but is not limited to, prerecorded material, whether copyrighted or not copyrighted.)

- a product that is used for commercial or institutional purposes.

WHERE IS SERVICE AVAILABLE?

Warranty service is available in all countries where the product is officially distributed by Philips Consumer Electronics Company. In countries where Philips Consumer Electronics Company does not distribute the product, the local Philips service organization will attempt to provide service (although there may be a delay if the appropriate spare parts and technical manual(s) are not readily available).

MAKE SURE YOU KEEP..

Please keep your sales receipt or other document showing proof of purchase. Attach it to this owner's manual and keep both nearby. Also keep the original box and packing material in case you need to return your product.

BEFORE REQUESTING SERVICE...

Please check your owner's manual before requesting service. Adjustments of the controls discussed there may save you a service call.

TO GET WARRANTY SERVICE IN U.S.A., PUERTO RICO OR U.S. VIRGIN ISLANDS...

Take the product to a Philips factory service center (see enclosed list) or authorized service center for repair. When the product has been repaired, you must pick up the unit at the center. Centers may keep defective parts.

(In U.S.A., Puerto Rico and U.S. Virgin Islands, all implied warranties, including implied warranties of merchantability and fitness for a particular purpose, are limited in duration to the duration of this express warranty. But, because some states do not allow limitations on how long an implied warranty may last, this limitation may not apply to you.)

TO GET WARRANTY SERVICE IN CANADA...

Please contact Philips at:

1-800-661-6162 (French Speaking)
1-800-363-7278 (English Speaking)

(In Canada, this warranty is given in lieu of all other warranties. No other warranties are expressed or implied, including any implied warranties of merchantability or fitness for a particular purpose. Philips is not liable under any circumstances for any direct, indirect, special, incidental or consequential damages, howsoever incurred, even if notified of the possibility of such damages.)

REMEMBER...

Please record the model and serial numbers found on the product below. Also, please fill out and mail your warranty registration card promptly. It will be easier for us to notify you if necessary.

MODEL # _____

SERIAL # _____

This warranty gives you specific legal rights. You may have other rights which vary from state/province to state/province.

**Philips Service Solutions Group, P.O. Box 2976,
Longview, Texas 75606, USA, (903) 242-4800**

EL4965E006 / MAC 4110 / 12-98

43

Free Manuals Download Website

<http://myh66.com>

<http://usermanuals.us>

<http://www.somanuals.com>

<http://www.4manuals.cc>

<http://www.manual-lib.com>

<http://www.404manual.com>

<http://www.luxmanual.com>

<http://aubethermostatmanual.com>

Golf course search by state

<http://golfingnear.com>

Email search by domain

<http://emailbydomain.com>

Auto manuals search

<http://auto.somanuals.com>

TV manuals search

<http://tv.somanuals.com>