

Quick Use Guide

MX3660D



PHILIPS

Printed in China

Use this simple and quick way to watch your favorite DVD movie and enjoy your Home Cinema experience!

(Not all the cables supplied are required to complete the basic hook-up.)

Connecting Speaker Cable

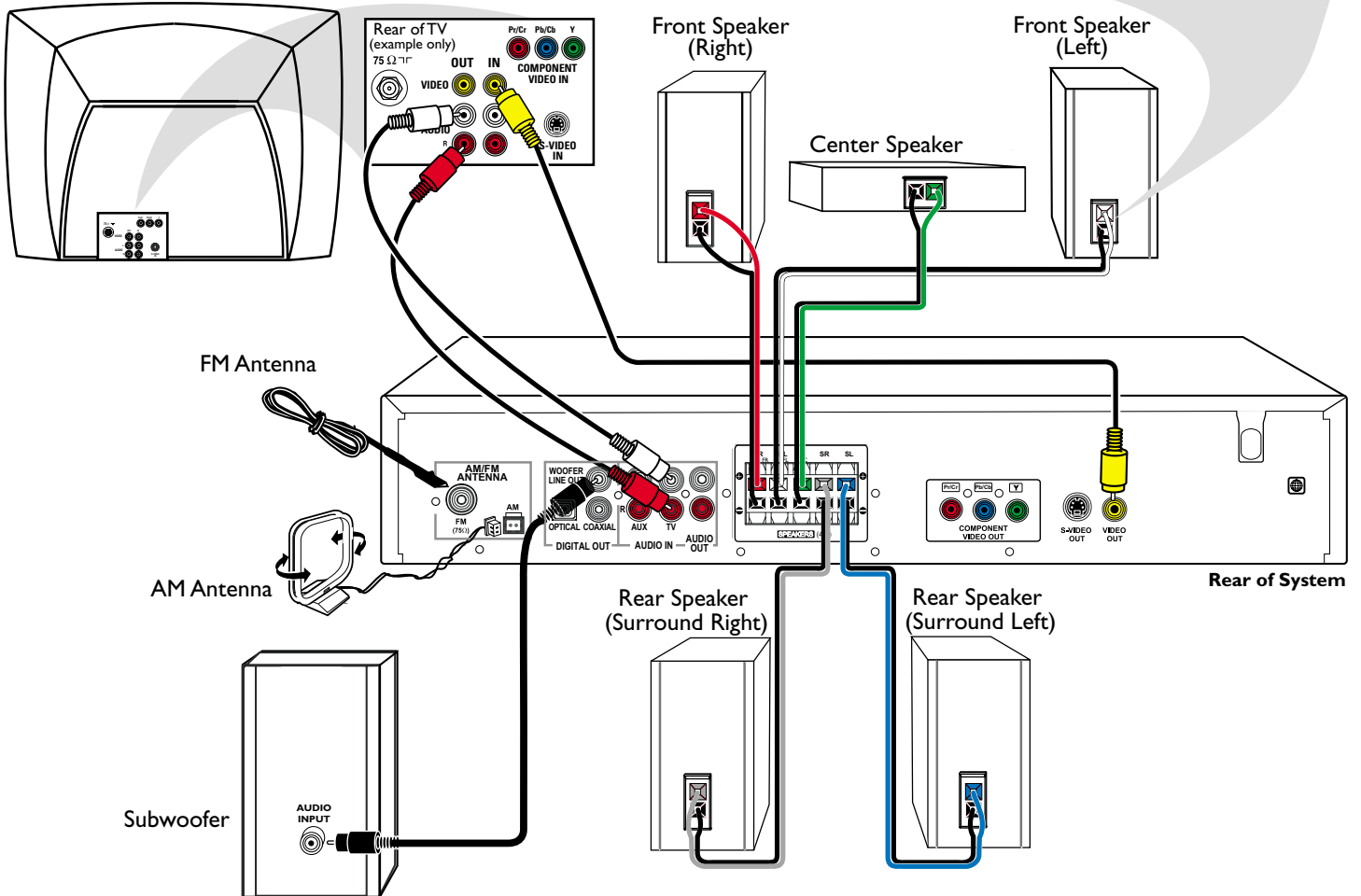
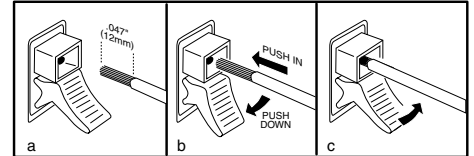

Recommended Speaker Setup

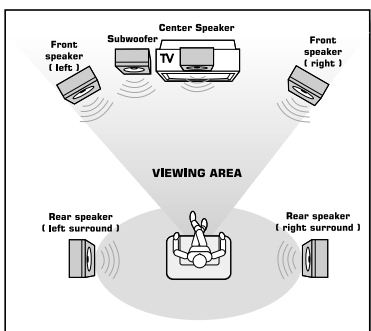

Helpful Hints

You only need to make one video connection to your TV in order to view the DVD playback.

75 Ω TV If your TV has only a single Antenna In jack, you will need an accessory RF modulator. The RF modulator converts the video from the DVD system so it can play through the TV's Antenna connector. Refer to your owner's manual for proper connection.

Additional Video Input Connections can provide better picture quality and image for DVD movie playback (If your TV is compatible) :

Component Video (Pr/Cr Pb/Cb Y) provides the best picture quality.
OR
S-Video provides excellent picture quality.

Connect the DVD system VIDEO OUT (put) directly to the TV. Do not connect to a VCR first and then to a TV. This type of connection may distort the picture and sound playback.

When listening to TV programs, press **TV/AV** button on the remote to set the DVD system to TV/AV mode in order for the sound to be heard.

continue...

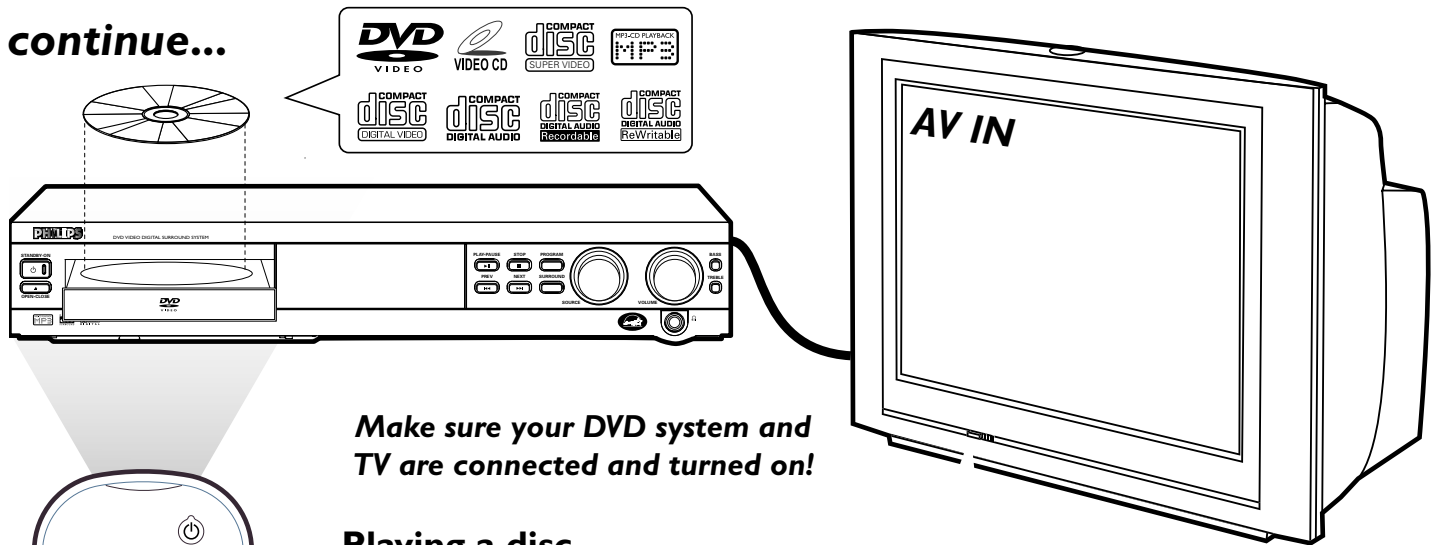

Make sure your DVD system and TV are connected and turned on!

Playing a disc

1 Press DISC on the remote control.

You can also adjust the SOURCE button on the front panel until "DISC" appears on the display panel.

2 Turn on the TV and select the correct Video In mode.

You should see the blue Philips DVD background screen on the TV (if no disc in the DVD system). Usually this channel is between the lowest and highest channels and may be called FRONT, A/V IN, or VIDEO.

Or, you may go to channel 1 on your TV, then press the Channel down button repeatedly until you see the Video In channel.

Or, your TV remote control may have a button or switch that chooses different video modes.

Do not use channel 3 or 4 on the TV unless you are using an RF modulator.

See your TV manual for more details.

3 Press OPEN•CLOSE \blacktriangle on the front of the DVD system and load a disc, then press the OPEN•CLOSE \blacktriangle again to close the disc tray.

Make sure the disc label facing up. For double-sided discs, load the side you want to play facing up.

4 Playback will start automatically. If not, press \blacktriangleright \parallel button.

If a disc menu appears, use \blacktriangle \blacktriangledown \blacktriangleleft \blacktriangleright buttons on the remote to make the necessary selection, then press OK to confirm. Or, use the numeric keypad on the remote to select features. Follow the instructions given in the disc menu.



5 To stop playback, press STOP \blacksquare .

Region Codes

DVDs must be labeled for ALL regions or for Region 1 in order to play on this DVD system.



DVD system Video Output Selection for Proper Playback

- 1) Press **SYSTEM MENU** button.
The  icon will be highlighted in the menu bar on the TV screen.
- 2) Press \blacktriangledown button to select the Picture Setup Menu item .
- 3) Press \blacktriangleright button to enter the Menu.
- 4) Press \blacktriangledown button to select 'VIDEO OUT' and \blacktriangleright button to enter the Menu.
- 5) Press $\blacktriangle\blacktriangledown$ to select and highlight :
S-VIDEO - if you use the S-Video connection.
PR PB Y/SCART - if you use the Component Video
Pr/Cr Pb/Cb Y
- 6) Press **OK** button to confirm.



Note: SCART control not available for use with your DVD system.



Detailed playback features and additional functions are described in the accompanying owner's manual.

DVD VIDEO DIGITAL SURROUND SYSTEM



Need help? Call us!

Philips representatives are ready to help you with any questions about your new product. We can guide you through Connections, First-time Setup, or any of the Features. We want you to start enjoying your new product right away!

**CALL US BEFORE YOU CONSIDER
RETURNING THE PRODUCT!**

1-800-531-0039

or

Visit us on the web at www.philips.com



PHILIPS

Return your Warranty Registration card today to ensure you receive all the benefits you're entitled to.

• Once your Philips purchase is registered, you're eligible to receive all the privileges of owning a Philips product.

• So complete and return the Warranty Registration Card enclosed with your purchase at once, and take advantage of these important benefits.

Warranty Verification

Registering your product within 10 days confirms your right to maximum protection under the terms and conditions of your Philips warranty.

Owner Confirmation

Your completed Warranty Registration Card serves as verification of ownership in the event of product theft or loss.

Model Registration

Returning your Warranty Registration Card right away guarantees you'll receive all the information and special offers which you qualify for as the owner of your model.

PHILIPS

Congratulations on your purchase, and welcome to the "family!"

Dear Philips product owner:

Thank you for your confidence in Philips. You've selected one of the best-built, best-backed products available today. And we'll do everything in our power to keep you happy with your purchase for many years to come.

As a member of the Philips "family," you're entitled to protection by one of the most comprehensive warranties and outstanding service networks in the industry.

What's more, your purchase guarantees you'll receive all the information and special offers for which you qualify, plus easy access to accessories from our convenient home shopping network.

And most importantly you can count on our uncompromising commitment to your total satisfaction.

All of this is our way of saying welcome – and thanks for investing in a Philips product.

Sincerely,



Lawrence J. Blanford
President and Chief Executive Officer

P.S. Remember, to get the most from your Philips product, you must return your Warranty Registration Card within 10 days. So please mail it to us right now!



Know these safety symbols



This "bolt of lightning" indicates uninsulated material within your unit may cause an electrical shock. For the safety of everyone in your household, please do not remove product covering.



The "exclamation point" calls attention to features for which you should read the enclosed literature closely to prevent operating and maintenance problems.

WARNING: TO PREVENT FIRE OR SHOCK HAZARD, DO NOT EXPOSE THIS EQUIPMENT TO RAIN OR MOISTURE.

CAUTION: To prevent electric shock, match wide blade of plug to wide slot, and fully insert.

For Customer Use

Enter below the Serial No. which is located on the rear of the cabinet. Retain this information for future reference.

Model No. _____

Serial No. _____



Canada

English:

This digital apparatus does not exceed the Class B limits for radio noise emissions from digital apparatus as set out in the Radio Interference Regulations of the Canadian Department of Communications.

Français:

Cet appareil numérique n'émet pas de bruits radioélectriques dépassant les limites applicables aux appareils numériques de Class B prescrites dans le Règlement sur le Brouillage Radioélectrique édicté par le Ministère des Communications du Canada.

English ----- 5

Français ----- 28

Español ----- 51

Manufactured under license from Dolby Laboratories. "Dolby", "Pro-Logic" and the double-D symbol are trademarks of Dolby Laboratories. Confidential Unpublished Works. ©1992-1997 Dolby Laboratories, Inc. All rights reserved.

Manufactured under license from Digital Theater Systems, Inc. US Pat. No. 5,451,942, 5,956,674, 5,974,380, 5,978,762 and other world-wide patents issued and pending. "DTS" and "DTS Digital Surround" are registered trademarks of Digital Theater Systems, Inc. Copyright 1996, 2000 Digital Theater Systems, Inc. All Rights Reserved.

This product incorporates copyright protection technology that is protected by method claims of certain U.S. patents and other intellectual property rights owned by Macrovision Corporation and other rights owners. Use of this copyright protection technology must be authorized by Macrovision Corporation, and is intended for home and other limited viewing uses only unless otherwise authorized by Macrovision Corporation. Reverse engineering or disassembly is prohibited.

CAUTION

Use of controls or adjustments or performance of procedures other than herein may result in hazardous radiation exposure or other unsafe operation.

ATTENTION

L'utilisation des commandes ou réglages ou le non-respect des procédures ci-incluses peuvent se traduire par une exposition dangereuse à l'irradiation.

ATENCIÓN

El uso de mando o ajustes o la ejecución de métodos que no sean los aquí descritos puede ocasionar peligro de exposición a radiación.

Laser

Type	Semiconductor laser GaAlAs
Wave length	650nm
Output Power	7mW
Beam divergence	60 degree

The set complies with the FCC-Rules, Part 15 and with 21 CFR 1040.1. Operation is subject to the following two conditions:

- 1. This device may not cause harmful interference, and**
- 2. This device must accept any interference received, including interference that may cause undesired operation.**

NOTE:

PICTURES SHOWN MAY BE DIFFERENT BETWEEN COUNTRIES.

NEVER MAKE OR CHANGE CONNECTIONS WITH THE POWER SWITCHED ON.

IMPORTANT SAFETY INSTRUCTIONS

1. **Read these instructions.**
2. **Keep these instructions.**
3. **Heed all warnings.**
4. **Follow all instructions.**
5. **Do not use this apparatus near water.**
6. **Clean only with dry cloth.**
7. **Do not block any ventilation openings. Install in accordance with the manufacturer's instructions.**
8. **Do not install near any heat sources** such as radiators, heat registers, stoves, or other apparatus (including amplifiers) that produce heat.
9. **Do not defeat the safety purpose** of the polarized or grounding-type plug. A polarized plug has two blades with one wider than the other. A grounding type plug has two blades and a third grounding prong. The wide blade or the third prong are provided for your safety. If the provided plug does not fit into your outlet, consult an electrician for replacement of the obsolete outlet.
10. **Protect the power cord** from being walked on or pinched, particularly at plugs, convenience receptacles, and the point where they exit from the apparatus.

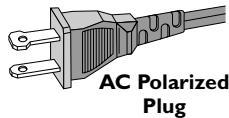

11. **Only use attachments/accessories** specified by the manufacturer.
12.  **Use only with the cart,** stand, tripod, bracket, or table specified by the manufacturer or sold with the apparatus. When a cart is used, use caution when moving the cart/apparatus combination to avoid injury from tip-over.
13. **Unplug this apparatus** during lightning storms or when unused for long periods of time.
14. **Refer all servicing** to qualified service personnel. Servicing is required when the apparatus has been damaged in any way, such as power-supply cord or plug is damaged, liquid has been spilled or objects have fallen into the apparatus, the apparatus has been exposed to rain or moisture, does not operate normally, or has been dropped.
15. **Battery usage CAUTION** – To prevent battery leakage which may result in bodily injury, property damage, or damage to the unit:
 - Install **all** batteries correctly, **+** and **-** as marked on the unit.
 - Do not mix batteries (**old** and **new** or **carbon** and **alkaline**, etc.).
 - Remove batteries when the unit is not used for a long time.

EL 6475-E004: 02/8

WARNING!

To reduce the risk of fire or electric shock, this apparatus should not be exposed to rain or moisture, and objects filled with liquids, such as vases, should not be placed on this apparatus.

Class II equipment symbol



This symbol indicates that the unit has a double insulation system

Introduction and General Information

Features	6
Discs for playback	6
Player zone	
Supplied accessories	6
Environmental information	6
Installation	6
Maintenance	6

Functional Overview

Front and Rear panels	7
Remote Control	8

Connections

Step 1: Connecting antennas	9
AM Indoor Loop Antenna	
FM Indoor Antenna	
FM Outdoor Antenna	
Step 2: Connecting the speakers	10
Step 3: Connecting a TV	10
Connecting additional components	10

Preparations

Inserting batteries into the remote control	11
Switching on the system	11
Setting up the surround sound system	11–12
Placing the speakers	
Changing the volume level	
Setting up the subwoofer	12
System Setup (DVD)	12–14
General operation	
Setting the picture	
Setting the sound	
Setting the language	
Setting the features	

Basic Functions

Selecting the surround sound mode	15
Selecting the digital sound effect	15
Volume control	16
Adjusting the tone	16
Dimming the display screen	16

Operations

Discs information	17
Basic playback	17–18
Skipping to another track/chapter	
Fast Search	
Continue playback from the last stop point	
Repeat play	
Repeat A-B	
Program favorite tracks	
Special DVD/VCD features	18-20
Changing subtitle language	
Changing sound track language	
Playing in slow motion mode	
Searching for a particular passage	
Display the disc information during playback	
Moving to another title/chapter	
Playback from a selected point	
Zooming in	
Viewing from another angle	
Advancing by frames	
Checking the contents of DVD	
Special VCD/SVCD features	20
Playback Control (PBC)	
Special MP3-CD features	21
MP3-CD menu	

Other Functions

Tuning to radio stations	22
Presetting radio stations	22
Listening to preset radio stations	22
Sleep timer setting	22

Specifications

Troubleshooting

Introduction and General Information

Features

Your complete 7-piece DVD Digital Home Cinema System creates the same dynamic sound qualities that you find in full-fledged cinemas and incorporates some of the best features in home theater technology.

Other features include:

Built-in DTS and Dolby® Digital decoder, supporting Dolby® ProLogic and virtual surround

Lets you use the Home Cinema Audio System for a movie-theater surround sound experience.

Additional Component Connections

Lets you connect other audio and audio/visual components to the DVD system so you can use the system's surround sound speakers.

Night Mode

Lets you compress the dynamic range, reducing the difference in loudness between different sounds in Dolby Digital mode.

Parental Control (Rating Level)

Lets you set a ratings level so that your children cannot watch a DVD that has a rating higher than you set.

Sleep Timer

Enables the system to switch to standby mode automatically at a preset time.

Discs for playback

Your DVD player is able to play :

- **All pre-recorded audio CDs**
- **All finalized audio CDR and audio CDRW discs**
- **All VCDs, Super VCDs and DVDs**
- **MP3-CDs (CD-ROMs with MP3 tracks)**



Player zone

DVD discs and players are designed with regional restrictions. Before playing a disc, make sure the disc is the same zone as your player:

The region code for this DVD player is 1.



Supplied accessories

- Remote control with two AA batteries
- AM loop antenna and FM wire antenna
- Audio cable (white/red), video cable (yellow)
- Five satellite speakers, including five speaker cables
- Active subwoofer, including a connection cable
- This instruction booklet and Quick Use Guide

If any item is damaged or missing, contact your retailer or Philips.

Environmental information

All unnecessary packaging has been omitted. We have tried to make the packaging easy to separate into three materials: cardboard (box), polystyrene foam (buffer) and polyethylene (bags, protective foam sheet).

Your system consists of materials which can be recycled and reused if disassembled by a specialized company. Please observe the local regulations regarding the disposal of packaging materials, exhausted batteries and old equipment.

Installation

- Place the player on a flat, hard, and stable surface.
- There must be sufficient room in front of the player for the drawer to open.
- In a cabinet, allows about 10cm (4 inches) of free space all around the player for adequate ventilation.
- Do not expose your player to extreme temperatures or humidity.

Maintenance

- When a disc becomes dirty, clean it with a cleaning cloth. Wipe the disc from the center out, in a straight line.
- Do not expose the player, batteries or discs to humidity, rain, sand or excessive heat (caused by heating equipment or direct sunlight). Always keep the disc tray closed to avoid dust on the lens.
- Do not use solvents such as benzene, thinner, commercially available cleaners, or anti-static spray intended for analog discs.
- The lens may cloud over when the player is suddenly moved from cold to warm surroundings, making it impossible to play a disc. Leave the player in the warm environment until the moisture evaporates.

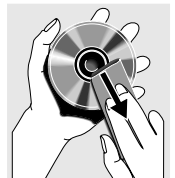

Front and Rear panels

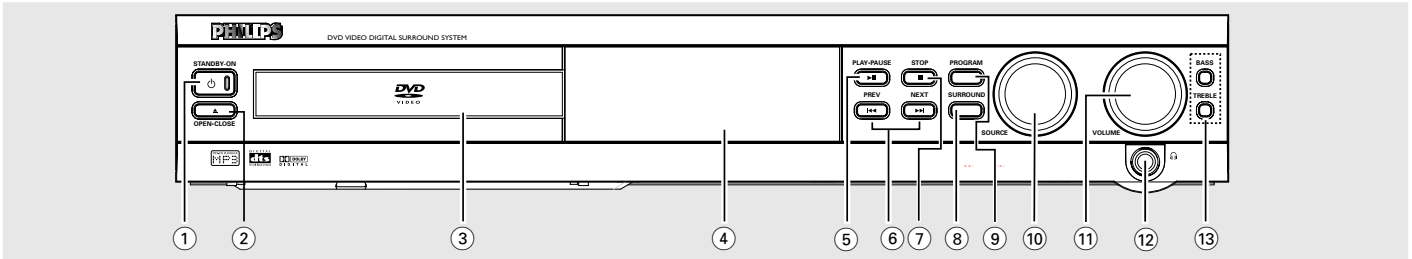

- ① **STANDBY ON**
- to switch between power on and standby modes.
- ② **OPEN/CLOSE**
- to open or close the disc tray.
- ③ **Disc Tray**
- ④ **Display screen**
- to display details for user's information.
- ⑤ **PLAY/PAUSE**
- to start or interrupt disc playback.
- ⑥ **PREV** / **NEXT**
- in Disc mode, press to skip to the previous/next chapter/track.
- in Disc mode, hold down to fast reverse/forward.
- in Tuner mode, to tune to a lower or higher radio frequency.
- ⑦ **STOP**
- to stop playing the disc.
- ⑧ **SURROUND**
- to select multichannel surround (Dolby Digital, DTS or Dolby ProLogic) or stereo sound effect.
- ⑨ **PROGRAM**
- in Disc mode, to program disc tracks.
- in Tuner mode, to program preset radio stations.
- ⑩ **SOURCE**
- to select the desired source or external input source (TV/AV, DISC, TUNER or AUX).
- ⑪ **VOLUME**
- to adjust the master volume.
- to adjust the bass/treble tone level.
- ⑫
- to connect headphones.
- ⑬ **BASS / TREBLE**
- to select Bass/Treble adjustment mode.

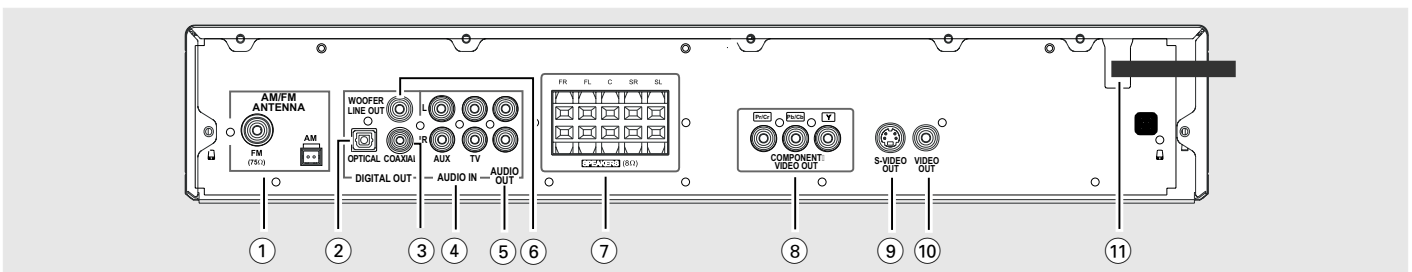

- ① **AM/FM ANTENNA**
- connect to the AM loop antenna or FM antenna.
- ② **DIGITAL OUT-OPTICAL**
- connect to audio equipment with digital-optical audio input.
- ③ **DIGITAL OUT-COAXIAL**
- connect to audio equipment with digital-coaxial audio input.
- ④ **AUDIO IN (TV / AUX)**
- connect to the analog audio outputs of a TV or VCR.
- ⑤ **AUDIO OUT**
- connect to the analog audio inputs of an external recording device or amplifier.
- ⑥ **WOOFER LINE OUT**
- connect to an active subwoofer.
- ⑦ **SPEAKERS**
- connect to the front, center and surround speakers.
- ⑧ **COMPONENT VIDEO OUT (Pr/Cr Pb/Cb Y)**
- connect to TV with Pr/Cr Pb/Cb Y inputs.
- ⑨ **S-VIDEO OUT**
- connect to a TV with S-video input.
- ⑩ **VIDEO OUT**
- connect to a TV with video input.
- ⑪ **AC Power Cord**
- connect to a standard AC outlet.

Caution: Do not touch the inner pins of the jacks on the rear panel. Electrostatic discharge may cause permanent damage to the unit.

Remote Control

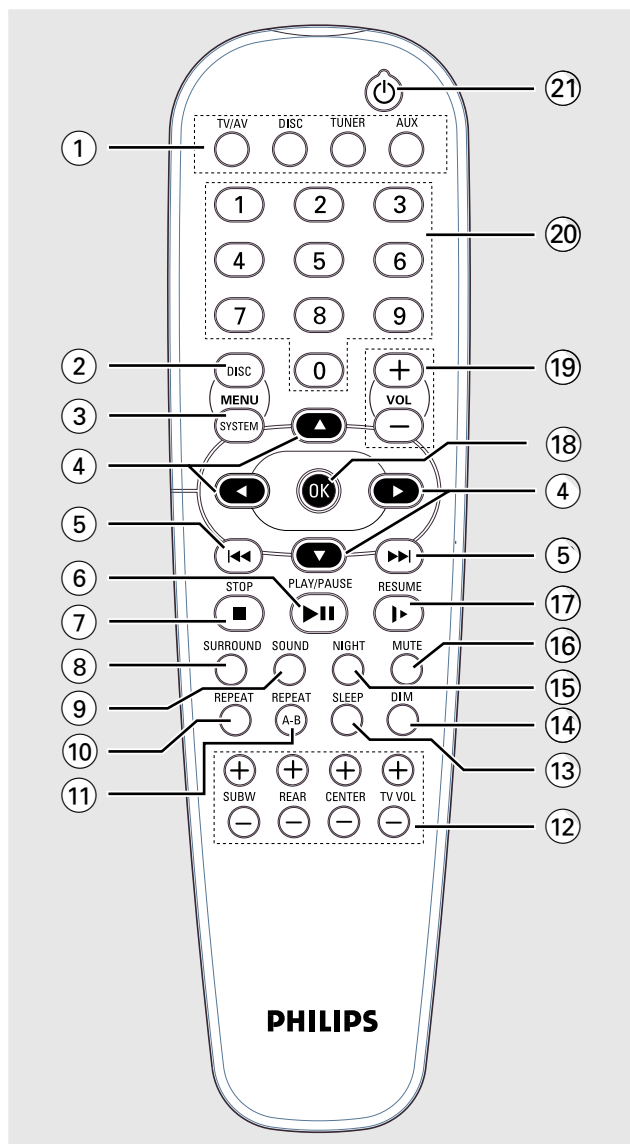

Notes for remote control:

– First, select the source you wish to control by pressing one of the source select keys on the remote control (DISC or TUNER, for example).

– Then select the desired function (▶, ◀◀, ▶▶▶ for example).

① SOURCE

– to select the desired source (TV/AV, DISC, TUNER or AUX).

② DISC MENU (disc mode only)

– to enter or exit the disc contents menu.

③ SYSTEM MENU (disc mode only)

– to enter or exit the system menu bar.

④ ▲ ▼ ◀ ▶

– in Tuner mode, to select a preset radio station number (◀ or ▶).

– to select movement direction in disc contents menu / system menu bar.

⑤ ◀◀ / ▶▶▶

– in disc mode, press to skip to the previous/next chapter/track.
 – in disc mode, hold down to fast reverse/forward the disc.
 – in Tuner mode, to tune to a lower or higher radio frequency.

⑥ ▶▶

– to start or interrupt disc playback.

⑦ ■

– to stop playing the disc.

⑧ SURROUND

– to select multichannel surround (Dolby Digital, DTS or Dolby ProLogic) or stereo sound effect.

⑨ SOUND

– to select the various sound effects : CONCERT, DRAMA, ACTION, SCI-FI, CLASSIC, JAZZ, ROCK or DIGITAL.

⑩ REPEAT

– to repeat chapter, track or disc.

⑪ REPEAT A-B

– to repeat a specific section on a disc.

⑫ SUBW + / –

– to adjust the subwoofer's level.

REAR + / –

– to adjust the rear (surround) speakers' level.

CENTER + / –

– to adjust the center speaker's level.

TV VOL + / –

– to adjust Philips television's volume level.

⑬ SLEEP

– to set the sleep (auto-off) timer function.

⑭ DIM

– to select different brightness for the display screen.

⑮ NIGHT (DVD mode only)

– to optimize the dynamics of the sound output.

⑯ MUTE

– to interrupt or resume sound reproduction.

⑰ RESUME

– to continue disc playback after an interruption.

⑱ OK

– to enter or confirm the selection.

⑲ VOL + / –

– to adjust the volume level.

⑳ Numeric Keypad (0-9)

– to enter a track/title number of the disc.

– to enter a number of preset radio stations.

㉑ ⏻

– to switch to standby mode.

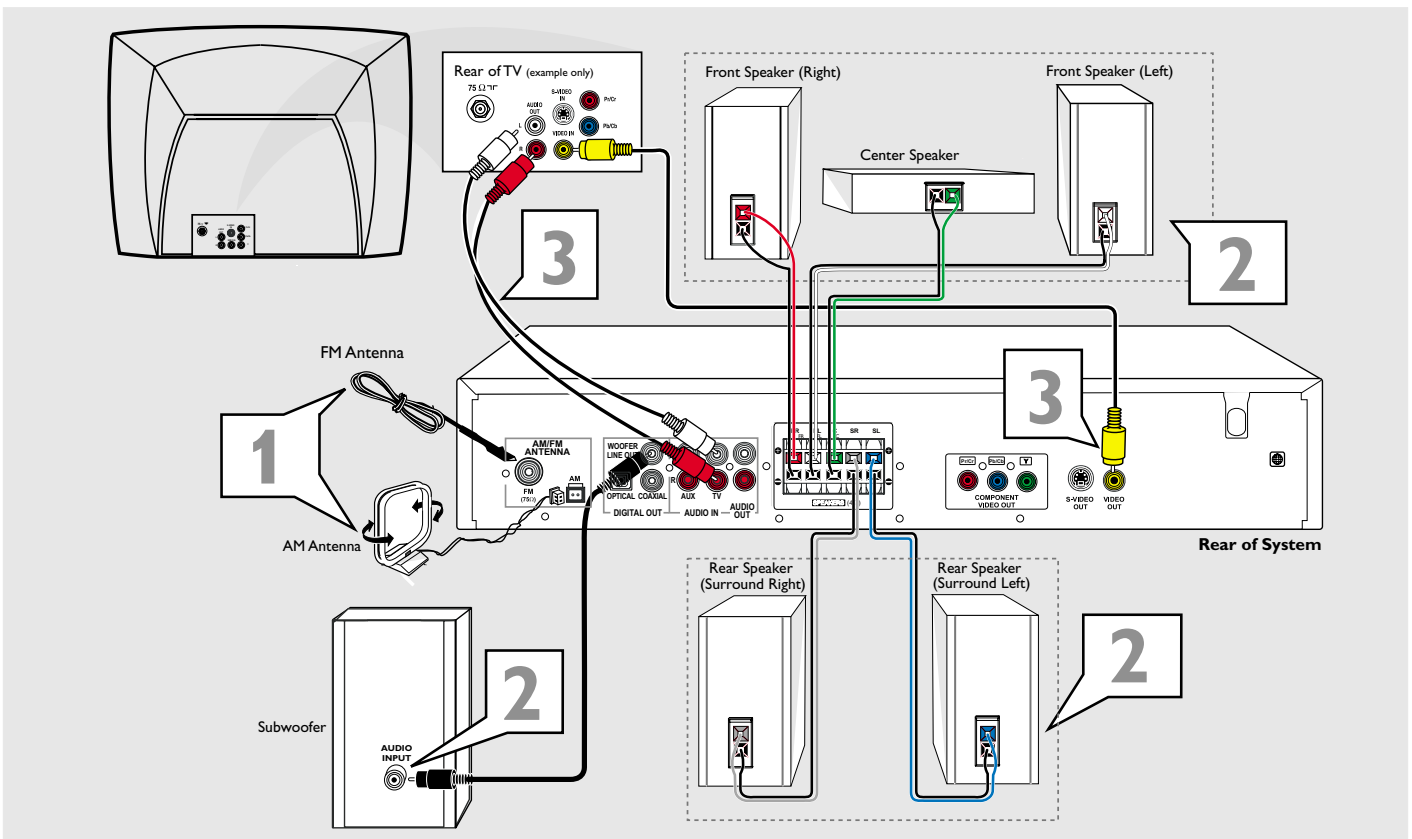

IMPORTANT!

- Before connecting the AC power cord to the wall outlet, ensure that all other connections have been made.
- Never make or change any connections with the power switched on.
- The type plate is located at the rear or bottom of the system.

Step 1: Connecting antennas

AM Indoor Loop Antenna

Connect the supplied AM loop antenna to the **AM** jack. Position the loop antenna to receive the clearest sound.

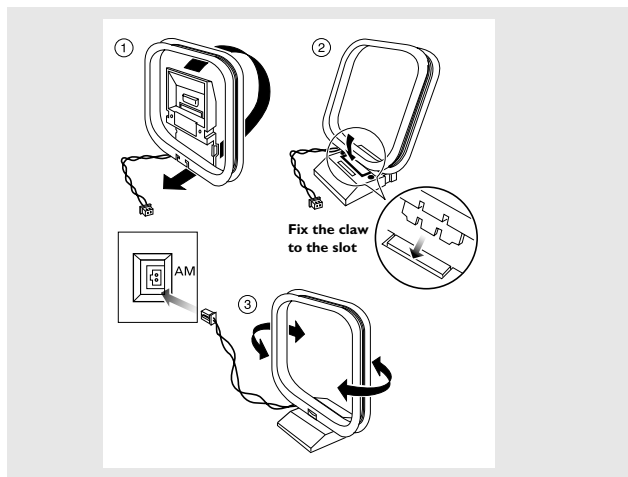

FM Indoor Antenna

Connect the supplied FM antenna to the **FM** jack. Move the antenna in various directions until the clearest signal is received.

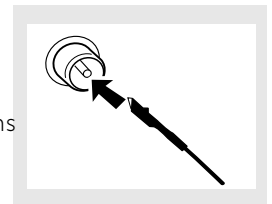

Note:

- Keep the antenna as far away as possible from the TV, VCR or any radiation source to prevent unwanted noise.

FM Outdoor Antenna

For better FM reception, use a 75 ohm coaxial cable (not supplied) to connect the system to an outdoor FM antenna as shown.

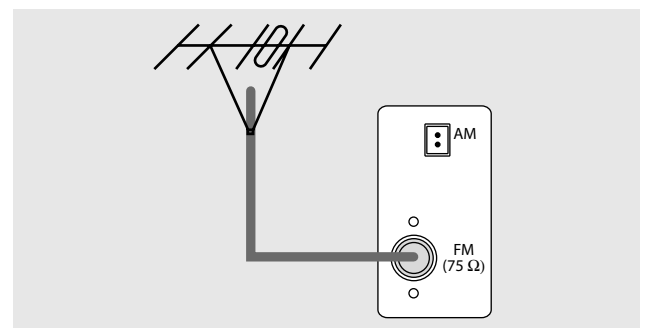

Step 2: Connecting the speakers

Connect the supplied speaker systems using the supplied speaker cables by matching the colors of the jacks and speaker cables.

- 1 Press up (or down) the speaker's jack and fully insert the stripped portion of the speaker cable into the jack, then release.
- 2 Connect the subwoofer's audio input to the **WOOFER LINE OUT** jack and the speakers as follows :

Speakers	⊖	⊕
Front Left (FL)	black	white
Front Right (FR)	black	red
Center (C)	black	green
Surround Left (SL)	black	blue
Surround Right (SR)	black	gray

Notes:

- Ensure that the speaker cables are correctly connected. Improper connections may damage the system due to short-circuit.
- For optimal sound performance, use the supplied speakers.
- Do not connect more than one speaker to any one pair of + / - speaker jacks.
- Do not connect speakers with impedance lower than the speakers supplied. Please refer to the SPECIFICATIONS section of this manual.

Step 3: Connecting a TV

IMPORTANT!

– There are various ways to connect the system to a TV (as shown in the illustration), it depends on the capabilities of your TV system.

- **To listen to the TV broadcast channels or VCR playback through the home cinema sound system**

Use the supplied audio cables (white/red) to connect **AUDIO IN** (TV or AUX) jacks to the corresponding **AUDIO OUT** jacks on the TV, VCR or other audio/visual components.

Before start operation, press **TV/AV** or **AUX** on the remote control to activate the corresponding input source.

- **To view the DVD playback**

Use the video cable (yellow) to connect the system's **VIDEO OUT** jack to the video input jack on the TV.

- **You can make an extra video connection with one of the following options if your TV has the same input connector**

Option 1

Use the S-video cable to connect the system's **S-VIDEO OUT** jack to the S-Video input jack on the TV.

OR

Option 2

Use the component video cables (red/blue/green) (not supplied) to connect the system's **Pr/Cr Pb/Cb Y** jacks to the corresponding Pr/Cr Pb/Cb Y input jacks on the TV.

IMPORTANT!

If S-VIDEO or Component video Pr/Cr Pb/Cb Y is used for DVD playback connection, the system's VIDEO OUT setting will need to be set accordingly. Details are on pages 12-13.

- **If your TV only has an RF-style jack (Antenna In or 75 ohm)**

You will need an RF modulator in order to view the playback of DVD discs on your TV. Ask your dealer for details on RF modulator availability and compatibility. Follow the instructions provided with the RF modulator to connect the DVD system to your TV

Connecting additional components

- **To connect additional components**

Use the AUDIO OUT jacks

- for connecting to an amplifier, audio system or TV with analog audio inputs.
- for connecting to a CD or Tape recorder to make an analog recording.

Use the OPTICAL or COAXIAL jacks

- for connecting to an amplifier with DTS, Dolby Digital decoder or CD recorder.
- You will need to set the DVD system's digital output to "ALL" (refer to "Preparations - System setup (DVD)").

Notes:

- MP3 audio is not available on the digital output.
- Digital recording is only possible on a CD or VCD.
- Always refer to the instruction manual of the connected equipment to make an optimal connection.
- Some DVD discs have anti-copying devices, so you will not be able to record the disc through a VCR.

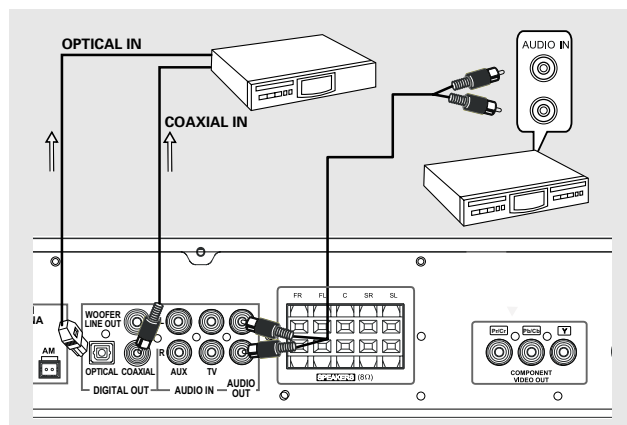

Inserting batteries into the remote control

- 1 Open the battery compartment.
- 2 Place the batteries in the compartment with the correct polarity as indicated by "+" and "-" symbols.
- 3 Close the cover.

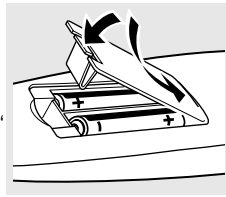

CAUTION!

- Remove batteries if they are exhausted or will not be used for a long time.
- Do not use old and new or different types of batteries in combination.
- Batteries contain chemical substances, so they should be disposed of properly.

Switching on the system

- 1 After completing all the connections, connect the AC power cord of the player and subwoofer to the power outlet.
- 2 Press **STANDBY ON** to switch on the last selected source.
- 3 Adjust the **SOURCE** button (or press **TV/AV**, **DISC**, **TUNER** or **AUX**) to select the input source.
 - The selected source will be displayed.
- For viewing a DVD or VCD disc, a TV set needs to be connected (refer to "Connections - Connecting a TV and additional components").
 - Switch on the TV and set to the correct video in channel (for example, EXT1, EXT2, AV1, AV2). Refer to your TV instruction manual for details.
 - The default screen appears on the TV.
- You can connect other external components to the DVD system in order to use the Home Theater Audio System's surround sound capabilities. For example, connect to a TV and select TV/AV as the input source or connect to a VCR and select AUX as the input source.

Setting up the surround sound system

You must connect all the speakers and set up the system properly in order to enjoy the Digital Cinema experience at home (refer to "Connections - Connecting the speakers"). You will have the feeling of being in the middle of the action because sound is coming from everywhere around you. The subwoofer can enhance the bass performance of your system dramatically.

IMPORTANT!

Please sit at your usual listening position in order to set up the speaker balance correctly.

Placing the speakers

To obtain the best surround effect, place the speakers as follows.

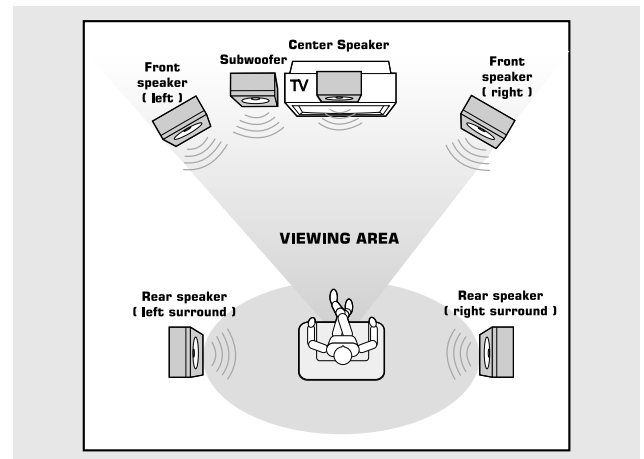

- 1 Place the front left and right speakers at equal distances from the TV and at an angle of approximately 45 degrees from the listening position.
- 2 Place the center speaker above or below the TV so the center channel's sound is localized.
- 3 Place the surround speakers at normal listening ear level facing each other or mounted on the wall.
- 4 Place the subwoofer on the floor near the TV.

Notes:

- To avoid magnetic interference, do not position the front speakers too close to your TV.
- If the rear surround speakers are installed farther away from the listening position than the front and center speakers, it will weaken the surround effect.
- All speakers should be securely installed to prevent accidents and improve sound quality.

Changing the volume level

You can change the speakers' sound distribution to suit your surround sound needs.

- Press **CENTER** \pm / \mp to adjust the level of the center speaker.
→ "CENT +XX dB" is displayed.
- Press **REAR** \pm / \mp to adjust the level of the rear surround speakers.
→ "RE +XX dB" is displayed.

Note:

– "XX" denotes the volume level between -15db to 10db.

Setting up the subwoofer

- 1 Use the supplied subwoofer cable to connect the subwoofer's audio input jack to the **WOOFER LINE OUT** of the DVD system.
- 2 Connect the subwoofer's AC power cable to the wall socket and switch on the power.
- 3 Rotate the **VOLUME** knob at the front panel of subwoofer until you hear a click, clockwise to switch on and counter-clockwise to switch off.
→ The LED indicator will light up in green when the subwoofer is switched on.
- 4 Select the phase polarity at the rear of the subwoofer at either **0°** or **180°** to determine better bass reproduction effect in certain listening environment.
- 5 Press **SUBW** \pm / \mp to adjust the volume level of the subwoofer (-15dB to 10dB).
→ "SUB +XX dB" is displayed.

System Setup (DVD)

The system setup is carried out via the TV, it enabling you to customize the DVD system to suit your particular requirement. If the preferred options selected are not available on a disc, then the disc's own preference will be used.

IMPORTANT !

To access the System Setup menu, playback must be stopped.

General operation

- 1 Press **SYSTEM MENU**.
→  icon will be highlighted in the menu bar on the TV screen.
- 2 Press \blacktriangledown to activate the System Setup menu.
- 3 Use \blacktriangleleft \blacktriangleright keys to toggle through the functions and select your preferred option.
- 4 Press **OK** to confirm a highlighted selection.
- 5 To exit the System Setup menu, press **SYSTEM MENU** or **OK**.

The following items are available :

Setting the picture

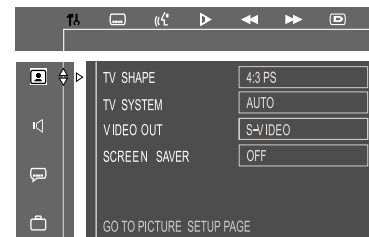

– TV Shape

Select the aspect ratio of the TV to be connected.

4:3 PS

– If you have a conventional TV set and your DVD is not formatted for widescreen viewing, use this setting. A wide picture is displayed on the whole TV screen with a portion automatically cut off.

4:3 LB

– If you have a conventional TV set and your DVD is formatted for widescreen viewing, use this setting. Wide bands will be displayed on the upper and lower portions of the TV screen.

16:9

– If you have a widescreen TV set, use this setting (you must also set your widescreen TV to "full size").

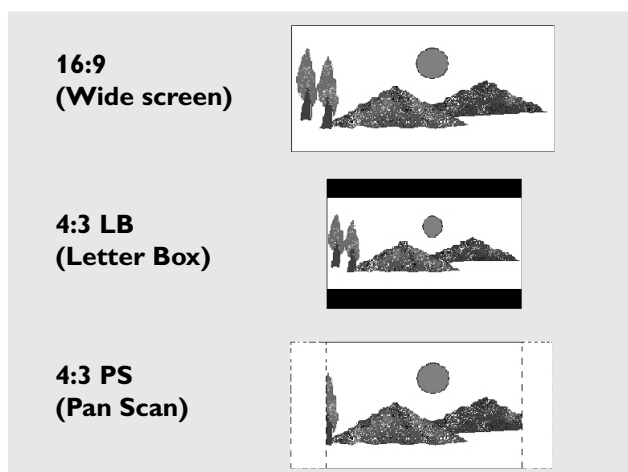

Note:

– If your DVD is not encoded to allow you to change the aspect ratio, TV shape cannot be changed.

– TV System

Allows you to select the color system matching the connected TV set.

AUTO

– If the connected TV is multi system, select this mode. The output format will be in accordance with the video signal of the disc.

NTSC

– If the connected TV is NTSC system, select this mode. It will change the video signal of a PAL disc and output in NTSC format.

PAL

– If the connected TV is PAL system, select this mode. It will change the video signal of a NTSC disc and output in PAL format.

– Video Out

Video out selection enables you to choose the type of video output suitable for your DVD system.

- Select **PR PB Y/SCART**, if you have connected the video output to your TV using the Component Video Out (Pr/Cr Pb/Cb Y) jacks. (SCART feature is not available for this model).
- Select **S-VIDEO**, if you have connected the video output to your TV using S-Video jack.

– Screen Saver

If set to ON, when you leave the system in stop or pause mode for more than one minute, the screen saver will be activated. The default setting is OFF.

Setting the sound 

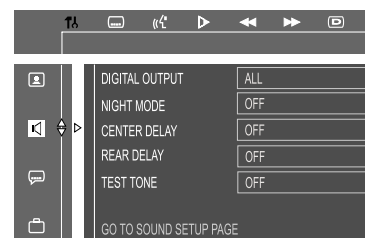

– Digital Output

Digital output selection enables you to specify the type of digital output suitable for your DVD system.

- Select **ALL**, if you have connected the digital output (COAXIAL or OPTICAL) to a multichannel decoder receiver.
- Select **PCM 96K** if the external component is capable of processing digital signal input with sampling rates of 96 kHz.
- Select **PCM 48K** if the external component is incapable of processing 96 kHz digital signal input, then convert to standard signal with sampling rates of 48 kHz.
- Select **OFF** to deactivate the digital output (COAXIAL or OPTICAL).

– Night Mode

Set night mode to on to level out the volume. For example, the disc will play at the same sound level throughout the movie. The default setting is OFF.

Night function can also be accessed via the remote control.

– Center Delay

If the listening position is closer to the center speaker than the front speakers, you can set the center delay time to improve the surround sound effect.
Options : 5ms, 3ms, 2ms, 1ms or OFF.

– Rear Delay

If the listening position is closer to the rear surround speakers than the front speakers, you can set the rear delay time to improve the surround sound effect.
Options : 15ms, 12ms, 9ms, 6ms, 3ms or OFF.

– Test Tone (disc mode only)

If set to ON, the system will test the speaker settings. The test signal is generated through the left, center, right, and surround speakers. The default setting is OFF.

Setting the language



- **Audio**
- **Subtitle**
- **Disc Menu**

- This is to select the audio language, subtitle language and the language used on TV screen menus or DVD menus that will always be used for every disc to be played back. The default setting is English.
- If the language selected is not available on the disc, the original language designated by each disc will be selected.

Setting the features

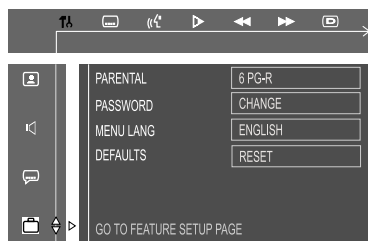

- Parental

Enables setting of playback limitation level. Some DVDs may have a parental level assigned to the complete disc or to certain scenes on the disc. The rating levels are from 1 to 8 and are country dependent. You can prohibit the playing of certain discs that are not suitable for your children or have certain discs played with alternative scenes.

- 1 Enter the 4-digit code. If necessary, enter the code a second time.

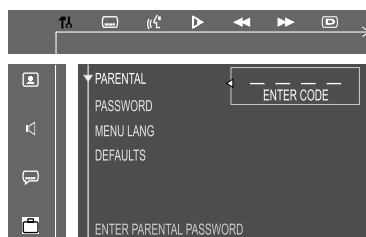

- 2 Use **▲▼** keys to select a rating level.

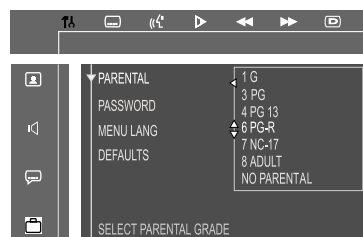

- 3 Press **OK** to confirm.

Rating - **NO PARENT**

If parental control is not activated, it will play all discs.

Rating - **1 to 8**

If the player's parental level is set below 8, only discs with a lower or equal level will play. For example, if the player is set to 5, only discs with ratings of 5, 4, 3, 2 and 1 will be played. Higher rated scenes will not be played unless an alternative that has the same rating or lower is available on the disc. For example, consider a disc that generally is suitable for most audiences, and it is rated at level 2 for the most part. However, in the middle, there are also scenes rated at 5 (not suitable for children).

To play a higher rated disc or scene than the level set

- Enter the 4-digit code before resetting the rating level to a higher number (go to "Password").

If you forget the 4-digit code

- 1 Press **■** **four times** when prompted for the password and the system will change back to the default password.
- 2 Go to "Password" and enter your new code.

Note:

– *Some DVDs are not encoded with a rating though the movie rating is printed on the disc jacket. The rating level feature does not work for such discs.*

- Password

To set a new password for the parental control or to change the password. The password supplied as default is 1234.

- Menu Language

Select the language for on screen display.

- Defaults

If RESET is selected, all the items in the setup menu will be reset to default setting.

Selecting the surround sound mode

IMPORTANT!

- For proper surround sound, make sure you have followed the “Connections” and “Preparations” procedures fully.
- The center and surround speakers only operate when the system is set to surround sound mode and the source material being played is recorded or broadcast in Dolby Digital, DTS or Dolby Pro Logic surround sound.
- Stereo broadcasts or recordings will produce some surround channel effects when played in a surround mode. However, monaural sources will not produce any sound from the surround speakers.

- Press **SURROUND** to select surround or stereo mode.
 - The availability of the various surround sound modes depend on the number of speakers used and the incoming sound information available on the disc. The available output modes are shown below.

Dolby Digital Surround

Dolby Digital (also known as AC-3 or Dolby 5.1) and MPEG Multichannel delivers a realistic and dynamic sound similar to theater and cinema. It requires connection of all five speakers (front left/right, center, surround left/right) and subwoofer for correct Dolby Digital Surround sound reproduction. Each channel plays its own unique role in providing the right sound. Front left, center and right join two surround speakers to reproduce high, mid and bass frequencies in five full-range channels of surround. Bass rumble, explosions and low frequency effects you feel are delivered through the subwoofer. A large number of DVD discs have been recorded in Dolby Digital Surround.

DTS Surround

The DTS Surround is a cinema surround sound format that offers superior digital audio performance. DTS offers more clarity and definition especially for higher tones. The better sound quality is a result of the limited sound compression (3:1 instead of 11:1 for Dolby Digital) and the 20-bit resolution.

Dolby Pro Logic Surround

The Dolby Pro Logic Surround system is a specially encoded two-channel analog format that will produce sound through four speaker channels (front left, center, front right, monaural surround) when a Dolby Pro Logic Decoder is used. It is also compatible with stereo systems but the user will only have two-channel (front left & right) of sound.

Matrix

A new surround playback system that delivers amazingly rich and convincing four-channel surround outputs (front left/right, surround left/right).

VSS (Virtual Surround Sound)

The ProLogic MPEG or Dolby Digital surround channel is processed by a 'virtualizer' DSP to add surround effect from just the two front speakers.

Stereo

All sound is reproduced and played through the front left and right speakers. This enables standard stereo reproduction.

Selecting the digital sound effect

The digital sound effects allow you to select from various pre-set modes that control the frequency bands of sound to optimize certain musical styles. It greatly enhances the excitement and enjoyment of your favorite music.

- Press **SOUND** repeatedly to select the available sound effect.

When playing a DVD/VCD, select :

- CONCERT, DRAMA, ACTION or SCI-FI

When playing a CD or in Tuner or Aux mode, select :

- CLASSIC, JAZZ, ROCK or DIGITAL

Volume control

Adjust **VOLUME** button (or press **VOL + / -**) to increase or decrease the volume level.

→ "VOL XX" is displayed. "XX" denotes the volume level.

For Philips TVs only

- Press **TVVOL + / -** on the remote control to adjust the TV's volume level.

To listen through the headphones

- Connect the headphones plug to the  socket at the front of the player.
 - The speakers will be muted.

To switch off the volume temporarily

- Press **MUTE**.
 - Playback will continue without sound and "MUTE" is displayed.
- To restore the volume, press **MUTE** again.

Adjusting the tone

The BASS (low tone) and TREBLE (high tone) feature enables you to define the sound-processor settings.

- 1 Press **BASS** or **TREBLE** on the system to select Bass or Treble sound feature.
- 2 While in Bass or Treble adjustment mode, adjust **VOLUME** knob to select the desired Bass or Treble level.

Notes:

- The volume knob can be used to adjust Bass/Treble level immediately after you have selected the respective Bass/Treble sound feature. If the volume knob is not used within 5 seconds, it will become normal volume control function.
- If no button is pressed within a few seconds, the player will exit the tone mode automatically.

Dimming the display screen

- Press **DIM** repeatedly to select different levels of brightness for the display screen : HIGH, MID or LOW.

Discs information

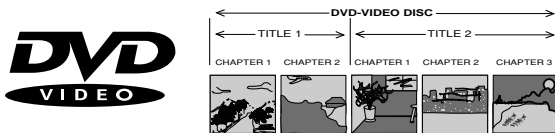

- DVD video discs may have one or more Titles, and each Title may have one or more Chapters.
- Playback stops at the end of each Title.

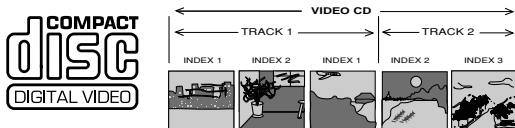

- Video CDs may have one or more Tracks, and each Track may have one or more Indexes.
- To make easy and convenient access, you can move between Tracks and Indexes.
- Some Video CDs have Play Back Control (PBC), which is a predefined playback sequence stored on the disc (refer to "Special VCD/SVCD features").

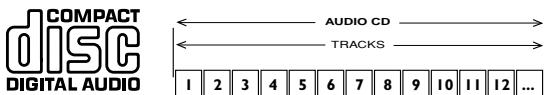

- Audio CDs contain only Tracks.

Basic playback

CAUTION!

- Do not move the disc player during playback, as doing so may damage the DVD system.
- Do not push on the disc tray or put any objects other than disc on the disc tray. Doing so may cause the disc player malfunction.

- 1 Press **STANDBY ON** \odot or **POWER** \odot to switch the system on.
 - 2 Press **OPEN/CLOSE** \blacktriangle to open the disc tray.
 - 3 Load a disc with the label side facing up.
 - 4 Press **OPEN/CLOSE** \blacktriangle again to close the tray.
 - There will be a short delay while the player identifies the disc and reads the menu from the disc.
- Some discs will start playing automatically, and others will display the Disc Contents Menu on the TV screen. If the menu is presented, use \blacktriangle \blacktriangledown \blacktriangleleft \blacktriangleright keys to highlight your selection and press **OK** to confirm. To select a play option, press **numeric keypad (0-9)**.
- 5 Press **▶II** to start playback.

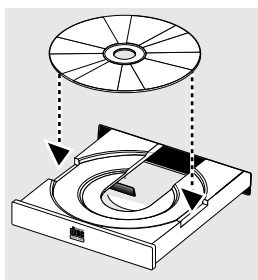

Notes:

- Your player will not play discs that have a region code different from the region code of your player.
-  If the inhibit icon appears on the TV screen when a button is pressed, it means the function is not available on the disc you are playing.

To interrupt playback

- Press **▶II**.
 - The picture freezes and the sound will be muted.
- To resume playback, press **▶II** again.

To stop playback

- Press **■**.

Skipping to another track/chapter

- Press **◀◀** or **▶▶** repeatedly during playback to skip backward or forward. Each press will take the disc to the beginning of the previous or next track/chapter.

Note:

- If the **REPEAT** function has been set, pressing **◀◀** or **▶▶** will replay the same track/chapter.

To skip to the beginning of the current track/chapter during playback

- Press **◀◀** once.

To go directly to any track/chapter

- Use the **numeric keypad (0-9)** to enter the number of the desired track/chapter.

Fast Search

- 1 Hold down **◀◀** or **▶▶** about **two seconds** to fast reverse or forward the disc.
- 2 To resume normal play, press **▶II**.

Continue playback from the last stop point

- In stop mode and when a disc has not been ejected, press **RESUME** to resume playback from the point at which it stopped.

To cancel the resume mode

- Press **■** again.

Notes:

- When the player is disconnected from the power supply or the disc tray is opened, the resume option will be cancelled automatically.
- The resume option may not be available on some discs.

Repeat play

You can only select the repeat play mode during playback.

For DVD - Repeat chapter/title/disc

- Press **REPEAT** repeatedly to select the following :
 - "R- I" – repeat chapter.
 - "R- R" – repeat title/disc.

For VCD/CD/MP3-CD - Repeat track/disc

- Press **REPEAT** repeatedly to select the following :
 - "R- I" – repeat the current track.
 - "R- R" – repeat the entire disc.

Notes:

- Repeat play might not work correctly with some DVDs.
- For VCD, repeat play is not possible during PBC playback.

Repeat A-B

You can play a specific section in a chapter/track repeatedly.

- 1 Press **REPEAT A-B** at your chosen starting point.
- 2 Press **REPEAT A-B** again at your chosen end point.
 - The passage will now repeat continuously.
- 3 To resume normal play, press **REPEAT A-B** again.

Note:

- The section A and B can be set only within the same chapter/track.

Program favorite tracks

You can play the contents of the disc in the order you want by programming the order of the tracks to be played. Up to 99 tracks can be stored.

- 1 While playback is stopped, select or press **PROGRAM** to enter program mode.
 - "P 00:00" is displayed.
- 2 Use the **numeric keypad (0-9)** to input the track number in the order you want.
 - If you attempt to program more than 99 tracks, "FULL" is displayed.
- 3 Press **OK** to store the track.
- Repeat **steps 2-3** to store other tracks.
- 4 To start program play, press **▶II**.
- 5 To stop playback, press **■ once**.
- 6 To cancel the program, press **■ again**.

Program function can also be accessed via the menu bar

- 1 Press **SYSTEM MENU** and select  from the menu bar.
- 2 Repeat **steps 2-6** listed above to program your favorite tracks.

Special DVD/VCD features

A number of operations can be carried out directly via the multiple menu bars on the TV screen without interrupting disc playback.



From the left,
 SETUP MENU → SUBTITLE → LANGUAGE → SLOW
 → FAST REVERSE → FAST FORWARD → STATUS



From the left,
 TITLE SEARCH → CHAPTER SEARCH → TIME
 SEARCH → ZOOM → ANGLE → STEP →
 PBC ON/OFF



From the left,
 PROGRAM

IMPORTANT!

Some operations may be different or restricted, depending on the disc format. Refer to the jacket or case of the disc you are playing.

- 1 Press **SYSTEM MENU**.
 - The menu bar will be displayed across the top of the TV screen.
- 2 Press **◀** or **▶** to move through the menu bar.
- 3 Press **▼** to select the highlighted icon and use **▲▼** keys to select your preferred option.
- 4 Press **OK** to confirm a highlighted selection.
- 5 To exit, press **SYSTEM MENU** or **OK**.

Changing subtitle language

This operation works only on DVDs with multiple subtitle languages.

- Select  from the menu bar and press **▼** key to select the desired language.

Changing sound track language

This operation works only on DVDs with multiple soundtrack language.

- Select  from the menu bar and press ▼ key to select the desired language.

For VCD :

- Press ▼ key to select the desired audio channels for sound :
LEFT VOCAL → RIGHT VOCAL → MONO LEFT
→ MONO RIGHT → STEREO → LEFT VOCAL

Note:

– When the desired language is not selected even after pressing the button several times, it means the language is not available on the disc.

Playing in slow motion mode



- 1 Select  from the menu bar and press ▼ key to select the required slow motion speed :
SF x2 → SF x4 → SF x8 → SR x2 → SR x4 → SR x8 → SLOW OFF
(SF) = slow forward
(SR) = slow reverse

For VCD :



- 1 Press ▼ key to select the required slow motion speed :
(forward) : SF x1 → SF x2 → SF x3 → OFF
- 2 To resume normal play, press ►||

Note:

– The sound will be muted during slow-motion play.

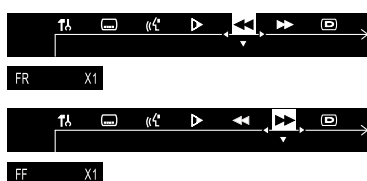
Searching for a particular passage



- 1 Select  or  from the menu bar to select fast reverse search or fast forward search respectively.
- 2 Press ▼ key to select the required search speed :
(reverse) : FR x2 → FR x4 → FR x6 → FR x8 → OFF
(forward) : FF x2 → FF x4 → FF x6 → FF x8 → OFF

For VCD :

- 2 Press ▼ key to select the required search speed :
(reverse) : FR x1 → FR x2 → FR x3 → FR x4 → OFF
(forward) : FF x1 → FF x2 → FF x3 → FF x4 → OFF

- 3 To resume normal play, press ►||

Note:

– The sound will be muted during fast reverse or forward search.

Display the disc information during playback

- Select  from the menu bar and press ▼ key to select the following display informations :

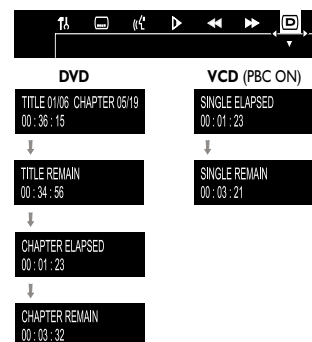

Moving to another title/chapter

Some discs may contain more than one title or chapter. If the disc has a title or chapter menu recorded on it, you can start playback from the selected item.

- 1 Select **T** (title) or **C** (chapter) from the menu bar.
- 2 Use **numeric keypad (0-9)** to select a desired title/ chapter number and press **OK** to start playback.

Note:

– Selecting a title or chapter might not be possible on certain discs.

Playback from a selected point

This function allows you to start playing at any chosen time on the disc.



- 1 Select  from the menu bar.
- 2 Enter hours, minutes and seconds from left to right in the time edit box using the **numeric keypad (0-9)**.
→ Each time an item has been entered, the next item will be highlighted.
- 3 Press ►|| to start playback.

Zooming in

This function allows you to enlarge the picture on the TV screen and to pan through the enlarged image.

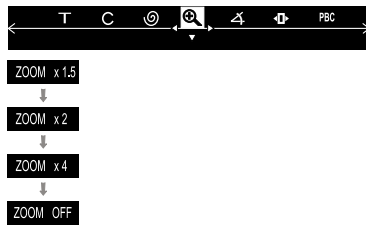

- 1 Select from the menu bar and press key repeatedly to select a zoom factor : x1.5 → x2.0 → x4.0 → OFF.
- 2 To pan through the enlarged image, press **OK** to confirm the zoom selection and use keys to move the zoomed picture left, right, up and down.
- 3 To exit ZOOM mode, select zoom factor to "ZOOM OFF" from the menu bar.

Viewing from another angle

If the disc contains sequences recorded from different camera angles, this allows you to view the picture from different angles. The selections of angle are depending on the disc format.

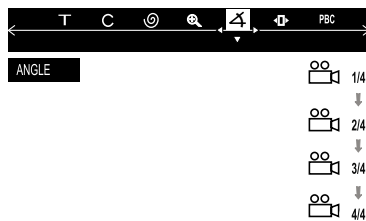

- Select from the menu bar and press keys to select the desired angle : 1/4, 2/4, 3/4 or 4/4.
→ Playback changes to the selected angle.

Advancing by frames



- 1 Select from the menu bar and press key to play the disc step by step (one frame each step).
- 2 To resume normal play, press

Checking the contents of DVD

- 1 Press **DISC MENU** on the remote control.
→ If the current title has a menu, the menu will appear on the screen. Otherwise, the disc menu will be displayed.
- 2 Use keys to select the desired title or chapter, followed by or **OK**.
→ The selected title or chapter starts playing.

Notes:

- The details of operation might differ depending on the DVD disc.
- Selecting a title or disc might not be possible on certain DVD discs.

Special VCD/SVCD features

Playback Control (PBC)

PBC playback allows you to play Video CDs interactively, following the menu on the display.



- Select in the menu bar and press key to select PBC ON or PBC OFF.

When playing a disc with PBC function

- If "PBC OFF", the system will start playback automatically.
- If "PBC ON", the PBC menu (if available) will appear on the TV screen for selection. Use the **numeric keypad (0-9)** to enter your choice.

Note:

- If PBC mode is switched on, TIME SEARCH and REPEAT functions are not available.

Special MP3-CD features

- JPEG format
- Max. 12 characters
- Max. nested directory is 7 levels
- The max. album number is 32
- Supported VBR bit-rate
- Supported sampling frequencies for MP3 disc are :
32 kHz, 44.1 kHz, 48 kHz
- Supported Bit-rates of MP3 disc are: 32, 64, 96, 128,
192, 256 (kbps)
- The disc reading time may exceed 30 seconds due to
the large number of songs compiled onto one disc.

MP3-CD menu

- 1** Press **DISC MENU** to switch on the MP3-CD menu.
→ The album menu appears on the TV screen.
 - 2** To select a desired album, press **▲▼◀▶** and followed by
OK or **▶||** to confirm.
→ The title menu appears on the TV screen.
 - 3** To select a desired title, press **▲▼◀▶** and followed by **OK**
or **▶||** to start playback.
- You can also use the **numeric keypad (0-9)** to enter
your choice.

If the MP3-CD menu is switched off

- You can only play the existing selected title by pressing
▶|| button. While in playback mode, press **◀◀/▶▶** to
select the previous/next title.
→ The title number will be displayed.

Only the following functions are possible for MP3 disc.

- STOP / PLAY / PAUSE / OK
- REPEAT (TITLE/ALBUM/DISC)

Tuning to radio stations

- 1 Press **STANDBY ON** to switch on the last selected source.
- 2 Adjust **SOURCE** (or press **TUNER**) to select TUNER mode.
- 3 Press **TUNER** again to select the desired band : FM or AM.
- 4 Press and hold **◀◀** or **▶▶** until the frequency indication starts to change, then release.
→ The system automatically tunes to the next strong radio station.



- To tune to a weak station, press **◀◀** or **▶▶** briefly and repeatedly until an optimal reception is found.
- 5 Repeat **step 4** if necessary until you find the desired radio station.

Presetting radio stations

You can preset up to 40 stations regardless of the reception.

- 1 Tune to your desired radio station (refer to "Tuning to radio stations").
- 2 Press **PROGRAM**.
→ "Program" appears.



- 3 Use the **numeric keypad (0-9)** to select the desired preset number.



Note:

– If "Program" icon goes off before you select the desired preset number, press **PROGRAM** again.

- 4 Press **PROGRAM** again to store the radio station.
- Repeat **steps 1–4** to store other radio stations.

Notes:

- If you attempt to program more than 40 preset radio stations, "FULL" is displayed.
- During programming, if no key is pressed within five seconds, the system will exit the program mode automatically.

Listening to preset radio stations

- In tuner mode, press **◀** or **▶** or use the **numeric keypad (0-9)** to select the desired preset number.
→ The preset number, radio frequency, and waveband are displayed.

Sleep timer setting

The sleep timer enables the system to switch to standby mode automatically at a preset time.

- 1 Press **SLEEP** repeatedly to select a preset time.
→ The selections are as follows (time in minutes):
15 → 30 → 45 → 60 → 90 → 120 → OFF → 15...



- 2 When you reach the desired length of time, stop pressing the **SLEEP** button.
→ "Sleep" icon appears.

To check the remaining length of time after sleep timer is activated

- Press **SLEEP once**.

To change the preset sleep timer

- Press **SLEEP** again while the remaining sleep timer is shown.
→ The display will show the next sleep timer options.

To deactivate the sleep timer

- Press **SLEEP** repeatedly until "OFF" is displayed, or press the **STANDBY ON** button.

AMPLIFIER SECTION

Output power	
- Stereo mode (DIN)	2 x 50 W
- Surround mode (1 kHz)	50 W RMS/channel
Total Harmonic Distortion	10% at rated power (1 kHz)
Frequency Response	180 Hz – 14 kHz / ±1 dB
Signal-to-Noise Ratio	> 65 dB (CCIR)
Input Sensitivity	400 mV

TUNER SECTION

Tuning Range	FM 87.5 – 108 MHz (100 kHz steps)
	AM 530 – 1700 kHz (10 kHz steps)
26 dB Quieting Sensitivity	FM 20 dB
26 dB Quieting Sensitivity	AM 5000 μ V/m
Image Rejection Radio	FM 25 dB
	AM 28 dB
IF Rejection Ratio	FM 60 dB
	AM 24 dB
Signal-to-Noise Ratio	FM 55 dB
	AM 35 dB
AM Suppression Ratio	FM 30 dB
Harmonic Distortion	FM Mono 3%
	FM Stereo 3%
	AM 5%
Frequency Response	FM 180 Hz – 10 kHz / ±6 dB
Stereo Separation	FM 26 dB (1 kHz)
Stereo Threshold	FM 23.5 dB

DVD SECTION

Laser Type	Semiconductor
Disc Diameter	12cm / 8cm
Video Decoding	MPEG-2
Video DAC	10 Bits
Signal System	PAL / NTSC
Video Format	4:3 / 16:9
Video S/N	56 dB (minimum)
Composite Video Output	1.0 Vp-p, 75 Ω
S-Video Output	Y - 1.0 Vp-p, 75 Ω
	C - 0.286 Vp-p, 75 Ω
Audio DAC	Direct Digital Amplification
Frequency Response	4 Hz – 20 kHz (44.1 kHz)
	4 Hz – 22 kHz (48 kHz)
	4 Hz – 44 kHz (96 kHz)
Digital Output	SPDIF Coaxial & Optical

MISCELLANEOUS

Power Supply Rating	120 V / 60 Hz
Power Consumption	160 W
Dimensions (w x h x d)	435 mm x 78 mm x 360 mm
	17.1 x 3.1 x 14.2 (inch)
Weight	5.1 kg
	11.2 pounds

IR REMOTE CONTROL

Effective Range	> 8 Meters
Number of Keys	45
Battery (1.5V)	AA x 2

SPEAKERS

Front speakers / surround speaker

System	2-way shielded
Impedance	8 Ω
Speaker drivers	3" full range, 1" piezo
Dimensions (w x h x d)	96 mm x 155 mm x 95 mm
	3.78 x 6.10 x 3.74 (inch)
Weight	0.45 kg/each
	0.99 pounds/each

Center speaker

System	5 multi directional driver
Impedance	8 Ω
Speaker drivers	4 x 2" woofer, 1 3/4" tweeter
Dimensions (w x h x d)	435 mm x 72 mm x 63.5 mm
	17.13 x 2.83 x 2.5 (inch)
Weight	1.32 kg
	2.90 pounds

SUBWOOFER

Subwoofer (not magnetically shielded design)	6.5"
Output power	50 W (4 Ω , DIN)
THD	10% at 55 Hz
Reproduction frequency response	40 Hz – 150 Hz
Phase switch	0°, 180°
Input sensitivity (Subwoofer In)	500 mVrms
AC power	120 V / 60 Hz
Power Consumption	32 W (at 1/8 Rated Power)
Dimensions (w x h x d)	200 mm x 310 mm x 350 mm
	7.87 x 12.20 x 13.78 (inch)
Weight	6.8 kg
	15.00 pounds

Specifications subject to change without prior notice

Troubleshooting

WARNING!

Under no circumstances should you try to repair the system yourself, as this will invalidate the warranty. Do not open the system as there is a risk of electric shock.

If a fault occurs, first check the points listed below before taking the system for repair. If you are unable to solve a problem by following these hints, consult your dealer or service center.

Problem	Solution
No power.	<ul style="list-style-type: none">– Check if the AC power cord is properly connected.
No picture.	<ul style="list-style-type: none">– Select the appropriate video input mode on the TV.– Check if the TV is switched on.– Check the video connection.– Set your TV to the correct Video In channel. These channels are usually near channel 00. Or, you may have a button on the TV remote control that selects Auxiliary or A/V IN channel. See your TV owner's manual for details. Or, change channels at the TV until you see DVD screen on the TV.
Distorted or poor picture.	<ul style="list-style-type: none">– Sometimes a small amount of picture distortion may appear. This is not a malfunction.– Clean the disc.– Check the video connection. You cannot use S-Video and Component Video connections at the same time.
Completely distorted picture or black/white picture.	<ul style="list-style-type: none">– Make sure the NTSC/PAL setting at the DVD player matches the video signal of your television (see "System Setup (DVD) - Setting the pictures - TV system").
The aspect ratio of the screen cannot be changed even though you have set the TV shape.	<ul style="list-style-type: none">– The aspect ratio is fixed on the DVD disc.– Depending on the TV, it may not allow you to change the aspect ratio.
No sound or distorted sound.	<ul style="list-style-type: none">– Adjust the volume.– Check that the speakers are connected correctly.– Replace the speaker cables.– Check the speaker settings.– The system is in pause, slow motion or fast forward/reverse mode, press PLAY/PAUSE to resume normal play mode.
No sound is heard from the center or rear speakers.	<ul style="list-style-type: none">– Use the CENTER + / - or REAR + / - to adjust the volume level.– Check that the center or rear surround speakers are connected correctly.– Use surround mode and make sure that the source material is recorded or broadcast in Dolby Digital, DTS or Dolby Pro Logic surround sound.
The DVD player does not start playback.	<ul style="list-style-type: none">– Insert a readable disc with the playback side facing down.– Check the disc type, color system and regional code. Check for any scratches or smudges on the disc.– Press SYSTEM MENU to turn off the setup menu screen.– Cancel the parental control rating function or change the rating level.– Moisture has condensed inside the system. Remove the disc and leave the system turned on for about an hour..
The DVD system does not respond when the buttons are pressed.	<ul style="list-style-type: none">– Disconnect the power plug from the outlet and insert again.
The language for the sound or subtitle cannot be changed when playing a DVD.	<ul style="list-style-type: none">– Multi-language sound or subtitle is not recorded on the DVD.– Changing the language for the sound or subtitle is prohibited on the DVD.
No image is output when a function is selected.	<ul style="list-style-type: none">– Make sure the component is connected correctly.– Press the correct function button for the input source.
Considerable noise in radio broadcasts.	<ul style="list-style-type: none">– Tune in the correct frequency.– Connect the antenna.– Route RF (AC-3) and digital cables away from the antenna terminals and wires.– Fully extend the FM wire antenna. Position for best reception and secure to a wall.– Connect an outdoor FM or AM antenna.– Adjust the direction and position for best reception.– Turn off the equipment causing the noise or move it away from the DVD system.– Place the antenna farther away from the equipment causing the noise.
The remote control does not function.	<ul style="list-style-type: none">– Point the remote control at the remote sensor of the unit.– Reduce the distance to the player.– Remove any possible obstacles.– Replace the batteries with new ones.– Check that the batteries are loaded correctly.
The display is dark.	<ul style="list-style-type: none">– Press DIM again.
Low hum or buzz sound.	<ul style="list-style-type: none">– Place the DVD system as far away as possible from electric devices with interference.
Low bass response.	<ul style="list-style-type: none">– Check all speakers for correct polarity.

LIMITED WARRANTY

AUDIO SYSTEM

One Year Free Labor

One Year Free Service on Parts

This product must be carried in for repair.

WHO IS COVERED?

You must have proof of purchase to receive warranty service. A sales receipt or other document showing that you purchased the product is considered proof of purchase.

WHAT IS COVERED?

Warranty coverage begins the day you buy your product. For one year thereafter, all parts will be repaired or replaced, and labor is free. After one year from the day of purchase, you pay for the replacement or repair of all parts, and for all labor charges. All parts, including repaired and replaced parts, are covered only for the original warranty period. When the warranty on the product expires, the warranty on all replaced and repaired parts also expires.

WHAT IS EXCLUDED?

Your warranty does not cover:

- labor charges for installation or setup of the product, adjustment of customer controls on the product, and installation or repair of antenna systems outside of the product.
- product repair and/or part replacement because of misuse, accident, unauthorized repair or other cause not within the control of Philips.
- reception problems caused by signal conditions or cable or antenna systems outside the unit.
- a product that requires modification or adaptation to enable it to operate in any country other than the country for which it was designed, manufactured, approved and/or authorized, or repair of products damaged by these modifications.
- incidental or consequential damages resulting from the product. (Some states do not allow the exclusion of incidental or consequential damages, so the above exclusion may not apply to you. This includes, but is not limited to, prerecorded material, whether copyrighted or not copyrighted.)
- a product that is used for commercial or institutional purposes.

WHERE IS SERVICE AVAILABLE?

Warranty service is available in all countries where the product is officially distributed by Philips. In countries where Philips does not distribute the product, the local Philips service organization will attempt to provide service (although there may be a delay if the appropriate spare parts and technical manual(s) are not readily available).

MAKE SURE YOU KEEP...

Please keep your sales receipt or other document showing proof of purchase. Attach it to this owner's manual and keep both nearby. Also keep the original box and packing material in case you need to return your product.

BEFORE REQUESTING SERVICE...

Please check your owner's manual for assistance. If you have additional questions, call us at 1-800-531-0039.

TO GET WARRANTY SERVICE IN U.S.A., PUERTO RICO, OR U.S. VIRGIN ISLANDS...

Take the product to a Philips factory service center (see enclosed list) or authorized service center for repair. When the product has been repaired, you must pick up the unit at the center. Centers may keep defective parts. (In U.S.A., Puerto Rico, and U.S. Virgin Islands, all implied warranties, including implied warranties of merchantability and fitness for a particular purpose, are limited in duration to the duration of this express warranty. But, because some states do not allow limitations on how long an implied warranty may last, this limitation may not apply to you.)

TO GET WARRANTY SERVICE IN CANADA...

Please contact Philips at:

1-800-661-6162 (French Speaking)
1-800-531-0039 (English or Spanish Speaking)

(In Canada, this warranty is given in lieu of all other warranties. No other warranties are expressed or implied, including any implied warranties of merchantability or fitness for a particular purpose. Philips is not liable under any circumstances for any direct, indirect, special, incidental or consequential damages, howsoever incurred, even if notified of the possibility of such damages.)

REMEMBER...

Please record below the model and serial numbers found on the product. Also, please fill out and mail your warranty registration card promptly. It will be easier for us to notify you if necessary.

MODEL # _____

SERIAL # _____

This warranty gives you specific legal rights. You may have other rights which vary from state/province to state/province.

Philips, P.O. Box 520890, Miami, FL 33152, USA, (402) 536-4171

EL4965E007 / 8-02

Free Manuals Download Website

<http://myh66.com>

<http://usermanuals.us>

<http://www.somanuals.com>

<http://www.4manuals.cc>

<http://www.manual-lib.com>

<http://www.404manual.com>

<http://www.luxmanual.com>

<http://aubethermostatmanual.com>

Golf course search by state

<http://golfingnear.com>

Email search by domain

<http://emailbydomain.com>

Auto manuals search

<http://auto.somanuals.com>

TV manuals search

<http://tv.somanuals.com>