



PHILIPS

12nc: 3139 115 22081
Printed in China

Quick Use Guide

MX5500

Use this simple and quick way to watch your favorite DVD movie and enjoy your Home Cinema experience!

IMPORTANT!

Attach the front speakers and the rear (surround) speakers to the mini speaker stands before making the connections to the DVD system. Refer to owner's manual for detailed set up instructions.

Recommended Speaker Setup

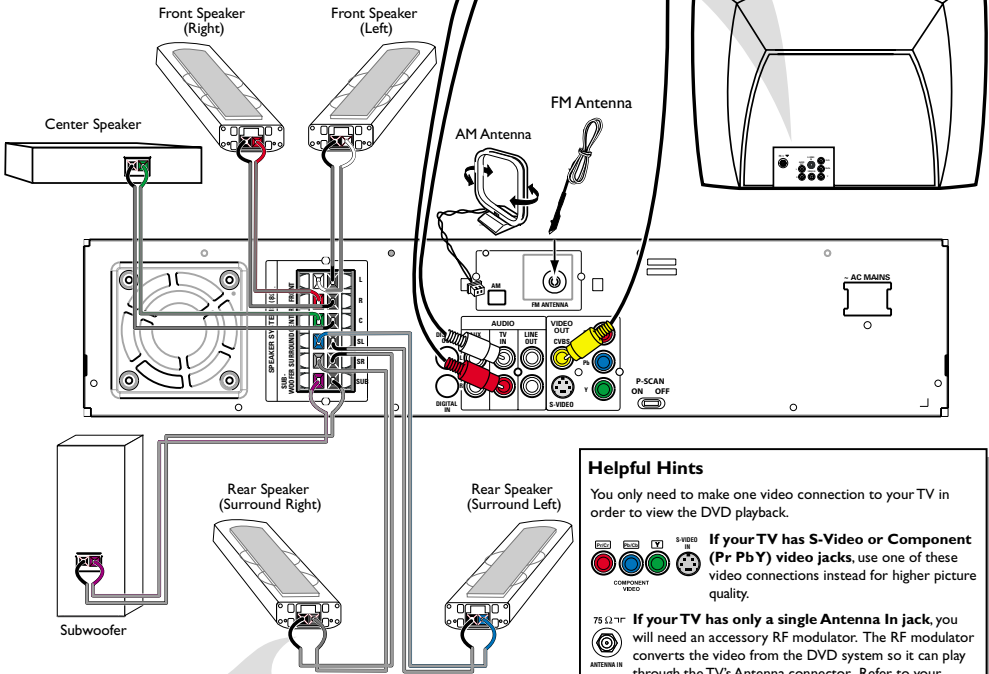
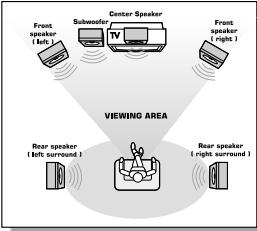

Connecting Speaker Cable

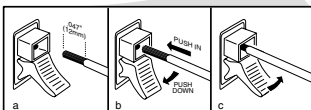

Helpful Hints

You only need to make one video connection to your TV in order to view the DVD playback.

If your TV has S-Video or Component (Pr Pb Y) video jacks, use one of these video connections instead for higher picture quality.



If your TV has only a single Antenna In jack, you will need an accessory RF modulator. The RF modulator converts the video from the DVD system so it can play through the TV's Antenna connector. Refer to your owner's manual for proper connection.



Do not switch the P-SCAN to 'ON' position, unless you have connected the DVD system to a Progressive Scan TV using the Component (Pr Pb Y) video jacks.

When listening to TV programs, press TV/AV button on the remote to set the DVD system to TV/AV mode in order for the sound to be heard.

continue...

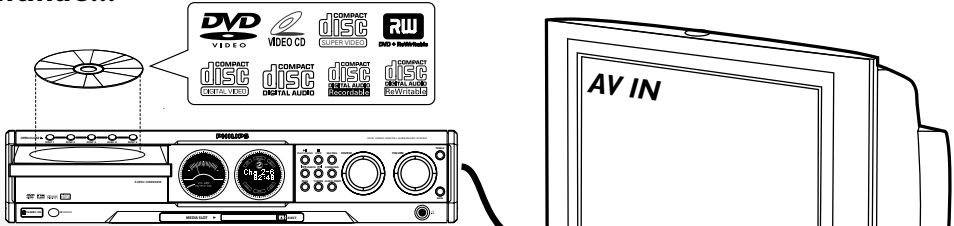

Make sure your DVD system and TV are connected and turned on!

Playing a disc

1 Press DISC/MEDIA on the remote control.

You can also adjust the SOURCE button on the front panel until "DISC X" appears on the display panel.

2 Turn on the TV and select the correct Video In mode.

You should see the blue Philips DVD background screen on the TV (if no disc in the DVD system). Usually this channel is between the lowest and highest channels and may be called FRONT, A/V IN, or VIDEO.

Or, you may go to channel 1 on your TV, then press the Channel down button repeatedly until you see the Video In channel.

Or, your TV remote control may have a button or switch that chooses different video modes.

Do not use channel 3 or 4 on the TV unless you are using an RF modulator.

See your TV manual for more details.

3 Press OPEN-CLOSE ▲ on the front of the DVD system and load a disc, then press the corresponding OPEN-CLOSE ▲ again to close the disc tray.

Make sure the disc label is facing up. For double-sided discs, load the side you want to play face up.

4 Playback will start automatically.

If a disc menu appears, use ▲▼◀▶ buttons on the remote to make the necessary selection, then press OK to confirm. Or, use the numeric keypad on the remote to select features. Follow the instructions given in the disc menu.

5 To stop playback, press STOP ■.

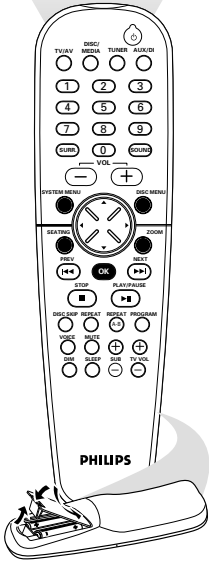

Region Codes











DVDs must be labeled for ALL regions or for Region 1 in order to play on this DVD system.



Helpful Hints

If a DVD does not play properly, please contact Philips at 1-800-531-0039 for assistance. Due to the inconsistency of disc formats provided by various disc manufacturers, your DVD system may require a playability enhancement or upgrade. As DVD technology advances, these enhancements will become common and will be easy to complete.

You should find the below accessories in the packaging box. If not, call Philips at 1-800-531-0039. (Not all the cables supplied are required to complete the basic hook-up.)

Speaker cables  (5x)	Component video cables (red, blue, green) 	AA size batteries 	Mini speaker stands and screws  (4x) (8x)
Subwoofer cable 	Audio cables (white, red) 	FM wire antenna 	Brackets and screws  (4x)
Composite video cable (yellow) 	AM loop antenna 	AC power cable 	



Detailed playback features and additional functions are described in the accompanying owner's manual.

DVDVIDEO DIGITAL SURROUND SYSTEM

MX5500D



Need help? Call us!

Philips representatives are ready to help you with any questions about your new product. We can guide you through Connections, First-time Setup, or any of the Features. We want you to start enjoying your new product right away!

**CALL US BEFORE YOU CONSIDER
RETURNING THE PRODUCT!**

1-800-531-0039

or

Visit us on the web at www.philips.com



PHILIPS

Canada

English:

This digital apparatus does not exceed the Class B limits for radio noise emissions from digital apparatus as set out in the Radio Interference Regulations of the Canadian Department of Communications.

Français:

Cet appareil numérique n'émet pas de bruits radioélectriques dépassant les limites applicables aux appareils numériques de Class B prescrites dans le Règlement sur le Brouillage Radioélectrique édicté par le Ministère des Communications du Canada.

CAUTION

Use of controls or adjustments or performance of procedures other than herein may result in hazardous radiation exposure or other unsafe operation.

ATTENTION

L'utilisation des commandes ou réglages ou le non-respect des procédures ci-incluses peuvent se traduire par une exposition dangereuse à l'irradiation.

ATENCIÓN

El uso de mando o ajustes o la ejecución de métodos que no sean los aquí descritos puede ocasionar peligro de exposición a radiación.

This warning label is located on the rearside and inside this laser product.

CAUTION: INVISIBLE LASER RADIATION WHEN OPEN. DO NOT STARE INTO BEAM.
DANGER: INVISIBLE LASER RADIATION WHEN OPEN. AVOID DIRECT EXPOSURE TO BEAM.
VARO! AVATTAESSA JA SUOJALUKITUS OHITETTAESSA, OLET ALTTIINANAKYMATTOMAALLE LASERSATEILYLLE. ÄLÄ KÄTSO SATEESEEN.
WARNING! OSYNLIG LASERSTRÅLNING NÄR DENNA DEL ÄR ÖPPNAD. OCH SPÄRREN ÄR URKOPPLAD. BETRakta EJ STRÅLEN.

or

DANGER - Invisible laser radiation when open.
AVOID DIRECT EXPOSURE TO BEAM.

This product incorporates copyright protection technology that is protected by method claims of certain U.S. patents and other intellectual property rights owned by Macrovision Corporation and other rights owners. Use of this copyright protection technology must be authorized by Macrovision Corporation, and is intended for home and other limited viewing uses only unless otherwise authorized by Macrovision Corporation. Reverse engineering or disassembly is prohibited.

Manufactured under license from Dolby Laboratories. "Dolby", "Pro-Logic" and the double-D symbol are trademarks of Dolby Laboratories. Confidential Unpublished Works. ©1992-1997 Dolby Laboratories, Inc. All rights reserved.

Manufactured under license from Digital Theater Systems, inc. US Pat. No. 5,451,942 and other worldwide patents issued and pending. "DTS" and "DTS Digital Surround" are trademarks of Digital Theater Systems, Inc. 1996 Digital Theater Systems, Inc. All rights reserved.

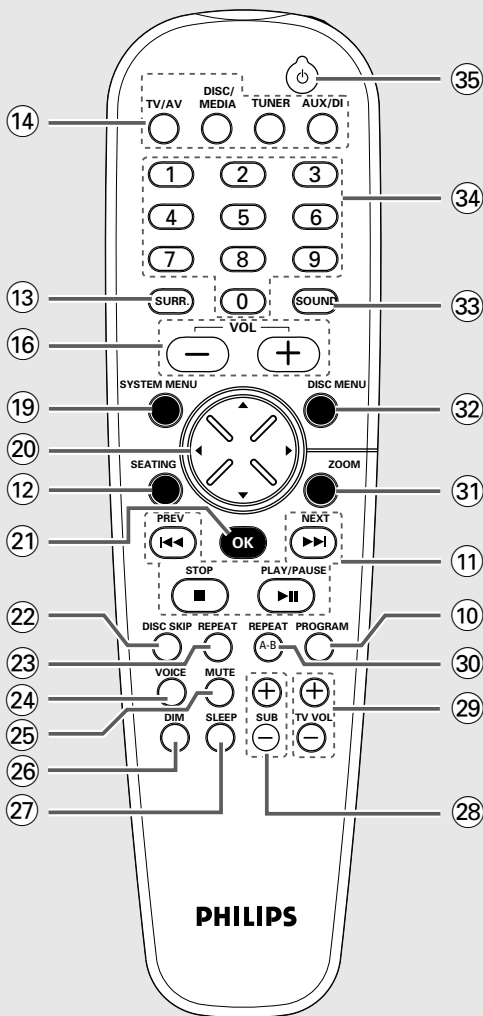
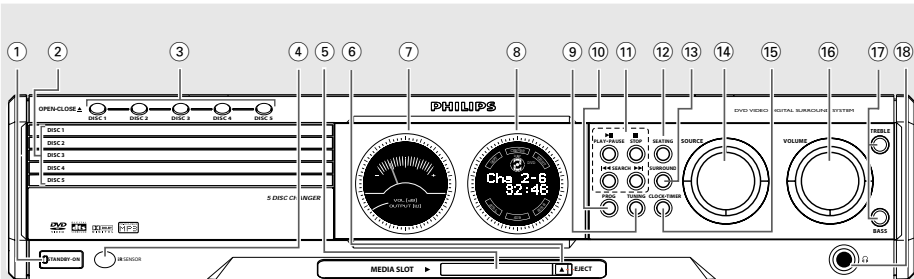

Return your Warranty Registration card today to ensure you receive all the benefits you're entitled to.

- Once your Philips purchase is registered, you're eligible to receive all the privileges of owning a Philips product.
- So complete and return the Warranty Registration Card enclosed with your purchase at once, and take advantage of these important benefits.

Warranty Verification

Registering your product within 10 days confirms your right to maximum protection under the terms and conditions of your Philips warranty.

Owner Confirmation

Your completed Warranty Registration Card serves as verification of ownership in the event of product theft or loss.

Model Registration

Returning your Warranty Registration Card right away guarantees you'll receive all the information and special offers which you qualify for as the owner of your model.

Know these *safety* symbols



 This "bolt of lightning" indicates uninsulated material within your unit may cause an electrical shock. For the safety of everyone in your household, please do not remove product covering.

 The "exclamation point" calls attention to features for which you should read the enclosed literature closely to prevent operating and maintenance problems.

For Customer Use

Enter below the Serial No. which is located on the rear of the cabinet. Retain this information for future reference.

Model No. _____

Serial No. _____

WARNING: TO PREVENT FIRE OR SHOCK HAZARD, DO NOT EXPOSE THIS EQUIPMENT TO RAIN OR MOISTURE.

CAUTION: To prevent electric shock, match wide blade of plug to wide slot, and fully insert.



PHILIPS

***Congratulations on your purchase,
and welcome to the “family!”***

Dear Philips product owner:

Thank you for your confidence in Philips. You've selected one of the best-built, best-backed products available today. And we'll do everything in our power to keep you happy with your purchase for many years to come.

As a member of the Philips “family,” you're entitled to protection by one of the most comprehensive warranties and outstanding service networks in the industry.

What's more, your purchase guarantees you'll receive all the information and special offers for which you qualify, plus easy access to accessories from our convenient home shopping network.

And most importantly you can count on our uncompromising commitment to your total satisfaction.

All of this is our way of saying welcome – and thanks for investing in a Philips product.

Sincerely,

Lawrence J. Blanford
President and Chief Executive Officer

P.S. Remember, to get the most from your Philips product, you must return your Warranty Registration Card within 10 days. So please mail it to us right now!

IMPORTANT SAFETY INSTRUCTIONS

1. Read these instructions.
2. Keep these instructions.
3. Heed all warnings.
4. Follow all instructions.
5. Do not use this apparatus near water.
6. Clean only with dry cloth.
7. Do not block any ventilation openings. Install in accordance with the manufacturer's instructions.
8. Do not install near any heat sources such as radiators, heat registers, stoves, or other apparatus (including amplifiers) that produce heat.

9. Do not defeat the safety purpose of the polarized or grounding-type plug.

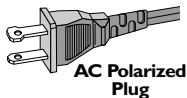

A polarized plug has two blades with one wider than the other. A grounding type plug has two blades and a third grounding prong. The wide blade or the third prong are provided for your safety. If the provided plug does not fit into your outlet, consult an electrician for replacement of the obsolete outlet.

10. Protect the power cord from being walked on or pinched, particularly at plugs, convenience receptacles, and the point where they exit from the apparatus.
11. Only use attachments/accessories specified by the manufacturer.

12.  Use only with the cart, stand, tripod, bracket, or table specified by the manufacturer or sold with the apparatus. When a cart is used, use caution when moving the cart/apparatus combination to avoid injury from tip-over.

13. Unplug this apparatus during lightning storms or when unused for long periods of time.
14. Refer all servicing to qualified service personnel. Servicing is required when the apparatus has been damaged in any way, such as power-supply cord or plug is damaged, liquid has been spilled or objects have fallen into the apparatus, the apparatus has been exposed to rain or moisture, does not operate normally, or has been dropped.

15. Battery usage **CAUTION** – To prevent battery leakage which may result in bodily injury, property damage, or damage to the unit:

- Install **all** batteries correctly, + and - as marked on the unit.
- Do not mix batteries (**old** and **new** or **carbon** and **alkaline**, etc.).
- Remove batteries when the unit is not used for a long time.

EL 6475-E004: 02/8

WARNING!

To reduce the risk of fire or electric shock, this apparatus should not be exposed to rain or moisture, and objects filled with liquids, such as vases, should not be placed on this apparatus.

Class II equipment symbol



This symbol indicates that the unit has a double insulation system

English 8

Français 52

Español 96

English

Français

Español

Environmental information

All unnecessary packaging has been omitted. We have tried to make the packaging easy to separate into three materials: cardboard (box), polystyrene foam (buffer) and polyethylene (bags, protective foam sheet).

Your system consists of materials which can be recycled and reused if disassembled by a specialized company. Please observe the local regulations regarding the disposal of packaging materials, exhausted batteries and old equipment.

This system complies with the FCC rules, Part 15 and with 21 CFR 1040.10.

Operation is subject to the following two conditions:

- This device may not cause harmful interference, and***
- This device must accept any interference received, including interference that may cause undesired operation.***

General Information

Supplied accessories	10
Care and safety information	10

Connections

Step 1: Set up the speakers	11
Step 2: Placing the speakers and subwoofer ...	11
Step 3: Connecting TV	12
Using Composite Video jack (CVBS)	12
Using Component Video jacks (Pr Pb Y) ...	12
Using S-Video jack	13
Using an accessory RF modulator	13
Step 4: Connecting speakers and subwoofer .	14
Step 5: Connecting FM/AM antennas	14
Step 6: Connecting the power cord	15

Connections (optional)

Connecting a VCR or Cable/Satellite Box	16
Viewing and listening to the playback	16
Using the VCR for recording DVDs	16
Connecting digital audio equipment	17
Listening to the playback	17
Recording (digital)	17

Functional Overview

Main unit and remote control	18–19
Control buttons available on the remote only	19

Getting Started

Step 1: Inserting batteries into the remote control	20
Using the remote control to operate the system	20
Step 2: Setting the clock	20
Step 3: Setting the TV	21
Changing the NTSC/PAL setting via the remote control	21
Selecting the color system that corresponds to your TV	21
Step 4: Selecting speaker layout	22
Changing seating control position	22
Setting the speakers' channels	23
Step 5: Setting language preference	23

Disc Operations

Playable discs	24
Playing discs	24
Turning on/off auto Eco standby mode	25
Using the Disc Menu	25
Basic playback controls	25
Resuming playback from the last stopped point (DVD/VCD)	25
Replacing discs without interrupting playback	25
Selecting various repeat functions	26
Repeat play mode	26
Repeating a section within a chapter/track	26
Program favorite tracks (audio CDs and VCDs)	26–27
Clearing the program	27
Using the menu bar to program	27
Playing MP3/Picture disc (Kodak, JPEG)	28
Program MP3 disc	28

Media Slot Operations

About media slot	29
Playing JPEG pictures from memory card	29

DVD Menu Options

Using the menu bar	30
Using the Setup Menu	31
Setting the TV shape	31
Setting the video output	32
Screen saver - turning on/off	32
Setting the analog output	32
Setting the digital output	33
Setting the PCM output	33
Night mode- turning on/off	34
Restoring the original settings	34
Restricting playback by parental control	35
Changing the password	36

Tuner Operations

Tuning to radio stations	37
Presetting radio stations	37
Using the Plug and Play	37
Automatic presetting	38
Manual presetting	38
Selecting a preset radio station	38
Deleting a preset radio station	38

Timer Operations

Setting the timer	39
Activating/Deactivating the timer	39
Setting the Sleep timer	40

Sound and Volume Controls

Sound Control	41
Selecting surround sound	41
Turning on/off clear voice effect	41
Changing subwoofer volume level	41
Adjusting Bass/Treble level	41
Selecting digital sound effects	41
Volume Control	41

Other Functions

Switching on/off	42
Switching to active mode	42
Switching to Eco Power standby mode	42
Switching to standby mode (view clock)	42
Dimming system's display screen	42
Recording to an external device	42
Using the remote to operate your television	42

Specifications

43

Troubleshooting

44-45

Glossary

46-47

Limited Warranty

48

General Information

Supplied accessories

Speaker cables



Subwoofer cable



Audio cable
(white, red)

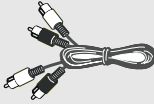

Composite video cable
(yellow)



Component video cables
(red/blue/green)

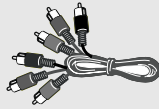

FM wire antenna



AM loop antenna



Remote Control and
two AA batteries

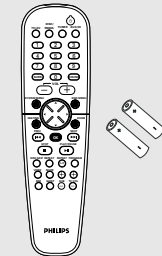

AC power cable



Mini speaker stands
and screws

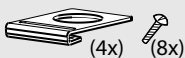

Brackets and screws



Care and safety information

Avoid high temperatures, moisture, water and dust

– Do not expose the system, batteries or discs to humidity, rain, sand or excessive heat (caused by heating equipment or direct sunlight.) Always keep the disc tray closed to avoid dust getting on the lens.

Avoid condensation problem

– The lens may cloud over when the player is suddenly moved from cold to warm surroundings, making it impossible to play a disc. Leave the player in the warm environment until the moisture evaporates.

Do not block the vents

– Do not operate the DVD system in an enclosed cabinet and allow about 10 cm (4 inches) of free space all around the player for adequate ventilation.

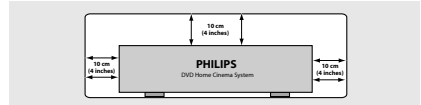

Care of disc

– To clean a CD, wipe it in a straight line from the center towards the edge using a soft, lint-free cloth. Do not use cleaning agents, as they may damage the disc!

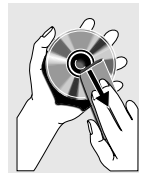

– Write only on the printed side of a CDR(W) and only with a soft felt-tipped pen.
– Handle the disc by its edge, do not touch the surface.

Care of the cabinet

– Use a soft cloth slightly moistened with a mild detergent solution. Do not use a solution containing alcohol, spirits, ammonia or abrasives.

Finding a suitable location

– Place the player on a flat, hard, stable surface.

Step 1: Set up the speakers

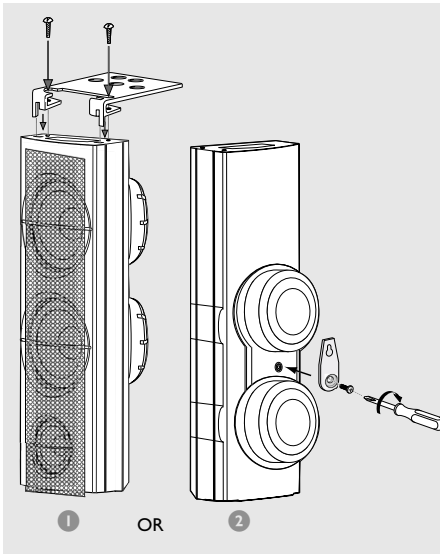

- 1 Before connecting the speakers to the DVD system, firmly attach the mini speaker stands to the front and the surround speakers using the supplied screws.

OR

- 2 Alternatively, you can choose to mount the speakers on the wall. Attach the supplied bracket firmly to the rear of the speakers using the supplied screws. Then mount a screw (not supplied) on the wall where the speaker is to be hung and hook the speaker securely onto the mounted screw.

CAUTION!

You should get a qualified person to attach the brackets to the wall. DO NOT do it by yourself to avoid unexpected damage to the equipment or injury to personnel.

Step 2: Placing the speakers and subwoofer

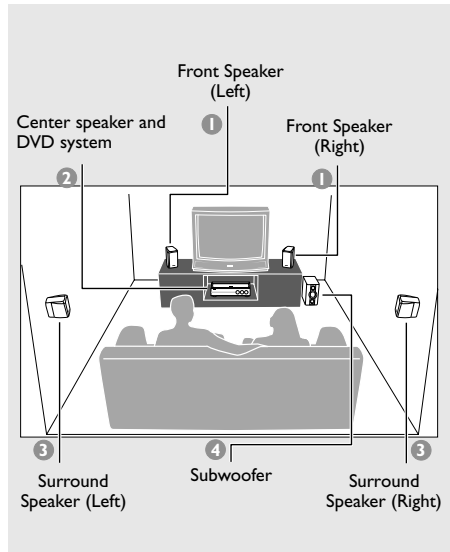

- For best possible surround sound, all the speakers (except the subwoofer) should be placed at the same distance from the listening position.
- 1 Place the front left and right speakers at equal distances from the TV and at an angle of approximately 45 degrees from the listening position.
 - 2 Place the center speaker above the TV or the DVD system so that the center channel's sound is localized.
 - 3 Place the surround speakers at normal listening ear level facing each other or mounted on the wall.
 - 4 Place the subwoofer on the floor near the TV.

Notes:

- To avoid magnetic interference, do not position the front speakers too close to your TV.
- Allow adequate ventilation around the DVD system.

Step 3: Connecting TV

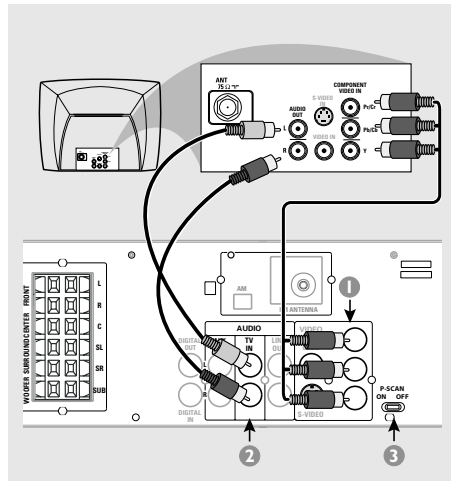
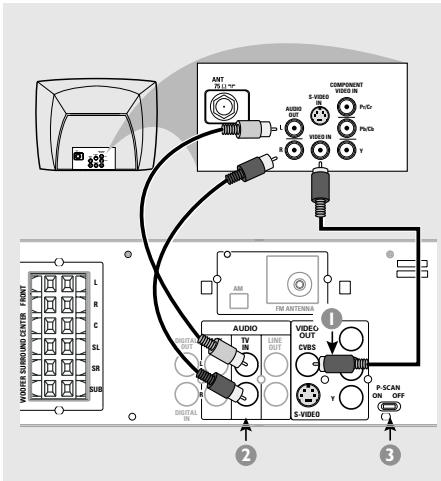

IMPORTANT!

- You only need to make **one** video connection from the following options, depending on the capabilities of your TV system.
- **S-Video or Component Video** connection provides higher picture quality. These options must be available on your TV.
- Connect the DVD system directly to the TV.

Using Composite Video jack (CVBS)

- 1 Use the composite video cable (yellow) to connect the DVD system's **CVBS** jack to the video input jack (or labeled as A/V In, Video In, Composite or Baseband) on the TV.
- 2 To hear the TV channels through this DVD system, use the audio cables (white/red) to connect **TV IN (L/R)** jacks to the corresponding **AUDIO OUT** jacks on the TV.
- 3 Set the **P-SCAN** switch to '**OFF**'.

IMPORTANT!

- If both **S-Video and Component (Pr Pb Y)** Video connections are used to connect to your TV, the video signal will automatically switch to **S-Video** when you power up the DVD system. To set the **VIDEO OUT(put)** to '**Pr Pb Y**', see page 32.
- The progressive scan video quality is only possible through **Component Video (Pr Pb Y)** output.

Using Component Video jacks (Pr Pb Y)

- 1 Use the component video cables (red/blue/green) to connect the DVD system's **Pr Pb Y** jacks to the corresponding Component video input jacks (or labeled as Pr/Cr Pb/Cb Y or YUV) on the TV.
- 2 To hear the TV channels through this DVD system, use the audio cables (white/red) to connect **TV IN (L/R)** jacks to the corresponding **AUDIO OUT** jacks on the TV.
- 3 If you are using a Progressive Scan TV (TV must indicate Progressive Scan or ProScan capability) set the **P-SCAN** switch to '**ON**'. Otherwise, set it to '**OFF**'.

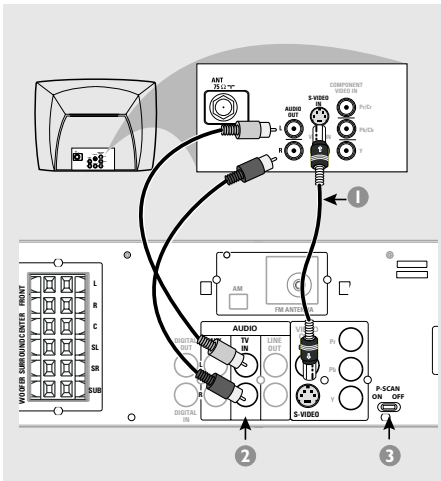

IMPORTANT!

– If the picture is distorted, check the **Video Output** setting. Make sure it is set to 'S-Video,' see page 32.

Using S-Video jack

- 1 Use the S-video cable (not supplied) to connect the DVD system's **S-VIDEO OUT** jack to the S-Video input jack (or labeled as Y/C or S-VHS) on the TV.
- 2 To hear the TV channels through this DVD system, use the audio cables (white/red) to connect **TV IN (L/R)** jacks to the corresponding **AUDIO OUT** jacks on the TV.
- 3 Set the **P-SCAN** switch to 'OFF'.

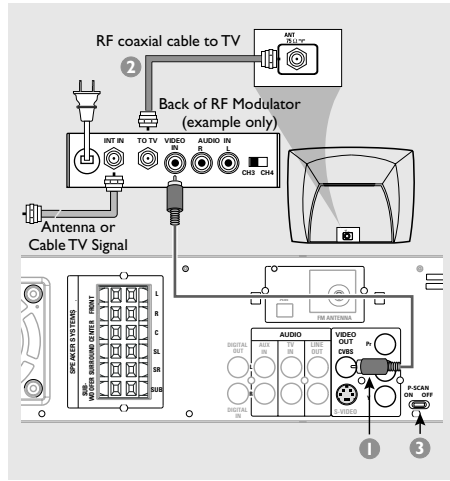

IMPORTANT!

– If your TV only has a single Antenna In jack (or labeled as 75 ohm or RF In,) you will need an RF modulator in order to view the DVD playback on the TV. See your electronics retailer or contact Philips for details on RF modulator availability and operations.

Using an accessory RF modulator

- 1 Use the composite video cable (yellow) to connect the DVD system's **VIDEO OUT** jack to the video input jack on the RF modulator.
- 2 Use the RF coaxial cable (not supplied) to connect the RF modulator to your TV's RF jack.
- 3 Set the **P-SCAN** switch to 'OFF'.

Step 4: Connecting speakers and subwoofer

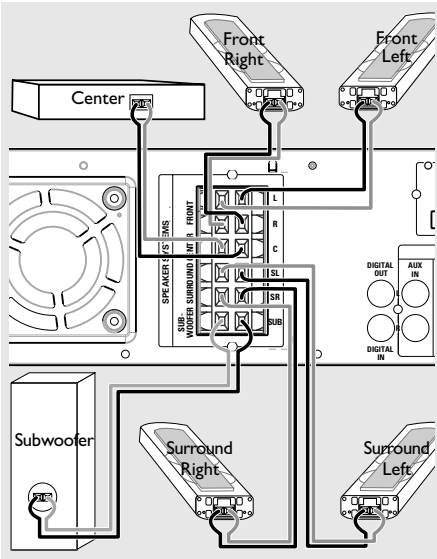

Connect the supplied speaker systems using the supplied speaker cables by matching the colors of the jacks and speaker cables. Fully insert the stripped portion of the speaker wire into the jacks.

Speakers / Subwoofer	⊖	⊕
Front Left (FL) (L)	black	white
Front Right (FR) (R)	black	red
Center (C)	black	green
Surround Left (SL)	black	blue
Surround Right (SR)	black	gray
Subwoofer (SUB)	black	purple

Notes:

- Ensure that the speaker cables are correctly connected. Improper connections may damage the system due to short-circuit.
- Do not connect more than one speaker to any one pair of $+/-$ speaker jacks.
- Do not connect speakers with an impedance lower than the speakers supplied. Please refer to the SPECIFICATIONS section of this manual.

Step 5: Connecting FM/AM antennas

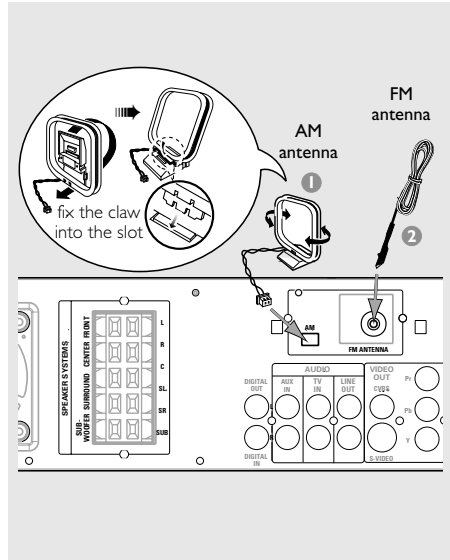

- 1 Connect the supplied AM loop antenna to the **AM** jack. Place the AM loop antenna on a shelf or attach it to a stand or wall.
- 2 Connect the supplied FM antenna to the **FM** jack. Extend the FM antenna and fix its ends to the wall.

For better FM stereo reception, connect an external FM antenna (not supplied.)

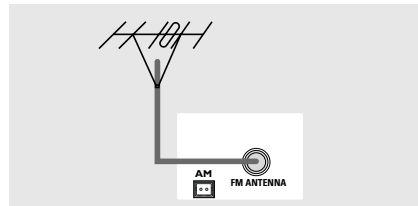

Notes:

- Adjust the position of the antennas for optimal reception.
- Position the antennas as far as possible from your TV, VCR or other radiation source to prevent unwanted interference.

Step 6: Connecting the power cord

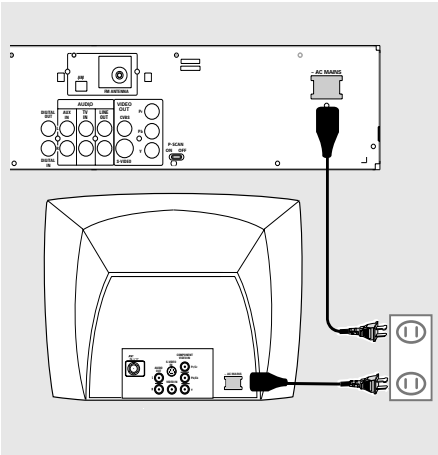

After everything is connected properly, plug in the AC power cord to the power outlet.

Never make or change any connections with the power switched on.

On the DVD system,

"AUTO INSTALL - PRESS PLAY" may appear on the display panel. Press **▶||** on the front panel to store all available radio stations or press **■** to exit (see page 37 "Tuner Operations").

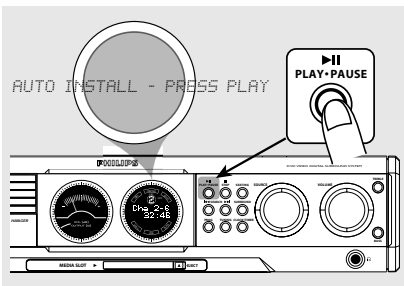

Connections (optional)

Connecting a VCR or Cable/Satellite Box

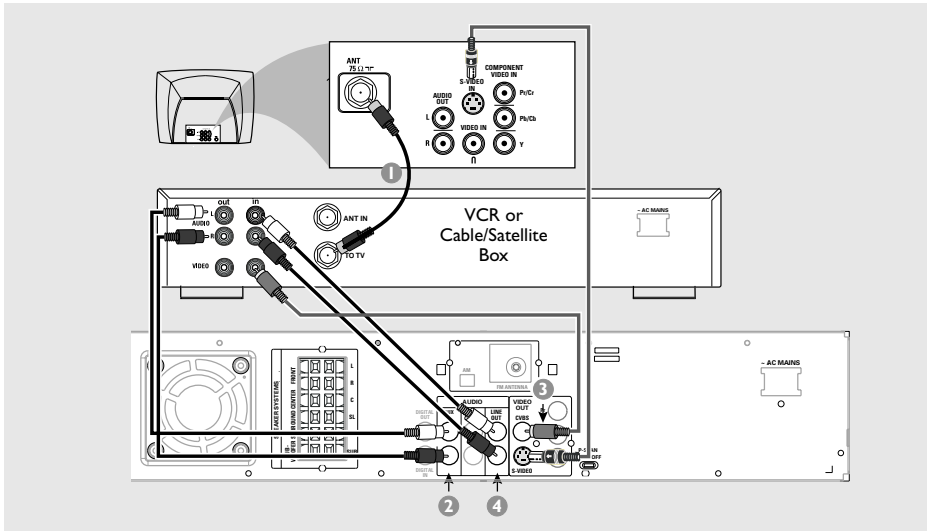

Viewing and listening to the playback

- 1 Connect the VCR or Cable/Satellite Box to the TV as shown.
- 2 Connect the DVD system's **AUX IN (R/L)** jacks to the AUDIO OUT jacks on the VCR or cable/satellite box.

Before starting operation, press **AUX/DI** on the remote to select "AUX" in order to activate the input source.

Using the VCR for recording DVDs

- Some DVDs are copy-protected. You cannot record or dub protected discs using a VCR.
- 3 Connect the DVD system's **CVBS** jack to the VIDEO IN jack on the VCR.
 - 4 Connect the DVD system's **LINE OUT (R/L)** jacks to the AUDIO IN jacks on the VCR. This will allow you to make analog stereo (two channel, right and left) recordings.

To view DVD playback while recording, you must connect the DVD system to your TV using the S-VIDEO (as shown above) or the Component (Pr Pb Y) video connection.

Connecting digital audio equipment

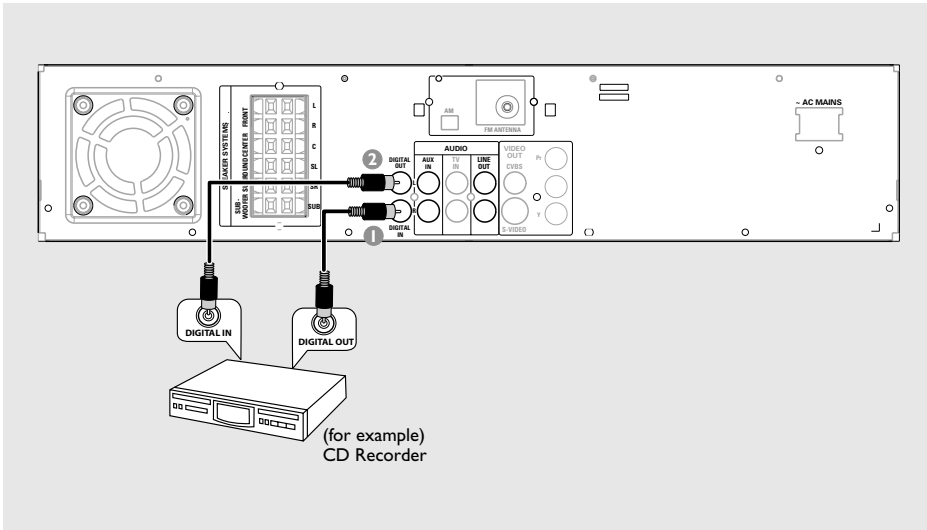

Listening to the playback

- 1 Connect the DVD system's **DIGITAL IN** jack to the DIGITAL OUT jack on a digital audio device.

Before starting operation, press **AUX/DI** on the remote to select "DI" in order to activate the input source.

Recording (digital)

- 2 Connect the DVD system's **DIGITAL OUT** jack to the DIGITAL IN jack on a digital recording device (DTS-Digital Theater System compatible, with a Dolby Digital decoder; for example.)

Before starting operation, set the DIGITAL OUTPUT according to the audio connection. (See page 33 "Setting the digital output".)

Notes:

- Some DVDs are copy-protected. You cannot record the disc through a VCR or digital recording device.
- Always refer to the owner's manual of the other equipment for complete connection and usage details.

Functional Overview *(illustrations on page 3)*

Main unit and remote control

① STANDBY ON

- Switches to Eco Power standby mode or turns on the system. (see page 42)
- *Switches to standby mode. (see page 42)

② Disc trays 1~5

③ OPEN•CLOSE ▲ (DISC1~5)

- Opens/Closes the individual disc tray.

④ iR SENSOR

- Point the remote control towards this sensor.

⑤ MEDIA SLOT

- Plug the memory card into the PC card adaptor and insert it into the media slot for viewing. (see page 29)

⑥ EJECT ▲

- Ejects the memory card from the slot.

⑦ Speaker display panel

⑧ System display panel

⑨ TUNING

- Switches between frequency tuning and preset tuning mode. (see pages 37-38)

⑩ PROG (PROGRAM)

- DISC: starts programming. (see pages 26-27)
- TUNER: starts *automatic/ manual preset programming. (see page 38)
- CLOCK: selects 12- or 24-hour clock display. (see page 20)

⑪ ► II PLAY•PAUSE

- DISC: starts/pauses playback. (see page 25)
- TUNER: *enters Plug & Play mode and/or starts preset radio station installation (only on the main unit.) (see page 37)

■ STOP

- Exits an operation.
- DISC: stops playback or *clears a program. (see page 25, 27)
- TUNER: *erases a preset radio station. (see page 38)

◀◀ SEARCH ▶▶ (PREV/NEXT)

- DISC: *searches backward/forward or selects a track. (see page 25)
- TUNER: tunes the radio frequency up/down or selects a preset radio station. (see pages 37-38) (On the remote, it can only tunes the radio frequency up/down.)
- CLOCK: sets the minutes and hours. (see pages 20, 39)

⑫ SEATING (only available in Multi-channel mode)

- Turns on/off the seating control diagram on the TV. Use the VOLUME control on the main unit or joystick on the remote to select the desired seating position. (see page 22)

⑬ SURROUND (Surr.)

- Selects multichannel surround, 3D sound or stereo mode. (see page 41)

⑭ SOURCE

- Selects the relevant active mode :TV/AV, DISC, MEDIA SLOT, TUNER, AUX or DI.
- DISC: toggles between DISC and MEDIA SLOT.
- TUNER: toggles between FM and AM band.
- AUX/DI: toggles between AUX and DI (Digital Input) mode.

⑮ CLOCK•TIMER

- *Enters clock or timer setting mode. (see pages 20, 39)
- Shows clock display for a few seconds. (see page 20)

* = Press and hold the button for more than two seconds.

16 VOLUME (VOL + -)

- Adjusts the volume level.

17 BASS / TREBLE

- Selects bass or treble sound. Use the VOLUME control to select the desired enhancement level. (see page 41)

18 

- Plugging in the headphones jack. The speakers output will be cancelled.

Control buttons available on the remote only

19 SYSTEM MENU (DVD mode only)

- Enters or exits system setup menu. (see pages 30, 31)

20 Joystick ◀ ▶ ▲ ▼

- Selects movement direction in the menu.
- Use ◀ ▶ to select a preset radio station. (see page 38)

21 OK

- Confirms a selection.

22 DISC SKIP

- Selects next disc tray for playback. (see page 25)

23 REPEAT

- Selects various repeat modes. (see page 26)

24 VOICE (only available in Multi-channel mode)

- Turns on/off clear voice sound effect. (see page 41)

25 MUTE

- Mutes or restores the volume. (see page 41)

26 DIM

- Turns on/off the dim mode. (see page 42)

27 SLEEP

- Sets the sleep timer function. (see page 40)

28 SUB + -

- Adjusts subwoofer's sound level. (see page 41)

29 TVVOL + -

- Adjusts TV volume (Philips TV only). (see page 42)

30 REPEAT A-B

- Repeats a specific section on a disc. (see page 26)

31 ZOOM

- Enlarges a picture on the TV screen.

32 DISC MENU

- Enters or exits disc contents menu. (see page 25)
- For VCD version 2.0 only; In stop mode, turns on/off playback control (PBC) mode. During playback, returns to main menu.

33 SOUND

- Selects a sound effect. (see page 41)

34 Numeric Keypad (0-9)

- Enters a track/title number of the disc.
- Enters a number of a preset radio station.

35 

- Switches to Eco Power standby mode. (see page 42)
- *Switches to standby mode. (see page 42)

* = Press and hold the button for more than two seconds.

Getting Started

Step 1: Inserting batteries into the remote control

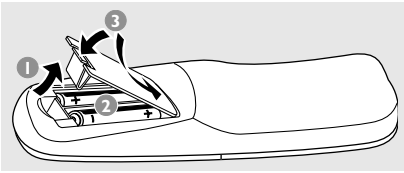

- 1 Open the battery compartment.
- 2 Insert two batteries type R06 or AA, following the indications (+ -) inside the compartment.
- 3 Close the cover.

Using the remote control to operate the system

- 1 Aim the remote control directly at the remote sensor (iR) on the front panel.
- 2 Select the source you wish to control by pressing one of the source select buttons on the remote control (for example TV/AV,TUNER.)
- 3 Then select the desired function (for example **▶ ||**, **◀◀◀ ▶▶▶**.)

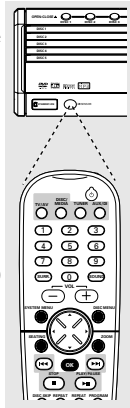

CAUTION!

- Remove batteries if they are exhausted or if the remote is not to be used for a long time.
- Do not use old and new or different types of batteries in combination.
- Batteries contain chemical substances, so they should be disposed of properly.

Step 2: Setting the clock

The clock can be set in either 12-hour or 24-hour mode ("12:00 AM" or "00:00" for example.)

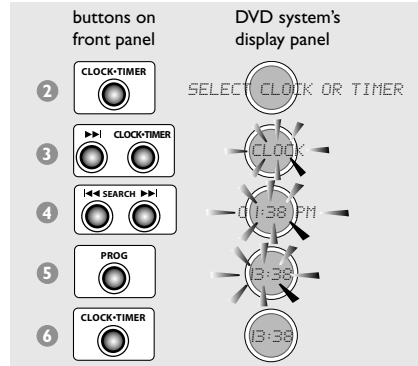

- 1 Press **STANDBY ON** to switch on the DVD system.
- 2 Press and hold **CLOCK•TIMER** until "SELECT CLOCK OR TIMER" appears.
- 3 Press **▶▶▶** (if necessary) to change the display to "CLOCK," then press **CLOCK•TIMER** again to confirm.
- 4 Press **◀◀◀ / ▶▶▶** to set the minutes and hours. To increase the speed, hold down **◀◀◀** or **▶▶▶**.
→ The changes in minutes will roll over to the hours.
- 5 Press **PROG** to change between 12-hour and 24-hour clock mode.
- 6 Press **CLOCK•TIMER** again to store the setting.
→ The clock will start working.

To view the clock time in any active mode

- Press **CLOCK•TIMER**.
→ The clock will display for a few seconds.

Notes:

- If the DVD system is disconnected from the power supply, it will erase the clock setting.
- If you do not press any buttons within 90 seconds, the system will exit clock setting mode.

Step 3: Setting the TV

IMPORTANT!

Make sure you have completed all the necessary connections. (See pages 12-13 "Connecting TV".)

- 1 Adjust **SOURCE** control until "DISC X" appears on the display panel (or press **DISC/MEDIA** on the remote.)
- 2 Turn on the TV and set to the correct video-in channel. You should see the blue Philips DVD background screen on the TV.
 - Usually this channel is between the lowest and highest channels and may be called FRONT, A/V IN, or VIDEO. See your TV manual for more details.
 - Or, you may go to channel 1 on your TV, then press the Channel down button repeatedly until you see the Video In channel.
 - Or, the TV remote control may have a button or switch that chooses different video modes.
 - Or, set the TV to channel 3 or 4 if you are using an RF modulator.

Changing the NTSC/PAL setting via the remote control

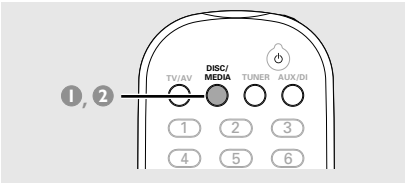

- 1 Press **DISC/MEDIA** on the remote to enter disc mode.
 - Make sure no MP3 or picture (Kodak, JPEG) disc is in disc tray 1.
 - Wait until the system finishes reading the discs before proceeding to next step. If playback begins, press **STOP** to stop playback.
- 2 Press and hold **DISC/MEDIA** on the remote until "PAL" or "NTSC" appears on the display panel.
 - To change the setting, repeat step 1.

Selecting the color system that corresponds to your TV

This DVD system is compatible with both NTSC and PAL. In order for a DVD to play on this DVD system, the color system of the DVD, the TV and the DVD system should match.

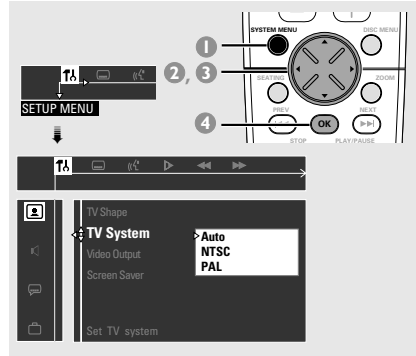

- 1 In disc mode, stop playback and press **SYSTEM MENU**.
- 2 Select **T** icon and press **▼**.
- 3 Use the joystick (**◀▶▲▼**) on the remote to navigate in the menu.
 - Move to **T** and press **▶**.
 - Move to **TV System** and press **▶**.

Auto – Select this if the connected TV is compatible with both NTSC and PAL (multi-system.) The output format will follow the video signal of the disc.

NTSC – Select this if the connected TV is NTSC system. It will change the video signal of a PAL disc (VCD only) and output to NTSC format.

PAL – Select this if the connected TV is PAL system. It will change the video signal of an NTSC disc and output to PAL format.

- 4 Select an item and press **OK**.

To remove the menu
Press **SYSTEM MENU**.

Step 4: Selecting speaker layout

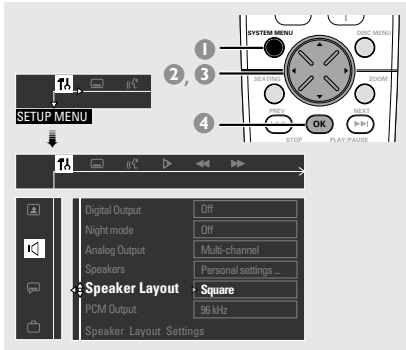

- 1 In disc mode, press **SYSTEM MENU**.
- 2 Select and press **▼**.
- 3 Use the joystick (**◀▶▲▼**) on the remote to navigate in the menu.
Move to and press **▶**.
Move to **Speaker Layout** and press **▶**.

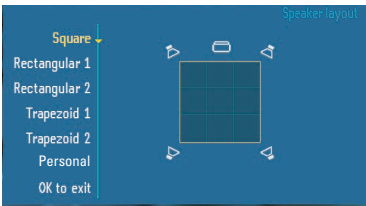

- 4 Select the layout that most closely resembles your speakers' arrangement, then press **OK**.
→ The speaker output will adjust automatically to suit the selected speaker layout settings based on the seating position in the middle. To change the seating position, see "Changing seating control position."
→ If you choose **Personal**, the speaker output will follow the settings in the **'Speakers'** menu. (See next page "Setting the speakers' channels".)

To remove the menu

Press **SYSTEM MENU**.

Changing seating control position

Normally, the best sound spot and the ideal setting position is in the middle of the room. With this **'SEATING'** feature, it allows you to select the current seating position in the room and the speaker setting will automatically adjust for optimum performance.

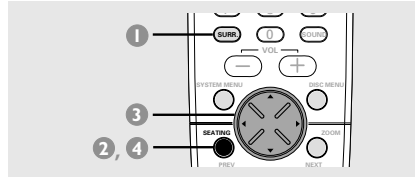

- 1 Press **SURRE**. (or **SURROUND** on the front panel) repeatedly to select **'Multi-channel'**.
- 2 Press **SEATING**.
→ The seating control diagram which represents your current speaker layout appears on the TV screen. To change the speaker layout, see "Selecting speaker layout."
- 3 Use the joystick (**◀▶▲▼**) on the remote (or **VOLUME** control on the front panel) to select your current seating position.
→ During playback, you can hear the changing of sound effect when you change the seating position.
→ If you do not press any buttons within five seconds, the seating control diagram will exit from the TV and the system will execute the last selected seating position.
- 4 If you want to remove the seating control feature, press **SEATING** twice.
→ **"PERSONAL SETTING"** appears and the system will revert to the personal speaker settings.

Setting the speakers' channels

You can adjust the delay times (center and surround only) and volume level for individual speakers. These adjustments let you optimize the sound according to your surroundings and setup. Speaker settings are only active on Multi-channel audio outputs.

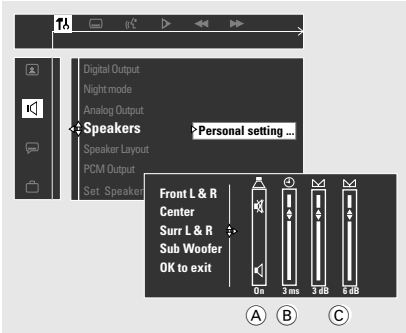

- 1 Press **SURR.** (or **SURROUND** on the front panel) repeatedly to select 'Multi-channel.'
- 2 In disc mode, press **SYSTEM MENU**.
- 3 Select and press **▼**.
- 4 Use the joystick (**◀▶▲▼**) on the remote to navigate in the menu.
Move to and press **▶**.
Move to 'Speakers' and press **▶**.
- 5 Press **▲▼** to select (**Front L&R, Center, Surr L&R, Sub Woofer**), then press **▶** to enter the speaker setting menu.
→ The test tone will be automatically generated.
- 6 Use **▲▼** to adjust the settings for each speaker to suit your surround sound needs. These adjustments may include :
 - (A) Turning on or off the sound output.
 - (B) Delay time settings - use the longer delay settings when the surround speakers are closer to the listener than the front speakers.
 - (C) Adjusting the volume levels for one or both speakers until the sound evens.
- 7 Press **OK** to confirm.

To remove the menu

Press **SYSTEM MENU**.

Step 5: Setting language preference

You can select your preferred language settings so that this DVD system will automatically switch to the language for you whenever you load a disc. If the language selected is not available on the disc, the disc's default setting language will be used instead. Except the DVD system's menu language, it will remain once selected.

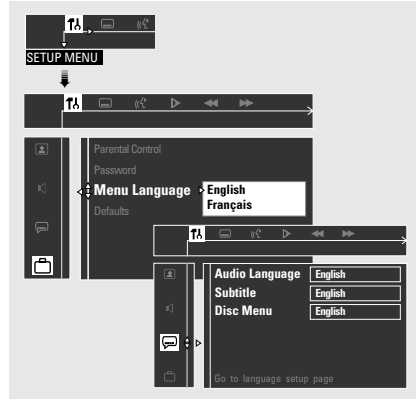

- 1 In disc mode, stop playback and press **SYSTEM MENU**.
- 2 Select and press **▼**.
- 3 Use the joystick (**◀▶▲▼**) on the remote to navigate in the menu.
Move to and press **▶**.
Move to 'Menu Language' and press **▶**.
- 4 Select a language and press **OK**.
- 5 Use the joystick (**◀▶▲▼**) on the remote to navigate in the menu.
Move to and press **▶**.
Move to one of the following and press **▶**.
 - 'Audio Language' (disc's soundtrack)
 - 'Subtitle' (disc's subtitles)
 - 'Disc Menu' (disc's menu)
- 6 Select a language and press **OK**.
- 7 Repeat steps 5~6 for other settings.

To remove the menu

Press **SYSTEM MENU**.

IMPORTANT!

- DVD discs and players are designed with regional restrictions. Before playing a disc, make sure the disc is for the same zone as your player.
- Depending on the DVD or VIDEO CD, some operations may be different or restricted.
- Do not push on the disc tray or put any objects other than discs on the disc tray. Doing so may cause the disc player to malfunction.

Playable discs

Your DVD home cinema system will play:

- Digital Video Discs (DVDs)
- Video CDs (VCDs)
- Super-Video CDs (SVCDs)
- Digital Video Discs + Rewritable(DVD+RW)
- Compact Discs (CDs)
- MP3 discs, picture (Kodak, JPEG) files on CD-R(W).
 - JPEG/ISO 9660 format.
 - Maximum 30 characters display.
 - Supported sampling frequencies : 32 kHz, 44.1 kHz, 48 kHz
 - Supported Bit-rates : 32~256 (kbps), variable bitrates



Region Codes

DVDs must be labeled for **ALL** regions or for **Region 1** in order to play on this DVD system. You cannot play discs that are labeled for other regions.



Note:

- If you are having trouble playing a certain disc, remove the disc and try a different one. Improperly formatted discs will not play on this DVD system.

IMPORTANT!



If the inhibit icon (or X) appears on the TV screen when a button is pressed, it means the function is not available on the current disc or at the current time.

Playing discs

- Adjust **SOURCE** control until "DISC X" appears on the display panel (or press **DISC/MEDIA** on the remote.)
 - Turn on the TV power and set to the correct Video In channel. (See page 21 "Setting the TV".)
 - You should see the blue Philips DVD background screen on the TV.
 - Press one of the **OPEN•CLOSE ▲** button to open the disc tray and load a disc, then press the same button again to close the disc tray.
 - Make sure the label side is facing up. For double-sided discs, load the side you want to play face up.
 - Repeat step 3 for loading a disc onto another disc tray.
 - Playback will start automatically from the last loaded disc.
 - All the available discs will play once, then stop.
 - If a disc menu shows on the TV, see next page on "Using the Disc Menu."
 - If the disc is locked by parental control, you must enter your four-digit password. (See page 35-36.)
- To obtain the best surround effects, see page 22 "Changing seating control position."

Note:

- Only one tray can be opened at a time. If you intend to open the second tray before closing the first tray, the first tray will automatically close before the second tray opens.

Turning on/off auto Eco standby mode

This is a power-saving feature, the system will automatically switch to Eco standby mode if you do not press any buttons within 30 minutes after a disc has stopped playing.

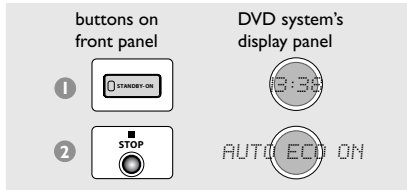

- 1 Press and hold **STANDBY ON** to switch the system to standby mode.
→ The clock appears.
- 2 Press and hold **■** until "AUTO ECO ON" appears.
→ To turn off the setting, repeat step 2 until "AUTO ECO OFF" appears.

Using the Disc Menu

Depending on the disc, a menu may appear on the TV screen once you load in the disc.

To select a playback feature or item

- Use the **joystick** (◀▶▲▼) or **numeric keypad (0-9)** on the remote, then press ▶ **II** or **OK** to start playback.

To access or remove the menu

- Press **DISC MENU** on the remote.

For VCD with Playback Control (PBC) feature (version 2.0 only)

- In stop mode, press **DISC MENU** to toggle between 'PBC ON' and 'PBC OFF', then the playback will start automatically.
→ If you select 'PBC ON', the disc menu (if available) will appear on the TV. Use the Joystick (◀▶▲▼) to highlight your selection and press OK to confirm or use the numeric keypad (0-9) to select a playback option.
- During playback, pressing **DISC MENU** will return to the menu screen (if PBC is on).

Basic playback controls

Pausing playback

- Press ▶ **II**.
→ To resume normal playback, press ▶ **II** again.

Selecting another track/chapter

- Press |◀◀ / ▶▶| or use the **numeric keypad (0-9)** to key in a track/chapter number.

Searching backward/forward

- Press and hold |◀◀ / ▶▶|, then press ▶ **II** to resume normal playback.
→ While searching, pressing and holding |◀◀ / ▶▶| again will increase the search speed.

Selecting next disc

- Press **DISC SKIP**.
→ The selected disc will play once, then stop.

Stopping playback

- Press **■**.

Resuming playback from the last stopped point (DVD/VCD)

- In stop mode and when the disc has not been ejected, press ▶ **II**.

To cancel the resume mode

- In stop mode, press **■** again.

Notes:

- Opening the current disc tray or selecting another disc tray will cancel the resume feature.
- Resume option may not be available on some discs.

Replacing discs without interrupting playback

- Press **OPEN•CLOSE ▲** buttons of the inactive disc trays.
For example, if currently disc tray 1 is playing, you can replace the discs on disc trays 2~5.

Disc Operations

Selecting various repeat functions

Repeat play mode

- While playing a disc, press **REPEAT** to select :

REPEAT CHAPTER (DVD)

- to repeat playback of the current chapter.

REPEAT ALBUM (MP3)

- to repeat playback of the current album.

REPEAT TRACK/TITLE

- to repeat playback of the current track/title.

REPEAT DISC (CD/VCD/SVCD)

- to repeat playback of the current disc or the programmed tracks (if the program mode is active.)

REPEAT ALL (CD/VCD/SVCD)

- to repeat playback of all available discs or the programmed tracks.

REPEAT OFF

- to cancel the repeat mode.

Notes:

- Repeat play might not work correctly with some DVDs.
- For VCD, if the PBC mode is switched on, repeat play is not possible.

Repeating a section within a chapter/track

- While playing a disc, press **REPEAT A-B** at the starting point.
- Press **REPEAT A-B** again at the point to end the section.
 - The section A and B can be set only within the same chapter/track.
 - The section will now repeat continuously.
- Press **REPEAT A-B** again to resume normal playback.

Program favorite tracks (audio CDs and VCDs)

You can play the contents of the disc in the order you want by programming the order of the tracks to be played. Up to 99 tracks can be stored.

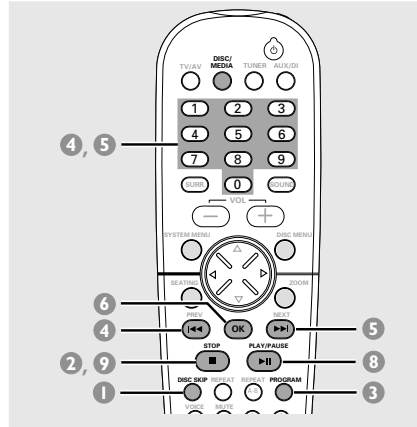

- Press **DISC SKIP** repeatedly to select a disc tray containing audio CD or VCD.
 - Wait until the system finishes reading the discs before proceeding to next step.
- When the playback begins, press **STOP** to stop playback.
- Press **PROGRAM** to enter program mode.
 - "PROGRAM FULL" appears if you have already programmed 99 tracks.



- 4 Press **◀◀**, then use the **numeric keypad (0-9)** to enter the disc number.
→ "DISC X" appears.
- 5 Press **▶▶**, then use the **numeric keypad (0-9)** to enter the track number.
→ "TRACK X" appears.
- 6 Press **OK** to store the track.
- 7 Repeat steps 4~6 to select other discs and tracks.
- 8 Press **▶||** to start program playback.
→ Only the tracks programmed from audio CDs and VCDs will play.
- 9 Press **■** to stop playback or exit program mode.

Notes:

- Pressing **OPEN•CLOSE** button of the programmed disc tray will erase the program.
- If you do not press any buttons within 20 seconds, the system will exit programming mode.

Clearing the program

- Stop playback, then press and hold **■**.
→ **PROG** disappears from the display panel and "PROGRAM CLEARED" appears.

Note:

- If the DVD system is disconnected from the power supply, the program will be erased.

Using the menu bar to program

IMPORTANT!

You have to turn on your TV and set to the correct Video In channel. (See page 21 "Setting the TV".)

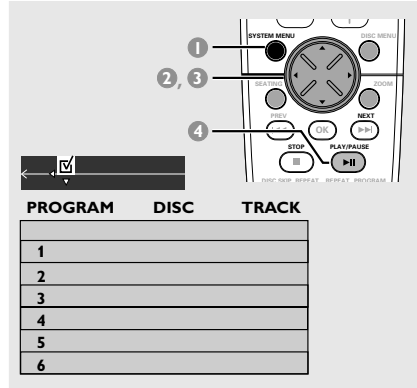

- 1 Stop playback, then press **SYSTEM MENU**.
→ The menu bar will appear across the top of the TV screen.
- 2 Use the joystick (**◀▶**) to select **✓** and press **▼** to enter the program menu.
- 3 Use the joystick (**◀▶▲▼**) to move within the program menu and use the **numeric keypad (0-9)** to enter the disc and track number to program.
- 4 Press **▶||** to start program playback.
→ Only the tracks programmed from audio CDs and VCDs will play.
- In stop mode, you can press **PROG** on the front panel to toggle between program on and off.

To clear the program

- Stop playback, then press and hold **■**.

Disc Operations

Playing MP3/Picture disc (Kodak, JPEG)

IMPORTANT!

You have to turn on your TV and set to the correct Video In channel. (See page 21 "Setting the TV".)

- Load an MP3/Picture (Kodak, JPEG) disc.
→ The disc reading time may exceed 30 seconds due to the complexity of the directory/file configuration.
- Playback will start automatically.
→ For picture discs, 9 thumbnail pictures will appear on the TV. Press **▶||** to start slide-show playback.
→ For MP3 discs, a list of albums/titles menu will appear on the TV.

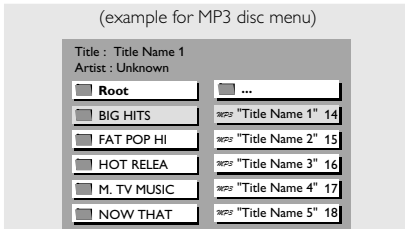

(example for 9 thumbnail pictures display)

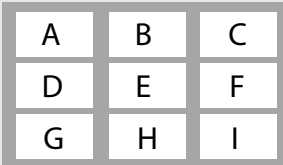

During playback, you can;

- Press **◀◀◀ / ▶▶▶** to select another title/picture in the current folder.
 - Use the joystick (**◀▶▲▼**) on the remote to rotate/flip the picture files.
 - Press **▶||** to pause/resume playback.
- To stop playback, press **■**.

In stop mode, you can;

- Use the joystick (**◀▶▲▼**) on the remote to move within the menu and press **OK** to select the desired file to play.
- In picture menu, you can use the joystick (**◀▶▲▼**) to select **◀◀◀** or **▶▶▶** in the menu to view the previous/next page (if available.)

Notes:

- Due to the recording nature of Digital Audio MP3 (DAM), only digital audio music will play.
- It is normal to experience an occasional "skip" while listening to your MP3 discs.
- Some files on Kodak or JPEG discs may be distorted during playback due to the configuration and characteristics of the disc.

Program MP3 disc

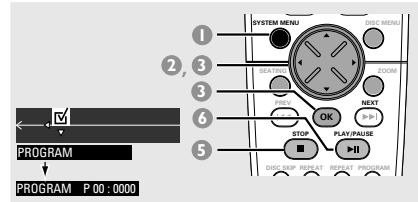

- Stop playback, then press **SYSTEM MENU**.
→ The menu bar will appear across the top of the TV screen.
 - Use the joystick (**◀▶**) to select **☑** and press **▼** to enter the program menu.
 - Use the **numeric keypad (0-9)** or joystick (**◀▶▲▼**) to select the title number and press **OK**.
 - Repeat step **3** to select title number.
 - Press **■** to stop the programming.
→ A list of programmed tracks appears.
 - Press **▶||** to start program playback.
- In stop mode, you can press **PROG** to toggle between program on and off.

To clear the program

- Stop playback, then press and hold **■**.

Note:

- Repeat function is not possible during MP3 program playback.

About media slot

The **MEDIA SLOT** allows you to playback the contents (for example, digital still pictures) stored in the memory card (PCMCIA) without the need of using the device itself (for example, digital camera, digital camcorder, MP player) or a computer.

Memory cards (for example, Compact Flash, Memory Stick, Smart Media, Secure Digital card, Multimedia card) are a new form of compact, portable, digital data exchange or storage systems with compatible memory card devices and versatile IC (Integrated Circuit) recording medium with a data capacity that exceeds a floppy disc.

Precaution on handling the memory card

- Do not attach any other material than the supplied label on the label space.
- Do not touch the memory card connector with fingers or metal objects.
- Do not bend, drop, disassemble or modify the memory card.
- Do not allow the memory card to get wet.
- If you use a memory card that has been initialized using a computer or if you initialize a memory card attached to a camera using a USB connection, further operation is not guaranteed.
- An image file that has been modified using an image processing software may not open if it is converted into a different file format.

Supported memory card format

File format: JPEG image (*.jpg)

Compatibility:

- *.jpg images recorded with a digital camcorder or digital camera with memory card function.
- JPEG images stored in a memory card using a memory card adaptor for PC.
- **MP3 files.**

Directories:

- Memory card
- Picture CD

Playing JPEG pictures from memory card

- 1 Remove the memory card from your digital camera and plug it into the PC card adaptor (not supplied.)
- 2 Insert the PC card adaptor into the media slot on your player.
- 3 Adjust **SOURCE** control until "MEDIA SLOT" appears on the display panel (or press **DISC/MEDIA** twice on the remote.)
- 4 Turn on the TV power and set to the correct Video In channel. (See page 21 "Setting the TV".)
→ If the memory card is recognized, 9 thumbnail pictures will appear on the TV.
- 5 You can also use the joystick (◀▶▲▼) to make your selection from the 9 thumbnail pictures. If you press **OK**, the selected picture will show on the TV screen. If you press ▶||, the slide-show playback will begin from the selected picture.

During playback, you can;

- Press ◀◀◀ / ▶▶▶ to select another picture.
- Use the joystick (◀▶▲▼) on the remote to rotate/flip the picture files.
- Press ▶|| to pause/resume playback.
- 6 To stop playback, press ■.
- 7 To eject the memory card, press **EJECT ▲**.

In stop mode, you can;

- Use the joystick (◀▶▲▼) to select ◀◀◀ or ▶▶▶ in the menu to view the previous/next page (if available.)

Notes:

- Some files on memory cards may be distorted when played back.
- If you insert the PC card adaptor into the media slot while watching a DVD playback, the picture/sound from the disc may freeze/skip due to electrical interference.

DVD Menu Options

Using the menu bar

You can continue a number of operations directly via the multiple menu bars on the TV screen without interrupting the disc playback.

The exception is when you enter **SETUP MENU** (SETUP MENU,) the playback will pause.

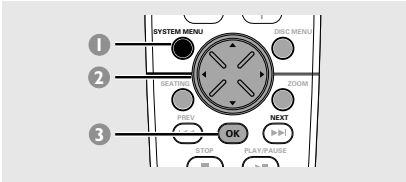

- In disc mode, press **SYSTEM MENU**.
→ The menu bar will appear across the top of the TV screen.

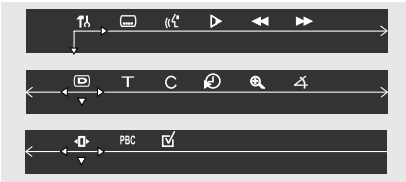

- Use the joystick (◀▶▲▼) on the remote to navigate in the menu.
→ Press ◀▶ to move through the menu bar.
→ Press ▼ to enter the selection. If there are multiple choices available, press ▼ repeatedly to select.
- Press **OK** to confirm the selection.
→ Playback will resume or begin automatically.

To remove the menu

Press **SYSTEM MENU**.

IMPORTANT!

– Some operations may be different or restricted, depending on the disc format. Refer to the jacket or case of the disc you are playing.

– Changing the Subtitle Language and Audio Language from the menu bar will only apply to the current disc, it will not change the default preset.

	SUBTITLE Select a subtitle language available on the DVD.
	AUDIO DVD : Select an audio soundtrack language available on the DVD. VCD : Select audio channels : LEFT VOCAL, RIGHT VOCAL, MONO LEFT, MONO RIGHT or STEREO.
	SLOW MOTION Select a slow playback speed. The volume will be muted. To resume normal playback, press ▶ II. DVD : SF x2, SF x4, SF x8, SR x2, SR x4, SR x8. VCD : SF x1, SF x2, SF x3. (SF=Slow Forward, SR=Slow Reverse)
	FAST REVERSE DVD : FR x2, FR x4, FR x6, FR x8. VCD/MP3 : FR x1, FR x2, FR x3, FR x4.
	FAST FORWARD DVD : FF x2, FF x4, FF x6, FF x8 VCD/MP3 : FF x1, FF x2, FF x3, FF x4. Select a search speed (backward/forward). The volume will be muted. To resume normal playback, press ▶ II.
	STATUS Allows viewing of the current status of the disc. The information will vary depend on the disc format.
T	<i>Available on DVD only</i> TITLE SEARCH (TITLE XX:YY) Select a Title for playback to begin.
C	CHAPTER SEARCH (CHAPTER XX:YY) Select a Chapter for playback to begin. "XX" - current title/chapter number. "YY" - total number of title/chapter. Use the numeric keypad (0-9) to change the "XX" number, then press OK .
	TIME SEARCH (TIME _:_:) Use the numeric keypad (0-9) to enter the time (hours, minutes and seconds) at which you want playback to begin.
	ZOOM Select an enlarge picture ratio : x1.5, x2.0, x3.0, then press OK to confirm. Use the joystick to move within the enlarged picture on the TV. To resume normal playback, select 'ZOOM OFF' from the menu.
	ANGLE (for DVD only) Select to view the same scene from different angles if the DVD is recorded with multiple angles.
	STEP FORWARD Select to advance the still picture one frame forward. To resume normal playback, press ▶ II.
PBC	PBC ON/OFF (for VCD 2.0 with PBC feature) Select between PBC On and Off. 'PBC OFF' - the playback will start automatically. 'PBC ON' - the disc menu (if available) will appear on the TV. Use the numeric keypad (0-9) to enter your choice.
	PROGRAM Stop playback, then select this to enter the program menu (see page 27 "Using the menu bar to program").

Using the Setup Menu

This DVD setup is carried out via the TV, enabling you to customize the DVD system to suit your particular requirements.

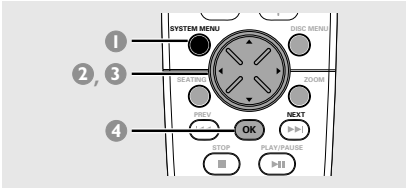

- 1 In disc mode, press **SYSTEM MENU**.
→ Playback will pause.
- 2 Select **TV** icon and press **▼** to enter the setup menu. Then press **▲▼** to select one of the setup menu options and press **▶** to enter the menu.



- 3 Use the joystick (**◀▶▲▼**) on the remote to navigate in the menu.
- 4 Press **OK** to confirm your selection.
→ Playback will resume or begin automatically.

To remove the menu

Press **SYSTEM MENU**.

NOTE:

Some of the features in the Setup Menu are described in “Getting Started.”

Setting the TV shape

The format you select must be available on the disc. If it is not, the setting for TV Shape will not affect the picture during playback.

Follow the steps of “Using the Setup Menu” and select :

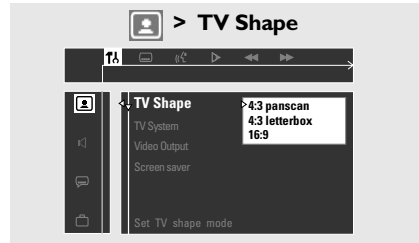

4:3 panscan

Select this if you have a conventional TV and your DVD is not formatted for wide screen viewing. A wide picture will display on the whole TV screen with a portion automatically cut off.

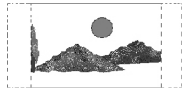

4:3 letterbox

Select this if you have a conventional TV and your DVD is formatted for wide screen viewing. Black bars appear on the upper and lower portions of the TV screen.



16:9

Select this if you have a wide screen TV (you must also set your wide screen TV to “full size”).



DVD Menu Options

Setting the video output

Set the Video Output according to your video connection.

Stop playback, then follow the steps of "Using the Setup Menu" and select :

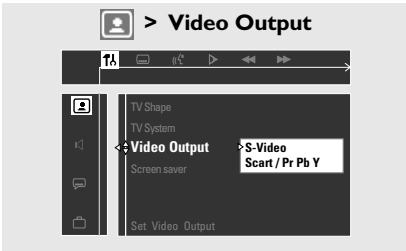

S-Video

Select this if you have connected the DVD system to your TV using the S-Video jack.

Scart / Pr Pb Y

Select this if you have connected the DVD system to your TV using component video jacks. (SCART - this feature is not available for this model.)

Note:

– You do not need to adjust the video output setting if you are using CVBS jack (yellow) to connect the DVD system to your TV.

Screen Saver - turning on/off

Follow the steps of "Using the Setup Menu" and select :

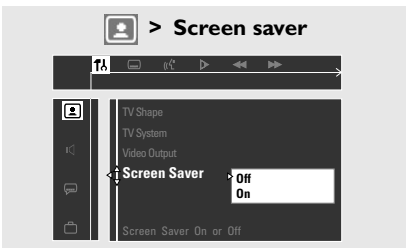

Off

Select this to disable the screen saver function.

On

Select this if you wish to dim the TV screen when disc playback is stopped or paused for more than five minutes. It is to prevent your display device from becoming damaged.

Setting the analog output

Set Analog Output to match your DVD home cinema system's playback capability. This function can also be accessed via the SURR. button on the remote control (or SURROUND on the front panel.)

Follow the steps of "Using the Setup Menu" and select :

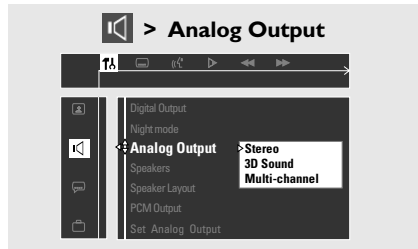

Stereo

Select this to change channel output to stereo which delivers sound from only the two front speakers and subwoofer:

3D Sound

Select this to change channel output to 3D sound which delivers surround sound from only the two front speakers and subwoofer:

Multi-channel

Select this to enable Multi-channel output. Once you select 'Multi-channel', the digital output of this DVD system will automatically change to 'ALL' (see next page).

Setting the digital output

Set Digital Output according to your optional audio equipment connections.

Follow the steps of "Using the Setup Menu" and select :

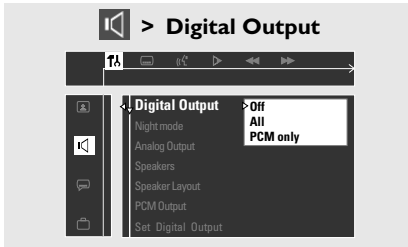

Off

Select this to deactivate the digital output.

All

Select this if you have connected the digital output to an optional piece of audio equipment that has a multichannel decoder:

PCM only

Select this if the optional audio equipment is not capable of decoding multichannel audio. After that, proceed to "Setting the PCM output."

Once you select 'PCM only', the surround mode will automatically change to 'STEREO'.

Setting the PCM output

Set your PCM (Pulse Code Modulation) output only after you have set the system's Digital Output to 'PCM only'. (See "Setting the digital output".)

Follow the steps of "Using the Setup Menu" and select :

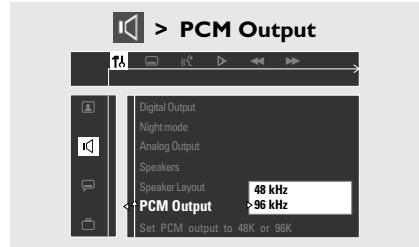

48 kHz

Select this if the optional audio equipment is incapable of processing 96 kHz digital signal input. The signal will then be converted to a standard signal with sampling rates of 48 kHz.

96 kHz

Select this if the optional audio equipment is capable of processing digital signal input with sampling rates of 96 kHz. However, if the sound output is distorted or there is no sound, select '48 kHz' instead.

DVD Menu Options

Night mode - turning on/off

Follow the steps of "Using the Setup Menu" and select :

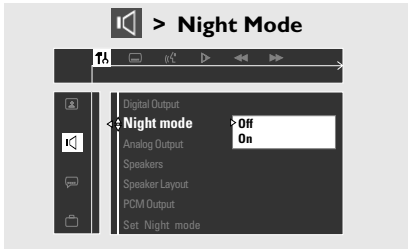

Off

Select this when you want to enjoy the surround sound with its full dynamic range.

On

Select this to level out the volume. High volume outputs will be softened and low volume outputs are brought upward to an audible level. This feature is only available for movies with Dolby Digital mode.

Restoring to original settings

Follow the steps of "Using the Setup Menu" and select :

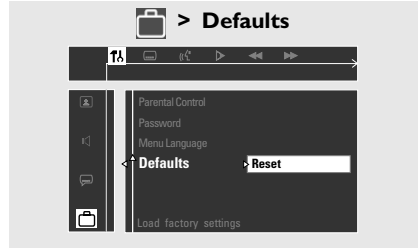

Reset

Pressing ► on the remote will restore all the items in the setup menu to the original factory setting except for your Parental Control password.

Restricting playback by Parental Control

(only available in region 1 players)

Some DVDs may have a parental level assigned to the complete disc or to certain scenes on the disc. This feature lets you set a playback limitation level. The rating levels are from 1 to 8 and are country dependent. You can prohibit the playing of certain discs that are not suitable for your children or have certain discs played with alternative scenes.

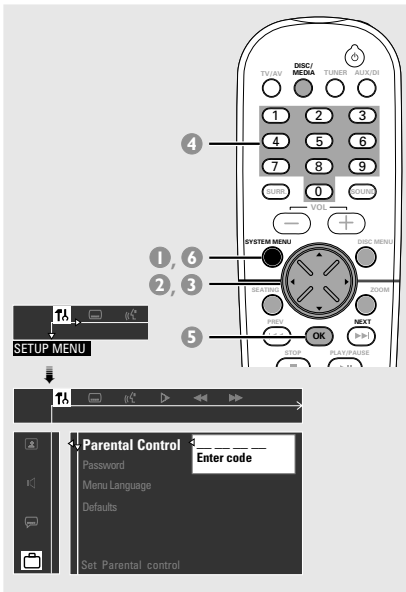

- 1 In disc mode, press **SYSTEM MENU**.
- 2 Select and press ▼.
- 3 Use the joystick (◀▶▲▼) on the remote to navigate in the menu.

Move to and press ▶.

Move to **Parental Control** and press ▶.

- 4 Use the **numeric keypad (0-9)** to enter '1234' (default password) when you are asked to enter the four-digit password. You will have to enter the same code, exactly, twice.
→ To change the password, see page 36 "Changing the password."
- 5 Select a rating level and press **OK**.
→ DVDs that are rated above the level you selected will not play unless you enter your four-digit password and choose a higher level rating. To disable Parental Controls and have all discs play, choose **'NO PARENTAL.'**

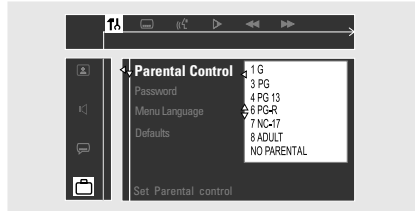

- 6 Press **SYSTEM MENU** again to remove the menu.

Rating explanations

NO PARENTAL – It will play all discs.

8 ADULT – Mature material; should be viewed only by adults due to graphic sexual material, violence, or language.

7 NC-17 – No children under age 17; not recommended viewing for children under age 17.

6 PG-R – Parental Guidance - Restricted; recommended that parents restrict children under 17 from viewing or allow to view only when supervised by a parent or adult guardian.

4 PG13 – Material is unsuitable for children under age 13.

3 PG – Parental Guidance suggested.

1 G – General Audience; recommended as acceptable for viewers of all ages.

Note:

– Some DVDs are not encoded with a rating though the movie rating may be printed on the disc jacket. The rating level feature does not work for such discs.

DVD Menu Options

Changing the password

You can change the four-digit password used for Parental Control. The default password is '1234'.

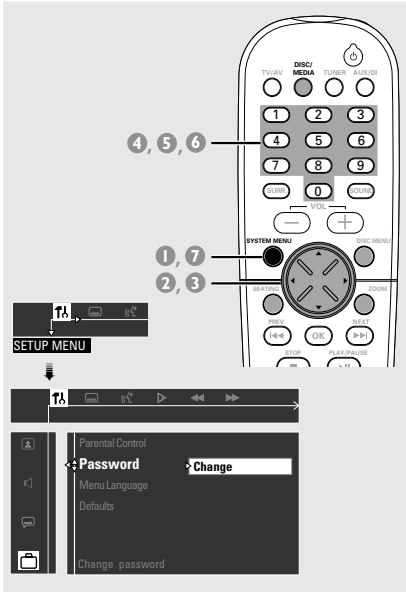

- 1 In disc mode, press **SYSTEM MENU**.
- 2 Select  icon and press **▼**.
- 3 Use the joystick (**◀▶▲▼**) on the remote to navigate in the menu.

Move to  and press **▶**.

Move to 'Password' and press **▶**.

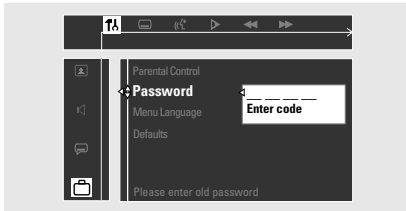

- 4 Use the **numeric keypad (0-9)** to enter your original four-digit password at "Enter code."
→ If you are asked to enter the code for the first time, key in '1234':
→ If you forget your password, press **■ four times** to restore to the default password (1234).
- 5 Enter your new four-digit password.



- 6 Enter the same new four-digit password again.

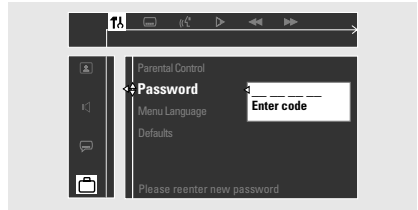

- 7 Press **SYSTEM MENU** again to remove the menu.

IMPORTANT!

- Make sure the **FM and AM antennas are connected.**
- The **TUNING** button on the front panel is used to toggle between frequency tuning and preset tuning. When in preset tuning mode, pressing **|◀◀/▶▶|** buttons on the front panel will change the preset number. Otherwise, pressing **|◀◀/▶▶|** will change the radio frequency.

Tuning to radio stations

- 1 Press **TUNER** on the remote (or adjust **SOURCE** control on front panel) to select "FM TUNER" or "AM TUNER."
- 2 Press and hold **|◀◀/▶▶|** on the remote until the frequency indication starts to change, then release.
 - The next radio station will tune automatically.
 - **∞** lights up for FM stereo reception.
- 3 To tune a weak station, press **|◀◀/▶▶|** briefly and repeatedly until an optimal reception is found.
- If you use **|◀◀/▶▶|** on the front panel for frequency tuning, make sure the system is in frequency tuning mode. If not, press **TUNING**.
 - "FREQ. MODE" appears.

Presetting radio stations

You can store up to 40 preset radio stations in the memory, starting from FM and followed by AM bands.

Notes:

- The system will exit presetting mode if no button is pressed within 20 seconds.
- If no stereo frequency is detected during Plug and Play, "CHECK ANTENNA" appears.

Using the Plug and Play

Plug and Play allows you to store all available radio stations automatically.

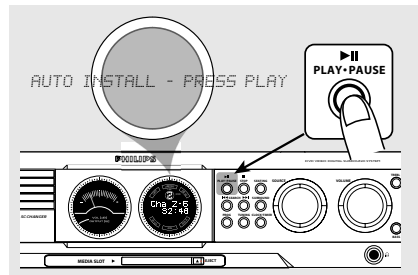

- 1 Connect the system to the power supply, "AUTO INSTALL - PRESS PLAY" appears. **OR**

In Eco Power standby/standby mode, press and hold **▶||** on the front panel until "AUTO INSTALL - PRESS PLAY" appears.

- 2 Press **▶||** on the front panel to start installation.
 - "INSTALL TUNER" appears.
 - All previously stored radio stations will be replaced.
 - Once completed, the last tuned radio station will play.

Tuner Operations

Automatic presetting

You can start the automatic presetting from a selected preset number:

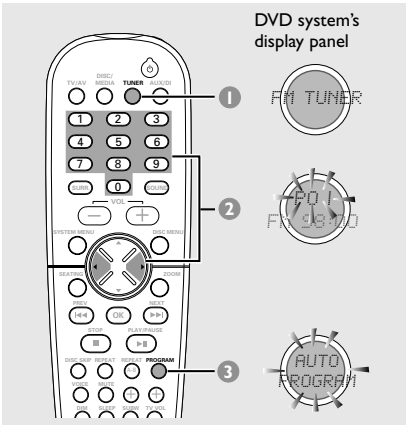

- 1 Press **TUNER** on the remote (or adjust **SOURCE** control on front panel) to select "FM TUNER" or "AM TUNER."
- 2 Press ◀▶ or use the **numeric keypad (0-9)** to select a preset number to begin.
 - If you use ◀◀▶▶ on the front panel for preset tuning, make sure the system is in preset tuning mode. If not, press **TUNING**.
→ "PRESET MODE" appears.
- 3 Press and hold **PROGRAM** (or **PROG** on the front panel) until "AUTO PROGRAM" appears.
 - If a radio station is stored in one of the presets, the same radio station will not store under another preset number.
 - If no preset number is selected, automatic preset will begin from preset (1) and all your former presets will be overridden.

Manual presetting

You can choose to store only your favorite radio stations.

- 1 In tuner mode, press **PROGRAM** (or **PROG** on the front panel.)
- 2 Press ◀▶ or use the **numeric keypad (0-9)** to select a preset number.
- 3 Press ◀◀▶▶ on the remote to select a radio station.
- 4 Press **PROGRAM** again to store.

Selecting a preset radio station

- Press ◀▶ or use the **numeric keypad (0-9)** to select a preset number:
 - The preset number, radio frequency, and waveband will appear.

Deleting a preset radio station

- Press and hold ■ until "PRESET DELETED" appears.
 - The current preset radio station will be deleted and the next available preset radio station will take its place.
 - All other preset radio stations with higher numbers will decrease by one.

Setting the timer

The system can switch on to DISC or TUNER mode automatically at a preset time, serving as an alarm to wake you up.

IMPORTANT!

- Before setting the timer, ensure that the clock is set correctly.
- The volume of the timer will increase gradually to the last tuned volume level. If the last tuned volume level is too low, the set will then increase to a predetermined minimum audible level.

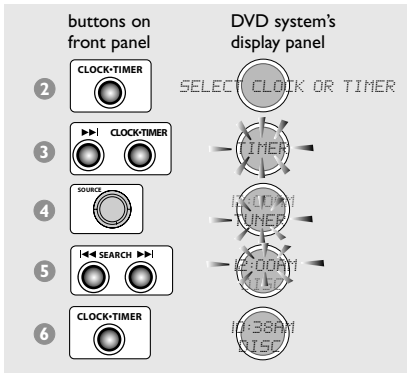

- 1 Press **STANDBY ON** to switch on the DVD system.
- 2 Press and hold **CLOCK•TIMER** until "SELECT CLOCK OR TIMER" appears.
- 3 Press **▶▶▶** (if necessary) to change the display to "TIMER," then press **CLOCK•TIMER** again to confirm.
- 4 Adjust **SOURCE** (or press **DISC/MEDIA** or **TUNER** on the remote) to select the wake up source (DISC or TUNER.)
- 5 Press **◀◀◀ / ▶▶▶** to set the wake up time (minutes and hours).
To increase the speed, hold down **◀◀◀** or **▶▶▶**.
→ The changes in minutes will roll over to the hours.

- 6 Press **CLOCK•TIMER** again to store the setting.
→ Once the timer is set, it will always switch on unless you deactivate it.
→ icon will remain on the display panel. It indicates the timer is activated.
- **At the preset time, the selected sound source will play for 30 minutes before it switches to Eco Power standby mode** (if no button is being pressed within the time frame.)
→ **DISC** – playing the first track of the last selected disc. If the last selected disc tray is empty, it will switch to the next available disc. If all the disc trays are not available, it will switch to Tuner mode.
→ **TUNER** – playing the last tuned radio station.

Activating/Deactivating the timer

- 1 Repeat steps 1~3 of "Setting the timer."
- 2 Press **■** to turn off the timer:
→ icon will disappear from the display panel and "TIMER OFF" appears.

OR

Press **CLOCK•TIMER** to turn on the timer to the last setting.
→ The timer information will display for a few seconds, then the system resumes its last active source or stays in standby mode.

Note:

- The system will exit timer setting mode if no button is pressed within 90 seconds.

Timer Operations

Setting the Sleep timer

The sleep timer enables the system to switch to Eco Power standby mode automatically at a preset time.

- Press **SLEEP** on the remote repeatedly until it reaches the desired preset turn-off time.
 - The selections are as follows (time in minutes):
 - 15 → 30 → 45 → 60 → 90 → 120 →
 - OFF → 15 ...
 - **SLEEP** will show on the display panel, except if "OFF" is selected.
 - Before the system switches to Eco Power standby mode, a countdown of 10 seconds is displayed.
 - "SLEEP 10" → "SLEEP 9"... →
 - "SLEEP 1" → "SLEEP"

To check or change the setting

- Press **SLEEP** once to show the remaining time before switching off. If you continue pressing the **SLEEP** button, the next Sleep Timer option will appear on the display panel.

To cancel the sleep timer

- Press **SLEEP** repeatedly until "OFF" appears or press the **STANDBY ON** button.

Sound Control

IMPORTANT!

For proper surround sound, make sure the speakers and subwoofer are connected (see page 14.)

Selecting surround sound

- Press **SURROUND (SURRE.)** to select : **MULTI-channel, 3D SOUND or STEREO.**
 - The availability of the various surround sound modes depends on the number of speakers used and the sound available on the disc.
 - The center and surround speakers operate only when the DVD home cinema system is set to Multi-channel mode.
 - The available output modes for Multi-channel include: Dolby Digital, DTS (Digital Theater Systems) Surround, Dolby Surround and Dolby Pro Logic.
 - Stereo broadcasts or recordings will produce some surround channel effects when played in a surround mode. However; monaural (single channel sound) sources will not produce any sound from the surround speakers.

Note:

– You are not able to select the surround sound mode if the system menu/menu bar is turned on.

Turning on/off clear voice effect

You can enhance the center and surround sound outputs by activating the clear voice sound feature if you have selected Multi-channel as the surround mode.

- Press **VOICE** on the remote to select "CLEAR VOICE ON."
 - To turn off the setting, press VOICE again to select "CLEAR VOICE OFF."

Changing subwoofer volume level

- Press **SUB +/–** on the remote to adjust subwoofer volume level (-6dB to + 6dB.)

Adjusting Bass/Treble level

The **BASS** (low tone) and **TREBLE** (high tone) features enable you to define the sound-processor settings.

- 1 Press **BASS** or **TREBLE**.
 - The level indicator appears.
- 2 Within five seconds, use the **VOLUME** control to adjust the Bass or Treble level (-3 to +3.)
 - If the volume control is not used within five seconds, it will resume its normal volume control function.

Selecting digital sound effects

Select a preset digital sound effects that matches your disc's content or that optimizes the sound of the musical style you are playing.

- Press **SOUND** on the remote.

When playing movie discs, you can select : **CONCERT, DRAMA, ACTION or SCI-FI.**

When playing music discs or while in **TUNER or AUX/DI** mode, you can select : **ROCK, DIGITAL, CLASSIC or JAZZ.**

Volume control

- Adjust **VOLUME** control (or press **VOL +/–** on the remote) to increase or decrease the volume level.
 - "VOL. MIN" is the minimum volume level and "VOL. MAX" is the maximum volume level.

To listen through the headphones

- Connect the headphones plug to the  socket at the front of the DVD system.
 - The speakers will be muted.

To turn off the volume temporarily

- Press **MUTE** on the remote.
 - Playback will continue without sound and "MUTE" appears.
 - To restore the volume, press MUTE again or increase the volume level.

Other Functions

Switching on/off

Switching to active mode

- Adjust the **SOURCE** control to select :
DISC 1...DISC 5 → FM TUNER →
AM TUNER → TV/AV → AUX → DI →
MEDIA SLOT → DISC 1...

OR

Press **DISC/MEDIA, TUNER, TV/AV** or **AUX/DI** on the remote.

Switching to Eco Power standby mode

- Press **STANDBY ON (⏻)**.
→ ECO POWER button lights up.
→ The display screen will go blank.

Switching to standby mode (view clock)

- Press and hold **STANDBY ON (⏻)**.
→ The clock appears.
→ While in standby mode, pressing
CLOCK•TIMER button will switch the system to
Eco Power standby mode.

Dimming system's display screen

- Press **DIM** repeatedly to select different levels of brightness for the display screen.

Recording to an external device

- 1 Connect the external recording device to **LINE OUT** or **DIGITAL OUT**.
(See pages 16, 17 "Connections-optional".)
- 2 Select the source to record from your DVD system (DISC/MEDIA SLOT, TUNER, TV/AV or AUX/DI) and start playback (if necessary).
→ You can only record from DISC if using DIGITAL OUT to connect the external recording device.
- 3 Start recording on the external recording device.

Notes:

- All the sound control features are available for selection.
- Refer to the owner's manual of the connected equipment for details.

Using the remote to operate your television

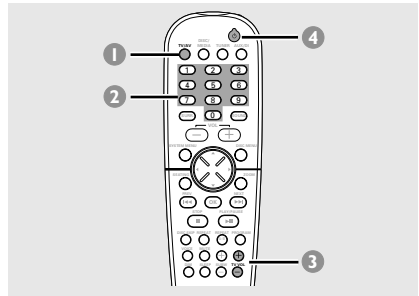

- 1 Press **TV/AV**.
- 2 Press **◀▶** or use the **numeric keypad (0-9)** to select the TV's channel.
- 3 Press **TVVOL + / -** to adjust the TV's volume level.
- 4 Press **⏻** to turn off your TV.

AMPLIFIER SECTION

Output power	600 W Total power
- Stereo mode (DIN)	100 W + 100 W RMS / 2 x 80 W FTC ^①
- Surround mode (1 kHz)	100 W RMS/channel
Frequency Response	100 Hz – 20 kHz / –3 dB
Signal-to-Noise Ratio	> 65 dB (CCIR)
Input Sensitivity	
- AUX In	880 mV
- TV In	350 mV
Output Sensitivity	
- Headphone	32 Ω – 1000 Ω
- Line Out	600 mV
- Digital In	acc IEC 60958 & IEC 61937

^① 8ohm, 120 Hz–12.5 kHz, 1% THD

TUNER SECTION

Tuning Range	FM 87.5 – 108 MHz (100 kHz steps) AM 530 – 1700 kHz (10 kHz steps)
26 dB Quieting Sensitivity	FM 20 dB
26 dB Quieting Sensitivity	AM 3162 mV/m
Image Rejection Ratio	FM 25 dB AM 28 dB
IF Rejection Ratio	FM 60 dB AM 24 dB
Signal-to-Noise Ratio	FM 60 dB AM 40 dB
AM Suppression Ratio	FM 30 dB
Harmonic Distortion	FM Mono 3% FM Stereo 3% AM 5%
Frequency Response	FM 180 Hz – 10 kHz / ±6 dB
Stereo Separation	FM 26 dB (1 kHz)
Stereo Threshold	FM 23.5 dB

DISC SECTION

Laser Type	Semiconductor
Disc Diameter	12cm / 8cm
Video Decoding	MPEG-2 / MPEG-1
Video DAC	10 Bits
Signal System	PAL / NTSC
Video Format	4:3 / 16:9
Video S/N	56 dB (minimum)
Composite Video Output	1.0 Vp-p, 75 Ω
S-Video Output	Y - 1.0 Vp-p, 75 Ω C - 0.286 Vp-p, 75 Ω
Audio DAC	24 Bits / 96 kHz
Frequency Response	4 Hz – 20 kHz (44.1 kHz) 4 Hz – 22 kHz (48 kHz) 4 Hz – 44 kHz (96 kHz)
Digital Output/Input	SPDIF (Sony Philips digital interface) Coaxial
- PCM	IEC 60958
- Dolby Digital/DTS	IEC 60958, IEC 61937

MAIN UNIT

Power Supply Rating	120V / 60 Hz
Power Consumption	155 W
Dimensions (w x h x d)	435 mm x 100 mm x 360 mm 17.13 x 3.94 x 14.17 (inch)
Weight	7.15 kg / 15.73 pounds

SPEAKERS

Front speakers / Rear (surround) speaker	
System	triple driver
Impedance	8 Ω
Speaker drivers	2 x 3" woofer; 1 3/4" tweeter
Frequency response	120 Hz – 20 kHz
Dimensions (w x h x d)	94 mm x 280 mm x 70 mm 3.70 x 11.02 x 2.76 (inch)
Weight	1.23 kg/each 2.7 pounds/each

CENTER SPEAKER

System	5 multi directional driver
Impedance	8 Ω
Speaker drivers	4 x 2" woofer; 1 3/4" tweeter
Frequency response	120 Hz – 20 kHz
Dimensions (w x h x d)	435 mm x 72 mm x 63.5 mm 17.13 x 2.83 x 2.5 (inch)
Weight	1.32 kg / 2.90 pounds

SUBWOOFER

Impedance	8 Ω
Speaker drivers	6 1/2" woofer
Frequency response	30 Hz – 120 Hz
Dimensions (w x h x d)	195 mm x 433 mm x 391 mm 7.68 x 17.05 x 15.39 (inch)
Weight	5.72 kg / 12.58 pounds

Specifications subject to change without prior notice

Troubleshooting

WARNING

Under no circumstances should you try to repair the system yourself, as this will invalidate the warranty. Do not open the system as there is a risk of electric shock.

If a fault occurs, first check the points listed below before taking the system for repair. If you are unable to remedy a problem by following these hints, please call [1-800-531-0039](tel:1-800-531-0039) for help.

Problem	Solution
No power.	<ul style="list-style-type: none">– Check if the AC power cord is properly connected.– Press the STANDBY ON on the front of the DVD system to turn on the power.
No picture.	<ul style="list-style-type: none">– Refer to your TV's manual for correct Video In channel selection. Change the TV channel until you see the DVD screen. (see page 21)– Press DISC on the remote.– Switch the P-SCAN at the back panel to "OFF" position if you are not using a Progressive Scan TV.
Distorted or poor picture.	<ul style="list-style-type: none">– Check the video connection. If both S-Video and Component (Pr Pb Y) Video connections are used to connect to your TV, the video signal will go to S-Video automatically every time when you power up the DVD system. To change the setting, refer to 'Video Output'. (see page 32)– Sometimes a small amount of picture distortion may appear. This is not a malfunction.– Clean the disc. (see page 10)
Completely distorted picture or black/white picture.	<ul style="list-style-type: none">– TVs have a color system standard. If the disc's or DVD system's color system is different than your TV's color system, the picture may be distorted or colorless. Set to the correct 'TV System' setting. (see page 21)
The aspect ratio of the screen cannot be changed even though you have set the TV display.	<ul style="list-style-type: none">– The aspect ratio is fixed on the DVD disc.– Depending on the TV, it may not be possible to change the aspect ratio.
No sound or distorted sound.	<ul style="list-style-type: none">– Adjust the volume.– Replace the speaker cables.– Check the speaker connections and settings. (see pages 14, 23)– Disconnect the headphones.– Press PLAY to resume normal play mode if necessary.– Press the correct source button on the remote (TV/AV or AUX, for example) to choose the equipment that you want to hear through the DVD system. (see pages 12, 13, 16, 17)
The DVD system does not work.	<ul style="list-style-type: none">– Disconnect the power cord from the power outlet for a few minutes. Reconnect the power cord and try to operate again as usual.

Problem	Solution
<p>The DVD player does not start playback.</p>	<ul style="list-style-type: none"> – Insert a readable disc with the playback side facing down. (see page 24) – Check the disc type, color system and region code. (see page 24) – Check for any scratches or smudges on the disc. – Press SYSTEM SETUP to turn off the setup menu screen. – Change the rating level. (see page 35) – Moisture has condensed inside the system. Remove the disc and leave the system turned on for about an hour.
<p>Cannot activate some features, such as Angles, Subtitles, or multi-language Audio.</p>	<ul style="list-style-type: none"> – The features may not be available on the DVD. – Changing the language for the sound or subtitle is prohibited on the DVD.
<p>There is no sound from the center and surround speakers.</p>	<ul style="list-style-type: none"> – Make sure the center and surround speakers are connected correctly. (see page 14) – Press SURROUND button to select a correct surround sound setting. (see page 41) – Make sure the source you are playing is recorded or broadcast in surround sound (DTS, Dolby Digital, etc.)
<p>Radio reception is poor.</p>	<ul style="list-style-type: none"> – If the signal is too weak, adjust the antenna or connect an external antenna for better reception. – Increase the distance between the system and your TV or VCR. – Tune in to the correct frequency. – Place the antenna farther away from any equipment that may be causing the noise.
<p>The remote control does not function properly.</p>	<ul style="list-style-type: none"> – Select the source (DISC or TUNER, for example) before pressing the function button (▶ , ◀◀, ▶▶◀) – Reduce the distance between the remote control and the system. – Replace the batteries with new ones. – Point the remote control directly toward the IR sensor. – Check that the batteries are loaded correctly.
<p>The timer is not working.</p>	<ul style="list-style-type: none"> – Set the clock correctly. (see page 20) – Press and hold CLOCK•TIMER to switch on the timer. (see page 39)
<p>The display panel is dark.</p>	<ul style="list-style-type: none"> – Press DIM again. (see page 42)
<p>Low hum or buzz sound.</p>	<ul style="list-style-type: none"> – Place the DVD system as far away as possible from electrical devices that may be causing interference.

Analog: Sound that has not been turned into numbers. Analog sound varies, while digital sound has specific numerical values. These jacks send audio through two channels, the left and right.

Aspect ratio: The ratio of vertical and horizontal sizes of a displayed image. The horizontal vs. vertical ratio of conventional TVs is 4:3, and that of wide-screens is 16:9.

AUDIO OUT Jacks: Jacks on the back of the DVD System that send audio to another system (TV, Stereo, etc.).

Bit Rate: The amount of data used to hold a given length of music; measured in kilobits per seconds, or kbps. Or, the speed at which you record. Generally, the higher the bit rate, or the higher the recording speed, the better the sound quality. However, higher bit rates use more space on a Disc.

Chapter: Sections of a picture or a music piece on a DVD that are smaller than titles. A title is composed of several chapters. Each chapter is assigned a chapter number enabling you to locate the chapter you want.

Clear voice: It enables the digital sound processor to extract the voice dynamics in movie dialog on all 5 surround channels without compromising on the location accuracy and the width of the surround sound.

Component Video Out Jacks: Jacks on the back of the DVD System that send high-quality video to a TV that has Component Video In jacks (R/G/B, Y/Pb/Pr, etc.).

Disc menu: A screen display prepared for allowing selection of images, sounds, subtitles, multi-angles, etc recorded on a DVD.

Digital: Sound that has been converted into numerical values. Digital sound is available when you use the DIGITAL AUDIO OUT COAXIAL or OPTICAL jacks. These jacks send audio through multiple channels, instead of just two channels as analog does.

Dolby Digital: A surround sound system developed by Dolby Laboratories containing up to six channels of digital audio (front left and right, surround left and right and center.)

DTS: Digital Theater Systems. This is a surround sound system, but it is different from Dolby Digital. The formats were developed by different companies.

JPEG: A still-picture data compression system proposed by the Joint Photographic Expert Group, which features small decrease in image quality in spite of its high compression ratio.

MP3: A file format with a sound data compression system. "MP3" is the abbreviation of Motion Picture Experts Group 1 (or MPEG-1) Audio Layer 3. By using MP3 format, one CD-R or CD-RW can contain about 10 times as much data volume as a regular CD can.

Multichannel: DVD is specified to have each sound track constitute one sound field. Multichannel refers to a structure of sound tracks having three or more channels.

Parental control: A function of the DVD to limit playback of the disc by the age of the users according to the limitation level in each country. The limitation varies from disc to disc; when it is activated, playback will be prohibited if the software's level is higher than the user-set level.

PCM (Pulse Code Modulation): A system for converting analog sound signal to digital signal for later processing, with no data compression used in conversion.

Playback control (PBC): Refers to the signal recorded on video CDs or SVCDs for controlling reproduction. By using menu screens recorded on a Video CD or SVCD that supports PBC, you can enjoy interactive-type software as well as software having a search function.

Plug and Play: After power up, the system will prompt the user to proceed with the automatic installation of radio stations by simply pressing the PLAY button on the main unit.

Progressive Scan: It displays all the horizontal lines of a picture at one time, as a signal frame. This system can convert the interlaced video from DVD into progressive format for connection to a progressive display. It dramatically increases the vertical resolution. A progressive-scan TV is needed to receive progressive scan output from the player.

Region code: A system for allowing discs to be played back only in the region designated beforehand. This unit will only play discs that have compatible region codes. You can find the region code of your unit by looking on the product label. Some discs are compatible with more than one region (or ALL regions).

S-Video: Produces a clear picture by sending separate signals for the luminance and the color. You can use S-Video only if your TV has S-video In jack.

Sampling Frequency: Frequency of sampling data when analog data is converted to digital data. Sampling frequency numerically represents how many times the original analog signal is sampled per second.

Seating control: It gives the user a perfect sound and movie experience anywhere in the room, providing maximum flexibility and real total immersion because the user can choose their preferred seat.

Surround: A system for creating realistic three-dimensional sound fields full of realism by arranging multiple speakers around the listener.

Title: The longest section of a picture or music feature on DVD, music, etc., in video software, or the entire album in audio software. Each title is assigned a title number enabling you to locate the title you want.

VIDEO OUT jack: Jack on the back of the DVD System that sends video to a TV.

LIMITED WARRANTY

AUDIO SYSTEM

One Year Free Labor

One Year Free Service on Parts

This product must be carried in for repair.

WHO IS COVERED?

You must have proof of purchase to receive warranty service. A sales receipt or other document showing that you purchased the product is considered proof of purchase.

WHAT IS COVERED?

Warranty coverage begins the day you buy your product. For one year thereafter, all parts will be repaired or replaced, and labor is free. After one year from the day of purchase, you pay for the replacement or repair of all parts, and for all labor charges.

All parts, including repaired and replaced parts, are covered only for the original warranty period. When the warranty on the product expires, the warranty on all replaced and repaired parts also expires.

WHAT IS EXCLUDED?

Your warranty does not cover:

- labor charges for installation or setup of the product, adjustment of customer controls on the product, and installation or repair of antenna systems outside of the product.
- product repair and/or part replacement because of misuse, accident, unauthorized repair or other cause not within the control of Philips.
- reception problems caused by signal conditions or cable or antenna systems outside the unit.
- a product that requires modification or adaptation to enable it to operate in any country other than the country for which it was designed, manufactured, approved and/or authorized, or repair of products damaged by these modifications.
- incidental or consequential damages resulting from the product. (Some states do not allow the exclusion of incidental or consequential damages, so the above exclusion may not apply to you. This includes, but is not limited to, prerecorded material, whether copyrighted or not copyrighted.)
- a product that is used for commercial or institutional purposes.

WHERE IS SERVICE AVAILABLE?

Warranty service is available in all countries where the product is officially distributed by Philips. In countries where Philips does not distribute the product, the local Philips service organization will attempt to provide service (although there may be a delay if the appropriate spare parts and technical manual(s) are not readily available).

MAKE SURE YOU KEEP...

Please keep your sales receipt or other document showing proof of purchase. Attach it to this owner's manual and keep both nearby. Also keep the original box and packing material in case you need to return your product.

BEFORE REQUESTING SERVICE...

Please check your owner's manual for assistance. If you have additional questions, call us at 1-800-531-0039.

TO GET WARRANTY SERVICE IN U.S.A., PUERTO RICO, OR U.S. VIRGIN ISLANDS...

Take the product to a Philips factory service center (see enclosed list) or authorized service center for repair. When the product has been repaired, you must pick up the unit at the center. Centers may keep defective parts.

(In U.S.A., Puerto Rico, and U.S. Virgin Islands, all implied warranties, including implied warranties of merchantability and fitness for a particular purpose, are limited in duration to the duration of this express warranty. But, because some states do not allow limitations on how long an implied warranty may last, this limitation may not apply to you.)

TO GET WARRANTY SERVICE IN CANADA...

Please contact Philips at:

1-800-661-6162 (French Speaking)
1-800-531-0039 (English or Spanish Speaking)

(In Canada, this warranty is given in lieu of all other warranties. No other warranties are expressed or implied, including any implied warranties of merchantability or fitness for a particular purpose. Philips is not liable under any circumstances for any direct, indirect, special, incidental or consequential damages, howsoever incurred, even if notified of the possibility of such damages.)

REMEMBER...

Please record below the model and serial numbers found on the product. Also, please fill out and mail your warranty registration card promptly. It will be easier for us to notify you if necessary.

MODEL # _____

SERIAL # _____

This warranty gives you specific legal rights. You may have other rights which vary from state/province to state/province.

Philips, P.O. Box 520890, Miami, FL 33152, USA, (402) 536-4171

EL4965E007 / 8-02

Free Manuals Download Website

<http://myh66.com>

<http://usermanuals.us>

<http://www.somanuals.com>

<http://www.4manuals.cc>

<http://www.manual-lib.com>

<http://www.404manual.com>

<http://www.luxmanual.com>

<http://aubethermostatmanual.com>

Golf course search by state

<http://golfingnear.com>

Email search by domain

<http://emailbydomain.com>

Auto manuals search

<http://auto.somanuals.com>

TV manuals search

<http://tv.somanuals.com>