

User Manual

MAGNAVOX

SMART. VERY SMART.

27MDTR20 20MC4304 19MDTR20

COLOR TV WITH BUILT-IN VCR AND DVD PLAYER

Thank you for choosing
Magnavox.

Need help fast?

Read your Quick Use Guide and/or
Owner's Manual first for quick tips
that make using your Magnavox product
more enjoyable.

If you have read your instructions
and still need assistance,
you may access our online help at

www.magnavox.com
or call

1-800-705-2000
while with your product.

Magnavox vous remercie de
votre confiance.

Besoin d'une aide rapide?

Les Guide d'utilisation rapide et Manuel de
l'utilisateur regorgent d'astuces destinées à
simplifier l'utilisation de votre produit Magnavox.

Toutefois, si vous ne parvenez pas à résoudre
votre problème, vous pouvez accéder à
notre aide en ligne à l'adresse

www.magnavox.com
ou formez le

1-800-661-6162 (Francophone)
1-800-705-2000 (English speaking)

Veillez à avoir votre produit à
portée de main.

Gracias por escoger
Magnavox

Necesita ayuda inmediata?

Lea primero la Guía de uso rápido o el
Manual del usuario, en donde encontrar
consejos que le ayudarán a disfrutar
plenamente de su producto Magnavox.
Si después de leerlo aún necesita ayuda,
consulte nuestro servicio de
asistencia en línea en

www.magnavox.com
o llame al teléfono

1-800-705-2000
y tenga a mano el producto.



27MDTR20



20MC4304



19MDTR20

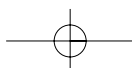

Return your Product Registration Card today to get the very most from your purchase.

Registering your model with MAGNAVOX makes you eligible for all of the valuable benefits listed below, so don't miss out. Complete and return your Product Registration Card at once to ensure:

| | | |
|--|---|--|
| <p>*Proof of Purchase Returning the enclosed card guarantees that your date of purchase will be on file, so no additional paperwork will be required from you to obtain warranty service.</p> | <p>*Product Safety Notification By registering your product, you'll receive notification - directly from the manufacturer - in the rare case of a product recall or safety defect.</p> | <p>*Additional Benefits of Product Ownership Registering your product guarantees that you'll receive all of the privileges to which you're entitled, including special money-saving offers.</p> |
|--|---|--|

MAGNAVOX

Congratulations on your purchase, and welcome to the "family!"

Dear MAGNAVOX product owner:

Thank you for your confidence in MAGNAVOX. You've selected one of the best-built, best-backed products available today. We'll do everything in our power to keep you happy with your purchase for many years to come.



As a member of the MAGNAVOX "family," you're entitled to protection by one of the most comprehensive warranties and outstanding service networks in the industry. What's more, your purchase guarantees you'll receive all the information and special offers for which you qualify, plus easy access to accessories from our convenient home shopping network.

Most importantly, you can count on our uncompromising commitment to your total satisfaction.

All of this is our way of saying welcome - and thanks for investing in a MAGNAVOX product.

P.S. To get the most from your MAGNAVOX purchase, be sure to complete and return your Product Registration Card at once.

Know these
safety symbols

| | | |
|---|---|---|
|  | CAUTION RISK OF ELECTRIC SHOCK DO NOT OPEN |  |
|---|---|---|

CAUTION:
TO REDUCE THE RISK OF ELECTRIC SHOCK, DO NOT REMOVE COVER (OR BACK). NO USER SERVICEABLE PARTS INSIDE. REFER SERVICING TO QUALIFIED SERVICE PERSONNEL.

 This "bolt of lightning" indicates uninsulated material within your unit may cause an electrical shock. For the safety of everyone in your household, please do not remove product covering.

 The "exclamation point" calls attention to features for which you should read the enclosed literature closely to prevent operating and maintenance problems.

WARNING: TO REDUCE THE RISK OF FIRE OR ELECTRIC SHOCK, THIS APPARATUS SHOULD NOT BE EXPOSED TO RAIN OR MOISTURE, AND OBJECTS FILLED WITH LIQUIDS, SUCH AS VASES, SHOULD NOT BE PLACED ON THIS APPARATUS.

CAUTION: To prevent electric shock, match wide blade of plug to wide slot, fully insert.

ATTENTION: Pour éviter les choc électriques, introduire la lame la plus large de la fiche dans la borne correspondante de la prise et pousser jusqu'au fond.

For Customer Use

Enter below the Serial No. which is located on the rear of the cabinet. Retain this information for future reference.

Model No. _____

Serial No. _____

MAGNAVOX Visit our World Wide Web Site at <http://www.magnavox.com>

Safety and General Information 3

Safety Precautions

- Do not stand the unit up vertically. Install the unit in a horizontal and stable position.
- Be sure to remove the disc and unplug the AC power cord from the output before carrying the unit.

Warning: To prevent fire or shock hazard, do not expose this equipment to rain or moisture.

Federal Communications Commission (FCC) Warning: Any unauthorized changes or modifications to this equipment void the user's authority to operate it.

Laser Safety: This unit employs a laser. Only a qualified service person should remove the cover or attempt to service this device, due to possible eye injury.

CAUTION: USE OF CONTROLS OR ADJUSTMENTS OR PERFORMANCE OF PROCEDURES OTHER THAN THOSE SPECIFIED HEREIN MAY RESULT IN HAZARDOUS RADIATION EXPOSURE.
CAUTION: VISIBLE AND INVISIBLE LASER RADIATION WHEN OPEN AND INTERLOCK DEFEATED. DO NOT STARE INTO BEAM. THE BEAM IS LOCATED INSIDE, NEAR THE DECK MECHANISM.

Special Information for Canadian Users: This Class B digital apparatus complies with Canadian ICES-003. Cet appareil numérique de la classe B est conforme à la norme NMB-003 du Canada.

Radio/TV Interference: This equipment has been tested and found to comply with the limits for a Class B digital device, pursuant to Part 15 of the FCC Rules. These limits are designed to provide reasonable protection against harmful interference in a residential installation. This equipment generates, uses, and can radiate radio frequency energy and, if not installed and used in accordance with the instructions, may cause harmful interference to radio communications. However, there is no guarantee that interference will not occur in a particular installation. If this equipment does cause harmful interference to radio or television reception, which can be determined by turning the equipment off and on, the user is encouraged to try to correct the interference by one or more of the following measures:

- 1) Reorient or relocate the receiving antenna.
- 2) Increase the separation between the equipment and the receiver.
- 3) Connect the equipment into an outlet on a circuit different from that to which the receiver is connected.
- 4) Consult the dealer or an experienced radio/TV technician for help.

Copyright Protection: Unauthorized copying, broadcasting, public performance and lending of discs are prohibited. "This product incorporates copyright protection technology that is protected by U. S. patents and other intellectual property rights. Use of this copyright protection technology must be authorized by Macrovision, and is intended for home and other limited viewing uses only unless otherwise authorized by Macrovision. Reverse engineering or disassembly is prohibited."

Note to the Cable TV System Installer: This reminder calls the Cable TV system installer's attention to Article 820-40 of the National Electrical Code, which provides guidelines for proper grounding – in particular, specifying that the cable ground shall be connected to the grounding system of the building, as close to the point of cable entry as possible.

Declaration of Conformity

Model Number: 27MDTR20
20MC4304
19MDTR20
Trade Name: Magnavox
Responsible Party: Philips Consumer Electronics North America
P.O. Box 671539
Marietta, GA 30006-0026
1-800-705-2000

Manufactured under license from Dolby Laboratories. "Dolby" and the double-D symbol are trademarks of Dolby Laboratories.
Copyright 2005 Magnavox. All rights reserved.

4 Safety and General Information (cont'd)

IMPORTANT SAFETY INSTRUCTIONS

Read before operating equipment

1. Read these instructions.
2. Keep these instructions.
3. Heed all warnings.
4. Follow all instructions.
5. Clean only with a dry cloth.
7. Do not block any of the ventilation openings. Install in accordance with the manufacturer's instructions.
8. Do not install near any heat sources such as radiators, heat registers, stoves, or other apparatus (including amplifiers) that produce heat.
9. Do not defeat the safety purpose of the polarized or grounding-type plug. A polarized plug has two blades with one wider than the other. A grounding type plug has two blades and a third grounding prong. The wide blade or third prong are provided for your safety. When the provided plug does not fit into your outlet, consult an electrician for replacement of the obsolete outlet.
10. Protect the power cord from being walked on or pinched particularly at plugs, convenience receptacles, and the point where they exit from the apparatus.
11. Only use attachments/accessories specified by the manufacturer.
12.  Use only with a cart, stand, tripod, bracket, or table specified by the manufacturer, or sold with the apparatus. When a cart is used, use caution when moving the cart/apparatus combination to avoid injury from tip-over.
13. Unplug this apparatus during lightning storms or when unused for long periods of time.
14. Refer all servicing to qualified service personnel. Servicing is required when the apparatus has been damaged in any way, such as power-supply cord or plug is damaged, liquid has been spilled or objects have fallen into apparatus, the apparatus has been exposed to rain or moisture, does not operate normally, or has been dropped.
15. This product may contain lead and mercury. Disposal of these materials may be regulated due to environmental considerations. For disposal or recycling information, please contact your local authorities or the Electronic Industries Alliance: www.eiae.org
16. **Damage Requiring Service** - The appliance should be serviced by qualified service personnel when:
 - A. The power supply cord or the plug has been damaged; or
 - B. Objects have fallen, or liquid has been spilled into the appliance; or
 - C. The appliance has been exposed to rain; or
 - D. The appliance does not appear to operate normally or exhibits a marked change in performance; or
 - E. The appliance has been dropped, or the enclosure damaged.
17. **Tilt/Stability** - All televisions must comply with recommended international global safety standards for tilt and stability properties of its cabinet design.
 - Do not compromise these design standards by applying excessive pull force to the front, or top, of the cabinet which could ultimately overturn the product.
 - Also, do not endanger yourself, or children, by placing electronic equipment/toys on the top of the cabinet. Such items could unsuspectingly fall from the top of the set and cause product damage and/or personal injury.
18. **Wall or Ceiling Mounting** - The appliance should be mounted to a wall or ceiling only as recommended by the manufacturer.
19. **Power Lines** - An outdoor antenna should be located away from power lines.
20. **Outdoor Antenna Grounding** - If an outside antenna is connected to the receiver, be sure the antenna system is grounded so as to provide some protection against voltage surges and built up static charges. Section 810 of the National Electric Code, ANSI/NFPA No. 70-1984, provides information with respect to proper grounding of the mast and supporting structure, grounding of the lead-in wire to an antenna discharge unit, size of grounding connectors, location of antenna-discharge unit, connection to grounding electrodes, and requirements for the grounding electrode. See Figure below.
21. **Object and Liquid Entry** - Care should be taken so that objects do not fall and liquids are not spilled into the enclosure through openings.
 - a) **Warning:** To reduce the risk of fire or electric shock, this apparatus should not be exposed to rain or moisture and objects filled with liquids, such as vases, should not be placed on this apparatus.
22. **Battery Usage CAUTION** - To prevent battery leakage that may result in bodily injury, property damage, or damage to the unit:
 - Install all batteries correctly, with + and - aligned as marked on the unit.
 - Do not mix batteries (old and new or carbon and alkaline, etc.).
 - Remove batteries when the unit is not used for a long time.

Note to the CATV system installer: This reminder is provided to call the CATV system installer's attention to Article 820-40 of the NEC that provides guidelines for proper grounding and, in particular, specifies that the cable ground shall be connected to the grounding system of the building, as close to the point of cable entry as practical.

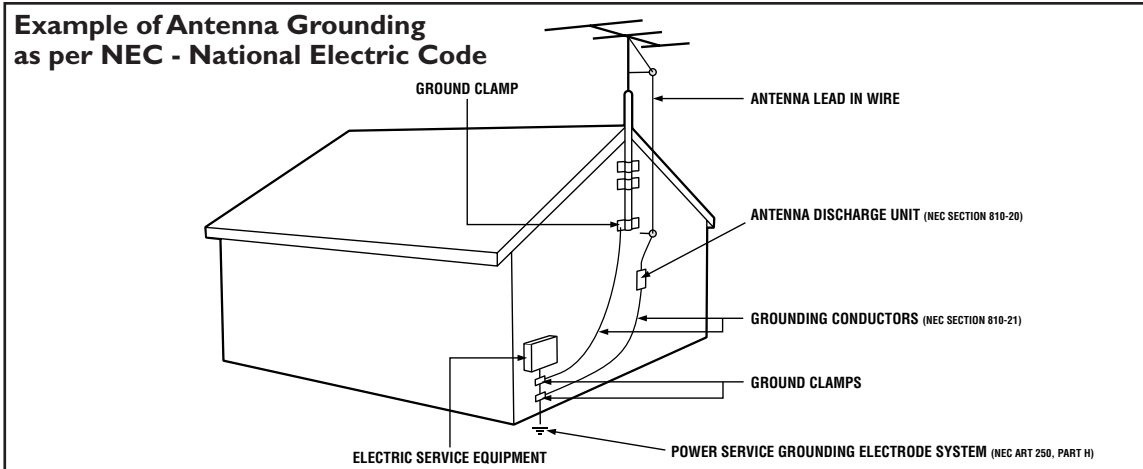

Table of Contents 5

General Information

| | |
|--------------------------------|-----|
| Safety and General Information | 3-4 |
| Table of Contents | 5 |
| Introduction | 6 |
| Playable Discs and Videotapes | 7 |

Initial Setup and Use

| | |
|-----------------------------|------|
| Before Using the TV/VCR/DVD | 8 |
| Hooking Up the TV/VCR/DVD | 9-10 |
| Optional Connections | 11 |
| Watching TV | 12 |
| Playing a Videotape | 13 |
| Playing a Disc | 14 |

Description of Controls

| | |
|------------------------|-------|
| Remote Control Buttons | 15-16 |
| Front Panel | 17 |
| Rear Panel | 18 |

TV Settings

| | |
|---|-------|
| Menu Language, Auto Channel Programming | 19 |
| Adding/Deleting Channels | 20 |
| Setting the Clock | 21-24 |
| Daylight-Savings Time | 25 |
| Status Displays, Picture Controls | 26 |

Recording

| | |
|--------------------------------|-------|
| Videotape Recording | 27 |
| One-Touch Recording | 28 |
| Timer Recording | 29-32 |
| Timer Recording Auto Return | 33 |
| Rerecording (Tape Duplication) | 34 |

Videotape Features

| | |
|------------------------------|----|
| Repeat Playback | 35 |
| Rental Playback | 36 |
| Zero Return, Sleep Timer | 37 |
| Time Search | 38 |
| Index Search | 39 |
| Videotape Playback Features | 40 |
| Automatic Operation Features | 41 |

Additional TV Features

| | |
|--------------------------------------|-------|
| Closed Captions | 42 |
| Setting V-Chip | 43-48 |
| Multi-Channel Television Sound (MTS) | 49-51 |

Disc Features

| | |
|--|-------|
| DVD Disc Menus, Title Menus | 52 |
| Fast Forward/Reverse Search | 53 |
| Title/Chapter Playback, Specific Time Playback | 54 |
| Track Playback | 55 |
| Paused and Step-by-Step Playback, Resume On | 56 |
| Repeat, A-B Repeat | 57 |
| Markers | 58 |
| Subtitles, Camera Angles | 59 |
| Slow Motion, Zoom | 60 |
| Audio Language, Stereo Sound | 61 |
| On-Screen Displays | 62-63 |
| Black Level, Virtual Surround, Initializing | 64 |
| Random Playback, Program Playback | 65 |
| MP3/JPEG Playback | 66-67 |

DVD Setup Features

| | |
|-------------------|-------|
| Language Settings | 68-69 |
| Display Settings | 70-71 |
| Audio Settings | 72 |
| Parental Password | 73-74 |
| Parental Levels | 75-76 |
| Others | 77-78 |

Information You May Need

| | |
|------------------|-------|
| Glossary | 79 |
| Helpful Hints | 80-81 |
| Specifications | 82 |
| Limited Warranty | 83 |
| Index | 84 |

6 Introduction

Welcome to your TV/VCR/DVD owner's manual.

This manual describes the 27MDTR20, 20MC4304 and 19MDTR20. These three models are different in size and design, but operate identically. The 20MC4304 is illustrated in this manual.

Features - TV/VCR

- Automatic Channel Setup
- Automatic Head Cleaner
- Automatic Tracking Adjustment
- Closed Captions
- Daylight-Savings Time
- English, Spanish or French Setup Menus
- Forward/Reverse Searching; Still
- High Quality (HQ) System
- Index Search
- One-Touch Recording
- Real-Time Videotape Counter
- Rental Playback
- Repeat Playback
- Sleep Timer
- Timer Recording
- Time Search
- V-Chip (Parental Controls)
- Zero Return

Features - Discs

- Audio Language choices *
- Bit Rate display
- Camera Angle *
- Dolby Digital Sound *
- Dual Playback
- Dynamic Range Control
- Fast/Paused/Slow/Step-by-Step Playback
- JPEG Playback
- Markers
- MP3 Playback
- Parental Controls *
- Program Playback (Audio CD, MP3, JPEG)
- Random Playback (Audio CD, MP3, JPEG)
- Repeat (A-B, Chapter, Title, Track, Group, Disc)
- Search (Title/Chapter, Time, Track)
- Subtitles *
- Virtual Surround
- Zoom

* If available on the disc

DVD Disc Menus...

Some explanations in this manual describe DVD disc menus. DVD manufacturers set the menus, which vary among DVDs. Not all DVDs have menus. If the DVD has a menu, access it by pressing DISC MENU on the remote control.

Details are on page 52.

Setup Menus...

Some instructions explain how to use the setup menus of the TV/VCR/DVD. There are two setup menus: one for the TV/VCR features while the unit is in TV/VCR mode, and one for the disc features while the unit is in DVD mode. Access the setup menus by pressing SETUP on the remote control.

While in TV/VCR mode, you can select only the TV/VCR SETUP menu.

In DVD mode, you can select both the TV/VCR SETUP menu and the SETUP menu for the unit's DVD player. Press SETUP once to select the TV/VCR SETUP menu. Press SETUP twice to get to the DVD player's SETUP menu.

Even if you set a DVD feature in the unit's SETUP menu, it will not be available if the current disc does not include that feature.

Available Disc Features...



All features described in this manual are not available on every disc. If the feature is not available on the disc, you cannot use the TV/VCR/DVD to make it available.

An "X" will appear in the top right corner of the screen if you try to access a feature that is not available.

For example, some features are available only during playback, while others are available only if playback is stopped. If you cannot access a feature, try stopping or starting playback, then try the feature again.

Playable Discs and Videotapes 7

Playable Discs

The DVD player of this TV/VCR/DVD will play many types of discs, including Digital Video Discs (DVDs) and Audio Compact Discs (CDs). It will play MP3 and JPEG files as well.

To play a DVD, make sure it meets the requirements for Region Codes and Color Systems as described below. Discs that have the following logos will play on the DVD player of this TV/VCR/DVD. Finalize CD-R, CD-RW, DVD+R and DVD+RW Discs before playing them in the TV/VCR/DVD.

- A disc may not play properly if the disc's recorded area is less than 55mm across.
- Do not glue paper or put stickers on to the disc. These may damage the disc, and the TV/VCR/DVD may not read it correctly.



DVD: Prerecorded Digital Video Discs



CD-R/RW: Compact Disc Recordable/Rewritable.
CD-Rs can be recorded on only once.
CD-RWs can be recorded on multiple times.



Audio CDs



MP3: Digital audio files recorded on a CD-R or CD-RW



DVD+R: DVD Recordable.
DVD+Rs can be recorded on only once.



Video CDs



DVD+RW: DVD Rewritable.
DVD+RWs can be recorded on multiple times.

DVD is a trademark of DVD Format/Logo Licensing Corporation.

This unit is not compatible with Multiple Bit Rate (MBR: a file that contains the same content encoded at several different bit rates).

Region Codes

This TV/VCR/DVD has a Region One (1) DVD player. DVDs must be labeled for ALL regions or for Region 1 in order to play on the unit. You cannot play DVDs that are labeled for other regions. Look for the symbols below on your DVDs. If these region symbols do not appear on your DVD, you cannot play the DVD in this TV/VCR/DVD.



The number inside the globe refers to a region of the world. Region 1 represents the United States, Canada, upper regions of North America, Bermuda, the U.S. Virgin Islands and small regions near Australia. A DVD labelled for a specific region can only play on DVD players with the same region code.

Color Systems

DVDs are recorded in different color systems throughout the world. The most common color systems are NTSC (which is used primarily in the United States and North America), PAL and SECAM. The DVD player of this unit uses NTSC, so DVDs you play must be recorded in the NTSC color system. You cannot play DVDs recorded in other formats. The color system of the DVD may be listed on the DVD or on the disc case.

Unacceptable Discs

If you insert an unacceptable type of disc, a Disc Error message may appear on the TV screen. The following discs will not play on this DVD player.

- CD-ROM
- Compact Disc-Interactive (CD-I)
- Unfinalized Discs
- DVD/CD contains Windows Media™ Audio
- DVD-RAM
- Video Single Disc (VSD)
- DVD contains MP3 or JPEG files
- DVD-ROM
- DVD-Audio

On the following disc, the sound may not be heard.

- Super Audio CD - Only the sound on the CD layer can be heard. The sound on the high-density Super Audio CD layer cannot be heard.

Videotapes

Magnavox recommends you use only videotapes that have the **VHS** mark. Other videotapes may have poor picture quality and cause excessive deposits on the video heads. The warranty may not cover such damage. The VCR of this TV/VCR/DVD has a High Quality (HQ) system and is compatible with existing Video Home System (VHS) equipment.

8 Before Using the TV/VCR/DVD

Remote Control Battery Installation

- 1** Remove the battery compartment lid on the bottom of the remote control. Slide the lid down and off. Follow the direction of the arrow on the lid.
- 2** Place two AA batteries inside the battery compartment. Align the + and – ends as indicated.
- 3** Replace the battery compartment lid.

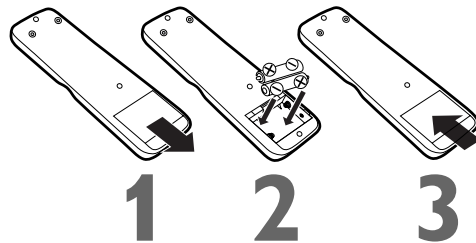

Battery Safety

Battery Usage CAUTION - To prevent battery leakage that may result in bodily injury, property damage or damage to the unit:

- Install ALL batteries correctly, with the + and – markings on the battery aligned as indicated on the unit;
- Do not mix batteries, for example, old with new or carbon with alkaline; and
- Remove batteries when the unit will not be used for a long time.

Recording Prevention

Videotapes have record tabs to ensure you do not erase recordings accidentally.

- 1** To prevent accidental recording, break off the tab with a screwdriver.
- 2** To record again, cover the hole with cellophane tape.

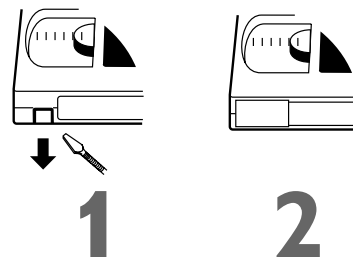

Using the Remote Control

- Point the remote control at the remote sensor on the front of the TV/VCR/DVD. *Details are on page 17.*
- Do not put objects between the remote control and the TV/VCR/DVD.

TV/VCR/DVD Maintenance

- Remove any light adhesive stick-on notes from the video cassette before putting the cassette in the TV/VCR/DVD. Removable labels can jam the TV/VCR/DVD.
- The TV/VCR/DVD requires periodic maintenance to maintain its excellent performance. This TV/VCR/DVD has an internal head cleaning system. However, the video heads will eventually require cleaning or replacement. Only an authorized service center should perform this service.

Helpful Hint

- Your new product, its packaging and this manual contain materials that can be recycled and reused. Specialized companies can recycle your product to increase the amount of reusable materials and to minimize the amount that needs to be properly disposed. Your product uses batteries that should not be thrown away when depleted but should be disposed of as small chemical waste. Please find out about the local regulations on disposal of your old product, batteries, manual and packaging when you replace existing equipment.

Hooking Up the TV/VCR/DVD 9

1 Hook up your TV/VCR/DVD using one of the connections shown.

A Hooking Up Your TV/VCR/DVD with a Cable TV Signal or Outdoor Antenna

Connect a Cable TV signal or an antenna to the ANT(enna) Jack.

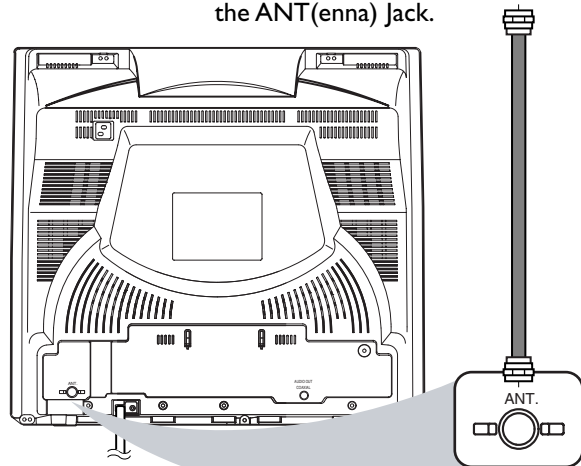

B Hooking Up Your TV/VCR/DVD with a Cable Box/Satellite Receiver

To view any channel, set the TV/VCR/DVD to the output channel (channel 03 or 04) of the Cable Box/Satellite Receiver. Then, select channels at the Cable Box/Satellite Receiver.

Connect the Cable TV or Satellite signal to the IN Jack on the Cable Box/Satellite Receiver.

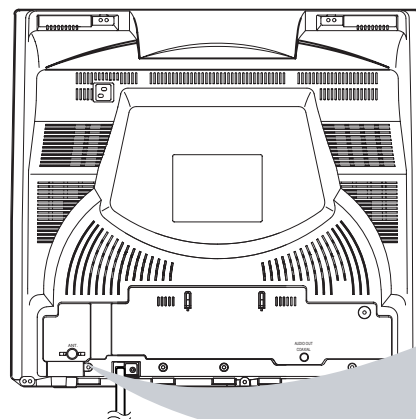

Connect an RF coaxial cable (not supplied) to the OUT Jack on the Cable Box/Satellite Receiver and to the ANT(enna) Jack on the TV/VCR/DVD.

Your Cable Box/Satellite Receiver may have Audio and Video Out jacks instead of the single Antenna Out jack (RF coaxial or 75 ohm) shown here. If so, connect Audio and Video cables to the Audio/Video Out jacks of the Cable Box/Satellite Receiver and to the AUDIO/VIDEO In jacks on the front of the TV/VCR/DVD. Press SELECT on the remote to set the TV/VCR/DVD to AUX, not channel 3 or 4. Select channels you want to watch or record at the Cable Box/Satellite Receiver as usual, leaving the TV/VCR/DVD on AUX.

Instructions continue on the next page.

10 Hooking Up the TV/VCR/DVD (cont'd)

Instructions continued from the previous page.

C Hooking Up Your TV/VCR/DVD with an Indoor Antenna

To install an indoor antenna or "rabbit ears" (not supplied), connect the antenna wire to the ANT(enna) Jack on the back of the TV/VCR/DVD as shown. Extend the antenna and adjust its length, direction and angle for the clearest picture.

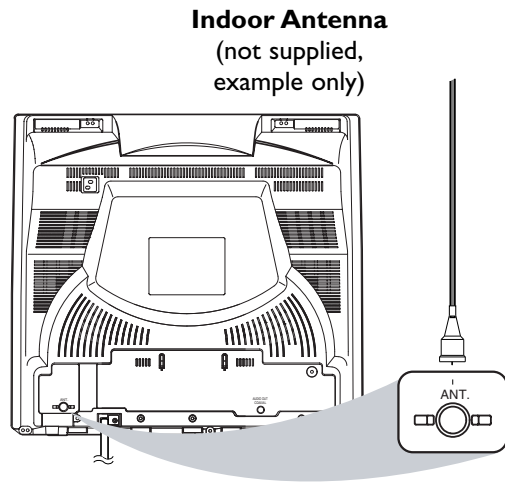

D Hooking Up Your TV/VCR/DVD to Another Video Source (VCR, DVD player, Camcorder, etc.)

You may need this connection if you want to play discs or tapes on other equipment but watch them on the TV/VCR/DVD. Press SELECT on the remote to select AUX at the TV/VCR/DVD. When you play the materials on the other equipment, it will show on the TV/VCR/DVD's AUX channel. *More details are on page 34.*

Audio and video cables are not supplied.

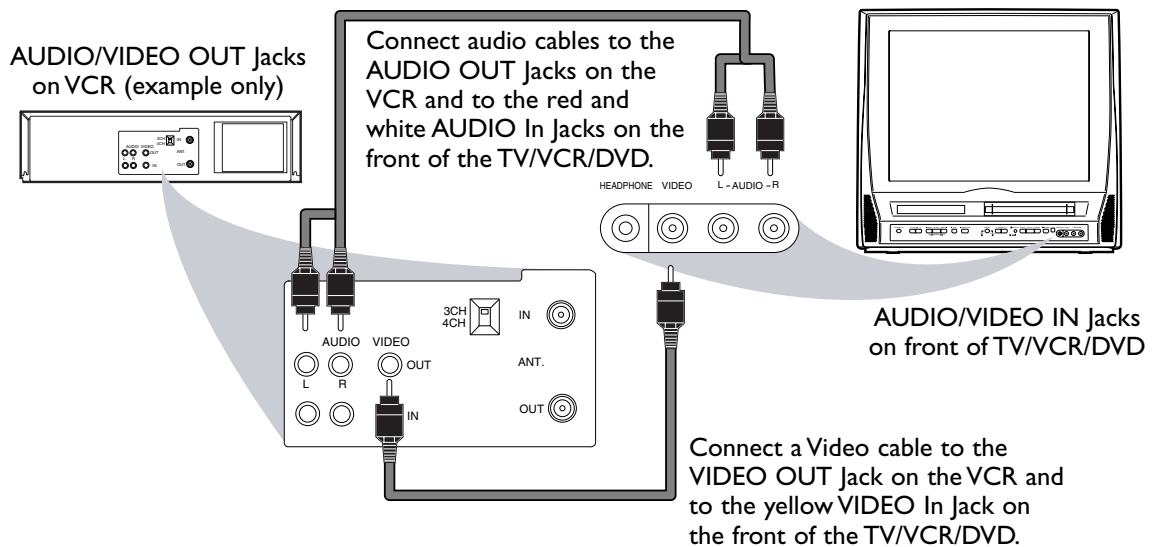

2 When all other connections are complete, plug in the TV/VCR/DVD's power cord.

Optional Connections 11

Digital Stereo Hookups

You can connect the TV/VCR/DVD to a Stereo that has a Digital Coaxial In jack. Use this hookup if you want to hear the TV/VCR/DVD sound through the Stereo instead. Use these connections for a Dolby Digital-compatible Stereo or for a Receiver that has a Mini-Disc or Digital Audio Tape deck.

- 1** Connect the antenna/Cable TV signal. Details are on pages 9-10.
- 2** Connect a digital audio coaxial cable (not supplied) to the **AUDIO OUT COAXIAL** jack on the TV/VCR/DVD. Also connect the cable to the Stereo's **COAXIAL DIGITAL AUDIO IN** jack.
- 3** If the Stereo is Dolby Digital-compatible, set **DOLBY DIGITAL** to **BITSTREAM**. If the Stereo is not Dolby Digital-compatible or if you connected to a Mini-Disc or Digital Audio Tape Deck, set **DOLBY DIGITAL** to **PCM**. Details are on page 72. An incorrect setting causes noise distortion and damages speakers.

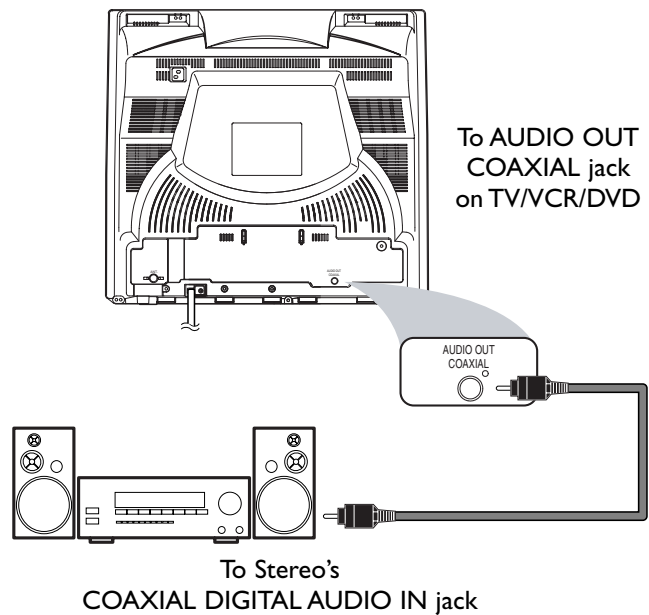

Helpful Hints

- You cannot use a Mini-Disc or Digital Audio Tape deck to copy Dolby Digital 5.1 channel surround sound discs.
- If the disc is not recorded in Dolby Digital 5.1 channel surround sound, you will not hear multi-channel sound even if you use the Digital Stereo hookup.
- To see if your disc is recorded in Dolby Digital, look for a Dolby Digital logo on disc or on its case.
- To see if your Stereo has Dolby Digital, look for a Dolby Digital logo on your Stereo. Or, refer to the Stereo owner's manual.

12 Watching TV

The unit selects available TV channels automatically when you connect an Antenna or Cable TV signal to it. To reset TV channels, see page 20.

If you are using a Cable Box or Satellite Receiver, you do not need to set channels at the TV/VCR/DVD.

1 Press **STANDBY-ON** to turn on the TV/VCR/DVD.

2 To watch TV, press **CH. ▲/▼** to select memorized channels. Memorized channels are those that appear when you flip through channels. If a channel is skipped, you still can use the Number buttons to select it. This is a non-memorized channel; it may have weak reception in your area.

To update your memorized and non-memorized channels, see page 19.

Remember, if you are using a Cable Box/Satellite Receiver, set the TV/VCR/DVD to channel 3, 4 or AUX. Change channels at the Cable Box/Satellite Receiver.

3 Press **VOL. ▲/▼** to adjust the volume.

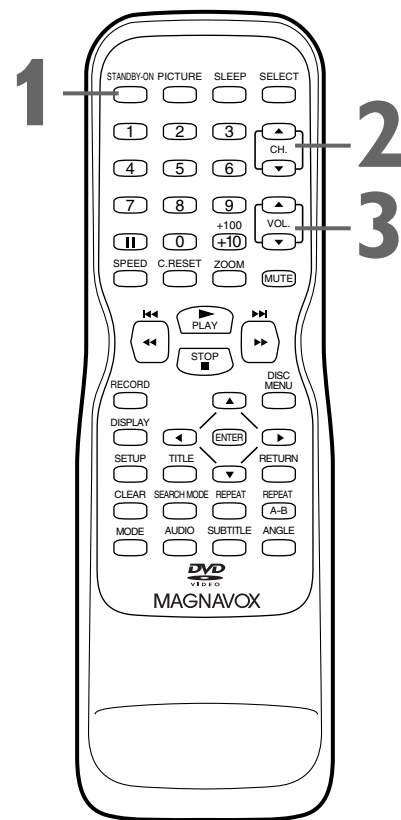
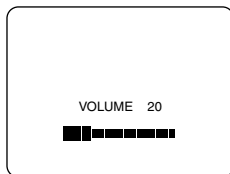

Playing a Videotape 13

Follow these steps to simply play a videotape. *Videotape playback options are on pages 35-41.*

- 1** Insert a videotape in the cassette compartment of the TV/VCR/DVD. The power will come on. If the tape's record tab is missing, playback should start automatically.
- 2** If playback does not start automatically, press **PLAY ►** to start playback.
- 3** Press **STOP ■** to stop playback.
- 4** Press **◀◀ / ◀◀** to rewind the tape.
Press **▶▶ / ▶▶** to fast forward the tape.
- 5** Press **STOP/EJECT ■/▲** on the front of the TV/VCR/DVD to remove the tape.

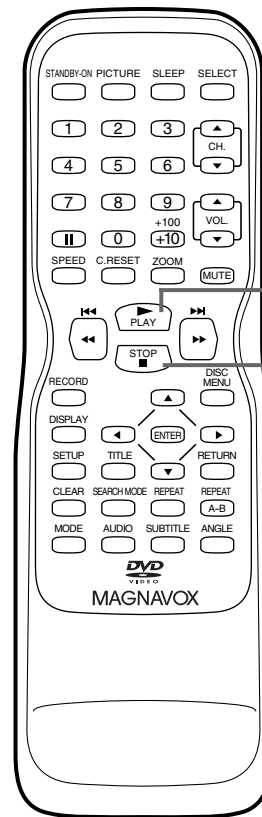

Helpful Hints

- If the tape you want to play is already in the TV/VCR/DVD, turn on the power. Press **SELECT** to choose TV/VCR mode (the red VCR/TV light will be on), then press **PLAY ►**.
- When you play an S-VHS format tape, you cannot get the high resolution that would be available on an S-VHS VCR. Noise lines (black and white streaks) may appear in the picture.
- If you press **SELECT** while playing a videotape, playback will stop and the unit will switch to DVD mode. This will happen also if you press **PLAY ►** (DVD) or **OPEN/CLOSE ▲** (DVD) on the front of the TV/VCR/DVD during videotape playback.

14 Playing a Disc

Before you begin, turn on the power of other equipment connected to the TV/VCR/DVD. Set a stereo (if applicable) to the correct sound source or channel. *Details are on page 11.*

- 1** Press **STANDBY-ON** to turn on the **TV/VCR/DVD**. The unit will be in TV/VCR mode. The red VCR/TV light will be on.
- 2** Press **SELECT** repeatedly to put the **TV/VCR/DVD** in **DVD mode**. The green DVD light will appear on the front of the TV/VCR/DVD.
- 3** Press **OPEN/CLOSE ▲** on the front of the **TV/VCR/DVD** to open the disc tray.
- 4** Place a disc into the tray.
Some DVDs are recorded on both sides. Make sure the label of the side you want to play is facing up.
Or, if the DVD is recorded on only one side, place the disc in the tray with the label facing up and the shiny side facing down.

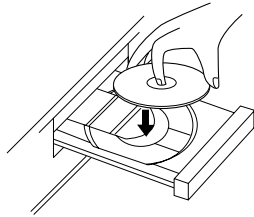

- 5** Press **PLAY ►** to close the tray. The tray will close and playback will begin. If playback does not start automatically, press **PLAY ►** again.
If a DVD menu appears instead, see *page 52*.
To play MP3 or JPEG files, see *page 66*.
You also can close the tray by pressing **OPEN/CLOSE ▲**.
- 6** Press **STOP ■** to stop playback. If playback remains stopped for 5 minutes, the DVD screen will dim. If playback is stopped for 20 minutes with no activity at the TV/VCR/DVD, the unit will turn off.

REMINDER: Only certain discs will play.
See *page 7* for details.

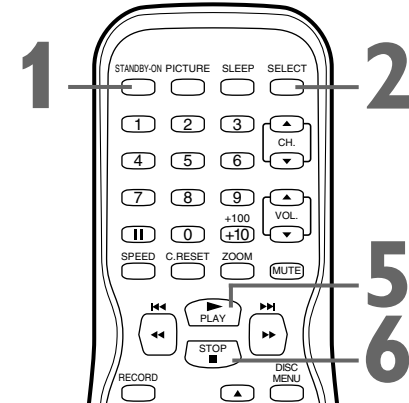

- 3** Press **OPEN/CLOSE ▲** on the front of the **TV/VCR/DVD**.
- 4** Insert a disc.

Helpful Hints

- Even if you turn off the unit in DVD mode, if you turn it on again with the **STANDBY-ON** button, it will be in TV/VCR mode. If the unit was shut down by unplugging the power cord or due to a power failure, it will be in DVD mode when you turn it on again.
- An "X" will appear on the screen when you try to access a feature that is not available. This is not a problem with the TV/VCR/DVD.
- If a disc is dirty or scratched, the picture may be distorted or playback may stop. Remove the disc and try a different one.
- Press **OPEN/CLOSE ▲** (DVD) or **PLAY ►** (DVD) on the front of the TV/VCR/DVD when the power is off. This turns on the unit in DVD mode (not TV/VCR mode).
- If a disc has multiple layers, the picture may freeze occasionally. This happens when the first layer switches to the second layer. This is not a malfunction.
- Pressing **SELECT** during disc playback stops disc playback and switches the unit to TV/VCR mode. Pressing **PLAY ►** (VCR) on the front of the unit during disc playback stops disc playback and starts tape playback.

Remote Control Buttons 15

PICTURE Button

Press to access the picture controls. *Details are on page 26.*

STANDBY-ON Button

Press to turn on or off the TV/VCR/DVD.

Number Buttons

TV Mode: Press two digits to access a specific channel. Press 0 before the number of a single-digit channel. *Details are on page 12.*

+100/+10 button: To select channels 100 or higher, press +100/+10, then the Number buttons of the last 2 digits of the channel number.

DVD Mode: Use the Number buttons to enter a track or chapter number.

+100/+10 button: Press before entering double-digit numbers. For example, to select chapter 16, press +100/+10, then 1, 6.

II (pause) Button

Press to pause videotape recording. Press again to resume recording. *Details are on page 27.*

Press to pause videotape or DVD playback. Press repeatedly to advance the picture one frame at a time. *Details are on pages 40 and 56.*

RECORD Button

Press once to start a recording on videotape. *Details are on page 27.*

DISPLAY Button

TV/VCR Mode: Press to see the videotape counter, channel or time on the screen. *Details are on page 26.*

DVD Mode: Press to see the disc status on the screen. *Details are on page 62.*

TITLE Button

Press to access a DVD's title menu if available. *Details are on page 52.*

SLEEP Button

Press to set the Sleep Timer. *Details are on page 37.*

SELECT Button

Press to choose AUX, TV/VCR or DVD mode. The corresponding light will appear on the front of the TV/VCR/DVD to indicate which mode is active. *Details are on page 17.*

PLAY ► Button

Press to start playing a disc or video cassette. *Details are on pages 13-14.*

▶▶ / ▶▶▶ Button

During disc playback, press briefly to skip to the next track or chapter. *Details are on page 55.* Or, press and hold for 2 seconds to search forward during disc playback. *Details are on page 53.* Press to forward a videotape. *Details are on page 40.*

STOP ■ Button

Press to stop disc or videotape playback.

Arrow Buttons

Use the Arrow buttons to select or adjust menu items.

RETURN Button

Press to go to the previous Setup menu in DVD or TV/VCR mode. Press to remove some menus or displays.

REPEAT Button

Press to play a disc, title, chapter or track repeatedly. *Details are on page 57.*

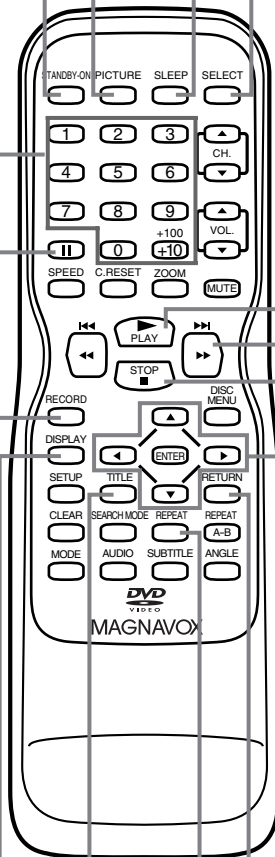

16 Remote Control Buttons (cont'd)

ZOOM Button

Press to enlarge the picture during DVD playback. *Details are on page 60.*

C.RESET (counter reset) Button

Press to reset the tape counter to 0:00:00. *Details are on page 37.*
Press to cancel a Timer Recording. *Details are on page 32.*

SPEED Button

Press to choose a tape recording speed (SP or SLP). *Details are on page 27.*

⏮ / ⏪ Button

During disc playback, press briefly to skip to the beginning of the current track/chapter. Press repeatedly to skip to previous tracks/chapters. *Details are on page 55.*
Or, press and hold for 2 seconds to search backward during disc playback. *Details are on page 53.*
Press to reverse a videotape. *Details are on page 40.*

SETUP Button

Press to access or remove the TV/VCR/DVD's Setup menu.

CLEAR Button

Press to reset or erase a setting or wrong information.

MODE Button

Press to play a program or to start Random playback. *Details are on page 65.*
Press to select a Black Level or Virtual Surround setting. *Details are on page 64.*

SEARCH MODE Button

Press to find a specific time, chapter, track or title on a disc. *Details are on pages 54-55.*
Press to set up Markers. *Details are on page 58.*

CH. (channel) ▲/▼ Buttons

Press to select memorized TV channels. *Details are on page 12.*

VOL. (volume) ▲/▼ Buttons

Press to adjust the volume.

MUTE Button

Press to mute or restore the sound.

DISC MENU Button

Press to access DVD disc menus. *Details are on page 52.*

ENTER Button

Press to accept or change a menu setting.

REPEAT A-B Button

Press to set a section of a disc to play repeatedly. *Details are on page 57.*

ANGLE Button

Press to change the camera angle and watch a disc sequence from a different perspective. *Details are on page 59.*

SUBTITLE Button

Press to select a subtitle language. *Details are on page 59.*

AUDIO Button

Press to select an audio language during DVD playback.
Press to select a sound mode during Audio CD or Video CD playback. *Details are on page 61.*
Press to select STEREO, SAP or MONO while receiving MTS broadcast.
Press to switch MONO/HIFI during playback of a videotape. *Details are on pages 50 and 51.*

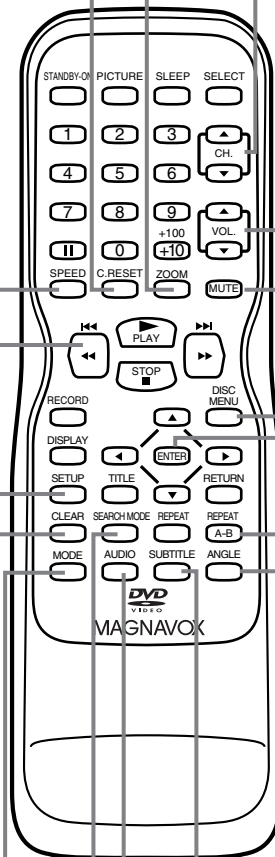

Front Panel 17

Front design varies slightly among models.

Cassette Compartment

Insert a videotape here.

Disc Tray

Insert a disc here.

CHANNEL ▲/▼ Buttons

Press to select TV channels.

Details are on page 12.

OPEN/CLOSE ▲ Button (DVD)

Press to open or close the disc tray.

Details are on page 14.

STOP ■ Button (DVD)

Press to stop disc playback.

Details are on page 14.

VOLUME ▲/▼ Buttons

Press to adjust the volume.

STANDBY-ON Button

Press to turn the TV/VCR/DVD on or off. Turn off the TV/VCR/DVD for a timer recording.

PLAY ► Button (DVD)

Press to start disc playback.

Details are on page 14.

PREV ◀◀,

NEXT ▶▶| Buttons (DVD)

Press to go to a different chapter or track. Details are on page 55.

DVD light (green)

Appears if the TV/VCR/DVD is in DVD mode.

SOURCE Button

Press to select AUX, TV/VCR or DVD mode. If you switch to TV/VCR mode, wait about 4 seconds before switching back to DVD mode. This button works the same as the SELECT button on the remote.

VCR/TV light (red)

Appears if the TV/VCR/DVD is in TV/VCR mode.

REC/OTR light (red)

This light flashes during recording. It lights when the TV/VCR/DVD is in Standby mode (power off) for a timer recording.

REC/OTR ● Button (VCR)

Press to start a videotape recording.

Details are on page 27.

Press repeatedly to start a One-Touch Recording. Details are on page 28.

REW ◀◀ Button (VCR)

Press to rewind the tape or to search backward quickly during playback.

Details are on page 40.

STOP/EJECT ■/▲ Button (VCR)

Press to stop tape playback. Press while playback is stopped to remove the tape.

F.FWD ▶▶ Button (VCR)

Press to fast forward the tape or to search forward quickly during playback.

Details are on page 40.

PLAY ► Button (VCR)

Press to start tape playback.

Details are on page 13.

VIDEO and AUDIO L/R (left/right) In jacks

Use audio and video cables to connect these jacks to the Audio and Video Out jacks of a Camcorder, DVD player or VCR. This lets you watch materials playing on the other equipment when you choose AUX at the TV/VCR/DVD. Details are on pages 10 and 34.

HEADPHONE jack

Connect headphones (not supplied) here for personal listening.

Remote Sensor

Receives a signal from your remote control so you can operate the TV/VCR/DVD from a distance.

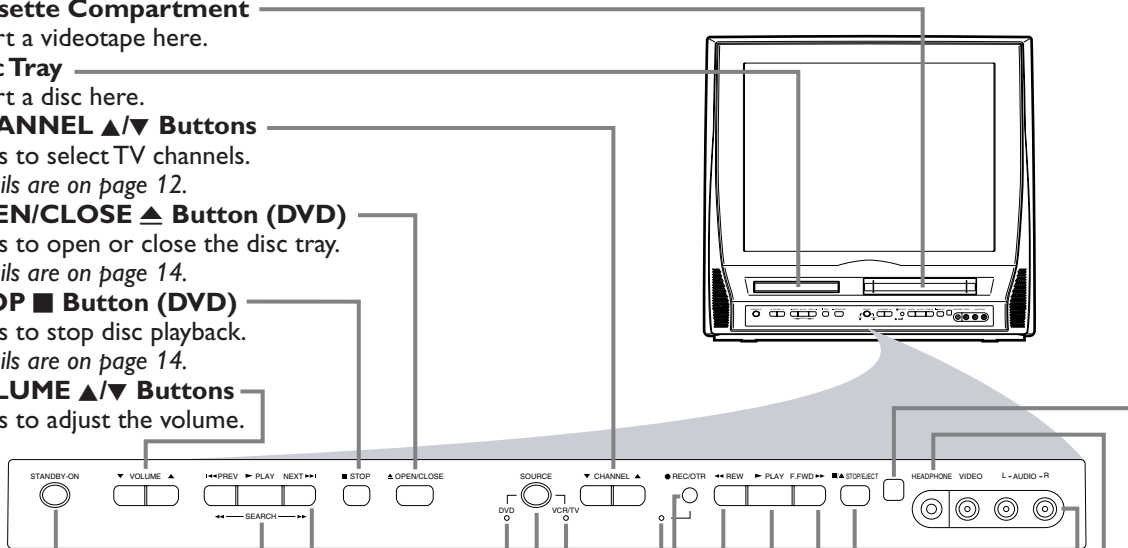

18 Rear Panel

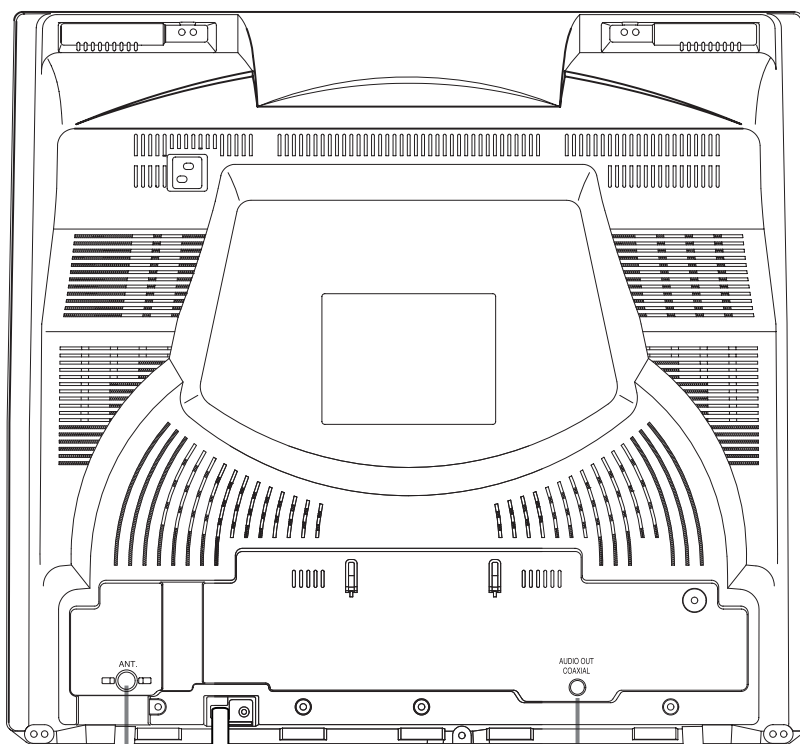

ANT. Jack (Antenna In)

Connect an antenna or Cable TV signal here. This brings TV channels to the TV/VCR/DVD. If you do not connect an antenna or Cable TV signal to the TV/VCR/DVD (or connect to a Cable Box/Satellite Receiver through this jack), you will not receive any TV channels. *Details are on pages 9-10.*

Power Cord

Connect to a standard AC outlet (120V/60Hz).

AUDIO OUT COAXIAL Jack

Connect this jack to a Digital Stereo using a digital audio coaxial cable (not supplied). Use this connection if the Stereo has Dolby Digital compatibility and has a Digital Coaxial Audio In jack. You may also use this connection when connecting the TV/VCR/DVD to a Mini-Disc or Digital Audio Tape deck. *Details are on page 11.*

Menu Language, Auto Channel Programming 19

Menu Language

This affects the language of the TV/VCR/DVD's setup menus and on-screen display terms. This does not alter the language of TV programming, videotapes, discs or closed captioning.

- Before you begin, press **SELECT** to put the TV/VCR/DVD in TV/VCR mode. The red VCR/TV light will appear.

1 Press **SETUP** once so the TV/VCR SETUP menu appears.

2 Press **▲** or **▼** to select **LANGUAGE**.

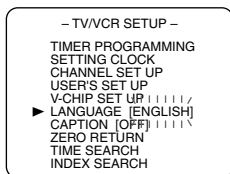

3 Press **ENTER** repeatedly to select **ENGLISH**, **ESPAÑOL** or **FRANÇAIS**. The selected language will appear inside the []. This will be the language of the TV/VCR/DVD setup menus in both TV/VCR and DVD modes.

4 Press **SETUP** to exit the menu.

Auto Channel Programming

To auto program only the channels which are available in your area, follow the steps below.

- Before you begin, put the TV/VCR/DVD in TV/VCR mode. Press **SELECT** so the red VCR/TV light appears on the front of the TV/VCR/DVD.

1 Press **SETUP**.

2 Press **▲** or **▼** to select **CHANNEL SET UP**. Then, press **ENTER**.

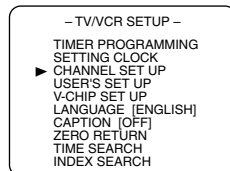

3 Press **▲** or **▼** to select **AUTO CH PROGRAMMING**. Press **ENTER**. The TV/VCR/DVD memorizes available channels. When scanning is complete, the TV/VCR/DVD will go to the lowest available channel. Use **CH. ▲/▼** to scan memorized channels. You can select non-memorized channels with the Number buttons.

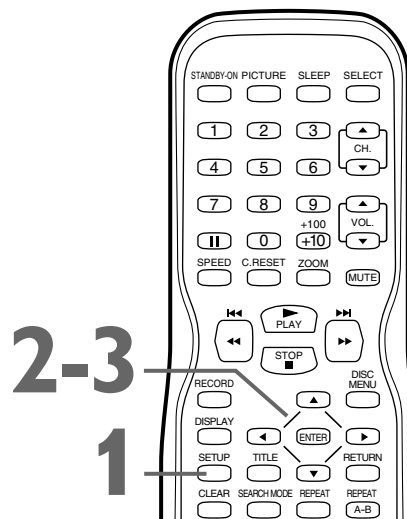
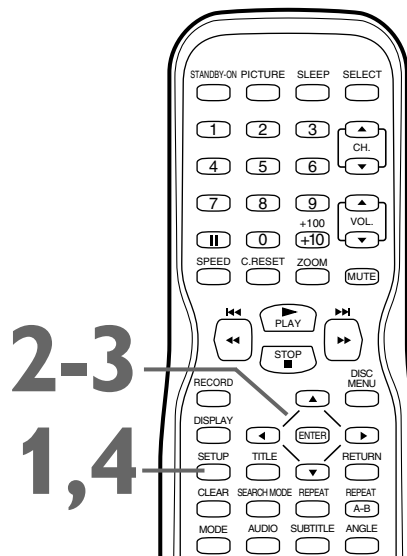
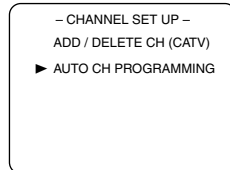

Helpful Hints

- The TV/VCR/DVD cannot change channels at the Cable Box or Satellite Receiver. Set the TV/VCR/DVD to 3, 4 or AUX. Change channels at the Cable Box/Satellite Receiver.
- Channel settings will be saved even if the power fails.
- If you have Spanish or French menus and need English, press **SETUP**. Press **▲** or **▼** to select **IDIOMA** or **LANGAGE**. Press **ENTER** to select **ENGLISH**. Press **SETUP** to remove the menu.
- You cannot reset TV channels when the unit is in DVD mode.

20 Adding/Deleting Channels

You can delete TV channels you no longer receive or seldom watch. Or, you can add more channels if the TV/VCR/DVD did not memorize all your favorite channels.

- **Before you begin, press SELECT to put the TV/VCR/DVD in TV/VCR mode. The red VCR/TV light will appear.**

1 Press **SETUP**.

2 Press **▲** or **▼** to select **CHANNEL SET UP**. Then, press **ENTER**.

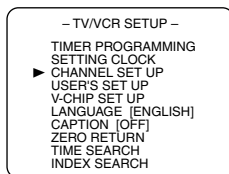

3 Press **▲** or **▼** to select **ADD/DELETE CH.** (TV) or (CATV) will appear beside ADD/DELETE CH. This indicates whether you connected an Antenna (TV) or a Cable TV signal (CATV) to the TV/VCR/DVD. Then, press **ENTER**. The menu will disappear and a TV channel will appear. The channel number will appear, along with ADD/DELETE.

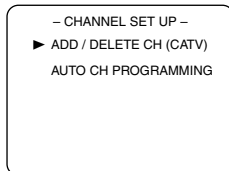

4 Press **▲** or **▼** until the channel you wish to add or delete appears. You also can use the Number buttons or CH. **▲/▼** to choose a channel.

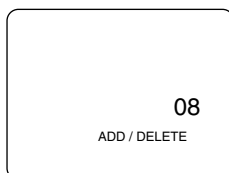

5 Press **ENTER** to add or delete the channel. To add a channel, press **ENTER** so **ADD** and the channel number appear in light blue (teal). To delete a channel, press **ENTER** so **DELETE** and the channel number appear in light red (purple). To delete another channel, repeat steps 4-5.

6 Press **SETUP** when you are finished.

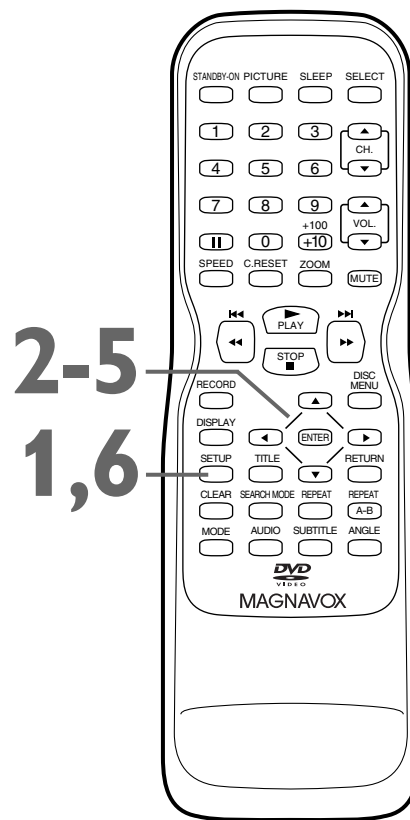

Helpful Hints

- To confirm that a channel has been added or deleted, press CH. **▲/▼** to see if you can or cannot select the channel. Only memorized/added channels can be selected with CH. **▲/▼**. Use the Number buttons to select deleted channels.
- If you connected an Antenna to the TV/VCR/DVD, channels 2-69 will be available to add or delete. If you connected to Cable TV, channels 1-125 will be available.
- This function will not operate when the unit is in DVD mode.

Setting the Clock 21

Manual Clock Setting

You must set the clock before you can do a timer recording. Set the clock manually. Afterward, use Auto Clock to monitor the time. *Details are on pages 23-24.*

If you do not receive a PBS station that carries time signals, you cannot use Auto Clock. Set AUTO CLOCK to OFF. The time will remain as you set it manually.

Before you begin ...

- With the power on, press **SELECT** to put the TV/VCR/DVD in TV/VCR mode. The red VCR/TV light will appear.

1 Press **SETUP**.

2 Press **▲** or **▼** to select **SETTING CLOCK**. Then, press **ENTER**.

```

- TV/VCR SETUP -
TIMER PROGRAMMING
▶ SETTING CLOCK
CHANNEL SET UP
USER'S SET UP
V-CHIP SET UP
LANGUAGE [ENGLISH]
CAPTION [OFF]
ZERO RETURN
TIME SEARCH
INDEX SEARCH
  
```

3 Press **▲** or **▼** to select **MANUAL CLOCK SET**. Then, press **ENTER**.

```

- SETTING CLOCK -
AUTO CLOCK [ON]
AUTO CLOCK CH SEARCH
AUTO CLOCK CH [02]
▶ MANUAL CLOCK SET
D.S.T. [OFF]
  
```

4 While the **MONTH** space is flashing, press **▲** or **▼** until the correct month appears. Then, press **▶**.

```

- MANUAL CLOCK SET -
MONTH DAY YEAR
05 - - - -
HOUR MINUTE
- - : - - -
  
```

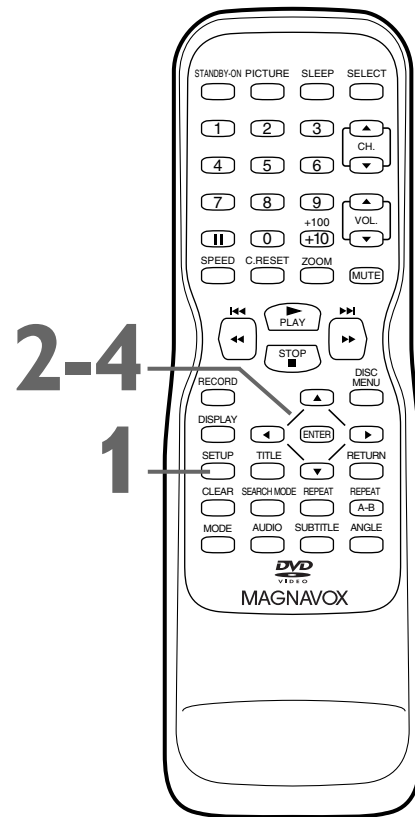

Instructions continue on the next page.

Helpful Hint

- You may have to reset the clock after a power failure.

22 Setting the Clock (cont'd)

Instructions continued from the previous page.

- 5** While the **DAY** space is flashing, press **▲** or **▼** until the correct day appears. Then, press **▶**. An abbreviation for the selected day of the week will appear.

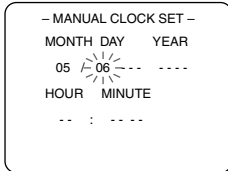

- 6** While the **YEAR** space is flashing, press **▲** or **▼** until the correct year appears. Then, press **▶**.

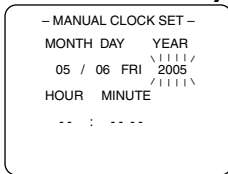

- 7** While the **HOUR** space and **AM** or **PM** are flashing, press **▲** or **▼** until the correct hour appears. Then, press **▶**.

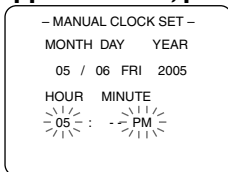

- 8** While the **MINUTE** space is flashing, press **▲** or **▼** until the correct minute appears.

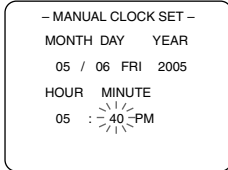

- 9** Press **SETUP**. Although seconds are not displayed, they begin counting from 0 when you press **SETUP**. Use this action to synchronize the clock exactly.

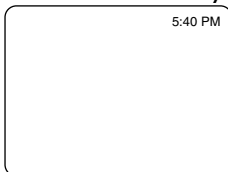

Press **DISPLAY** to see the current time on the screen. *Details are on page 26.*

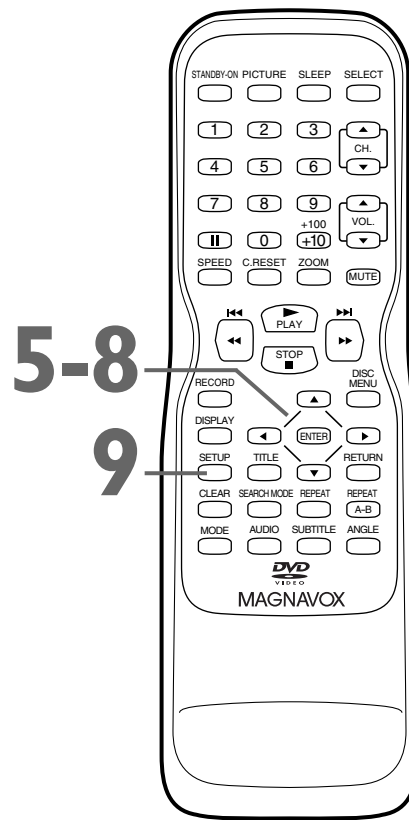

Helpful Hint

- To adjust the clock later, follow steps 1-3 on page 21. Then press **◀** or **▶** to select the item you want to change. Enter the correct information by pressing **▲** or **▼**. Press **SETUP** when you are finished.

Setting the Clock (cont'd) 23

Auto Clock Setting

You can have the TV/VCR/DVD adjust the clock using your PBS channel. Once you set the clock manually, the TV/VCR/DVD will monitor the correct time and date broadcast by the PBS station.

Before you begin ...

- Turn on the TV/VCR/DVD power.
- Connect the antenna/Cable TV signal.
Details are on pages 9-10.
- Turn on the Cable Box/Satellite Receiver (if applicable).
- Set up the TV channels. *Details are on pages 19-20.*
- Set the clock manually. *Details are on pages 21-22.*
- **Press SELECT to put the TV/VCR/DVD in TV/VCR mode. The red VCR/TV light will appear.**

1 Press **SETUP**.

2 Press **▲** or **▼** to select **SETTING CLOCK**.
Press **ENTER**.

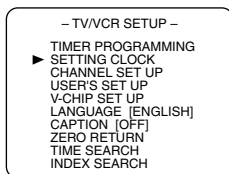

3 With **AUTO CLOCK** selected, press **ENTER** so **ON** appears beside **AUTO CLOCK**.

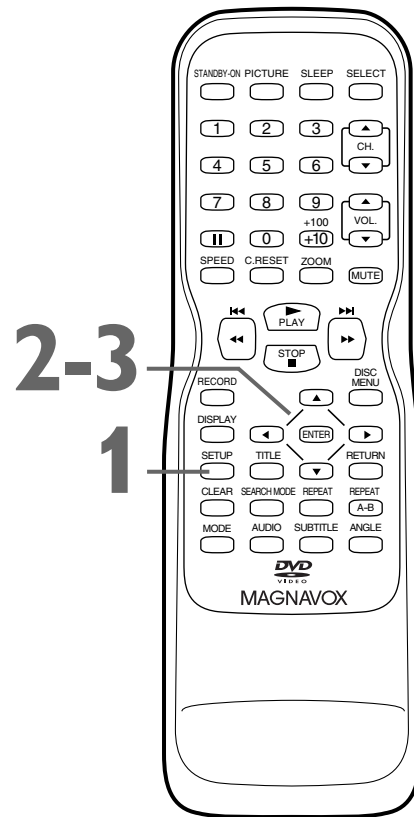
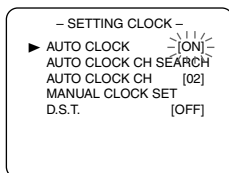

Instructions continue on the next page.

24 Setting the Clock (cont'd)

Instructions continued from the previous page.

- 4** If you already know your PBS channel number, skip ahead to step 8. If you do not know the channel number of your PBS station, press **▼** to select **AUTO CLOCK CH SEARCH**. Then press **ENTER**.

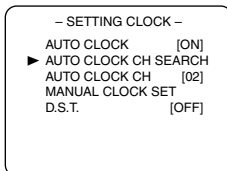

- The TV/DVD/VCR will search for a channel that carries a time signal. Channels that carry the time will appear at the top of the screen. Use one of these channels when you enter your **AUTO CLOCK CH** at step 9. This may take several minutes. An “_ _” appears in the lower left corner of the screen when the search is complete.

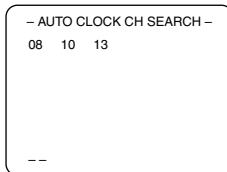

- 5** Press **SETUP** to remove the **AUTO CLOCK CH SEARCH** screen.
- 6** Press **SETUP** to access the menu again.
- 7** Press **▲** or **▼** to select **SETTING CLOCK**. Then, press **ENTER**.
- 8** Press **▼** to select **AUTO CLOCK CH**, then press **ENTER**.

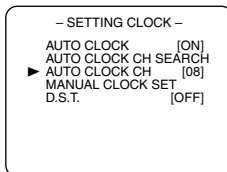

- 9** Press **◀** or **▶** until the channel number of your **PBS station** appears. Use the channel number you found at step 4.
- 10** Press **SETUP** to remove the menu.
- 11** Press **STANDBY-ON** to turn off the **TV/VCR/DVD** and let the **PBS channel** update the clock.

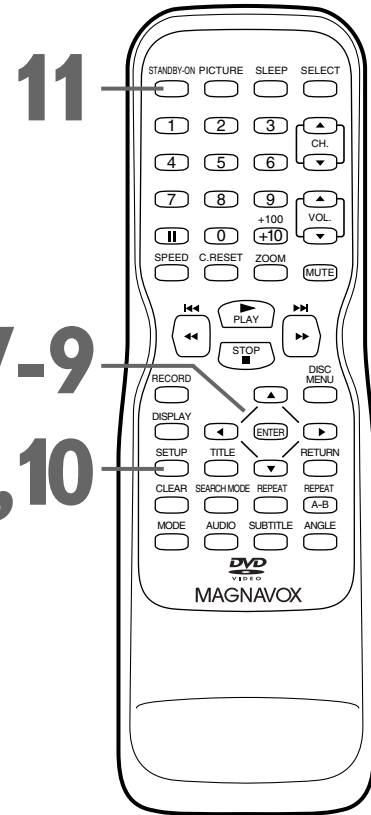

Helpful Hints

- During the Auto Clock Channel Search, the picture may be distorted. This is normal.
- If there are no PBS stations available, set **AUTO CLOCK** to **OFF**. Set the clock manually.
- If the TV/VCR/DVD is connected to a Cable Box or Satellite Receiver, select the local PBS station on the Cable Box/Satellite Receiver. Set the TV/VCR/DVD to the output channel of the Cable Box/Satellite Receiver (03, 04 or AUX).

Daylight-Savings Time 25

When Daylight-Savings Time (D.S.T.) is ON, the clock will move forward 1 hour on the first Sunday in April and move back 1 hour on the last Sunday in October.

To turn Daylight-Savings Time ON or OFF, follow the steps below.

- Before you begin, press **SELECT** to put the TV/VCR/DVD in TV/VCR mode. The red VCR/TV light will appear.

1 Press **SETUP**.

2 Press **▲** or **▼** to select **SETTING CLOCK**. Then, press **ENTER**.

```

- TV/VCR SETUP -
TIMER PROGRAMMING
SETTING CLOCK
CHANNEL SET UP
USER'S SET UP
V-CHIP SET UP
LANGUAGE [ENGLISH]
CAPTION [OFF]
ZERO RETURN
TIME SEARCH
INDEX SEARCH
  
```

3 Press **▲** or **▼** to select **D.S.T.** Then, press **ENTER** until **ON** appears beside **D.S.T.** Or, press **ENTER** so **OFF** appears beside **D.S.T.** if you want to disable this feature.

```

- SETTING CLOCK -
AUTO CLOCK [ON]
AUTO CLOCK CH SEARCH
AUTO CLOCK CH [02]
MANUAL CLOCK SET
▶ D.S.T. [ON]
  
```

4 Press **SETUP** to remove the menu.

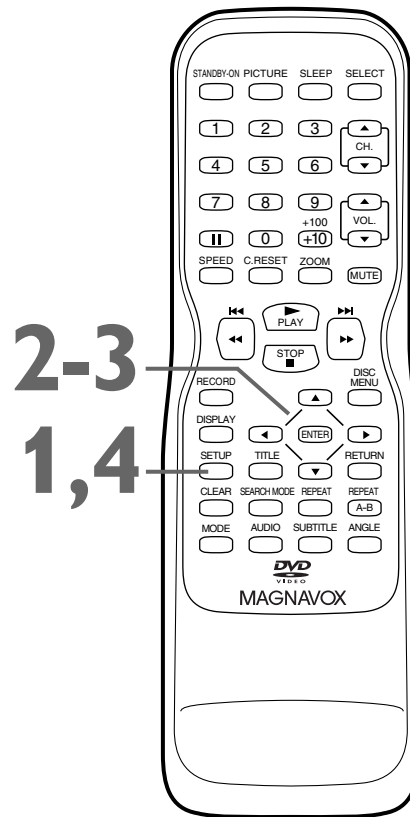

26 Status Displays, Picture Controls

Status Displays

To see the Videotape Counter, Clock or Channel number on the screen in TV/VCR mode, press DISPLAY repeatedly. The following will occur when Closed Captions are OFF.

- 1 Press **DISPLAY** once to see the Videotape counter. After 5 seconds, only the counter will remain on the screen.

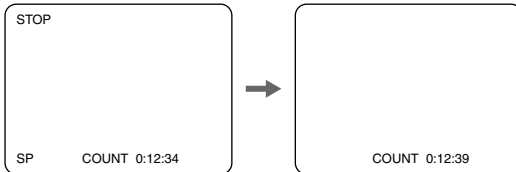

- 2 Press **DISPLAY** again to see the current time and TV channel. After 5 seconds, only the clock and channel number will remain on the screen. To clear them, press **DISPLAY** again.

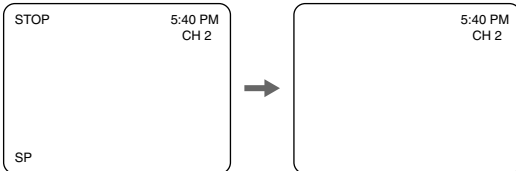

- If you press **DISPLAY** when Closed Captions are ON, all the status information will appear for 5 seconds. After 5 seconds, they will clear from the screen. *Closed Caption details are on page 42.*

Picture Controls

Follow these steps to adjust the TV/VCR/DVD's brightness, sharpness, tint, color or contrast.

- 1 Press **PICTURE**.
- 2 Within 5 seconds, press **▲** or **▼** to select the picture control you want to adjust. You can select **BRIGHT**, **CONTRAST**, **COLOR**, **TINT** or **SHARPNESS**.

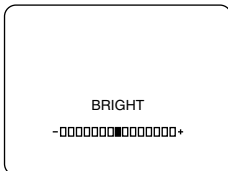

- 3 Within 5 seconds, press **◀** or **▶** to adjust the picture control.

| | ◀ | ▶ |
|------------------|------------------------|------------------------|
| BRIGHT | to decrease brightness | to increase brightness |
| CONTRAST | to decrease contrast | to increase contrast |
| COLOR | to decrease color | to brighten color |
| TINT | to add purple | to add green |
| SHARPNESS | to make soft | to make clear |

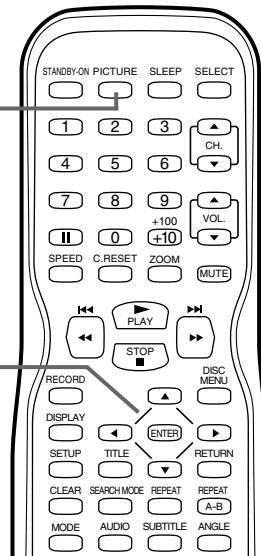
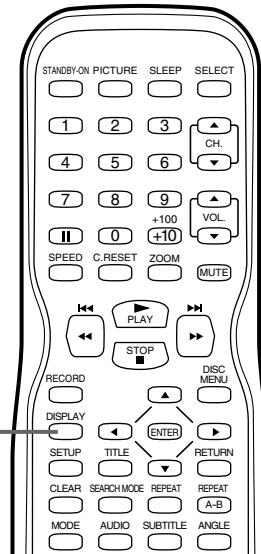

Helpful Hint

- **Degaussing:** Magnetism from nearby appliances and speakers might affect the color of the TV picture. If this happens, move the TV/VCR/DVD away from the appliance. If the color is still not correct, turn off the power for 30 minutes (for 27MDTR20) or disconnect the power cord for 30 minutes (for 19MDTR20 and 20MC4304). After 30 minutes, try using the unit again.

Videotape Recording 27

- 1 Place a tape with its record tab intact in the cassette compartment of the TV/VCR/DVD.** The TV/VCR/DVD power will come on. If the power is already on and a videotape is in the unit, make sure the unit is in TV/VCR mode. Press SELECT so the red VCR/TV light appears on the front of the unit.
- 2 Press SPEED until the desired tape speed (SP or SLP) appears in the bottom left corner of the screen.** See *tape speed details below*.
- 3 Press CH. ▲/▼ or the Number buttons to select the channel you want to record.** You cannot change channels during recording. You can only record and view one TV channel at a time.
- 4 Press RECORD once to start recording.** The REC/OTR light will flash on the front of the TV/VCR/DVD. (If the tape does not have a record tab, the tape will eject. Insert another tape.)
- 5 To pause the recording, press II. To resume recording, press II again or press RECORD.**
- 6 To stop recording, press STOP ■.**

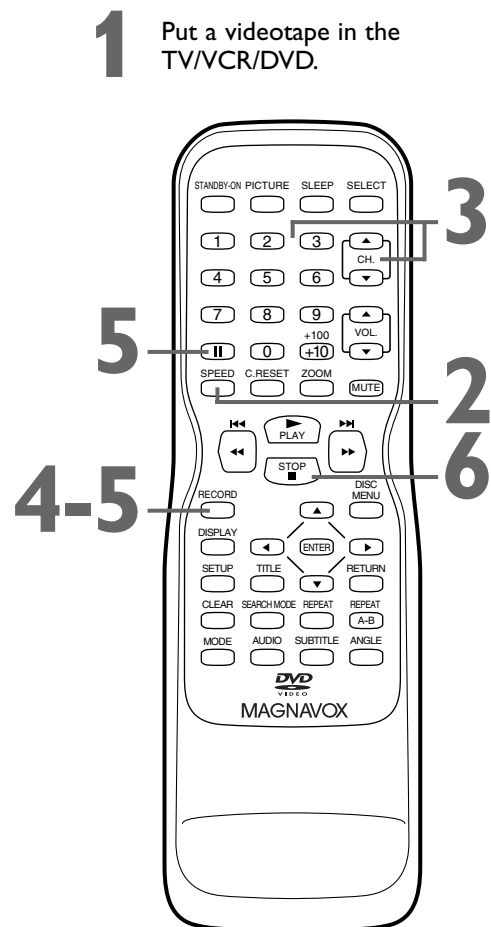

Tape Speeds

This chart shows the recording/playback time for 3 types of video cassettes (T160, T120 and T60). There are 3 playback speeds: SP, LP and SLP. A tape will play only in the speed in which it was recorded. When recording, you can change the tape speed using SPEED. You cannot record in LP speed on this TV/VCR/DVD.

The slower the speed, the more programming you can fit on the tape. SLP is the slowest speed.

| Tape Speed | Cassette type / Playback Time | | |
|--------------------------------------|-------------------------------|--------|--------|
| | T160 | T120 | T60 |
| SP(Standard Playback) | 2 hrs. 40 mins. | 2 hrs. | 1 hr. |
| LP(Long Playback) (playback only) | 5 hrs. 20 mins. | 4 hrs. | 2 hrs. |
| SLP (Super Long Playback) | 8 hrs. | 6 hrs. | 3 hrs. |

Helpful Hints

- You cannot record DVD contents onto a videotape using this unit.
- Recording options are on pages 28-33.
- If you pause a recording for 5 minutes, the unit will start Recording again automatically.
- You can change the tape speed by pressing SPEED while a recording is in progress. Some distortion may appear on the tape.

28 One-Touch Recording

A One-Touch Recording (OTR) is an immediate timed recording from 30 minutes to 8 hours long.

Before you begin ...

- Turn on the TV/VCR/DVD.
- Press SELECT to put the unit in TV/VCR mode.
The red VCR/TV light will appear on the front of the unit.
- Insert a videotape with its erase prevention tab in place.
Details are on page 8.

1 Press the Number buttons or CH. ▲/▼ to select the channel you want to record.

Remember, if the TV/VCR/DVD is connected to a Cable Box/Satellite Receiver, the TV/VCR/DVD must be on channel 3, 4 or AUX.

Select the channel you want to record at the Cable Box/Satellite Receiver. *Details are on page 9.*

2 Press SPEED to select a tape recording speed (SP or SLP). *Details are on page 27.*

3 Press REC/OTR ● on the front of the TV/VCR/DVD repeatedly to select a recording length. Recording will start immediately.

Each press of REC/OTR ● will increase the recording time by 30 minutes. The maximum recording length is 8 hours.

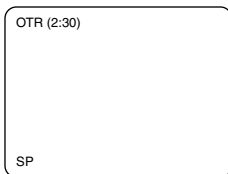

4 Press STOP ■ to stop a one-touch recording before its designated end time. Otherwise, recording will stop at the time you designated. The TV/VCR/DVD will turn off when the OTR ends.

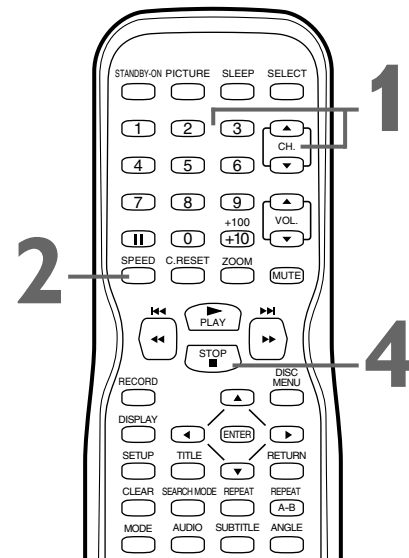

3 Press REC/OTR ● on the front of the TV/VCR/DVD.

Helpful Hints

- You cannot start an OTR with the RECORD button on the remote control.
- To show the remaining recording time, press DISPLAY. OTR and the remaining recording time will appear briefly in the top left corner of the screen.
- If the tape ends before the recording's end time, the TV/VCR/DVD will stop recording, eject the tape, and turn itself off.
- An OTR will continue even if you turn off the TV/VCR/DVD. The flashing REC/OTR light indicates the recording is still in progress.
- To change the recording length while an OTR is in progress, press REC/OTR ● repeatedly.
- You cannot pause an OTR.
- If the preset time for a timer recording comes up during an OTR, the OTR has priority. The timer recording will not take place.

Timer Recording 29

Follow the steps below to program the TV/VCR/DVD to record TV programs while you're away from home. The TV/VCR/DVD will record and turn itself off automatically. You can set a maximum of 8 timer recordings.

Before you begin, make sure ...

- The clock is set. If the clock is not set, the Manual Clock Set menu will appear. See pages 21-22 to set the clock.
- Channels are set. *Details are on page 19.*
- A tape is in the TV/VCR/DVD. Make sure the record tab is intact. *Details are on page 8.*

1 Press **SETUP**. Press **▲** or **▼** to select **TIMER PROGRAMMING**, then press **ENTER**.

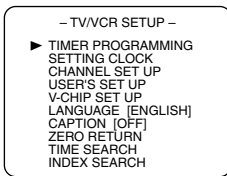

2 Press **▲** or **▼** to select a program position. Then, press **►**.

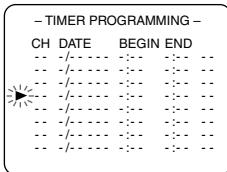

3 While **CH** is selected, press **▲** or **▼** to select the channel you want to record. Then press **►**. If the TV/VCR/DVD is connected to a Cable Box/Satellite Receiver, the TV/VCR/DVD must be on channel 3, 4 or AUX. Set CH as 03, 04 or AUX in the Timer Programming menu. Choose the channel you want to record at the Cable Box/Satellite Receiver. Leave the Cable Box/Satellite Receiver on for the timer recording. Leave the TV/VCR/DVD set to AUX. (Press **SELECT** on the remote to choose AUX at the TV/VCR/DVD.) *Additional details are on page 9.*

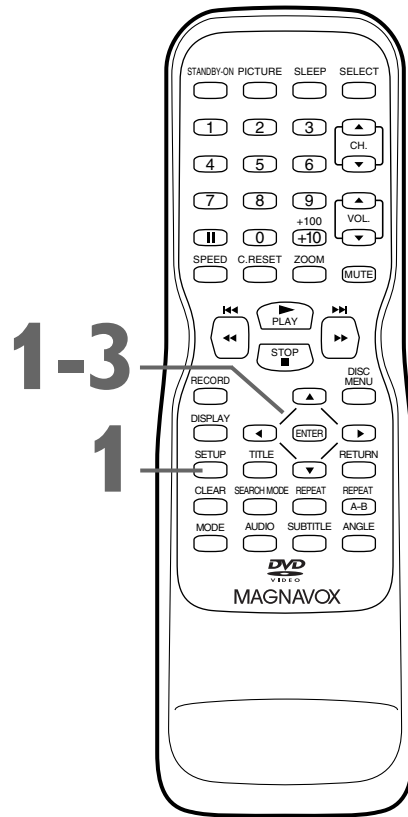
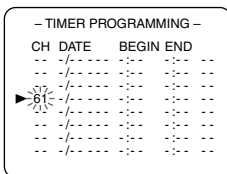

Helpful Hint

- You cannot access the Timer Programming menu at step 1 if the clock is not set. The Setting Clock menu will appear. Follow the steps on pages 21-24 to set the clock.
- Enter the information while the space is flashing.

30 Timer Recording (cont'd)

4 While **DATE** is selected, press **▲** or **▼** until the correct date appears. Recording will happen once.

| - TIMER PROGRAMMING - | | | |
|-----------------------|----------|-------|-------|
| CH | DATE | BEGIN | END |
| -- | -/- | --:-- | --:-- |
| -- | -/- | --:-- | --:-- |
| ▶ 61 | 7/04 MON | --:-- | --:-- |
| -- | -/- | --:-- | --:-- |
| -- | -/- | --:-- | --:-- |
| -- | -/- | --:-- | --:-- |

Or, to record a program at the same time on the same channel every day, press **▼** until **EVERY DAY** appears.

| - TIMER PROGRAMMING - | | | |
|-----------------------|-----------|-------|-------|
| CH | DATE | BEGIN | END |
| -- | -/- | --:-- | --:-- |
| -- | -/- | --:-- | --:-- |
| ▶ 61 | EVERY DAY | --:-- | --:-- |
| -- | -/- | --:-- | --:-- |
| -- | -/- | --:-- | --:-- |
| -- | -/- | --:-- | --:-- |

Or, to record a program at the same time on the same channel every week, press **▼** until **EVERY** and a day of the week appear together.

| - TIMER PROGRAMMING - | | | |
|-----------------------|-----------|-------|-------|
| CH | DATE | BEGIN | END |
| -- | -/- | --:-- | --:-- |
| -- | -/- | --:-- | --:-- |
| ▶ 61 | EVERY SUN | --:-- | --:-- |
| -- | -/- | --:-- | --:-- |
| -- | -/- | --:-- | --:-- |
| -- | -/- | --:-- | --:-- |

Finally, press **▶**.

5 While **BEGIN** is selected, press **▲** or **▼** to select the hour you want recording to begin. AM or PM will appear with the hour. Then, press **▶** and press **▲** or **▼** to select the minute you want recording to start. Press **▶**.

| - TIMER PROGRAMMING - | | | |
|-----------------------|----------|-------|-------|
| CH | DATE | BEGIN | END |
| -- | -/- | --:-- | --:-- |
| -- | -/- | --:-- | --:-- |
| ▶ 61 | 7/04 MON | 7:30 | --:-- |
| -- | -/- | --:-- | --:-- |
| -- | -/- | --:-- | --:-- |
| -- | -/- | --:-- | --:-- |

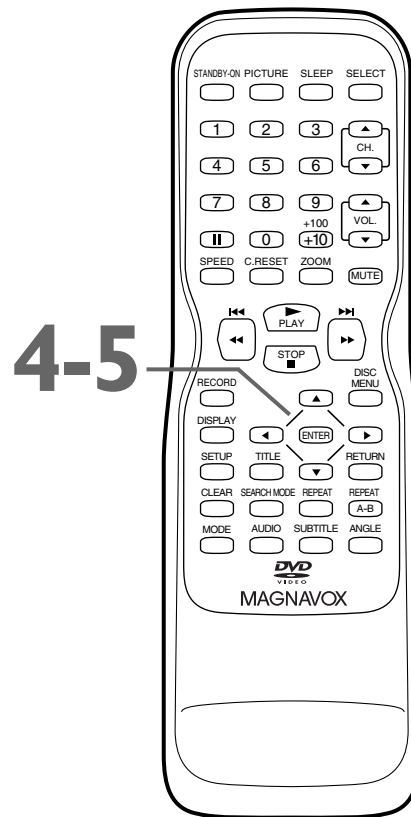

Timer Recording (cont'd) 31

- 6** While **END** is selected, press **▲** or **▼** to select the hour at which you want recording to stop. AM or PM will appear with the hour. Then, press **▶** and press **▲** or **▼** to select the minute at which you want recording to end. Press **▶**.

| - TIMER PROGRAMMING - | | | |
|-----------------------|----------|-------------------|-------------------|
| CH | DATE | BEGIN | END |
| -- | -/- | ---- | ---- |
| -- | -/- | ---- | ---- |
| ▶ 61 | 7/04 MON | 7:30 ^u | 8:50 ^u |
| -- | -/- | ---- | ---- |
| -- | -/- | ---- | ---- |
| -- | -/- | ---- | ---- |

- 7** Press **▲** or **▼** until the tape speed (**SP** or **SLP**) appears at the right end of the line.

| - TIMER PROGRAMMING - | | | |
|-----------------------|----------|-------------------|----------------------|
| CH | DATE | BEGIN | END |
| -- | -/- | ---- | ---- |
| -- | -/- | ---- | ---- |
| ▶ 61 | 7/04 MON | 7:30 ^u | 8:50 ^u SP |
| -- | -/- | ---- | ---- |
| -- | -/- | ---- | ---- |
| -- | -/- | ---- | ---- |

- 8** Press **SETUP** to remove the menus.

- 9** Press **STANDBY-ON** to turn off the **TV/VCR/DVD** and set the timer recording. The red REC/OTR light will appear on the front of the TV/VCR/DVD. You must turn off the TV/VCR/DVD to activate a timer recording. If the power is not off and you continue watching TV, **TIMER REC STANDBY** starts flashing on the screen 2 minutes before the programmed start time. Turn off the unit to do the recording.

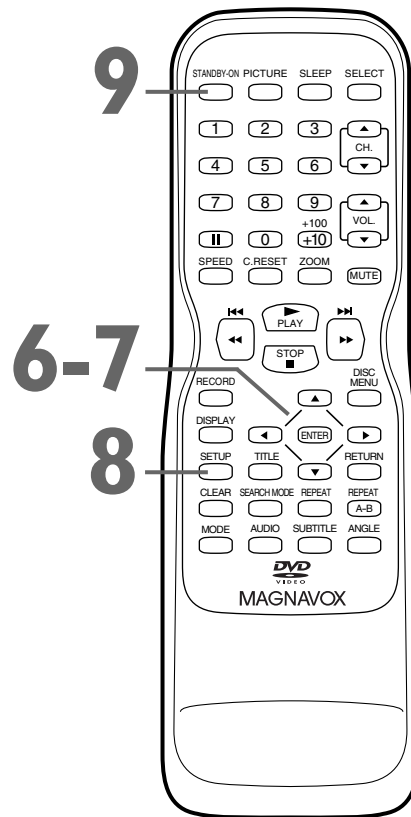

Helpful Hints

- To correct information while setting the Timer Recording, press **◀** to go back one step and select the incorrect information. Press **▲** or **▼** to enter the correct information.
- While a timer recording is in progress, the red REC/OTR light will flash.
- If a timer recording is set for hours or days later, you can use the TV/VCR/DVD until then. Just be sure to turn off the TV/VCR/DVD about 5 minutes before the recording. Set the Cable Box/Satellite Receiver if appropriate.
- If the record tab is missing, the videotape will eject when you press **STANDBY-ON** to turn off the TV/VCR/DVD. Insert a recordable tape for the timer recording.
- If the tape ends before the recording is complete, the TV/VCR/DVD will stop recording immediately and eject the tape.

32 Timer Recording (cont'd)

Extending a Timer Recording

To make a Timer Recording start and end later than originally scheduled, follow these steps.

- 1 With the unit on, press SETUP. Press ▲ or ▼ to select TIMER PROGRAMMING. Press ENTER.
- 2 Press RECORD, then press ▲ or ▼ to select the desired program.
- 3 Press RECORD again. Each press of RECORD will shift forward the beginning/end time by 10 minutes. If the recording is in progress, each press will shift forward the end time only.
If you adjust the times during recording, the recording speed automatically changes to SLP.
To restore the original recording times, press ■■.
- 4 Press SETUP to remove the menus.
- 5 If the timer recording is scheduled to start later, press STANDBY-ON to turn off the TV/VCR/DVD for the recording.

Correcting a Timer Recording

- 1 With the unit on, press SETUP. Press ▲ or ▼ to select TIMER PROGRAMMING. Press ENTER.
- 2 Press ▲ or ▼ to select a timer recording, then press ►.
- 3 Press ◀ or ▶ to select the information you want to change.
Press ▲ or ▼ to enter the correct information.
- 4 Press SETUP to remove the menu.
- 5 Press STANDBY-ON to turn off the TV/VCR/DVD to set the recording.

Cancelling Timer Recordings

To cancel a Timer Recording that is in progress:

- 1 The red REC/OTR light will flash during recording. Press STANDBY-ON to turn on the TV/VCR/DVD, then press STOP/EJECT ■/▲ on the front of the TV/VCR/DVD.

To cancel a Timer Recording that has not started:

- 1 With the unit on, press SETUP.
Press ▲ or ▼ to select TIMER PROGRAMMING. Press ENTER.
- 2 Press ▲ or ▼ to select a timer recording.
- 3 Press C.RESET. All the information for the selected recording will disappear.
- 4 Press SETUP to remove the menu.

Checking Scheduled Timer Recordings

- 1 With the unit on, press SETUP.
Press ▲ or ▼ to select TIMER PROGRAMMING.
- 2 Press ENTER. The program details will appear on the screen.
- 3 Press SETUP to remove the menu.

Timer Recording Auto Return 33

Use this feature to rewind the tape to the beginning of a completed timer recording.

1 Press **SETUP**.

2 Press **▲** or **▼** to select **USER'S SET UP**. Then, press **ENTER**.

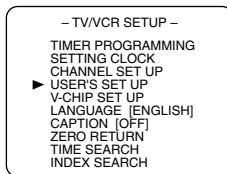

3 Press **▲** or **▼** to select **AUTO RETURN**.

4 Press **ENTER** until **ON** appears beside **AUTO RETURN**. To turn off Auto Return, press **ENTER** to choose **OFF** instead.

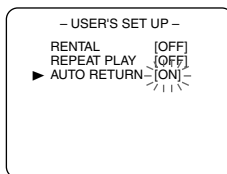

5 Press **SETUP**. When **AUTO RETURN** is **ON**, when all the timer recordings are completed, the tape will rewind to the beginning of the recorded program(s).

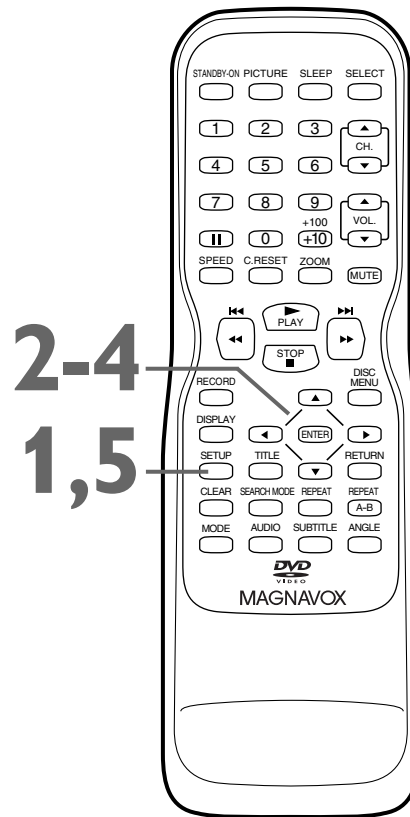

Helpful Hints

- If you press **STANDBY-ON** while the tape is rewinding, the rewinding will stop.
- If there is a power failure, the TV/VCR/DVD will retain its memory for this feature.

34 Rerecording (Tape Duplication)

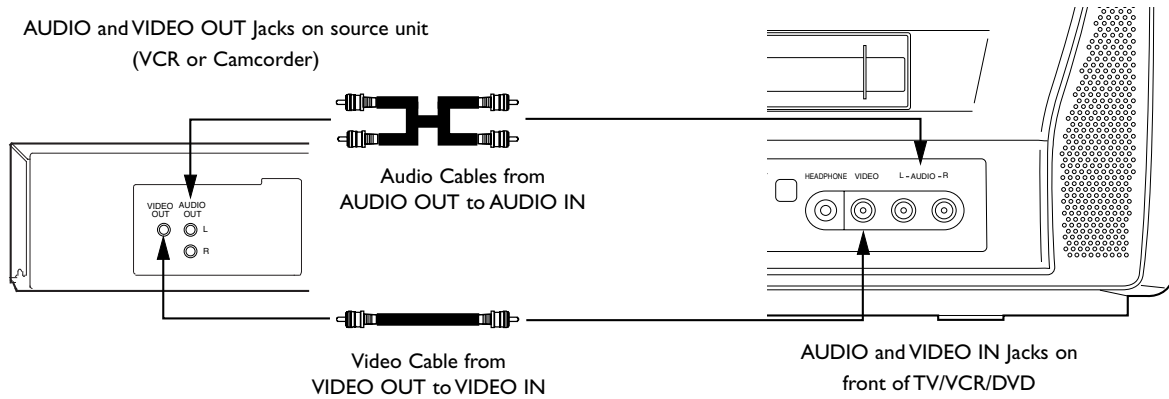

- 1** Make the connections shown above. Use audio and video cables (not supplied). Connect the source unit (VCR or Camcorder) to a power source after connections are made.
- 2** The VCR or Camcorder will play your tape. **Insert a prerecorded tape in the source unit.** If playback begins, press **STOP ■** on the VCR or Camcorder.
- 3** The TV/VCR/DVD will record your tape. **Insert a blank videotape in the cassette compartment of the TV/VCR/DVD.** Make sure the tape's record tab is intact and the TV/VCR/DVD power is on.
- 4** Point the TV/VCR/DVD remote control at the TV/VCR/DVD. Press **SELECT** or **CH. ▲/▼** until **AUX** appears on the screen. The TV/VCR/DVD is now in Line Input or Auxiliary mode.
- 5** Press **SPEED** until the desired tape speed (**SP** or **SLP**) appears in the lower left corner of the screen.
- 6** Press **PLAY ►** on the VCR or Camcorder and **REC/OTR ●** on your TV/VCR/DVD at the same time. Videotape copying will begin.
- 7** To stop copying, press **STOP/EJECT ■/▲** on the TV/VCR/DVD, then stop the tape on the VCR or Camcorder.

Helpful Hints

- Unauthorized recording of copyrighted television programs, videotapes or other materials may infringe on the rights of copyright owners and violate copyright laws.
- Different brands of equipment may operate differently.
- Make sure all connections are secure. Otherwise, you may not record both picture and sound.
- Programs that are copyright protected may not record clearly.
- You cannot record a DVD onto a videotape using this TV/VCR/DVD.
- You can use this connection to simply view tapes playing on a camcorder or VCR at the TV/VCR/DVD. Follow steps 1, 2 and 4 for connections and AUX setup. Then play the tape on the camcorder, etc., as usual.

Repeat Playback 35

Repeat Playback allows you to play a videotape continuously. All Repeat will repeatedly play the tape from the beginning to the end. Blank Repeat will repeatedly play the tape from its beginning to the first part that is blank for more than 10 seconds.

1 Press **SETUP**.

2 Press **▲** or **▼** to select **USER'S SET UP**. Then, press **ENTER**.

```

- TV/VCR SETUP -
TIMER PROGRAMMING
SETTING CLOCK
CHANNEL SET UP
▶ USER'S SET UP
V-CHIP SET UP
LANGUAGE [ENGLISH]
CAPTION [OFF]
ZERO RETURN
TIME SEARCH
INDEX SEARCH
  
```

3 Press **▲** or **▼** to select **REPEAT PLAY**.

4 Press **ENTER** until **ALL** or **BLANK** appears beside **REPEAT PLAY**. Or, to cancel Repeat Play, press **ENTER** to select **OFF**.

```

- USER'S SET UP -
RENTAL [OFF]
▶ REPEAT PLAY [ALL]
AUTO RETURN [OFF]
  
```

5 Press **SETUP** to remove the menu.

6 Press **PLAY ▶** to play a videotape.
REPEAT PLAY ▶ will appear on the screen briefly.

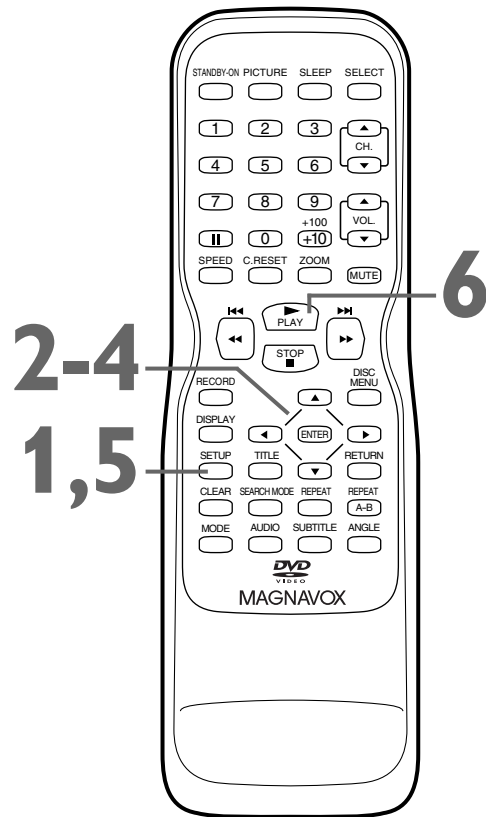

Helpful Hints

- Repeat Playback stays in effect after you turn off the TV/VCR/DVD. The TV/VCR/DVD keeps the Repeat Playback setting even if the power fails.
- If RENTAL is ON, RENTAL PLAY ▶ will appear on the screen instead of REPEAT PLAY ▶. Details are on page 36.

36 Rental Playback

This function enables you to improve picture quality when playing worn cassettes such as rented videotapes.

- 1 Press **SETUP**.
- 2 Press **▲** or **▼** to select **USER'S SET UP**. Then, press **ENTER**.

- TV/VCR SETUP -

TIMER PROGRAMMING
SETTING CLOCK
CHANNEL SET UP
▶ USER'S SET UP
V-CHIP SET UP
LANGUAGE [ENGLISH]
CAPTION [OFF]
ZERO RETURN
TIME SEARCH
INDEX SEARCH

- 3 Press **▲** or **▼** to select **RENTAL**. Press **ENTER** until **ON** appears beside **RENTAL**. To turn off Rental, press **ENTER** to choose **OFF**.

- USER'S SET UP -

▶ RENTAL [ON]
REPEAT PLAY [OFF]
AUTO RETURN [OFF]

- 4 Press **SETUP** to exit the menu.
- 5 Press **PLAY ▶** to start videotape playback. **RENTAL PLAY ▶** will appear briefly on the screen.

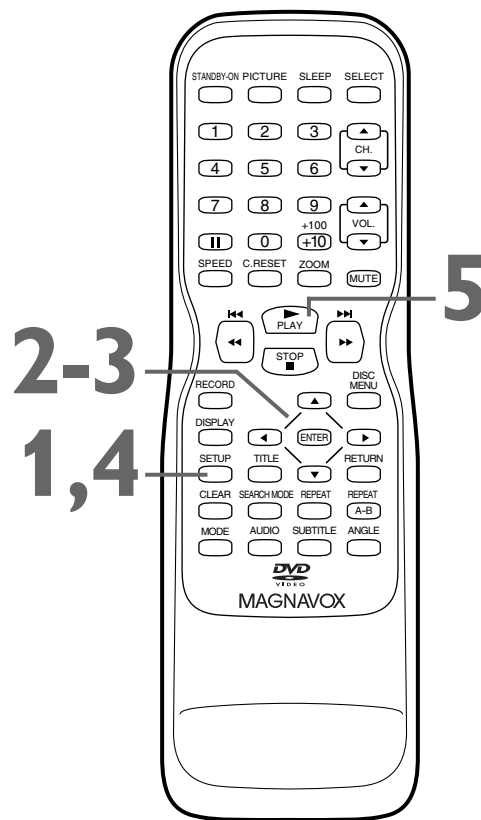

Helpful Hints

- Once you select Rental Playback, it stays in effect even after you turn off the TV/VCR/DVD.
- The TV/VCR/DVD will retain the Rental setting even if the power fails.

Zero Return, Sleep Timer 37

Zero Return

The videotape counter shows the elapsed recording or playback time in hours, minutes and seconds from the point at which the counter was set to 0. The counter time will not change on a blank tape or blank portions on a tape. The “-” before the tape counter indicates the amount of remaining recording/playing time before the counter reaches 0. Follow the steps below to reset the tape counter to 0 at a tape location you want to refer to later.

- 1** Play, rewind or fast forward the tape to the location you would like to refer to later. Press **STOP** ■ to stop the tape.
- 2** Press **C.RESET** to set the counter to 0:00:00.
- 3** To return to this same point later, press **SETUP**. Press **▲** or **▼** to select **ZERO RETURN**. Then, press **ENTER**.

The tape counter will appear on the screen. When the tape reaches the point at which you set the counter to 0, the tape will stop. Press **PLAY** ► to watch the tape from the designated point.

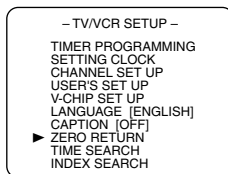

Sleep Timer

Use the Sleep Timer to program the TV/VCR/DVD to shut off in a certain amount of time.

- 1** Press **SLEEP** until the correct amount of time appears on the screen with **SLEEP**. Each press of **SLEEP** will increase the time by 30 minutes. You may set a Sleep Timer of 30, 60, 90 or 120 minutes. After 5 seconds, the Sleep Timer information will disappear from the screen. The TV/VCR/DVD will turn itself off after the selected amount of time has passed.

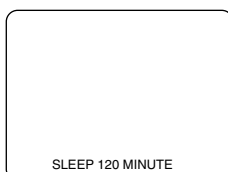

To Cancel the Sleep Timer

Press **SLEEP** until “SLEEP 0 MINUTE” appears.

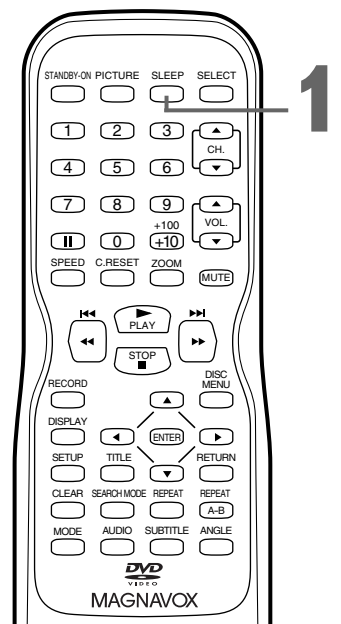
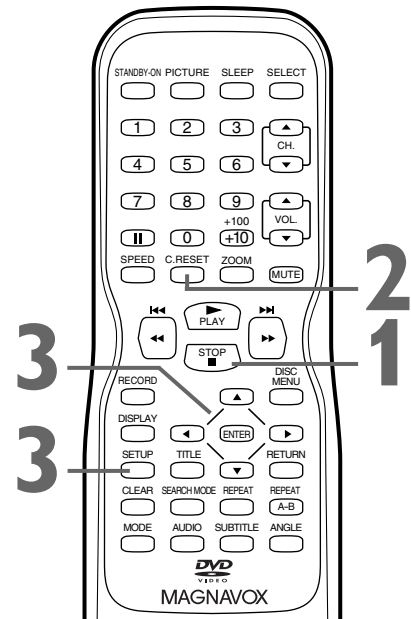

Helpful Hint

- To see how much time remains before the TV/VCR/DVD turns itself off, press **SLEEP** once. The information will disappear automatically in 5 seconds.

38 Time Search

Time Search lets you quickly advance the videotape to a position simply by entering the amount of playback time you want to skip.

In the example below, Time Search is set to 2 hours, 50 minutes from the present position.

1 Insert a videotape.

2 Press **SETUP**. Press **▲** or **▼** to select **TIME SEARCH**. Then, press **ENTER**.

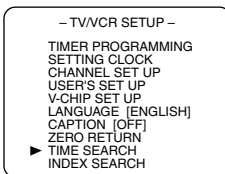

3 Press **▲** or **▼** until your desired time appears beneath **TIME SEARCH** at the top of the screen. (Example: 2:50 for 2 hours, 50 minutes) Each press of **▲** or **▼** increases or decreases the length of time by 10 minutes. To cancel the Time Search at this point, press **SETUP**.

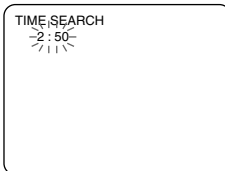

4 Press **◀** or **▶** to rewind or fast forward the tape the length of time you chose. The TV/VCR/DVD will rewind or fast forward the tape the specified amount of time. The time counts down on the screen as the search progresses. When 0:00 is reached, the tape will start playing. Or, to cancel the Time Search before it finishes, press **STOP** ■.

1 Insert a videotape.

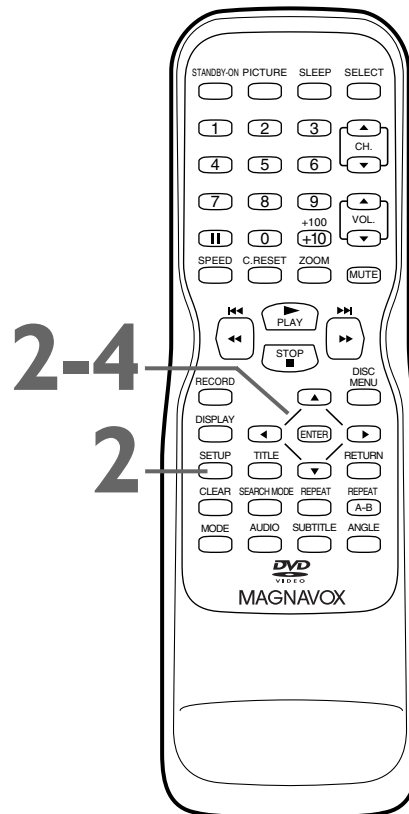

Helpful Hints

- A Time Search can be set up to a maximum of 9 hours 50 minutes in 10-minute increments.
- Time Search will not operate during recording.

Index Search 39

This feature lets you quickly rewind or fast forward to the start of recordings.

- Index Marks are made automatically at the start of all recordings. They are not made where recording pauses. The time gap between Index Marks should be greater than 1 minute for SP recording and 3 minutes for SLP recording. This means recordings should be 1 (SP) or 3 (SLP) minutes long. Otherwise, Index Search may not find the start of the recording. In some cases, Index Marks at the beginning of a videotape cannot be detected.

- 1 Press SETUP. Press ▲ or ▼ to select INDEX SEARCH. Then, press ENTER.**

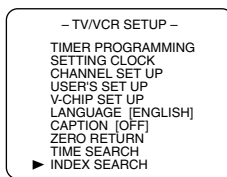

- 2 Press ▲ or ▼ until the number of programs you want to skip appears beneath INDEX SEARCH. To cancel an Index Search at this point, press SETUP.**

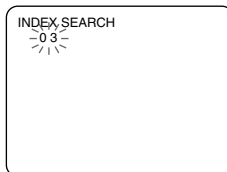

- 3 Press ◀ or ▶.** The TV/VCR/DVD begins rewinding or fast forwarding the videotape to the beginning of the desired program.
- 4** When the program is reached, playback will start.

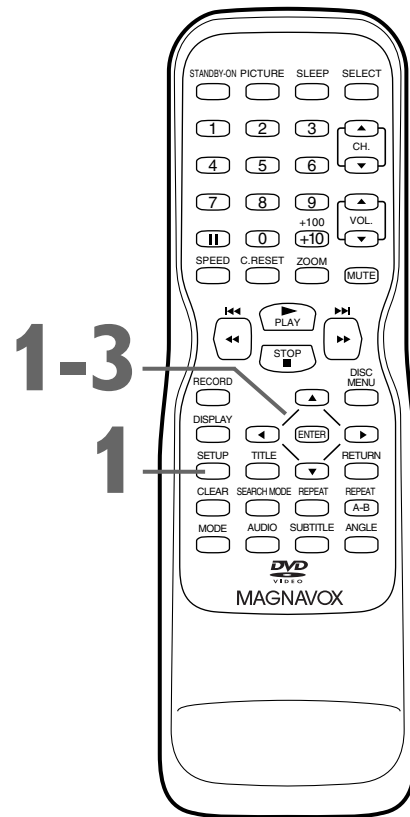

Helpful Hints

- Every time an Index Mark (or recording) is passed, the number beneath INDEX SEARCH on the screen decreases by one.
- A videotape must be in the TV/VCR/DVD for this function to work.
- You may search up to 20 Index Marks.
- This function will not operate during recording.
- To cancel an Index Search, press STOP ■.
- If the end of the tape is reached during an Index Search(forward), the tape will rewind to the beginning automatically. The TV/VCR/DVD will turn off and the tape will eject.

40 Videotape Playback Features

Slow Motion

1 Press **II** during playback to pause the videotape. Then press **▶▶** / **▶▶** to start slow motion. Sound will be mute during slow motion. Slow motion will stop automatically after 5 minutes to prevent damage to the tape.

2 Press **PLAY ▶** to return to normal playback.

Forward and Reverse Searching (SP/LP/SLP)

1 During videotape playback, press and release **◀◀** / **◀◀** or **▶▶** / **▶▶**. A fast forward or reverse picture search will begin.

2 To return to normal playback, press **PLAY ▶**.

Super High Speed Searching (LP/SLP)

1 During tape playback, press **◀◀** / **◀◀** or **▶▶** / **▶▶**, then press again. The TV/VCR/DVD will search the tape in high speed. Press **◀◀** / **◀◀** or **▶▶** / **▶▶** repeatedly to switch between regular and high speed searching.

2 To return to normal playback, press **PLAY ▶**.

Viewing a Still Picture

1 During tape playback, press **II**. A still picture will appear on the screen. The picture advances each time you press **II**. After a tape is paused for 5 minutes, playback will stop automatically. This prevents damage to the tape and TV/VCR/DVD.

2 If the still picture vibrates vertically, stabilize the picture by pressing **CH. ▲** or **▼**.

3 To release the still picture and return to normal playback, press **PLAY ▶**.

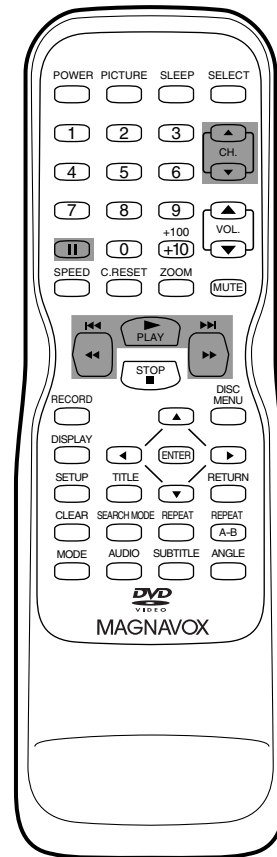

Helpful Hints

- SP/LP/SLP means this feature will work with tapes recorded in Standard Playback, Long Playback or Super Long Playback. LP/SLP means this feature will work with tapes recorded in Long Playback and Super Long Playback. Tape speed details are on page 27.
- During forward and reverse searching, horizontal noise bars will appear on the screen.

Automatic Operation Features 41

The following videotape features are available.

Automatic Rewind, Eject, Off

When you play, fast forward or record a videotape to its end, the TV/VCR/DVD will rewind the tape, stop, turn itself off, and eject the tape.

If Repeat Play is activated, playback will start again instead.

Details are on page 35.

The tape will not rewind automatically after a timer recording or One-Touch Recording ends. To rewind a tape after timer recordings, see Auto Return details on page 33.

Automatic Tracking Adjustment

The TV/VCR/DVD automatically adjusts the videotape tracking to give you the best possible picture quality. With some recordings, however, you may get a better picture using the manual tracking controls (see below).

Manual Tracking

To adjust the tracking manually, press CHANNEL ▲/▼ on the front of the TV/VCR/DVD or CH. ▲/▼ on the remote control during playback.

Tracking returns to Automatic Tracking Adjustment when you insert a tape or press STOP ■.

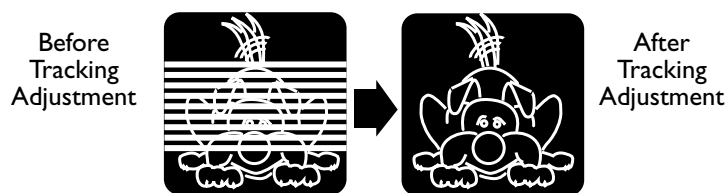

42 Closed Captions

Follow the steps below to select closed captions for TV programming. Not all TV programs and commercials have closed captions or all types of closed captions (second language, half-screen text, etc.). If closed captioning is not broadcast, you cannot receive it. This does not indicate a problem with the TV/VCR/DVD. Check your TV program listings for shows with closed captions.

If the TV/VCR/DVD receives poor quality television signals, the captions may contain errors, or there might be no captions at all. Some possible causes of poor quality signals are:

- Automobile ignition noise
- Electric motor noise
- Weak signal reception
- Multiplex signal reception (ghosts or screen flutter)
- Playing poorly recorded or worn videotapes.

- 1 Press SETUP.**
Press ▲ or ▼ to select **CAPTION**.

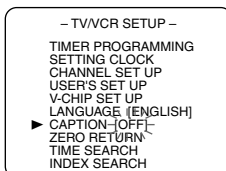

- 2 Press ENTER repeatedly to select CAPTION1, CAPTION2, TEXT1, TEXT2 or OFF.**

CAPTION1 displays standard closed captions (what a character is saying). CAPTION2 displays foreign language closed captions (foreign language words showing what a character is saying).

TEXT1 and TEXT2 display half-screen text (such as a channel guide, schedule or announcement).

OFF turns off closed captions. Captions will not appear on the screen.

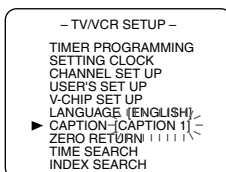

- 3 Press SETUP to exit the menu.**

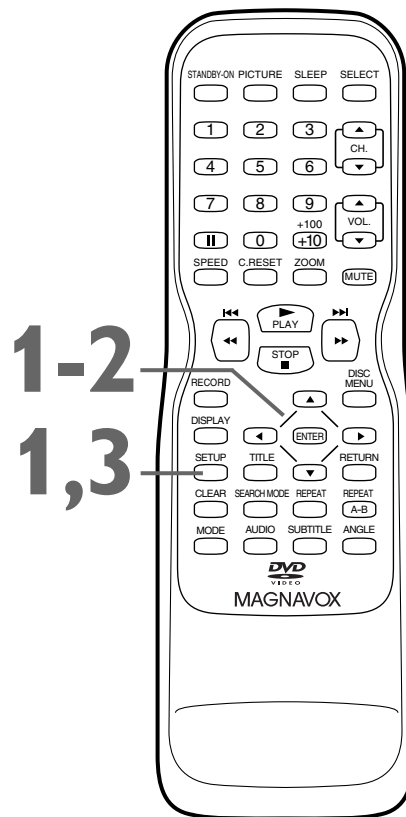

Helpful Hints

- If a black box appears on the screen, a TEXT mode is selected. Select CAPTION1, CAPTION2 or OFF.
- The TV/VCR/DVD retains the Closed Caption setting if the power fails.
- Abbreviations, symbols and other grammatical shortcuts may be used in order to keep pace with the on-screen action. This is not a problem with the TV/VCR/DVD.
- Changing channels may delay closed captions for a few seconds.
- Adjusting or muting the volume may delay closed captions for a few seconds.

Setting V-Chip 43

TV Rating Settings

V-CHIP enables parents to prevent their children from watching inappropriate material on TV. V-CHIP reads the ratings for programming (except for news and sports programs, unedited movies on premium cable channels, and Emergency Broadcast System signals), then denies access to programming if the program's rating meets the limitations you select. In this case, a "PROTECTED PROGRAM by ..." message appears on the TV screen.

If the "PROTECTED..." message appears during your TV viewing, change to a channel that is not blocked. Then, you can access the V-Chip Setup menu and change the settings to allow all TV viewing.

Programming may be rated by the Motion Picture Association of America (MPAA) or according to the Television Parental Guidelines. To block any inappropriate programming, set your limits in both MPAA RATING and TV RATING.

Before you begin, make sure ...

- The TV/VCR/DVD is on.
- The unit is in TV/VCR mode. Press SELECT on the remote until you see TV channels and see the red VCR/TV light on the front of the TV/VCR/DVD.

1 Press SETUP. Press ▲ or ▼ to select V-CHIP SET UP. Then, press ENTER.

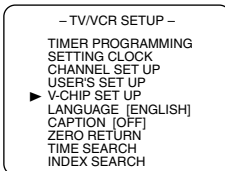

2 Press the Number buttons to enter the 4-digit access code. When entering the access code for the first time or if there has been a power failure, enter default code 0000. 4 Xs will appear instead of your code. This protects the identity of your code.

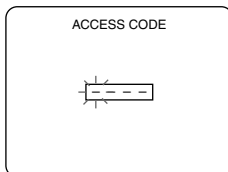

3 Press ▲ or ▼ to select TV RATING. Then, press ENTER.

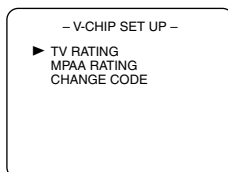

Instructions continue on the next page.

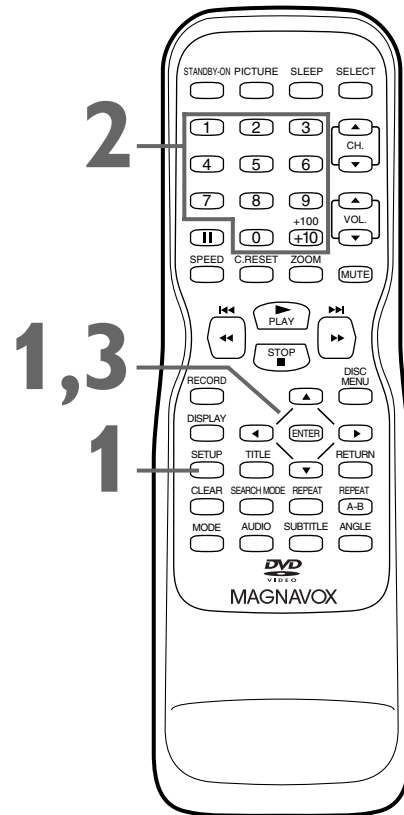

TV Rating Explanations

- TV-Y - Appropriate for all children
- TV-Y7 - Appropriate for children seven and older
- TV-G - General Audience
- TV-PG - Parental Guidance suggested.
- TV-14 - Unsuitable for children under 14
- TV-MA - Mature audience only

44 Setting V-Chip (cont'd)

Instructions continued from the previous page.

- 4** Press **▲** or **▼** to select the TV Rating level at which you want to block viewing, then press **ENTER** once. If you press **ENTER** again, the subratings for that category will appear.
Details are on pages 45-46.

When you select the rating category and set it to **BLOCK**, the higher ratings will turn to **BLOCK** automatically. Lower ratings will turn to **VIEW**.
When you set "TV-Y" to **VIEW** (or **BLOCK**), all ratings will turn to **VIEW** (or **BLOCK**) automatically.

| | | |
|-------|-----|---------|
| TV-Y | () | [VIEW] |
| TV-Y7 | () | [VIEW] |
| TV-G | () | [BLOCK] |
| TV-PG | () | [BLOCK] |
| TV-14 | () | [BLOCK] |
| TV-MA | () | [BLOCK] |

- 5** Press **SETUP** to save your settings and remove the menus.

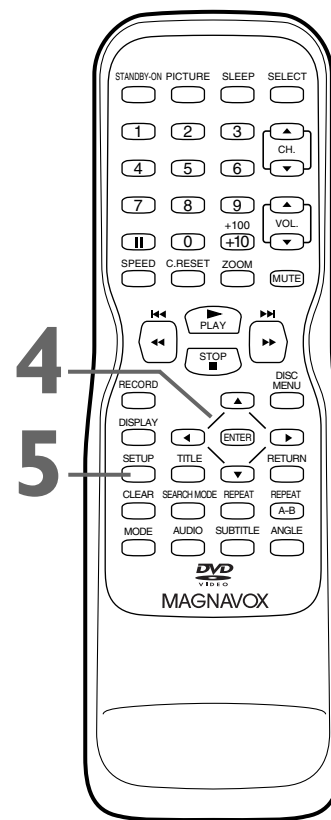

Helpful Hints

- If you want to disable V-Chip so you can view all TV programming, set TV-Y to VIEW.
- The V-CHIP settings will be retained after a power failure (except the access code reverts to 0000).

Setting V-Chip (cont'd) 45

TV Rating Subratings

When you select TV-Y7, TV-PG, TV-14 or TV-MA, you can use the subratings to block specific elements of programming, such as language or violence.

1 Press **SETUP**.

2 Press **▲** or **▼** to select **V-CHIP SET UP**.
Press **ENTER**.

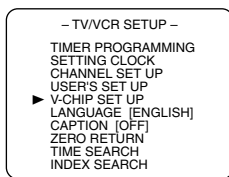

3 Press the **Number** buttons to enter the **4-digit access code**. The default code is **0000** (if you have not set up your own code yet or if there has been a power failure).

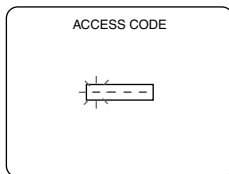

4 Press **▲** or **▼** to select **TV RATING**.
Press **ENTER**.

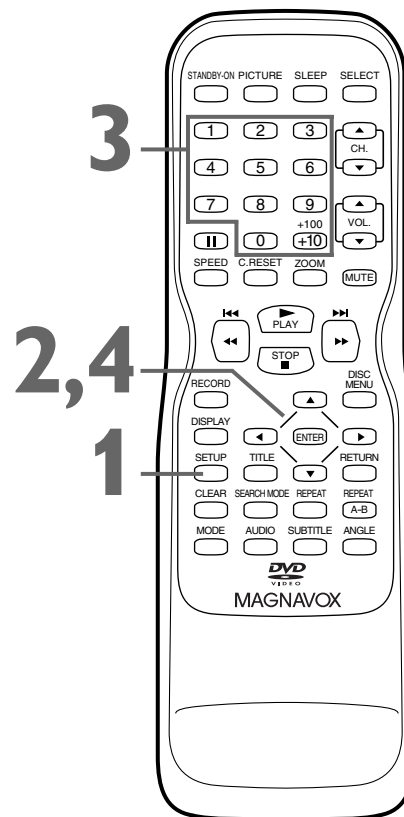
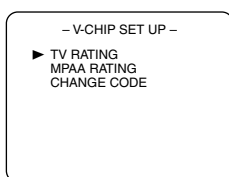

Instructions continue on the next page.

46 Setting V-Chip (cont'd)

Instructions continued from the previous page.

- 5** Press ▲ or ▼ to select the rating you wish to adjust. Then, press ENTER twice to go to its subratings.

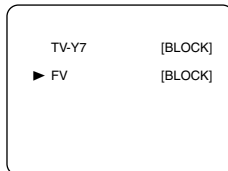

Example:
TV-Y7 subratings

- **When you select TV-Y7:**
Press ▲ or ▼ to select FV (Fantasy Violence, violence that seems realistic to young children). Then, press ENTER to select BLOCK or VIEW.
- **When you select TV-PG, TV-14 or TV-MA:**
Press ▲ or ▼ to select "D" (Suggestive Dialog), "L" (Coarse Language), "S" (Sexual Situation) or "V" (Violence). Then, press ENTER repeatedly to select BLOCK or VIEW for each subrating.
To go to the previous menu, press RETURN.

- 6** Press **SETUP** to save your settings and remove the menus.

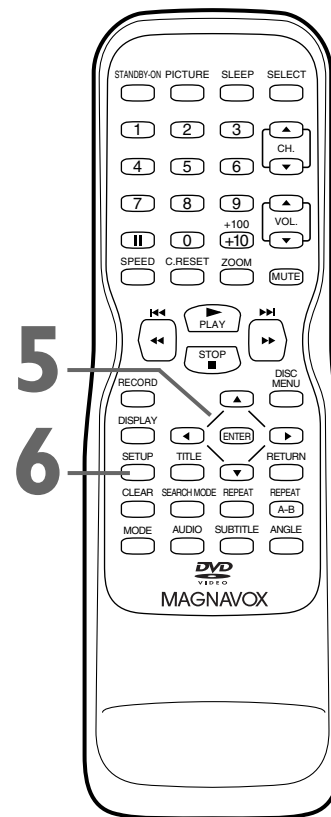

Helpful Hints

- Dialog (D) is not an available subrating for TV-MA.
- Blocked subratings will appear beside the rating category in the TV Ratings menu.
- You cannot BLOCK a subrating (D, L, S or V) if the main category is set to VIEW. However, you can set a subrating to VIEW even when the main category is set to BLOCK.
- Changing the category to BLOCK or VIEW automatically changes all its subratings to the same (BLOCK or VIEW).

Setting V-Chip (cont'd) 47

MPAA Rating Settings

You can block TV channel viewing according to the Motion Picture Association ratings. To do so, follow these steps.

1 Press SETUP.

2 Press ▲ or ▼ to select V-CHIP SET UP. Then, press ENTER.

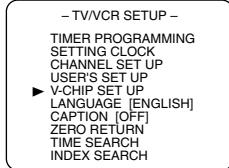

3 Press the Number buttons to enter the 4-digit access code. (The default code is 0000 if you have not set up your own code yet or if the power has failed.)

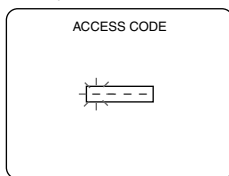

4 Press ▲ or ▼ to select MPAA RATING. Then, press ENTER.

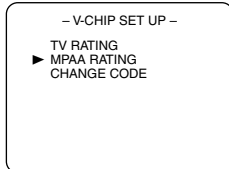

5 Press ▲ or ▼ to select the level at which you want to block viewing. Then, press ENTER to select BLOCK or VIEW.

When you Block a category, higher ratings turn to BLOCK automatically. Lower ratings turn to VIEW. When you set G to VIEW or BLOCK, all ratings turn to VIEW or BLOCK automatically.

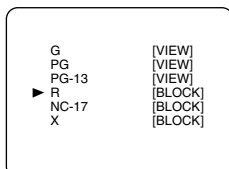

6 Press SETUP to save your settings and remove the menus.

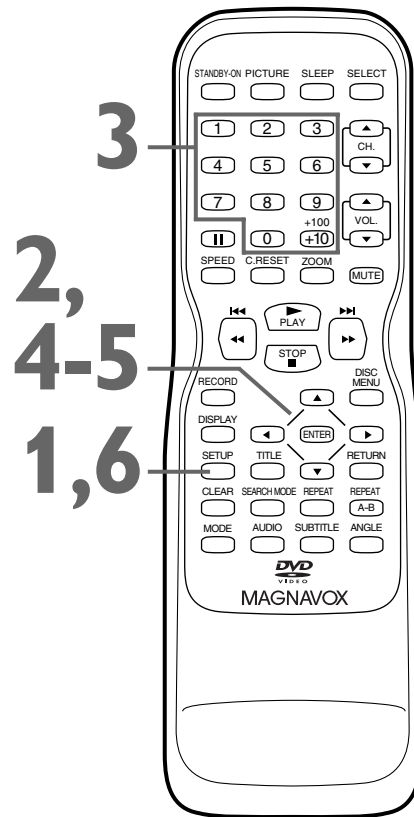

MPAA Rating Explanations

- G - General Audience
- PG - Parental Guidance suggested.
- PG-13 - Unsuitable for children under 13
- R - Restricted; under 17 requires accompanying parent or adult guardian
- NC-17 - No one under 17 admitted
- X - Mature audience only

Helpful Hints

- To disable all the MPAA Ratings, set G to VIEW.
- The V-CHIP settings will be retained after a power failure (except the access code reverts to 0000).

48 Setting V-Chip (cont'd)

Changing the Access Code

Although the default code 0000 is supplied with the TV/VCR/DVD, you can set your own access code.

- 1** Press **SETUP**.
- 2** Press **▲** or **▼** to select **V-CHIP SET UP**. Then, press **ENTER**.
- 3** Press the **Number** buttons to enter the old access code. When doing this for the first time, use 0000. 4 Xs will appear instead of the code to protect its identity.

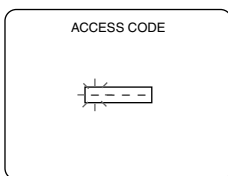

- 4** Press **▲** or **▼** to select **CHANGE CODE**. Then, press **ENTER**.

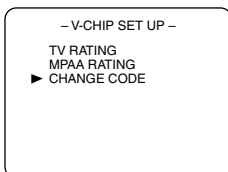

- 5** Press the **Number** buttons to enter your preferred access code in the **NEW CODE** space. Then, enter the same code in the **CONFIRM CODE** space. Again, Xs will appear instead of the code numbers. The access code must have exactly 4 digits.

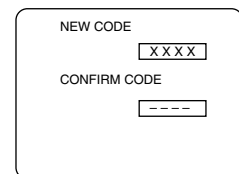

- 6** Press **SETUP** to save your settings and remove the menus.

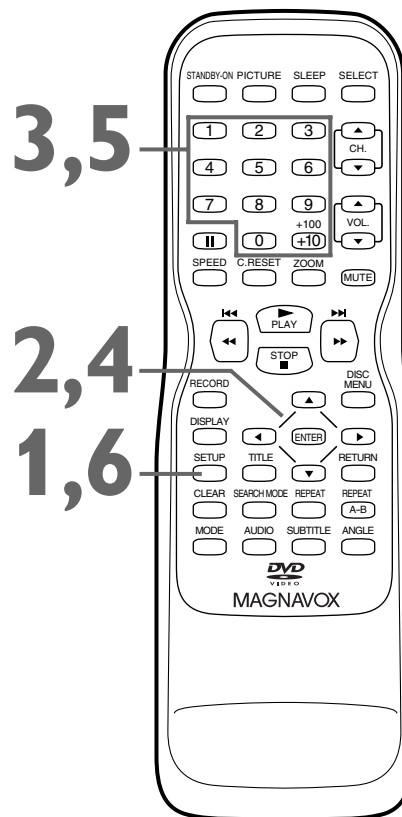

Helpful Hints

- If you enter the wrong code in the CONFIRM CODE space, repeat step 5. Enter the same new code exactly in the CONFIRM CODE space.
- If you unplug the power cord or if the power fails, the default code will be active again (0000). Change your access code again as necessary.

50 Multi-Channel Television Sound (MTS) (cont'd)

For TV Audio

1 While receiving an MTS broadcast, press **AUDIO** repeatedly to select **STEREO**, **SAP** (Second Audio Program) or **MONO**.

- The output mode changes as described below every time you press the button.



- The current mode appears on the TV screen for about 5 seconds.

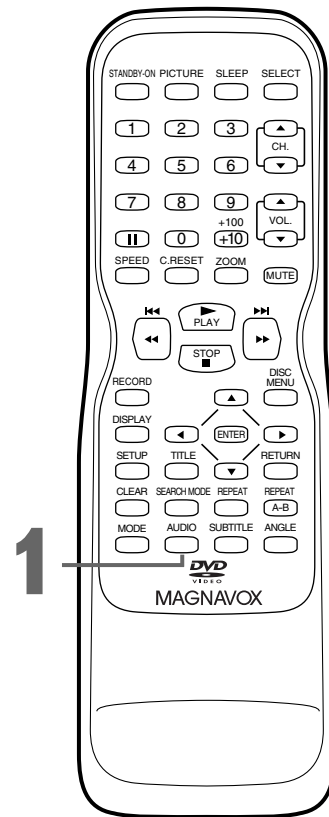

Helpful Hint

- The initial setting is STEREO.
- When recording a TV program, TV/VCR/DVD records MTS broadcasts in HIFI stereo sound automatically unless you select SAP mode recording beforehand.
- This setting is saved even if the until is turned off.
- If you select second audio when second audio is not available, the TV/VCR/DVD will receive and record normal audio.

Multi-Channel Television Sound (MTS) (cont'd) 51

For VCR Audio

1 During playback of a videotape, press **AUDIO** to select **HIFI** or **MONO**.

- The current mode appears on the TV screen for about 5 seconds.
- The initial setting is HIFI.
- This setting is saved until the cassette is ejected.

For External Devices

- Pressing **AUDIO** does not affect the audio output mode of an external device.
- The current audio output mode of an external device does not appear on the TV screen.

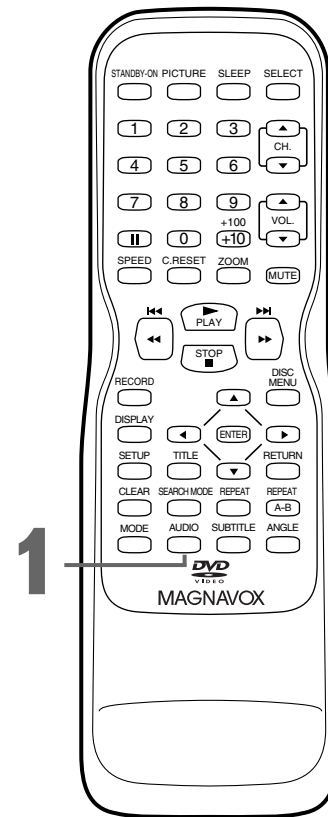

Helpful Hints

- Non-HIFI tapes will play in monaural automatically.
- When playing a non-HIFI tape, pressing **AUDIO** will only affect the display shown on the TV screen but it does not affect the actual sound mode.
- MTS broadcasts automatically record in HIFI unless you select SAP before recording. Details are on page 50.

52 DVD Disc Menus, Title Menus

Disc Menus

Some DVDs contain menus that describe the contents of the disc or allow you to customize disc playback. For example, the menu may offer choices for subtitle languages, special features or scene selection.

To use the DVD disc menu and select playback features, follow these steps.

- **Before you begin, press SELECT** to put the TV/VCR/DVD in DVD mode. The green DVD light will appear on the front of the TV/VCR/DVD.

- 1 Press DISC MENU.**
The DVD's disc menu will appear.
- 2 Press ▲, ▼, ◀ or ▶ to select an item, then press ENTER.** Continue this process to set up all the features you want or to start disc playback.

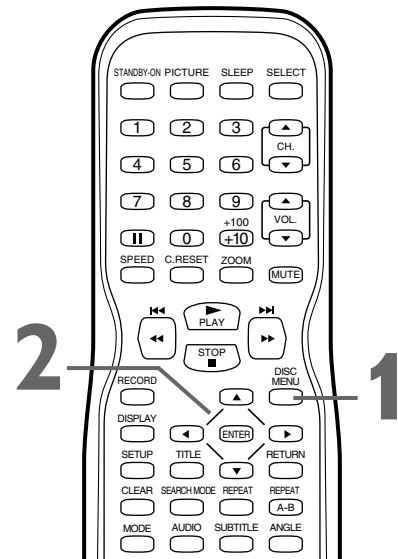

Title Menus

Some DVDs have a title menu, which lists the titles available on the DVD. Use the title menu to play a specific Title.

- **Before you begin, press SELECT** to put the TV/VCR/DVD in DVD mode. The green DVD light will appear on the front of the TV/VCR/DVD.

- 1 Press TITLE.** The title menu will appear.
If a title menu is not available, the "X" may appear on the TV screen. Or, if the DVD only has a main menu as described above, it may appear when you press TITLE.
- 2 Press ▲, ▼, ◀ or ▶ to select a title, then press ENTER.** Playback will begin at the title you selected.

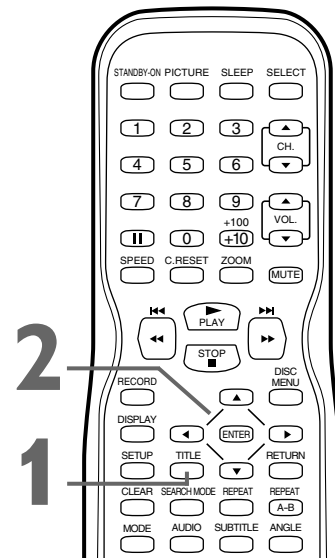

Helpful Hints

- Menus vary among discs. Follow the information with the DVD.
- Not all DVDs have disc or title menus.
- Some DVDs may refer to chapters as "scenes." Some DVDs may refer to the title menu as the "scene index."
- TITLE may not be active with all DVDs.

Fast Forward/Reverse Search 53

- **Before you begin, press SELECT** to put the TV/VCR/DVD in DVD mode. The green DVD light will appear on the front of the TV/VCR/DVD.

1 During playback, press and hold **▶▶▶/▶▶▶** or **◀◀◀/◀◀◀** on the remote control to fast forward or fast reverse the picture.

- For DVD playback, each time you press and hold the button, it will increase the speed by approximately 2, 8, 20, 50 or 100 times the normal speed. The speed may vary depending on the disc.

▶▶▶ 1, ▶▶▶ 2, ▶▶▶ 3, ▶▶▶ 4 or ▶▶▶ 5 will appear briefly on the TV screen to indicate forward searching. Or, ◀◀◀ 1, ◀◀◀ 2, ◀◀◀ 3, ◀◀◀ 4 or ◀◀◀ 5 will indicate reverse searching.

For DVD playback, the sound will be mute during the search.

- For Video CDs, Audio CDs or MP3 playback, the speed will increase by 2, 8 or 30 times the normal speed. The speed may vary depending on the disc.

▶▶▶ 1, ▶▶▶ 2 or ▶▶▶ 3 will appear briefly on the TV screen to indicate forward searching. Or, ◀◀◀ 1, ◀◀◀ 2 or ◀◀◀ 3 will indicate reverse searching.

For MP3 or Audio CD playback, the sound will be intermittent during the search.



Example: Playing a DVD in reverse at twice the normal playing speed.

2 Press **PLAY ▶** to return to normal playback.

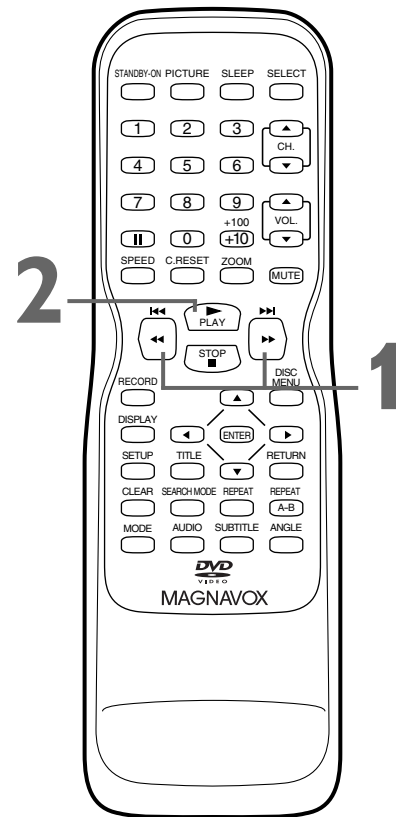

Helpful Hint

- If you use **▶▶▶/▶▶▶** or **◀◀◀/◀◀◀** during Dual Playback, JPEG playback will be paused.

54 Title/Chapter Playback, Specific Time Playback

Title/Chapter Playback

- Before you begin, press **SELECT** to put the TV/VCR/DVD in DVD mode. The green DVD light will appear on the front of the TV/VCR/DVD.

- 1 During DVD playback, press **SEARCH MODE** until CH (for chapter) or TT (for title) appears on the TV. The number of available titles or chapters will appear at the right (/4, for example).

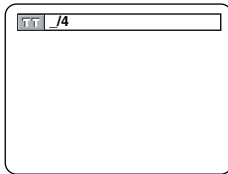

- 2 Enter the title or chapter number using the **Number buttons**. The title or chapter will play.
 - To select a single-digit title/chapter number when there are more than 10 tracks, press **ENTER** to play the title/chapter.
 - If you enter a title/chapter number that is not available on the disc, playback will not begin (or the current title/chapter will continue to play).

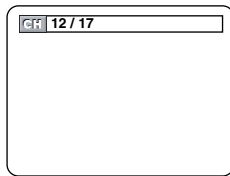
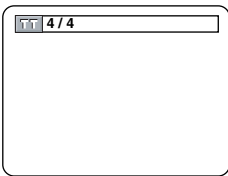

Specific Time Playback

- Before you begin, press **SELECT** to put the TV/VCR/DVD in DVD mode. The green DVD light will appear on the front of the TV/VCR/DVD.

- 1 During DVD, Audio CD or Video CD (without PBC) play, press **SEARCH MODE** until the Time Search display appears.

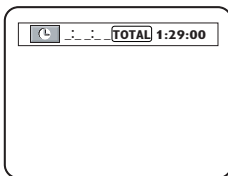

- 2 Within 30 seconds, use the **Number buttons** to enter the elapsed playing time (of the track or title) at which you want play to begin. Enter the time in hours, minutes and seconds. Within a few seconds, playback will start at the specified time.
 - Example: 1 hour, 23 minutes and 30 seconds
1 → 2 → 3 → 3 → 0
 - Make sure the time you enter is within the total time of the current title or track. If it is not, the time space will clear and playback will continue at its current point. The total time available in the current track or title will appear in the Time Search display.
 - If you make a mistake entering the time, press **CLEAR** to clear the time area. Enter the correct information.

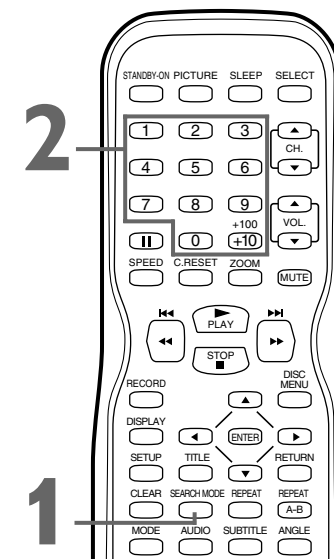
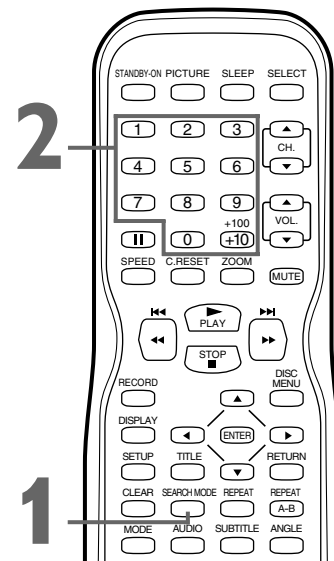

Helpful Hints

- When playback is stopped, use the **Number buttons** to select a title for immediate playback. During playback, use the **Number buttons** to choose a chapter for immediate playback.
- Title/chapter playback is not available with some DVDs.

Track Playback 55

There are three ways to play a specific Audio CD, Video CD (without PBC), MP3 or JPEG track: Use the Number buttons, SEARCH MODE or \lll/\lll and \ggg/\ggg .

- **Before you begin, press SELECT** to put the TV/VCR/DVD in DVD mode. The green DVD light will appear on the front of the TV/VCR/DVD. Make sure a valid disc is in the disc tray.

A

Using the Number Buttons

Press the Number buttons to enter a track number. Playback will start at the selected track.

For tracks 10 and above, press the +100/+10 button so the Search display (TR _ _ /12 - an example of total tracks) appears on the TV. Press the Number button of the first digit, then press the Number button of the second digit. For example, to playback track 26, press +100/+10, then Number 2, then Number 6. For single-digit tracks (1-9), press a single Number button. If you enter a track number that is not available on the disc, playback will not begin (or the current track will continue to play).

B

Using SEARCH MODE

Press SEARCH MODE so the Track Search Display (TR) appears. Within 30 seconds, press the Number buttons to select the track number. Playback will begin at the selected track. For a single-digit track (1-9), enter 0 first. For example, to play track 5, press 0, 5. You do not have to use the +100/+10 button in Search Mode for tracks 10 and above.

C

Using \lll/\lll and \ggg/\ggg

During playback, press \ggg/\ggg to skip the current track and move to the next track.

Press \lll/\lll to return to the beginning of the current track or to go to previous tracks.

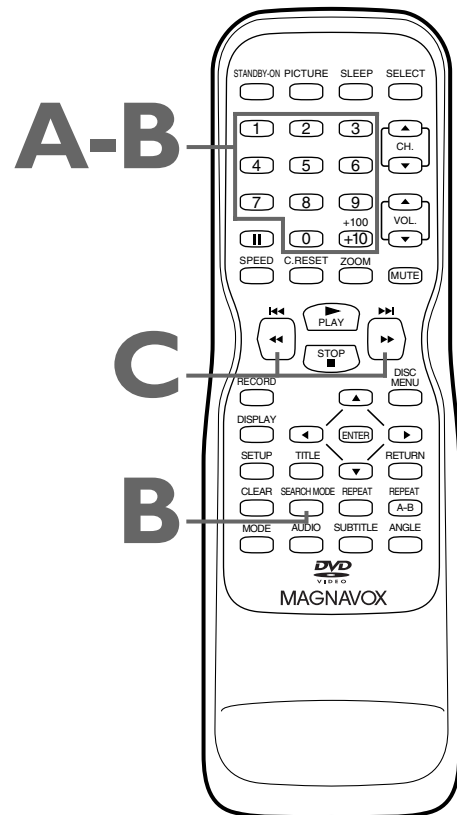

Helpful Hints

- \lll/\lll and \ggg/\ggg does not function when playback is stopped.
- You cannot use \ggg/\ggg to go from the last track on the disc to the first track.
- Using \lll/\lll or \ggg/\ggg will only affect MP3 files during Dual Playback.

56 Paused and Step-by-Step Playback, Resume On

Paused and Step-by-Step Playback

- Before you begin, press **SELECT** to put the TV/VCR/DVD in DVD mode. The green DVD light will appear on the front of the TV/VCR/DVD.

- 1 During disc playback, press **II**.**
Playback will pause and the sound will be mute.
 - Pressing **II** once during Dual Playback will pause a JPEG file only. Pressing **II** one more time will pause an MP3 track.
- 2 Press **II** repeatedly to see a DVD or Video CD picture advance one frame (or step) at a time.**
The sound will remain mute. Pressing **II** repeatedly during Audio CD, MP3 or JPEG playback will have no effect.
- 3 Press **PLAY** ► to resume playback.**

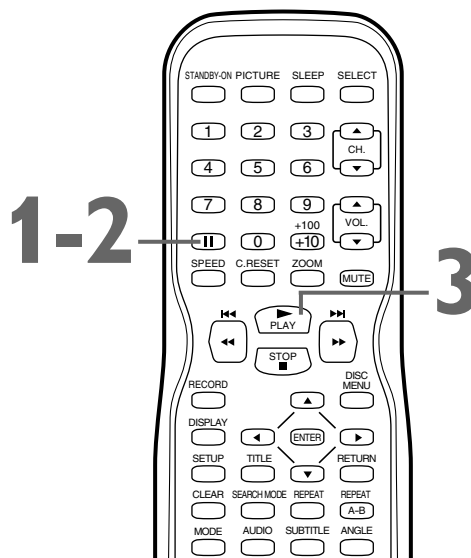

Resume On

- Before you begin, press **SELECT** to put the TV/VCR/DVD in DVD mode. The green DVD light will appear on the front of the TV/VCR/DVD.

- 1 Press **STOP** ■ during playback.** In a few seconds, the following Resume message will appear on the TV screen.

For DVD, AudioCD or VideoCD:

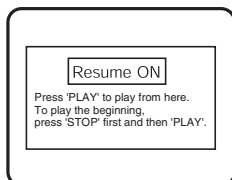

For MP3 or JPEG:

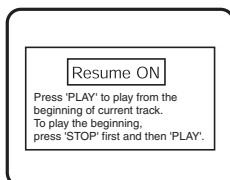

- 2 Press **PLAY** ►.** In a few seconds, playback will resume from the point at which it stopped last. You can resume playing at the same point even if you turn off the DVD/VCR, then turn it on again later. However, opening the disc tray will cancel the Resume feature. Playback will start at the beginning the next time you insert the disc. For MP3 and JPEG, the playback will resume from the beginning of the current track. To cancel Resume and start playing the disc from the beginning, press **STOP** ■ again while playback is stopped. The Stop symbol (■) will appear briefly on the TV screen. Press **PLAY** ► to start playing the disc from the beginning. The resume information will be saved even when the power is turned off.

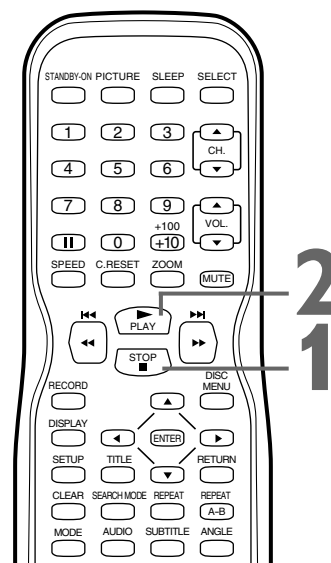

Helpful Hint

- Set **STILL MODE** to **FIELD** in the Display menu if paused images are blurry. Details are on pages 70-71.

Repeat, A-B Repeat 57

Repeat

- **Before you begin, press SELECT** to put the TV/VCR/DVD in DVD mode. The green DVD light will appear on the front of the TV/VCR/DVD.

- 1 During playback, press REPEAT until the repeat mode you want appears on the TV.**
On a DVD, select CHAPTER, TITLE or OFF.
On an Audio CD and Video CD (without PBC), select TRACK, ALL (all tracks on the disc) or OFF. With MP3 or JPEG files, select TRACK, GROUP (all tracks in the current folder), ALL or OFF.
Selecting a new track, chapter or title will cancel repeat playback.



Example: Repeat a DVD chapter



Example: Repeat an Audio CD or Video CD track

A-B Repeat

Follow these steps to play a section of a DVD, Audio CD or Video CD repeatedly.

- 1 During disc playback, press REPEAT A-B to set the starting point (A).** If you make a mistake, press CLEAR. This will erase point A and let you start over. OFF will appear briefly on the TV screen.

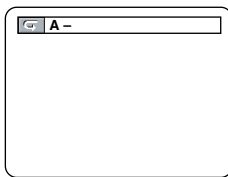

- 2 Play the disc to the point at which you want repeated playback to end, then press REPEAT A-B again.** Within a few seconds, the section will begin to play. The segment will play over and over until you cancel the A-B Repeat feature.

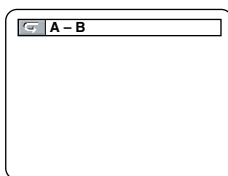

- 3 To cancel A-B Repeat Playback, press REPEAT A-B so OFF appears on the TV screen.** Regular playback will resume.

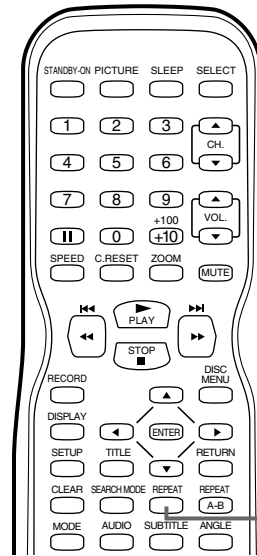

1

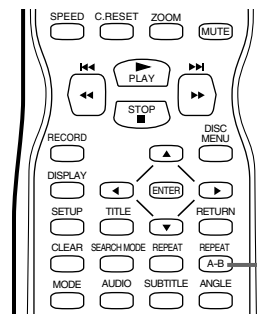

1-3

Helpful Hints

- Repeat and A-B Repeat are not available with some discs.
- A-B Repeat is not available with MP3 tracks.
- The entire A-B Repeat section must be within a single title or track. If you do not enter Point B before the end of the track or title is reached, the end of the track or title will become Point B automatically.
- Stopping playback will cancel A-B Repeat.
- If you choose GROUP Repeat during Dual Playback, all tracks or files in each folder will play repeatedly. For example if you choose GROUP Repeat during Dual Playback of MP3 folder A and JPEG folder B, all MP3 tracks in folder A and all JPEG files in folder B will be repeated.

58 Markers

Use Markers to remember your favorite places on a DVD, an Audio CD or a Video CD (without PBC). To set the Markers, follow these steps.

- **Before you begin, press SELECT** to put the TV/VCR/DVD in DVD mode. The green DVD light will appear on the front of the TV/VCR/DVD.

- 1** Play the disc to within 30 seconds prior to the point at which you want to set the Marker. **During playback, press SEARCH MODE until the Markers appear** at the top of the TV screen.

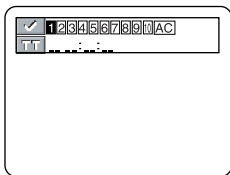

Example: DVD

- 2** Within 30 seconds, press ◀ or ▶ to select a Marker (1-10). Make sure ____:____:____ appears beneath the number.

- 3** Let the disc playback to the point at which you want to set the Marker (up to 30 seconds away).

When the disc reaches the point you want to remember, press ENTER. The title or track number and its elapsed playing time will appear beneath the markers.

A checkmark will replace the Marker number. The Marker display will disappear in about 30 seconds, or press SEARCH MODE again to remove the Marker display.

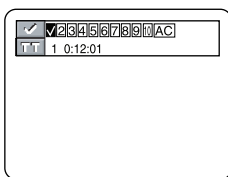

Example: DVD

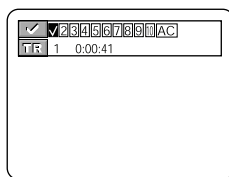

Example: Audio CD
or Video CD

- 4** To return to a Marker during playback, press **SEARCH MODE** until you see the Markers. Press ◀ or ▶ to choose the Marker you want, then press **ENTER**. Disc playback will continue from the marked point.

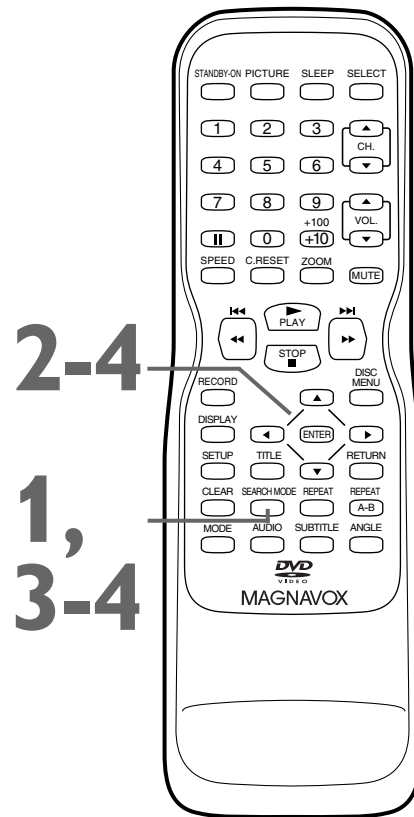

Helpful Hints

- Opening the disc tray, switching to TV/VCR mode, or turning off the TV/VCR/DVD will erase all the Markers.
- To erase a single Marker, press SEARCH MODE until you see the Markers. Press ◀ or ▶ to select a Marker. Press CLEAR. Press RETURN to remove the display.
- To erase all the Markers, press SEARCH MODE until you see the Markers. Press ▶ to select AC (All Clear), then press ENTER. Press SEARCH MODE or RETURN to remove the display.

Subtitles, Camera Angles 59

Subtitles

You can select a language for DVD subtitles during playback. You may select only the subtitles that are available on the DVD.

- **Before you begin, press SELECT** to put the TV/VCR/DVD in DVD mode. The green DVD light will appear on the front of the TV/VCR/DVD.

- 1 During playback, press SUBTITLE repeatedly to select a subtitle language.** The number of available languages appears at the right of the subtitle display.

In the example below, six languages are available (/ 6). After a few seconds, the subtitles will appear. Or, press SUBTITLE repeatedly to turn off Subtitles. When no subtitles are available, "NOT AVAILABLE" appears at the right of the subtitle display.



Example: English as first of six available subtitles

Camera Angles

Some DVDs contain scenes recorded from different angles. The camera angle will not change if the DVD does not contain sequences recorded from different perspectives.

- **Before you begin, press SELECT** to put the TV/VCR/DVD in DVD mode. The green DVD light will appear on the front of the TV/VCR/DVD.

- 1 During DVD playback, press ANGLE repeatedly to select a different angle.** The number of available angles appears at the right of the Angle display. In this example, eight angles are available (/ 8).

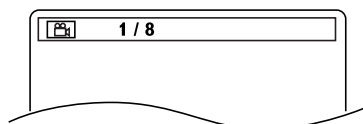

Example: Angle 1 of eight available angles

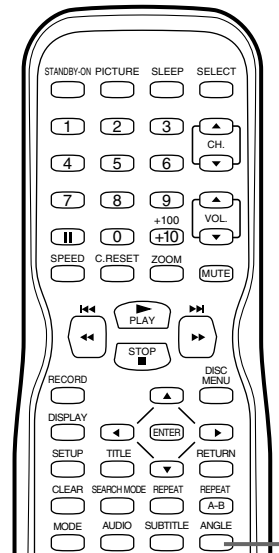
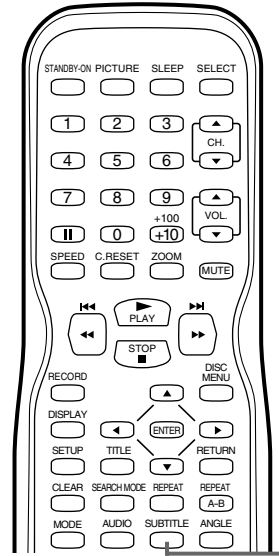

Helpful Hints

- With some DVDs, you must select a subtitle language in the disc menu.
- If the desired language does not appear after pressing SUBTITLE several times, the disc does not have subtitles in that language.
- Opening the disc tray will cancel your subtitle setting.
- If the ANGLE ICON setting is ON,  will appear on the TV screen when the current portion of the disc has multiple camera angles. To set the ANGLE ICON ON or OFF, see pages 77-78.

60 Slow Motion, Zoom

Slow Motion

- 1 Press **II** during DVD or Video CD playback.
- 2 Press and hold **▶▶/▶▶** or **◀◀/◀◀** for a few seconds. Slow motion playback will begin. Press **▶▶/▶▶** or **◀◀/◀◀** repeatedly to play the DVD forward or backward at approximately 1/16, 1/8 or 1/2 the normal speed. Reverse slow motion is not available on a Video CD.
An **▶▶ 1 (1/16)**, **▶▶ 2 (1/8)** or **▶▶ 3 (1/2)** will appear briefly on the TV screen to indicate slow forward playback.
An **◀◀ 1 (1/16)**, **◀◀ 2 (1/8)** or **◀◀ 3 (1/2)** will indicate slow reverse playback.



Example: Playing a DVD forward at half the normal speed.

- 3 Press **PLAY ▶** to return to normal playback.

Zoom

Zooming lets you enlarge the playback image of a DVDs, Video CDs or JPEG CDs, and lets you pan through the enlarged image.

- 1 Press **ZOOM** during playback. **[-] ZOOM1** will appear on the screen. The picture will be 1.3 times larger. Press **ZOOM** again to increase the picture to twice the regular size. **[+] ZOOM2** will appear. Press **ZOOM** again to increase the picture to 4 times the regular size. **[+] ZOOM3** will appear.

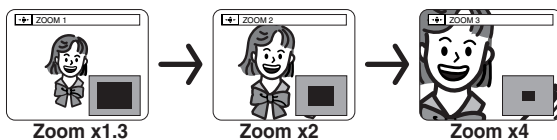

- 2 Press **▲, ▼, ◀** or **▶** to move the zoomed image up, down, left or right.



Position guide example:
The Zoomed area is in the top portion of the overall picture.

- 3 To return the picture to its normal size, press **ZOOM** repeatedly.

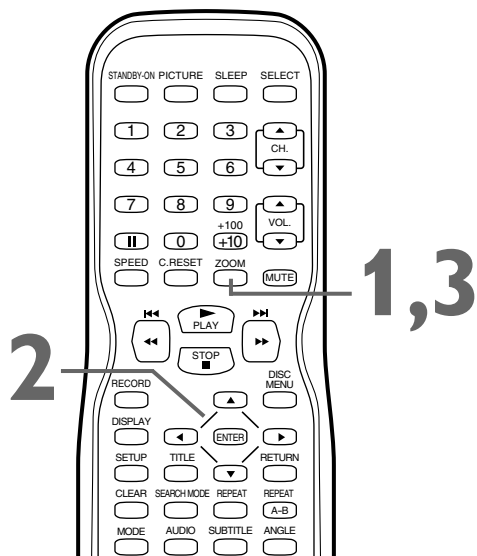
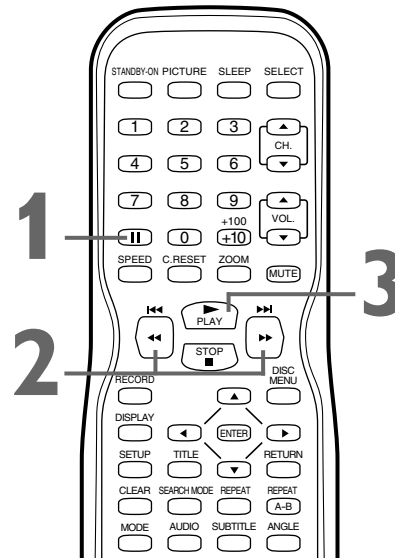

Helpful Hints

- The sound will be mute during slow motion playback.
- The gray box with an inner blue box that shows during Zoomed playback is the position guide. To remove it or show it, press **ENTER**. The position of the blue box inside the gray box indicates the position of the zoomed image within the overall picture.
- The x4 zooming is not active with some discs. x1.3 and x2 zooming is available for Video CDs. Only x2 zooming is available for JPEGs.
- Position guide is not available for JPEG playback.

Audio Language, Stereo Sound 61

Audio Language

You can select a language for DVDs during playback if multiple languages are available.

- **Before you begin, press SELECT** to put the TV/VCR/DVD in DVD mode. The green DVD light will appear on the front of the TV/VCR/DVD.

1 During DVD playback, press **AUDIO** repeatedly to choose one of the available languages. Audio display appears at the top of the TV screen, and the new audio will be heard. The display will disappear after about 5 seconds.

The Audio display may show the current settings for the Dolby Digital or multi-channel (5.1 CH) sound, if they are available on the disc, and the sampling rate of the disc. The number of available languages appears after the “ / ” at the right of the display (/3, for example).

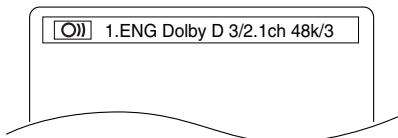

Example: English audio

Stereo Sound

Adjust Stereo Sound to determine whether you will hear the left channel, the right channel or both channels (stereo) during Audio CD or Video CD playback.

1 Press **AUDIO** repeatedly during Audio CD or Video CD playback to choose **STEREO**, **L-ch** or **R-ch**. The display will disappear in about 5 seconds.

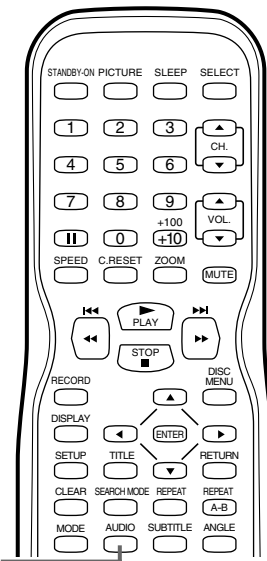
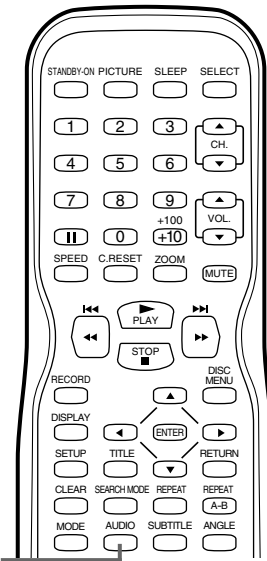
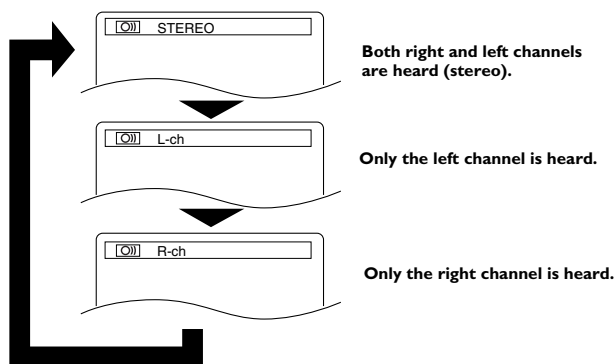

Helpful Hints

- If a language is not available after pressing **AUDIO** several times, the DVD does not have that language.
- Some DVDs only let you change the language in the disc menu.
- Audio languages may be abbreviated (such as **ENG** for English). Or, 3 dashes (- - -) may appear instead of an abbreviation.

62 On-Screen Displays

DVD Display

- Before you begin, press **SELECT** to put the TV/VCR/DVD in DVD mode. The green DVD light will appear on the front of the TV/VCR/DVD.

1 Press **DISPLAY** repeatedly to see the following displays during DVD playback.

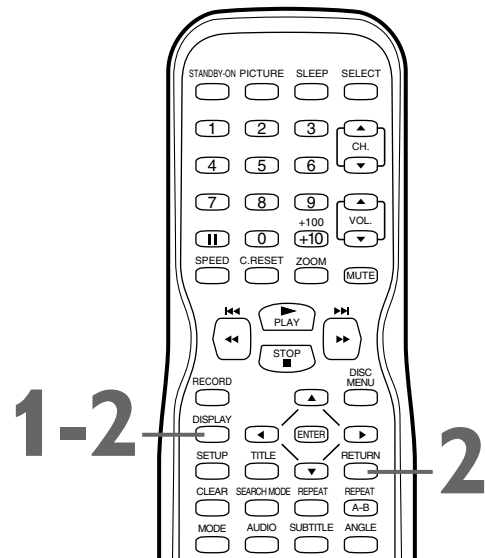
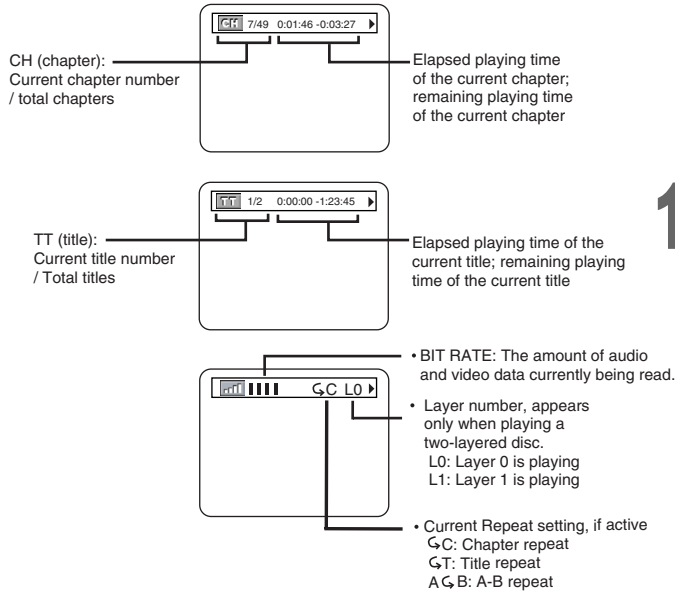

2 Press **DISPLAY** repeatedly or press **RETURN** to remove the display.

Audio CD and Video CD Display

- Before you begin, press **SELECT** to put the TV/VCR/DVD in DVD mode. The green DVD light will appear on the front of the TV/VCR/DVD.

1 Press **DISPLAY** repeatedly to see the following displays during Audio CD or Video CD (without PBC) playback.

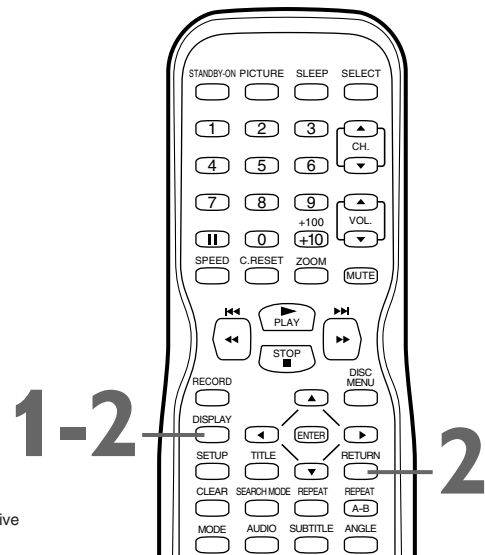
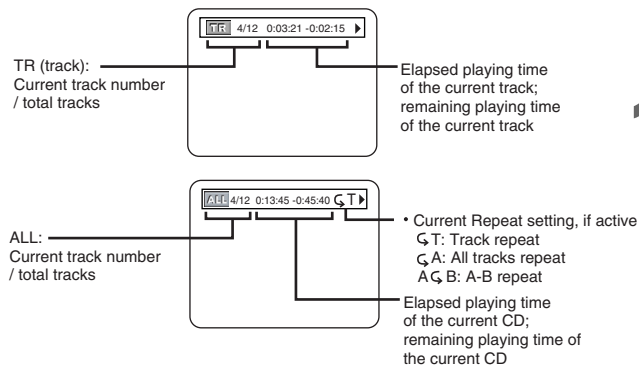

2 Press **DISPLAY** repeatedly or press **RETURN** to remove the display.

On-Screen Displays (cont'd) 63

MP3/JPEG Displays

- Before you begin, press **SELECT** to put the TV/VCR/DVD in DVD mode. The green DVD light will appear on the front of the TV/VCR/DVD.

1 Press **DISPLAY** until the current track or file information appears.

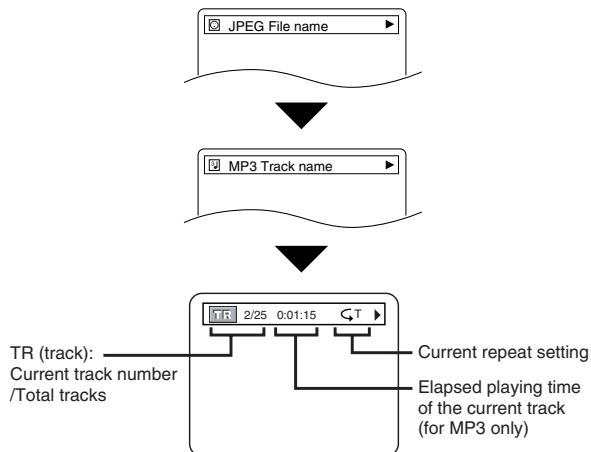

Example: MP3 track

The following may appear to indicate Repeat playback.

- ☑ T: The current track will play repeatedly.
- ☑ G: Tracks in the current folder (group) will play repeatedly.
- ☑ A: All tracks will play repeatedly.

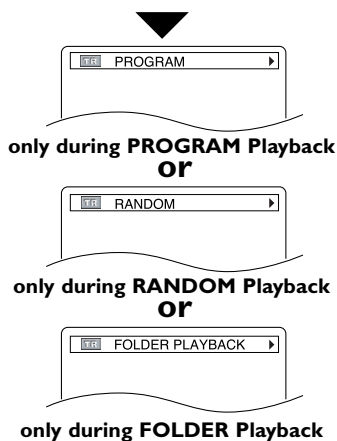

- Program and Random Playback is available only when **DUAL PLAYBACK** is OFF.
- Folder Playback is available only when **DUAL PLAYBACK** is ON.

2 Press **DISPLAY** again to remove the display.

1-2

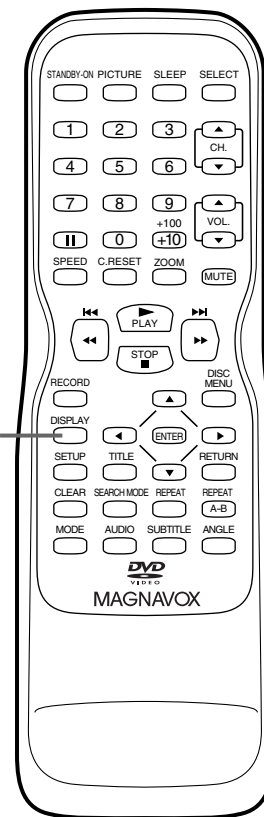

Helpful Hint

- For MP3 files recorded in Variable Bit Rate (VBR), the elapsed time displayed on the screen may vary from the actual elapsed time.

64 Black Level, Virtual Surround, Initializing

Black Level

Adjust Black Level to brighten the DVD and Video CD picture during playback.

- 1 During DVD or Video CD playback, press **MODE** so the Black Level icon shows on the TV screen.



- 2 Within 10 seconds, press **◀**, **▶**, or **ENTER** repeatedly to choose **ON** or **OFF**. **ON** brightens the dark parts of the picture. **OFF** shows the original picture as recorded.

Virtual Surround

You can enjoy improved stereo sound when you play DVDs, Audio CDs, Video CDs or MP3 files recorded in Dolby Digital or Pulse Code Modulation (PCM). Check the disc case for details on availability.

- 1 During disc playback, press **MODE** repeatedly until the Virtual Surround icon appears on the TV screen.



- 2 While the Virtual Surround icon appears, press **◀**, **▶** or **ENTER** to choose **1**, **2** or **OFF**. The default setting is **OFF**. The icon will disappear after about 10 seconds.

Initializing

You can return all the DVD player's Setup menu items (except for PARENTAL) to their default settings.

- Before you begin, press **SELECT** to put the TV/VCR/DVD in DVD mode. The green DVD light will appear on the front of the unit.

- 1 While playback is stopped, press **SETUP** twice. The QUICK SETUP screen appears.

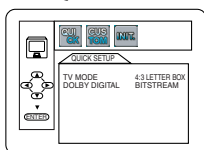

- 2 Press **◀** or **▶** to select **INIT.** (INITIALIZE) at the top of the menu, then press **ENTER**.

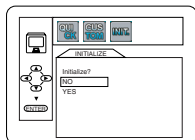

- 3 Press **▲** or **▼** to select **YES**. Then, press **ENTER** twice. To cancel, select **NO** instead.

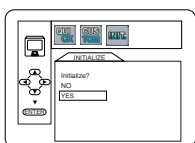

- 4 Press **SETUP** to remove the menu.

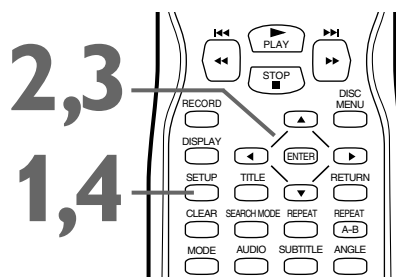
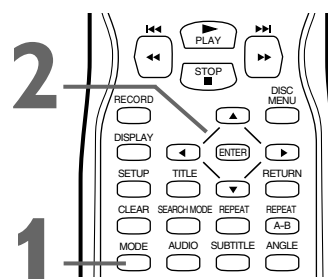
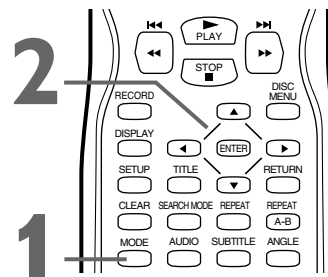

Helpful Hints

- For Audio CDs and Video CDs, you can adjust Virtual Surround only if you set Stereo Sound to **STEREO**. Details are on page 64.
- The Black Level and Virtual Surround settings will be saved even if the player is turned off.

Random Playback, Program Playback 65

Random Playback

You may play Audio CD, JPEG or MP3 tracks in Random order instead of the order in which they are recorded (1,2,3...).

- **Before you begin, press SELECT** to put the TV/VCR/DVD in DVD mode. The green DVD light will appear on the front of the TV/VCR/DVD.

- 1 While playback is stopped, press **MODE** until the **RANDOM** screen appears.

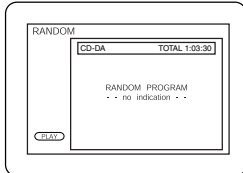

Example: Audio CD

- 2 While the **RANDOM** screen appears, press **PLAY** ►. The tracks will play in random order. After all the tracks have played once, playback will stop.

Program Playback

You may determine the order in which Audio CD, MP3 or JPEG tracks will play. To set a program, follow these steps.

- **Before you begin, press SELECT** to put the TV/VCR/DVD in DVD mode. The green DVD light will appear on the front of the TV/VCR/DVD.

- 1 While playback is stopped, press **MODE** until the **PROGRAM** screen appears.

- 2 Press **▲** or **▼** to select a track you want to play, then press **ENTER**.

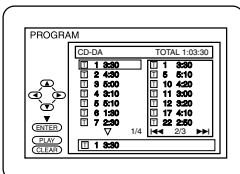

Example: Audio CD

Press **CLEAR** to erase the last track in the program if you make an error.

Additional tracks may be on other screens. press **▼** to go on to the next page, and press **▲** to go back to the previous page.

Repeat this step until you have selected all the tracks you wish to play in the program.

To see tracks in a program when there are more than eight tracks, use **◀◀◀/▶▶▶** to see all the tracks.

For MP3 or JPEG folders, press **◀** or **▶** to go to the previous or next level of folders. Press **TITLE** to return to the first item in the highest level.

- 3 Press **PLAY** ►. The tracks will play once in the order you set. Turning off the TV/VCR/DVD or opening the disc tray will erase the program. You can start program playback only while in the **PROGRAM** screen.

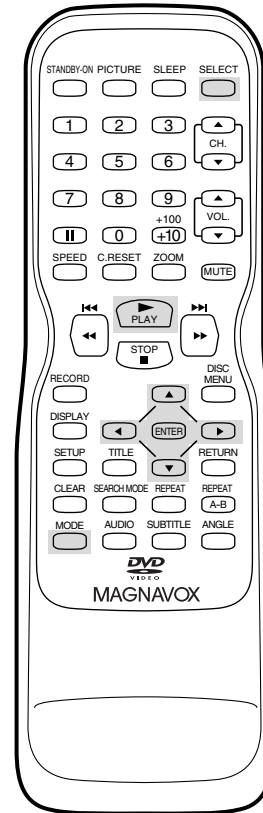

Helpful Hints

- You cannot use the Number buttons or **SEARCH MODE** to select another track while playing a program. Press **◀◀◀/▶▶▶** or **◀▶▶/▶▶▶** to select other tracks in the program.
- You cannot combine random playback with programmed playback.
- You may play a program or a track within a program repeatedly. During programmed playback, press **REPEAT** so **ALL** (all tracks in the program) or **TRACK** appears. The entire program or the current track will play over and over.
- You cannot alter a program during playback.
- You can start program playback only while in the **PROGRAM** screen.
- A program can have a maximum of 99 tracks.
- To erase all tracks in the program, select **ALL CLEAR** at step 2.
- Program/Random playback of MP3 or JPEG tracks is not available while Dual Playback is ON.

66 MP3/JPEG Playback

The DVD player will play MP3 and JPEG files that you record and finalize on a CD-RW (Compact Disc-Rewritable) or CD-R (Compact Disc-Recordable).

These discs may contain pictures in a JPEG format or audio tracks in an MP3 format. For example, you may have photographic film developed by a retailer that places the pictures on a CD-R for you. These pictures may be in JPEG format.

Or, you may copy or download MP3 music files from certain legal Internet sites, then copy those files onto a CD-R or CD-RW.

You cannot make or record such discs using the TV/VCR/DVD. See your computer manual for details on recording.

Keep these characteristics in mind when making discs you intend to play on the DVD player of the TV/VCR/DVD.

- Record MP3 tracks at a sampling frequency of 44.1 kHz or 48 kHz. Record in a constant bit rate between 32 kbps and 320 kbps.
- When recording JPEG files, the size of the picture should be between 32 x 32 and 6300 x 5100 dots.
- **Before you begin, press SELECT** to put the TV/VCR/DVD in DVD mode. The green DVD light will appear on the front of the TV/VCR/DVD.

1 When you put a CD-RW or CD-R with MP3 or JPEG files in the TV/VCR/DVD, a file list will appear on the TV screen when you press DISC MENU (If you use PLAY ► to close the disc tray, playback may start automatically). Press ▲ or ▼ to select a folder, MP3 track or JPEG file.

2 If you choose a track or file, press PLAY ► or ENTER. Starting with the track or file you selected, the tracks/files will play in the order they were recorded, i.e. 1, 2, 3.

If you select a folder and press ENTER, the tracks or files within that folder will appear. Press ▲ or ▼ to select the track or file you want, then press PLAY ► or ENTER.

- Press TITLE to return to the first item in the highest level of folders or files.
- Press ◀ or ▶ to return to previous or next levels.
- To change the TRANSITION MODE of JPEG playback, press MODE during playback. Then press ◀, ▶ or ENTER to switch CUT IN/OUT and FADE IN/OUT. If you choose CUT IN/OUT, the images will cut in and out sharply as playback progresses. If you choose FADE IN/OUT, the images will fade in and out as playback progresses.
- To change the size of the playback image, press MODE repeatedly until SIZE CHANGE MODE appears on top of the TV screen during playback. Then press ◀, ▶ or ENTER to switch between NORMAL(100%) and SMALL(95%).
- Press MODE repeatedly to remove the display.
- During JPEG playback, press ◀ or ▶ to rotate a picture 90 degrees clockwise or counter-clockwise.

3 To stop play, press STOP ■.

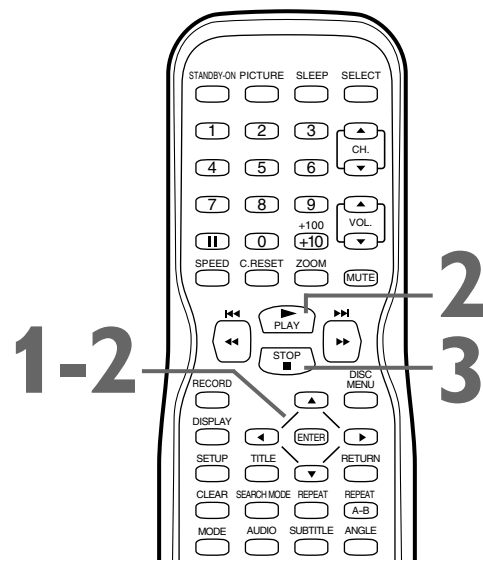

Helpful Hints

- JPEG images and MP3 tracks are known as files. Groups of files are called folders.
- Folders have the □ icon.
- MP3 tracks have the 🎵 icon.
- JPEG files have the 🖼️ icon.
- A maximum of 255 folders can be recognized. A maximum of 999 files can be recognized.
- During playback, press the Number buttons to select another track. Or, press ◀◀◀/▶▶▶ or ▶▶▶/◀◀◀ to change tracks. If a track is not available, "X" may appear on the TV screen, and playback may resume at an incorrect track or may continue with its current track.
- Specific Time playback is not possible with MP3 tracks.
- Progressive JPEGs (JPEG files saved in the progressive format) will not play on this DVD player.
- High resolution JPEG files takes longer to be displayed.
- SIZE CHANGE MODE may have no effect on some files (e.g. files with a small picture size).

MP3/JPEG Playback (cont'd) 67

Dual Playback

This feature lets you play MP3 and JPEG files simultaneously. Available only when DUAL PLAYBACK is ON. See pages 77-78 on how to set the DUAL PLAYBACK ON or OFF.

- 1** Press **SELECT** to put the DVD/VCR in DVD mode.
DVD light will appear on the front of the DVD/VCR.
- 2** Press **DISC MENU** during MP3/JPEG playback.
A file list will appear.
- 3** Press **▲** or **▼** to select a desired JPEG file/an MP3 track from the List and press **PLAY ►** or **ENTER**.
- 4** To stop playback, press **STOP ■**.

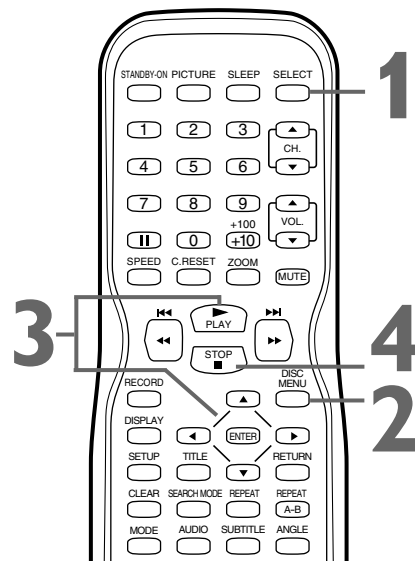

Folder Playback

You may select to play a folder. Available only when DUAL PLAYBACK is ON. See pages 77-78 on how to set the DUAL PLAYBACK ON or OFF.

- 1** Press **SELECT** to put the DVD/VCR in DVD mode.
DVD light will appear on the front of the DVD/VCR.
- 2** While playback is stopped, press **MODE**.
A folder list will appear.
- 3** Press **▲** or **▼** to select a folder, then press **PLAY ►** or **ENTER**.
 - MP3 tracks and JPEG files in the selected folder will play simultaneously.

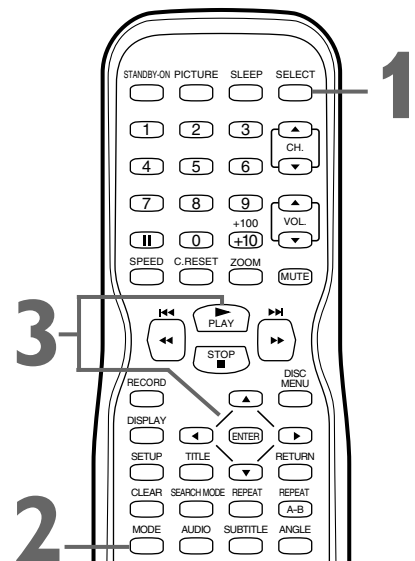
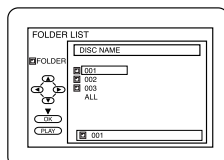

Helpful Hints

- If you press **PLAY ►** directly after you inserted a disc which contains both MP3 tracks and JPEG files and if the **DUAL PLAYBACK** setting is ON, Dual Playback will start automatically.
- Zooming or rotating a JPEG file during Dual Playback may cause an intermittent sound.
- Dual Playback may not function properly if MP3 and JPEG files on the disc interfere each other due to the difference in their data size.

68 Language Settings

You can use the LANGUAGE settings to select different languages for the Audio or Subtitles of DVDs, as well as languages for DVD disc menus.

- Before you begin, press **SELECT** to put the TV/VCR/DVD in DVD mode. The green DVD light will appear on the front of the TV/VCR/DVD.

1 Press **SETUP** once so the TV/VCR SETUP menu appears.

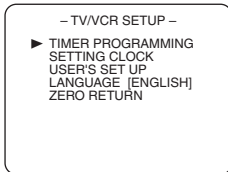

2 While playback is stopped, press **SETUP** again. The QUICK SETUP screen appears.

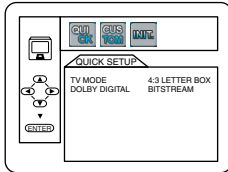

3 Press **◀** or **▶** to select **CUSTOM** at the top of the menu, then press **ENTER**.

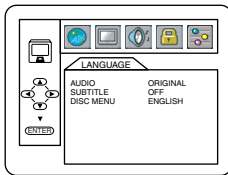

4 (LANGUAGE) will be selected. Press **ENTER**.

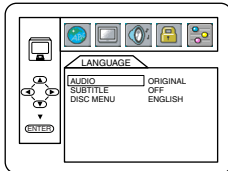

5 Press **▲** or **▼** to select **AUDIO**, **SUBTITLE** or **DISC MENU**. Then, press **ENTER**. The language options for the selected item will appear.

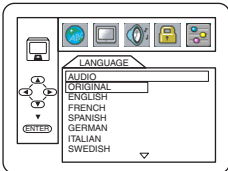

AUDIO:
The DVD's audio plays in the selected language.

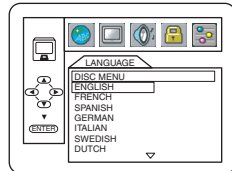

DISC MENU:
A DVD's disc menu appears in the selected language.

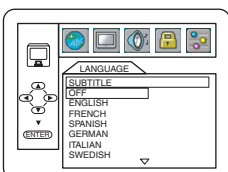

SUBTITLE:
Subtitles appear in the selected language.

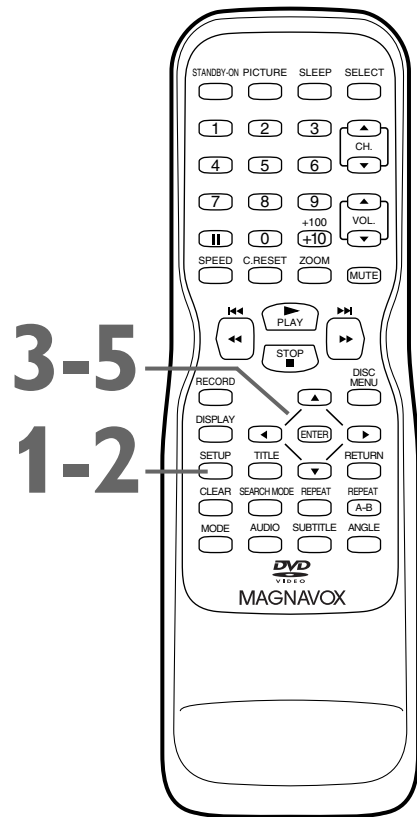

Helpful Hints

- If the DVD's default settings for Audio and Subtitle are the same language, the subtitles may not show unless you turn them on.
- Use AUDIO and SUBTITLE to select Audio and Subtitles available on the DVD. Details are on pages 59 and 61.
- If you set AUDIO to ORIGINAL, the default setting of the DVD Audio will play.

Language Settings (cont'd) 69

6 Press **▲** or **▼** to select a language, then press **ENTER**. The language lists may continue on multiple screens. Press **▲** or **▼** to move to the other screens.

- If you select **OTHER**, press four Number buttons to enter the code for the language you desire. Use the Language Codes below. The language or language code you select will appear in the Language menu beside **AUDIO**, **SUBTITLE** or **DISC MENU**.

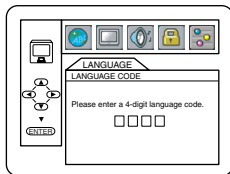

- You can select other languages for **AUDIO**, **SUBTITLE** and **DISC MENU** only if the language is available on the disc. If the language is not recorded on the DVD, changing these settings will have no effect.

7 Press **SETUP** to exit the menu.

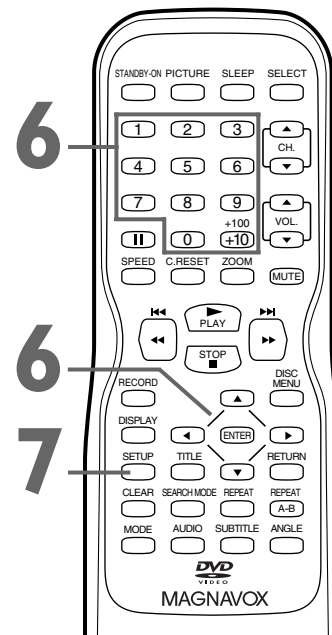

Language Codes

| | | | | | | | | | |
|--------------|---------|----------------|---------|--------------|---------|----------------|----------|------------|------|
| A-B | English | 5160 | Kannada | 5760 | Panjabi | 6247 | T | | |
| Abkhazian | 4748 | Esperanto | 5161 | Kashmiri | 5765 | Pashto | 6265 | Tagalog | 6658 |
| Afar | 4747 | Estonian | 5166 | Kazakh | 5757 | Persian | 5247 | Tajik | 6653 |
| Afrikaans | 4752 | F-H | | Kinyarwanda | 6469 | Polish | 6258 | Tamil | 6647 |
| Albanian | 6563 | Faroese | 5261 | Kirghiz | 5771 | Portuguese | 6266 | Tatar | 6666 |
| Amharic | 4759 | Fiji | 5256 | Kirundi | 6460 | Pushto | 6265 | Telugu | 6651 |
| Arabic | 4764 | Finnish | 5255 | Korean | 5761 | Quechua | 6367 | Thai | 6654 |
| Armenian | 5471 | French | 5264 | Kurdish | 5767 | Rhaeto-Romance | 6459 | Tibetan | 4861 |
| Assamese | 4765 | Frisian | 5271 | L-N | | Romanian | 6461 | Tigrinya | 6655 |
| Aymara | 4771 | Gaelic (Scots) | 5350 | Laothian | 5861 | Russian | 6467 | Tonga | 6661 |
| Azerbaijani | 4772 | Galician | 5358 | Latin | 5847 | | | Tsonga | 6665 |
| Bangla | 4860 | Georgian | 5747 | Latvian | 5868 | S | | Turkish | 6664 |
| Bashkir | 4847 | German | 5051 | Lettish | 5868 | Samoan | 6559 | Turkmen | 6657 |
| Basque | 5167 | Greek | 5158 | Lingala | 5860 | Sangho | 6553 | Twí | 6669 |
| Bengali | 4860 | Greenlandic | 5758 | Lithuanian | 5866 | Sanskrit | 6547 | U-Z | |
| Bhutani | 5072 | Guarani | 5360 | Macedonian | 5957 | Serbian | 6564 | Ukrainian | 6757 |
| Bihari | 4854 | Gujarati | 5367 | Malagasy | 5953 | Serbo-Croatian | 6554 | Urdu | 6764 |
| Bislama | 4855 | Hausa | 5447 | Malay | 5965 | Sesotho | 6566 | Uzbek | 6772 |
| Breton | 4864 | Hebrew | 5569 | Malayalam | 5958 | Setswana | 6660 | Vietnamese | 6855 |
| Bulgarian | 4853 | Hindi | 5455 | Maltese | 5966 | Shona | 6560 | Volapuk | 6861 |
| Burmese | 5971 | Hungarian | 5467 | Maori | 5955 | Sindhi | 6550 | Welsh | 4971 |
| Byelorussian | 4851 | I-K | | Marathi | 5964 | Singhalese | 6555 | Wolof | 6961 |
| C-E | | Icelandic | 5565 | Moldavian | 5961 | Siswat | 6565 | Xhosa | 7054 |
| Cambodian | 5759 | Indonesian | 5560 | Mongolian | 5960 | Slovak | 6557 | Yiddish | 5655 |
| Catalan | 4947 | Interlingua | 5547 | Nauru | 6047 | Slovenian | 6558 | Yoruba | 7161 |
| Chinese | 7254 | Interlingue | 5551 | Nepali | 6051 | Somali | 6561 | Zulu | 7267 |
| Corsican | 4961 | Inupiak | 5557 | Norwegian | 6061 | Spanish | 5165 | | |
| Croatian | 5464 | Irish | 5347 | O-R | | Sundanese | 6567 | | |
| Czech | 4965 | Italian | 5566 | Occitan | 6149 | Swahili | 6569 | | |
| Danish | 5047 | Japanese | 5647 | Oriya | 6164 | Swedish | 6568 | | |
| Dutch | 6058 | Javanese | 5669 | Oromo (Afan) | 6159 | | | | |

70 Display Settings

You can change the TV Aspect ratio and Still Mode clarity in the Display menu.

- **Before you begin, press SELECT** to put the TV/VCR/DVD in DVD mode. The green DVD light will appear on the front of the TV/VCR/DVD.

1 Press **SETUP** once so the **TV/VCR SETUP** menu appears.

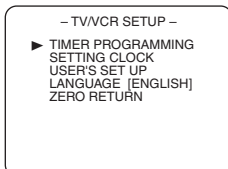

2 When playback is stopped, press **SETUP** again. The **QUICK SETUP** screen will appear.

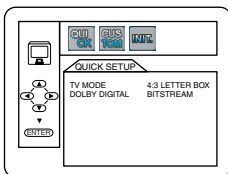

3 Press **◀** or **▶** to select **CUSTOM** at the top of the menu, then press **ENTER**.

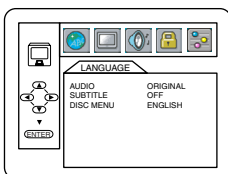

4 Press **◀** or **▶** to select **DISPLAY**, then press **ENTER**.

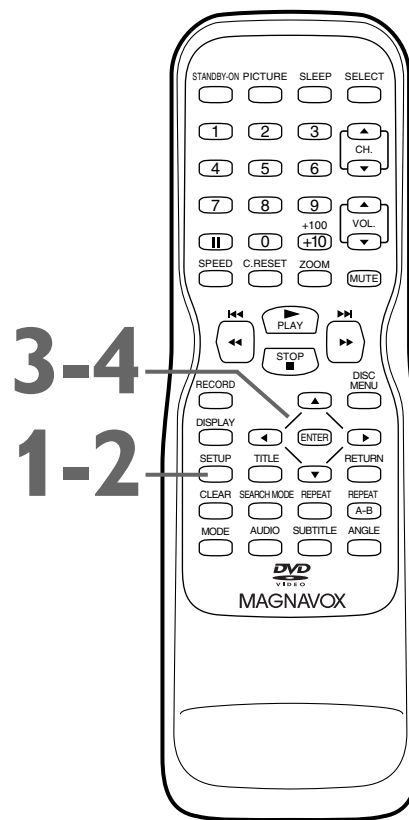
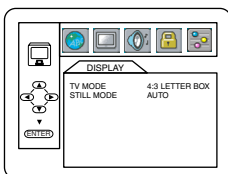

Helpful Hints

- Selecting a different TV MODE setting is only effective if it is available on the DVD. Check the DVD disc menu or case for details.
- You also can adjust TV MODE in the QUICK SETUP menu. With QUICK selected, press ENTER. TV MODE will be selected, so press ENTER. Press ▲ or ▼ to choose a setting, then press ENTER. Press SETUP to remove the menu.

Display Settings (cont'd) 71

5 Press ▲ or ▼ to select an item, then press ENTER.

- If you selected **TV MODE**, press ▲ or ▼ to select a setting, then press ENTER.

Choose 4:3 LETTER BOX if you want to see the entire, widened picture with black bars at the top and bottom of the screen. This looks like the picture you see when watching movies in a theater. This setting is possible only if the DVD was recorded in the letterbox or widescreen format. Choose 4:3 PAN & SCAN for a full height picture, with both sides trimmed. Some companies refer to this as reformatting the picture to fit your TV screen and may call it the regular or normal format.

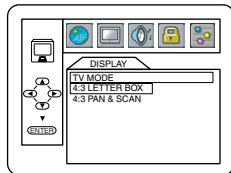

TV MODE

- If you selected **STILL MODE**, press ▲ or ▼ to select a setting, then press ENTER.

This function allows you to adjust the quality of a still image. AUTO is the default setting. If you select FIELD, still images will be stabilized but coarse due to the limited amount of data. If you select FRAME, the picture quality will be improved due to the simultaneous output of two field data but the image can be unstabilized.

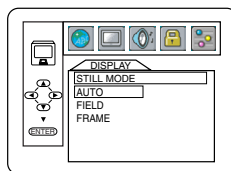

STILL MODE

6 Press SETUP to exit the menus.

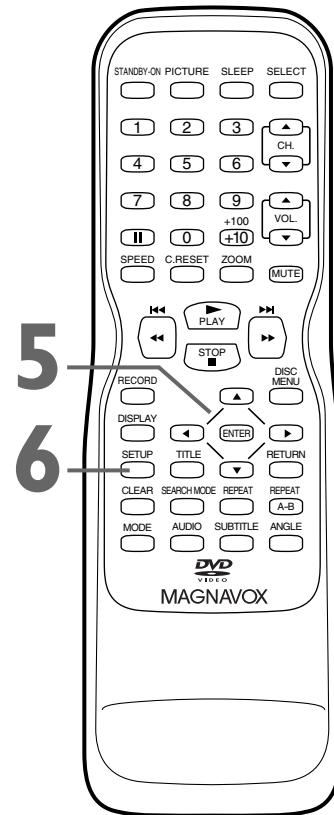

72 Audio Settings

Change Audio settings based on other equipment you connected to the TV/VCR/DVD or according to your disc sound features. These settings only affect the Audio from the DVD player of the TV/VCR/DVD.

- **Before you begin, press SELECT** to put the TV/VCR/DVD in DVD mode. The green DVD light will appear on the front of the TV/VCR/DVD.

- 1 Press SETUP once so the TV/VCR SETUP menu appears.**

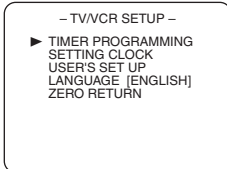

- 2 While playback is stopped, press SETUP again. The QUICK SETUP screen will appear.**

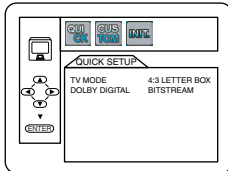

- 3 Press ◀ or ▶ to select CUSTOM at the top of the menu, then press ENTER.**

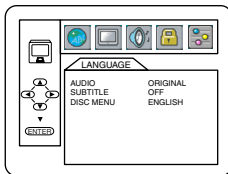

- 4 Press ◀ or ▶ to select AUDIO, then press ENTER.**

- 5 Press ▲ or ▼ to select DRC, DOWN SAMPLING, or DOLBY DIGITAL, then follow step 5 accordingly.**

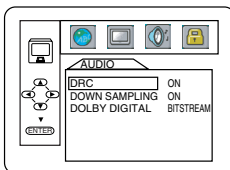

DRC

- 6**
 - If you selected DRC, press **ENTER** repeatedly to turn Dynamic Range Control (DRC) ON or OFF. Choosing ON compresses the range of volume by suppressing loud sounds and raising low sounds. DRC is available only on discs recorded in the Dolby Digital format.
 - If you selected DOWN SAMPLING, press **ENTER** repeatedly to choose ON or OFF. ON sets downsampling to 48 kHz. OFF sets downsampling to 96 kHz. DOWN SAMPLING is available only when the unit is connected to a Stereo using the AUDIO OUT COAXIAL jack.
 - If you selected DOLBY DIGITAL, press **ENTER** repeatedly to select BITSTREAM or PCM. Select BITSTREAM if you used the AUDIO OUT COAXIAL jack to connect the TV/VCR/DVD to a stereo that is Dolby Digital compatible. Details are on page 11. Otherwise, choose PCM.

- 7 Press SETUP to exit the menu.**

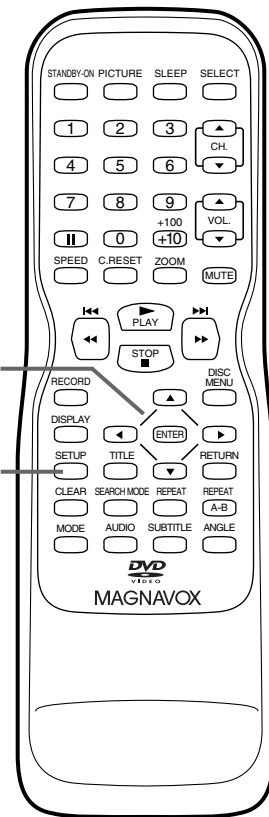

Helpful Hints

- Dolby Digital sound must be available on the DVD.
- You can adjust DOLBY DIGITAL in the QUICK SETUP menu. With QUICK SETUP selected, press ENTER. Press ▼ to select DOLBY DIGITAL. Press ENTER to choose BITSTREAM or PCM. Press SETUP to remove the menu.
- When you play a disc that has copyright protection, downsampling will be at 48 kHz, even if DOWN SAMPLING is OFF.

Parental Password 73

The Parental feature prevents viewing of DVDs that exceed your rating limits. This feature will not limit viewing if the DVD is not rated or coded. Check your DVDs and settings before letting children access the TV/VCR/DVD. Follow these steps to change your password.

- **Before you begin, press SELECT** to put the TV/VCR/DVD in DVD mode. The green DVD light will appear on the front of the TV/VCR/DVD.

- 1 Press SETUP once so the TV/VCR SETUP menu appears.**

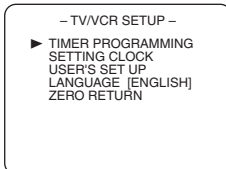

- 2 Press SETUP again while playback is stopped.**

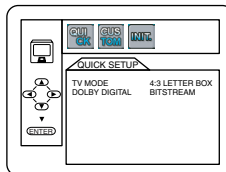

- 3 Press ◀ or ▶ to select CUSTOM at the top of the menu, then press ENTER.**

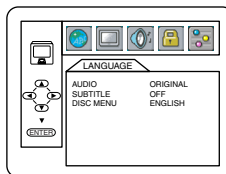

- 4 Press ◀ or ▶ to select (PARENTAL), then press ENTER.**
The first time you set a password, this menu will appear:

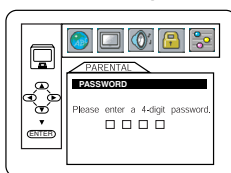

Press the Number buttons to enter a 4-digit password. The password will appear on the screen. Write it down so you don't forget it.

Press ENTER, and proceed to step 6 on the next page.

If you have set a password before, this menu will appear:

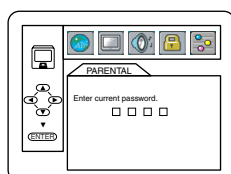

Press the Number buttons to enter your current 4-digit password. Asterisks (*) will appear instead of your password. This protects its identity.

Instructions continue on the next page.

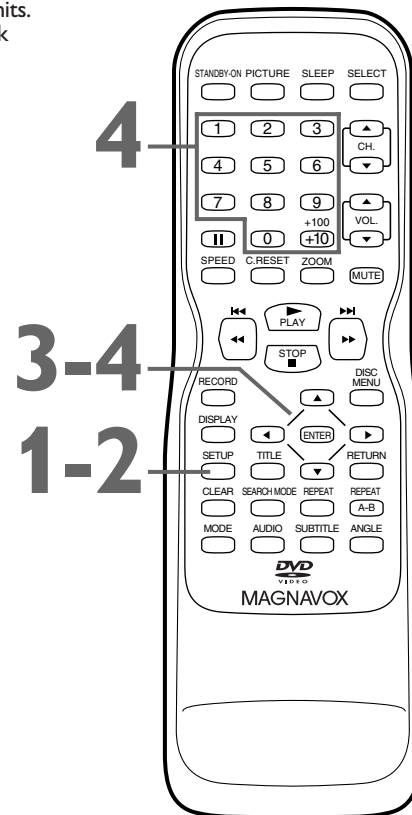

74 Parental Password (cont'd)

Instructions continued from the previous page.

- 5** Press **▼** to select **PASSWORD CHANGE**, then press **ENTER**.

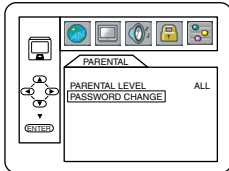

- 6** Press the **Number** buttons to enter a **4-digit password**. The password numbers will appear on the screen. Write down the password so you will not forget it. Press **ENTER**. The previous menu will reappear.

- 7** Press **SETUP** to exit the menu.

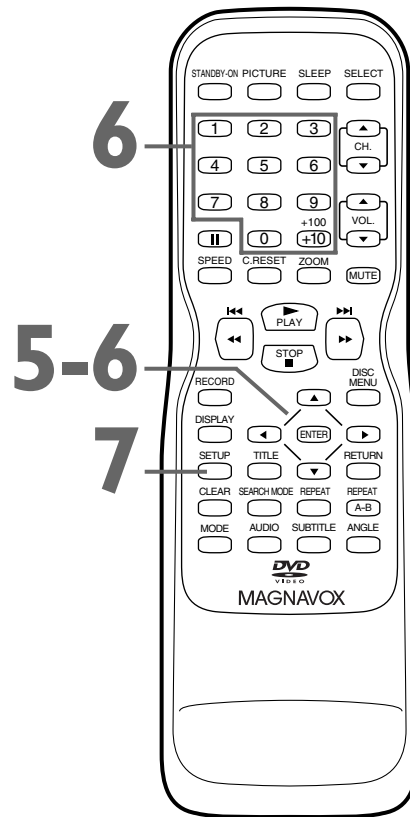

Helpful Hints

- The default password is 4737. If you forget your password, press Number buttons 4, 7, 3, 7 at step 3. You will be prompted to enter a new 4-digit password. Use the Number buttons to enter a new 4-digit password, then press ENTER. PARENTAL LEVEL will reset to ALL. Press SETUP to remove the menu. See pages 75-76 to reset PARENTAL LEVEL as you desire.
- A power failure will not erase your password.

Parental Levels 75

Follow these steps to set the rating level for your DVDs. DVDs whose ratings exceed the level you set will not play.

● **Before you begin, press SELECT** to put the TV/VCR/DVD in DVD mode. The green DVD light will appear on the front of the TV/VCR/DVD.

1 Press **SETUP** once so the **TV/VCR SETUP** menu appears.

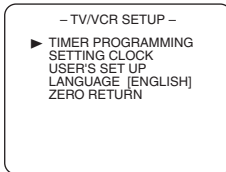

2 Press **SETUP** again while playback is stopped.

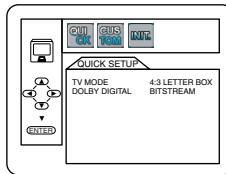

3 Press **◀** or **▶** to select **CUSTOM** at the top of the menu, then press **ENTER**.

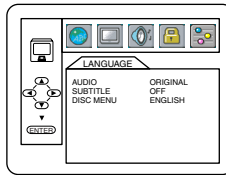

4 Press **◀** or **▶** to select **PARENTAL**, then press **ENTER**.

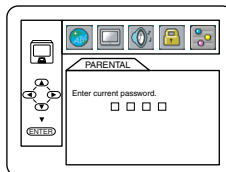

5 Press the **Number** buttons to enter your **4-digit password**. Asterisks (*) will appear instead of your password. This protects its identity.

6 Press **▲** or **▼** to select **PARENTAL LEVEL**, then press **ENTER**.

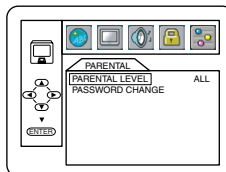

Instructions continue on the next page.

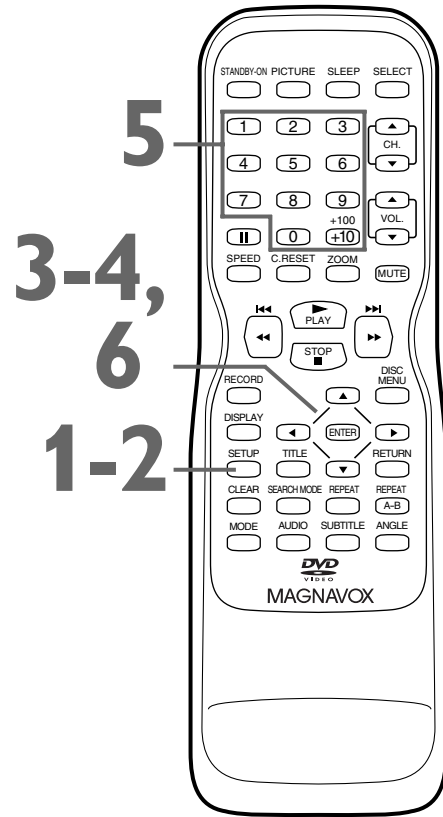

RATING EXPLANATIONS

- ALL - The Parental feature is inactive; all discs can play.
- 8 - Adult material
- 7 - NC-17 - Not appropriate for children under 17
- 6 - R - Restricted; parental approval required for viewers under 18.
- 4 - PG13 - Unsuitable for children under 13
- 3 - PG - Parental Guidance suggested.
- 1 - G - General Audience; recommended for all ages.

76 Parental Levels (cont'd)

Instructions continued from the previous page.

- 7** Press **▲** or **▼** to select a level, then press **ENTER**. The rating levels continue on two menu screens. Press **▲** or **▼** repeatedly to move to the next or previous screen to find the rating level you want. After making your selection, the previous menu will appear. The level you selected will appear beside **PARENTAL LEVEL**.

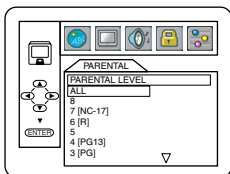

- 8** Press **SETUP** to exit the menu.

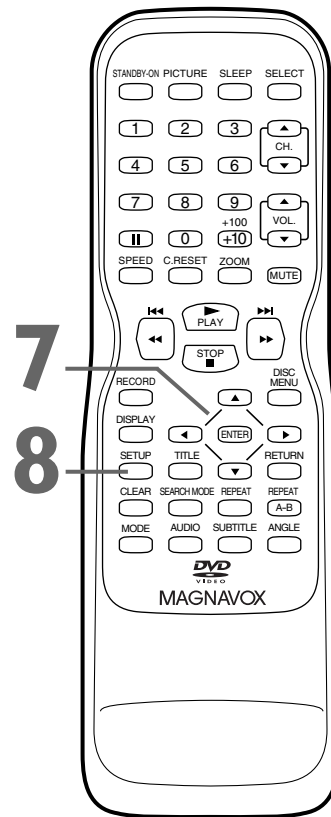

Helpful Hints

- When you try to play a DVD whose rating exceeds the level you set, an on-screen message will indicate the DVD cannot play. Remove the DVD, then set **PARENTAL LEVEL** to **ALL**. Reload the DVD and begin playback. Some DVDs may let you enter your 4-digit password to begin playback. Follow the on-screen messages as prompted.
- You cannot use the default password (4737) to play a DVD.

Others 77

You may adjust the Angle Icon, Automatic Power Off, Dual Playback and Slide Show settings.

- **Before you begin, press SELECT** to put the TV/VCR/DVD in DVD mode. The green DVD light will appear on the front of the TV/VCR/DVD.

1 Press **SETUP** once so the **TV/VCR SETUP** menu appears.

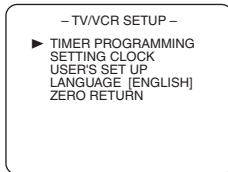

2 When playback is stopped, press **SETUP** again. The **QUICK SETUP** screen will appear.

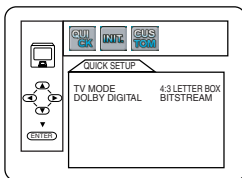

3 Press **◀** or **▶** to select **CUSTOM** at the top of the menu, then press **ENTER**.

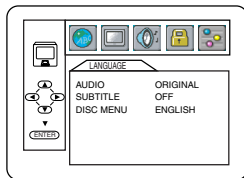

4 Press **◀** or **▶** to select **OTHERS** (OTHERS), then press **ENTER**.

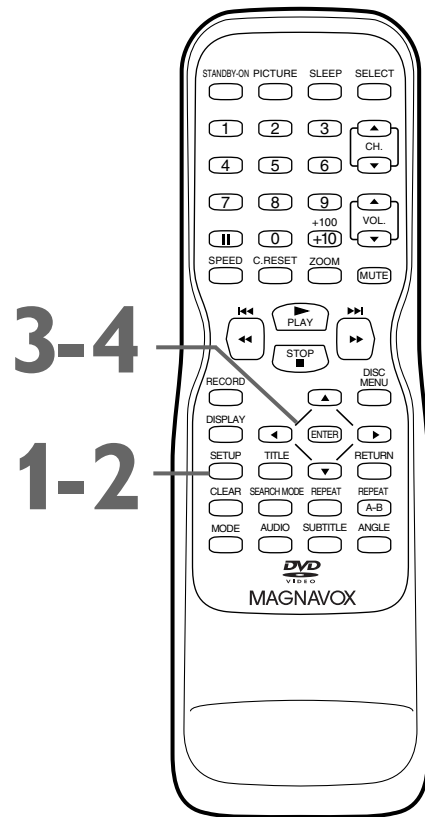
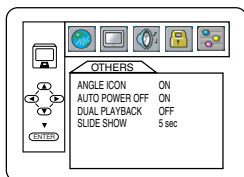

Instructions continue on the next page.

78 Others (cont'd)

Instructions continued from the previous page.

5 Press ▲ or ▼ to select an item, then press ENTER.

- If you selected **ANGLE ICON**, press ENTER repeatedly to select ON or OFF. The default setting is ON. Choose ON to see the Angle icon when multiple camera angles are available during DVD playback. Details are on page 59. Choose OFF to disable the Angle icon.

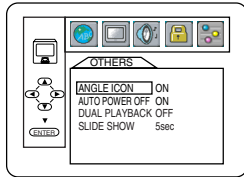

ANGLE ICON

- If you selected **AUTO POWER OFF**, press ENTER repeatedly to choose ON or OFF. The default setting is ON. Choose ON if you want the player to turn off when there is no activity at the player or its remote for 20 minutes.

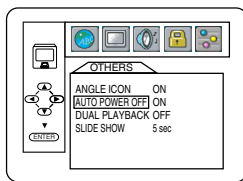

AUTO POWER OFF

- If you selected **DUAL PLAYBACK**, press ENTER to choose ON or OFF. This feature lets you play MP3 and JPEG files simultaneously.

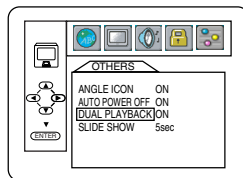

DUAL PLAYBACK

- If you selected **SLIDE SHOW**, press ▲ or ▼ to choose 5sec or 10sec, then press ENTER. This adjusts the playback speed of the SLIDE SHOW. The default setting is 5 sec. Choose 5 sec to display each image for 5 seconds. Choose 10 sec to display each image for 10 seconds.

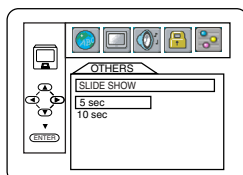

SLIDE SHOW

6 Press SETUP to remove the menus.

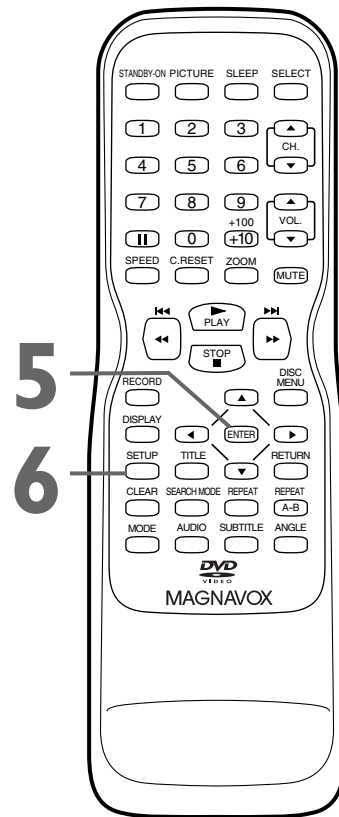

Glossary 79

AUDIO In Jacks: red and white jacks on the front of the TV/VCR/DVD which are used to receive or record audio from another source (VCR, Camcorder, etc.).

Automatic Channel Setup: process in which the TV/VCR/DVD memorizes all available TV channels. Then, when you push CH. ▲/▼, you only scan through channels you receive.

Auxiliary (AUX): The channel to which you set your TV/VCR/DVD during dubbing or when viewing material that is playing on another device that is connected to the TV/VCR/DVD (for example, a Camcorder or VCR or TV channels from a Cable Box/Satellite Receiver). Press SELECT to choose AUX at the TV/VCR/DVD.

Bands: settings that allow you to tune channels.

- **Antenna** – VHF (very high frequency; channels 2-13) and UHF (ultra high frequency; channels 14-69).
- **Cable** – standard channels can be received without a Cable Box.

Brightness: adjusting increases or decreases the brightness of the color on the screen.

COAXIAL Digital Audio Out jack: Sends digital audio to a stereo, allowing you to adjust the volume at the stereo.

Color: adjusting pales or brightens the TV/VCR/DVD picture color.

Dolby Digital: A surround sound system that provides 5.1 channel sound as used in movie theaters. Sound is heard through multiple channels, not just the right and left as with standard stereo.

Dubbing: copying a videotape from a separate VCR or camcorder.

HQ: high quality; a feature in the VCR circuitry which provides enhanced videotape picture detail through the TV/VCR/DVD.

OTR: One-Touch Recording; a timed recording that starts immediately and records for 30 minutes to 8 hours, whichever you specify.

Sharpness: adjusting softens or clarifies the picture on the screen.

Tape Speeds: how fast the videotape travels during playback or recording. The faster the tape speed, the better the recording quality will be. Faster speeds (SP) also use more space on the tape. So, you can put more recording on a tape if you use a slower tape speed (SLP).

- **SP** (standard playback) – fastest tape speed (recording time for a T120 tape is approximately 2 hours); best picture quality.
- **LP** (long playback) – average tape speed; only playback in this speed is available on this TV/VCR/DVD.
- **SLP** (super long playback) – slowest tape speed (recording time for a T120 tape is approximately 6 hours).

Tint: adjusting changes the tints of the picture from purple to green.

VIDEO IN Jack: yellow jack on the front of the TV/VCR/DVD which is used to receive or record video from another source (VCR, Camcorder, etc.).

80 Helpful Hints

If you are having problems with your product, check this list of problems and possible solutions before requesting service. You may be able to solve the problem yourself.

Location

For safe operation and satisfactory performance of your TV/VCR/DVD, remember the following:

- Shield it from direct sunlight and keep it away from sources of intense heat.
- Avoid dusty or humid places.
- Avoid places with insufficient ventilation. Do not block the ventilation openings at the top and bottom of the TV/VCR/DVD. Do not place the TV/VCR/DVD on a carpet, as this will block the ventilation openings.
- Avoid locations subject to strong vibrations.
- Do not place the TV/VCR/DVD near strong magnetic fields.
- Do not move the TV/VCR/DVD from a cold place to a hot place, or vice versa.

Electrical Shock and Fire Hazards

- Do not handle the power cord with wet hands.
- Do not pull the power cord when disconnecting the TV/VCR/DVD from the AC (alternating current) wall outlet. Grasp it by the plug.
- If you spill water on the TV/VCR/DVD, unplug the power cord immediately and take the TV/VCR/DVD to an authorized service center.
- Do not put your fingers or objects into the cassette compartment or disc tray.
- Do not place anything on top of the TV/VCR/DVD.

Dew Warning (Moisture Condensation)

- Moisture may condense inside the unit when you move it from a cold place to a warm place, after heating a cold room, or when the humidity is high. There is no warning that moisture is in your TV/VCR/DVD. Playing a tape when moisture has accumulated could damage the tape and the TV/VCR/DVD. If you suspect moisture inside the TV/VCR/DVD, keep the power on (but do not play a tape) for at least 2 hours. This will allow the TV/VCR/DVD to dry.

TV/VCR/DVD will not perform a timer recording.

- Set the recording start and stop times correctly. *Details are on pages 29-32.*
Midnight is 12 a.m. Noon is 12 p.m.
- Make sure the TV/VCR/DVD power is off for the timer recording.
- Set the clock. *Details are on pages 21-24.*
- Put a videotape in the cassette compartment of the TV/VCR/DVD. The tape must have a record tab. *Details are on page 8.*
- If the power fails, timer recordings will be restored when you reset the clock. Timer recordings do not occur if set to take place during the power failure.

TV/VCR/DVD will not record on a videotape.

- Make sure the videotape has a record tab. *Details are on page 8.*
- Plug the power cord into an active AC outlet. *Details are on page 10.*
- Check your hookups. *Details are on pages 9-10.*
- Set up the TV channels. *Details are on page 19.*
- You cannot record DVDs onto a videotape using the TV/VCR/DVD.

Channel reception is poor.

- Check connections, then set up the channels again. *Details are on page 19.*

TV/VCR/DVD has no power.

- Connect the power plug to an AC (alternating current) outlet completely.

TV/VCR/DVD ejects the tape when you try to start a recording.

- Make sure the tape has a record tab. *Details are on page 8.*

Helpful Hints (cont'd) 81

Disc cannot play.

- Insert a playable disc. Make sure the disc is labelled for Region 1 or ALL regions and is NTSC compatible. *Details are on page 7.*
- Place the disc correctly in the disc tray. If the disc is one-sided, place the disc in the tray with the label facing up. If the disc is two-sided, make sure the label of the side you want to play is facing up.
- Clean the disc. Make sure the disc is not scratched or warped.
- Cancel the Parental Controls, enter the password, or change the Parental level. *Details are on pages 75-76.*

TV/VCR/DVD does not have a picture.

- Adjust the antenna or check the Cable TV or satellite signal connection. If using a Cable Box/Satellite Receiver, set the TV/VCR/DVD to channel 3, 4 or AUX. *Details are on pages 9-10.*
- Adjust the picture controls. *Details are on page 26.*
- Select an active TV channel. *Details are on pages 19-20.*
- Make sure the disc is compatible with the DVD player of the TV/VCR/DVD. *Details are on page 7.*

TV/VCR/DVD has poor sound or no sound.

- Press VOL. ▲/▼ to adjust the volume. Press MUTE to restore the volume.
- Check the audio settings for DVD mode. *Details are on page 72.*
- Check the audio settings of the disc. For example, you may have selected "soundtrack" playback or an unavailable sound setting (such as Dolby Digital) or language. *Details are on pages 61, 68-69 and 72.* Try other sound options provided in the DVD disc menu.

You cannot choose a DVD feature, such as camera angle or audio or subtitle language.

- The feature must be recorded on the DVD. Not all DVDs contain multiple angles, subtitles, etc. Refer to the disc case to see what features are available. If the feature is not available, the "X" may appear in the top right corner of the screen.

Videotape playback is poor or the tape is destroyed.

- Adjust the tracking. *Details are on page 41.*
- Use the Rental feature. *Details are on page 36.*
- If moisture has accumulated in the unit, keep the power on for at least 2 hours, but do not play a tape.

TV/VCR/DVD does not display closed captions for TV programs.

- Make sure closed captioning is available for the program. Refer to the TV listings in your local newspaper.

Remote control does not operate the TV/VCR/DVD.

- Aim the remote control directly at the remote sensor on the front of the TV/VCR/DVD. *Details are on page 17.*
- Remove all obstacles between the remote control and the TV/VCR/DVD.
- Inspect and replace the batteries in the remote control. *Details are on page 8.*

Number buttons will not select channels above 69.

- Enter channel numbers as a 2-digit number. If you want to select channels 100 and above, press the +100/+10 button, then the Number buttons for the last 2 digits. *Details are on page 15.*
- If you are using an antenna and do not have Cable TV/Satellite, only channels 2-69 will be available.

You cannot insert a tape into the cassette compartment of the TV/VCR/DVD.

- Insert the tape with the window facing up and the record tab facing you and on the left.
- Make sure a tape isn't already inside by pressing STOP/EJECT ■/▲ on the front of the TV/VCR/DVD.
- Gently push on the center of the tape. Never force a tape into the TV/VCR/DVD.
- If you have set a timer recording and the power is off, the unit will eject the tape if the record tab is missing.

You cannot remove the tape from the TV/VCR/DVD.

- Make sure the power plug is completely connected to an AC (alternating current) outlet.
- If a timer recording is programmed, turn on the TV/VCR/DVD power, then eject the tape. Be sure to insert a tape and turn off the TV/VCR/DVD power for the timer recording.
- Unplug the TV/VCR/DVD power cord for 5 minutes. Then, plug in the power cord again, then press STANDBY-ON on the TV/VCR/DVD. If the tape does not eject, press STOP/EJECT ■/▲ on the TV/VCR/DVD three to five times. If the tape still does not eject, an authorized servicer may need to remove the tape.

82 Specifications

General TV/VCR

27MDTR20

CRT: 27 inch in-line gun
110° deflection tube

20MC4304

CRT: 20 inch in-line gun
90° deflection tube

19MDTR20

CRT: 19 inch in-line gun
90° deflection tube

Closed Caption system: 15.119/FCC

Video Heads: Rotary four-head

Tape width: 1/2 inch

Tape speeds

SP 33.40 mm/sec.

LP 16.67 mm/sec.

SLP 11.12 mm/sec.

Tuner channels: 2-69

Cable TV: 1-125

General DVD

Color System: NTSC

Electrical Specifications

Sound output: Two speakers, 1W, 8 ohm

Other Specifications

Terminals

Antenna In: VHF/UHF/Cable TV
75 ohm unbalanced (F-type)

Video In: One RCA connector

Audio L/R In: Two RCA connectors

Headphone: 1/8" stereo (3.5 mm)

Coaxial Digital

Audio Out: One pin jack,
500m Vpp (75 ohm)

Operating temperature: 41°F-104°F (5°C-40°C)

Power requirements: AC 120V, 60Hz

27MDTR20:

Power consumption (Maximum):

120W

Dimensions: Height: 25.5" (648 mm)

Width: 26.6" (675 mm)

Depth: 19.7" (500 mm)

Weight: 86 lbs. (39 kg)

20MC4304:

Power consumption (Maximum):

90W

Dimensions: Height: 20.2" (513 mm)

Width: 22.1" (562 mm)

Depth: 20.2" (513 mm)

Weight: 50.7 lbs. (23 kg)

19MDTR20:

Power consumption (Maximum):

90W

Dimensions: Height: 19.7" (500 mm)

Width: 23.8" (605 mm)

Depth: 18.7" (474 mm)

Weight: 48.5 lbs. (22 kg)

Accessories:

Remote Control with two
AA batteries
Owner's Manual
Quick-Use Guide

Designs and specifications are subject to change without notice and without our legal obligation.

Limited Warranty 83

MAGNAVOX LIMITED WARRANTY

Ninety (90) Days Labor & One (1) Year Parts & One (1) Year Display

MAGNAVOX warrants this product against defect in material or workmanship, subject to any conditions set forth as follows:

PROOF OF PURCHASE:

You must have proof of the date of purchase to receive warranted repair on the product. A sales receipt or other document showing the product and the date that you purchased the product as well as the authorized retailer included, is considered such proof.

COVERAGE:

(If this product is determined to be defective)

LABOR: For a period of ninety (90) days from the date of purchase, Magnavox will repair or replace the product, at its option, at no charge, or pay the labor charges to any Magnavox authorized service center. After the period of ninety (90) days, Magnavox will no longer be responsible for charges incurred.

PARTS: For a period of one (1) year, Magnavox will supply, at no charge, new or rebuilt replacement parts in exchange for defective parts. Magnavox authorized service centers will provide removal and installation of the parts under the specified labor warranty.

DISPLAY: For a period of one (1) year from the date of purchase, Magnavox will supply, at no charge, a new or rebuilt active display device in exchange for the defective display. Magnavox authorized service centers will provide removal and installation of the parts under the specified labor warranty. (PTV screens carry a thirty (30) day replacement warranty.)

EXCLUDED FROM WARRANTY COVERAGE

Your warranty does not cover:

- Labor charges for installation or setup of the product, adjustment of customer controls on the product, and installation or repair of antenna systems outside of the product.
- Product repair and/or part replacement because of improper installation, connections to improper voltage supply, abuse, neglect, misuse, accident, unauthorized repair or other cause not within the control of Magnavox.
- A product that requires modification or adaptation to enable it to operate in any country other than the country for which it was designed, manufactured, approved and/or authorized, or repair of products damaged by these modifications.
- Damage occurring to product during shipping when improperly packaged or cost of associated packaging.
- Product lost in shipment and no signature verification of receipt can be provided.
- A product used for commercial or institutional purposes (including but not limited to rental purposes).
- Products sold AS IS or RENEWED.

TO OBTAIN WARRANTY SERVICE IN THE U.S.A., PUERTO RICO, OR U.S. VIRGIN ISLANDS...

Contact Magnavox Customer Care Center at:
1-800-705-2000

TO OBTAIN WARRANTY SERVICE IN CANADA...

1-800-661-6162 (French Speaking)
1-800-705-2000 (English or Spanish Speaking)

REPAIR OR REPLACEMENT AS PROVIDED UNDER THIS WARRANTY IS THE EXCLUSIVE REMEDY FOR THE CONSUMER. MAGNAVOX SHALL NOT BE LIABLE FOR ANY INCIDENTAL OR CONSEQUENTIAL DAMAGES FOR BREACH OF ANY EXPRESS OR IMPLIED WARRANTY ON THIS PRODUCT. EXCEPT TO THE EXTENT PROHIBITED BY APPLICABLE LAW, ANY IMPLIED WARRANTY OF MERCHANTABILITY OR FITNESS FOR A PARTICULAR PURPOSE ON THIS PRODUCT IS LIMITED IN DURATION TO THE DURATION OF THIS WARRANTY.

Some states do not allow the exclusions or limitation of incidental or consequential damages, or allow limitations on how long an implied warranty lasts, so the above limitations or exclusions may not apply to you. In addition, if you enter into a service contract agreement with the MAGNAVOX partnership within ninety (90) days of the date of sale, the limitation on how long an implied warranty lasts does not apply.

This warranty gives you specific legal rights. You may have other rights which vary from state/province to state/province.

Magnavox, P.O. Box 671539, Marietta, GA. 30006-0026

(Warranty: 4835 710 28125)

84 Index

- a-b repeat 57
 angle button 16, 59
 ant(enna) jack 9-10, 18
 arrow buttons 15
 audio button 16, 61
 audio cd 7, 55
 audio in/out jacks 10, 17, 34
 audio out coaxial jack 11, 18
 audio settings (dvd) 72
 auto return 33
 automatic rewind, eject 41
 auxiliary mode (aux) .. 9-10, 12, 34
- batteries 8
 black level 64
 brightness 26
- c.reset button 16, 32, 37
 camera angle 59
 cassette compartment 17
 channel
 above 100 15
 adding/deleting 20
 setup 19
 ▲/▼ buttons 12, 16-17, 41
 chapters 54
 clear button 16
 clock setting 21-24
 closed captions 42
 color 26
 connections 9-11, 34
 contents, table of 5
 contrast 26
 controls
 remote 15-16
 tv/vcr/dvd 17
 copyright protection 3, 34
 counter 26, 37
- daylight-savings time 25
 disc menu button 16, 52
 disc tray 14, 17
 display button 15, 26, 62-63
 display settings 70-71
 duplication 34
 dvd light 17
 dvd video 7
- ejecting a tape 81
 enter button 16
- fast forward search 40, 53
 front panel 17
- glossary 79
- headphone jack 17
- helpful hints 80-81
 hookups 9-11, 34
- language (dvd) 61, 68-69
 language (setup menus) 19
 language settings 68-69
 lp (long playback) 27, 79
- menus 6, 19, 52
 mode button 16, 64-65
 mp3 display 63
 mp3 playback 66
 mp3 track selection 66
 mts system 49-51
 mute button 16
- number buttons 15
- on-screen status displays .. 26, 62-63
 one-touch recording 28
 open/close button ▲ 17
- parental controls 73-76
 password 73-74
 (pause) ■■ button 15, 40, 56, 60
 picture controls 26
 picture button 15, 26
 play ► button 13-15, 17
 playing discs 14
 playing videotapes 13
 power cord 10, 18
 programs 65
- random playback 65
 ratings
 mpaa 47
 tv 43-46
 real-time tape counter 37
 rear panel 18
 record button 15, 27
 recording
 basic 27
 one-touch 28
 timer 29-32
 rec/otr ● button 17
 rec/otr light 17
 remote control
 buttons 15-16
 using 8
 remote sensor 17
 repeat button 15, 57
 repeat a-b button 16, 57
 repeat playback 35, 57
 rerecording 34
 resuming playback 56
 return button 15
 reverse searching 40, 53
- rf coaxial cable 9
- safety precautions 3
 search mode button .. 16, 54-55, 58
 searching 40, 53
 second audio program 49, 51
 select button 15
 setup button 6, 16
 sharpness 26
 sleep button 15, 37
 sleep timer 37
 slow motion 40, 60
 slp (super long playback) ... 27, 79
 source button 17
 sp (standard playback) 27, 79
 specifications 82
 speed button 16, 27
 standby-on button 15, 17
 status display 26, 62-63
 stereo broadcast recording .. 49-51
 still picture 40, 56
 stop ■ button 15
 stop/eject ■/▲ button 13, 17
 subtitle button 16, 59
 super high speed searching ... 40
- table of contents 5
 tape duplication 34
 tape eject 17, 81
 tape speed 27, 79
 time search 38
 time setting 21-24
 timer recording
 cancelling 32
 checking 32
 setting 29-31
 tint 26
 title button 15, 52
 titles 52
 tracking 41
 tracks 55
- vcr/tv light 17
 v-chip setup 43-48
 video in/out jacks 10, 17, 34
 virtual surround 64
 volume ▲/▼ buttons 16-17
- warranty 83
- zero return 37
 zoom button 16, 60

Free Manuals Download Website

<http://myh66.com>

<http://usermanuals.us>

<http://www.somanuals.com>

<http://www.4manuals.cc>

<http://www.manual-lib.com>

<http://www.404manual.com>

<http://www.luxmanual.com>

<http://aubethermostatmanual.com>

Golf course search by state

<http://golfingnear.com>

Email search by domain

<http://emailbydomain.com>

Auto manuals search

<http://auto.somanuals.com>

TV manuals search

<http://tv.somanuals.com>