

# Panasonic®

## Operating Instructions

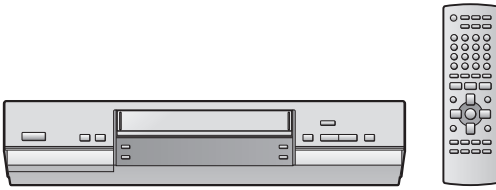

## Video Cassette Recorder

Model No.

### NV-MV41GN



Contents	Page
Warning and Important Information	2
Controls and Components	3
Connections	4
Tuning the TV to Your VCR	5
Storing TV Broadcasts in Your VCR	5
Setting the Clock of Your VCR	7
Settings Using the On Screen Display	7
Option Setting	8
Playback	9
Recording	10
Timer Recording	13
Search Functions	15
Before Requesting Service	17
Specifications	19



### ***SUPER DRIVE***

Before attempting to connect, operate or adjust this product, please read these instructions completely.

RQTV0012

## Warning and Important Information

As this equipment gets hot during use, operate it in a well ventilated place;  
Do not install this equipment in a confined space such as a book case or similar unit.

**WARNING:**

To reduce the risk of fire, electric shock or product damage, do not expose this equipment to rain, moisture, dripping or splashing and ensure that no objects filled with liquids, such as vases, shall be placed on the equipment.

**Important**

Your attention is drawn to the fact that the recording of pre-recorded tapes or discs or other published or broadcast material may infringe copyright laws.

**For your safety**

Do not remove outer cover.

Touching internal parts of the VCR is dangerous, and may seriously damage it.

To prevent electric shock, do not remove cover. There are no user serviceable parts inside. Refer all servicing to qualified service personnel.

**Inserting Remote Control Batteries**

Insert the batteries with the polarity (+ and -) correctly aligned.

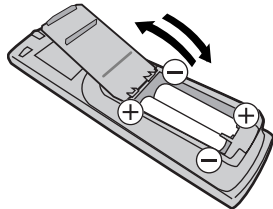

**Notes:**

The service life of the batteries is approximately 1 year. However, it varies considerably depending on the frequency of use.

- When they are exhausted, replace them with two AA, UM3, or R6 size batteries.
- When the batteries are exhausted, remove them immediately and dispose them correctly.
- Do not mix old battery with new battery.
- Do not mix different battery types, i.e. Alkaline and Manganese.
- Do not use rechargeable (Ni-Cd) batteries.
- Do not heat or short-circuit the batteries.
- When you do not use the remote control for a long time, take out the batteries and store them in a cool, dry place.

**Cautions before you operate this VCR**

Avoid:

- Humidity and dust.
- Extreme heat such as direct sunlight.
- Magnets or electromagnetic objects.
- Touching internal parts of the VCR.
- Water or some other liquid.
- Lightning. (Disconnect the aerial plug from the VCR during lightning storms.)
- Anything heavy on the VCR.
- Connecting or handling the equipment with wet hands.
- Using a cell phone near the VCR because doing so may cause noise to adversely affect the picture and sound.

Do:

- Wipe the VCR with a clean and dry cloth.
- Install the VCR in a horizontal position.
- Keep the VCR, TV and other equipment switched off until you have finished all connections.

**Condensation may form in the following cases:**

- The VCR is brought from cold surroundings into a well-heated room.
- The VCR is suddenly brought from cool surroundings, such as an air-conditioned room or car, to a place which is hot and humid.

**Note:**

- In any of the above-mentioned conditions, do not operate the VCR for at least 1 hour. This VCR is not equipped with a dew sensor.

Press [VCR-ON/OFF] **1** to switch the VCR from ON to standby mode or vice versa. In the standby mode, the VCR is still connected to the mains.

## Controls and Components

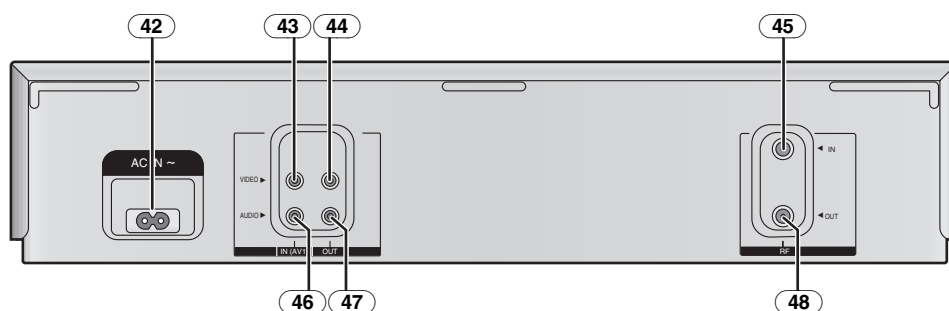
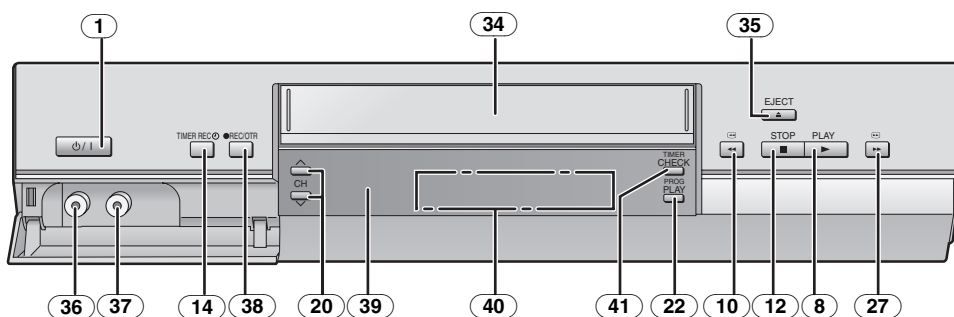
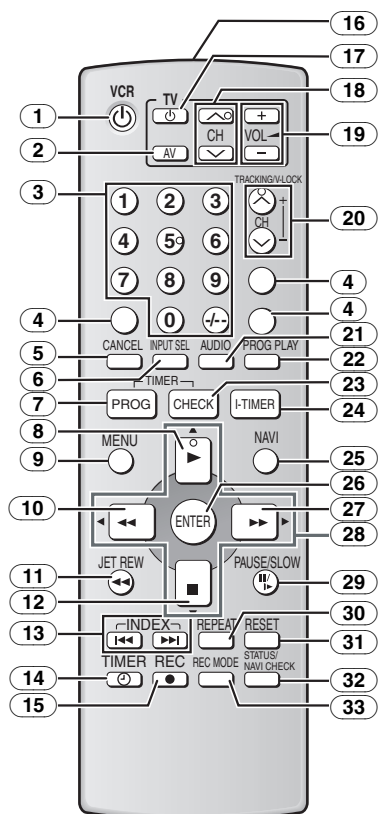

### VCR Operation

- ① [VCR-ON/OFF]
- ② [AV]
- ③ [Numeric]  
To select the programme positions (1-99).  
• Example:  
9: ⑨  
19: ① → ⑨  
To enter numbers for various settings.
- ④ No function
- ⑤ [CANCEL]
- ⑥ [INPUT SELECT]
- ⑦ [PROG]
- ⑧ [PLAY]
- ⑨ [MENU]
- ⑩ [Rewind]
- ⑪ [JET REW]
- ⑫ [STOP]
- ⑬ [INDEX]
- ⑭ [TIMER (REC)]
- ⑮ [REC]
- ⑯ Infra-red transmitter
- ⑰ [TV-ON/OFF]
- ⑱ [Channel]
- ⑲ [VOLUME]
- ⑳ [Channel]/[TRACKING/V-LOCK]
- ㉑ [AUDIO]  
This button does not operate on this VCR.
- ㉒ [PROG PLAY]
- ㉓ [CHECK]

- ㉔ [I-TIMER]
- ㉕ [NAVI]
- ㉖ [ENTER]
- ㉗ [Fast Forward]
- ㉘ [▼, ▲, ◀, ▶] (Cursor buttons)
- ㉙ [PAUSE/SLOW]
- ㉚ [REPEAT]
- ㉛ [RESET]  
To reset the tape counter (elapsed time) to [0:00.00].  
• The tape counter is automatically reset to [0:00.00] when a video cassette is inserted.
- ㉜ [STATUS/ NAVI CHECK]
- ㉝ [REC MODE]
- ㉞ Cassette compartment
- ㉟ [EJECT]
- ㊱ VIDEO IN socket (AV 2)
- ㊲ AUDIO IN sockets (AV 2)
- ㊳ [REC/OTR]
- ㊴ Infra-red Remote Control Receiver window
- ㊵ VCR display
- ㊶ [TIMER CHECK]
- ㊷ AC Input socket
- ㊸ VIDEO IN socket (AV 1)
- ㊹ VIDEO OUT socket
- ㊺ RF IN socket
- ㊻ AUDIO IN sockets (AV 1)
- ㊼ AUDIO OUT sockets
- ㊽ RF OUT socket

### TV Operation using the remote control

You can use [TV-ON/OFF] ⑰<sup>\*1</sup>, [AV] ②<sup>\*2</sup>, [VOLUME] ⑲<sup>\*3</sup> and [Channel] ⑱<sup>\*4</sup> on the remote control for your TV operation.  
(See page 4.)

<sup>\*1</sup> To switch the TV on from standby mode (OFF) or vice versa.

On some TVs it is only possible to switch the TV to standby mode (OFF) with this button, but not on. In this case, try to turn the TV on with one of the following buttons:

[AV] ②  
[Channel] ⑱

<sup>\*2</sup> To select desired AV input on the TV.

<sup>\*3</sup> To adjust the volume of the TV.

<sup>\*4</sup> To select the desired programme position (TV station) on the TV.

### Note:

- You cannot operate TV channels with [Numeric] ③. When you want to change the channel, press [Channel] ⑱ on TV operation part.

## Setting the Remote Control to Operate Your TV

You can operate the TVs of the manufacturers listed below with the remote control after setting it.

This setting procedure allows you to operate the TVs of some manufacturers using the supplied remote control.

### Preparation

- Turn on the TV.

### Operations

- 1 Find the manufacturer number of your TV while referring to the following table.**
- 2 While holding down [TV-ON/OFF] (17) on the remote control, use [Numeric] (3) to enter the manufacturer number. This completes the settings for the TV manufacturer.**
  - Be sure to enter the number in two digits.  
Example: 1 → 01
- 3 To confirm the correct settings were made, check whether the TV can be operated properly.**
  - When a manufacturer has multiple numbers in the following table, try entering other numbers if the TV operations cannot be performed properly, and then select the optimal number.

### Notes:

- If you are using a Panasonic TV, this setting has already been made, and so you do not need to perform the above setting procedure. However, this remote control may not work with some Panasonic TVs.
- Some TV models cannot be operated using this remote control (including all TVs non-remote compatible).

### List of TVs Compatible with the VCR Remote Control

[Brand]	[Code]
Panasonic/National	01-04
SONY	05
TOSHIBA	06
JVC	07
HITACHI	08
MITSUBISHI	09, 10
SHARP	11
PHILIPS, SAMSUNG	12
NEC	13
SANYO	14
GOLDSTAR/LG	15, 16
SAMSUNG	17, 18
SANYO	19

## Connections

This section shows you how to connect the VCR to an aerial, TV, etc.

### Basic Connections

The following connections are required to record and play back the video cassette through the TV.

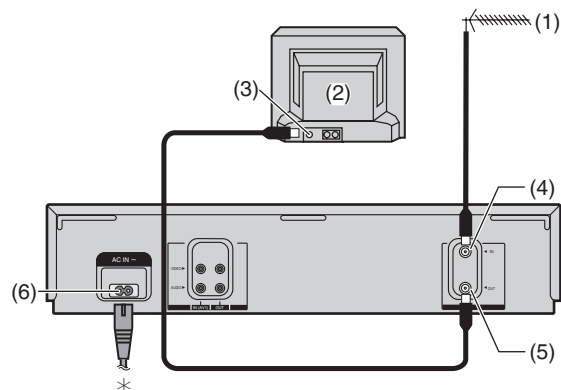

- (1) Aerial (Not supplied)
- (2) TV Set (Not supplied)
- (3) Aerial Connector
- (4) RF IN socket (45)
- (5) RF OUT socket (48)
- (6) AC Input socket (42)
- \* To mains supply

### Connection to a TV using the Audio/Video Input Socket:

Set the RF output channel of the VCR to [---] (RF OFF) when the VCR is connected to the TV via the Audio/Video input cable. (See page 5.)

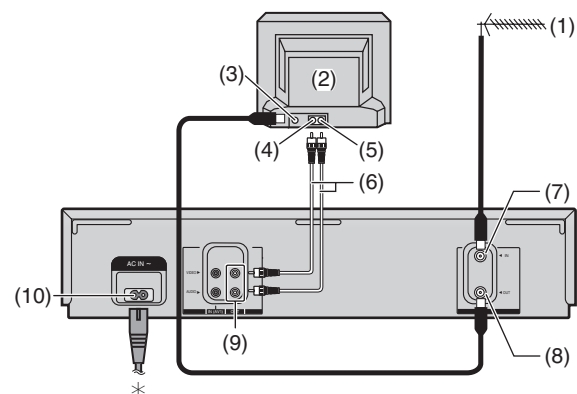

- (1) Aerial (Not supplied)
- (2) TV Set (Not supplied)
- (3) Aerial Connector
- (4) VIDEO IN
- (5) AUDIO IN
- (6) Audio Cable/Video Cable (Not supplied)
- (7) RF IN socket (45)
- (8) RF OUT socket (48)
- (9) VIDEO OUT (44) / AUDIO OUT (47)
- (10) AC Input socket (42)
- \* To mains supply

## Tuning the TV to Your VCR

The VCR supplies a signal to the TV via the RF coaxial cable on channel NZ21-69 or AU28-69.

If you have connected the VCR to the TV through the Audio/Video input sockets, then you do not need to follow the procedure below. To view the pictures from the VCR, set to the AV mode on the TV with [AV] (2).

### Preparation

- Turn on the TV and the VCR.

### Operations

- 1 Hold down [MENU] (9) for 5 seconds or more.
- 2 Set the TV to an unused position which you wish to use for your video playback.
  - Tune the TV until the display shown below appears on the screen. (Please refer to the TV manufacturers operating instructions regarding tuning.)

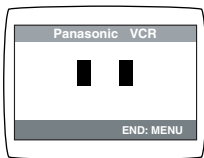

- 3 Press [MENU] (9).

## To Change the RF output Channel

You can change the RF output channel, for example, when interference occurs on the picture after tuning.

### Operations

- 1 Hold down [MENU] (9) for 5 seconds or more.
  - The VCR display changes as shown below and the VCR picture on the TV displays this pattern.

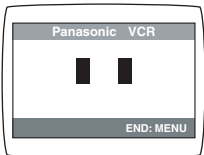

- 2 Enter the desired channel number (NZ21-69, AU28-69) by [Numeric] (3) or [Channel] (20).

- Set the RF output channel of the VCR to [---] (RF OFF) when the VCR is connected to the TV via the Audio/Video cable. Press [Channel] (20) to display [---].

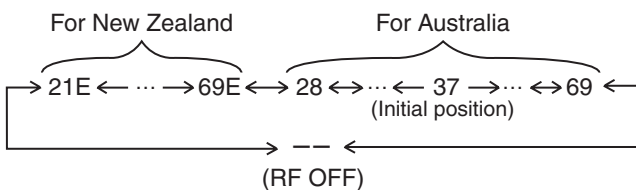

- It is also possible to select by pressing [Numeric] (3).

Example: 28: (2) → (8)

- 3 Press [MENU] (9) to finish the setting mode.

- 4 Retune your TV to the new RF channel for the VCR.

### Note:

- Even if the RF output channel has been changed, it is not necessary to perform Auto Tuning.

## Storing TV Broadcasts in Your VCR

The VCR is fitted with its own tuner (just like a normal TV) and can be preset to receive up to 99 TV broadcast stations.

## Pre-programmed TV Channels (Australia only)

The local TV broadcast channels 2, 7, 9, 10 and 28 are factory-preset in this VCR.

That is, if you can receive television broadcasts on VHF channels 2, 7, 9, 10 and UHF channel 28, these are already tuned on the programme positions with the matching numbers. However, it is possible to cancel these settings and tune the local TV broadcast channels to any desired programme position.

## Auto Tuning Using the On Screen Display For New Zealand

When you use this VCR in New Zealand, need to operate as follows.

### Preparations

- Confirm that the TV is on and the VCR viewing channel is selected.
- Turn on the VCR and select any programme position except A1 or A2.

### Operations

- 1 Press [MENU] (9) to display the Main menu on the TV screen.

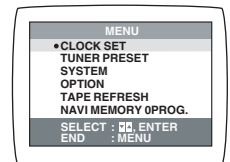

- 2 Press [▼▲] (28) to select [TUNER PRESET] then press [ENTER] (26).

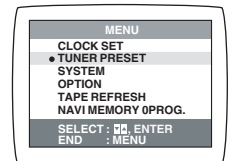

- 3 Press [▼▲] (28) to select [COUNTRY] then press [◀▶] (28) to select [NEW ZEALAND].

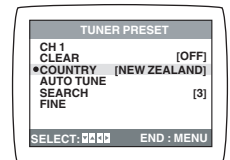

- 4 Press [▼▲] (28) to select [AUTO TUNE] then press [◀▶] (28) to start the Auto Tuning.

- When Auto Tuning is completed, the On Screen Display disappears and programme position 1 is selected.

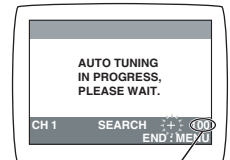
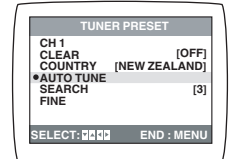

The number displayed here is the number of channels still to be auto tuned.

### Channels that can be received

	VHF	UHF	CATV
New Zealand	1-11	21-69	44-470 MHz

### Notes:

- Auto Tuning searches for TV stations from VHF minimum to UHF maximum and memorizes every tuned programme position. Other programme positions are skipped.
- Auto Tuning takes 5 or more minutes to complete its search.



## Auto Tuning Using the On Screen Display For Australia

### Introduction

Auto Tuning using the On Screen Display should be performed according to the following method if necessary.

### Preparations

- Confirm that the TV is on and the VCR viewing channel is selected.
- Turn on the VCR and select any programme position except A1 or A2.

### Operations

- 1 Press [MENU] (9) to display the Main menu on the TV screen.

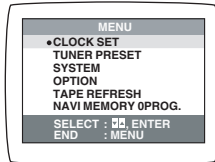

- 2 Press [▼▲] (28) to select [TUNER PRESET] then press [ENTER] (26).

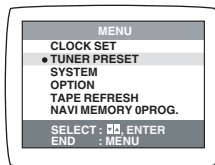

- 3 Confirm that [COUNTRY] is set to [AUSTRALIA].

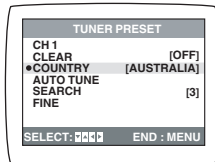

- 4 Press [▼▲] (28) to select [AUTO TUNE] then press [◀▶] (28) to start the Auto Tuning.
  - When Auto Tuning is completed, the On Screen Display disappears and programme position 1 is selected.

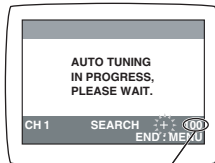
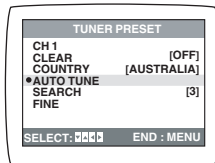

### Channels that can be received

	VHF	UHF	CATV
Australia	0-12	28-69	45-470 MHz

### Notes:

- Auto Tuning searches for TV stations from VHF minimum to UHF maximum and memorizes every tuned programme position. Other programme positions are skipped.
- Auto Tuning takes 5 or more minutes to complete its search.

## Manual Tuning Procedure

If the VCR is not correctly tuned by Auto Tuning, follow the procedure below.

- 1 Press [MENU] (9) to display the Main menu on the TV screen.
- 2 Press [▼▲] (28) to select [TUNER PRESET] then press [ENTER] (26).
- 3 Press [▼▲] (28) to select [CH] then select the channel number you want to tune by pressing [◀▶] (28).
- 4 Confirm that [CLEAR] is set to [OFF].
- 5 Press [▼▲] (28) to select [SEARCH] then press [◀▶] (28) to start the Manual Tuning.
  - If the desired TV station has not been tuned, press [◀▶] (28) again.
  - Press [MENU] (9) and repeat steps 3-5 for each programme position you want to tune to a station.

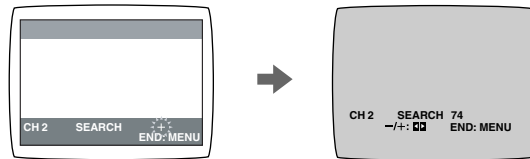

- 6 Press [MENU] (9) three times to exit the On Screen Display.

## Direct Tuning

Follow steps 1 to 4 of Manual Tuning Procedure.

- 5 Press [▼▲] (28) to select [SEARCH].
- 6 Press [Numeric] (3) to enter the number of the desired programme position.
  - For other channels that require tuning, repeat steps 3, 4, 5, 6.
- 7 Press [MENU] (9) twice to exit the On Screen Display.

## Fine Tuning Procedure

Follow steps 1 to 4 of Manual Tuning Procedure.

- 5 Press [▼▲] (28) to select [FINE] then press [◀▶] (28) to obtain the best tuning condition.
  - Press [ENTER] (26) to return the tuning to its former state.
- 6 Press [MENU] (9) to exit the On Screen Display.

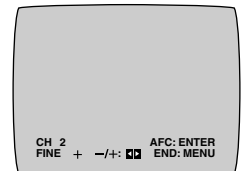

## Blanking of Unused Programme Positions

Follow steps 1 to 3 of Manual Tuning Procedure.

- 4 Press [▼▲] (28) to select [CLEAR] then press [◀▶] (28) to select [ON].
  - Repeat steps 3, 4 for other unused programme positions to skip during the selection of programme positions.
  - To cancel the blanking of a programme position, select that programme position then set [CLEAR] to [OFF].
- 5 Press [MENU] (9) twice to exit the On Screen Display.

## Setting the Clock of Your VCR

In the event of a power failure, the clock will operate on its back up system for a minimum of 3 years. After 3 years, clock back up in the event of a power failure can only be guaranteed for maximum of 1 hour.

### Preparations

- Confirm that the TV is on and the VCR viewing channel is selected.
- Turn on the VCR.

### Operations

- 1 Press [MENU] (9) to display the Main menu on the TV screen.

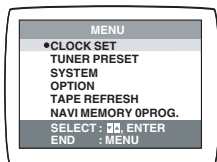

- 2 Press [▼▲] (28) to select [CLOCK SET] then press [ENTER] (26).

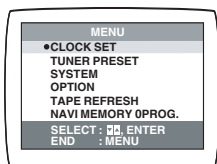

- 3 Set each item by pressing [◀▶▼] (28). Press [▲] (28) to return to the previous item.

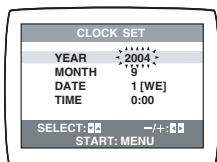

#### At the set time (TIME) point:

- When [◀▶] (28) is kept pressed, the indication changes in 30-minute steps.

- 4 Press [MENU] (9).
  - The clock starts.

## Time Reset Function

If the clock is less than 2 minutes slow or fast, it can easily be reset to the proper time.

### Example:

Resetting the clock to 12:00.00

- 1 Press [MENU] (9) to display the Main menu on the TV screen.
- 2 Press [▼▲] (28) to select [CLOCK SET] then press [ENTER] (26).
- 3 When the current clock displays on the VCR is between 11:58.00 and 12:01.59, press [MENU] (9) as soon as you see the 12:00.00. This resets the time to 12:00.00.

## Settings Using the On Screen Display

### Preparations

- Confirm that the TV is on and the VCR viewing channel is selected.
- Turn on the VCR.

### To Set the Colour TV System

- 1 Press [MENU] (9) to display the Main menu on the TV screen.

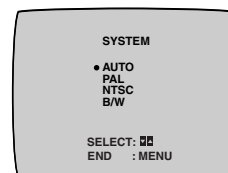

- 2 Press [▼▲] (28) to select [SYSTEM] then press [ENTER] (26).

- 3 Press [▼▲] (28) to select [AUTO].

- The VCR automatically distinguishes between PAL and NTSC signals. If the picture lacks of colour during AV external recording or playback, set to [PAL] or [NTSC].
- When you want to record or play back in black and white, set to [B/W].

- 4 Press [MENU] (9) twice to exit the On Screen Display.

### To Make Various Indicators Appear On Screen Display

At a press of [STATUS/ NAVI CHECK] (32), the following indications appear on the TV screen.

- Set [OSD] to [AUTO]. (See page 9.)
- The display is released automatically after 5 seconds.

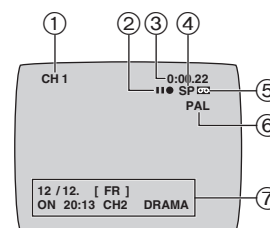

- 1 Programme position

- 2 Tape running display

Stop, Eject

Rewind, Review, Index Search ◀◀, Jet Search ◀◀, Jet Rewind



Fast Forward, Cue, Index Search ▶▶, Jet Search ▶▶



Playback



Recording



Recording pause



Repeat playback



- 3 Present time/Tape counter/Remaining tape time/Index Search/OTR indication/JET Rewind

Information	Display
Present time	17:24
Tape counter	0:02:54
Remaining tape time	REMAIN 2:34
Index Search	S 01
OTR indication	OTR 60
JET Rewind	J . REW

④ **Tape Mode/Rec Mode indicator (SP/LP/EP)**

⑤ **Cassette-in indicator**

⑥ **Colour system indicator**

Any selected colour TV system except [AUTO] appears on screen display. See the “**To Set the Colour TV System**” (page 7).

⑦ **NAVI CHECK indicator**

During playback, press the [STATUS/ NAVI CHECK] (32) repeatedly until the NAVI CHECK indicator appears. You can check the property of the programme being played. However, this function is effective only for programmes recorded with setting the [JET NAVIGATOR] to [ON]. (See to the right.)

Clock → Counter → Remaining Tape Time →  
→ **NAVI CHECK indicator** → Clock

- The VCR is checking the programme information while the message [CHECKING DATA] is displayed.
- When the message [DATA NOT FOUND] appears, the NAVI CHECK indicator cannot be displayed.

**Note:**

- The On Screen Display may be disturbed or disappeared during special playback.

## Option Setting

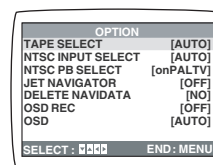
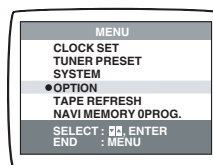

1 Press [MENU] (9) to display the Main menu on the TV screen.

2 Press [▼▲] (28) to select [OPTION] then press [ENTER] (26).

3 Press [▼▲] (28) to select the desired field.

**TAPE SELECT:** To select the corresponding video cassette tape length to display the approximate remaining tape time.

- Press [◀▶] (28) to select the corresponding video cassette tape length.  
AUTO: The VCR automatically distinguishes E30, -60, -90, -120, -180 and -240 tapes.  
E195: For E195 tape  
E260: For E260 tape  
E300: For E300 tape
- The remaining tape time may not be displayed correctly depending on the tape used.

**NTSC INPUT SELECT:** To select the colour TV system used to record NTSC signals.

- Press [◀▶] (28) to select [AUTO]. Allows NTSC [4.43] or [3.58] signals to be distinguished automatically.
- If the tape has not recorded correctly, select 4.43 or 3.58.  
4.43: When recording NTSC 4.43 signals.  
3.58: When recording NTSC 3.58 signals.
  - Some programmes on NTSC 3.58 system cannot be recorded correctly by selecting [3.58].

**NTSC PB SELECT:** To select the colour TV system of the TV used to play back a tape recording NTSC signals.

- Press [◀▶] (28) to select the desired position according to the colour TV system of the TV.  
on PAL TV: For TVs that can receive PAL signals.  
4.43: For TVs that can receive NTSC 4.43 signals.  
3.58: For TVs that can receive NTSC 3.58 signals.

**JET NAVIGATOR:** To set the conditions for the Jet Navigator Function.

- Press [◀▶] (28) to select [ON] or [OFF].  
OFF: Initially set at this position.  
ON: Jet Navigator function works. If you select [ON], [OSD REC] is set to [OFF] automatically.

**DELETE NAVIDATA:** To delete all the Jet Navigator data stored in the VCR memory.

- Press [◀▶] (28) to select [ENTER] then press [ENTER] (26) to do the deletion.  
NO: Initially set at this position.  
ENTER: It is done to delete all the Jet Navigator data.



OSD REC: To set the conditions for the OSD Recording function.

- Press [◀▶] (28) to select [ON] or [OFF].

OFF: Initially set at this position.  
 ON: This setting enables OSD Recording. (See page 11.) If you select [ON], [JET NAVIGATOR] is set to [OFF] automatically.

OSD: To select the On Screen Display mode.

- Press [◀▶] (28) to select [AUTO] or [OFF].

AUTO: To make various indicators appear On Screen Display for 5 seconds press [STATUS/ NAVI CHECK] (32).  
 OFF: No indications appear.

**4 Press [MENU] (9) twice to exit the On Screen Display.**

## Playback

### Preparations

- Confirm that the VCR is on.
- Confirm that the TV is on and the VCR viewing channel is selected.
- Insert a recorded video cassette.

### For Normal Playback:

Press [PLAY] (8).



### For Cue or Review Playback:

During playback, tap [Fast Forward] (27) or [Rewind] (10).

- To return to normal playback, press [PLAY] (8).
- If you press and hold down [Fast Forward] (27) or [Rewind] (10), cue or review playback continues for as long as you keep the button pressed, and operation returns to normal playback when the button is released.



### For High speed Cue or Review Playback (JET SEARCH):

During playback, tap [Fast Forward] (27) or [Rewind] (10) twice.

### For Still Playback:

During playback, press [PAUSE/SLOW] (29).

- To return to normal playback, press [PLAY] (8) or [PAUSE/SLOW] (29).



### For Slow Playback:

During playback, keep [PAUSE/SLOW] (29) pressed for 2 seconds or more.

- To return to normal playback, press [PLAY] (8).



### Fast-forwarding or Rewinding the Tape:

Press [Fast Forward] (27) or [Rewind] (10) in the stop mode.

- To stop fast-forwarding or rewinding, press [STOP] (12).

### To Obtain a Higher Speed Rewind (Jet Rewind):

Press [JET REW] (11).

The [J . REW] indication appears on the TV screen and only the channel position appears on the VCR display (except when the remaining tape time indication appears).

- Depending on a cassette or an operating condition, the rewind speed may change somewhat.
- The tape counter is reset to [0:00.00] when the tape is rewound to the beginning.

### To Stop Playback:

Press [STOP] (12).

### Notes:

- JET SEARCH, cue, review or slow playback will be automatically cancelled after 10 minutes, and still playback after 5 minutes.
- During playback function other than normal playback, horizontal noise bars may appear in the picture, the colour of the picture may be unstable, or the picture may be otherwise distorted.
- When you play back a tape recorded in the LP mode, the picture may be in black and white.
- When you play back a tape recorded in the EP mode, the picture and the sound may be unstable. However, these are not malfunctions.

## To Play Back a Recorded Part Repeatedly

Press [REPEAT] (30). The [R] indication appears on the VCR display.

- A recorded part on the tape must be at least 15 minutes long.
- When recording over the same location on a tape, it may not function correctly.

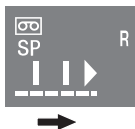

### To Cancel the Repeat Playback Mode:

Press [STOP] (12).

## NTSC Playback

Tapes recorded in the NTSC system can be played back with this VCR via a PAL system TV.

- Select [NTSC PB SELECT] from the On Screen Display according to the colour TV system of the TV. (See page 8.)
- NTSC 3.58 recording requires [NTSC INPUT SELECT] to be in the AUTO or 3.58 position (see page 8), however if [NTSC INPUT SELECT] is in this position when recording a NTSC 3.58 signal, no colour is available for the PAL TV. Once the recording is completed, you then need to select [on PAL TV] to view the recording in colour on PAL TV.
- On some TVs, the playback picture may roll up or down. If your TV has V-HOLD control or equivalent adjustment function, use it to adjust the picture.

### Note for only NTSC Playback on PAL system TV

This function is designed to allow only the playback of tapes recorded by NTSC signals on a PAL system TV. The NTSC signal is not completely converted to a PAL signal. For this reason, images play back by this function cannot be recorded correctly on other VCRs.

## Convenient Automatic Functions

### VCR Auto Power On

When you insert a video cassette, the VCR switches on automatically.

### Auto Playback Start

When you insert a video cassette with a broken erasure prevention tab, playback starts automatically without press [PLAY] (8).

### VCR-off Playback

When the VCR is off, the inserted cassette can be played back by pressing [PLAY] (8).

### Auto Rewind

When the tape reaches the end, the VCR automatically rewinds it to the beginning.

- This function does not work during timer recording, OTR recording and fast-forwarding.

### Automatic Switching Off and Ejection

When the VCR is switched off, the inserted cassette can be ejected simply by pressing [EJECT] (35). The VCR will eject the cassette and automatically turn itself off again.

## To Eject Video Cassette Using the Remote Control

Keep [STOP] (12) pressed for at least 3 seconds.

## Recording

### Preparations

- Confirm that the VCR is on.
- Confirm that the TV is on and the VCR viewing channel is selected.

### Operations

#### 1 Insert a video cassette with an intact erasure prevention tab.

- If it has already been inserted, press [VCR-ON/OFF] (1) to turn the VCR on.

#### 2 Select the TV station using [Channel] (20).

- It is also possible to select by pressing [Numeric] (3).

#### 3 Press [REC] (15) ([REC/OTR] (38)) to start recording.

#### 4 Press [STOP] (12) to stop recording.

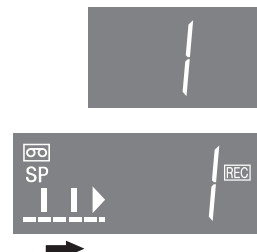

## To Select the Desired Rec Mode

Press [REC MODE] (33) before recording.

- SP provides standard recording time, optimum picture and sound quality.
  - LP provides double recording time with slightly reduced picture and sound quality.
  - EP provides triple recording time with slightly reduced picture and sound quality.
- When you play back a tape recorded in the EP mode, the monaural sound may be unstable.



When you start the recording in the EP mode, [EP] indication on the VCR display flashes for about 8 seconds.

EP mode means Super Long Play (SLP).

## To Pause Recording

Press [PAUSE/SLOW] (29) during recording.

Press it again to continue recording.



## To View One TV Programme while Recording Another TV Programme

After pressing [REC] (15) to start recording, select on your TV the programme position of the TV programme that you want to view.

## To Prevent Accidental Erasure of Recorded Contents

Break out the erasure prevention tab after recording.

If you insert a video cassette with a broken out erasure prevention tab and press [REC] (15) ([REC/OTR] (38)), the [ ] indication flashes on the VCR display to indicate that recording is not possible.

To record this video cassette again, cover the tab hole with two layers of adhesive tape.

## To Display the Approximate Remaining Tape Time

The remaining tape time can be displayed in the VCR display.

- 1 Select [TAPE SELECT] from the On Screen Display and select the corresponding video cassette tape length. See page 8.

- 2 Press [STATUS/ NAVI CHECK] (32) repeatedly until the Remaining Tape Time appears on the VCR display.



For certain cassettes, the remaining tape time may not be displayed correctly.

## To reset the tape counter

Press [RESET] (31) to reset the tape counter (elapsed time) to [0:00.00].

- The tape counter is automatically reset to [0:00.00] when a video cassette is inserted.
- The tape counter is reset to [0:00.00] when you operate the Jet Rewind function and the tape is rewound to the beginning.

### Notes:

- When playing back a cassette recorded in the LP or EP mode, some pictures and sound distortion may occur. However, this is not a malfunction.
- The recording pause mode will be automatically cancelled after 5 minutes and return to the stop mode.
- The tape recorded in the EP mode on this VCR cannot be played back on the other VCR without EP mode function.
- On the other VCR (even with EP mode function), when you play back the tape recorded in the EP mode, the picture and the sound may be distorted. However, this is not a malfunction.

## To Record the Present Date and Time (OSD Recording) on the same screen as the picture

This function allows you to record the present date and time on the same screen as the picture being recorded.

### Operations

- 1 Set [OSD REC] to [ON]. (See page 9.)
- 2 Press [REC] (15) ([REC/OTR] (38)).
- 3 Press [STOP] (12) to stop recording.



### Note:

- This function is also activated for OTR recording and Timer recording.

## To Select the Recording Duration and Perform Timer Recording (OTR Recording)

OTR means One-Touch Recording and is called this way, because you can start recording and select the recording duration by repeatedly pressing a single button. This is very convenient, for example when you want to start recording immediately but need to go out or want to go to bed. After the selected recording duration has elapsed, recording stops and the VCR automatically switches off.

### To Perform an OTR Recording:

- 1 Display the VCR picture on the TV.
- 2 Insert a video cassette with an intact erasure prevention tab.
- 3 Press [Channel] (20) to select the programme position on which the TV programme to be recorded will be broadcast.
- 4 Press [REC/OTR] (38) to start recording.
- 5 Press [REC/OTR] (38) repeatedly to select the desired recording duration.
  - Every time you press this button, the recording duration indicated in the VCR display changes in the following order.
  - For example, if you select [30], the VCR records a programme from that moment for 30 minutes.

Counter display (normal recording mode) → 30 (min.) → 60 (min.) → 90 (min.) → 120 (min.) → 180 (min.) → 240 (min.) → Counter display (normal recording mode)

### To Stop the OTR Recording Before the End:

Press [STOP] (12).

### Notes:

- The OTR function works during normal recording.
- When the tape reaches its end during OTR recording, the VCR will turn itself off.

## Recording from an external source

This function can be used to make up an edited tape from other recordings or video sources.

A new scene can be added to the end of previous one.

### Recording VCR

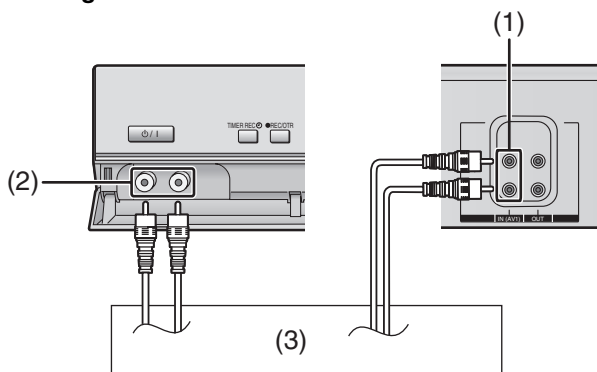

- (1) AV 1  
(VIDEO IN **43**/AUDIO IN **46**)
- (2) AV 2  
(VIDEO IN **36**/AUDIO IN **37**)
- (3) Other VCR or Video movie camera

### Preparations

- Connect a video movie camera or another VCR to this VCR as shown.
- Display the VCR picture on the TV.
- Insert the cassette on which the copying is to be performed, and make sure that its erasure prevention tab is not broken out.
- Select the audio/video source required by pressing [INPUT SELECT] **6** to set A1 or A2.
  - A1: Through the AV1 (AUDIO IN/VIDEO IN) sockets.
  - A2: Through the AV2 (AUDIO IN/VIDEO IN) sockets on front panel.

### Operations

- 1 Press [PLAY] **8** to start playback.
- 2 At the point where you want to join a new scene, press [PAUSE/SLOW] **29** to put it in the still playback mode.
- 3 Press [REC] **15** to put it in the recording pause mode.
- 4 Start playback on the source unit and search for the point from which you want to record (copy) onto this VCR.
- 5 When that point is reached, press [PAUSE/SLOW] **29** again to start recording the new picture and sound from the playback unit.
- 6 To record (copy) additional scenes, press [PAUSE/SLOW] **29** to put this VCR in the recording pause mode and then perform above steps 4 and 5 again.
- 7 At the point where you want to stop recording, press [STOP] **12** to finish recording.

### Note:

- If you leave the VCR in the recording pause mode for more than 5 minutes in step 3 or 6, the VCR automatically switches over to stop mode to protect the video heads.

## To Delete all of a Cassette's Contents (Tape Refresh Function)

You can delete a cassette contents (the picture, the sound and the Jet Navigator data) all at once.

### Operations

- 1 Be sure to set [JET NAVIGATOR] to [ON] when you want to delete all contents of a cassette that is recorded while setting [JET NAVIGATOR] to [ON]. Be sure to set [JET NAVIGATOR] to [OFF] when you want to delete all contents of a cassette that is recorded while setting [JET NAVIGATOR] to [OFF] or is recorded on another VCR. (See page 8.)
- 2 Insert a cassette that you want to delete the cassette contents.
- 3 Press [MENU] **9** to display the Main menu on the screen.
- 4 Press [▼▲] **28** to select the [TAPE REFRESH], and then press the [ENTER] **26**.

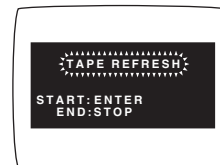

- 5 Press [ENTER] **26** for 2 seconds or more to start the tape refresh function.

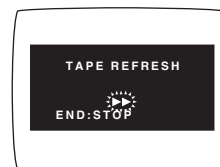

The tape is rewound to the beginning, and it is fast-forwarded with the tape refresh function.

When the tape reaches the end, the VCR automatically rewinds it to the beginning.

### Note:

- When a video cassette with a broken off erasure prevention tab is inserted, this function is not activated.

# Timer Recording

## Easy Timer Programming

Up to 16 timer programmes, including weekly and daily programmes, can be recorded up to one month in advance by setting the timer.

### Preparations

- The VCR must be turned on, or in timer recording standby mode.
- Confirm that the TV is on and the VCR viewing channel is selected.
- Insert a video cassette with an intact erasure prevention tab.
- Check that the clock is set to the correct time. If it has not been set, refer to page 7.
- When [JET NAVIGATOR] is set to [ON] (See page 8), you can set the category. Alternatively, you can see the category on the Navigator list. (See page 15 for details.)

### Operations

In case of [JET NAVIGATOR] is set to [ON];

1 Press [PROG] (7) to display the menu for timer programme on the TV screen.

2 Press [◀▶] (28) to set the date on which the TV programme will be broadcast, and press [▼] (28).

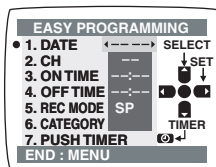

3 Press [◀▶] (28) to select the programme position of the desired TV station, and press [▼] (28).

4 Press [◀▶] (28) to set the starting time, and press [▼] (28).

- When [◀▶] (28) is kept pressed, the indication changes in 30-minute steps.

5 Press [◀▶] (28) to set the ending time, and press [▼] (28).

6 Press [◀▶] (28) to set the desired Rec Mode, and press [▼] (28).

- SP provides standard recording time, optimum picture and sound quality.

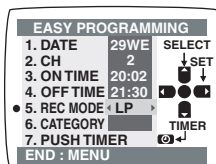

LP provides double recording time with slightly reduced picture and sound quality.

EP provides triple recording time with slightly reduced picture and sound quality.

Regarding the [A] indication, refer to page 14.

When you play back a tape recorded in the EP mode, the monaural sound may be unstable.

7 Press [◀▶] (28) to select the Category. Then, select the desired category by pressing [▼▲◀▶] (28).

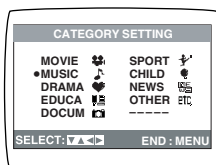

- When [JET NAVIGATOR] is set to [OFF] (See page 8), proceed to step 9.

8 Press [MENU] (9) to make the previous display appears.

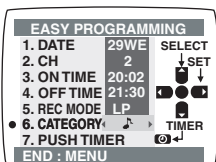

9 Press [TIMER (REC)] (14) to switch the VCR over to the timer recording standby mode.

- When [JET NAVIGATOR] is set to [ON] (see page 8), the [PROGRAMME IS COMPLETE. REMAINING PROGRAMME 49.]\* message appears.
- When [JET NAVIGATOR] is set to [OFF] (see page 8), the [PROGRAMME IS COMPLETE.]\* message appears.

\*These messages will not appear if timer recording is started immediately after [TIMER (REC)] (14) is pressed.

## To Suspend the Timer Recording Standby Mode

When you want to use the VCR for playback, normal recording or some other operation before the programmed timer recording perform, you can temporarily suspend the timer recording standby mode by pressing the [TIMER (REC)] (14) so that the [⊖] indication on the VCR display disappears.

However, after you have finished using the VCR, be sure to reactivate the timer recording standby mode by pressing the [TIMER (REC)] (14) again otherwise the programmed timer recording will not be performed.

## Weekly and Daily Timer Recording

In step 2 of Easy Timer Programming, select the desired day by pressing [◀] (28).

Current date ↔ Weekly ↔ Daily ↔

↔ the day before one month ↔ Current date...

### Weekly:

SU=Sunday, MO=Monday, TU=Tuesday, WE=Wednesday, TH=Thursday, FR=Friday, SA=Saturday

### Daily:

Daily recording	On Screen Display	VCR Display
Monday to Friday	MO-FR	M-F
Monday to Saturday	MO-SA	M-S
Sunday to Saturday	SU-SA	S-S

For example, SU (Sunday)

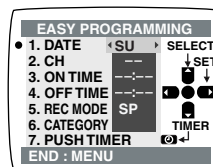

## Timer Recording from an External Signal Source

If timer recording is performed by a unit connected to the Audio/Video input sockets, select the A1 or A2 indicator in step 3 of Easy Timer Programming for the programme position.

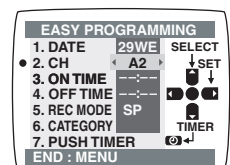



## Setting other Programmes in Succession

Repeat steps 1-9 of Easy Timer Programming (page 13).

## Programming a Timer Recording of a TV Programme Until its End (Rec Mode Auto Change Function)

If the VCR determines that the remaining tape time is insufficient to record the programme to its end during a timer recording performed in the SP mode, this function automatically changes the Rec Mode to ensure that the whole programme will be recorded.

The Rec Mode will change as follows:

PAL system: SP → LP

NTSC system: SP → EP

- This function cannot change the recording mode to the EP mode for PAL system.

Depending on the remaining tape length, recording may be performed in the LP (EP) mode from the start. However, if the remaining tape time is still not sufficient in this case, the programme cannot be recorded to the end.

The tape length must be set correctly. (See page 8.)

Some tapes may not work correctly.

If the recording mode changes from SP to LP during a timer recording, some brief picture distortion occurs at that point.

To Activate the Rec Mode Auto Change Function:

Press [REC MODE] (33) to select [A].

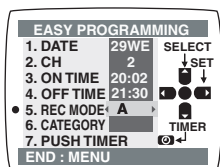

- Every time you press [REC MODE] (33), the indication changes in the following order:

SP → LP → EP → A → SP

## Timer recording for the same programme on the next week (Intelligent Timer)

When you wish to set the timer recording for programmes which will be recorded within 1 week and you have ever recorded the programmes before, you can record them soon with I-TIMER function without entering day and time by buttons. Select the desired setting from the list of timer programme recorded before. Please check the date and time carefully.

Preparations

- The VCR must be turned on, or in timer recording standby mode.
- Confirm that the TV is on and the VCR viewing channel is selected.
- Insert a video cassette with an intact erasure prevention tab.

1 Press [I-TIMER] (24) to display the menu for Intelligent Timer on the TV screen.

- The list of the timer programmes which are recorded before appears.

2 Press [▼▲] (28) to select the timer programme which you want to record on the next week.

DAY	CH	ON	OFF	
SU	4	19:10	19:55	EP ♪
SU	14	15:00	16:00	SP ♪
SU	25	10:30	11:00	A
SA	2	20:02	21:30	SP ♡
FR	2	20:02	21:30	SP
WE	5	22:15	23:30	EP ♪

SELECT: [ENTER] END: MENU

3 Press [ENTER] (26).

- Timer Programme List screen appears.

4 Press [TIMER (REC)] (14) to switch the VCR over to the timer recording standby mode.

DATE	CH	ON	OFF	
15SA	2	10:30	11:00	SP
15SA	25	20:02	21:30	SP
16SU	25	10:30	11:00	A
---	---	---	---	---
---	---	---	---	---
---	---	---	---	---
---	---	---	---	---

SELECT: [SET] END: MENU

Notes:

- Up to 16 I-Timer Programmes can be memorized.
- When I-Timer Programmes are increased to more than 16, the oldest one is deleted.

## To check and cancel a Timer Programme

Preparations

- The VCR must be turned on, or in timer recording standby mode.
- Confirm that the TV is on and the VCR viewing channel is selected.

1 Press [CHECK] (23) or [TIMER CHECK] (41).

- The Timer Programme List screen appears.

2 Press [CHECK] (23) or [TIMER CHECK] (41) repeatedly to select the program.

- Every time you press [CHECK] (23) or [TIMER CHECK] (41), the cursor shifts below.

- Press [▶] (28) to display the category. (When [JET NAVIGATOR] is set to [ON].) Press [▶] (28) again to make the previous display appear.

DATE	CH	ON	OFF	
SU-SA	25	10:30	11:00	A
SU	14	15:00	16:00	SP
19WE	5	22:15	23:30	EP
23SA	2	20:02	21:30	SP
28FR	A2	18:02	19:30	SP
30SU	4	19:10	19:55	EP
---	---	---	---	---
---	---	---	---	---

SELECT: [SET] END: MENU

3 Press [CANCEL] (5) to cancel.

4 Press [MENU] (9) to exit the On Screen Display.

Notes:

- If timer recording is not completed (due to insufficient tape or cancellation by the user), the programmed timer recording data will be cancelled from the memory by 4 A.M two days later. However, if the timer recording function is activated at that time, the programmed timer recording data will not be cancelled.
- After you cancel the programmed timer recording data, the current Rec Mode is displayed during the stop mode.

## Search Functions

### Jet Navigator

This VCR can display a list of the recorded programmes on the inserted video cassette on the TV screen. You can then select the desired programme, and the VCR will quickly locate its beginning and start playback.

Conditions for correct operation of the Jet Navigator function:

- The tape length of the inserted cassette must be set correctly. (See page 8.)
- The VCR must not be in the timer recording standby mode.
- A programme at least 15 minutes must be recorded on the tape.

#### Preparations

- Display the VCR picture on the TV.
- Be sure to set [JET NAVIGATOR] to [ON] (see page 8) and perform recording.

#### Operations

##### 1 Press [NAVI] (25) to display the Jet Navigator list.

- Up to 14 programme data that have been recorded are displayed on the Jet Navigator list.  
(7 programme data for each page)
- When more than 14 programs have been recorded in one cassette, the programme data are deleted from the first one.
- When pressing [NAVI] (25) during playback, playback stops and the Jet Navigator list appears.

##### 2 Press [NAVI] (25) several times to select the programme that you want to locate and play back. After more than 3 seconds, the VCR starts to search for the beginning of the selected programme and playback starts automatically.

- Every time you press [NAVI] (25), the cursor shifts above.

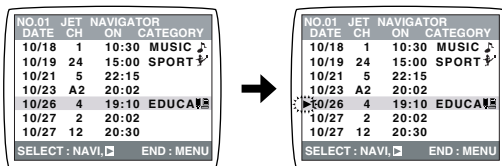
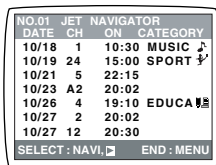

#### To Cancel the Jet Navigator list:

Press [MENU] (9).

### To Set the Category

The category setting allows you to find what kind of programmes are recorded by the character and the icon indications.

- 1 Press [▶] (28) while the Jet Navigator list appears. Then, select the desired category by pressing [▼▲◀▶] (28).

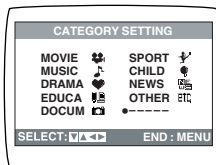

- 2 Press [MENU] (9).

Category	Indication	Icon
MOVIE	MOVIE	🎬
MUSIC	MUSIC	♪
DRAMA	DRAMA	♥
EDUCATION	EDUCA	📖
DOCUMENTARY	DOCUM	📺

Category	Indication	Icon
SPORTS	SPORT	⚽
CHILDREN	CHILD	👶
NEWS	NEWS	📰
OTHERS	OTHER	ETC

### To Delete the Jet Navigator Data of a Single Video Cassette Tape

Keep [CANCEL] (5) pressed for more than 5 seconds while the Jet Navigator list appears.

[—] appears on the list.

See page 8 to delete all the Jet Navigator data stored in the VCR memory.

#### Notes:

- The Jet Navigator list is stored in each cassette. Up to 20 cassettes and 50 programmes can be registered.
- Signals approximately 10 seconds before and after the current tape position are checked. (During this checking, [CHECKING JET NAVIGATOR DATA.] is displayed on the TV screen.)
- Checking cannot be performed properly where there are no signals such as at unrecorded portions of the tape. In this case, press [NAVI] (25) at a portion of the tape where a programme has been recorded of this VCR. This will allow signal checking to be performed more reliably. When a signal is still not found, [CAN NOT FIND JET NAVIGATOR DATA.] is displayed on the TV and you cannot find the beginning of the programme.
- [PROGRAMME IS COMPLETE. REMAINING PROGRAMME 0. DELETE JET NAVIGATOR DATA.] appears when you try to store more than 50 programmes. The new item is added and the oldest item is deleted.
- When programmes equivalent to 20 cassettes are already stored in memory, [REMAINING CASSETTE 0. FOR JET NAVIGATOR.] is displayed after Jet Navigator data checking is performed. Programmes recorded without deleting data are not registered in the list.
- The list does not appear when playing tapes recorded on other equipment.
- When recording over the same location on a tape, it may not work correctly.

### Confirming the cassette which includes a programme you want to watch (Jet Navigator Memory)

This allows you to search the cassette which you recorded the programme you want to watch without inserting video cassette tapes.

#### Preparations

- Display the VCR picture on the TV.
- You can only search for cassettes recorded in timer recording with setting [JET NAVIGATOR] to [ON] (See page 8) on this VCR in the past.

- 1 Press [MENU] (9) to display the Main menu on the TV screen.

- 2 Press [▼▲] (28) to select [NAVI MEMORY 1\*PROG.] then press [ENTER] (26).

- NAVI MEMORY Screen appears.
- The programme list for 1 cassette is displayed per 1 screen.
- Up to 20 cassettes can be selected on this VCR and displayed on the NAVI MEMORY Screen.

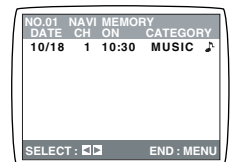

- \* The number of Jet Navigator Data memorized on this VCR is displayed.

- 3 Press [◀▶] (28).

- The display can be switched for each cassette (programme list).

#### To Cancel the NAVI MEMORY Screen:

Press [MENU] (9).

## To Demonstrate the Jet Navigator Function

Keep [NAVI] (25) pressed for more than 5 seconds without inserting a cassette tape.

NO.01 JET NAVIGATOR				
DATE	CH	ON	CATEGORY	
1/10	2	8:00	MUSIC	♪
1/10	6	19:00	SPORT	⚽
1/10	4	21:00	MOVIE	🎬
1/10	6	22:00	CHILD	👶

DEMONSTRATION

SELECT : NAVI      END : MENU

### To Cancel the Demonstration of Jet Navigator Function:

Press [MENU] (9).

## To Check the Recorded Programming Data (Time Stamp Function)

When playback starts after searching with Jet Navigator function or index search function, recorded programming data (called Time Stamp) appears on the TV screen for approx. 5 seconds.

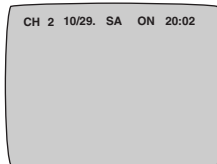

### Note:

- Time Stamp does not appear if the beginning of the Jet Navigator data is not recorded 10 minutes before and after the current tape position even when index signals are recorded.

## To Find the Beginning of Each Recording (VHS Index Search System)

This VCR automatically records special index signals on the tape every time a recording is started. The Index search function makes use of these index signals to let you find the beginning of a desired programme quickly and easily.

### Index signals are automatically recorded in the following cases:

- When you start a recording by pressing [REC] (15) or [REC/OTR] (38).
- When a timer recording starts.
- When you press [REC] (15) on the remote control during recording.

### Conditions for correct operation of the Index search function:

- The VCR must be in the stop mode or in the playback mode.
- Each programme recorded on the tape must be at least 5 minutes long.

### Preparations

- Display the VCR picture on the TV.
- Insert a recorded video cassette.

### Operation

- 1 Press [INDEX] (13) (that corresponds to the direction from the current tape position in which the desired programme is located on the tape) to start the index search.

For example, if you want to search for the 2nd recorded programme in forward direction, press [INDEX] (13) (▶▶) twice.



- The VCR fast-forwards or rewinds the tape and searches for the specified index signal (the beginning of the desired recorded programme).  
When it is found, playback starts automatically.

### To Cancel the Index Search or to Stop Playback:

Press [STOP] (12).

### Notes:

- Searching in either direction is possible up to the 20th index signal.
- If you press either of [INDEX] (13) too many times, simply press the other [INDEX] (13) (indicating the opposite direction) to correct it. In this way, you can reduce the displayed figure down to 1.
- The figure on the VCR display decreases by 1 every time an index signal is located.

## Finding a Timer-recorded programme for viewing (Easy Programme Playback)

Allows you to find a timer-recorded programme with One-touch operation and to play it back easily.

### Preparation

Set timer recording for the programme you wish to view.

### Operation

- 1 Press [PROG PLAY] (22).

- As soon as the timer-recorded programme is found, playback starts automatically.



### To Cancel the Easy Programme Playback:

Press [STOP] (12).

### Notes:

- The VCR memorises the position at which timer recording is set to the standby mode by pressing [TIMER (REC)] (14) as the start point of Easy Programme Playback.
- If you take out the cassette after a timer recording has finished, Easy Programme Playback function does not work.

---

---

## Before Requesting Service

---

---

### Message of On Screen Display

The error message is indicated in brackets [ ].

[PLEASE PUT IN A VIDEO CASSETTE.]

- [REC/OTR] (38) ([REC] (15) or [TIMER (REC)] (14) has been pressed without a video cassette inserted.

→Insert a video cassette.

[PLEASE STOP THE TAPE.]

- [TUNER PRESET] has been selected during playback.

→Stop the tape.

[PLEASE SET THE CLOCK.]

- [TIMER (REC)] (14), [PROG] (7), [CHECK] (23) or [TIMER CHECK] (41) has been pressed when the clock is not set.

→Set the clock.

[PLEASE USE A CASSETTE WITH TAB.]

- [REC/OTR] (38), [REC] (15) or [TIMER (REC)] (14) has been pressed with a video cassette without an erasure prevention tab.

→Use a video cassette with an intact erasure prevention tab.

[NO TIMER RECORDING HAS BEEN SET.]

- [TIMER (REC)] (14) has been pressed with no timer programmes.

→Set timer recording.

[VCR IS IN THE TIMER STANDBY MODE.]

- [VCR-ON/OFF] (1) has been pressed during the timer standby mode.

→Press the [TIMER (REC)] (14) to release the VCR from the timer standby mode.

[CAN NOT FIND PROG PLAY DATA.]

- [PROG PLAY] (22) has been pressed with no programmed timer recording data.

→Set timer recording.

### The VCR will not operate correctly

The symptom description is indicated in brackets [ ].

[The VCR display is not illuminated.]

- The mains lead has not been connected.

→Connect the mains lead to the mains supply.

[The VCR display is illuminated but the VCR will not operate.]

- The VCR is in the timer mode.

→Press the [TIMER (REC)] (14) to operate the VCR manually.

- Safety devices are operating.

→Disconnect the mains lead and wait for 1 minute.

Reconnect the mains supply and check functions.

- Dew may have formed.

→Do not operate the VCR for 1 hour.

### Playback will not operate correctly

The symptom description is indicated in brackets [ ].

[The picture is noisy or is not in colour. Horizontal bars or lines run down the screen.]

- Tracking is not correct.

→Adjust the tracking. See page 18.

- The TV has not been tuned to the VCR.

→Tune the TV to the VCR. See page 5.

- The video heads are clogged or worn.

→Consult your dealer for further advice.

→Consult Panasonic Customer Care Centre for advice on 132600. (For Australia)

- The playback picture is distorted when using an E300 type video cassette that was recorded in the LP or EP mode.

→We recommend that you use video cassettes other than type E300.

### Recording will not operate correctly

The symptom description is indicated in brackets [ ].

[The  indication flashes whenever recording is attempted.]

- The erasure prevention tab on the video cassette has been broken off.

→Use a tape with an intact erasure prevention tab, or cover the tab hole with adhesive tape, if the original recording is no longer required.

[The picture is recorded with noise or a blank screen.]

- The aerial or aerial cable is defective.

→Check the aerial connection to the VCR. See page 4.

→Check your normal TV picture. If there is no picture, check your aerial.

- The VCR is not correctly tuned.

→Retune the VCR. See pages 5-6.

- A1 or A2 has been selected.

→Select the required TV programme.

[Timer recording cannot be performed.]

- The clock or calendar has been incorrectly set.

→Check the clock and calendar. Set them to the present time. (Note that this is a 24-hour clock.)

See page 7.

- The recording starting or ending time setting is incorrect.

→Set the recording starting and ending time correctly.

- The VCR has not been set for timer recording.

→Press [TIMER (REC)] (14) after programming for timer recording.

[AV external recordings cannot be made.]

- A1 or A2 has not been selected.

→Select A1 or A2 by pressing [INPUT SELECT] (6).

- External AV connections are incorrect.

→Check that the connections for external video and audio sources are correct. See page 12.

### The remote control will not operate correctly

The symptom description is indicated in brackets [ ].

[The remote control does not operate correctly.]

- The remote control transmitter beam is not reaching the VCR.

→Ensure that the remote control is being pointed at the VCR and that the transmitter beam is not obstructed.

- The distance is too far.

→Use the remote control within 7 m of the VCR.

- The batteries are exhausted.

→Replace the batteries. See the precautions for replacement on page 2.

- The batteries are incorrectly fitted with (+/−) reversed.

→Fit the batteries correctly as shown on page 2.

- The remote controller signal sensor is exposed to strong light source such as direct sunlight or inverted fluorescent light.

→Keep strong light source so far away from the remote controller signal sensor as possible.

## Crystal View Control

The crystal view control function ensures that you always obtain the optimum picture quality so that you get the best picture automatically.

### Adjusting the Playback Picture

Under normal conditions, the VCR automatically adjusts the playback picture for optimum quality. However, in some cases it may be necessary to adjust it manually.

#### If the Picture Contains Noise Bars and It Is Not Clear to See (Tracking adjustment):

If noise bars appear during normal playback, slow playback or still playback, follow the operations below.

During normal or slow playback, press [TRACKING/V-LOCK] (20) + or – until the bars noise disappear.

- If the noise bars appear during still playback, switch the VCR over to the slow playback mode and then adjust the tracking as explained above.

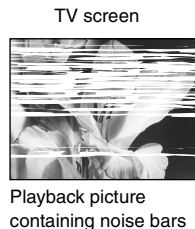

#### To Return to Auto Tracking:

Press both [TRACKING/V-LOCK] (20) + and – simultaneously.

#### If the Still Picture shaking (V-Lock Adjustment):

If the still picture shakes, perform the following operation.

During still playback, keep [TRACKING/V-LOCK] (20) + or – pressed until the picture stops shaking.

#### Precautions:

- With certain TV models and tapes, it may not be possible to adjust the tracking.
- If you play back a cassette that was recorded on another VCR, the picture quality may be inferior and it may be necessary to adjust the tracking. Also, on some TVs, the picture may shake in the special playback functions. However, these are not malfunctions.

### Dirt on the video heads

If the video heads get dirty, pictures will not be recorded or played back clearly.

(See the following conditions.)



If this happens, insert and eject a cassette 5-10 times successively to remove the dirt from the video heads.

If the problem still persists after performing above, contact a service personnel to request assistance.

**Head cleaning by service agents is not covered by warranty.**



---

---

## Specifications

---

---

### NV-MV41GN

<b>Power Source:</b>	220–240 V AC 50/60 Hz
<b>Power Consumption:</b>	11 W

<b>Video Recording System:</b>	2 rotary heads, helical scanning system
<b>Video Heads:</b>	4 heads
<b>Tape Speed:</b>	PAL SP; 23.39 mm/s    LP; 11.7 mm/s    EP; 7.8 mm/s NTSC SP; 33.3 mm/s    EP; 11.1 mm/s
<b>Tape Format:</b>	VHS tape
<b>Record/Playback Time:</b>	PAL SP; 240 min with NV-E240 PAL LP; 480 min with NV-E240 PAL EP; 720 min with NV-E240
<b>FF/REW Time:</b>	Approx. 60 s with NV-E180 (FF/REW) Approx. 43 s with NV-E180 (Jet Rewind)

### VIDEO

<b>Television System:</b>	CCIR; 625 lines, 50 fields, PAL colour signal EIA; 525 lines, 60 fields, NTSC colour signal
<b>Modulation System:</b>	Luminance; FM azimuth recording Colour signal; converted subcarrier phase shift recording
<b>Input Level:</b>	VIDEO IN (PHONO); 1.0 Vp-p, 75 ohm, terminated
<b>Output Level:</b>	VIDEO OUT (PHONO); 1.0 Vp-p, 75 ohm, terminated RF Modulate; UHF Channel    NZ21–69 (New Zealand)    75 ohm AU28–69 (Australia)    75 ohm

### AUDIO

<b>Input Level:</b>	AUDIO IN (PHONO); –6 dBV, more than 47 kohm
<b>Output Level:</b>	AUDIO OUT (PHONO); –6 dBV, less than 1 kohm
<b>Audio Track:</b>	1 track (Normal-mono only)
<b>Video Horizontal Resolution:</b>	Colour; more than 240 lines (SP)
<b>Signal-to-Noise Ratio:</b>	Video; more than 43 dB (SP) Audio; more than 43 dB (SP)
<b>Audio Frequency Response:</b>	80 Hz–8 kHz/SP
<b>Operating Temperature:</b>	5°C–40°C
<b>Operating Humidity:</b>	35%–80%
<b>Mass:</b>	3 kg
<b>Dimensions:</b>	430 mm (W) × 89 mm (H) × 227 mm (D)
<b>Standard Accessories:</b>	1 pc. AC Mains Lead 1 pc. RF Coaxial cable 1 pc. Remote Control 2 pcs. R6 size batteries

Mass and dimensions shown are approximate. Specifications are subject to change without notice.

**Matsushita Electric Industrial Co., Ltd.**

Web Site: <http://www.panasonic.co.jp/global/>

## Free Manuals Download Website

<http://myh66.com>

<http://usermanuals.us>

<http://www.somanuals.com>

<http://www.4manuals.cc>

<http://www.manual-lib.com>

<http://www.404manual.com>

<http://www.luxmanual.com>

<http://aubethermostatmanual.com>

Golf course search by state

<http://golfingnear.com>

Email search by domain

<http://emailbydomain.com>

Auto manuals search

<http://auto.somanuals.com>

TV manuals search

<http://tv.somanuals.com>