

PHILIPS



VCR

VIDEO CASSETTE RECORDER

NOM

VR355/50



PHILIPS

2 Table of Contents

Safety Precautions

WARNING: DANGEROUS VOLTAGE INSIDE
WARNING: TO PREVENT FIRE OR SHOCK
HAZARD, DO NOT EXPOSE THIS
UNIT TO RAIN OR MOISTURE.

- The POWER button does not completely shut off mains power from the unit, but switches operating current on and off.
- The rating plate and the safety caution are on the rear of the unit.

Introduction

Congratulations on purchasing your new VCR (Video Cassette Recorder). It is one of the most sophisticated yet simple-to-use home video recorders you can buy. It will give you many hours of enjoyment, whether you use it for playing back prerecorded cassettes of your favourite films, or for recording TV programs which you would otherwise have missed. Alternatively, you may find it an invaluable business aid.

You can't wait to get it working, but before you do, spare a few moments to read this brief introduction to the world of video recording. It may repay you handsomely in terms of improved results, or avoiding of costly mistakes.

Your VCR is prepared for reception of NTSC programs.

IMPORTANT

Audio-Visual material may consist of copyrighted works which must not be recorded without the authority of the owner of the copyright. Please refer to relevant laws in your country.

Getting Started

Description of Controls	3-5
Before Using Your VCR	6
Hook Up Your VCR	7-8
Turn On Your VCR	8
Set the Clock	9
Play a Tape	10
Record on a Tape	11
Record One Channel/See Another	12
On Screen Displays	13

Doing More

One Touch Recording (OTR)	14
Timer Recording	15-16
Special Playback Features	17-18
Re-Recording (Tape Duplication)	19
Tape Operation	20
Re-Setting Your VCR's Tuner	21

Information You May Need

Notes on Operations	22
Before Requesting Service	23-24
Specifications	24

What is a video recorder?

Simply, it is a machine which stores pictures and sound on magnetic tape. This VCR uses VHS cassettes, and since VHS is the most popular video system in the world, there are plenty to choose from. Suffice it to say that a cassette from another kind of VCR cannot be used on this VCR. Ensure that you only buy VHS cassettes of the best quality to get the best results from this VCR.

The VCR is a television receiver in its own right. When you record a TV program, it is being received by the video recorder, not by your TV set. This means that you can record one TV program on the VCR while you watch another which is being received by the TV set.

Your VCR has two big enemies: other electrical machines, and condensation. Read the instructions for installation carefully, with special regard to the proximity of other electrical devices, and make sure that you never, either during installation or ever in the future — put a cassette, still cold from your shopping basket or car, into the VCR without first letting it stand in the room for at least two hours to acclimatize.

Positioning

Do not place the VCR directly on top of, or underneath, your TV set. Ensure that there is at least 20 cm between the VCR and the TV set, and that air can circulate freely through the ventilation openings of the VCR.

Description of Controls 3

Front Panel

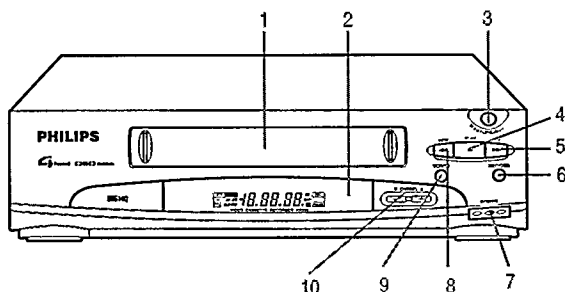

1 Cassette Compartment

Where the video cassette is inserted.

2 Wireless Remote Sensor

Receives the signal from the (wireless) remote control.

3 STOP/EJECT Button

Press to stop the tape. Press again after the tape has stopped to eject the cassette.

4 PLAY Button

- Press to play back a tape.
- Press to release the Slow or Search mode and return to playback.

5 FF (Fast Forward)/SEARCH Button

Press to move the tape forward rapidly. Also, during playback, press this button for rapid forward visual search.

6 REC/OTR Button

Press to start recording.

7 POWER Button

Press to turn the VCR (Video Cassette Recorder) on and off. To set the VCR for unattended recordings after timer settings have been completed.

8 REW(ind)/SEARCH Button

Press to rewind tapes. Also, during playback, press this button for reverse visual search.

9 VCR/TV Button

Press to select the signal source that your TV receives.

TV position

(VCR indicator on the display panel: OFF)

To watch TV or to watch one program while recording another.

VCR position

(VCR indicator on the display panel: ON)

To watch a tape, monitor a recording, or watch a TV broadcast selected with the VCR's channel selector.

10 CHANNEL UP/DOWN Buttons

Press to scan up or down through the VCR's channels.

VCR Display Panel

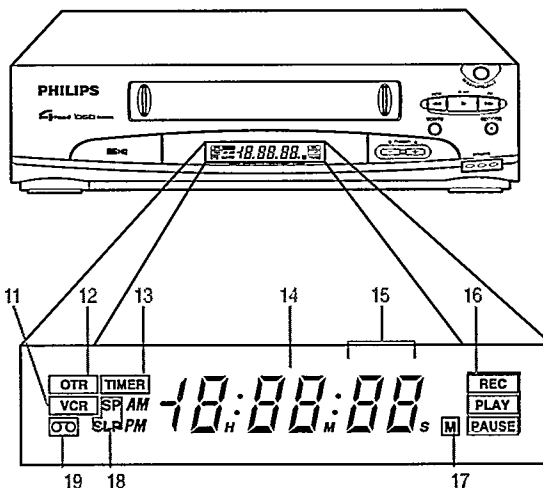

11 VCR Indicator

Lights up when the VCR mode is selected.

12 OTR Indicator

Lights up when the One Touch Recording (OTR) feature is in use.

13 Timer Indicator "TIMER"

Lights up when the VCR is set for unattended recording.

14 Digital Clock/Counter

After setting the clock, the present time is displayed.

15 Channel/Input Signal Indicator

Shows the channel number. ("L" means External Line Input Signal is selected.)

Select Line mode by pressing NUMBER buttons 0-0.

To exit Line mode, press any other number, for example, 0-2.

16 Mode Indicator

Displays which feature the VCR is currently performing.

REC - Recording

PLAY - Playback

PAUSE - Still, Slow, Record-Pause

17 Memory Indicator

Lights up when the Memory function is selected.

18 Speed Indicator "SP," "SLP"

Shows the tape speed during recording and playback ("SP" or "SLP").

SP - Standard Play

SLP - Super Long Play

19 Cassette-Inside Indicator

Lights up when there is a cassette in the unit.

4 Description of Controls (cont'd)

Rear Panel

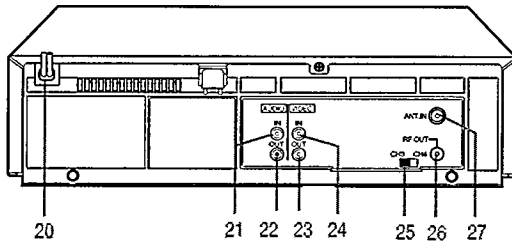

- 20 AC (Alternating Current) Power Cord
Connect the AC Power Cord to a household outlet.
- 21 AUDIO IN(put) jack
For audio input connection from the output jack of a portable video camera, another VCR, or another audio source.
- 22 AUDIO OUT(put) Jack
For connection to the audio input connector on a TV, another VCR, or an audio tape recorder.
- 23 VIDEO OUT(put) Jack
For video output connection to a TV or another VCR.
- 24 VIDEO IN(put) jack
For video input connection from the output jack of a portable video camera, another VCR, or another video source.
- x25CH3/CH4 Switch
Set to channel 3 or 4 (whichever is not used for regular TV broadcasting in your area) to use your TV as a screen for your VCR. See "Hook Up Your VCR."
- 26 RF OUT(put) Jack (out to TV set)
Use the supplied cable to connect this terminal to the UHF/VHF input terminal on your TV set.
- 27 ANT(enna) IN(put) Jack (in from Antenna)
Connect your antenna or cable to this terminal.

Remote Control Transmitter

TV Controls

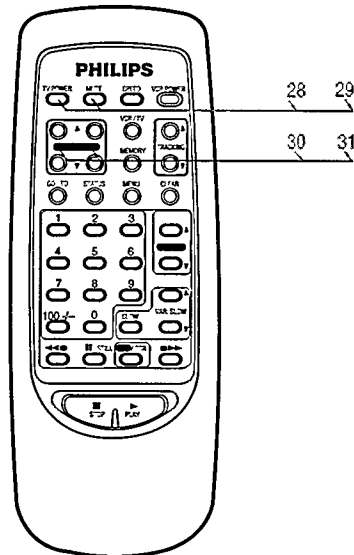

- 28 TV POWER Button *
Press to turn TV power ON or OFF.
- 29 MUTE Button *
Press to instantly reduce the TV's sound level. Press again to return to previous setting.
- 30 VOLUME UP/DOWN Buttons *
Press "▲" or "▼" to increase or decrease the TV's sound volume.
- 31 TV CHANNEL UP/DOWN Buttons *
Press "▲" or "▼" to scan up or down through the TV channels. Release at desired channel.

* NOTE: Only applicable for Philips TV.

Description of Controls (cont'd) 5

Remote Control Transmitter

VCR Controls

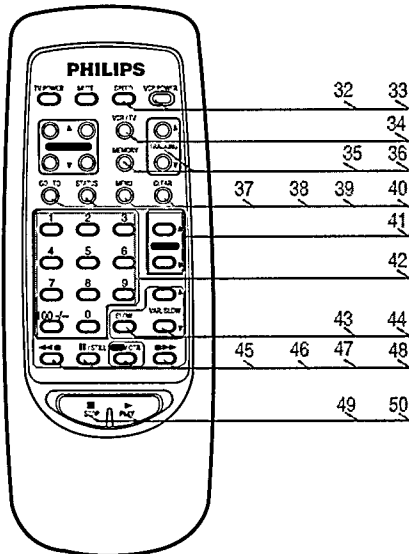

- 32 Tape SPEED Button**
Press to select recording speed (SP, SLP). In playback, the tape speed is automatically selected (SP, LP, SLP).
- 33 VCR POWER Button**
Press to turn VCR power ON or OFF. Also, used to set the VCR for unattended timer recording.
- 34 VCR/TV Button**
Press to select the signal source that your TV receives.
TV position
(VCR indicator on the display panel: OFF)
To watch TV or to watch one program while recording another.
VCR position
(VCR indicator on the display panel: ON)
To watch a tape, monitor a recording, or watch a TV broadcast selected with the VCR's channel selector.
- 35 MEMO(ry) Button**
Press to memorize the tape position at which the counter was reset to "0:00:00."
- 36 TRACKING Buttons**
In the Play and Slow modes, when playing a tape, press TRACKING "▲" or "▼" button to adjust the tracking.
- 37 GO-TO Button**
This button can make search easier by allowing you to skip back or ahead on a tape. Press this button and select desired counter number with NUMBER buttons, followed by PLAY/STOP button.
- 38 STATUS Button**
Press this button to display the time counter, time, function, and channel number.
- 39 MENU Button**
Press to call up the on-screen menu display.
- 40 CLEAR Button**
 - To erase incorrect or unwanted data in on-screen menu operation.
 - To reset the tape counter. "0:00:00" will appear on the TV screen.
- 41 VCR CH(annel) UP/DOWN.**
Press "▲" or "▼" to scan up or down through the VCR's channels. Release at desired channel.
- 42 NUMBER Buttons**
(0, 1, 2, 3, 4, 5, 6, 7, 8 and 9)
Use for channel selection, on-screen menu selection, clock setting, program setting, etc. For selecting channels 1 to 9, first press "0" button and then press "1" to "9." (100)
Press this button first when selecting channels 100 and higher.
- 43 SLOW Button**
Press during SP or SLP playback to view a slow-motion picture.
- 44 SLOW/VAR(iable) SLOW Buttons**
First press the SLOW button during SP or SLP playback to view a slow-motion picture. The speed can be varied from about 1/6 to about 1/30 of normal speed with the VAR(iable) SLOW button.
- 45 REW(ind)/SEARCH Button**
Press to rewind the tape at high speed. Also, during playback, press this button to view the picture in rapid reverse visual search.
- 46 PAUSE/STILL Button**
 - Press once to temporarily stop the tape during recording (Pause).
 - Press once to freeze the tape picture during playback (Still).
 - Press again when you want to resume normal playback or recording.
- 47 REC/OTR Button**
Press to start recording. Select the channel and press this button to start an immediate recording 30 minutes to 9 hours long. Each press delays the shut-off time by 30 minutes. Power shut off is automatic.
- 48 FF (Fast Forward)/SEARCH Button**
To move the tape forward at high speed. Also, during playback, press this button for rapid forward visual search.
- 49 STOP Button**
Press to stop the tape.
- 50 PLAY Button**
 - Press to play back a tape.
 - Press to release the Slow or Search mode and return to playback.

6 Before Using Your VCR

1 Load The Batteries as Follows:

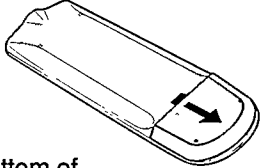
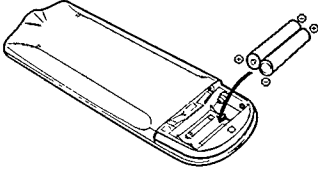
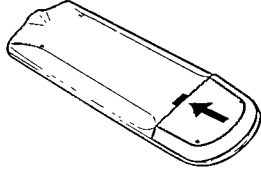
<p>1 Remove the Battery Compartment lid from the bottom of the remote control.</p>  <p>Bottom of Remote Control</p>	<p>2 Install two batteries as indicated inside the Battery Compartment.</p> 	<p>3 Replace the lid.</p> 
---	--	---

Battery Replacement Caution

- Do not mix old and new batteries. (Also never mix alkaline batteries with manganese batteries.)

NOTE: This remote control and batteries are supplied accessories. Please check to make sure they are included. Also, check the Specifications to see what other accessories are included.

2 Types of Video Cassettes and Tape Speeds

You can change the recording speed for a tape using the Tape SPEED button.

- 2 Recording speeds: SP, SLP
- 3 Playback speeds: SP, LP, SLP

In this VCR, use only tapes with the **VHS** mark. The chart below shows the recording/playback time for 3 types of tapes (T160, T120, T60).

Tape Speed Selector Position	Type of Tapes	Maximum Record/Playback Time		
		T160	T120	T60
SP (Standard Play)		2 Hours 40 Minutes	2 Hours	1 Hour
LP (Long Play)(Playback only)		5 Hours 20 Minutes	4 Hours	2 Hours
SLP (Super Long Play)		8 Hours	6 Hours	3 Hours

* During Playback, the VCR selects the tape speed, SP, LP, or SLP, automatically.

3 Erase Protection

Cassettes have a Record Tab to ensure that recordings are not accidentally erased.

- To prevent accidental erasure:

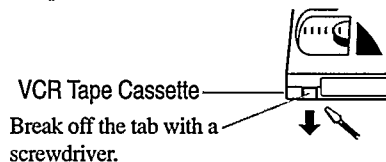

- To record again:

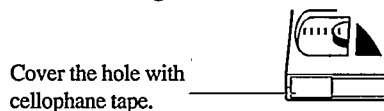

4 Please Read and Relax

Please read all the instructions for each feature before attempting that feature. For example, read all the steps for Timer Recording (pages 15–16) before doing a Timer Recording.

Now, turn the page to begin hooking up your VCR.

Hook Up Your VCR 7

1 VCR to TV Connection

Step 1: Disconnect the Antenna or Cable from Your TV.

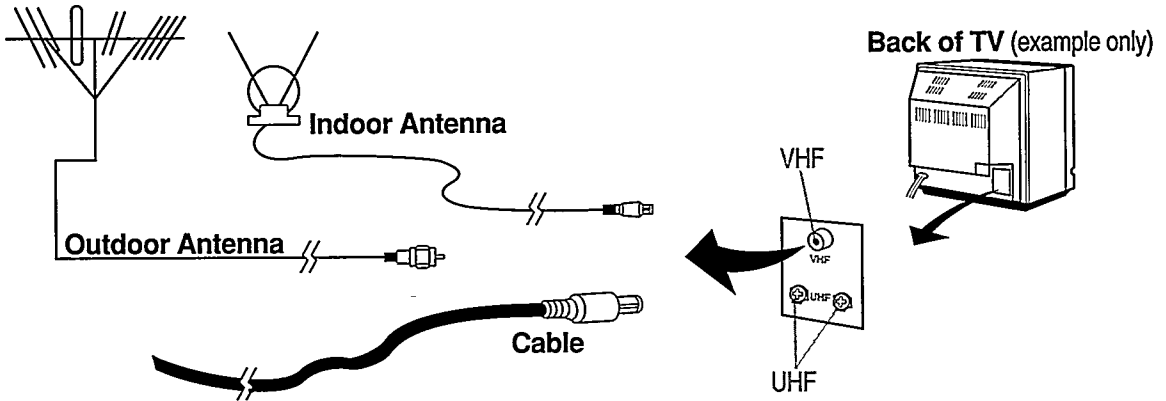

Step 2: Connect Your Antenna or Cable to Your VCR.

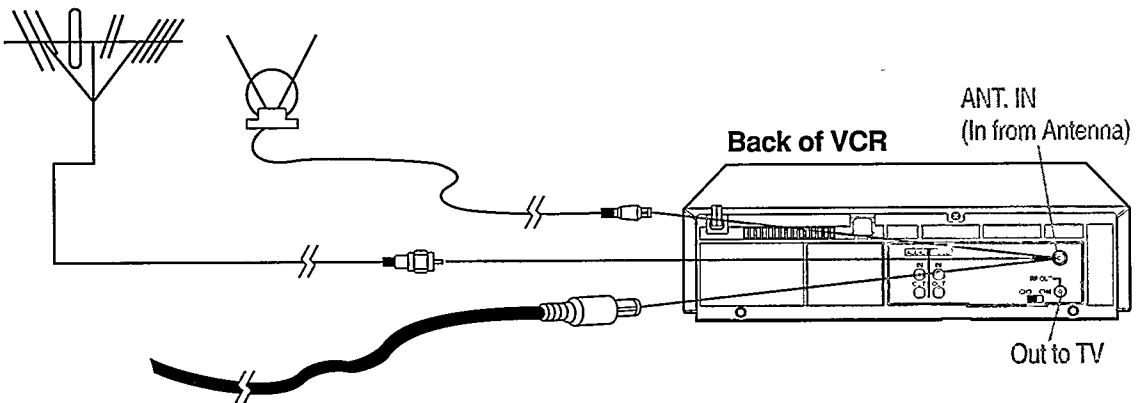

Step 3: Connect Your VCR to Your TV.

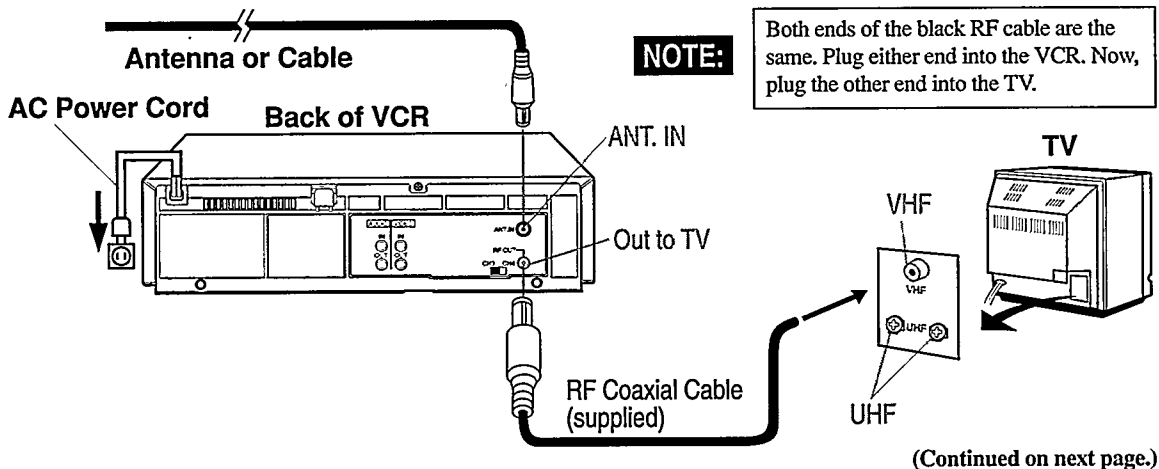

8 Hook Up Your VCR (cont'd)

2 Select Channel 3 or 4

Set the CH3/CH4 switch on the back of the VCR to channel 3 or 4. To operate the VCR with your TV, set your TV to the same channel. For example, if your switch is set to channel 3 (CH3), turn your TV to channel 3.

To avoid local interference, the CH3/CH4 switch position you choose should correspond to the local TV channel that is not used or least used.

If both are used, select the channel that gives you the best picture when playing a tape.

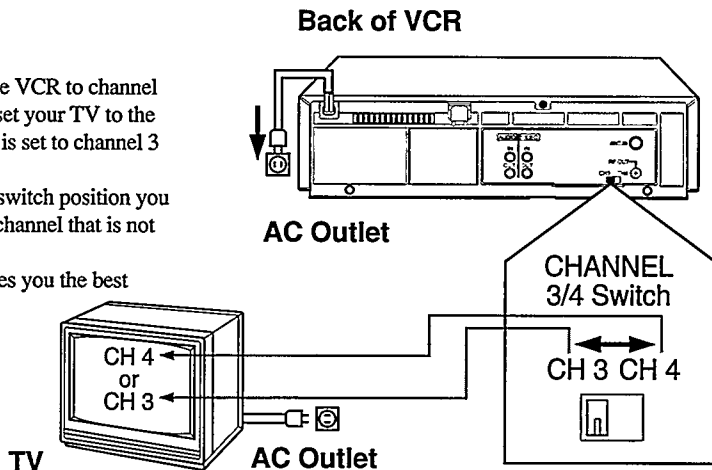

Now, turn ON the VCR's power to see if you have made the right connections.

Turn On Your VCR

Make sure ...

the batteries are loaded in the remote control and the connections have been completed before continuing to the steps below.

At the TV

- 1 Turn the TV on. Set the TV to the same channel as the switch on the back of the VCR (CH3/CH4).

Choose Your Language

Press the VCR POWER button.

- The VCR (Video Cassette Recorder) Power will come on.

- 2 The language select menu appears, asking you whether you prefer to have messages displayed on your TV screen in English or in Spanish.

Press the NUMBER 1 button if you want English.

Press the NUMBER 2 button if you want Spanish.

Press the MENU button to continue to the next step.

- To change your selection later on, see the instructions on page 13.

TO SELECT PUSH NO. SHOWN

- 1 ENGLISH [ON]
- 2 ESPAÑOL

MAKE SELECTION OR PUSH MENU TO CONTINUE

Setting the VCR's Tuner

- 3 Press the VCR CH(annel) UP button to start automatic tuner setting.

- "AUTO SET PROCEEDING, PLEASE WAIT" will be displayed on the TV screen. If you made all connections properly, the local channels that are receivable in your area will be automatically placed in your VCR's tuner.

(If the tuner has already been set, press the STOP button.)

- When completed, "AUTO SET COMPLETED" will be displayed and the VCR will tune in to the lowest receivable channel.

- If proper antenna or cable connections were not made, "NO TV SIGNALS" will be displayed. Please make connections and press the VCR CH(annel) UP button again.

AUTO SET PROCEEDING
PLEASE WAIT

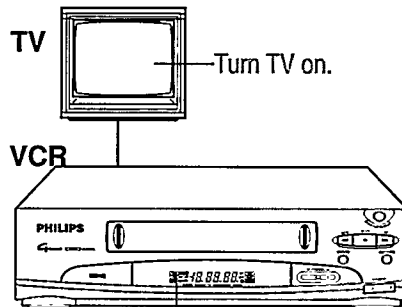

VCR Indicator

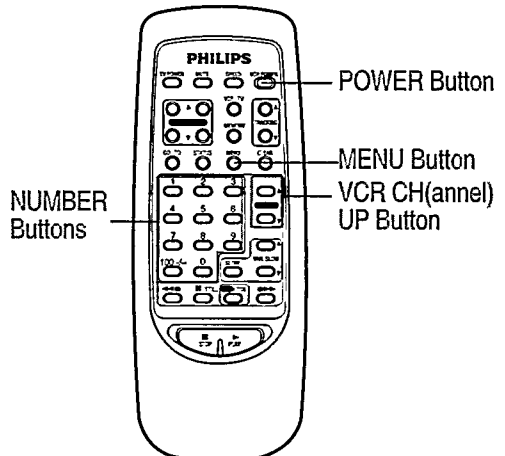

Remote Control

Now, turn to the next page and set the VCR's clock

Set the Clock 9

To set your VCR to the present day and time, follow steps 1 – 4 below. Once set, your VCR (Video Cassette Recorder) will maintain the time in its internal clock, and will make timer recording possible.

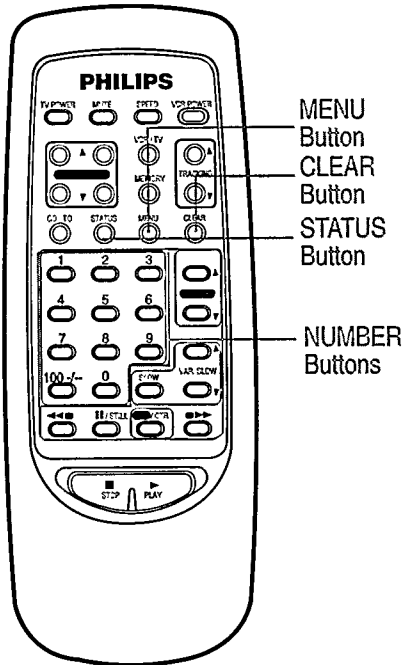

Remote Control

Make sure ...

- your VCR and TV are connected and turned on.
- the VCR indicator says "VCR".
- to make each entry within 10 seconds, otherwise the VCR will exit the Clock Set mode and you will have to start over.

1 Select the Clock Set Mode

- 1 Press the MENU button. Then press the 5 button to select "CLOCK SET" from the menu screen.

TIME ✨----

TO END PUSH MENU

2 Set the Time & AM or PM

- 2 First, press two NUMBER buttons for the hour, then two NUMBER buttons for the minutes, and finally press "1" for AM or "2" for PM. For example, for 10:30 PM, press the NUMBER buttons 1-0, 3-0, 2.
- When setting the clock for the first time, entries that do not match the VCR's internal calendar will cause a "?" to appear.
 - Always enter "0" before any single-number entries.
 - To make corrections, press the CLEAR button repeatedly to move back to an item then enter the correct number.

3 Set the Month, Day & Year

- 3 Press two numbers for the month, two numbers for the day, and two numbers for the year. For example, for July 1, 1995, press the NUMBER buttons 0-7, 0-1, 9-5.

TIME 10:30 PM

MONTH ✨/ /

TO CORRECT PUSH CLEAR
TO END PUSH MENU

TIME 10:30 PM

DATE 07/01/95
SAT.

TO CORRECT PUSH CLEAR
TO END PUSH MENU

4 Start the Clock

- 4 Press the MENU button.
- Clock starts and the screen returns to the program you were on.
 - To display the time, press the STATUS button.

To Reset the Clock

Press the MENU button. The TV and VCR must be on and the VCR in the "VCR" mode. The menu screen will appear. Press the NUMBER 5 button and follow the clock set guide to re-enter the new date and time.

TO SELECT PUSH NO. SHOWN

- 1 PROGRAM
- 2 VCR SET UP
- 3 TUNER SET UP
- 4 INPUT SELECT
- 5 CLOCK SET

TO END PUSH MENU

Power failures can cause you to lose your clock setting placed in the VCR's memory. Should this happen, repeat steps on pages 8 and 9 before doing anything else.

Your VCR should now be properly set-up. Go to the next page and try playing a tape.

10 Play a Tape

To play a tape, follow steps 1 – 4 below.

Make sure ...

the batteries are loaded in the remote control and the connections on pages 7 and 8 have been completed before continuing to the steps below.

At the TV

- 1 Turn the TV on. Set the TV to the same channel as the switch on the back of the VCR (CH3/CH4).

At the VCR

- 2 Insert a cassette.*
 - The VCR Power will come on.

Start Playback

- 3 Press the PLAY button.
 - The VCR mode is automatically set. "VCR" indicator will light.

Stop Playback

- 4 Press the STOP/EJECT button to stop playback.
 - Press the REW(ind) button to fully rewind the tape.
 - Press the STOP/EJECT button again to remove the tape.

- * If a cassette's record tab is removed, playback starts automatically.
- If a cassette is already in the VCR, just press the POWER button.

Now, turn to the next page and learn how to record a TV program.

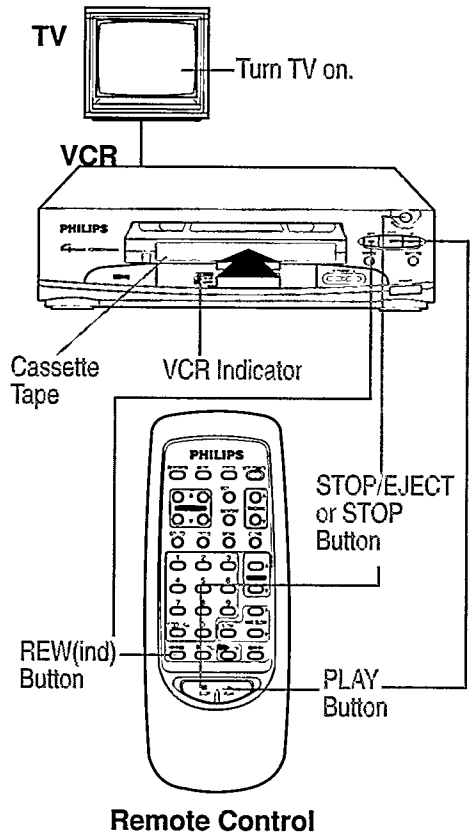

Record on a Tape 11

To record on a cassette tape, follow steps 1 – 7 below. Read all the instructions before starting. You must use your remote control.

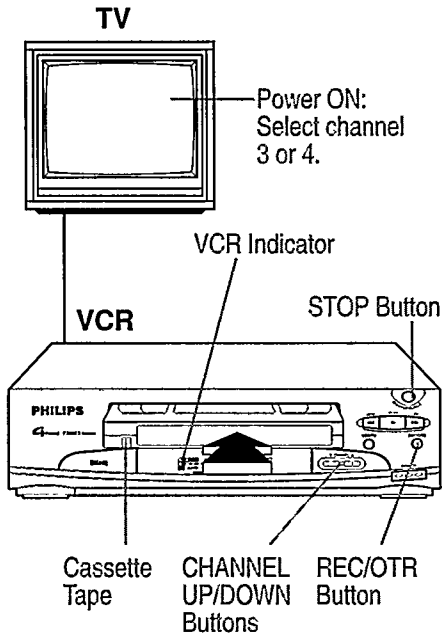

Make sure ...

the steps in "Hook Up Your VCR" on pages 7 – 8 have been completed.

At the TV

- 1 Turn the TV on. Turn to channel 3 if the VCR CH3/CH4 switch is set to "CH3." Turn to channel 4 if the VCR is set to "CH 4."

At the VCR

- 2 Insert a cassette with the record tab in place. The power will come on. If the cassette is already in the VCR, press the POWER button. If the VCR display lights on the VCR, do nothing. If it isn't, press the VCR/TV button.

Choose the Tape Speed

- 3 (You may skip this step if the desired tape speed is already selected.) Press the Tape SPEED button on the remote control until the desired tape speed (SP, SLP) appears on the TV screen.

Choose the Channel

- 4 Press the VCR CH(annel) UP/DOWN or NUMBER buttons to select the channel to be recorded.

Start Recording

- 5 Press the REC/OTR button.

Pause Recording

- 6 To pause, press the PAUSE/STILL button. To continue recording, press this button again.

Stop Recording

- 7 To stop, press the STOP button.

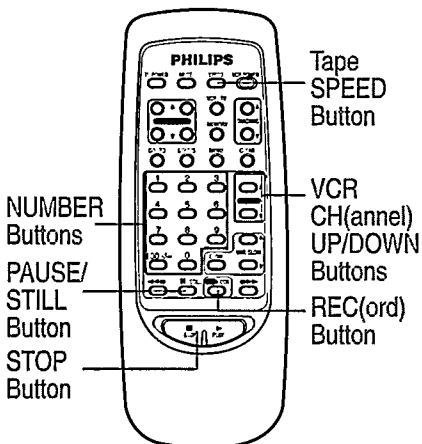

Remote Control

Other recording options are available on pages 14–16, 19.

Now, go to the next page and learn how to record one channel while watching another.

12 Record One Channel/See Another

To record one channel while viewing another, follow steps 1 – 4 below. Please read all the instructions. You must use your remote control.

1 Start a Recording

Start a recording as described on page 11.

2 Set the VCR/TV Button

Press the VCR/TV button to select the TV mode. The VCR indicator disappears.

3 Select the Channel at the TV for Viewing

Select the channel to be viewed at the TV, using the channel controls on the TV or TV remote control.

The channel selected with the TV channel controls appears on the TV screen. The channel selected with the VCR channel control is recorded on the tape.

4 To Return to the Channel Being Recorded

First, using the channel controls on the TV or TV remote control, return the TV to either channel 3 or 4 (Please see "Hook Up Your VCR.")

Now, press the VCR/TV button to view again the channel being recorded.

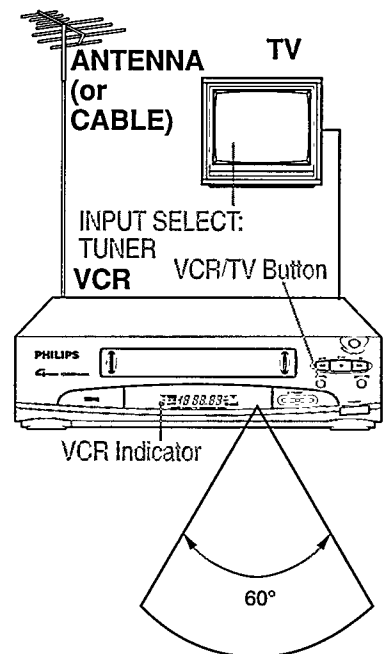

VCR/TV Button

VCR CH(annel) Buttons

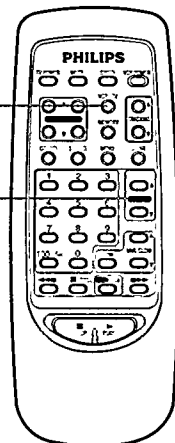

Remote Control

* If you are not receiving channels, please repeat the steps on page 7 – 8 of this book. Also, follow carefully the instructions listed above.

Point the transmitter toward the remote sensor, within the angle shown in the illustration above.

NOTE:

If you use a converter box or satellite system hook-up, you may not be able to do this feature.

Congratulations! You've taken many steps. Now, turn to the next page and find out a little more about your VCR and remote control.

On-Screen Displays (OSD) 13

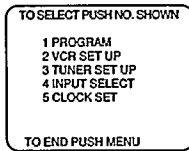

Main Menu

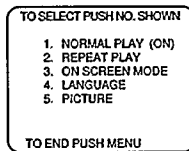

VCR Set Up

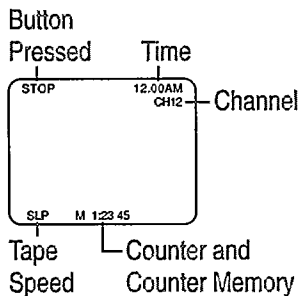

VCR Status Display

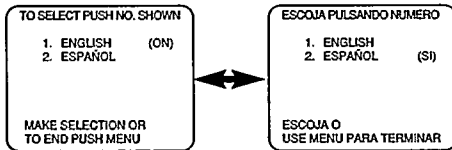

Language Selection Menu

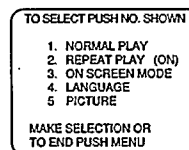

Repeat Playback Selection

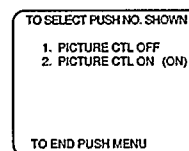

Picture Control

OSD Main Menu Screen

Press the MENU button on the remote to display the main menu screen. Then press the NUMBER button on the remote control for the desired feature displayed on the menu. When you select a feature, turn to the section in this manual and read the accompanying instructions.

VCR Status Display

1. Press the MENU button.
2. Next, press the 2 button to select "VCR SET UP."
3. Then, press the 3 button to select "ON SCREEN MODE."
4. Now, press the 1, 2, or 3 button to select "ON SCREEN ON," "COUNTER ONLY" or "ON SCREEN OFF."
"[ON]" appears beside the selection made.

POSITION

ON SCREEN ON: Whenever a function button (Stop, FF, etc.) is pressed, a 5 second VCR Status Display appears.

COUNTER ONLY: Whenever a function button (Stop, FF, etc.) is pressed, a 5 second VCR Status Display appears.

After 5 seconds, the counter information will remain on the screen.

ON SCREEN OFF: In this position, there will be no indication when normal functions are pressed.

OSD Language Select

1. Press the MENU button.
2. Next, press the 2 button to select "VCR SET UP."
3. Then, press the 4 button to select "LANGUAGE."
4. Now, press the 1 or 2 button to select "ENGLISH" or "SPANISH."
All OSD (On-Screen Displays) will appear in the language you select. "[ON]" will appear beside the selection if you choose English and "[SI]" will appear if you choose Spanish.

Repeat Playback

1. Press the MENU button.
2. Next, press the 2 button to select "VCR SET UP."
3. Then, press the 2 button to select "REPEAT PLAY."
"[ON]" will appear beside the selection.
 - The PLAY light on the display panel will blink.
 - The tape will be played all the way to the end, 20 times automatically and then stop.
 - When the STATUS button is pressed during Repeat Playback, "PLAY" blinks on the TV screen.
 - To stop the tape during Repeat Playback, press STOP.

Picture Control

To get a better picture when viewing tapes with noise such as rental tapes.

1. Press the MENU button, and next press the 2 button to select "VCR SET UP".
2. Then, press the 6 button to select "PICTURE," and now press the 2 button to select "PICTURE CTL ON."

14 One Touch Recording (OTR)

To set the VCR (Video Cassette Recorder) to automatically shut off after recording is completed, follow steps 1–3 below. OTR lets you quickly specify how long you want recording to continue. You don't have to program the timer with this function. **You must use your remote control.**

Make sure ...

- the steps in "Hook Up Your VCR" are done, channels are programmed into the VCR's memory, and the TV and VCR are both turned on.
- the clock is set to the correct time.
- the desired tape speed (SP, SLP) is selected. Use the tape SPEED button.
- the record tab is in place on the cassette.
- the tape is long enough to record the programs.

1 Choose a TV Program

Press the VCR CH(annel) UP/DOWN or NUMBER buttons on the remote control.

2 Start an OTR

Press the OTR button twice on the remote control. The screen below appears.

- Recording begins immediately.
- OTR will flash on the VCR display.

This indicates that the VCR will automatically shut off after 30 minutes of recording.

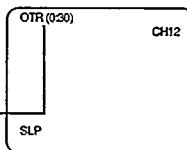

3 Select a Recording Length

Continue pressing the OTR button until the desired recording length is displayed.

Each press of the button will add 30 minutes, up to 9 hours. If pressed beyond 9 hours, "REC" appears on the TV screen.

- To check time remaining after an OTR has been set, press the STATUS button.

To Change the Recording Length

Press the OTR button until the desired length is displayed.

To Cancel an OTR

To stop recording before the preset recording length is reached, simply press the STOP button. If you want to cancel the OTR mode but continue recording, press the OTR button several times until the OTR indicator disappears. "REC" remains on the VCR Display Panel.

- During recording, the displayed time counts down. When 0:00 is reached, recording stops and the power is switched off automatically.
- If OTR is engaged in the Record-Pause mode, the timer will count down normally, but recording will not begin until the PAUSE/STILL button is pressed.

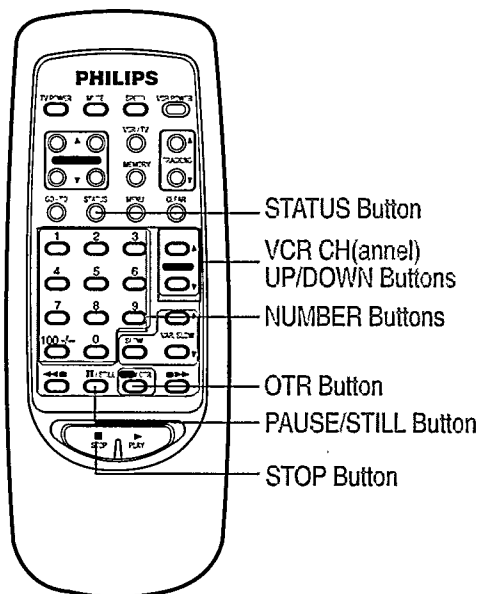
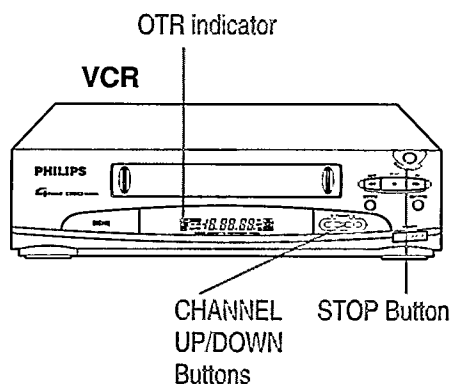

Remote Control

Timer Recording 15

To record while you're away, follow steps 1–12 below. For each program you set, the VCR will turn itself on, do the recording, and turn off automatically. You can store up to eight programs. Instructions for each step appear on the TV screen after you begin. You must use your remote control.

Make sure ...

- the steps in "Hook Up Your VCR" have been completed, an antenna or cable system is connected to the VCR, and the VCR and TV are turned on.
 - CABLE or NORMAL has been selected and channels have been programmed into the VCR's memory. See "Turn On Your VCR" and "Adding/Deleting a Channel".
 - the TV/VCR selector is set to "VCR."
 - the clock is set to the correct time.
 - a cassette tape is inserted in the VCR and the record tab is in place on the cassette.
 - the tape is long enough to record the programs.
- FOR EACH STEP BELOW, YOU HAVE 60 SECONDS TO COMPLETE IT. IF YOU DON'T, PROGRAMMING WILL HAVE TO BE RESTARTED FROM STEP 1.**

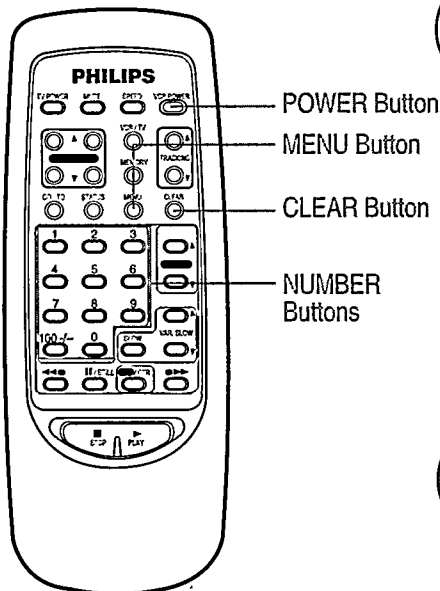
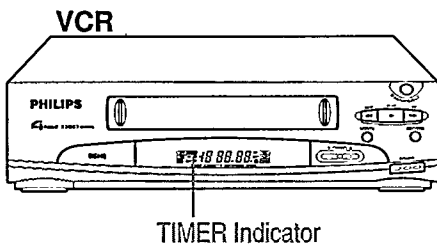

Remote Control

1 Select the Menu Screen

Press the MENU button on the remote control. The main menu screen at right will appear.

TO SELECT PUSH NO. SHOWN

1 PROGRAM
2 VCR SET UP
3 TUNER SET UP
4 INPUT SELECT
5 CLOCK SET

TO END PUSH MENU

2 Select the Program Mode

Press the NUMBER 1 button on the remote control to select the Program mode. Remember, use the NUMBER buttons on your remote control.

3 Select Normal, Daily or Weekly Recording

Normal Recording
Press the 1 button to record a TV show on any day you choose up to 12 months away.

Or

Daily Recording
Press the 2 button to record a TV show every day (Monday through Friday) at the same time and length.

Or

Weekly Recording
Press the 3 button to record a TV show once a week at the same day, time, and length.

TO SELECT PUSH NO. SHOWN

1 ONCE
2 DAILY
3 WEEKLY
4 PROGRAM REVIEW

TO END PUSH MENU

DAILY PROGRAM, (MON-FRI)
PROGRAM-1 2 3 4 5 6 7 8

SELECT PROGRAM NUMBER
TO END PUSH MENU

WEEKLY PROGRAM
PROGRAM-1 2 3 4 5 6 7 8

SELECT PROGRAM NUMBER
TO END PUSH MENU

4 Select the Position

Press the NUMBER buttons 1–8 to select one of the 8 positions to store a timer record program. The flashing numbers indicate an open position where a program can be stored.

- If you select a position number that has already been set, "PREVIOUSLY SET PROGRAM" appears for a few seconds, then the position contents will be displayed. If this happens, press the MENU button twice and start over.

PREVIOUSLY SET PROGRAM

To Make Corrections...

Press the CLEAR button while the screen you wish to change is displayed. This moves the flashing indicator to the number you want to change. Now, enter the correct number. You may have to press the CLEAR button more than once to reach the numbers you want to change.

5 Select the Channel

Enter two numbers for the TV channel. For channels above 100, press the 100 button, then two numbers for the channel. For example, for channel 10, press NUMBER button 1, then 0. Or, for channel 115, press 100, then press 1 and 5. To record from line input, press 0 and 0. "A/V IN" will appear on the screen.

ONE TIME PROGRAM PROGRAM CHANNEL

TO CORRECT PUSH CLEAR
TO END PUSH MENU

(Continued on next page.)

16 Timer Recording (cont'd)

Select the "TIME ON"

6 First, press two NUMBER buttons for the hour.
Next, press two NUMBER buttons for the minute.

Now, press NUMBER button "1" for AM or "2" for PM.

For example, for 9:30 PM, press NUMBER buttons 0-9, 3-0, 2.

```
NORMAL PROGRAM
PROGRAM 1
CHANNEL 10
TIME ON 9:30 PM
```

TO CORRECT PUSH CLEAR
TO END PUSH MENU

Select the "TIME OFF"

4 First, press two NUMBER buttons for the hour.
Next, press two NUMBER buttons for the minute.

For example, for 10:00 PM, press 1-0, 0-0, 2.

```
NORMAL PROGRAM
PROGRAM 1
CHANNEL 10
TIME ON 09:30 PM
TIME OFF 10:00 PM
```

TO CORRECT PUSH CLEAR
TO END PUSH MENU

Select the Recording Speed

8 Press the 1 or 2 button to choose SP (Standard Play) or SLP (Super Long Play).

You cannot use the SPEED button on the remote control to choose the recording speed.

```
NORMAL PROGRAM
PROGRAM 1
CHANNEL 10
TIME ON 09:30 PM
TIME OFF 10:00 PM
REC SPEED SP
SP = 1 SLP = 2
```

TO CORRECT PUSH CLEAR
TO END PUSH MENU

Select the "START DATE"

9 First, press two NUMBER buttons for the month.
Next, press two NUMBER buttons for the day.
For example, to make a recording on July 1, press 0-7, 0-1.

The year and day of the week will be displayed automatically.

```
NORMAL PROGRAM
PROGRAM 1
CHANNEL 10
TIME ON 09:30 PM
TIME OFF 10:00 PM
REC SPEED SP
START DATE 07/01/95
SAT.
```

TO CORRECT PUSH CLEAR
TO END PUSH MENU

Confirm Your Program

10 Press the MENU button.
"PROGRAM WAS COMPLETED" should appear on the screen.
If "PROGRAM NOT COMPLETED" appears, please try again from step 1 on page 15.

After 3 seconds, the display will disappear from the screen, and the normal TV picture will reappear.

The TIMER indicator will light up on the VCR.

Select the Next Program

11 If needed, press the MENU button and repeat steps 2 to 10.

Set the Timer

12 When finished, press the POWER button to OFF on the remote control.

After a Timer Recording Has Taken Place

Press the POWER button on the remote control to return your VCR (Video Cassette Recorder) to normal operation.

If the Power Should Fail...

repeat the steps on pages 8 and 9 before setting up a Timer Recording.

Check or Clear Timer Recordings

1. Turn the VCR on. VCR must be in VCR mode.

2. First, press the MENU button.
Next, press the 1 button to select "PROGRAM."

Now, press the 4 button to select "PROGRAM REVIEW."

The Timer Record information for the lowest numbered position (1 - 8) appears.

```
NORMAL PROGRAM
PROGRAM 1
CHANNEL 10
TIME ON 09:30 PM
TIME OFF 10:00 PM
REC SPEED SP
START DATE 07/01/95
SAT.
```

TO CANCEL PUSH CLEAR
NEXT=1 END=MENU

3. Press the 1 button repeatedly to view all the filled positions.

If you do not press the 1 button, after 10 seconds the display changes to the next filled position. This continues until all filled positions appear. Finally, the screen returns to the previous on-screen menu.

4. Press the CLEAR button to clear a filled position.

5. At any time, press the MENU button once to exit the Program Review mode.

6. Repeat steps 1 - 4 to make sure you have cleared the correct filled positions.
To fill a position, follow "Timer Recording" steps 1 - 12.

NOTE: This function does not work with OTR (One Touch Recording).

Stop a Started Timer Recording

1. Press the POWER button.

- Timer recording is cancelled and VCR power turns off.

Today's recording stops. If it is a Daily or Weekly recording, future recordings will be carried out as programmed.

Special Playback Features 17

Is your VCR (Video Cassette Recorder) connected to your TV (see "Hook Up Your VCR")? Are you familiar with tape playback (see "Play a Tape")? If so, you are ready to enjoy the special playback features described on this page. These features work best in the SP (Standard Play) or SLP (Super Long Play) mode. You must use your remote control.

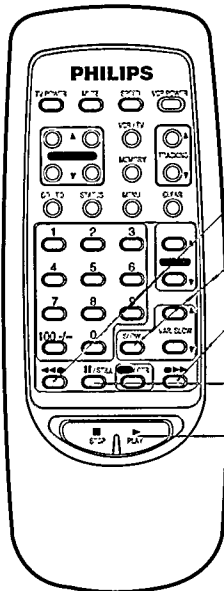

Remote Control

To Rapidly Locate a Particular Segment

- 1 First, press the PLAY button.
Next, press the REW(ind)/SEARCH or FF (Fast Forward)/SEARCH button.
A rapid forward or reverse picture search begins.
Search speed in SP mode is about 7 times the normal speed.
Search speed in SLP mode is about 21 times the normal speed.
- 2 Now, press the PLAY button to return to playback.
If the FF or REW button is held down for more than 2 seconds, simply releasing it will cancel the Search mode. In this case, the search speed in SLP mode is about 15 times normal speed.
Press the PLAY button to return to playback.
 - During search playback, some noise bars will appear on the TV screen.

To View a Still Picture (During Playback)

- 1 First, press the PLAY button.
Next, press the PAUSE/STILL button.
A freeze frame (still) playback image appears.
- 2 Now, press the PAUSE/STILL or PLAY button again to release the stilled image and continue playback.

To View a Slow Motion Picture

- 1 First, press the PLAY button.
Next, press the SLOW button.
 - During slow motion the slow speed can be controlled using the VAR(iable) SLOW button.
- 2 Now, press the PLAY or SLOW button to release the Slow mode and continue playback.

NOTES:

- The sound will be muted during special-effects playback.
- Slow Motion and Still automatically switch to the Stop mode after 5 minutes to protect the tape and video heads.

(Continued on next page.)

18 Special Playback Features (cont'd)

Auto Operation Functions

Auto Playback

When a tape is inserted, the power comes on.
If the record tab* is removed, playback begins.

Auto Rewind

When a tape reaches its end during playback, fast forward, or manual record, the VCR rewinds the tape and goes into Stop mode.

Memory Rewind Power Off

When the POWER button is pressed during rewind, the VCR will turn off after rewind is complete.

Eject Cassette

A cassette may be ejected with power on or off.

* For record tab information, refer to page 6.

Auto Tracking Control

With Auto Tracking there is usually no need for manual adjustments to minimize noise in playback for most tapes. Auto Tracking continuously analyzes the signal to adjust for optimum picture quality for each recording. However, with some recordings you may get a better result using the TRACKING UP/DOWN buttons.

Manual Tracking Controls

Press the TRACKING UP/DOWN button.
Use Manual Tracking adjustment during playback, slow motion, and double speed playback to minimize noise in the picture.

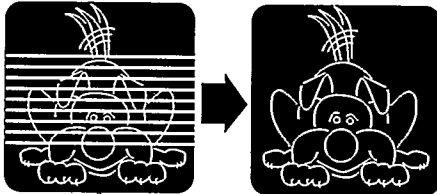

Also, use these buttons to reduce jitter in a still picture. Once you make this adjustment, you probably will not have to do it again – unless you select Still mode while playing a tape recorded on a different VCR.

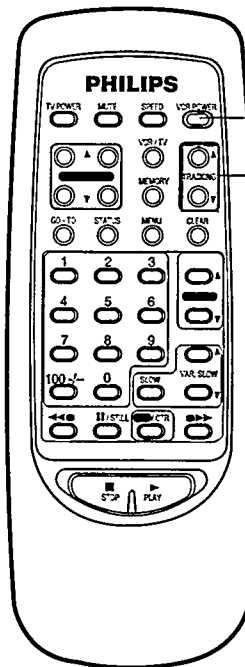

POWER Button

TRACKING
UP/DOWN Buttons

Remote Control

Re-Recording (Tape Duplication) 19

Dubbing from any VHS recorder (or camcorder) to another is simple. Just use the connections and steps below. The example below uses two VCRs like this one. Other VCRs may operate differently.

CONNECTIONS 1

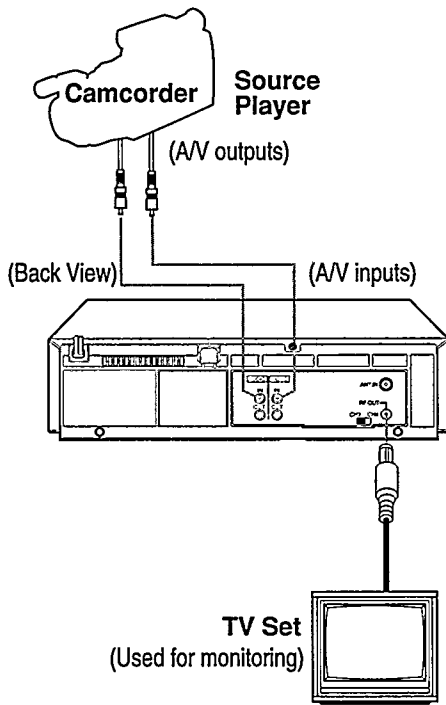

- At VCR 1**
 - 1 Insert a pre-recorded tape. VCR 1 is the VCR (Video Cassette Recorder) that will play your tape. If the record tab is missing (page 6), playback starts. In that case, press the stop button.
- At VCR 2**
 - 2 Insert a blank tape in the editing VCR. The VCR will turn on automatically. The VCR indicator light on the VCR should come on. If not, press the VCR/TV button on the remote control.
- To Monitor the Re-Recording Process On Your TV**
 - 3 Turn the TV on.
Turn the TV channel to either 3 or 4, whichever channel VCR 2 is set to (see page 8).
- Select Input Source**
 - 4 Point your remote control at VCR 2. Press 0-0 on the NUMBER buttons. "L" appears on the VCR display panel.
- Select Tape Speed**
 - 5 Point your remote control at VCR 2. Press Tape SPEED button to select SP (Standard Play) or SLP (Super Long Play).
- Play Back the Tape**
 - 6 Press the PLAY button on VCR 1.
- Record (Copy) the Tape**
 - 7 Press the REC/OTR button on VCR 2.
Remember: press the buttons in steps 6 and 7 simultaneously to avoid missing any of the recording.

CAUTION

Unauthorized recording of copyrighted television programs, films, video tapes, and other materials may infringe on the rights of copyright owners and be contrary to copyright laws.

CONNECTIONS 2

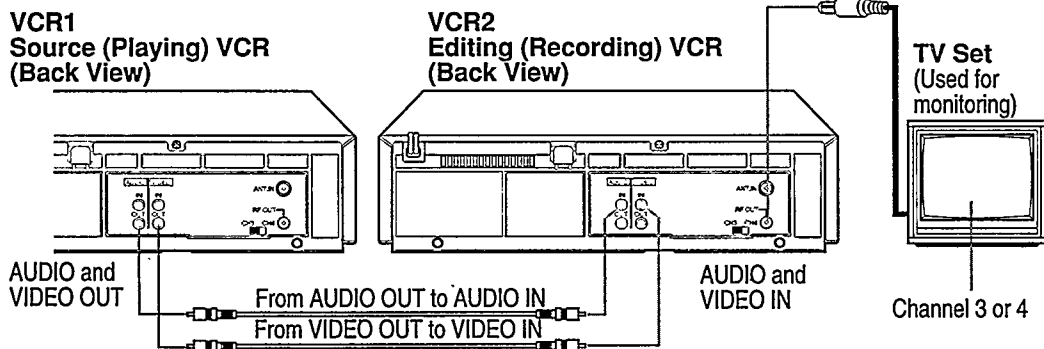

20 Tape Operation

Tape Counter Control

If you always rewind your tapes fully and reset the tape counter, then you'll be able to use a list of program locations as an index. You must use your remote control.

- 4 Select the Tape Counter Display**

To select the tape counter display, press the STATUS button. The tape counter display appears on the TV screen.

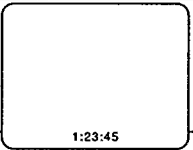
- 2 Reset the Tape Counter**

To reset the tape counter, press the CLEAR button. You can reset the counter to zero at whatever point on the tape you choose.

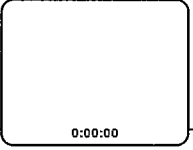

- 3 Select the Memory Function**

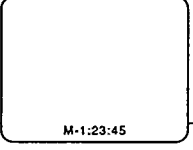
To select the memory function, press the MEMO(ry) button. "M" will appear on the screen in front of the counter reading.

- 4 Start the Memory Function**

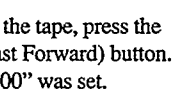
To start the memory function, from anywhere on the tape, press the STOP button, then press the REW(ind) or FF (Fast Forward) button. The tape will stop automatically wherever "0:00:00" was set.

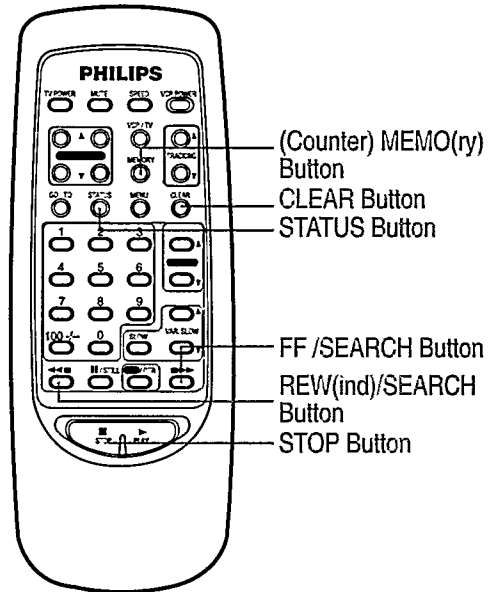



Remote Control

Go-To Function

You can have your VCR automatically "go to" and locate the point on the tape with the counter reading that you specify. You must use your remote control.

- 1 Select the Go-To Function**

While in the Stop mode, press the GO-TO button.

* The screen at right appears.

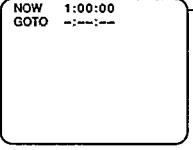
- 2 Select the Counter Number**

Select the desired counter number by pressing the NUMBER buttons. For example, by pressing 1, 2-0, 0-0, the VCR will automatically go to the point with counter reading "1:20:00."

If the counter location you want has a minus (-) before it, you can enter the minus by pressing the VCR CH(annel) DOWN button. To remove the minus, press the VCR CH(annel) UP button.

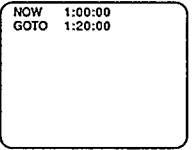
- 3 Start the Go-To Function**

Press the PLAY or REC or STOP or VCR POWER button. The Go-To function will Fast Forward or Rewind to the counter number, and depending on which button you pressed, will enter that mode.

PLAY button = Will begin playback at that point.
 REC button = Will begin recording at that point.
 STOP button = Will stop at that point.
 VCR POWER button = Will turn the VCR's power off at that point.

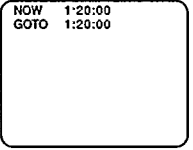

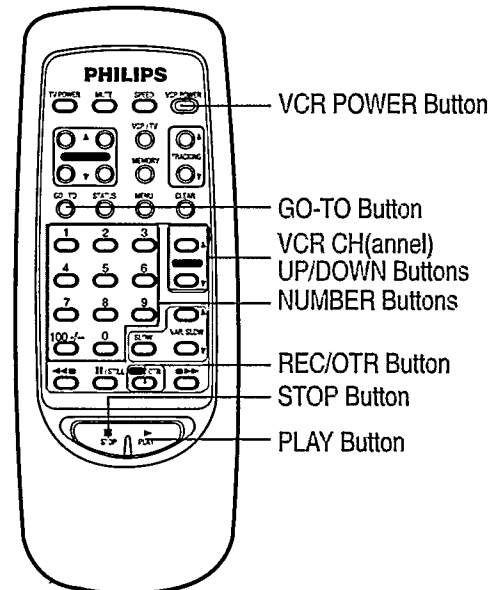

Remote Control

Re-Setting Your VCR's Tuner 21

To place receivable channels in your VCR (Video Cassette Recorder), follow steps 1–4 below. This function lets you re-program your VCR's tuner at any time. With the Add/Delete feature you can add or delete any channel. You must use your remote control.

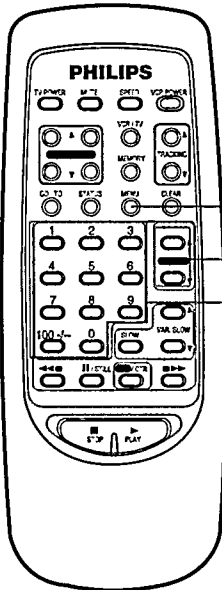

Remote Control

Make sure ...

- the steps on pages 7–8 have been completed, and your TV and VCR are on.
- to make each entry within 60 seconds, otherwise the VCR will exit the Tuner Set Up mode and you will have to start over.

Display the Tuner Set Up Mode

- 1 First, press the MENU button to display the main menu screen. Now, press the NUMBER 3 button to select "TUNER SET UP." The screen at right appears.

TO SELECT PUSH NO. SHOWN

1 TV	[ON]
2 CABLE TV	
3 AUTO PROGRAMMING	
4 ADD/DELETE CH	
5 CH MEMORY REVIEW	

TO END PUSH MENU

Start Auto Program

- 2 Press the NUMBER 3 button to start Auto Programming. "AUTO SET PROCEEDING, PLEASE WAIT" appears on the TV screen.

AUTO SET PROCEEDING
PLEASE WAIT

Finish Auto Program

- 3 When auto program is complete, "AUTO SET COMPLETED" appears on the TV screen, and then the lowest channel stored in the VCR's memory will appear on the TV screen. To view other stored channels, press the VCR CH(annel) UP/DOWN button. Line mode is always stored in the VCR's memory. "L" appears on the VCR's front panel when selected using the VCR CH(annel) UP/DOWN button.

Adding and Deleting a Channel

1. Press the MENU button to display the menu screen. Next, press the 3 button to select "TUNER SET UP."
2. Press the 2 button to change from "TV" to "CABLE TV." Press the 1 button to change from "CABLE TV" to "TV." "[ON]" appears beside your selection.
3. Press the 4 button to select the Add/Delete channel feature. The display shown here will appear.
4. Press two numbers to add or delete channels up to 99. For 100 and higher, first press the 100 button, then two numbers.
 - Always enter a "0" before any single-digit entries. For example, 0, then 6 for "6."
 - Refer to "Using the 100 Button" to enter a three-digit number.
5. Press the 1, 2, or 3 button to "ADD," "DELETE," or "SELECT ANOTHER CH" that is in the VCR's memory. If "3" is selected, the display in step 3 will re-appear. To exit the Add/Delete mode, press the MENU button once.

SELECT CHANNEL NUMBER

CH 12

TO END PUSH MENU

TO SELECT PUSH NUMBER

CH 12

1 ADD
2 DELETE
3 SELECT ANOTHER CH

TO END PUSH MENU

Channel Memory Review

First, press the MENU button. Next, press the 3 button to select "TUNER SET UP." Now, press the 5 button to select "CH MEMORY REVIEW." The memorized channel list will appear on the TV screen. Now, press the 1 button to see the next channel list. Press the 2 button to see the previous channel list. To exit, press the MENU button.

MEMORIZED CHANNEL: CABLE

15	17	20	21	27	31
32	36	42	43	45	47
50	51	52	65	64	67
68	70	73	75	78	80
81	83	84	86	88	83
90	92	95	104	107	112

NEXT = 1 PREVIOUS = 2
TO END PUSH MENU

Using the 100 Button

To select channel numbers 100 to 125 with the NUMBER buttons, first press the 100 button and then enter the remaining two numbers. For example for channel 105, press NUMBER buttons 100, 0, 5.

22 Notes on Operations

Hook Up Your VCR

- If the reception on all channels is unsatisfactory, you may need to re-tune your TV set.

Clock Adjustment

- In the Clock Adjustment mode, be sure to enter the first digit and all subsequent entries within 10 seconds of one another. Otherwise, the VCR will automatically leave this mode and the program you were watching will return to the screen. If this happens, press the MENU button and start again.
- Be sure to enter "0" before single-digit numbers.
- The letters indicating the day of the week will appear when you have entered both digits for the year.
- If the digits entered for the day do not match the calendar, the entry will be rejected and "?" will appear.
- If you press the MENU button while in the Clock Set mode, the TV screen will return to the program you were watching.

Channel Indication

- If the channel you select has no broadcast, the screen will change to a solid blue field. The screen will remain blue until an active channel is selected.

Special Playback Features

- During search playback, horizontal noise bars will appear on the TV screen.
- After the VCR has been in the Still mode for 5 minutes, it will automatically go to the Stop mode to protect the tape and video heads.
- Special-effects playback can be used during playback of tapes recorded in the SP or SLP mode.

To Record

- Although it is possible to change the tape speed while you are recording, some distortion will appear on the tape at the point where you make the change.
- After the VCR has been in the Pause mode for 5 minutes, it will automatically go to the Stop mode to protect the tape and video heads.

One Touch Recording (OTR)

- If the preset time for a timer recording comes up during OTR recording, OTR has priority.

Timer Recording

- To do a timer recording in the LINE mode, follow steps 1–4 in "Timer Recording" section. At step 5, press the NUMBER button 0 twice (0, 0) to engage the LINE (external source) mode. Complete the rest of the steps under "Timer Recording" section.
- Timer recording may not be performed or continued if a power interruption of more than one minute occurs before or during timer recording, even if power resumes thereafter. Preset clock and timer data will be lost. This is indicated by the clock display on the VCR which resets to "-- : --". If this happens, reset the clock and program the timer.
- If the time spans of two preset programs overlap, the lower-numbered program will have priority and the second program will start only after the first program has been executed.
- If the POWER button is pressed to OFF with no cassette loaded, the TIMER and "Cassette Inside" indicators will continue blinking.
- If the record tab is missing, the cassette will be ejected when the POWER button is pressed to OFF, and the TIMER and "Cassette Inside" indicators will continue blinking.

Power Failure

- Timer Recordings will be erased if the power fails. Repeat "Set the Clock" on page 9 before setting up a "Timer Recording" on pages 15–16.

Satellite Hook-Up

- Watching one TV channel while recording another may not be possible with a satellite hook-up.
- You may have to set your VCR to channel 3 or 4 and make your channel selections at the satellite converter box.
- If you use accessory Audio and Video cables (not supplied) to hook-up your VCR to TV, you will have to set your VCR to Line Input. "A/V IN" appears on your TV screen when you first switch into this mode. "L" appears on your VCR.

Line Input

- If you accidentally get into the Line mode ("L" appears on the VCR), simply press the VCR CH(annel) UP/DOWN button or select a channel using the NUMBER buttons to exit.

Before Requesting Service 23

IMPORTANT NOTE: Periodic maintenance is required in order to maintain the unit's continued excellent performance. After a period of time the Video heads will require replacement. If cleaning or replacement of the Video heads is required, this service should be performed by an authorized Video System Service Center.

Check the following points once again if you are having some difficulty with your VCR (Video Cassette Recorder).

Power	Correction
<p>No power...</p> <p>Power Failure...</p>	<ul style="list-style-type: none"> • Check that the power cord is correctly connected to an AC (Alternating Current) outlet. • Check that the Power button is set to on. • Please complete "Setting the Clock" on page 9 before attempting to set up a "Timer Recording" on page 15 – 16.
Recording & Playback	Correction
<p>TV program can't be recorded...</p> <p>Timer recording can't be performed...</p> <p>There is no playback picture, or the playback picture is noisy or contains streaks...</p> <p>During special effects playback, the picture may contain some vertical jitter when using a TV which has an Automatic Vertical Hold Control...</p> <p>If the top of your playback picture waves back and forth excessively...</p>	<ul style="list-style-type: none"> • Check the connections between the VCR, the external antenna, and your TV. • Make sure that the record tab on the back of the cassette is still intact. (P.6). • Set the recording start/stop time correctly (P.15 – 16). • Make sure that the POWER button is set to "OFF" (P.16). • Timer recording may not be performed or continued if a power interruption of more than 1 minute occurs before or during Timer Recording, even if the power resumes thereafter. • Select the same channel on your TV as that of the VCR Channel 3/4 switch (P.8). • Set the TV/VCR selector to "VCR". • Check that channel 3 or 4 of the TV is properly adjusted. • Adjust the Tracking control slowly in either direction (P.18). • Set the TV's Vertical Hold Control, if available, to "MANUAL" and adjust. • Because the VCR playback signal is not as stable as an off-the-air TV signal, the top of your TV screen may be bent or unstable during playback. To solve this problem, slowly turn the HORIZONTAL HOLD control on your TV to correct the wavy picture. If your TV does not have the horizontal hold control or adjusting the control does not help, please contact your local TV service center.

24 Before Requesting Service (cont'd)

<p>Remote Control</p> <p>VCR can't be remote controlled...</p>	<p>Correction</p> <ul style="list-style-type: none"> • Aim the Remote Control directly at the remote sensor on the VCR. • Avoid all obstacles which may interfere with the signal path. • Inspect or replace the batteries (P.6). • Make sure batteries are inserted correctly (P.6).
<p>Miscellaneous</p> <p>You can't view programs normally on the TV...</p> <p>Video cassette can't be inserted...</p> <p>Video cassette can't be removed...</p> <p>Video cassette ejects when the OTR or RECORD button is pressed, or when the POWER button is pressed off to set the Timer...</p>	<p>Correction</p> <ul style="list-style-type: none"> • Set the VCR/TV selector to "TV". • Insert the cassette with the window side up and the record tab facing you. • Make sure a cassette tape is not already inserted. Press STOP/EJECT button on VCR. • Check that the power cord is correctly connected to your VCR's back panel and to an AC (Alternating Current) outlet. • If the VCR's TIMER indicator is lit, press POWER to disengage the timer first, and then press STOP/EJECT. • Check the cassette to be sure that the record tab on the back of the cassette is still intact (P.6).

Specifications

Video Recording System	Rotary four-head helical scan system	Weight	3.8 kg
Video Signal	EIA standards: NTSC color	Dimensions	360(W) x 94(H) x 295(D) mm
Antenna	VHF/UHF – 75 ohm external antenna terminal	Tuner	
VHF Output Signal	Channel 3 or 4 (switchable) 75 ohms unbalanced	Broadcast Channels	VHF 2 – 13, UHF 14 – 69
Power Requirement	AC110V – 127V – 220V ~ 50/60 Hz	CATV Channels	Midband A – I Superband J – W Hyperband AA – EEE Lowband A5 – A1 Special channel 5A Ultraband 65 – 125
Power Consumption	19W	Accessories	<ul style="list-style-type: none"> • Wireless Remote Control • "AAA" Batteries • RF Coaxial Cable • Conversion plug
Operating Temperature	41°F (5°C) to 104°F (40°C)		
Relative Humidity	10% to 80%		

Design and specifications are subject to change without notice.

c

THE BEST CHOICE FOR YOUR VIDEO CASSETTE RECORDER



Philips offers a full range of High Grade & Extra High Grade Video Cassettes.



PHILIPS

PU36278-123

Free Manuals Download Website

<http://myh66.com>

<http://usermanuals.us>

<http://www.somanuals.com>

<http://www.4manuals.cc>

<http://www.manual-lib.com>

<http://www.404manual.com>

<http://www.luxmanual.com>

<http://aubethermostatmanual.com>

Golf course search by state

<http://golfingnear.com>

Email search by domain

<http://emailbydomain.com>

Auto manuals search

<http://auto.somanuals.com>

TV manuals search

<http://tv.somanuals.com>