

Video Cassette Recorder

VR388 / 55
VR588 / 55



Instructions for use

Инструкция по эксплуатации

طريقة استعمال



Let's make things better.



PHILIPS

TABLE OF CONTENTS

Safety Precautions

- WARNING: DANGEROUS VOLTAGE INSIDE**
- WARNING: TO PREVENT FIRE OR SHOCK HAZARD, DO NOT EXPOSE THIS UNIT TO RAIN OR MOISTURE.**
- The POWER button does not completely shut off the mains power from the unit, but switches operating current on or off only.
 - The rating plate is on the rear of the unit.

WARNING

Any unauthorized changes or modifications to this equipment void the user's authority to operate it.



Introduction

Congratulations on purchasing your new VCR.

You can't wait to get it working, but before you do, spare a few moments to read this brief introduction to the world of video recording. It may repay you handsomely in terms of improved results, and avoiding of costly mistakes.

Table of Contents

Description of Controls	3
Front Panel	3
Remote Control (For VR588/55)	4
Remote Control (For VR388/55)	6
Rear Panel	7
Display Window	8
On-Screen Display	8
Getting Connected Up	9
VCR to TV Connection	9
VCR to AV TV Connection Using SCART Cable	9
Setting Up	10
Setting the Video Channel	10
Menu Operations	11
Initial Setup	11
Manual Channel Setting	13
Selecting Colour Mode	13
Basic Operations	14
Playback	14
Recording	14
One Touch Recording (OTR)	15
Index Search	15
Automatic Operations	15
Advanced Operations	16
Using On-Screen Display	16
Picture Control	16
Special Effect Playbacks	16
Tracking Adjustments	17
Timer Recording	17
Tape Duplication	19
Before Requesting Service	20
Specifications	21

Positioning

Do not place the VCR directly on top of, or underneath, your TV set. Ensure that there is at least 20 cm between the VCR and the TV set, and that air can circulate freely through the ventilation openings of the VCR.

IMPORTANT

Audio-Visual material may consist of copyrighted works which must not be recorded without the authority of the owner of the copyright. Please refer to relevant laws in your country.

DESCRIPTION OF CONTROLS

Front Panel

VR588/55

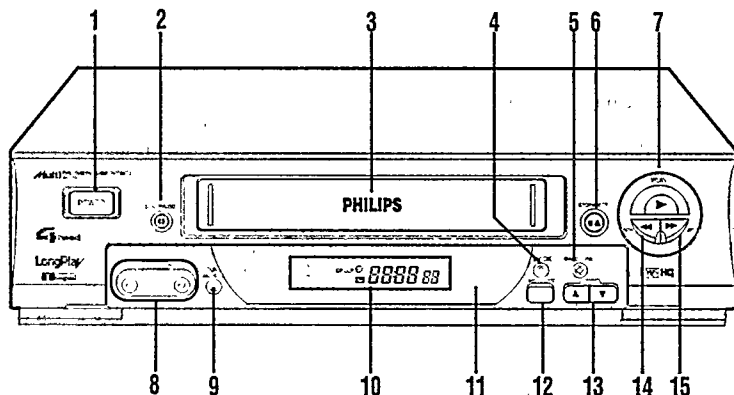

VR388/55

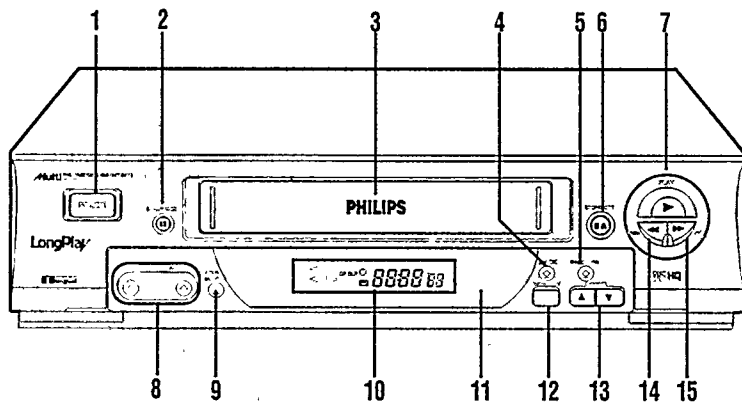

1 POWER button

- Turns the VCR on or off.
- Sets the VCR for an unattended recording (timer recording) after timer settings are completed. (→P.18)

2 STILL/PAUSE ■ button

Stops the tape during recording (pause) or playback (still picture). (→P.14, P.16) Press again to resume normal recording. Press PLAY ► to resume normal playback. Activates slow motion picture when pressed for more than 2 seconds during playback.

3 Cassette Compartment

Where a video cassette is inserted.

4 ►/OK button

Changes the selection when using the menus. (→P.11)

5 REC (record)/OTR ● button

- Starts recording when pressed once. (→P.14)
- Starts a recording for 30 minutes to 9 hours long for VR588/55 or 5 hours long for VR388/55 when pressed more than once. The shut-off time increases in 30 minute intervals. (→P.15)

6 STOP/EJECT ■ / ▲ button

Stops the tape when the tape is running. (→P.14)

Press again to eject the cassette when the tape is not running. (→P.14)

7 PLAY ► button

Starts normal playback. (→P.14)

8 AUDIO/VIDEO input jacks

For connecting another VCR or a portable video camera. (→P.19)

9 COLOUR MODE button

Selects the colour mode both for playback and recording. (→P.13)

10 Display window

See the next page.

11 IR (infrared) remote sensor

Receives the signal from the (IR) remote control.

12 MENU/EXIT button

Display the main menu.

Press again to exit from the menu operations. (→P.11)

13 CHANNEL ▼ / ▲ buttons

- Changes the channels on the VCR. Release at a desired channel.
- Moves the cursor up and down when using the menus. (→P.11)
- Adjusts the tracking during playback, still picture, and slow motion picture. (→P.17)

14 REW (Rewind) ◀◀ button

- Rewinds the tape when the tape is not running. (→P.14)
- Starts reverse rapid visual search during playback. (→P.14)

15 FF (Fast forward) ▶▶ button

- Fast forwards the tape when the tape is not running. (→P.14)
- Starts forward rapid visual search during playback. (→P.14)

Remote Control (For VR588/55)

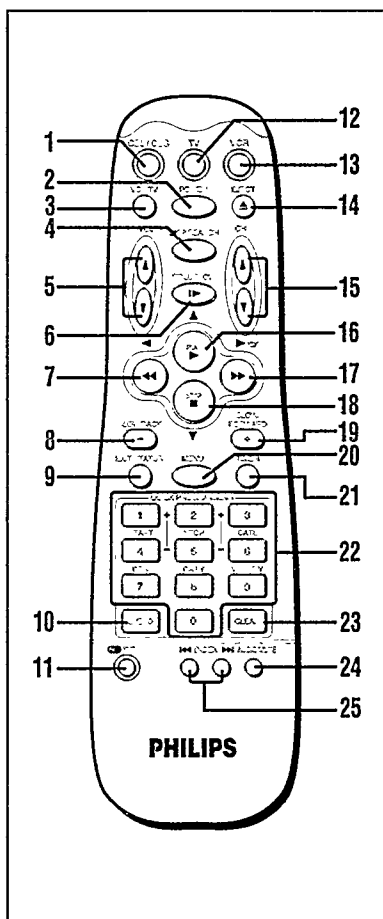

Using this remote control to operate other components

You can use this remote control to operate some of the PHILIPS TVs.

1 CBL/DBS button

Does not function for this model.

2 POWER button

Before using this button, press VCR or TV to select your target component.

- After pressing VCR:
 - Turns the VCR on or off.
 - Sets the VCR for an unattended recording (timer recording) after timer settings are completed. (→P.19)

For some Philips TV only:

- After pressing TV, turns the TV on or off.

3 VCR/TV button

Does not function for this model.

4 SKIP SEARCH button

Skips playback for 30 seconds by time counter reading.

When pressed more than once up to 4 times, the search time increase in 30-second intervals up to 2 minutes. (→P.16)

5 VOL (volume) ▲ / ▼ buttons

For some Philips TV only:

Changes the TV volume. Release at desired volume.

6 STILL/SLOW ► button

Stops the tape during recording (pause) or playback (still picture) temporarily. (→P.14, P.16)

Press again to resume normal recording. Press PLAY ► to resume normal playback. Activates slow motion picture when pressed for more than 2 seconds during playback.

7 ◀◀ (Rewind) / ◀ button

Before using this button, press VCR.

- After pressing VCR:
 - Rewinds the tape. Also, during playback, starts rapid reverse visual search. (→P.14)
 - Goes back to the previous menu screen when using the menus. (→P.11)

8 SLOW/BACK – button

During a slow motion picture, adjust the playback speed in the reverse direction. (→P.16)

9 EXIT/STATUS button

Before using this button, press VCR.

- After pressing VCR:
 - Displays the time counter, present time, channel number, and remaining tape length. (→P.16)
 - Exits from menu operations when using the menus. (→P.11)

10 SPEED button

Selects the tape speed for recording {SP, LP or SLP (For NTSC tape only)}.

During playback, the tape speed is automatically selected (SP, LP or SLP). (→P.14, P.17)

11 REC (record)/OTR button

- Start recording when pressed once. (→P.14)
- Starts a recording for 30 minutes to 9 hours long. When pressed more than once, the shut-off time increases in 30-minute intervals. (→P.15)

12 TV button

Makes the remote control ready for operating the TV.

13 VCR button

Makes the remote control ready for operating the VCR.

14 EJECT ▲ button

Ejects the cassette. (→P.14)

15 CH (channel) ▲ / ▼ button

Before using this button, press VCR or TV.

- After pressing VCR, changes the channels on the VCR. Release at a desired channel.

For some Philips TV only:

- After pressing TV, changes the channels on the TV. Release at a desired channel.

16 PLAY ► / ▲ button

Before using this button, press VCR.

- After pressing VCR:
 - Starts normal playback. (→P.14)
 - Moves up the cursor when using the menus. (→P.11)

17 ►► (Fast forward) / ►/OK button

Before using this button, press VCR.

- After pressing VCR:
 - Fast forward the tape. Also during playback, starts rapid forward visual search. (→P.14)
 - Selects the items on the menus or goes to the next menu screen when using the menus. (→P.11)

18 STOP ■ / ▼ button

- Stops the tape. (→P.14)
- Moves down the cursor when using the menus. (→P.11)

19 SLOW/FORWARD + button

During a slow motion picture, adjust the playback speed in the forward direction. (→P.16)

20 MENU button

Before using this button, press VCR.

- After pressing VCR, calls up the main menu. (→P.11)

21 TIMER button

Display the Timer Recording menu. (→P.17)

22 Number buttons

(0, 1, 2, 3, 4, 5, 6, 7, 8 and 9)

Before using these buttons, press VCR.

- Press to select a channel on the VCR. To select channels 1 to 9, press 0 then the channel you want. For example, for channel 4, press 0 then 4.
- Also used to programme the Timer Recordings. (→P.17)

23 CLEAR button

Erases unwanted timer programmes. (→P.18)

24 AUDIO/MUTE button

For some Philips TV only:
Turns off the TV sound.

25 INDEX ◀◀ / ▶▶ buttons

Locates an index marked at the beginning of every recording. (→P.15)

To insert the batteries:

- 1 Remove the battery compartment lid from the bottom of the remote control.

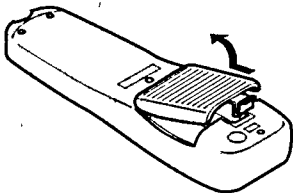

- 2 Install two batteries —R6(SUM-3)/AA — matching polarity indicated inside the battery compartment.

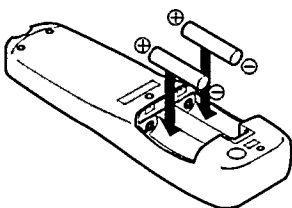

- 3 Replace the lid.

Note:

This remote control and batteries are supplied accessories. Check to make sure they are included. Also, check "Specifications" to see what other accessories are included.

CAUTION

On Battery Replacement

Do not mix old and new batteries.
(Also never mix alkaline batteries with manganese batteries.)

Remote Control (For VR388/55)

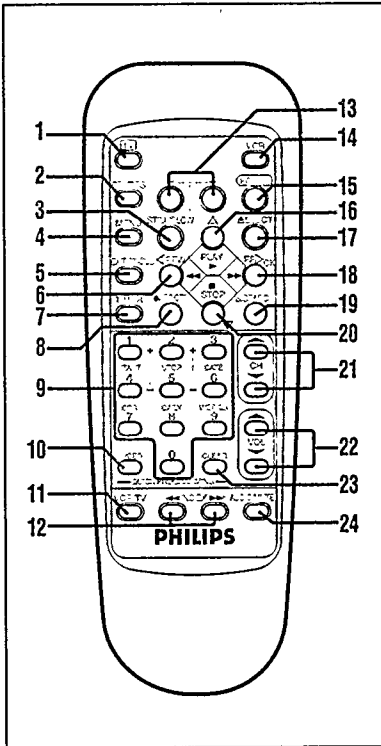

Using this remote control to operate PHILIPS TV

You can use this remote control to operate some of the PHILIPS TVs.

1 TV button

Makes the remote control ready for operating the TV.

2 CBL/DBS button

Does not function for this VCR.

3 STILL/SLOW button

Stops the tape during recording (pause) or playback (still picture) temporarily. (→P.14, P.16)
Press again to resume normal playback or recording.

4 MENU button

Before using this button, press VCR.
• After pressing VCR, calls up the main menu. (→P.11)

5 EXIT/STATUS button

Before using this button, press VCR.

- After pressing VCR:
 - Displays the time counter, present time, channel number, and remaining tape length. (→P.16)
 - Exits from menu operations when using the menus. (→P.11)

6 ◀◀ (Rewind) / ◀ button

Before using this button, press VCR.

- After pressing VCR:
 - Rewinds the tape. Also, during playback, starts rapid reverse visual search. (→P.14)
 - Goes back to the previous menu screen when using the menus. (→P.11)

7 TIMER button

Display the Timer Recording menu. (→P.17)

8 REC (record)/OTR ● button

- Start recording when pressed once. (→P.14)
- Starts a recording for 30 minutes to 5 hours long. When pressed more than once, the shut-off time increases in 30-minute intervals. (→P.15)

9 Number buttons

(0, 1, 2, 3, 4, 5, 6, 7, 8 and 9)

- Before using these buttons, press VCR.
- Press to select a channel on the VCR. To select channels 1 to 9, press 0 then the channel you want. For example, for channel 4, press 0 then 4.
 - Also used to programme the Timer Recordings. (→P.17)

10 SPEED button

Does not function for this VCR.

11 VCR/TV button

Does not function for this VCR.

12 INDEX ◀◀◀ / ▶▶▶ buttons

Locates an index marked at the beginning of every recording. (→P.15)

13 STILL/SLOW +/- button

- +: During a slow motion picture, adjust the playback speed in the forward direction. (→P.16)
- -: During a slow motion picture, adjust the playback speed in the reverse direction. (→P.16)

14 VCR button

Makes the remote control ready for operating the VCR.

15 POWER button

Before using this button, press VCR or TV to select your target component.

- After pressing VCR:
 - Turns the VCR on or off.
 - Sets the VCR for an unattended recording (timer recording) after timer settings are completed. (→P.18)

For some Philips TV only:

- After pressing TV, turns the TV on or off.

16 PLAY ▶ / ▲ button

Before using this button, press VCR.

- After pressing VCR:
 - Starts normal playback. (→P.14)
 - Moves up the cursor when using the menus. (→P.11)

17 EJECT ▲ button

Ejects the cassette. (→P.14)

18 ▶▶ (Fast forward) / ▶/OK button

Before using this button, press VCR.

- After pressing VCR:
 - Fast forward the tape. Also during playback, starts rapid forward visual search. (→P.14)
 - Selects the items on the menus or goes to the next menu screen when using the menus. (→P.11)

19 S. (Skip) SEARCH button

Skips playback for 30 seconds by time counter reading.

When pressed more than once up to 4 times, the search time increase in 30-second intervals up to 2 minutes. (→P.16)

20 STOP ■ / ▼ button

- Stops the tape. (→P.14)
- Moves down the cursor when using the menus. (→P.11)

21 CH (channel) ▲ / ▼ button

Before using this button, press VCR or TV.

- After pressing VCR, changes the channels on the VCR. Release at a desired channel.

For some Philips TV only:

- After pressing TV, changes the channels on the TV. Release at a desired channel.

22 VOL (volume) ▲ / ▼ buttons

For some Philips TV only:

Changes the TV volume.

Release at desired volume.

23 CLEAR button

Erases unwanted timer programmes.

(→P.18)

24 AUDIO/MUTE button

For some Philips TV only:

Turns off the TV sound.

To insert the batteries:

- 1 Remove the battery compartment lid from the bottom of the remote control.

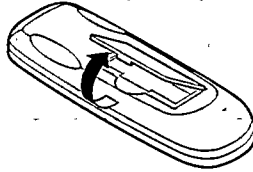

- 2 Install two batteries —R6(SUM-3)/AA — matching polarity indicated inside the battery compartment.

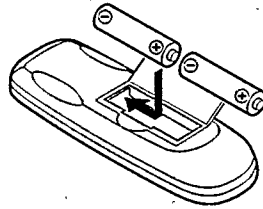

- 3 Replace the lid.

Note:

This remote control and batteries are supplied accessories.

Check to make sure they are included. Also, check "Specifications" to see what other accessories are included.

CAUTION

On Battery Replacement

Do not mix old and new batteries. (Also never mix alkaline batteries with manganese batteries.)

Rear Panel

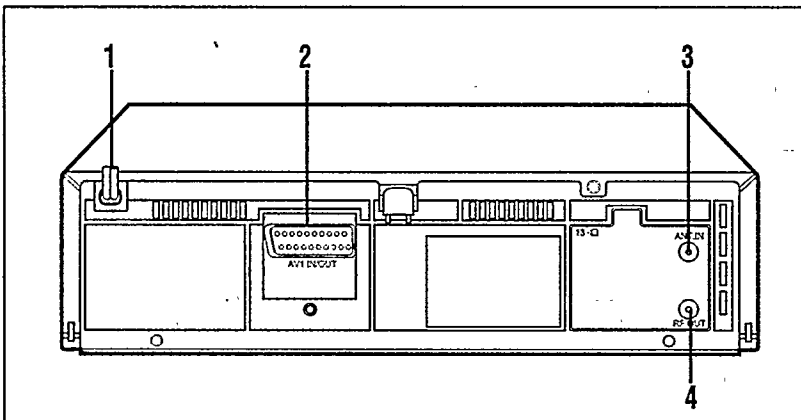

1 AC (alternating current) power cord

Connect the AC power cord to an AC outlet.

2 AV1 IN/OUT terminal (SCART)

For connecting to the SCART terminal (21-pin SCART connector) on TV or another VCR. (→P.9, P.19.)

3 ANT. (antenna) IN (input) terminal (from Antenna)

Connect your antenna or Cable to this terminal. (→P.9)

4 RF OUT (output) terminal (to TV)

Use the supplied RF coaxial cable to connect this terminal on the TV. (→P.9)

DESCRIPTION OF CONTROLS (CONTINUED)

Display Window

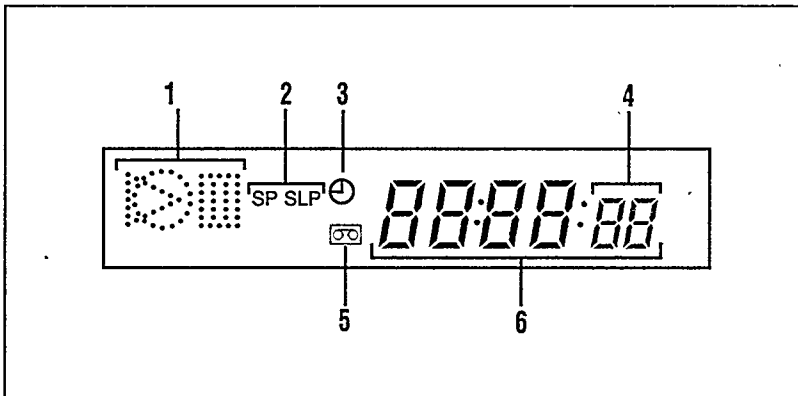

1 Operation mode indicators

- : Lights up during recording.
- ▷: Lights up during playback.
- ⏸: Lights up during a pause.

2 Speed indicator

- Indicates the tape speed.
- SP – Standard Play
 - LP – Long Play
 - SLP – Super Long Play
(For NTSC tape only).

3 (timer) indicator

- Lights up when the VCR is set for an unattended recording (timer recording). (→P.18)

4 Channel indicator

- A channel number selected with the TV tuner built-in the VCR appears. When the external line input is selected: "L-F" appears for the front panel connectors or "L-I" appears for the rear panel connectors.

5 (Cassette-in) indicator

- Lights up when there is a cassette in the VCR.

6 Digital clock/counter

- Normally the present time appears.
- When a tape is inserted, the time counter appears (and is reset to 0:00:00).
If you always rewind your tapes completely, you can use this counter reading as an index to find where a programme starts.

On-Screen Display

The following information (VCR operating status) appears on the TV screen. (→P.16)

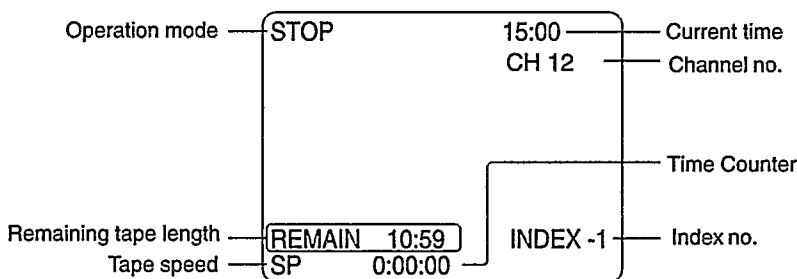

Note on the displayed information

- The time counter and remaining tape length will not be correct when playing back an NTSC tape.
- When you playback a thin tape like an E-160 cassette tape or compact video cassette tape (VHS-C), the remaining tape length will flash.
- If the remaining tape length is more than 10 hours, "A" will be shown to indicate the hour of the actual remaining tape length. (Ex. "A:20")

GETTING CONNECTED UP

VCR to TV Connection

Connection Diagram

- 1 Disconnect the antenna or Cable from the TV and the AC power cord of the TV from the AC outlet.
- 2 Connect the antenna or Cable to the VCR.
- 3 Connect the VCR to the TV using the RF coaxial cable.
- 4 Plug the AC power cords of the VCR and TV into the AC outlets.

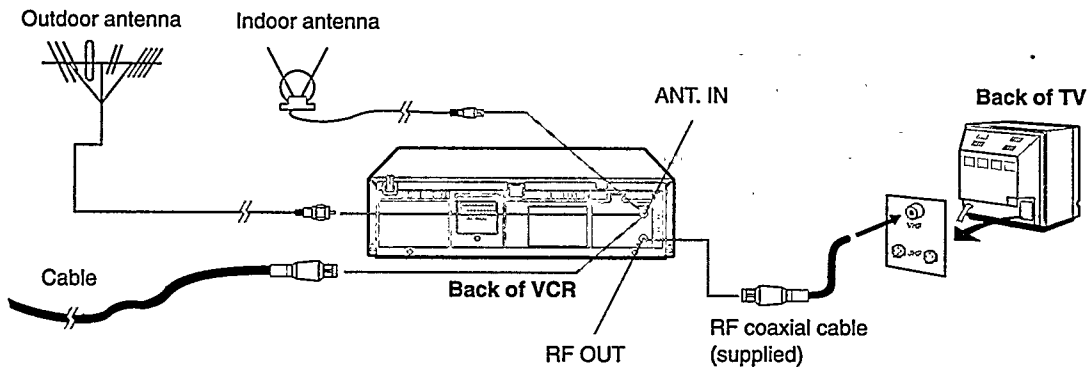

CAUTION

Do not plug the AC power cords until all connections are completed.

To watch a picture from this VCR on the TV, select UHF E36 channel (video channel of this VCR when shipped from the factory). If you want to change video channel, see "Setting the Video Channel" (→.P10).

VCR to AV TV Connection

With this connection, you can get better pictures and sounds when playing back a tape.

To watch a picture from this VCR on the TV, select the video input on the TV, to which this VCR is connected.

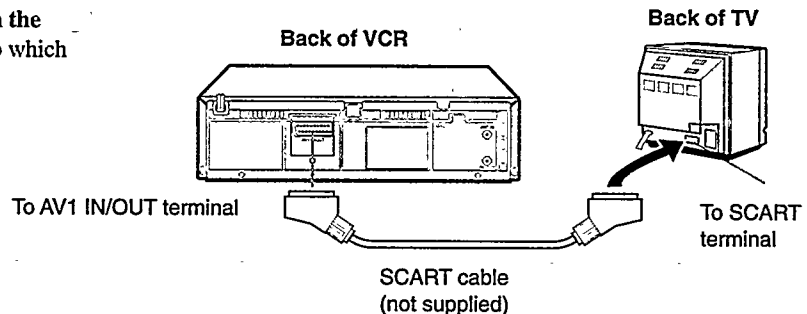

Setting the Video Channel

This VCR is designed to send picture and sound signal on UHF channel E36 to the TV, through the RF coaxial cable. If you want to change this video channel (E36) to another channel (between E28 to E60), follow the procedure below before turning on the VCR for the first time.

- 1 Keep the VCR turned off and no cassette inserted until you finish the following procedure.
- 2 Turn on the TV, and tune it to any channel (UHF E28 to E60) you want to use as the video channel on the TV.
 - Select a channel not used in your area.
- 3 Press STOP/EJECT \blacksquare / \blacktriangle on the front panel for more than 5 seconds. The following indication appears on the display.

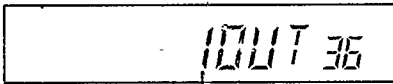

TV system number starts flashing.

- 4 Press CH \blacktriangle / \blacktriangledown on to select an appropriate TV system number for your area.
 - 1: For B/G.
 - 2: For D/K.
 - 3: For I

- 5 Press OK/▶.
- The channel number starts flashing on the display.

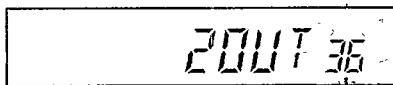

Channel number starts flashing.

- 6 Press CH \blacktriangle / \blacktriangledown to select the channel you have tuned on the TV as the video channel in step 2. A test signal (two vertical white bars) appears on the TV.



Test signal
(two vertical white bars)

*If you use only external video input (AV) mode to watch the picture from this VCR
You can turn off the video channel output. To turn off the video output channel, press CH until "--" appears on the channel number position.*

- 7 Press OK/▶ to finish the video channel setting. Now you will enter the Initial Setup mode explained on page 11.

To watch a picture from this VCR on the TV, select the same channel you have selected as the video channel (in step 2 above) on the TV.

Operations hereafter are described using the buttons on the remote control unless mentioned otherwise. The buttons on the front panel having the same (or nearly same) name or same (or nearly same) mark function exactly the same as those on the remote control.

Menu Operations

Before operating the VCR, be familiar with the menu operations first because most of the features built into the VCR can be available only on the menus.

- 1 Press VCR on the remote control.
 - When using the buttons on front panel, skip this step.

- 2 Press MENU (or MENU/EXIT on the front panel) to display the main menu screen.

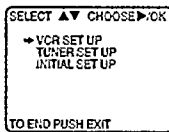

- 3 Press ▲ or ▼ (or CHANNEL ▲/▼ on the front panel) to select a desired feature on the menu, then press OK/►.
- 4 When you select a feature, go to the section in this manual and follow the instructions described there.

To go back to the previous menu screen, press ◀.

To exit from the menu operations, press EXIT/STATUS (or MENU/EXIT on the front panel again).

Note:
Menu operating buttons function only when a menu is on the TV screen. When no menus is on the TV screen, they function differently.

IMPORTANT

The setup and adjustment procedures explained hereafter are written under the following conditions:

- You have turned on the TV and selected the video channel (or external video input).
- You have turned on the VCR.

Initial Setup

For the first time you turn on the VCR, the VCR automatically enters the Initial Setup mode unless you have set it. This mode asks you to set the following items:

- Selecting the language.
- Setting the clock.
- Selecting the TV system.
- Setting the channels.

Make sure....

- Your VCR, TV, and antenna are connected correctly.
- The remote control operation mode is set correctly for operating your target component.
 - Press VCR to operate the VCR.
 - Press TV to operate the TV.

1 Select the Language

- 1 Press VCR.
 - When using the buttons on front panel, skip this step.
- 2 Press POWER. The VCR turns on, then the menu for selecting the language appears.
- 3 Press ▲ or ▼ to select either "ENGLISH," "中文" (Chinese), or "РУССКИЙ" (Russian) whichever you want to use on the TV screen.

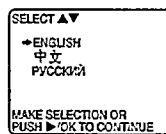

2 Set Clock

- 1 Press OK/►. The clock setting menu appears.
- 2 Press ▲ or ▼ to set the time, then press OK/►.
 - Each time you press ▲ or ▼, the set time changes by 1-minute intervals. If you hold the button, the set time changes by 30-minute intervals.

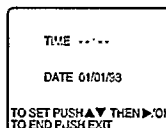

- 3 Press ▲ or ▼ to set the month and day, then press OK/►.
 - Each time you press ▲ or ▼, the set date changes by 1-day intervals. If you hold the button, the set time changes by 15-day intervals.
- 4 Press ▲ or ▼ to set the year, then press OK/►.
 - Each time you press ▲ or ▼, the set date changes by 1-year intervals. If you hold the button, the set time changes rapidly.
- 5 Press EXIT/STATUS to exit from the menu operations. The following message appears on the TV screen.

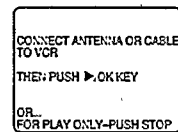
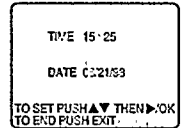

3 Select TV System

- 1 Press OK/►. The TV system selecting menu appears on the TV.
- 2 Press ▲ or ▼ to select the appropriate TV system of your residential area.
 - B/G: For West Europe, ASEAN countries, Australia, New Zealand.
 - D/K: For China, Russia, East Europe.
 - I: For Hong Kong, South Africa, United Kingdom.

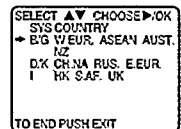

4 Start Auto Programming

Press OK/►. Auto programming starts, and the following message appears on the TV.

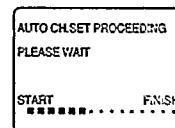

The local channels receivable in your area are automatically programmed in the VCR tuner.

- If "NO TV SIGNALS" appears on the TV screen, the TV or an antenna is not connected correctly. Check the connection and press OK/► again.

To be continued on the next page

SETTING UP (CONTINUED)

When the auto programming is completed

The following message appears on the TV, and the lowest channel will be tuned in.

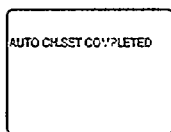

Now you have finished the initial set up procedure.

*If you stop the initial setup procedure while it is proceeding:
The VCR enters the initial setup mode again the next time your turn on the VCR.*

Initial setup will not start in the following cases:

- If there is a tape inserted.
- If any one of the initial setup procedures is finished manually.

To reset the clock manually

You can also reset or correct the clock manually.

- 1 Press VCR.
- 2 Press MENU.
- 3 Press ▲ or ▼ to select "INITIAL SET UP" then press ►.
- The Initial Set Up menu appears.
- 4 Press ▲ or ▼ to select "SET CLOCK" then press OK/►.
- 5 Press ▲ or ▼ to set the time, then press OK/►.
 - Each time you press ▲ or ▼, the set time changes by 1-minute intervals. If you hold the button, the set time changes by 30-minute intervals.
- 6 Press ▲ or ▼ to set the month and day, then press OK/►.
 - Each time you press ▲ or ▼, the set date changes by 1-day intervals. If you hold the button, the set date changes by 15-day intervals.
- 7 Press ▲ or ▼ to set the year, then press OK/►.
 - Each time you press ▲ or ▼, the set date changes by 1-year intervals. If you hold the button, the set year changes rapidly.
- 5 Press EXIT/STATUS to exit from the menu operations.

Note:

If a power failure occurs, clock will lose its setting.

To change the language manually

You can also change the language manually.

- 1 Press VCR.
- 2 Press MENU.
- 3 Press ▲ or ▼ to select "INITIAL SET UP" then press ►.
- The Initial Set Up menu appears.
- 4 Press ▲ or ▼ to select "LANGUAGE."
- 5 Press OK/► to select the language on the TV screen.
- Each time you press the button, the language changes as follows:

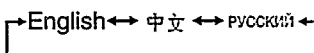

- 6 Press EXIT/STATUS to exit from the menu operations.

If you want to delete unwanted channels

You can delete channels manually. After you have deleted the channels, they will be not selected by pressing CH ▲/▼.

- 1 Press VCR.
- 2 Press MENU.
- 3 Press ▲ or ▼ to select "TUNER SET UP" then press OK/►.
- 4 Press ▲ or ▼ to select "CHANGING TUNER SET UP" then press OK/►.
- The programmed channel information list appears with the settings of the tuned channel flashing. (You can also watch the picture of the tuned channel since the list and the picture alternates on the TV.)
- 5 Press ▲ or ▼ until an unwanted channel setting flashes.
- 6 Press CLEAR to delete the unwanted channel.
 - If you have accidentally deleted a channel, press ◀.
- 7 Repeat steps 5 and 6 until you delete all unwanted channels.
- 8 Press EXIT/STATUS to exit from the menu operations.

CH	FREQ	B/S	CH	FREQ	S/S
01	163	EG	07	223	EG
02	169	EG	08	229	EG
03	165	EG	09	237	EG
04	215	EG	10	245	EG
05	213	EG	11	274	EG
06	221	EG	12	324	EG

SELECT=▲▼ DELETE=CLEAR
TO CHANGE CH FUSH ►◀
TO END FUSH EXIT

If you want to exchange the channel positions

You can also replace the channel position numbers.

EX. Replace channel 9 and channel 3

- 1 Press VCR.
- 2 Press MENU.
- 3 Press ▲ or ▼ to select "TUNER SET UP" then press OK/►.
- 4 Press ▲ or ▼ to select "CHANGING TUNER SET UP" then press OK/►.
- 5 Press ▲ or ▼ until information for channel 3 flashes.
- 6 Press OK/► once.
- Only channel indication for channel 3 starts flashing.
- 7 Press 0 then 9.
- The channel settings for channel 3 and 9 are exchanged.
- If you have accidentally deleted a channel, press ◀.
- 8 Press OK/► to store the setting.
- 9 Press EXIT/STATUS to exit from the menu operations.

If the picture is not clear

You need to fine-tune this particular channel.

EX. Fine-tune channel 3

- 1 Press VCR.
- 2 Press MENU.
- 3 Press ▲ or ▼ to select "TUNER SET UP" then press OK/►.
- 4 Press ▲ or ▼ to select "CHANGING TUNER SET UP" then press OK/►.
- 5 Press ▲ or ▼ until information for channel 3 flashes.
- 6 Press OK/► twice.
- Only frequency indication for channel 3 starts flashing.
- 7 Press ▲ or ▼ to fine-tune the station until you get the best possible picture.
- 8 Press OK/► to store the setting.
- 9 Press EXIT/STATUS to exit from the menu operations.

If no sound comes out

You need to change the TV system for this particular channel.

EX. Change the TV system for channel 3

- 1 Press VCR.
- 2 Press MENU.
- 3 Press ▲ or ▼ to select "TUNER SET UP" then press OK/▶.
- 4 Press ▲ or ▼ to select "CHANGING TUNER SET UP" then press OK/▶.
- 5 Press ▲ or ▼ until information for channel 3 flashes.
- 6 Press OK/▶ three times.
Only TV system indication for channel 3 starts flashing.
- 7 Press ▲ or ▼ to select the appropriate TV system (BG, DK, I) so that sound comes out.
- 8 Press OK/▶ to store the setting.
- 9 Press EXIT/STATUS to exit from the menu operations.

If you need to do the auto programming again

If you move to another place, you may need to tune the VCR tuner again for your new residential area.

- 1 Press VCR.
- 2 Press MENU.
- 3 Press ▲ or ▼ to select "TUNER SET UP" then press OK/▶.
- 4 Press ▲ or ▼ to select "AUTO TUNER SET UP" then OK/▶.
- 5 Press ▲ or ▼ to select the appropriate TV system (B/G, D/K, I) of your residential area.
- 6 Press OK/▶.
Auto programming starts.
When it ends, programmed channels, frequencies, and TV systems are shown on the display.
- 7 Press EXIT/STATUS to exit from the menu operations.

Manual Channel Setting

When you want to do channel setting manually, follow this procedure.

1 Select Tuner Set Up Mode

- 1 Press VCR.
- 2 Press MENU.
- 3 Press ▲ or ▼ to select "TUNER SET UP" then press OK/▶.
The Tuner Set Up menu appears.

2 Delete Unwanted Channel

- 1 Press ▲ or ▼ to select "CHANGING TUNER SET UP" then press OK/▶.
The programmed channel information list appears with the settings of the tuned channel flashing. (You can also watch the picture of the tuned channel since the list and the picture alternates on the TV.)
- 2 Press ▲ or ▼ until an unwanted channel setting flashes.
- 3 Press CLEAR to delete the unwanted channel.
 - If you have accidentally deleted a channel, press ◀.

3 Select Station

- 1 press OK/▶.
- 2 Press ▲ or ▼ to select the search starting band.

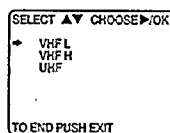

- VHF L:** Starts searching from the VHF L band.
- VHF H:** Starts searching from the VHF H band.
- UHF:** Starts searching from UHF band.

- 3 Press OK/▶.
Searching starts, and when a station is tuned in, searching stops and the tuned frequency is shown on the TV. Then the following menu appears.

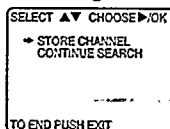

4 Store Channel

- Press ▲ or ▼ to select "STORE CHANNEL" then press OK/▶.
- The programmed channel information list appears again with the settings of the newly tuned channel flashing.
- If you do not want to store this station, select "CONTINUE SEARCH" then press OK/▶, searching starts again.

5 Finish Setting

Press EXIT/STATUS.

Selecting Colour Mode

Before using the VCR, you need to set the colour mode both for recording and playback.

Press COLOUR MODE on the front panel to change the colour system.

For recording:

AUTO: Normally select this mode.

The colour system is automatically detected.

NTSC3.58: Select this mode if "AUTO" does not work well when recording the NTSC signals. (For playback on an NTSC TV)

NTSC4.43: Select this mode if "AUTO" does not work well when recording the NTSC signals on the PAL TV. (For playback on a PAL TV)

PAL: Select this mode if "AUTO" does not work well when recording the PAL signals.

MESECAM: Select this mode if "AUTO" does not work well when recording the SECAM signals.

For playback:

AUTO: Normally select this mode. When you watch a PAL, NTSC or MESECAM tape, the colour system is automatically detected.

NTSC3.58: Select this mode when you watch an NTSC3.58 tape on an NTSC TV.

NTSC4.43: Select this mode when you watch an NTSC4.43 tape on a PAL TV.

NTSC→PAL: Select this mode when you watch an NTSC3.58 tape on a PAL TV.

PAL: Select this mode if "AUTO" does not work well when playing back a PAL tape.

MESECAM: Select this mode if "AUTO" does not work well when playing back a MESECAM tape.

*When playing back an NTSC tape with "AUTO" mode selected
The tape is played back using "NTSC3.58" mode.*

BASIC OPERATIONS

Playback

Make sure....

- Your VCR, TV, and antenna are connected correctly.
- The remote control operation mode is set correctly for operating your target component.
 - Press VCR to operate the VCR.
 - Press TV to operate the TV.

1 On TV

- 1 Turn on the TV.
- 2 Select the video channel (or external video input).

2 On VCR

Insert a cassette.

The VCR turns on.

- If the record tab on a cassette is removed, playback will start automatically.
- If a cassette is already in the VCR, turn on the VCR.

3 Start Playback

Press PLAY ►.

- When you want to play back the same tape repeatedly, press and hold PLAY ► for more than 5 seconds. (See "Repeat playback" on page 15.)

To rapidly locate a particular scene

Press FF ►► or REW ◀◀ during playback. (No sound comes out.)

To resume playback, press PLAY ► again.

- If FF ►► or REW ◀◀ is held down for more than 2 seconds, simply releasing it will cancel the search.

To stop playback

Press STOP ■.

To rewind the tape

Press REW ◀◀ when the tape is not running.

To fast forward the tape

Press FF ►► when the tape is not running.

To eject the tape

Press EJECT ▲.

To turn off the VCR

Press POWER.

When playing back an NTSC tape on a PAL TV

- Some TVs shrink the picture vertically and place black bars at the top and the bottom of the TV screen.
- The time counter and remaining tape length will not be correct.

Recording

When using this VCR, an index mark is always marked at the beginning of every recording. This index marks make it easier for you to search for the beginning of the recordings (see "Index Search" (→P.15).)

Make sure....

- The record tab on the cassette is not removed.
- Your VCR, TV, and antenna are connected correctly.
- The remote control operation mode is set correctly for operating your target component.
 - Press VCR to operate the VCR.
 - Press TV to operate the TV.
- ONLY FOR VR388/55: This VCR can record a tape only in SP (Standard Play) mode. You cannot select the tape speed even if you press SPEED.

1 On TV

- 1 Turn on the TV.
- 2 Select the video channel (or external video input).

2 On VCR

Insert a cassette with the record tab in place.

The VCR turns on.

- If a cassette is already in the VCR, turn on the VCR.

To rewind the tape, press REW ◀◀.

3 ONLY FOR VR588/55: Select Tape Speed

Press SPEED until the desired tape speed {SP, LP or SLP (For NTSC tape only)} appears on the display.

4 Select a Channel

Press CH ▲ / ▼ or Number buttons to select the channel to record.

5 Start Recording

Press REC/OTR ●.

To pause recording

Press STILL/SLOW ► briefly (or STILL/PAUSE ■ on the front panel). To resume recording, press the same button again.

To stop recording

Press STOP ■.

To watch another TV programme while recording

Select a different channel you want to watch on the TV.

You can watch the programme of the selected channel on the TV, without affecting recording on the VCR.

Erase protection

Cassettes have the record tab to ensure that recordings are not accidentally erased.

To prevent accidental erasure:

Break off the record tab with a screwdriver.

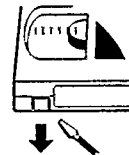

To record again:

Cover the opening with adhesive tape.

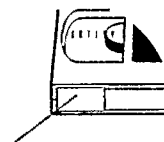

Adhesive tape

One Touch Recording (OTR)

The OTR function lets you quickly specify how long you want a recording to continue. You do not have to programme the timer.

Make sure....

- The record tab on the cassette is not removed.
- Your VCR, TV, and antenna are connected correctly.
- The remote control operation mode is set correctly for operating your target component.
 - Press VCR to operate the VCR.
 - Press TV to operate the TV.

1 On TV

- 1 Turn on the TV.
- 2 Select the video channel (or external video input).

2 On VCR

Insert a cassette with the record tab in place.

The VCR turns on.

- If a cassette is already in the VCR, turn on the VCR.

To rewind the tape, press REW ◀◀.

3 Select Channel

Press CH ▲ / ▼ or Number buttons to select the channel to record.

4 Start OTR

Press REC/OTR ● twice.

Recording starts immediately, and the ● (Record) indicator lights up on the display.

This indicates that the VCR will automatically shut off after 30 minutes of recording.

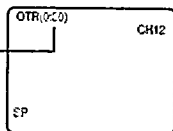

5 Select Recording Length

Press REC/OTR ● repeatedly until the desired recording length appears. Each time you press the button, recording length increases in 30-minute intervals.

For VR588/55:

→0:30→1:00→1:30.....8:30→9:00
←REC (Normal recording)←

For VR388/55:

→0:30→1:00→1:30.....4:30→5:00
←REC (Normal recording)←

To check time remaining during an OTR

Press EXIT/STATUS.

To change the recording length during an OTR

Press REC/OTR ● until the desired length appears.

To cancel an OTR

Press STOP ■ to stop recording before the preset recording length is reached. If you want to cancel the OTR mode but continue recording, press REC/OTR ● several times until "OTR" changes to "REC" on the TV screen.

Notes on the indications on the display while an OTR operation

- During recording, the displayed time counts down. When "0:00" is reached, recording stops and the VCR turns off automatically.
- If an OTR is engaged during pause, the displayed time counts down normally, but recording does not begin until you cancel the pause.

Index Search

You can locate an index marked at the beginning of each recording on a tape recorded on this VCR (or an indexed tape).

Press INDEX ►► or INDEX ◀◀ repeatedly until the appropriate number is displayed on the TV screen before starting play. Rapid forward or reverse search begins. When it finds the designated index, playback starts automatically.

- Locate an index number by pressing the button repeatedly, indicating how many index marks ahead of or behind that recording you want is from the tape's current position.
- Up to ±9th index mark from the current position on the tape can be located.

Automatic Operations

Auto playback

When a tape is inserted, the VCR turns on. If the record tab is removed, playback begins.

Repeat playback

When you press and hold PLAY ► for more than 5 seconds, you can play back the same tape repeatedly (50 times). When the tape runs to its end, the VCR automatically rewinds the tape, and starts playback.

Auto rewind

When a tape reaches its end during playback, fast forwarding, or manual recording, the VCR rewinds the tape and stops.

Memory rewind power off

When you press POWER during rewinding, the VCR turns off after rewinding is completed.

Eject cassette

You can eject the tape simply by pressing EJECT ▲ even while the VCR is turned off.

When you press EJECT ▲, the VCR automatically turns on, ejects the tape, then turns off.

ADVANCED OPERATIONS

Using On-Screen Display

You can display the VCR operating status on the TV screen.

For the information about what you can see on the TV screen, see page 8.

1 Select VCR Set Up Mode

- 1 Press VCR.
- 2 Press MENU.
- 3 Press \blacktriangle or \blacktriangledown to select "VCR SET UP" then press OK/ \blacktriangleright .

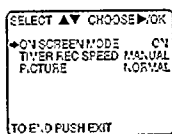

The VCR Set Up menu appears.

2 Select On-Screen Mode

- 1 Press \blacktriangle or \blacktriangledown to select "ON SCREEN MODE."
- 2 Press OK/ \blacktriangleright .

Each time you press the button, the setting changes.

ON:

When you press a tape running button (Stop, Play, etc.), the VCR status appears for 5 seconds.

COUNTER:

When you press a tape running button, the VCR operating status appears for 5 seconds.

After 5 seconds, the VCR status disappears except the time counter.

OFF:

The VCR operating status does not appear even if you press a tape running button.

3 Finish Setting

Press EXIT/STATUS.

To display the VCR status on the TV screen manually, press EXIT/STATUS. The VCR status appears for about 5 seconds.

- If "ON SCREEN MODE" is set to "OFF," no VCR status appears though you press EXIT/STATUS.

Picture Control

To get a better picture when viewing tapes with noise such as rental tapes.

1 Select VCR Set Up Mode

- 1 Press VCR.
- 2 Press MENU.
- 3 Press \blacktriangle or \blacktriangledown to select "VCR SET UP" then press OK/ \blacktriangleright .

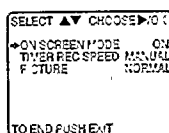

The VCR Set Up menu appears.

2 Select Picture Control Mode

- 1 Press \blacktriangle or \blacktriangledown to select "PICTURE."
- 2 Press OK/ \blacktriangleright .

Each time you press the button, the setting changes.

NORMAL:

Select this when you play back a tape with no picture adjustments.

ENHANCER:

Select this when you want to make a playback picture softer.

INCREDIBLE:

Select this when you want to make a playback picture sharper.

3 Finish Setting

Press EXIT/STATUS.

Special Effect Playbacks

Are you familiar with tape playback? If so, you are ready to enjoy the special effect playback features described below.

To skip playback for a certain period

Press SKIP SEARCH (For VR588/55) or S. SEARCH (For VR388/55) during playback to search forward for 30 seconds by the time counter reading. Each time you press the button, the search time increases as follows:

30 \rightarrow 60 \rightarrow 90 \rightarrow 120 sec.

The VCR automatically resumes normal playback after searching for the specified period.

To view a still picture

Press STILL/SLOW \blacktriangleright briefly (or STILL/PAUSE \blacksquare on the front panel) during playback.

Playback is frozen and a still picture appears.

To resume playback, press PLAY \blacktriangleright .

To view a slow motion picture

Press STILL/SLOW \blacktriangleright (or STILL/PAUSE \blacksquare on the front panel) for more than 2 seconds during playback.

To decrease the slow motion speed (and reverse the slow motion playback), press SLOW/BACK \blacktriangleleft (for VR588/55) or STILL/SLOW \blacktriangleleft (for VR388/55).

To increase the slow motion speed (and forward the slow motion playback), and press SLOW/FORWARD \blacktriangleright (for VR588/55) or STILL/SLOW \blacktriangleright (for VR388/55).

To resume playback, press PLAY \blacktriangleright .

Notes:

- No sound comes out during special effect playbacks.
- If you keep viewing slow motion and still pictures for 5 minutes, the VCR automatically stops to protect the tape and video heads.
- During special effect playbacks, some noise bars will appear on the TV screen.

Tracking Adjustments

Auto tracking

Each time a tape is inserted, auto tracking starts working and continuously analyses the signal to adjust for optimum picture quality during playback. So, there is no need for you to minimize noises in most tapes during playback.

Manual tracking

- **During normal playback:**
If auto tracking cannot eliminate noises well during playback, press CHANNEL ▲ or ▼ on the front panel.
- **During a slow motion picture:**
Press CHANNEL ▲ or ▼ on the front panel to minimize noises in the slow motion picture.
- **During a still picture:**
Press CHANNEL ▲ or ▼ on the front panel to reduce jitter in the still picture.

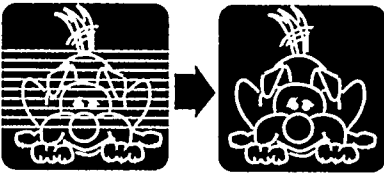

To cancel manual tracking, stop the tape, eject the tape, then re-insert it.

Timer Recording

To record while you're away, follow step 1 — 10 below. For each programme you set, the VCR will turn on, start recording, and turn off automatically. You can store up to 8 programmes.

Make sure....

- The clock is set to the correct time before setting timer recording.
- A cassette is inserted in the VCR and the record tab of the cassette must not be removed.
- The remote control operation mode is set correctly for operating your target component.
 - Press VCR to operate the VCR.
 - Press TV to operate the TV.
- **ONLY FOR VR388/55:** This VCR can record a tape only in SP (Standard Play) mode. You cannot select the tape speed even if you press SPEED.

FOR EACH STEP BELOW, YOU NEED TO FINISH WITHIN 60 SECONDS; OTHERWISE, PROGRAMMING WILL HAVE TO BE RESTARTED FROM STEP 1.

1 Select Timer Mode

Press **TIMER**.
The Timer Recording menu appears.

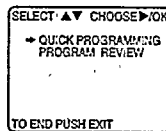

2 Select Programme mode

1 Press ▲ or ▼ to select "QUICK PROGRAMMING" then press **OK/▶**.

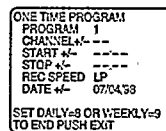

The Quick Programming menu appears.

- If you have already made 8 programmes, "ALL PROGRAMS IN USE" appears and goes back to the Timer Recording menu. If this happens, delete unwanted programmes (→P.18).

3 Select Channel

Press **CH ▲** or **▼** to enter the TV channel.

- To record from external line input, press **CH ▲** or **▼** until "A/V REAR" or "A/V FRONT" appears on the TV screen.

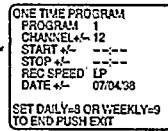

4 Select Start Time

Press **START +** or **-** (Number button 1 or 4).

- Each time you press the button, the set time changes by 1-minute intervals. If you hold the button, the set time changes by 30-minute intervals.



5 Select Stop Time

Press **STOP +** or **-** (Number button 2 or 5).

- Each time you press the button, the set time changes by 1-minute intervals. If you hold the button, the set time changes by 30-minute intervals.



6 ONLY FOR VR588/55: Select Tape Speed

Press **SPEED**.

- Each time you press the button, the tape speed alternates between "LP" and "SP."



7 Select Start Date

Press **DATE +** or **-** (Number button 3 or 6).

- Each time you press the button, the set date changes by 1-day intervals. If you hold the button, the set date changes by 15-day intervals. You can only specify the date within one year.
- The year and day of the week is displayed automatically.

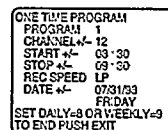

To be continued on the next page

8 Select Recording Type

If you want to record the same programme daily, press **DAILY** (Number button 8).

The VCR will record a TV programme every day (Monday through Friday) at the same time and length. (Daily Recording)

If you want to record the same programme weekly, press **WEEKLY** (Number button 9).

The VCR will record a TV programme once a week at the same day, time, and length. (Weekly Recording)

If you want to cancel the currently set programme, press **CLEAR**.

9 Confirm Programme

Press **EXIT/STATUS**.

"PROGRAM WAS COMPLETED" appears on the TV screen.

After 5 seconds, the above message disappears, and the normal TV picture resumes. The **(Timer)** indicator lights up on the display.

- If "PROGRAM NOT COMPLETED" appears, try again from step 1.

If you want to store other programmes, repeat steps 1 to 8.

10 Finish Settings

Press **POWER** to turn off the VCR.

After a timer recording has taken place

Press **POWER** to turn on the VCR. You can operate your VCR normally.

To stop a started timer recording

Press **POWER**.

Recording stops and the VCR turns off. If it is a Daily or Weekly Recording, future recordings will be carried out as programmed.

Useful function for Timer Recording: Auto Tape Speed

With this function activated, the VCR can change the tape speed and record the programme in SLP mode unless enough tape remains for recording in SP mode.

- 1 Press **VCR**.
- 2 Press **MENU**.
- 3 Press **▲** or **▼** to select "VCR SET UP" then **▶**.
- 4 Press **▲** or **▼** to select "TIMER REC SPEED."

- 6 Press **OK/▶**.

Each time you press the button, the setting changes.

AUTO:

Select this to allow the VCR to change the tape speed from SP to SLP when there is not enough tape length remaining.

MANUAL:

Select this not to allow the VCR to change the tape speed.

- 7 Press **EXIT/STATUS** to exit from the menu operations.

To check, edit or erase the programmes

- 1 Turn on the VCR and TV.
- 2 Press **VCR**.
- 3 Press **TIMER**.
- 4 Press **▲** or **▼** to select "PROGRAM REVIEW" then press **OK/▶**.

The list of the timer recording programmes appears.

- 5 Press **OK/▶** repeatedly to view the more detailed programme information.

- When you press the button for the first time, the detailed programme information for Programme 1 appears. By pressing this button repeatedly, you can review the detailed information of all other programmes.

PR	CH	START	STOP	DATE
1	12	09:30	10:00	D07/31
2	13	10:00	10:45	MON
3	125	11:30	01:00	DAILY
4	45	15:00	15:15	W06/16
5				
6				
7				
8				
NEXT=▶		END=EXIT		

ONE TIME PROGRAM
PROGRAM 1
CHANN.EL+ 12
START +/- 09 30
STOP +/- 10 00
REC.SPEED LP
DATE +/- 07/31/83
FR DAY
SET DAILY=5 OR WEEKLY=0
TO END PUSH EXIT

- 6 If you want to change the programme setting shown on the TV screen, press the following buttons:
 - CH ▲/▼**: Changes the channel.
 - START +/-**: Changes the start time.
 - STOP +/-**: Changes the stop time.
 - SPEED**: Changes the tape speed.
 - DATE +/-**: Changes the date.

If you want to erase the programme setting shown on the TV screen, press **CLEAR**. The detailed information of the next programme appears.

- 7 Press **EXIT/STATUS** to exit from the menu operations.

Note:

This function does not work for OTR (One Touch Recording).

How to see the programme list

①	②	③	④	⑤
PR	CH	START	STOP	DATE
1	12	09:30	09:30	D07/31
2	13	10:00	10:45	MON
3	125	11:30	01:00	DAILY
4	45	15:00	15:15	W06/16
5				
6				
7				
8				
NEXT=▶		END=EXIT		

- ① Programme numbers
- ② Preset channel numbers
- ③ Start time
- ④ Stop time
- ⑤ Start date

"D" stands for "DAILY," and "W" stands for "WEEKLY."

- If the programme has worked once for the Daily recording, "DAILY" will be shown instead of the start date.
- If the programme has worked once for the Weekly recording, the day of the week (in this example, "MON") will be shown instead of the start date.

Connection Diagram

- 1 Connect the recording VCR (this VCR) and the playing VCR.
- 2 Connect the recording VCR (this VCR) to the TV.

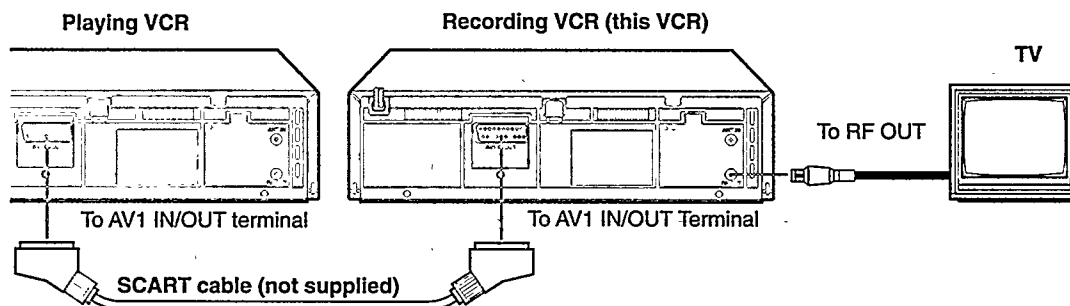

Dubbing from any VHS VCR (or video camera) to another is simple. Explanations on this page uses this VCR as the recording VCR. Refer also to the manual supplied with the other VCR (for playback).

- You can also use the AUDIO/VIDEO input jacks on the front panel to connect another VCR or video camera. If you use these jacks on the front panel, they have the priority over the ones on the rear panel.

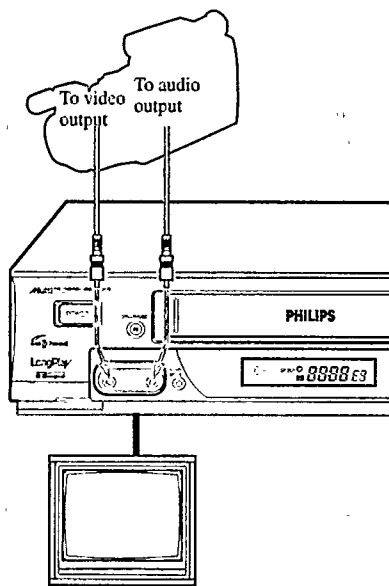

Make sure....

- To record from the AUDIO/VIDEO IN jacks on the rear panel, make sure no connection is made to the AUDIO/VIDEO input jacks on the front panel.
- The remote control operation mode is set correctly for operating your target component.
 - Press VCR to operate the VCR.
 - Press TV to operate the TV.
- ONLY FOR VR388/55: This VCR can record a tape only in SP (Standard Play) mode. You cannot select the tape speed even if you press SPEED.

1 At VCRs

Insert a source tape in the playing VCR and a blank tape in the recording VCR.

- If a tape without the record tab is inserted in the playing VCR, playback automatically starts. In this case, press the STOP button.
- If the VCR indicator on the recording VCR (this VCR) does not light up, press VCR/TV once.

2 At TV

Turn the channel on the TV to your video channel.

3 Select Line Input

Press CH ▲ or ▼, pointing the remote control at this VCR, to select the external line input.

- For rear jacks, select "L-1" on the display or "A/V REAR" on the TV screen.
- For front jacks, select "L-F" on the display or "A/V FRONT" on the TV screen.

4 Select Tape Speed

Press SPEED, pointing the remote control at this VCR, until the desired tape speed {SP, LP or SLP (For NTSC, tape only)} appears on the display.

5 Play Back Tape

Press the PLAY ► button on the playing VCR.

6 Record (Copy) Tape

Press REC/OTR, pointing the remote control at this VCR.

Remember: press the buttons in steps 5 and 6 simultaneously to avoid missing any of the recording.

BEFORE REQUESTING SERVICE

Check the following points once again if you are having some difficulties with your VCR.

IMPORTANT

Periodic maintenance is required in order to maintain the VCR's continuous excellent performance. After a period of time the video heads will require replacement. If cleaning or replacement of the video heads is required, this service should be performed at an authorized video system service center.

Power

No power.

Correction

- Check that the AC power cord is correctly connected to an AC outlet.
- Check that the VCR is turned on.

Recording & Playback

TV programme cannot be recorded.

Correction

- Check the connections between the VCR, the antenna, and the TV.
- Make sure that the record tab on the back of the cassette is not removed. (→P.14)

Timer recording cannot be performed.

- Set the timer on-time and timer off-time correctly. (→P.17)
- Make sure that the VCR is turned off after setting is made. (→P.18)
- Timer recording may not be performed or stopped if a power interruption occurs before or during timer recording. If the power resumes within one minute, timer recording will also resume.

There is no playback picture, or the playback picture is noisy or contains streaks.

- Select your video channel correctly.
- Adjust the tracking slowly in either direction. (→P.17)

During a still or slow motion picture, the picture may contain some vertical jitter when using a TV which has an automatic vertical hold control.

- Adjust the vertical hold control manually on the TV, if available.

If the top of your playback picture waves back and forth excessively.

- Because the VCR playback signal is not as stable as an off-the-air TV signal, the top of your TV screen may be bent or unstable during playback. To solve this problem, slowly turn the horizontal hold control on your TV to correct the wavy picture. If your TV does not have the horizontal hold control or adjusting the control does not help, contact your local TV service center.

Remote Control

The remote control cannot work.

Correction

- Aim the remote control directly at the remote sensor on the VCR.
- Avoid all obstacles which may interfere with the signal path.
- Inspect or replace the batteries. (→P.5,7)
- Make sure batteries are inserted correctly. (→P.5,7)

Miscellaneous

A cassette cannot be inserted.

The cassette does not eject.

The cassette ejects when you press REC/OTR ●, or when you press POWER to set timer recording.

Correction

- Insert the cassette with the window side up and the record tab facing you.
- Check that a cassette tape is not already inserted. Press EJECT ▲.
- Check that the AC power cord is correctly connected to an AC outlet.
- If the ⏸ (Timer) indicator is lit on the display, press POWER to cancel timer recording, then press EJECT ▲.
- Check that the record tab on the back of the cassette is not removed. (→P.14)

SPECIFICATIONS

Design and specifications are subject to change without notice.

General

Mains voltage	AC 110 – 240V [~]
Mains frequency	50/60Hz
Power consumption	Approx. 18 watts
Ambient temperature	+5°C to +40°C
Relative humidity	10% to 80%
Dimensions	Approx. 400(W) x 94(H) x 265(D) mm
Mass	Approx. 3.1kg
Position for use	Horizontal
Video output channel	UHF E36 (adjustable between E28 — E60)
Possible number of TV channel	48
Number of pre-programmable memory blocks	8
Number of days in advance	365 or every day, or every week

Tuner

Aerial input	B/G, D/K, I, SECAM K1
VHF L:	42 — 175 MHz
VHF H:	175 — 470 MHz
UHF:	470 — 870 MHz
	CATV

Video

Input (VIDEO IN)	0.5 to 2.0 V _{p-p} , 75 ohms
Output (VIDEO OUT)	1.0±0.2 V _{p-p} , 75 ohms
Resolution	Better than 240 lines
Signal/noise ratio	Better than 43 dB

Audio

Input (AUDIO IN)	–8 dBs, 50k ohms (0dBs=0.775 V _{rms})
Output (AUDIO OUT)	–6 dBs, 1k ohms (0dBs=0.775 V _{rms})

Accessories supplied

Remote control unit
RF coaxial cable
Batteries – R6(SUM-3)/AA (only for checking operations)
SCART cable (for VR388/55 only)

THE BEST CHOICE FOR YOUR VIDEO CASSETTE RECORDER

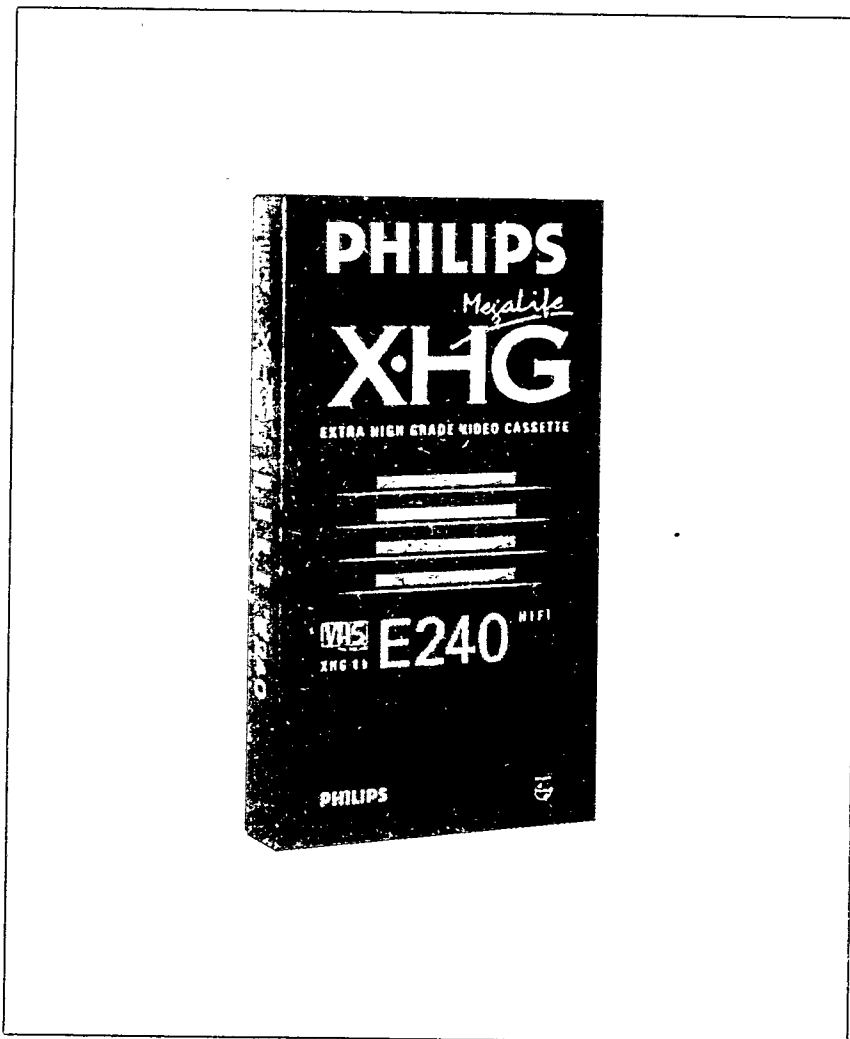

Philips offers a full range of High Grade &
Extra High Grade Video Cassettes.



PHILIPS

LPT0091-001A

Free Manuals Download Website

<http://myh66.com>

<http://usermanuals.us>

<http://www.somanuals.com>

<http://www.4manuals.cc>

<http://www.manual-lib.com>

<http://www.404manual.com>

<http://www.luxmanual.com>

<http://aubethermostatmanual.com>

Golf course search by state

<http://golfingnear.com>

Email search by domain

<http://emailbydomain.com>

Auto manuals search

<http://auto.somanuals.com>

TV manuals search

<http://tv.somanuals.com>