

PHILIPS **MAGNAVOX**

Video Cassette Recorder

VRZ222AT



Owner's Manual

I M P O R T A N T !

Return Your Warranty Registration Card
Within 10 Days. See Why Inside.

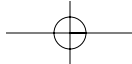

Return your Warranty Registration card today to ensure you receive all the benefits you're entitled to.

Once your PHILIPS MAGNAVOX purchase is registered, you're eligible to receive all the privileges of owning a PHILIPS MAGNAVOX product. So complete and return the Warranty Registration Card enclosed with your purchase at once. And take advantage of these important benefits.

Warranty Verification

Registering your product within 10 days confirms your right to maximum protection under the terms and conditions of your PHILIPS MAGNAVOX warranty.

Owner Confirmation

Your completed Warranty Registration Card serves as verification of ownership in the event of product theft or loss.

Model Registration

Returning your Warranty Registration Card right away guarantees you'll receive all the information and special offers which you qualify for as the owner of your model.

PHILIPS MAGNAVOX

Congratulations on your purchase, and welcome to the "family!"



Dear PHILIPS MAGNAVOX product owner:

Thank you for your confidence in PHILIPS MAGNAVOX. You've selected one of the best-built, best-backed products available today. And we'll do everything in our power to keep you happy with your purchase for many years to come.

As a member of the PHILIPS MAGNAVOX "family," you're entitled to protection by one of the most comprehensive warranties and outstanding service networks in the industry.

What's more, your purchase guarantees you'll receive all the information and special offers for which you qualify, plus easy access to accessories from our convenient home shopping network.

And most importantly you can count on our uncompromising commitment to your total satisfaction.

All of this is our way of saying welcome-and thanks for investing in a PHILIPS MAGNAVOX product.

Sincerely,

Robert Minkhorst
President and Chief Executive Officer

P.S. Remember, to get the most from your PHILIPS MAGNAVOX product, you must return your Warranty Registration Card within 10 days. So please mail it to us right now!

Know these

safety symbols



This "bolt of lightning" indicates uninsulated material within your unit may cause an electrical shock. For the safety of everyone in your household, please do not remove product covering.

The "exclamation point" calls attention to features for which you should read the enclosed literature closely to prevent operating and maintenance problems.

WARNING: TO PREVENT FIRE OR SHOCK HAZARD, DO NOT EXPOSE THIS EQUIPMENT TO RAIN OR MOISTURE.

CAUTION: To prevent electric shock, match wide blade of plug to wide slot, and fully insert.

ATTENTION: Pour éviter les chocs électriques, introduire la lame la plus large de la fiche dans la borne correspondante de la prise et pousser jusqu'au fond.

For Customer Use

Enter below the Serial No. which is located on the rear of the cabinet. Retain this information for future reference.

Model No. _____
Serial No. _____

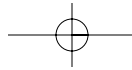

Introduction 3

Welcome to your VCR owner's manual.

This manual has six sections: Setting Up Your VCR; Description of Controls; Basic Operations; Recording; Playing; and Information You May Need. The instructions explain all of the VCR's features, which are listed below. You cannot hurt your VCR by trying the features! So read on – and relax.

Features

- High Quality (HQ) System
- Automatic Channel Setup
- On-Screen Displays in English or Spanish
- Display Panel
- Digital Auto Tracking System
- One-Touch Recording
- Timer Recording
- Special Effects Playback: Forward and Reverse Searching; Still
- Remote Control with capability to operate TV
- Repeat Play
- Automatic Operation Features
- Real-Time Counter
- Daylight-Saving Time
- The VCR Plus+ Programming System
- Automatic Head Cleaner

Safety Precautions

Warning: To prevent fire or shock hazard, do not expose this equipment to rain or moisture.

Federal Communications Commission Warning: Any unauthorized changes or modifications to this equipment void the user's authority to operate it.

This VCR is equipped with a High Quality (HQ) system and is compatible with existing Video Home System (VHS) equipment. Philips Consumer Electronics Company recommends that you use only video cassette tapes that have been tested and inspected for use in two, four, six, and eight hour VCRs, and which are labeled with the **VHS** mark. The use of tapes that have not been inspected for use in two, four, six, and eight hour VCRs may result in poor picture quality and excessive deposits on the video heads, which may not be covered by the warranty if damage occurs.

Note to the Cable TV System Installer: This reminder is provided to call the Cable TV system installer's attention to Article 820-40 of the National Electrical Code, which provides guidelines for proper grounding – in particular, specifying that the cable ground shall be connected to the grounding system of the building, as close to the point of cable entry as possible.

Copyright 1998 Philips Consumer Electronics Company. All rights reserved. VCR Plus+™ and PlusCode® are trademarks of Gemstar Development Corporation. The VCR Plus+ Programming system is manufactured under license from Gemstar Development Corporation.

4 Table of Contents

Setting Up Your VCR

Introduction	3
Table of Contents	4
Before Using Your VCR	5
Hookups Without a Cable Box/Direct Broadcast System	6 - 7
Hookups With a Cable Box/Direct Broadcast System	8 - 9
Hookups With a Stereo TV	10
Turning on Your VCR	11
Automatic Channel Setup	12 - 14
Setting the Clock	15
Daylight-Saving Time	16
Language Selection	17

Description of Controls

Remote Control Buttons	18 - 19
On-Screen Status Displays	20
VCR Display Panel	21
Front Panel	22
Rear Panel	23

Basic Operations

Playing	24
Recording	25

Recording

Recording One Channel/Watching Another	26
One Touch Recording	27
Timer Recording	28 - 31
Setting Up the VCR Plus+ Programming System	32 - 33
Timer Recording With the VCR Plus+ Programming System	34 - 35
Rerecording (Tape Duplication)	36

Playing

Repeat Play	37
Real-Time Counter Memory	38
Special Effects Playback	39
Automatic Operation Features	40

Information You May Need

Specifications	41
Helpful Hints	42 - 43
Glossary	44
Limited Warranty	45
Index	46
Supplied Accessories	48



Before Using Your VCR 5

Removing the Plastic Cover from the Front Panel

A thin, plastic cover may protect the front panel of your VCR. Before using the VCR, lift a corner of the plastic, then peel it off.

Putting Batteries in the Remote Control

1

Remove the battery compartment lid on the bottom of the remote control by sliding it in the direction of the arrow.

2

Place two AA batteries inside the battery compartment with their + and - ends aligned as indicated.

3

Replace the battery compartment lid.

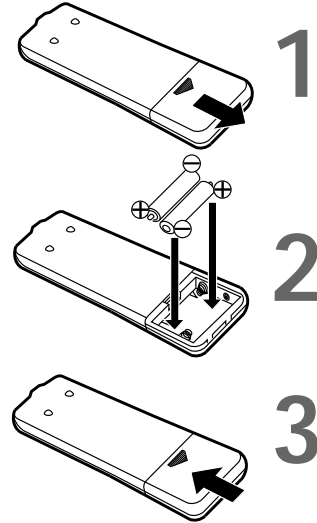

Using the Remote Control

- Point the remote control at the VCR, then press the VCR button, when using the remote control to operate the VCR.
- If you have a Magnavox television, point the remote control at the TV, then press the TV button, when using the remote control to operate the TV.

Erasure Prevention

Video cassette tapes have record tabs to ensure that recordings are not erased accidentally.

1

To prevent erasure, break off the tab with a screwdriver.

2

To record again, cover the hole with cellophane tape.

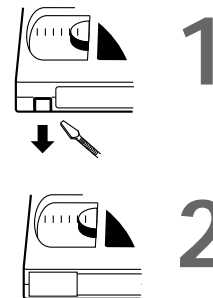

VCR maintenance

- Use only tapes with the **VHS** mark.
- Remove any light adhesive stick-on notes from the video cassette tape before putting the tape in the VCR. Removable labels can jam the VCR.
- Periodic maintenance is required to maintain your VCR's excellent performance. This VCR has an Automatic Head Cleaner. However, the video heads will require replacement eventually. Only an authorized service center should perform this service.

Helpful Hints

- Do not mix alkaline and manganese batteries.
- Do not mix old and new batteries.

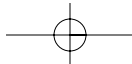

6 Hookups Without a Cable Box / Direct Broadcast System

The basic VCR/TV connection – antenna/cable to VCR to TV – is shown below. If you have a Cable Box or a Direct Broadcast System, please see pages eight-nine. If you have a Stereo TV, please see page 10. After you hook up the VCR, go to page 11 to turn on the VCR.

1

Disconnect the antenna or cable from your TV.

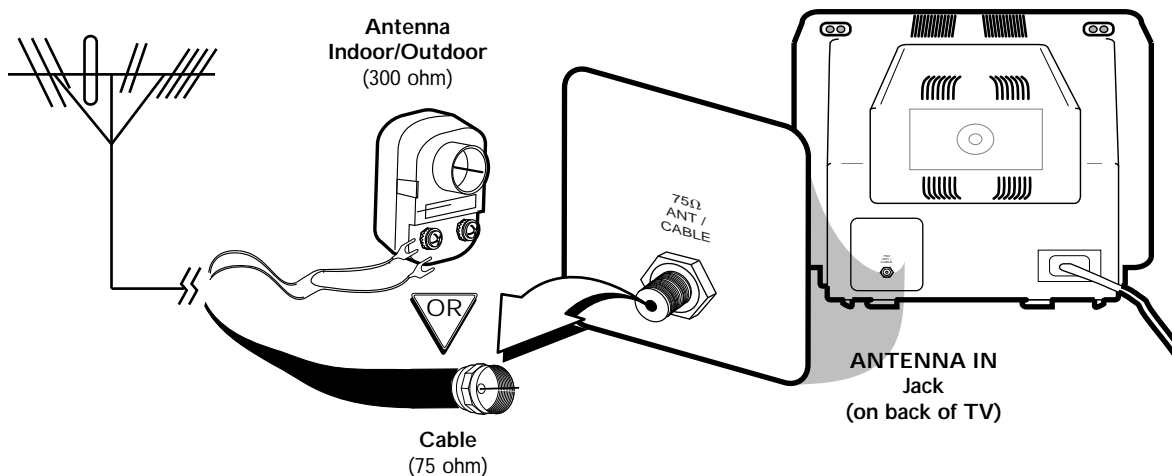

2

Connect the antenna or cable to the ANT(enna) IN Jack of your VCR.

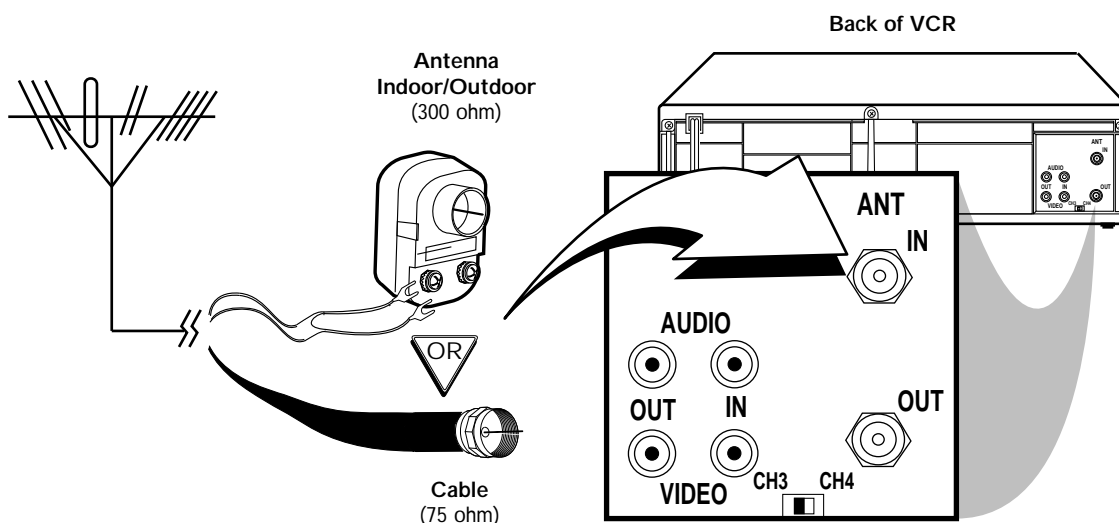

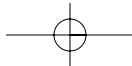

Hookups Without a Cable Box / Direct Broadcast System (cont'd) 7

3

Connect the RF coaxial cable (supplied) to the **OUT** Jack on the back of the **VCR** and to the **ANTENNA IN** Jack on the **TV**. (You may use either a snap-on type (supplied) or screw-on type of coaxial cable, whichever you prefer.)

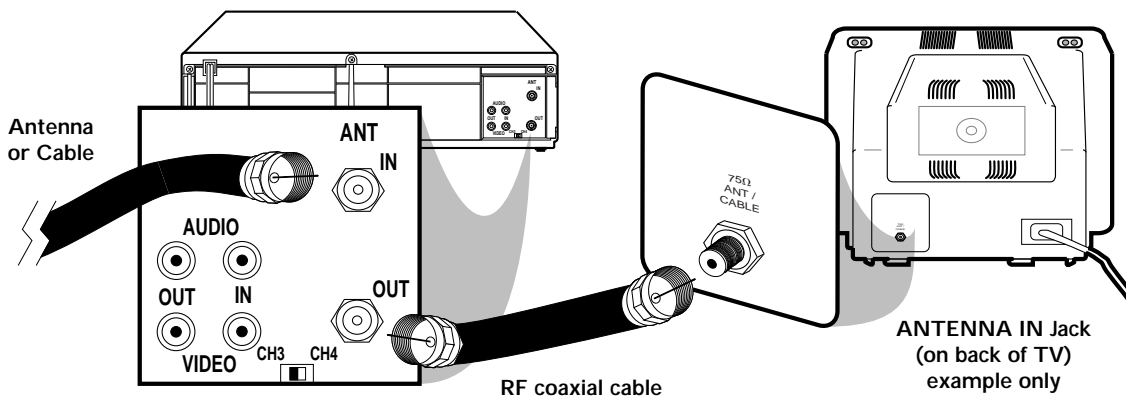

4

Plug in the TV and the VCR.

5

Set the **CH3/CH4** switch on the back of the **VCR** to **CH3** or **CH4**, whichever channel is not used or least used in your area. Set the **TV** to the same channel. For example, when playing a tape, if the **CH3/CH4** switch is set to **CH3**, the TV should be on channel 03.

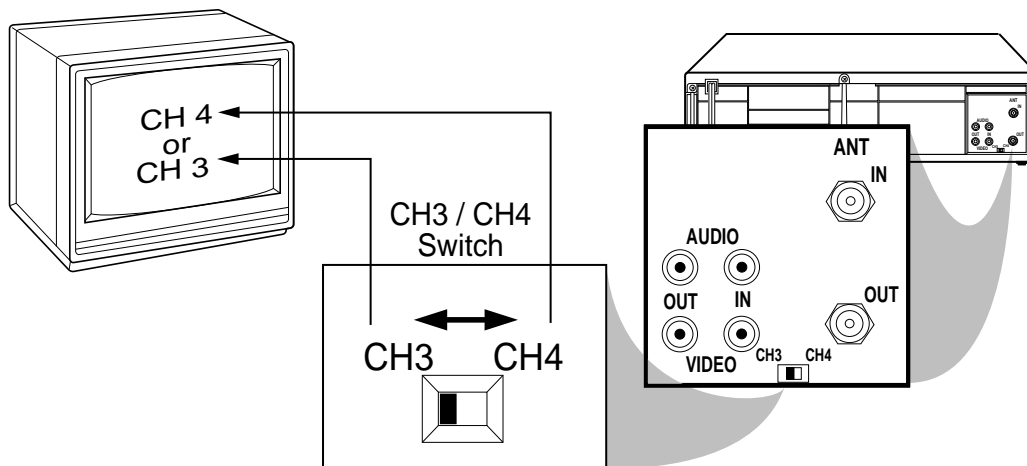

6

You are ready to turn on the **VCR**. Please go to page 11 before turning on the **VCR**.

8 Hookups With a Cable Box / Direct Broadcast System

There are two ways to connect your Cable Box/DBS to the VCR. With this connection:

- You may view any channel.
- You must select channels at the Cable Box/DBS. Channels cannot be changed at the VCR.
- You may not view a channel other than the one you are recording.
- You may not program channels at the VCR.
- You can only program a timer recording for one channel at a time. Set the TV and the VCR to the Cable Box/DBS output channel (channel 03 or 04), and set your Cable Box/DBS to the channel you want to record. When you enter the channel you want to record in a timer recording, select channel 03 or 04 (the Cable Box/DBS output channel). (This is step 5 on page 29.) Leave the Cable Box/DBS on for a timer recording.

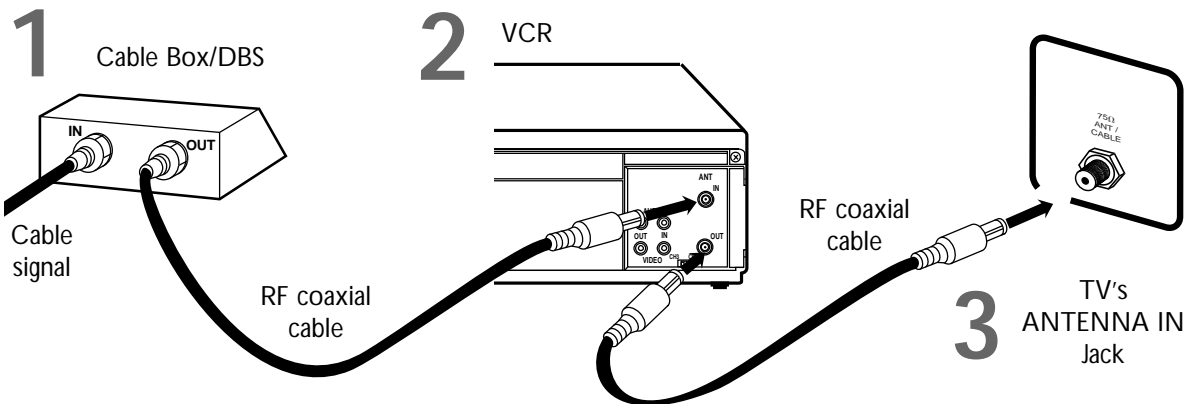

Connections

1

Connect a Cable signal to the IN Jack on the Cable Box/DBS.

2

Use an RF coaxial cable (supplied) to connect the OUT Jack on the Cable Box/DBS to the ANT(enna) IN Jack on the VCR.

3

Use a second RF coaxial cable to connect the OUT Jack on the VCR to the TV's ANTENNA IN Jack.

Recording/Viewing Any Channel

1

With the VCR on and in VCR position (the VCR light will appear on the display panel), use the **CHANNEL ▲/▼** buttons to set the VCR to the Cable Box/DBS output channel (channel 03 or 04).

2

Set the TV to the same channel to which you set the VCR.

3

Select the channel you want to view/record at the Cable Box/DBS.

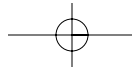

Hookups With a Cable Box / Direct Broadcast System (cont'd) 9

With this connection:

- You may watch one channel while recording another.
- You may not record scrambled channels.

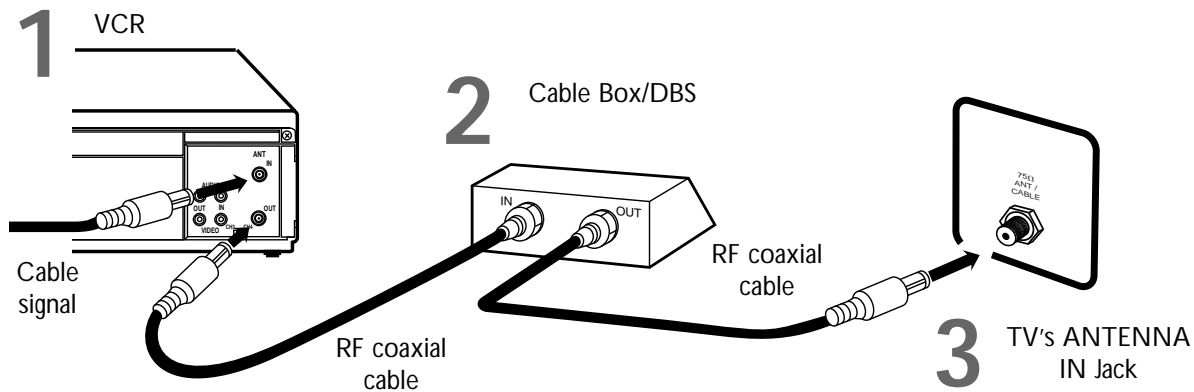

Connections

1

Connect a Cable signal to the VCR's ANT(enna) IN Jack.

2

Use an RF coaxial cable (supplied) to connect the OUT Jack on the VCR to the IN Jack on the Cable Box/DBS.

3

Use a second RF coaxial cable to connect the OUT Jack on the Cable Box/DBS to the ANTENNA IN Jack on the TV.

Recording One Channel/Watching Another

1

Put the Cable Box/DBS on the same channel as the VCR's CH3/CH4 switch. Then, with the VCR in VCR position (the VCR light will appear on the display panel), use the **CHANNEL ▲/▼** buttons to select the channel you want to record at the VCR. Start the recording.

2

Press the VCR/TV button once to put the VCR in TV position. (The VCR light will disappear.)

3

Set the TV to the Cable Box/DBS output channel (03 or 04).

4

Select the channel you want to watch at the Cable Box/DBS.

Helpful Hint

- When you play a tape, make sure the Cable Box/DBS is set to the same channel as the CH3/CH4 switch on the VCR. Set the TV to the Cable Box/DBS output channel (03 or 04).



10 Hookups With a Stereo TV

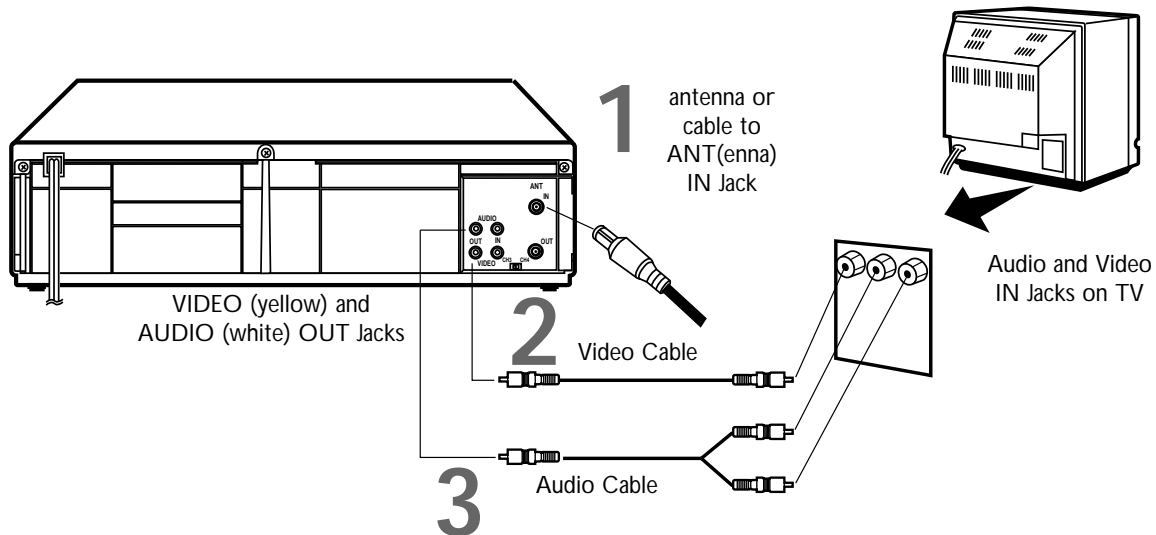

- Audio and Video cables are not supplied.

1

Connect the antenna or cable to the **ANT(enna) IN Jack** on the back of the VCR.

2

Connect a video cable to the yellow **VIDEO OUT Jack** on the back of the VCR. Then, connect the other end of the video cable to the **VIDEO IN Jack** on your TV.

3

Connect an audio cable to the white **AUDIO OUT Jack** on the back of the VCR. Then, connect the other end of the audio cable to the **AUDIO IN Jack** on your TV. (If your TV has Right and Left **AUDIO IN Jacks**, you must use a "Y" splitter audio cable as illustrated to deliver audio to the TV's right and left channels.)

4

Turn on your TV, making sure it is in Line Input mode. Please refer to your TV owner's manual for details.

Helpful Hint

- This hookup will not give you stereo sound. To get stereo sound, use the connections on pages six - seven and select the channel to be viewed at the TV (with the VCR turned off).

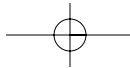

Turning on Your VCR 11

Before turning on your VCR, make sure batteries are in the remote control and the VCR and TV are connected correctly.

- Follow the steps on this page only when you plug the VCR power cord into the wall outlet for the first time.
- You can not set up channels if you are using a Cable Box or a Direct Broadcast System.

1

Press the **VCR** button, then the **POWER** button. The VCR light and the PWR. (power) light will appear on the display panel.

2

Turn on the TV. Set it to the same channel as the **CH3/CH4** switch on the back of the VCR. The display shown below will appear. (If the display does not appear, check your hookups, then follow the steps on page 12 to set up channels and page 17 to select a language.)

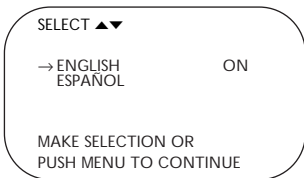

3

Within 60 seconds, press the **PLAY/▲** button or the **STOP/▼** button to select English or Spanish on-screen displays.

4

Press the **MENU** button. The display shown below will appear.

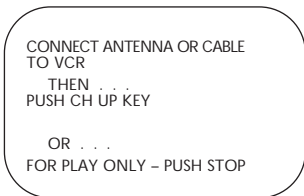

5

Within 60 seconds, press the **CHANNEL ▲** button to begin automatic channel setup. AUTO SET PROCEEDING PLEASE WAIT will appear on-screen. The VCR will memorize all available channels. When all channels are programmed, CHANNELS ARE SET will appear on-screen briefly, then TV programming will appear.

Now, when you press the **CHANNEL ▲/▼** buttons, you'll only scan through channels that you receive.

2 Turn on the TV.

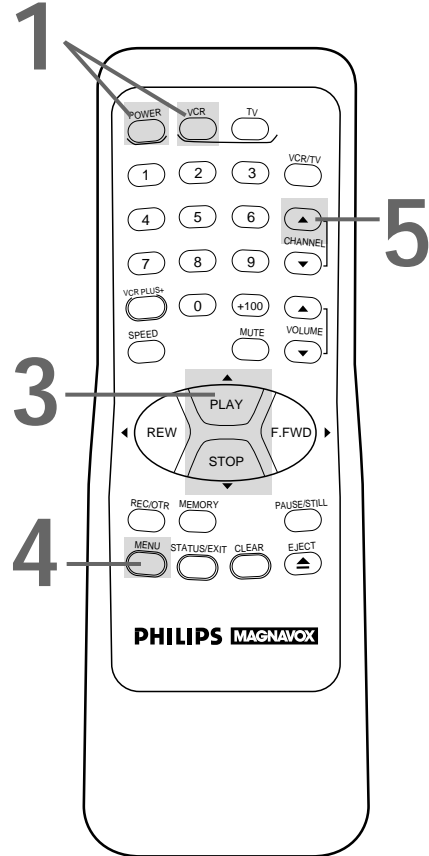

Helpful Hints

- To skip this feature and play a tape immediately, insert a tape with its record tab removed. Or, to skip step 3, press the **MENU** button. All on-screen displays will be in English. To skip step 5, press the **STOP** button. Channels will not be programmed, and **CHANNELS NOT SET** will appear on-screen.
- If you try to set up channels when there is no antenna or cable connected to the VCR, programming will appear to take place, but eventually a **NO TV SIGNALS** message will appear. Connect an antenna or cable to the VCR's **ANT(enna) IN Jack** and try again. You may need to follow the steps on page 12.



12 Automatic Channel Setup

Although your VCR may automatically memorize the channels you receive when you turn it on for the first time, this function lets you set up the channels again.

1

Press the **VCR** button.

2

Press the **MENU** button.

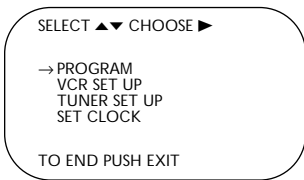

3

Press the **PLAY/▲** button or the **STOP/▼** button to select **TUNER SET UP**, then press the **F.FWD/▶** button.

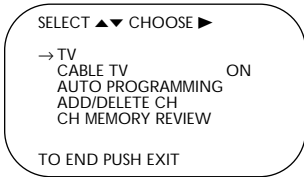

4

Press the **PLAY/▲** button or the **STOP/▼** button to select **TV** (if you have an antenna) or **CABLE TV** (if you have a cable connection). Then, press the **F.FWD/▶** button. **ON** will appear beside your choice.

5

Press the **PLAY/▲** button or the **STOP/▼** button to select **AUTO PROGRAMMING**, then press the **F.FWD/▶** button. The VCR will place all the channels you receive into its memory.

6

Wait for a few minutes while the VCR sets up the channels. When this is complete, **CHANNELS ARE SET** will appear on-screen. Then the programming of the lowest channel number placed in the VCR's memory will appear on-screen. Now when you press the **CHANNEL ▲/▼** buttons, you will scan only through channels you receive.

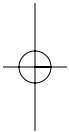
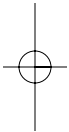
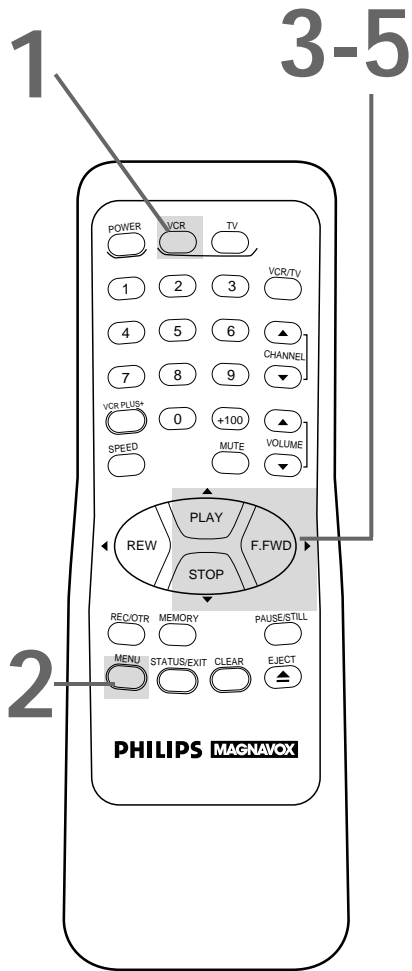

Helpful Hints

- You can not enter the **TUNER SET UP** menu when you are in **Line Input mode (channel 00)**. When you select channel 00, **AV IN** will appear on-screen briefly.
- You can not program channels if you are using a **Cable Box** or **DBS**.

Automatic Channel Setup (cont'd) 13

Adding/Deleting Channels

1

Press the VCR button.

2

Press the MENU button.

3

Press the PLAY/▲ button or the STOP/▼ button to select TUNER SET UP, then press the F.FWD/▶ button.

4

Press the PLAY/▲ button or the STOP/▼ button to select ADD/DELETE CH, then press the F.FWD/▶ button.

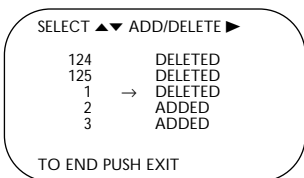

5

Press the PLAY/▲ button or the STOP/▼ button until the channel number you want to add or delete appears beside the arrow.

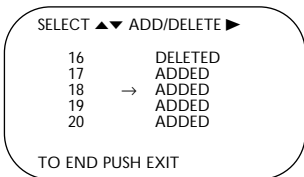

6

Press the F.FWD/▶ button to select ADDED or DELETED.

7

Press the STATUS/EXIT button.

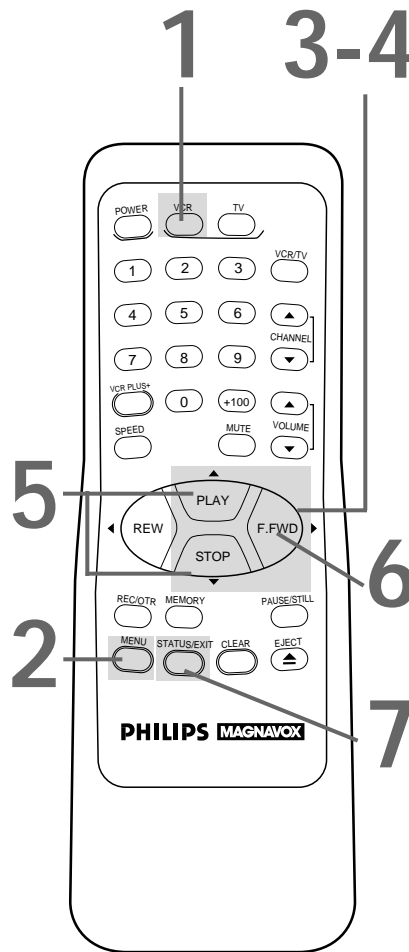

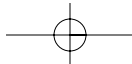

14 Automatic Channel Setup (cont'd)

Reviewing Memorized Channels

1

Press the VCR button.

2

Press the MENU button.

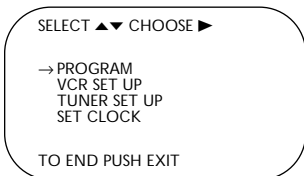

3

Press the PLAY/▲ button or the STOP/▼ button to select TUNER SET UP, then press the F.FWD/▶ button.

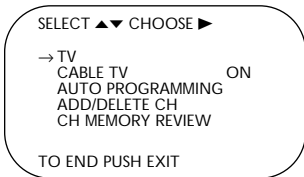

4

Press the PLAY/▲ button or the STOP/▼ button to select CH MEMORY REVIEW, then press the F.FWD/▶ button. A list of programmed channels will appear on-screen.

- If all the programmed channels don't fit on the screen, press the F.FWD/▶ button to see the remaining channels. Then press the REW(ind)/◀ button to return to the first screen of channels.
- If you do not press any buttons within 10 seconds, you will either go to the next screen of channels or you will return to the previous menu.

5

Press the STATUS/EXIT button once or twice to exit.

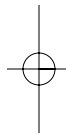
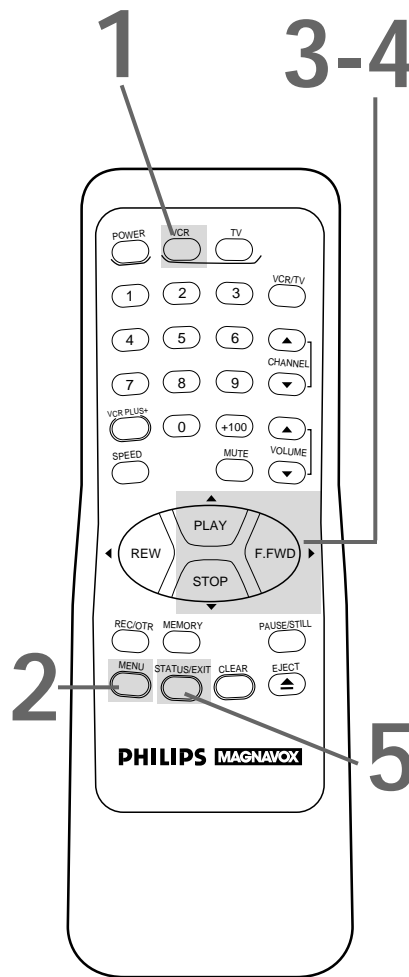

Setting the Clock 15

Follow the steps below to set your VCR's clock. Make sure:

- The VCR is on and the VCR light appears on the display panel. (If it does not, press the VCR/TV button once.)
- You make each entry within 60 seconds of the previous entry.

1

Press the VCR button.

2

Press the MENU button.

3

Press the PLAY/▲ button or the STOP/▼ button to select SET CLOCK, then press the F.FWD/▶ button.

4

Press the PLAY/▲ button or the STOP/▼ button to select SET CLOCK, then press the F.FWD/▶ button.

5

Press two Number buttons for the hour(s) and two Number buttons for the minute(s). Then press 1 for AM or 2 for PM. For example, for 2:15 PM, press 02, 15, 2.

6

Press two Number buttons for the month, two Number buttons for the day, and two Number buttons for the year. For example, for July 1, 1998, press 07, 01, 98. The day of the week will appear automatically.

7

Press the STATUS/EXIT button.

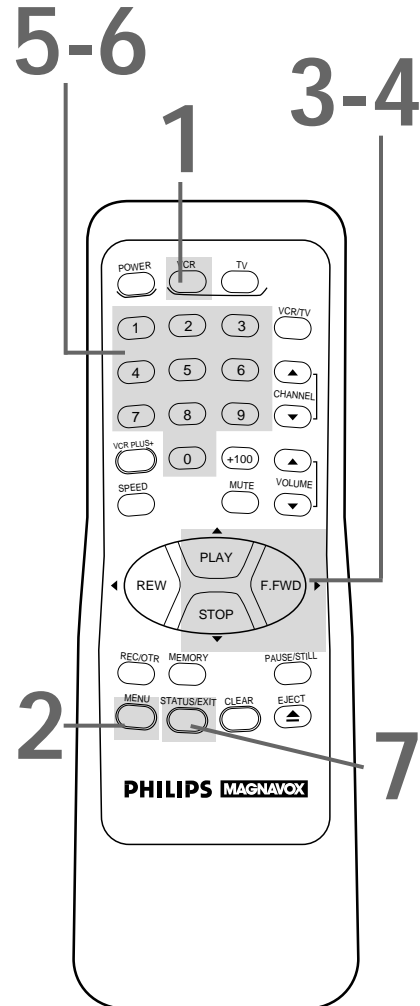

Helpful Hints

- Enter a 0 before a single digit number.
- Entries that do not match the VCR's calendar will cause a question mark to appear on-screen.
- To make corrections, press the CLEAR button until the space for the number you want to correct is flashing. Then enter the correct number.
- The current time will appear on the VCR display panel when the clock is set. The current time will also appear on-screen if you press the STATUS/EXIT button. (See page 20 for details.)
- Power failures that last for more than one minute can cause you to lose your clock setting.

16 Daylight-Saving Time

You may program the VCR so its clock will automatically move forward one hour in April and turn back one hour in October. Daylight-Saving Time is set to ON when you receive your VCR. Turn Daylight-Saving Time ON or OFF by following the steps below. Before you begin:

- Make sure the clock is set.

1

Press the VCR button.

2

Press the MENU button.

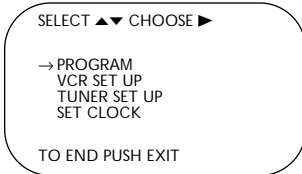

3

Press the PLAY/▲ button or the STOP/▼ button to select SET CLOCK, then press the F.FWD/► button.

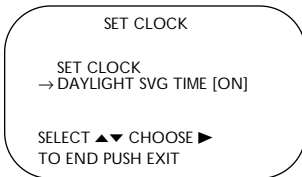

4

Press the PLAY/▲ button or the STOP/▼ button to select DAYLIGHT SVG TIME. Then, press the F.FWD/► button so that OFF (or ON) appears beside DAYLIGHT SVG TIME.

5

Press the STATUS/EXIT button.

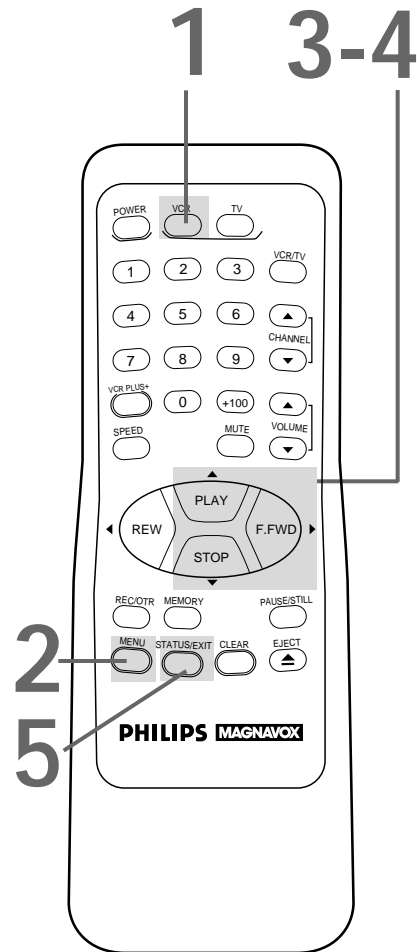

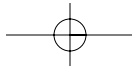

Language Selection 17

Follow the steps below to change the language of the on-screen displays.

1

Press the VCR button.

2

Press the MENU button.

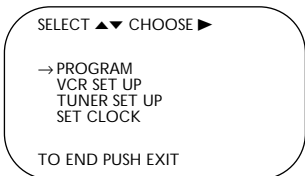

3

Press the PLAY/▲ button or the STOP/▼ button to select VCR SET UP, then press the F.FWD/▶ button.

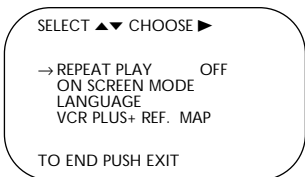

4

Press the PLAY/▲ button or the STOP/▼ button to select LANGUAGE, then press the F.FWD/▶ button.

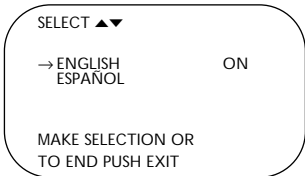

5

Press the PLAY/▲ button or the STOP/▼ button to select English or Spanish on-screen displays.

6

Press the STATUS/EXIT button.

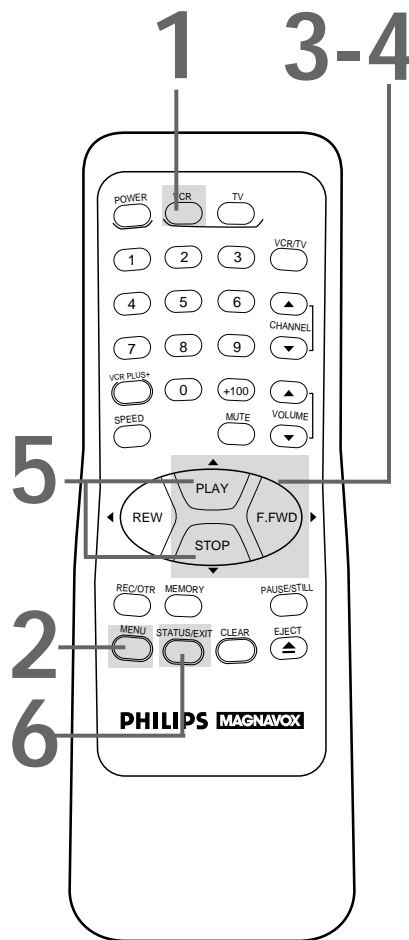

Helpful Hint

- If you accidentally select Spanish on-screen displays and need English on-screen displays:

 1. Press the VCR button.
 2. Press the MENU button.
 3. Press the PLAY/▲ button or the STOP/▼ button to select PREPARE EL VCR, then press the F.FWD/▶ button.
 4. Press the PLAY/▲ button or the STOP/▼ button to select LENGUAJE, then press the F.FWD/▶ button.
 5. Press the PLAY/▲ button or the STOP/▼ button to select ENGLISH.
 6. Press the STATUS/EXIT button.

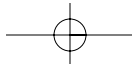

18 Remote Control Buttons

POWER Button
Press to turn on or off the VCR or a Magnavox TV. (You must first press the VCR or TV button.)

Number Buttons
Use to select channels at the VCR or a Magnavox TV; use to set up VCR features (such as the clock).

Channels 1 - 9 ●
To select, press 0, then the channel number you want. For example, to select channel 7, press 0, 7.

Channels 100 and above ●
To select, press the +100 button, then press the last two digits of the channel you want. For example, to select channel 117, press the +100 button, 1, 7. (You can not select channels above 99 at the Magnavox TV.)

VCR PLUS+ Button
Press to set a timer recording with the VCR Plus+ programming system. *Details are on pages 32 - 35.*

SPEED Button
Press to select the recording speed (SP, LP, or SLP). *Details are on pages 30 and 44.*

REW(ind)/◀ Button
When tape playback is stopped, press to rewind the tape at high speed. During playback, press to rewind the tape while the picture stays on-screen. *Details are on page 39.* Or, if you have a Magnavox TV, use the REW(ind) button to adjust the picture controls in the TV menu.

MEMORY Button
Press to memorize a tape position at which the real-time counter was set to 0:00:00. *Details are on page 38.*

REC(ord)/OTR Button
Press once to start a recording. *Details are on page 25.* Or, press repeatedly to start a One-Touch Recording. *Details are on page 27.*

MENU Button
Press to access the VCR menu. Or, if you have a Magnavox TV, press the TV button, then press the MENU button to display the TV menu.

STATUS/EXIT Button
Press to access or remove the on-screen status display. *Details are on page 20.* Press to exit on-screen menus. Or, if you have a Magnavox TV, press the TV button, then press the STATUS/ EXIT button, to see a TV status display or to remove the TV menu.

PLAY/▲ Button
Press to play a tape; press to release Search or Still mode and return to normal playback. *Details are on page 39.* Press to select an item in the on-screen menu. Or, if you have a Magnavox TV, press when in TV mode to move up one row or selection in the TV menu.

Helpful Hint

- Press the VCR button before pressing VCR feature buttons; press the TV button before pressing TV feature buttons if you have a Magnavox TV.

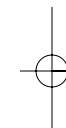
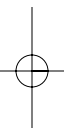

Remote Control Buttons (cont'd) 19

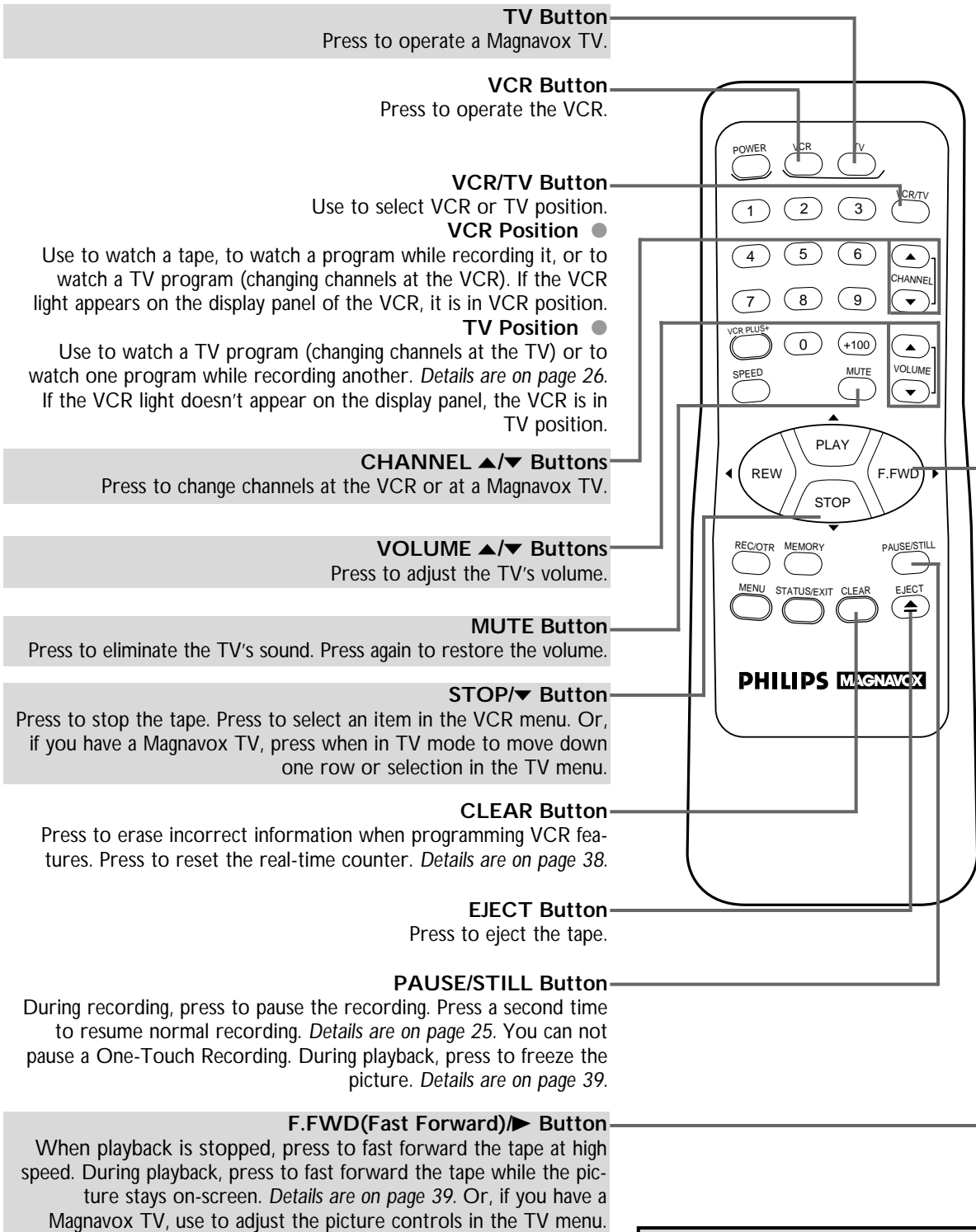

Helpful Hint

- Buttons with a shaded description may also operate features of a Magnavox TV.

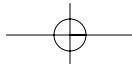

20 On-Screen Status Displays

A status display will appear when you press the STATUS/EXIT button or certain function buttons. The contents of the status display will vary. To choose the status display mode, follow the steps below.

If you select STATUS ON, then select COUNTER ONLY ON:

- Whenever you press the STOP/▼ button or the PLAY/▲ button, the status display will appear for five seconds. After five seconds, only the counter will remain on-screen. You must press the STATUS/EXIT button to remove it.

If you select STATUS ON, then select COUNTER ONLY OFF:

- Whenever you press the STOP/▼ button or the PLAY/▲ button, the status display will appear for five seconds.

If you select STATUS OFF:

- The status display will not appear when you press function buttons. You must press the STATUS/EXIT button to see the status display.

Status Display (example only)

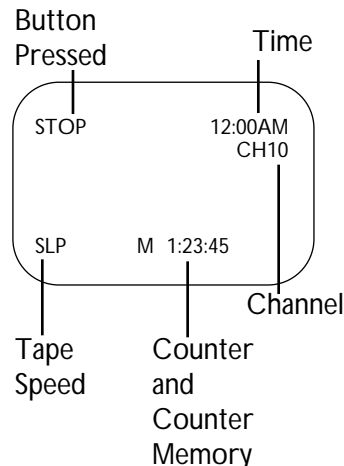

1

Press the VCR button, then press the MENU button.

2

Press the PLAY/▲ button or the STOP/▼ button to select VCR SET UP, then press the F.FWD/▶ button.

3

Press the PLAY/▲ button or the STOP/▼ button to select ON SCREEN MODE, then press the F.FWD/▶ button.

4

Press the PLAY/▲ button or the STOP/▼ button to select STATUS, then press the F.FWD/▶ button so that OFF (or ON) appears beside STATUS.

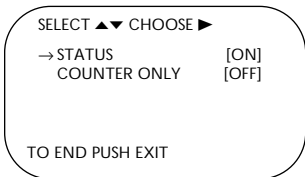

5

If you set STATUS to OFF, go to step 6. If you set STATUS to ON, press the PLAY/▲ button or the STOP/▼ button to select COUNTER ONLY, then press the F.FWD/▶ button so that OFF (or ON) appears beside it.

6

Press the STATUS/EXIT button.

Helpful Hints

- If the channel you select has no broadcast, the screen will become solid blue.
- You may not access a status display when viewing a still picture or when the F.FWD/▶ or REW(ind)/◀ button is pressed during playback.

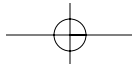

VCR Display Panel 21

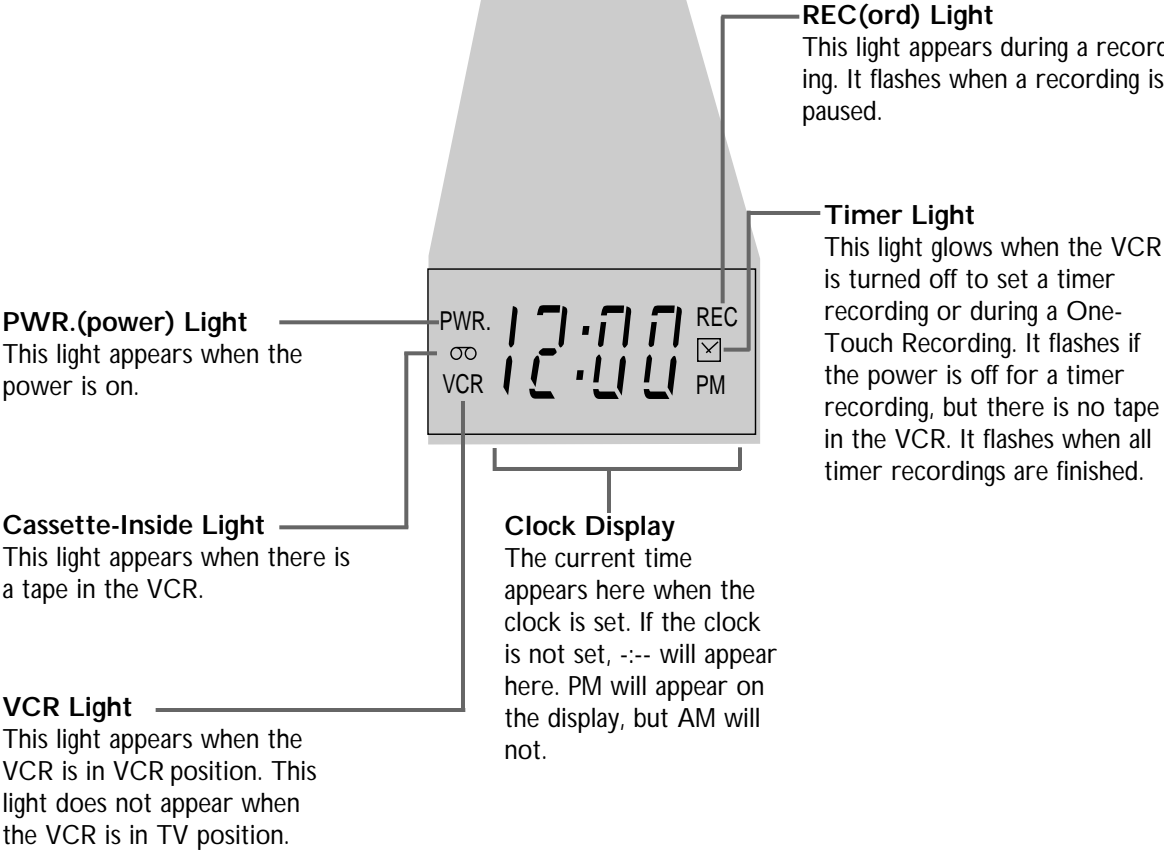
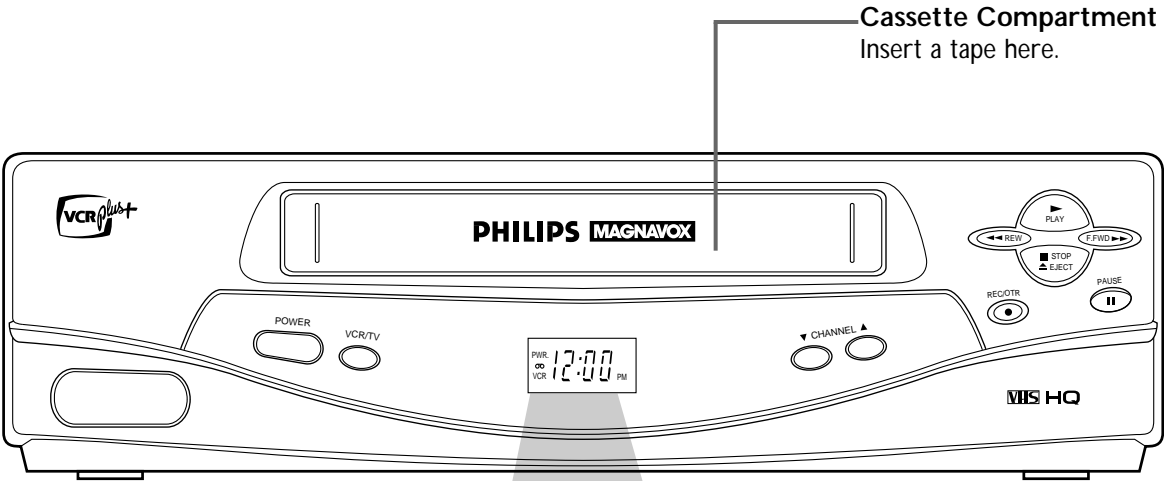

22 Front Panel

Remote Sensor

Receives a signal from your remote control so you can operate your VCR from a distance.

POWER Button

Press to turn the VCR power on and off.

F.FWD (Fast Forward) Button

When playback is stopped, press to fast forward the tape at high speed. During tape playback, press to fast forward while the picture stays on-screen. *Details are on page 39.*

STOP/EJECT Button

Press once to stop the tape. When playback is stopped, press to eject the tape.

PLAY Button

Press to play a tape. Press to release Search or Still mode and return to playback. *Details are on page 39.*

REW(ind) Button

When playback is stopped, press to rewind the tape at high speed. During playback, press to rewind the tape while the picture stays on-screen. *Details are on page 39.*

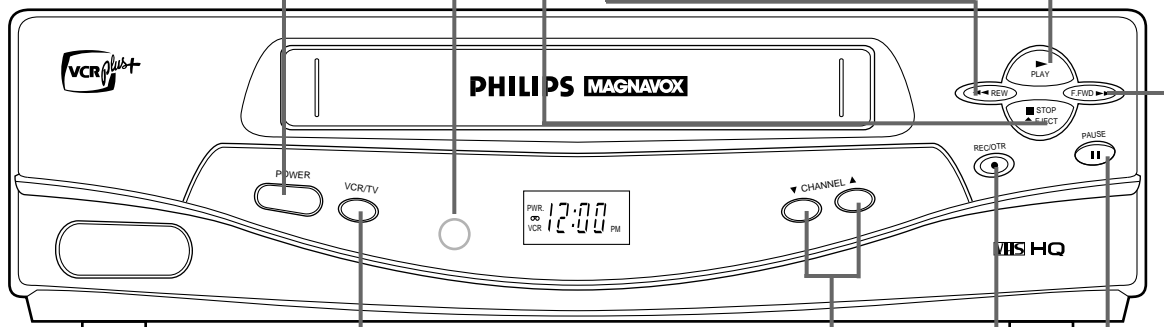

CHANNEL (▼/▲) Buttons

Press to change channels at the VCR. Or, press to adjust the tracking of a tape during playback.

VCR/TV Button

Press to select VCR or TV position.

● VCR Position

Use to watch a tape, to watch a program while recording it, or to watch a TV program (changing channels at the VCR). When the VCR light appears on the display panel, the VCR is in VCR position.

● TV Position

Use to watch TV (changing channels at the TV) or to watch one program while recording another. When the VCR light does not appear on the display panel, the VCR is in TV position.

REC(ORD)/OTR Button

Press once to start a recording. Press repeatedly to start a One-Touch Recording. *Details are on page 27.*

PAUSE Button

While recording, press to pause the recording. Press again to resume recording. *Details are on page 25.* You can not pause a One-Touch Recording. During tape playback, press to freeze the picture. *Details are on page 39.*

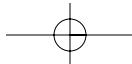

Rear Panel 23



ANT(enna) IN Jack
Connect your antenna or cable here. *Details are on pages six - 10.*

AUDIO IN Jack
Connect a cable coming from the AUDIO OUT Jack of a camcorder, another VCR, or an audio source here. *Details are on page 36.*

AUDIO OUT Jack
Connect a cable going to the AUDIO IN Jack of a camcorder, another VCR, or an audio source here. *Details are on page 36.*

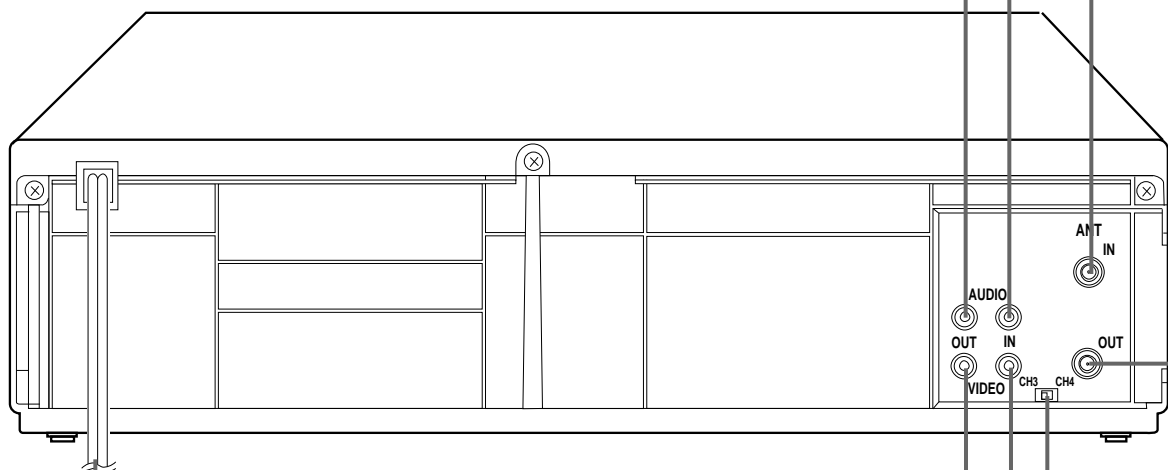

VIDEO OUT Jack
Connect a cable going to the VIDEO IN Jack of a camcorder, another VCR, or an audio-visual source (laser disc player, video disc player, etc.) here. *Details are on page 36.*

VIDEO IN Jack
Connect a cable coming from the VIDEO OUT Jack of a camcorder, another VCR, or an audio-visual source (laser disc player, video disc player, etc.) here. *Details are on page 36.*

AC Power Cord
Connect to a standard AC outlet to supply power to the VCR.

CH3/CH4 Switch
Set to channel 3 or 4 to use your TV with your VCR. *Details are on pages six - nine.*

OUT Jack
Use the supplied RF coaxial cable to connect this jack to the ANTENNA IN Jack on your TV, Cable Box, or Direct Broadcast System. *Details are on pages six - nine.*

24 Playing

Read and follow the steps below to play a tape.

1

Turn on the TV and set it to channel 03 or 04, whichever the CH3/CH4 switch on the back of the VCR is set to.

2

Insert a tape in the VCR. The PWR., VCR, and Cassette-Inside lights will appear on the display panel. If the tape's record tab has been removed, playback will start automatically.

3

If playback does not start automatically, press the PLAY/▲ button.

4

Press the STOP/▼ button on the remote control or the STOP/EJECT button on the VCR once to stop playback.

5

Press the REW(ind)/◀ button to rewind the tape.

6

When the tape stops, press the EJECT button on the remote control or the STOP/EJECT button on the VCR to remove the tape.

1

Turn on the TV.

2

Insert a tape in the VCR.

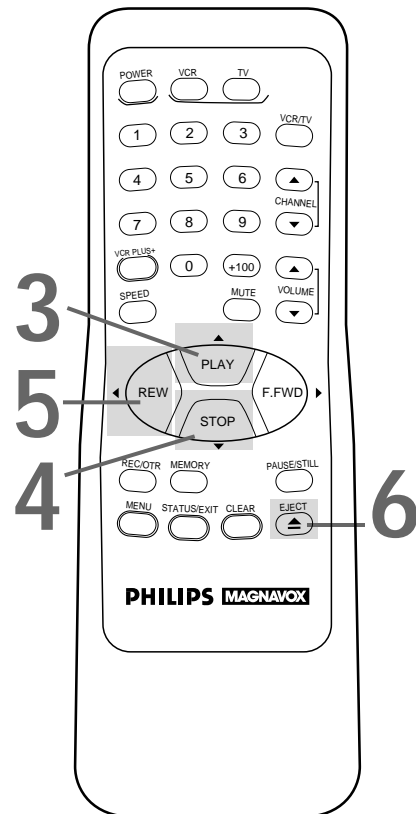

Helpful Hints

- If the tape you want to play is already in the VCR, make sure the VCR power is on and the VCR is in VCR position. (The VCR light will appear on the display panel. If it does not, press the VCR/TV button.) Press the VCR button, then press the PLAY/▲ button.
- Other playback options and features are on pages 37 - 40.

Recording 25

Read and follow the steps below to record a television program.

1

Turn on the TV and set it to channel 03 or 04, whichever the CH3/CH4 switch on the back of the VCR is set to.

2

Insert a tape with its record tab intact in the VCR.

3

Press the VCR button.

4

If the VCR light appears on the display panel, go to step 5. If the VCR light does not appear, press the VCR/TV button once.

5

Press the SPEED button until the desired tape speed appears briefly on-screen. (Details about tape speed are on page 30.)

6

Use the CHANNEL ▲/▼ buttons or the Number buttons to select the channel to be recorded.

7

Press the REC(ord)/OTR button once to start recording. The REC light will appear.

8

To pause the recording, press the PAUSE/STILL button once. The REC light will flash. To resume recording, press the REC(ord)/OTR button or press the PAUSE/STILL button again. The REC light will come on again.

9

To stop recording, press the STOP/▼ button.

1 Turn on the TV.

2 Insert a tape in the VCR.

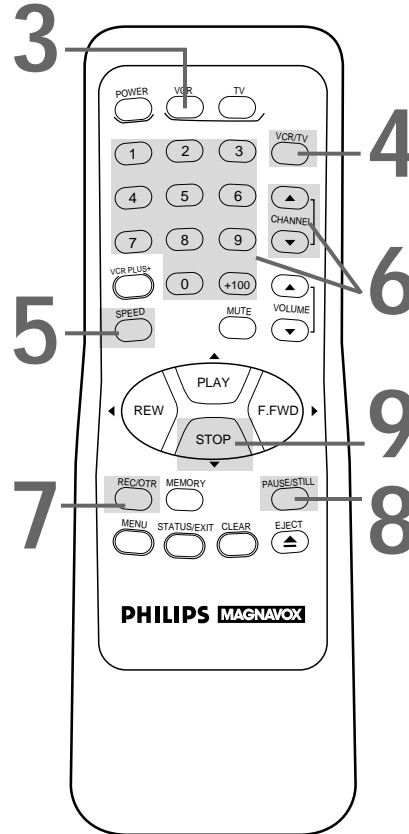

Helpful Hints

- If you press the REC(ord)/OTR button when there is not a tape in the VCR, NO CASSETTE will flash on-screen.
- If you press the REC(ord)/OTR button while a tape without a record tab is in the VCR, the VCR will eject the tape and PROTECTED CASSETTE CANNOT RECORD will flash on-screen.
- Other recording options are on pages 26 - 36.
- You can change the tape speed during a recording, but some distortion will appear on the tape.
- The VCR will record in a preset volume.



26 Recording One Channel/Watching Another

1

Start a recording. (See page 25.)

2

Press the VCR button.

3

Press the VCR/TV button to put the VCR in TV position. The VCR light will disappear from the VCR's display panel.

4

Choose the channel you want to watch at the TV.

5

To return to the channel being recorded, select channel 03 or 04 at the TV (whichever channel the CH3/CH4 switch on the back of the VCR is set to).

6

Press the VCR button.

7

Press the VCR/TV button to put the VCR in VCR position. The VCR light will appear on the display panel. The channel being recorded will appear on-screen.

8

Press the STOP/▼ button to stop the recording.

2&6

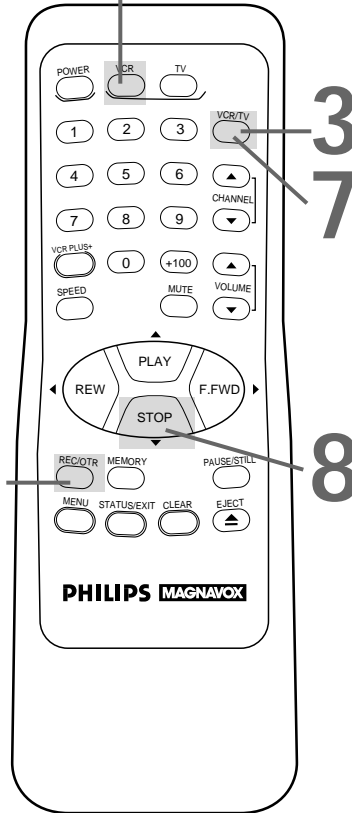

4 Select the channel you want to watch at the TV.

5 Select channel 03 or 04 at the TV.

Helpful Hints

- If you use a Cable Box or Direct Broadcast System hookup, you may not be able to watch one channel while recording another. See pages eight-nine for details.

One-Touch Recording 27

The One-Touch Recording (OTR) feature allows you to set an immediate timed recording 30 minutes to eight hours long. Before you begin:

- Set up the channels at the VCR.
- Select a recording speed (SP, LP, SLP) with the SPEED button.
- Put a tape in the VCR. Make sure the tape's record tab is intact and the tape is long enough to record the program(s).
- Place the VCR in VCR position. (The VCR light will appear on the display panel. If it does not, press the VCR/TV button once.)

1

Press the VCR button.

2

Press the CHANNEL ▲/▼ buttons or the Number buttons to select the channel you want to record.

3

Press the REC(ord)/OTR button repeatedly until the desired recording length (30 minutes to eight hours) appears on-screen. Recording will begin immediately. The REC light and the Timer light will appear on the display panel.

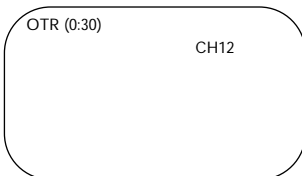

4

To stop an OTR before recording is finished, press the STOP/▼ button or the POWER button.

To cancel the OTR but continue recording, press the REC(ord)/OTR button repeatedly until REC appears in the upper left corner of the TV screen. The REC light will remain on the display panel of the VCR, but the Timer light will disappear.

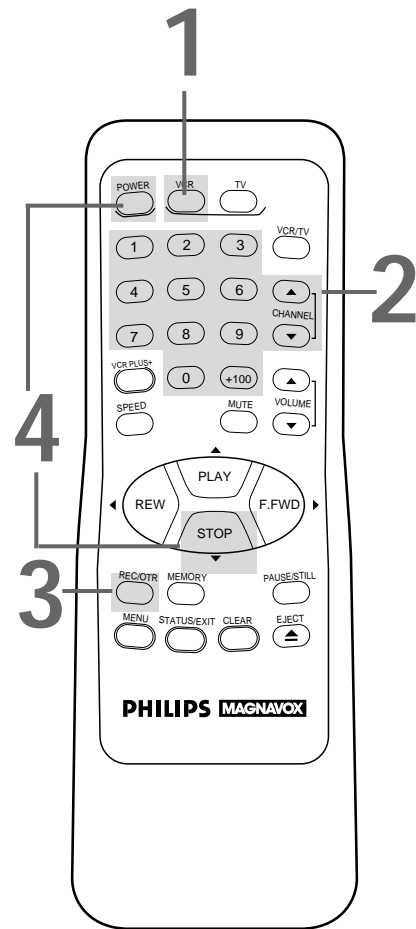

Helpful Hints

- To check the time remaining for an OTR after the OTR has been set, press the STATUS/EXIT button.
- To change the recording length while an OTR is in progress, press the REC(ord)/OTR button until the desired length appears on-screen.
- If you begin an OTR when another recording is paused, the OTR will begin.
- You can not pause an OTR.
- If the preset time for a timer recording comes up during an OTR, the OTR has priority. The timer recording will not take place.



28 Timer Recording

Follow the steps below to program your VCR to record TV programs while you're away from home. The VCR will turn itself on, record, and turn itself off automatically. Before you begin:

- Set up the channels at the VCR.
- Set the clock.
- Put a tape in the VCR. Make sure the tape's record tab is intact and the tape is long enough to record the program(s).
- Put the VCR in VCR position. The VCR light will appear on the display panel. If it does not, press the VCR/TV button once.

Do each step within 60 seconds of the previous step.

1

Press the **VCR** button, then press the **MENU** button.

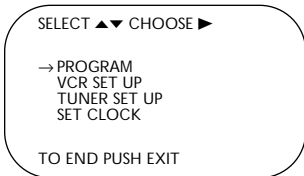

2

Press the **PLAY/▲** button or the **STOP/▼** button to select **PROGRAM**, then press the **F.FWD/▶** button.

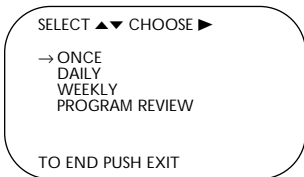

3

Press the **PLAY/▲** button or the **STOP/▼** button to select a **ONCE, DAILY, OR WEEKLY** recording. Then, press the **F.FWD/▶** button.

- **ONCE:** The VCR will record a TV program on any day you choose, up to 12 months away.
- **DAILY:** The VCR will record every day from Monday to Friday – starting at the same time and recording for the same length of time.
- **WEEKLY:** The VCR will record on the same day, at the same time, and for the same length of time every week.

Daily Recording (example)

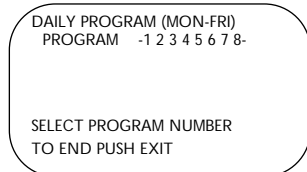

2-3

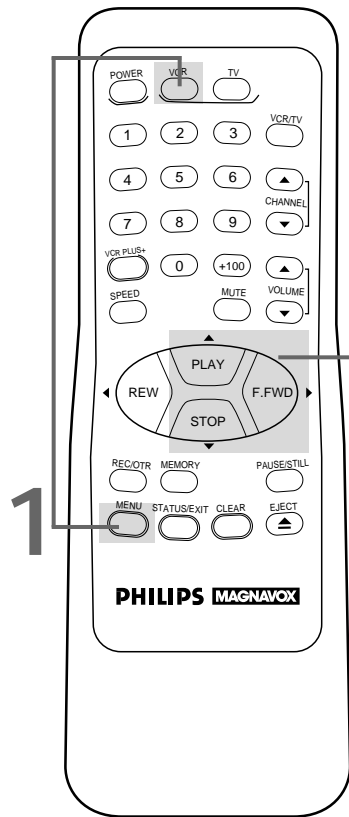

Helpful Hint

- If you need to make a correction while programming a timer recording, press the **CLEAR** button until the cursor is flashing on the item you want to change. Then enter the correct information.

Timer Recording (cont'd) 29

4

Use the Number buttons (1 - 8) to select a slot in which to store the timer recording. There are eight slots. Open slots will flash on-screen.

NOTE: If you enter a number for a slot that has already been used to store a timer recording, PREVIOUSLY SET PROGRAM will appear on-screen briefly. Information about the program in that slot will appear on-screen. If this happens, press the STATUS/EXIT button, then select another number.

5

Use the Number buttons to enter the channel you want to record.

- If you have a basic antenna or cable hookup (as shown on pages six-seven) enter the channel number of the TV program you want to record. (Enter a 0 before all single-digit channels.)
- If you are recording from line input, press 0, 0. A/V IN will appear on-screen.
- If you are using a Cable Box/DBS, enter the Cable Box/DBS output channel (03 or 04). See page eight for details.

ONE TIME PROGRAM
PROGRAM 1
CHANNEL --

TO CORRECT PUSH CLEAR
TO END PUSH EXIT

6

Press two Number buttons for the hour you want the recording to begin. Press two Number buttons for the minute you want the recording to begin. Press 1 for AM or 2 for PM. For example, for 9:30 PM, press 09, 30, 2.

ONE TIME PROGRAM
PROGRAM 1
CHANNEL 10
TIME ON ---:--

TO CORRECT PUSH CLEAR
TO END PUSH EXIT

7

Follow the instructions in step 6 to enter the recording's stop time. (AM or PM will be set automatically.)

ONE TIME PROGRAM
PROGRAM 1
CHANNEL 10
TIME ON 09:30 PM
TIME OFF ---:--

TO CORRECT PUSH CLEAR
TO END PUSH EXIT

Instructions continue on page 30.

4-7

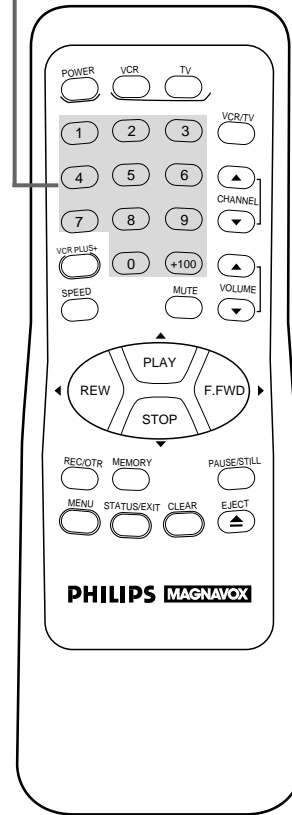

Helpful Hint

- Entries that do not match the VCR's clock or calendar will cause a question mark to appear on-screen.

30 Timer Recording (cont'd)

8

Press the Number 1 button to record in SP speed, the Number 2 button to record in LP speed, or the Number 3 button to record in SLP speed. (See the chart below.) You cannot use the SPEED button at this time.

```

ONE TIME PROGRAM
PROGRAM      1
CHANNEL     10
TIME ON     09:30 PM
TIME OFF    11:00 PM
REC SPEED   SLP
            SP=1 LP=2 SLP=3
TO CORRECT PUSH CLEAR
TO END PUSH EXIT
    
```

9

Press two Number buttons for the month and two Number buttons for the day you want to record the program. For example, for July 10, 1998, press 07, 10. The day of the week and the year will appear automatically (you cannot program the VCR to record more than one year in advance).

```

ONE TIME PROGRAM
PROGRAM      1
CHANNEL     10
TIME ON     09:30 PM
TIME OFF    11:00 PM
REC SPEED   SLP
START DATE  07/10/98
            FRI.
TO CORRECT PUSH CLEAR
TO END PUSH EXIT
    
```

10

Press the STATUS/EXIT button. PROGRAM WAS COMPLETED / PLEASE TURN OFF VCR FOR TIMER RECORDING will appear on-screen briefly. (If PROGRAM NOT COMPLETED appears, try again from step 1.)

11

Turn off the VCR power. The Timer light will appear on the display panel.

If the timer recording will take place several hours or days from now, you may use the VCR until time for the recording. Turn off the VCR a few minutes before the recording starts. If you forget to turn off the VCR, PLEASE TURN OFF VCR FOR TIMER RECORDING flashes on your TV screen two minutes before a timer recording starts. Press the CLEAR button to remove the message.

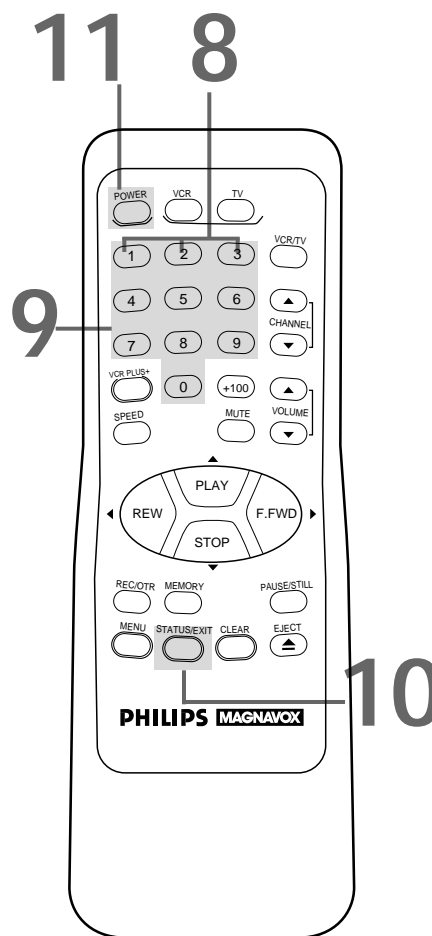

The VCR must be off for a timer recording. Put a tape in the VCR.

Tape Speeds	Tape Speed Type	Maximum Record/Playback Time		
		T160	T120	T60
This chart shows the recording/playback time for three types of video cassettes (T160, T120, and T60). There are three playback speeds: SP, LP, and SLP. When recording, you can change the tape speed using the SPEED button.	SP (Standard Play)	2 hrs. 40 mins.	2 hrs.	1 hr.
	LP (Long Play)	5 hrs. 20 mins.	4 hrs.	2 hrs.
	SLP (Super Long Play)	8 hrs.	6 hrs.	3 hrs.

Timer Recording (cont'd) 31

Checking or Cancelling Timer Recordings

1

With the VCR on and in VCR position (the VCR light will appear on the display panel), **press the VCR button, then press the MENU button.**

2

Press the **PLAY/▲** button or the **STOP/▼** button to select **PROGRAM**, then press the **F.FWD/▶** button.

3

Press the **PLAY/▲** button or the **STOP/▼** button to select **PROGRAM REVIEW**, then press the **F.FWD/▶** button.

The timer recording information for the program in the lowest numbered slot will appear on-screen. If no timer recordings are set, nothing will happen when you press the **F.FWD/▶** button.

4

Press the **F.FWD/▶** button repeatedly to review all programmed timer recordings. If you don't press the **F.FWD/▶** button within 10 seconds, the VCR will automatically display information about the next programmed timer recording. This will continue until all timer recordings have been displayed. Then the menu will disappear.

5

To cancel the timer recording displayed, press the **CLEAR** button. Either the display will disappear or information about other timer recordings will appear. If you do not press any other buttons, the display will disappear after all timer recordings have been displayed.

6

Repeat steps 1 - 4 to make sure you have cleared the correct timer recording.

2-3

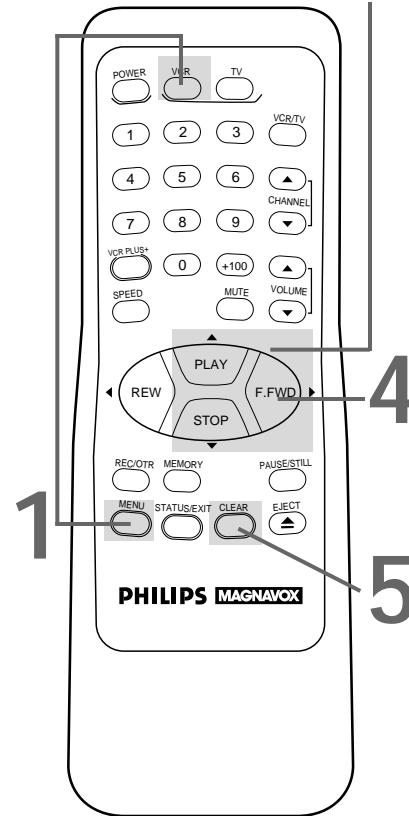

Helpful Hints

- *CLASH* may flash on-screen when you finish setting a timer recording. This means that the timer recording you just programmed and another timer recording overlap. The current timer recording will not take place. You may choose to cancel the overlapping timer recording.
- If the preset time for a timer recording comes up during a One-Touch Recording, the OTR has priority.
- To stop a started timer recording, press the **STOP/EJECT** button on the VCR.
- If the power fails for more than one minute, programmed timer recordings will be lost. Reset the clock before resetting the timer recordings.

See page 42 for more hints.

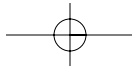

Setting Up the VCR Plus+ Programming System (cont'd) 33

2

Now, compare the channel numbers you have written in the VCR PLUS+ CH. and CABLE/TV CH. columns. For stations whose VCR Plus+ and Cable/TV channels do not match, you must tell the VCR the VCR Plus+ and Cable/TV channel numbers by following steps 3 - 7. Make each entry within 60 seconds of the previous entry.

3

Press the VCR button, then press the MENU button.

4

Press the PLAY/▲ button or the STOP/▼ button to select VCR SET UP, then press the F.FWD/▶ button.

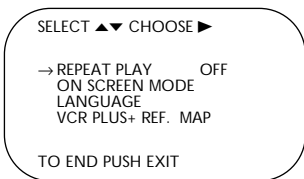

5

Press the PLAY/▲ button or the STOP/▼ button to select VCR PLUS+ REF. MAP, then press the F.FWD/▶ button.

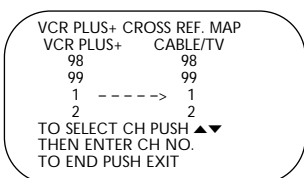

6

Look at the lists you filled in on page 32. For stations whose VCR Plus+ and Cable/TV channels do not match, press the PLAY/▲ button or the STOP/▼ button until the arrow is beside the VCR Plus+ channel you need. Then, press the Number buttons to enter the corresponding Cable/TV channel from your list. (Enter a "0" before single-digit channels.) Enter all the stations on your list.

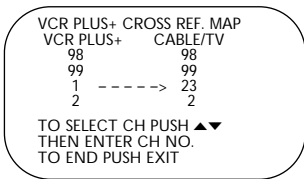

7

Press the STATUS/EXIT button.

2

Examine the lists on page 32.

4-5

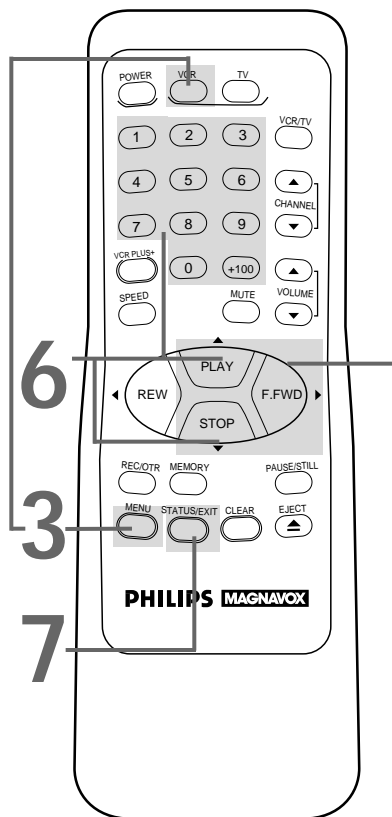

Helpful Hints

- To erase a Cable/TV channel number, repeat steps 3-5 on this page. Then, press the PLAY/▲ button or the STOP/▼ button to select it. Press the CLEAR button, then press the STATUS/EXIT button.
- To select line input for the Cable/TV channel, press 0,0. AUX will appear on-screen.
- When you receive the VCR, all the VCR Plus+ channel numbers and Cable/TV channel numbers are the same.



34 Timer Recording With the VCR Plus+ Programming System

Follow these steps to set a timer recording with the PlusCode programming numbers in your TV guide. Before you begin:

- Set up the channels at the VCR (page 12).
- Set up the VCR Plus+ and Cable/TV channel numbers (pages 32 - 33).
- Set the clock (page 15).
- Put a tape in the VCR.
- Turn on the VCR power. The VCR light should appear on the display panel. If it does not, press the VCR/TV button once.

Do each step within 60 seconds of the previous step.

1

Press the VCR button.

2

Press the VCR PLUS+ button.

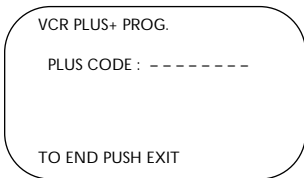

3

Press the Number buttons to enter the PlusCode programming number of the program you wish to record. Then, press the VCR PLUS+ button.

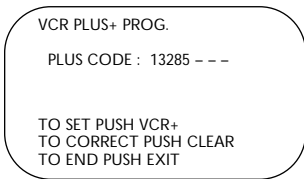

4

Press the **PLAY/▲** button or the **STOP/▼** button to select a **ONCE**, **DAILY**, OR **WEEKLY** recording. Then, press the **F.FWD/▶** button.

- **ONCE:** The VCR will record a TV program on any day you choose, up to 12 months away.
- **DAILY:** The VCR will record every day from Monday to Friday – starting at the same time and recording for the same length of time.
- **WEEKLY:** The VCR will record on the same day, at the same time, and for the same length of time every week.

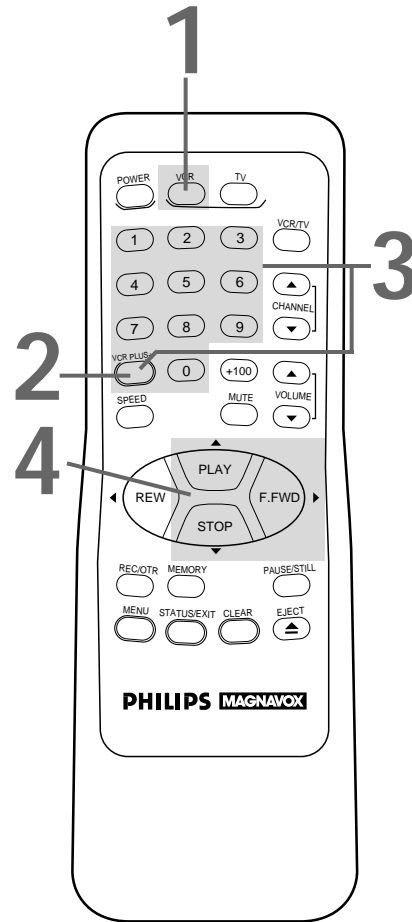
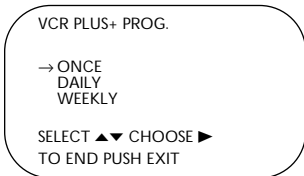

Helpful Hints

- **CODE ERROR** may flash on-screen after step 3 if you enter an incorrect number (for example, one that is too short). The previous screen will appear. Enter the correct PlusCode programming number.
- If the **VCR PLUS+ CROSS REF. MAP** reappears after step 3, the VCR PLUS+ channel number for the recording you entered was higher than 99. In this case, enter the correct CABLE/TV channel in the map. Then, press the **MENU** button and continue from step 4.
- If **CLASH** flashes on-screen at step 3, the timer recording you just programmed and another timer recording overlap. The current timer recording will not occur.

Timer Recording With the VCR Plus+ Programming System (cont'd) 35

5

Press the Number 1 button to record in SP speed, the Number 2 button to record in LP speed, or the Number 3 button to record in SLP speed. Your selection will appear beside REC SPEED on-screen; SP=1 LP=2 SLP=3 will continue to flash. For details about tape speed, see pages 30 and 44. You cannot use the SPEED button at this time.

```

ONE TIME PROGRAM
PROGRAM      1
CHANNEL     09
TIME ON     10:30 PM
TIME OFF    11:30 PM
REC SPEED   SLP
           SP=1 LP=2 SLP=3
START DATE  10/10/98
           SAT.
TO END PUSH EXIT
  
```

6

Press the **STATUS/EXIT** button. PROGRAM WAS COMPLETED / PLEASE TURN OFF VCR FOR TIMER RECORDING should appear on-screen briefly.

7

Press the **POWER** button to turn off the VCR power. The Timer light will appear. The Timer light will flash if there is not a tape in the VCR.

If the timer recording will take place several hours or days from now, you may use the VCR until time for the recording. Just turn off the VCR a few minutes before the recording starts. If you forget to turn off the VCR, PLEASE TURN OFF VCR FOR TIMER RECORDING flashes on your TV screen two minutes before a timer recording starts. Remove the message by pressing the CLEAR button.

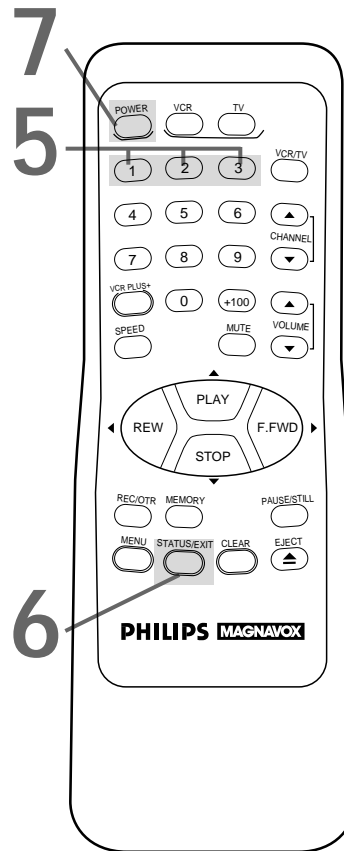

The VCR must be off for a timer recording to take place! Make sure there is a tape in the VCR.

Helpful Hints

- If the time for a timer recording comes up during a One-Touch Recording, the OTR has priority.
- To stop a started timer recording, press the STOP/EJECT button on the VCR.
- If the power fails for more than one minute, programmed timer recordings may be lost. Reset the clock before resetting the timer recordings.
- If you are using a Cable Box, timer recordings are programmed differently. See page eight for details. See page 42 for more hints.

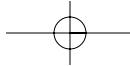

36 Rerecording (Tape Duplication)

1. Audio cable from AUDIO OUT Jack of VCR 1 to AUDIO IN Jack of VCR 2

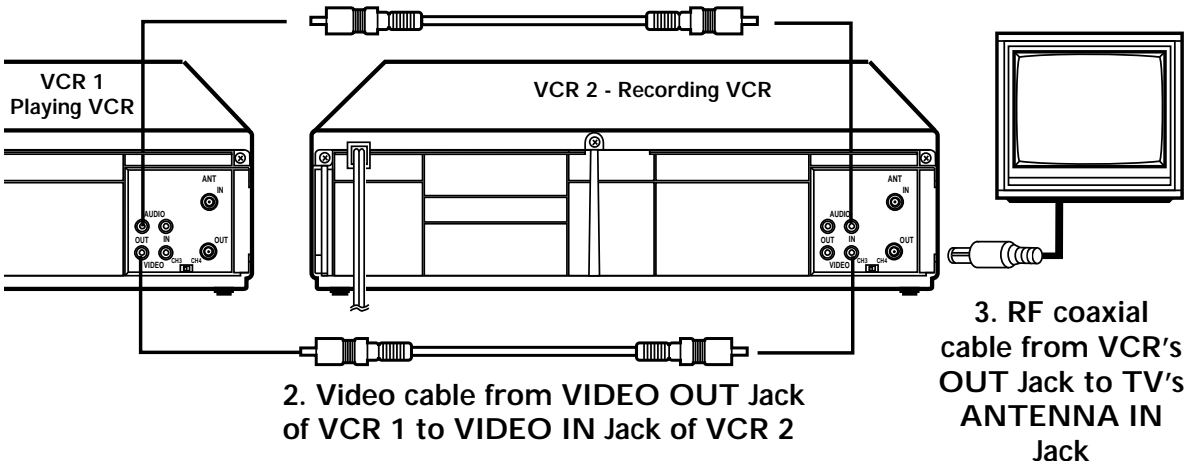

- Audio and video cables are not supplied.

1

Make the connections shown above.

2

VCR 1 will play your tape. Put a prerecorded tape in VCR 1.

3

VCR 2 will record your tape. Insert a blank tape in VCR 2. The VCR must be in VCR position. (The VCR light will appear on the display panel. If it does not, press the VCR/TV button once.)

4

Turn on the TV and set it to channel 03 or 04, whichever channel the CH3/CH4 switch on VCR 2 is set to.

5

Point the remote control at VCR 2. Press Number buttons 0, 0 to select Line Input. A/V IN will appear on-screen.

6

Use the SPEED button to select SP, LP, or SLP at VCR 2.

7

Press the PLAY button on VCR 1 and the REC(ord)/OTR button on VCR 2 at the same time.

To stop recording, press the STOP/EJECT button on VCR 1, then press the STOP/EJECT button on VCR 2.

Helpful Hints

- Unauthorized recording of copyrighted television programs, video tapes, or other materials may infringe on the rights of copyright owners and violate copyright laws.
- These instructions show you how to copy tapes using two VCRs like yours. Different VCRs may operate differently.

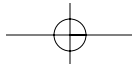

Repeat Play 37

Follow the steps below to make the VCR play a tape over and over.

1

Press the VCR button.

2

Press the MENU button.

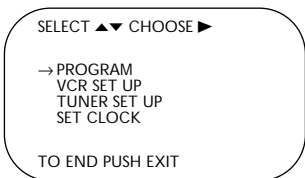

3

Press the PLAY/▲ button or the STOP/▼ button to select VCR SET UP, then press the F.FWD▶ button.

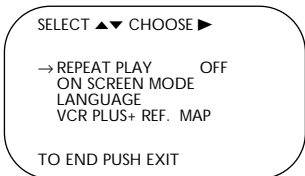

4

Press the PLAY/▲ button or the STOP/▼ button to select REPEAT PLAY.

5

Press the F.FWD▶ button so that ON appears beside REPEAT PLAY.

6

Press the STATUS/EXIT button. Now, when a tape has finished playing, the VCR will rewind it and start playback again.

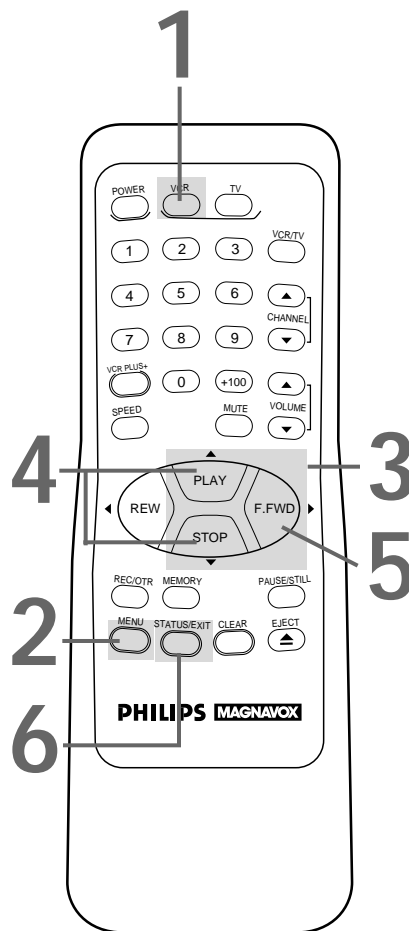

Helpful Hints

- To cancel Repeat Play, follow steps 1 - 4 above. At step 5, press the F.FWD▶ button so that OFF appears beside REPEAT PLAY. Press the STATUS/EXIT button.
- The real-time counter memory does not function during Repeat Play.

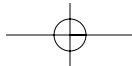

38 Real-Time Counter Memory

Follow the steps below to reset the real-time counter to zero at a tape location you want to refer to later.

1

Play, fast forward, or rewind a tape to the location that you would like to refer to later. Press the **STOP/▼** button to stop the tape.

2

Press the **STATUS/EXIT** button to see the status display.

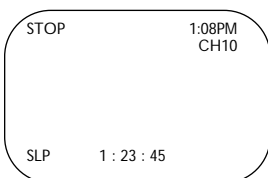

3

While the status display is on-screen, press the **CLEAR** button to reset the real-time counter to zero.

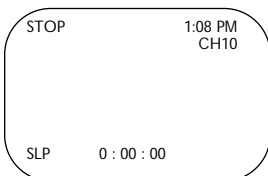

4

While the real-time counter is on-screen, press the **MEM-ORY** button so that **M** appears beside the counter.

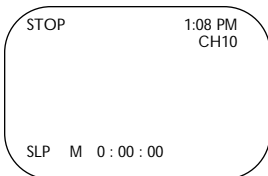

5

To go to a tape location where the real-time counter was reset to zero, press the **REW(ind)/◀** button or the **F.FWD/▶** button when playback is stopped.

When the tape reaches the point at which the counter was set to zero, the tape will stop.

Press the **PLAY/▲** button to watch the tape.

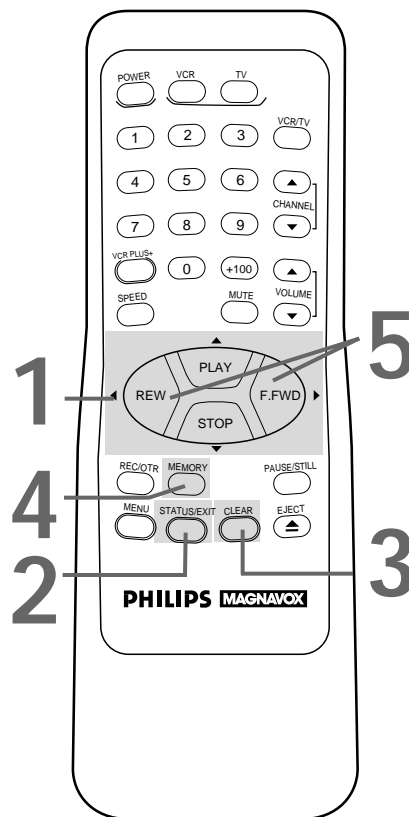

Helpful Hints

- The **MEMORY** button does not function if **REPEAT PLAY** is set to **ON**. Details are on page 37.
- To erase a real-time counter memory, press the **MEMORY** button until the **M** disappears from the screen.
- You may only set the real-time counter to zero at one location at a time. If you try to set the real-time counter to zero at a second location, the previous real-time counter to zero setting will be erased.

Special Effects Playback 39

Forward and Reverse Searching (SP/LP/SLP)

1

During tape playback, press and release the F.FWD/▶ button or the REW(ind)/◀ button. A fast forward or reverse picture search will begin.

2

To return to playback, press the PLAY/▲ button.

Super High Speed Searching (LP/SLP)

1

During tape playback, press the F.FWD/▶ button or the REW (ind)/◀ button, then press again. The VCR will now search in super high speed.

2

To return to normal playback, press the PLAY/▲ button.

Viewing a Still Picture

1

During tape playback, press the PAUSE/STILL button. A still picture will appear on-screen.

2

To release the still picture and return to playback, press the PLAY/▲ button.

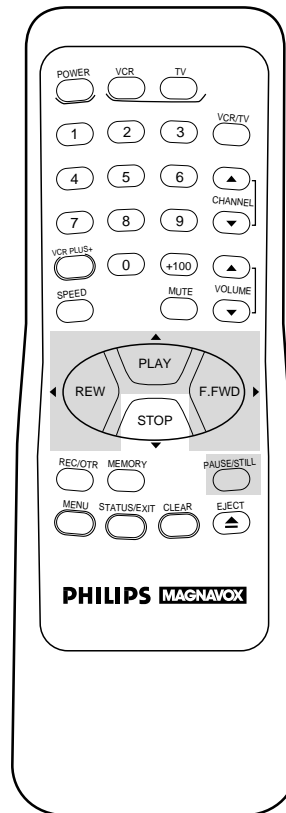

Helpful Hints

- Still mode will automatically switch to Stop mode after five minutes to protect the VCR and the tape from damage.
- SP/LP/SLP means this feature will work with tapes recorded in Standard Play, Long Play, or Super Long Play.
- LP/SLP means this feature will work with tapes recorded in Long Play or Super Long Play. For details about tape speed, see pages 30 and 44.

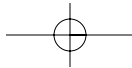

40 Automatic Operation Features

The following playback features will always operate.

Automatic Playback

When you put a tape in the VCR, the power will come on automatically. If the tape's record tab is missing, playback will begin. If a timer recording is set, the power will not come on automatically when you insert a tape with the record tab intact. If a timer recording is set and the VCR power is off, the VCR will eject the tape if the record tab is missing.

Automatic Rewind, Eject, Off

When a tape is played, fast forwarded, or recorded to its end, the VCR will rewind the tape, stop, eject the tape, then turn itself off. If the real-time counter memory is set, the VCR will only rewind to the point at which the counter is set to zero, then stop. The VCR will not eject the tape automatically or shut itself off.

Tape Eject

A tape can be ejected with the VCR power on or off (but the VCR must be plugged in). If a timer recording is set, a tape can only be ejected with the power on. Make sure you insert a tape and turn off the VCR power for the timer recording.

Automatic Tracking Adjustment

The VCR adjusts tracking automatically to give you the best possible picture quality. With some recordings, however, you may get a better picture using the manual tracking controls (see below). Tracking is returned to automatic tracking when a tape is inserted or when the STOP/▼ button is pressed.

Manual Tracking

To manually adjust the tracking during playback, press the CHANNEL ▲/▼ buttons **on the VCR**. (The CHANNEL ▲/▼ buttons on the remote control will not adjust tracking.) You cannot manually adjust the tracking of a Still picture. Tracking will return to Automatic Tracking Adjustment when you press the STOP/▼ button or insert a tape.

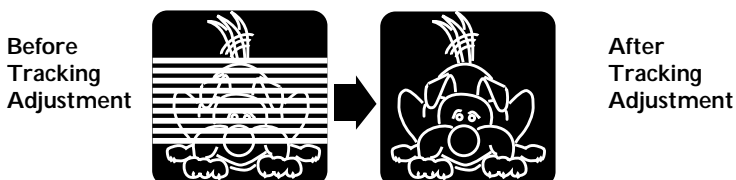

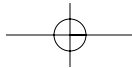

Specifications 41

Video Heads

Two heads

Video Signal

EIA standards; NTSC color

Antenna

VHF/UHF – 75 ohm external antenna terminal

VHF Output Signal

Channel 03 or 04 (switchable)

75 ohms unbalanced

Power Requirement

120V AC; 60Hz

Power Consumption

16W

Operating Temperature

41°F (5°C) to 104°F (40°C)

Relative Humidity

10% to 80%

Weight

5.51 lbs. (2.5 kg.)

Dimensions

14-3/16" (W) x 3-1/16" (H) x 10" (D)

(360 mm x 92mm x 230mm)

Tuner Broadcast Channels

VHF 2-13, UHF 14-69

Cable TV Channels

2 – 13

Midband: A – 1

Superband: J – W

Hyperband: A-5 – A-1

Special Channel: 5A

Ultraband: 37 – 94, 100 – 125

NOTE: Designs and specifications are subject to change without notice.

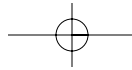

42 Helpful Hints

If you are having problems with your product, check this list of problems and possible solutions before requesting service. You may be able to solve the problem yourself.

If you need to call a customer service representative, please know the model number and serial number of your product before you call. This information is displayed on the back of the product. Also, please take a moment to identify the problem you are having, and be prepared to explain this to the representative. If you believe the representative will need to help you with operations, please stay near the product. Our representatives will be happy to assist you.

No power

- Make sure the power plug is completely connected to an AC (alternating current) outlet.
- Make sure the power is turned on.

Power Failure

- Timer recordings and the clock setting may be lost if the power fails for more than one minute. See page 15 to reset your clock. See pages 28 - 35 to reprogram your timer recordings.

A TV program cannot be recorded.

- Check the connections between the VCR, TV, antenna/cable, and Cable Box/Direct Broadcast System (if applicable) (pages six - 10).
- Make sure the tape has a record tab (page five).
- Check the TV/VCR position (page 22).
- Check the CH3/CH4 switch (pages six - nine).

The VCR will not perform a timer recording.

- Make sure the recording start and stop times are set correctly (pages 28 - 35).
- Make sure a tape is in the VCR and the tape has a record tab (page five). If, after programming a timer recording, you turn off the VCR power without putting a tape in the VCR, the Timer light will blink.
- If the record tab on a tape is missing, the VCR will eject the tape. The Timer light will blink.
- Make sure the VCR power is off.
- Make sure the clock is set (page 15).
- The VCR may not perform or continue a timer recording if a power interruption of more than one minute occurs.
- If you have a Cable Box/Direct Broadcast System, timer recordings are programmed differently. (See page eight for details.)
- Finish programming a timer recording at least five minutes before the recording is set to begin.
- 12 p.m. is noon; 12 a.m. is midnight.

There is no playback picture or the playback picture is noisy or contains streaks.

- Make sure the TV is on the same channel as the VCR's CH3/CH4 switch.
- Make sure the VCR is in VCR position. (The VCR light will appear on the display panel.)
- Make sure channel 03 or 04 is properly adjusted at the TV.
- Adjust the tracking (page 40).

The VCR cannot be controlled with the remote control.

- Press the VCR button, then try the other VCR feature buttons.
- Make sure the VCR light appears on the display panel. If it does not, press the VCR/TV button once.
- Aim the remote control directly at the VCR's remote sensor (page 22).
- Remove all obstacles between the remote control and the VCR.
- Inspect and/or replace the batteries in the remote control (page five).

The Number buttons won't work for channels above 69.

- Select CABLE TV at the TUNER SET UP menu (page 12), then let the VCR set up the channels.

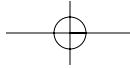

Helpful Hints (cont'd) 43

TV programs cannot be watched normally.

- Put the VCR in TV position. (Press the VCR/TV button so that the VCR light disappears from the display panel. For details see page 22.)
- Check the connections between the VCR, TV, antenna/cable, and Cable Box/Direct Broadcast System (if applicable). (See pages six - 10 for details.)

Tape cannot be inserted.

- Insert the tape, window side up, with the record tab facing you.
- Make sure a tape isn't already in the VCR by pressing the STOP/EJECT button on the VCR.
- Gently push on the center of the tape when putting it in the VCR. Never force the tape into the VCR.
- If a timer recording is programmed and the VCR power is off, you can not insert a tape without a record tab.

Tape cannot be removed.

- Make sure the power plug is completely connected to a power outlet.
- You have set a timer recording. Turn the VCR power on, then eject the tape. Be sure to insert a tape and turn off the power for your timer recording.

VCR ejects the tape when the REC(ord)/OTR button is pressed or when the VCR power is turned off to set a timer recording.

- Make sure the tape has a record tab (page five).

Channels above 13 cannot be received.

- Select CABLE TV at the TUNER SET UP menu (page 12), then let the VCR set up the channels.

Poor reception

- You may need to tune your TV again.

The motor (cylinder) rotates even when the VCR is in Stop mode.

- To enable the quick play mechanism, the cylinder will rotate for about five minutes. This is normal.

Direct Broadcast System Hookups

- Watching one TV channel while recording another may not be possible if you have a DBS hookup. You may have to set your TV to channel 03 or 04, then make your channel selections at the DBS.
- With many DBS hookups, if you use accessory audio and video cables to connect your VCR to your TV, you will have to put your VCR in Line Input mode (channel 00).

Line Input mode

- If you accidentally enter Line Input mode (A/V IN will appear on your TV screen briefly), press the CHANNEL ▲/▼ buttons or use the Number buttons to select another channel.

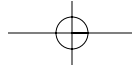

44 Glossary

AUDIO IN/OUT Jacks: jacks located on the back of the VCR which are used to record audio from another source (IN) or to send audio to another source (OUT).

Automatic Channel Setup: process in which the VCR memorizes all available channels. Then, when you press the CHANNEL ▲/▼ buttons, you only scan through channels you receive.

Bands: settings that allow you to tune channels.

- **Antenna** – VHF (very high frequency; channels 2 - 13) and UHF (ultra high frequency; channels 14 - 69).
- **Cable** – all standard channels can be received without a Cable Box.

Cable Box Output Channel: 03 or 04.

Dubbing: copying a tape using a second VCR.

Frame: a still picture.

HQ: high quality; a feature in the VCR circuitry which provides enhanced picture detail.

Line Input: The channel to which you set your VCR during dubbing (channel 00). If you select channel 00, A/V IN will appear on-screen. If you accidentally enter Line Input mode, press the CHANNEL ▲/▼ buttons or use the Number buttons to select another channel.

OTR: One-Touch Recording; a timed recording that starts immediately and records for 30 minutes to eight hours.

Remote Control: the small electronic unit that came with your VCR; allows you to operate your VCR from a distance.

RF coaxial cable: The cable supplied with your VCR. Use it to connect your VCR to your TV (or Cable Box or DBS). The supplied cable is a snap-on type. However, you may use a screw-on type if you prefer.

Special Effects: forward and reverse searching; a still picture.

Tape Speeds: how fast the tape travels during a recording or playback.

- **SP** (standard play) – fastest tape speed (recording time for a T120 tape is approximately two hours); best picture quality.
- **LP** (long play) – average tape speed (recording time for a T120 tape is approximately four hours).
- **SLP** (super long play) – slowest tape speed (recording time for a T120 tape is approximately six hours).

VCR: video cassette recorder.

VIDEO IN/OUT Jacks: jacks located on the back of the VCR which are used to record video from another source (IN) or to send video to another source (OUT).

Limited Warranty 45

VIDEO CASSETTE RECORDER

90 Days Free Labor/One Year Parts Exchange. This product must be carried in for repair.

WHO IS COVERED?

You must have proof of purchase to receive warranty service. A sales receipt or other document showing that you purchased the product is considered proof of purchase.

WHAT IS COVERED?

Warranty coverage begins the day you buy your product. For 90 days thereafter, all parts will be repaired or replaced, and labor is free. From 90 days to one year from the day of purchase, all parts will be repaired or replaced, but you pay for all labor charges. After one year from the day of purchase, you pay for the replacement or repair of all parts, and for all labor charges.

All parts, including repaired and replaced parts, are covered only for the original warranty period. When the warranty on the product expires, the warranty on all replaced and repaired parts also expires.

WHAT IS EXCLUDED?

Your warranty does not cover:

- labor charges for installation or setup of the product, adjustment of customer controls on the product, and installation or repair of antenna systems outside of the product.
- product repair and/or part replacement because of misuse, accident, unauthorized repair or other cause not within the control of Philips Consumer Electronics Company.
- reception problems caused by signal conditions or cable or antenna systems outside the unit.
- a product that requires modification or adaptation to enable it to operate in any country other than the country for which it was designed, manufactured, approved and/or authorized, or repair of products damaged by these modifications.
- incidental or consequential damages resulting from the product. (Some states do not allow the exclusion of incidental or consequential damages, so the above exclusion may not apply to you. This includes, but is not limited to, prerecorded material, whether copyrighted or not copyrighted.)
- damage caused by the use of non-VHS tapes or tapes that have not been tested and labeled for use in two, four, six, and eight hour VHS recorders.
- a product that is used for commercial or institutional purposes (including but not limited to rental purposes).

WHERE IS SERVICE AVAILABLE?

Warranty service is available in all countries where the product is officially distributed by Philips Consumer Electronics Company. In countries where Philips Consumer Electronics Company does not distribute the product, the local Philips service organiza-

tion will attempt to provide service (although there may be a delay if the appropriate spare parts and technical manual(s) are not readily available).

MAKE SURE YOU KEEP...

Please keep your sales receipt or other document showing proof of purchase. Attach it to this owner's manual and keep both nearby. Also keep the original box and packing material in case you need to return your product.

BEFORE REQUESTING SERVICE...

Please check your owner's manual before requesting service. Adjustments of the controls discussed there may save you a service call.

TO GET WARRANTY SERVICE IN U.S.A., PUERTO RICO OR U.S. VIRGIN ISLANDS...

Take the product to a Philips factory service center (see enclosed list) or authorized service center for repair. When the product has been repaired, you must pick up the unit at the center. Centers may keep defective parts.

(In U.S.A., Puerto Rico and U.S. Virgin Islands, all implied warranties, including implied warranties of merchantability and fitness for a particular purpose, are limited in duration to the duration of this express warranty. Because some states do not allow limitations on how long an implied warranty may last, this limitation may not apply to you.)

TO GET WARRANTY SERVICE IN CANADA...

Please contact Philips at:

1-800-661-6162 (French Speaking)

1-800-363-7278 (English Speaking)

(In Canada, this warranty is given in lieu of all other warranties. No other warranties are expressed or implied, including any implied warranties of merchantability or fitness for a particular purpose. Philips is not liable under any circumstances for any direct, indirect, special, incidental, or consequential damages, howsoever incurred, even if notified of the possibility of such damages.)

REMEMBER...

Please record below the model and serial numbers found on the product. Also, please fill out and mail your warranty registration card promptly. It will be easier for us to notify you if necessary.

MODEL # _____

SERIAL # _____

This warranty gives you specific legal rights. You may have other rights which vary from state to state.

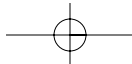

46 Index

-
- ac power cord.....23
 - accessories.....48
 - ant(enna) in jack.....6 - 10, 23
 - audio in/out jacks.....10, 23, 36, 44
 - automatic
 - playback.....40
 - rewind, eject, off.....40
 - batteries.....5
 - cassette compartment.....21
 - cassette-inside light.....21
 - ch3/ch4 switch.....6-9, 23
 - channel
 - above 100.....18
 - adding.....13
 - deleting.....13
 - reviewing.....14
 - setup.....11 - 14
 - ▲/▼ buttons.....19, 22, 40
 - clear button.....19, 38
 - clock display.....21
 - clock setting.....15
 - connections.....6 - 10
 - contents, table of.....4
 - controls
 - remote.....18 - 19
 - vcr.....22 - 23
 - counter only mode.....22
 - daylight-saving time.....16
 - display panel.....21
 - duplication.....36
 - eject button.....19
 - erase prevention.....5
 - f.fwd/▶ button.....19, 22, 39
 - front panel.....22
 - glossary.....44
 - helpful hints.....42 - 43
 - hookups
 - with cable box/dbs.....8-9
 - with stereo tv.....10
 - without cable box/dbs.....6-7
 - language selection.....11, 17
 - line input mode.....36, 43 - 44
 - long play.....30, 44
 - lp.....30, 44
 - memory button.....18, 38
 - menu button.....18
 - mute button.....19
 - number buttons.....18
 - on-screen status displays.....20
 - one-touch recording.....27
 - out jack.....6-9, 23
 - pause button.....22
 - pause/still button.....19
 - play/▲ button.....18, 24, 39
 - playing.....24
 - power
 - button.....18, 22
 - cord.....23
 - pwr.(power) light.....21
 - real-time counter.....38
 - rear panel.....23
 - rec/otr button.....18, 22, 25
 - rec(ord) light.....21
 - recording
 - basic.....25
 - one channel/
watching another.....26
 - timer.....28 - 31
 - with the vcr plus+
programming system.....32 - 35
 - remote control
 - buttons.....18 - 19
 - sensor.....22
 - using.....5
 - repeat play.....37
 - rerecording.....36
 - rew(ind)/◀ button.....18, 22
 - rf coaxial cable.....6-9, 36
 - safety precautions.....3
 - searching.....39
 - sensor (remote).....22
 - slp.....30, 44
 - sp.....30, 44
 - speed button.....18
 - standard play.....30, 44
 - status display.....20
 - status/exit button.....18, 20
 - stereo TV hookups.....10
 - still picture.....39
 - stop/▼ button.....19
 - stop/eject button.....22
 - super high speed searching.....39
 - super long play.....30, 44
 - table of contents.....4
 - tape
 - duplication.....36
 - eject.....19, 43
 - speed.....30, 44
 - time (setting).....15
 - timer
 - light.....21
 - recording
 - cancelling.....31
 - checking.....31
 - setting.....28 - 30
 - with vcr plus+ programming
system.....32 - 35
 - tracking.....40
 - tv
 - button.....5, 19
 - controls.....5, 18 - 19
 - hookups.....6-10
 - position.....19, 22
 - vcr
 - button.....5, 19
 - light.....21
 - plus+ button.....18, 34
 - plus+ programming
system.....32 - 35
 - position.....19, 22
 - vcr/tv button.....19, 22
 - video
 - in/out jacks.....10, 23, 36, 44
 - volume ▲/▼ buttons.....19
 - warranty.....45

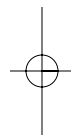
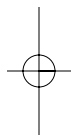

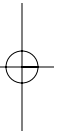
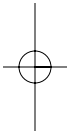
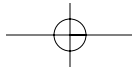

SUPPLIED ACCESSORIES

Check to be sure the items on this page are packed with your VCR. These accessories are provided to help you use or set up your VCR.

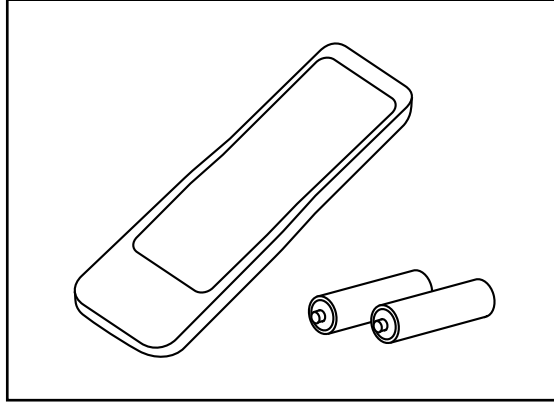

**Remote Control 4835 218 37212
Two AA Batteries 4835 138 17012**

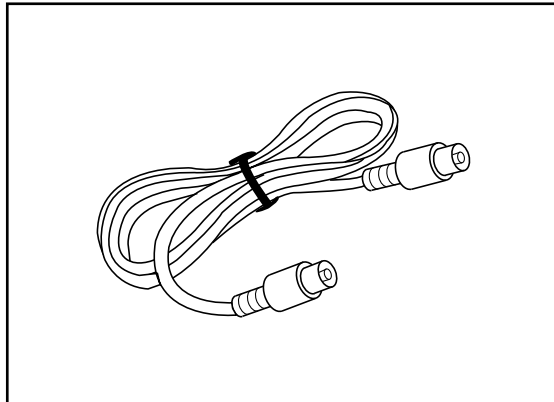

RF Coaxial Cable, 75 ohm 4835 323 27011

If any of these items are not included, or if you need to replace an item, contact Philips Service Company at the address below.

***Philips Service Company
P.O. Box 967
Greeneville, TN 37744-0967***

Or, call 1-800-851-8885.

Free Manuals Download Website

<http://myh66.com>

<http://usermanuals.us>

<http://www.somanuals.com>

<http://www.4manuals.cc>

<http://www.manual-lib.com>

<http://www.404manual.com>

<http://www.luxmanual.com>

<http://aubethermostatmanual.com>

Golf course search by state

<http://golfingnear.com>

Email search by domain

<http://emailbydomain.com>

Auto manuals search

<http://auto.somanuals.com>

TV manuals search

<http://tv.somanuals.com>