

TV STAND

MODEL TV50201

SUPPORT DE TÉLÉVISION
MODÈLE TV50201

SOPORTE DE TELEVISIÓN
MODELO TV50201

Do not contact the store for parts.

Individual stores do not stock parts.

For missing or damaged parts please call anytime at 1-877-490-3338

We guarantee immediate service.

For customer comments please email us at customer.service@pinnacledesign.net

Visit us at www.pinnacledesign.net

Ne pas contacter le magasin

Pour les pièces qui manquent ou des pièces endommager téléphonez au 1-877-490-3338

Nous assurons un service rapide.

Pour commentaires, s'adresser à customer.service@pinnacledesign.net

Visiter nous à www.pinnacledesign.net

Si tienen falta de piezas, favor de no devlver este prducto al almacen.

Nuestro departamento de servicio tiene mucho orgullo en darle ayuda en la manera mas eficiente y lo pronto posible. Si es necesario de obtener piezas de repuesto, favor de llamar 1-877-490-3338.

Nosotros garantizamos servicio inmediato.

Para comentarios de cliente por favor nos manda correo electrónico a customer.service@pinnacledesign.net

Visita nuestro sitio electrónico a www.pinnacledesign.net



Pinnacle Design warrants this product to be free from defects in material and workmanship and agrees to remedy any such defect for one year from the date of original purchase. This warranty is solely limited to the repair or replacement of defective furniture components and no assembly labor is included.

This warranty service does not apply to any product which has been improperly assembled, subjected to misuse or abuse or which has been altered or repaired in anyway. Liability for consequential damages is excluded to the extent exclusion is permitted by law. This warranty gives you specific legal rights.

Additional warranty rights may be provided by law in some areas.

To obtain warranty service, purchaser must present original dated bill of sales. Components repaired or replaced are warranted through the remainder of the original warranty period only. The defective components will be repaired or replaced without charge, subject to the terms and conditions described above.

Thank you for purchasing an item for Pinnacle Design.

Pinnacle Design garantit ce produit libre de défaut de matériaux ou de fabrication et s'engage à remédier tout problème qui se manifeste durant la première année, effectif de la date original d'achat. Cette garantie s'applique seulement à la réparation ou au remplacement de pièces défectueuse et n'inclut aucune main-d'oeuvre d'assemblage.

Cette garantie ne s'applique pas aux produits qui ont été assemblé incorrectement, abusé, modifié ou réparé d'aucune façon. La responsabilité pour les dégats important est excluse à l'exclusion de l'ampleur autorisée par la loi. Cette garantie vous donne des droits légaux spécifiques. Dans certaine regions, des droits de garantie supplémentaires peuvent être disponible.

Pour obtenir une réclamation, vous devez présenter votre reçu d'achat original. Les pièces qui sont remplacer sont garantie seulement pour la durée originale de la garantie. Les pièces défectueuses seront réparés ou remplacés sans frais sujets aux termes et conditions indiqué ci-haut.

Merci d'avoir fait l'achat d'un produit Pinnacle Design.

Pinnacle Designs garantiza que este producto sera libre de los defectos de material o de construcción y está de acuerdo a corregir esos defectos. Esta garantía entra en vigo el día de compra y dura un año. Esta garantía es limitada solo en la reparación o reemplazo de las piezas defectuosas y el montaje de mano de obra no esta incluido. Esta garantía no se aplica al producio que está armado incorrectamente, maltratado o abusado de cualquier manera. La responsabilidad por los daños consiguientes es excluido hasta el punto que la exclusión es permitida por la ley. Esta garantía suplementarios pueden ser suministrados por la ley en ciertas regions. Para obtener el servicio de garantía, el comprador debe presentar la factura de venta original. Las piezas reparadas o reemplazadas quedan garantizadas solo por el periodo de garantía original. Las piezas defectuosas serán reparadas o reemplazadas sin cargo sujeta a las condiciones antedichas. Gracias por haber comprado de Pinnacle Design.

Helpful Hints and Warnings

Make sure all parts are included.

Read each step carefully. Each step of the instruction should be performed in the correct order.

To clean the stand, use your favorite furniture polish and a soft cloth. Do not use harsh chemicals or abrasive cleaners. Please refer to your TV owner's manual for proper cleaning/care of the TV.

Do not allow children to climb on unit. Unit can tip over and cause severe injury or death.

Put heavy items on lower shelves.

Consignes et Avertissements

Assurez vous que toute pièces requise sont inclus.

Liser chaque étape avec soin avant de commencer. Les étapes doivent être completer selon l'ordre indiqué.

Pour nettoyer le produit, n'utilisez pas de produits chimiques ou abrasifs. Au lieu, utilisez une cire à meuble et un linge doux.

Assurez vous que personnes grimpent sur le meuble. Le meuble peut basculer et causer des blessures grave ou même la mort.

Placer items lourd sur les tablettes du bas.

Notas Utiles

Asegurar que todas la piezas son incluidos.

Leer con cuidado cada paso antes de empezar. Es muy importante de ejecutar cada paso en el orden correcto.

Para limpiar el producto, utilice la cera de lustrar para mueble y un trapo suave. NO UTILIZA productos con químicos duros o abrasivos.



NO dejar que los niños suben por encima del mueble.

Pon artículos pesados en el estante inferior.

PARTS IDENTIFICATION LIST

LISTE DE PIÈCE

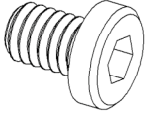
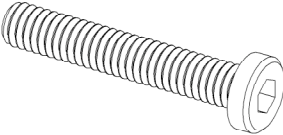
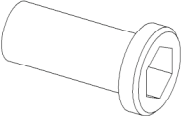
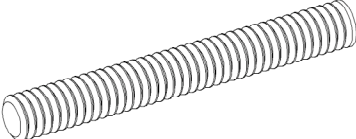

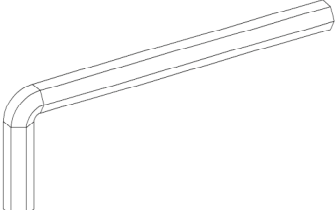

LISTA DE IDENTIFICACIÓN DE LAS PIEZAS

PART PIÈCE PIEZAS	HARDWARE QUINCAILLERIE FERRETERIA	PART NAME/# QUINCAILLERIE NUMEROS DE LAS PIEZAS	QUANTITY QUANTITÉ QUANTIDAD
1		Short Bolt / MS010	6 pcs
2		Long Bolt / MS011	2 pcs
3		Rod Cap / RC001	2 pcs
4		Short Rod / SR001	2 pcs
5		Washer / W001	4 pcs
6		Hex Wrench / HW001	1 pc

PARTS IDENTIFICATION LIST

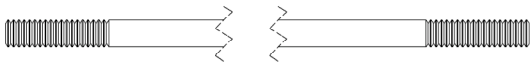
LISTE DE PIÈCE

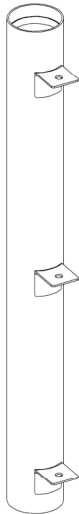
LISTA DE IDENTIFICACIÓN DE LAS PIEZAS

PART PIÈCE PIEZAS	HARDWARE QUINCAILLERIE FERRETERIA	PART NAME/# QUINCAILLERIE NUMEROS DE LAS PIEZAS	QUANTITY QUANTITÉ QUANTIDAD
A		Cap / TV50201 -A	2 pcs
B		Long Rod / TV50201 -B	2 pcs
C		Wire Cover / TV50201 -C	2 pcs
D		Front Leg / TV50201 -D	2 pcs
E		Metal Cap / TV50201 -E	1 pc

PARTS IDENTIFICATION LIST

LISTE DE PIÈCE

LISTA DE IDENTIFICACIÓN DE LAS PIEZAS

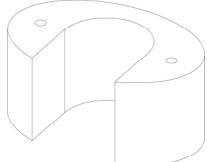
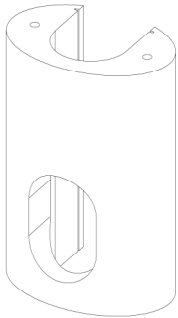
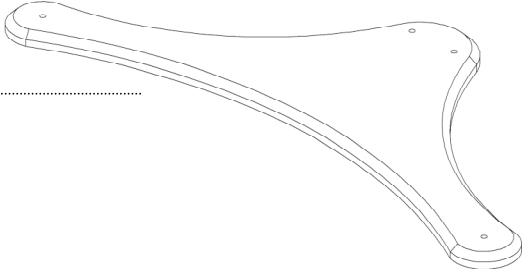
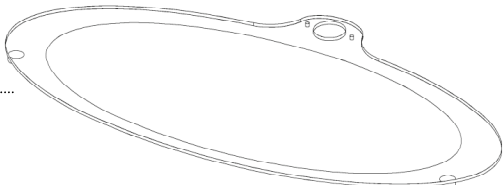
PART PIÈCE PIEZAS	HARDWARE QUINCAILLERIE FERRETERIA	PART NAME/# QUINCAILLERIE NUMEROS DE LAS PIEZAS	QUANTITY QUANTITÉ QUANTIDAD
F		Small Black Spine / TV50201 -F	1 pc
G		Medium Black Spine / TV50201 -G	1 pc
H		Large Black Spine / TV50201 -H	2 pcs
J		Bottom / TV50201 -J	1 pc
K		Glass / TV50201 -K	3 pcs

STEP 1

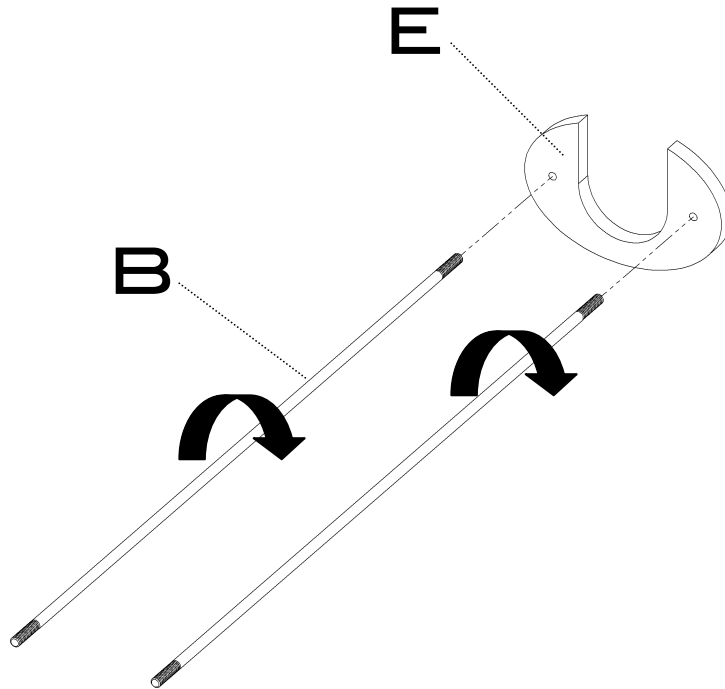

STEP 2

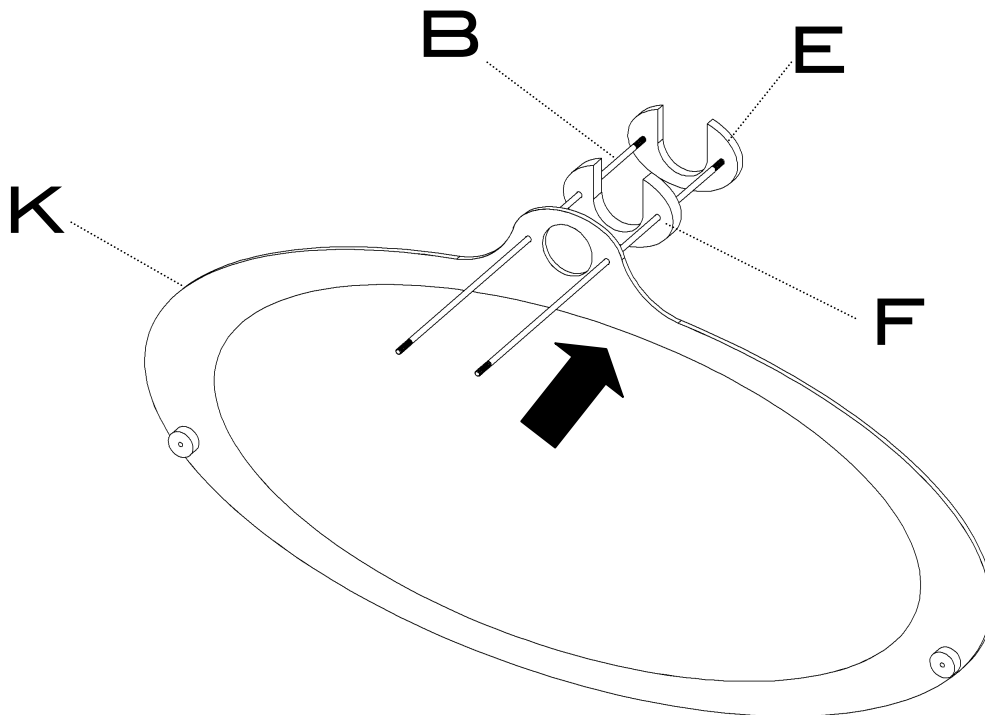

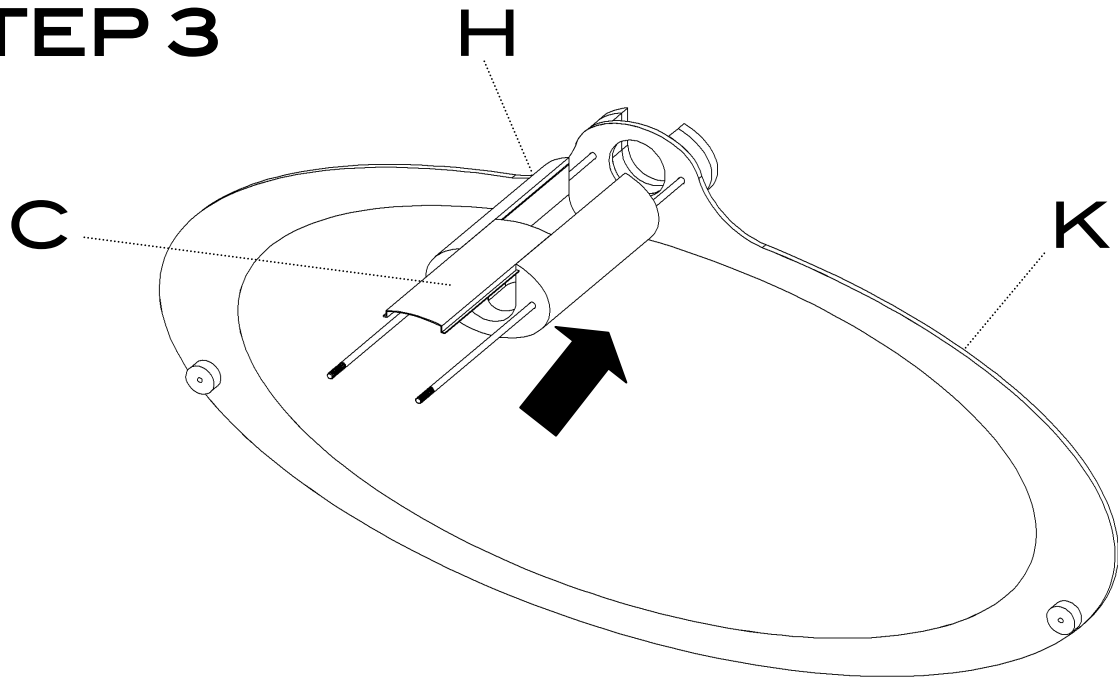
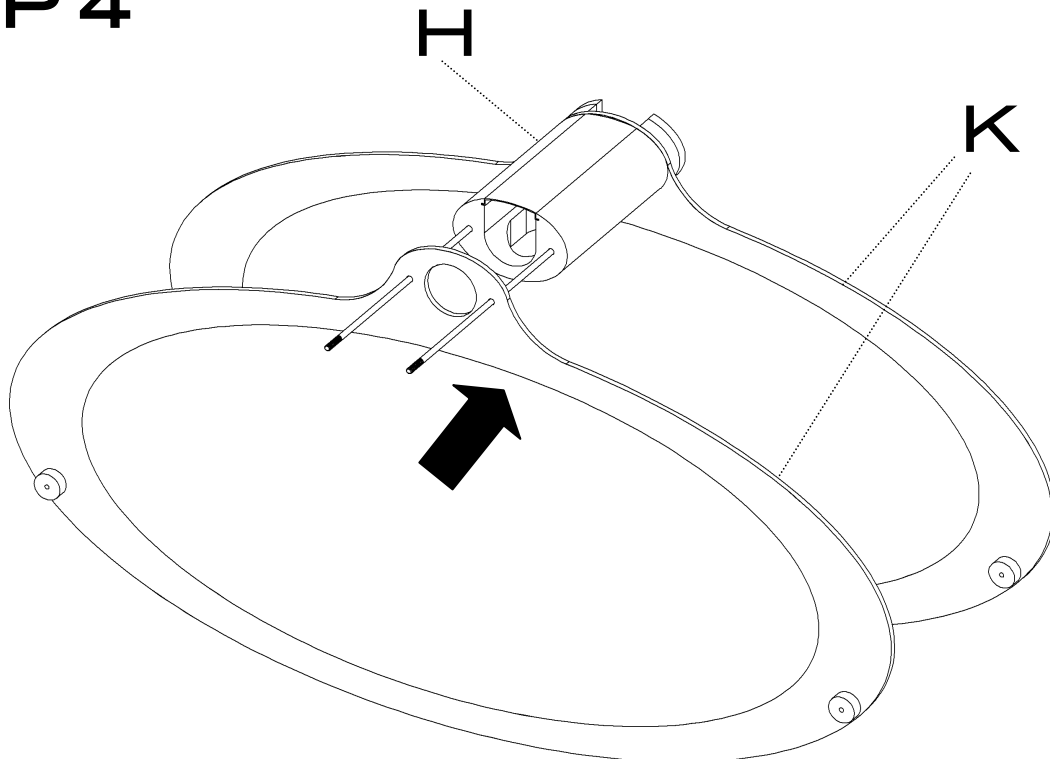
STEP 3**STEP 4**

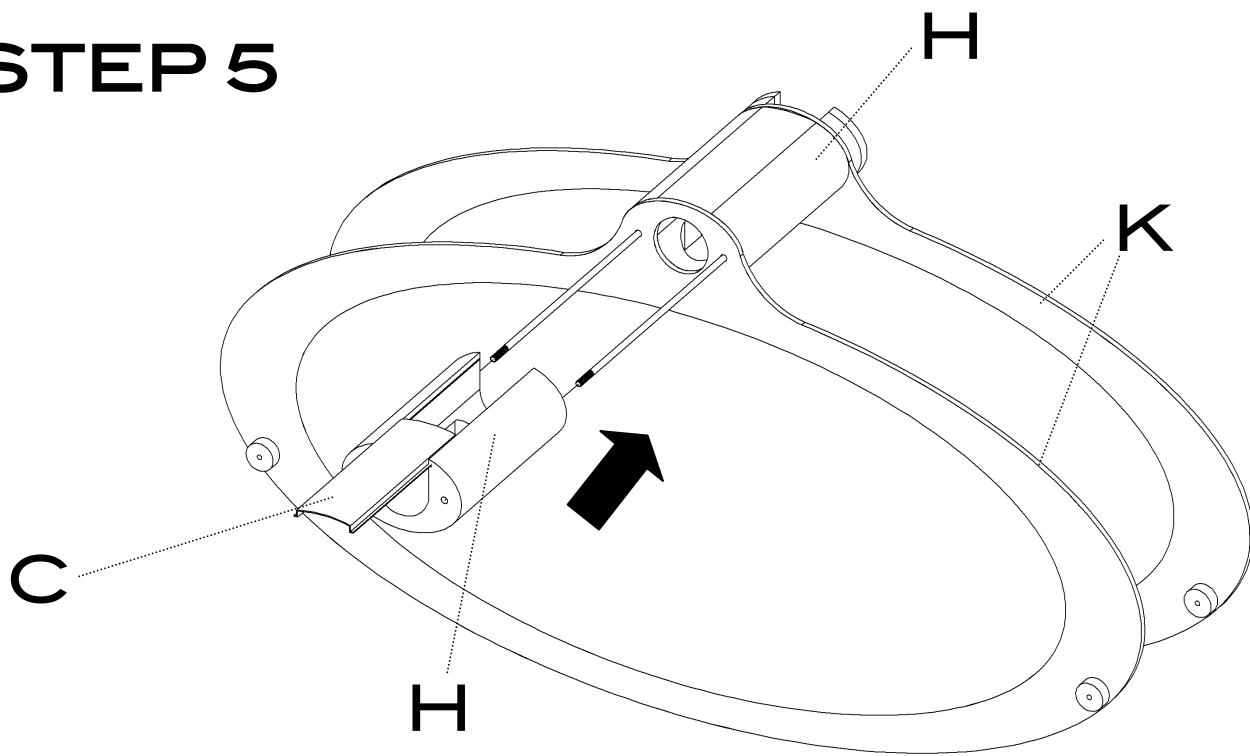
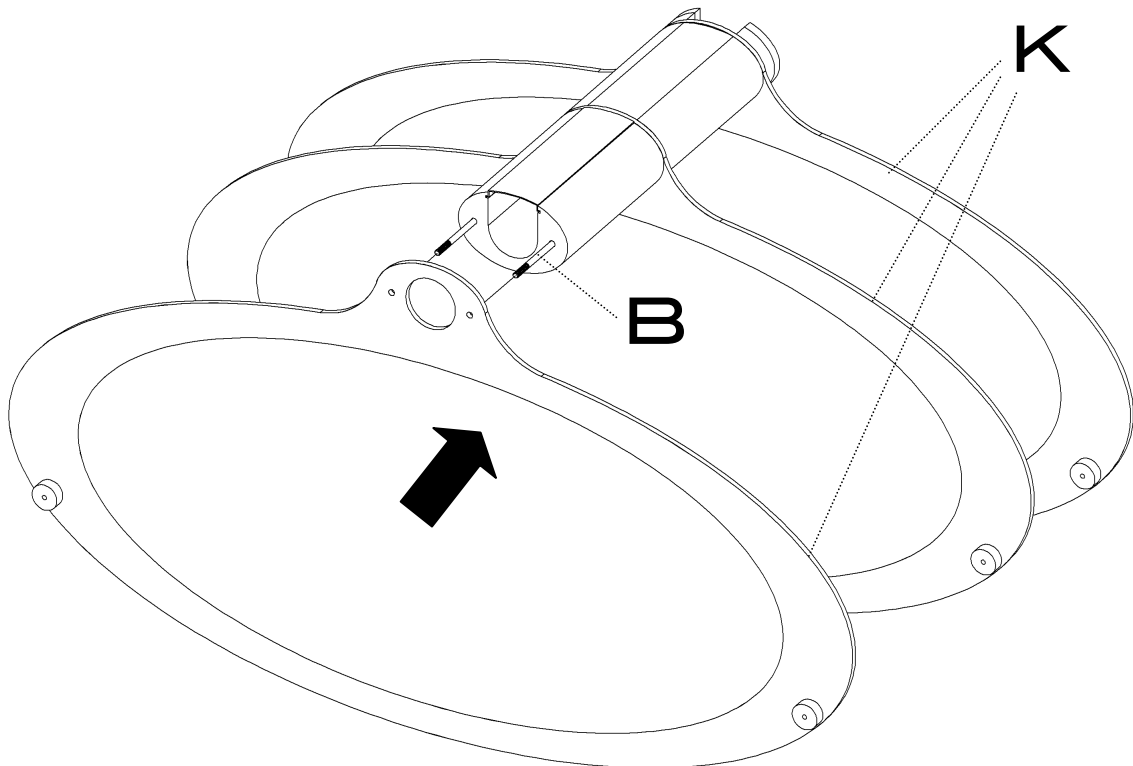
STEP 5**STEP 6**

STEP 7

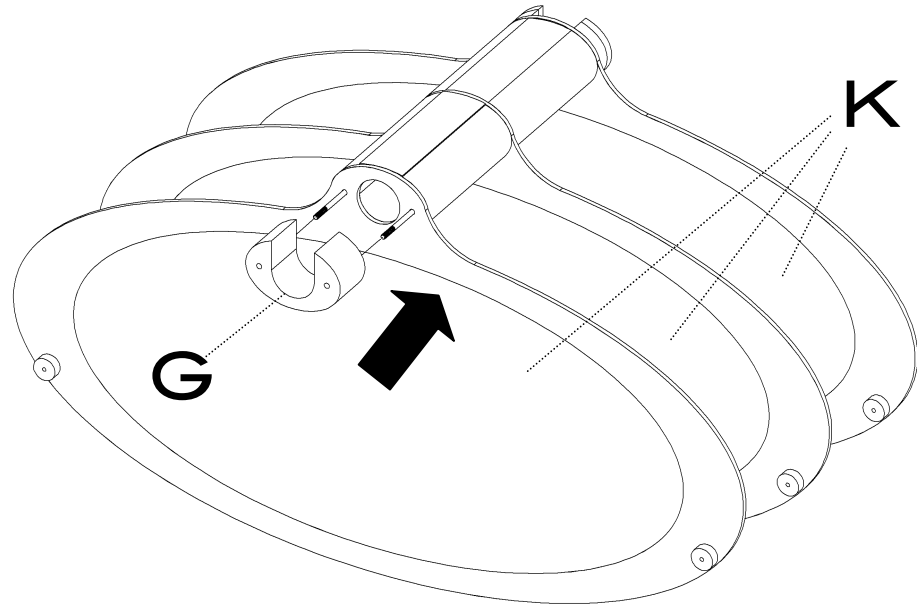

STEP 8

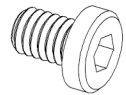

PART 1x6

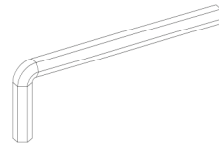

PART 6x1

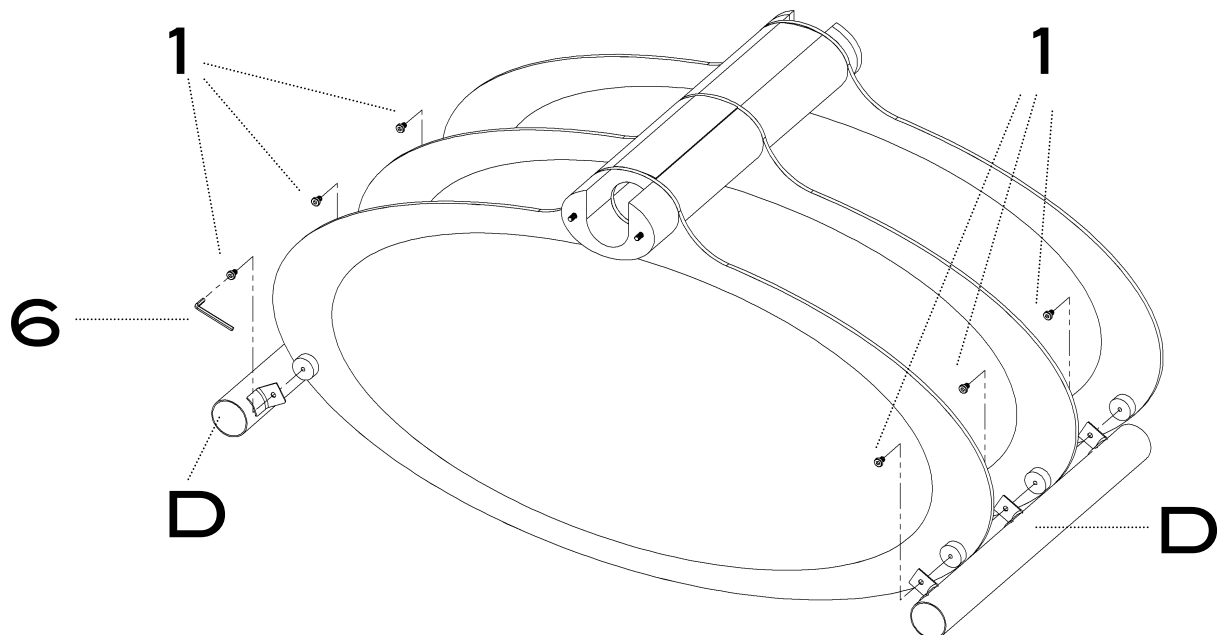

STEP 9

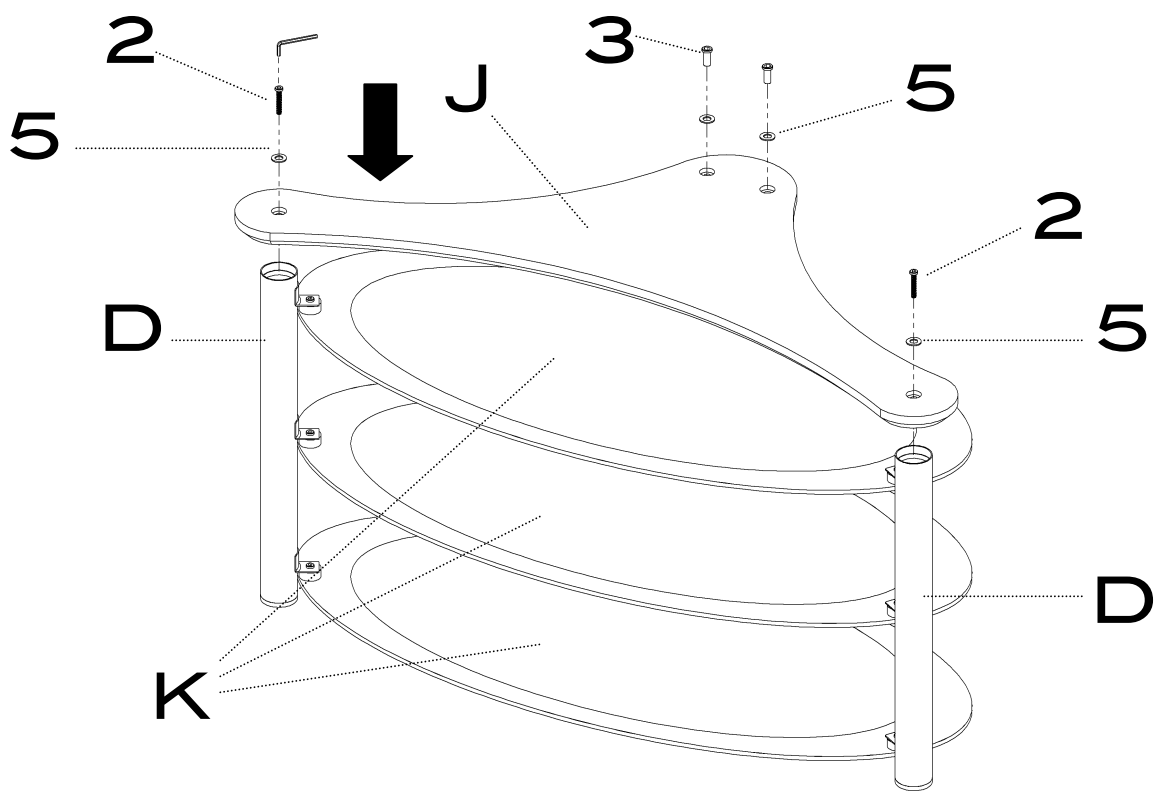
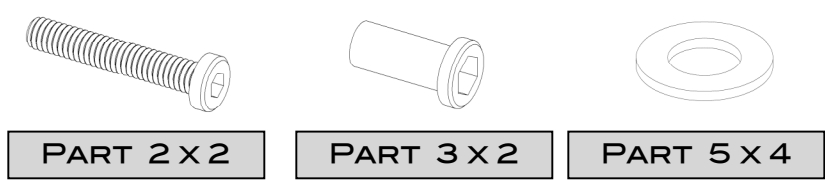

STEP 10

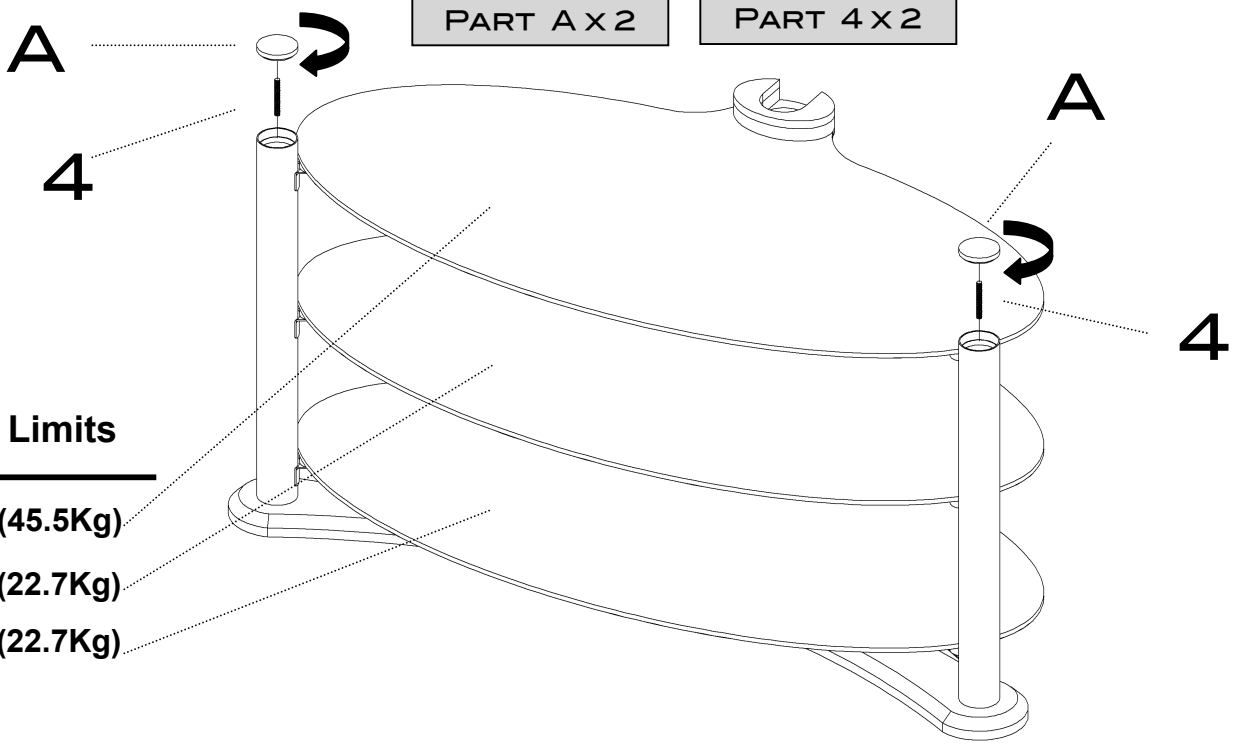
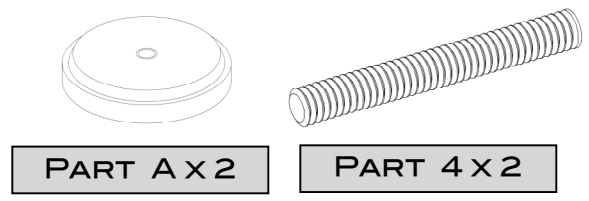

Weight Limits

- 100lbs. (45.5Kg)
- 50lbs. (22.7Kg)
- 50lbs. (22.7Kg)

Free Manuals Download Website

<http://myh66.com>

<http://usermanuals.us>

<http://www.somanuals.com>

<http://www.4manuals.cc>

<http://www.manual-lib.com>

<http://www.404manual.com>

<http://www.luxmanual.com>

<http://aubethermostatmanual.com>

Golf course search by state

<http://golfingnear.com>

Email search by domain

<http://emailbydomain.com>

Auto manuals search

<http://auto.somanuals.com>

TV manuals search

<http://tv.somanuals.com>