

Pioneer

MULTI PLAYER

CDJ-2000



<http://www.prodjnet.com/support/>

The Pioneer website shown above offers FAQs, information on software and various other types of information and services to allow you to use your product in greater comfort.

<http://www.prodjnet.com/rekordbox/support/>

For inquiries on rekordbox, please see the support site indicated above.

Operating Instructions

Thank you for buying this Pioneer product. Please read through these operating instructions so you will know how to operate your model properly. After you have finished reading the instructions, put them away in a safe place for future reference. In some countries or regions, the shape of the power plug and power outlet may sometimes differ from that shown in the explanatory drawings. However the method of connecting and operating the unit is the same.

IMPORTANT



The lightning flash with arrowhead symbol, within an equilateral triangle, is intended to alert the user to the presence of uninsulated "dangerous voltage" within the product's enclosure that may be of sufficient magnitude to constitute a risk of electric shock to persons.

CAUTION

**RISK OF ELECTRIC SHOCK
DO NOT OPEN**

CAUTION:
TO PREVENT THE RISK OF ELECTRIC SHOCK, DO NOT REMOVE COVER (OR BACK). NO USER-SERVICEABLE PARTS INSIDE. REFER SERVICING TO QUALIFIED SERVICE PERSONNEL.



The exclamation point within an equilateral triangle is intended to alert the user to the presence of important operating and maintenance (servicing) instructions in the literature accompanying the appliance.

D3-4-2-1-1_A1_En

NOTE: THE NO USER-SERVICEABLE PARTS COMPARTMENT WARNING IS LOCATED ON THE APPLIANCE BOTTOM.

IMPORTANT SAFETY INSTRUCTIONS

- 1) Read these instructions.
- 2) Keep these instructions.
- 3) Heed all warnings.
- 4) Follow all instructions.
- 5) Do not use this apparatus near water.
- 6) Clean only with dry cloth.
- 7) Do not block any ventilation openings. Install in accordance with the manufacturer's instructions.
- 8) Do not install near any heat sources such as radiators, heat registers, stoves, or other apparatus (including amplifiers) that produce heat.
- 9) Do not defeat the safety purpose of the polarized or grounding-type plug. A polarized plug has two blades with one wider than the other. A grounding type plug has two blades and a third grounding prong. The wide blade or the third prong are provided for your safety. If the provided plug does not fit into your outlet, consult an electrician for replacement of the obsolete outlet.
- 10) Protect the power cord from being walked on or pinched particularly at plugs, convenience receptacles, and the point where they exit from the apparatus.
- 11) Only use attachments/accessories specified by the manufacturer.
- 12) Use only with the cart, stand, tripod, bracket, or table specified by the manufacturer, or sold with the apparatus. When a cart is used, use caution when moving the cart/apparatus combination to avoid injury from tip-over.
- 13) Unplug this apparatus during lightning storms or when unused for long periods of time.
- 14) Refer all servicing to qualified service personnel. Servicing is required when the apparatus has been damaged in any way, such as power-supply cord or plug is damaged, liquid has been spilled or objects have fallen into the apparatus, the apparatus has been exposed to rain or moisture, does not operate normally, or has been dropped.



P1-4-2-2_En

NOTE:

This equipment has been tested and found to comply with the limits for a Class B digital device, pursuant to Part 15 of the FCC Rules. These limits are designed to provide reasonable protection against harmful interference in a residential installation. This equipment generates, uses, and can radiate radio frequency energy and, if not installed and used in accordance with the instructions, may cause harmful interference to radio communications. However, there is no guarantee that interference will not occur in a particular installation. If this equipment does cause harmful interference to radio or television reception, which can be determined by turning the equipment off and on, the user is encouraged to try to correct the interference by one or more of the following measures:

- Reorient or relocate the receiving antenna.
- Increase the separation between the equipment and receiver.
- Connect the equipment into an outlet on a circuit different from that to which the receiver is connected.
- Consult the dealer or an experienced radio/TV technician for help.

D8-10-1-2_A1_En

Information to User

Alterations or modifications carried out without appropriate authorization may invalidate the user's right to operate the equipment.

D8-10-2_A1_En

CAUTION

This product satisfies FCC regulations when shielded cables and connectors are used to connect the unit to other equipment. To prevent electromagnetic interference with electric appliances such as radios and televisions, use shielded cables and connectors for connections.

D8-10-3a_A1_En

FEDERAL COMMUNICATIONS COMMISSION DECLARATION OF CONFORMITY

This device complies with part 15 of the FCC Rules. Operation is subject to the following two conditions: (1) This device may not cause harmful interference, and (2) this device must accept any interference received, including interference that may cause undesired operation.

Product Name: MULTI PLAYER
 Model Number: CDJ-2000, CDJ-2000-W
 Responsible Party Name: PIONEER ELECTRONICS (USA), INC.
 SERVICE SUPPORT DIVISION
 Address: 1925 E. DOMINGUEZ ST. LONG BEACH, CA 90810-1003, U.S.A.
 Phone: 1-800-421-1404
 URL: <http://www.pioneerelectronics.com>

D8-10-4*_B1_En

This Class B digital apparatus complies with Canadian ICES-003.

D8-10-1-3_A1_En

WARNING

This equipment is not waterproof. To prevent a fire or shock hazard, do not place any container filled with liquid near this equipment (such as a vase or flower pot) or expose it to dripping, splashing, rain or moisture.

D3-4-2-1-3_B_En

WARNING

Before plugging in for the first time, read the following section carefully.

The voltage of the available power supply differs according to country or region. Be sure that the power supply voltage of the area where this unit will be used meets the required voltage (e.g., 230V or 120V) written on the rear panel.

D3-4-2-1-4_A_En

WARNING

To prevent a fire hazard, do not place any naked flame sources (such as a lighted candle) on the equipment.

D3-4-2-1-7a_A_En

VENTILATION CAUTION

When installing this unit, make sure to leave space around the unit for ventilation to improve heat radiation (at least 5 cm at rear, and 5 cm at each side).

WARNING

Slots and openings in the cabinet are provided for ventilation to ensure reliable operation of the product, and to protect it from overheating. To prevent fire hazard, the openings should never be blocked or covered with items (such as newspapers, table-cloths, curtains) or by operating the equipment on thick carpet or a bed.

D3-4-2-1-7b_A_En

Operating Environment

Operating environment temperature and humidity: +5 °C to +35 °C (+41 °F to +95 °F); less than 85 %RH (cooling vents not blocked)

Do not install this unit in a poorly ventilated area, or in locations exposed to high humidity or direct sunlight (or strong artificial light)

D3-4-2-1-7c*_A1_En

If the AC plug of this unit does not match the AC outlet you want to use, the plug must be removed and appropriate one fitted. Replacement and mounting of an AC plug on the power supply cord of this unit should be performed only by qualified service personnel. If connected to an AC outlet, the cut-off plug can cause severe electrical shock. Make sure it is properly disposed of after removal. The equipment should be disconnected by removing the mains plug from the wall socket when left unused for a long period of time (for example, when on vacation).

D3-4-2-2-1a_A1_En

CAUTION

The POWER switch on this unit will not completely shut off all power from the AC outlet. Since the power cord serves as the main disconnect device for the unit, you will need to unplug it from the AC outlet to shut down all power. Therefore, make sure the unit has been installed so that the power cord can be easily unplugged from the AC outlet in case of an accident. To avoid fire hazard, the power cord should also be unplugged from the AC outlet when left unused for a long period of time (for example, when on vacation).

D3-4-2-2-2a_A_En

POWER-CORD CAUTION

Handle the power cord by the plug. Do not pull out the plug by tugging the cord and never touch the power cord when your hands are wet as this could cause a short circuit or electric shock. Do not place the unit, a piece of furniture, etc., on the power cord, or pinch the cord. Never make a knot in the cord or tie it with other cords. The power cords should be routed such that they are not likely to be stepped on. A damaged power cord can cause a fire or give you an electrical shock. Check the power cord once in a while. When you find it damaged, ask your nearest PIONEER authorized service center or your dealer for a replacement.

5002*_En

IMPORTANT NOTICE

THE SERIAL NUMBER FOR THIS EQUIPMENT IS LOCATED ON THE BOTTOM. PLEASE WRITE THIS SERIAL NUMBER ON YOUR ENCLOSED WARRANTY CARD AND KEEP IN A SECURE AREA. THIS IS FOR YOUR SECURITY.

D1-4-2-6-1*_A1_En

When using this product, confirm the safety information shown on the bottom of the unit.

CAUTION

This product is a class 1 laser product classified under the Safety of laser products, IEC 60825-1:2007.

CLASS 1 LASER PRODUCT

D58-5-2-2a_A1_En

This product contains mercury. Disposal of this material may be regulated due to environmental considerations. For disposal or recycling information, please contact your local authorities or the Electronics Industries Alliance : www.eiae.org.

K057_A1_En

WARNING: Handling the cord on this product or cords associated with accessories sold with the product will expose you to chemicals listed on proposition 65 known to the State of California and other governmental entities to cause cancer and birth defect or other reproductive harm.

Wash hands after handling

D36-P5_A1_En

The Safety of Your Ears is in Your Hands

Get the most out of your equipment by playing it at a safe level – a level that lets the sound come through clearly without annoying blaring or distortion and, most importantly, without affecting your sensitive hearing. Sound can be deceiving. Over time, your hearing “comfort level” adapts to higher volumes of sound, so what sounds “normal” can actually be loud and harmful to your hearing. Guard against this by setting your equipment at a safe level BEFORE your hearing adapts.

ESTABLISH A SAFE LEVEL:

- Set your volume control at a low setting.
- Slowly increase the sound until you can hear it comfortably and clearly, without distortion.
- Once you have established a comfortable sound level, set the dial and leave it there.

BE SURE TO OBSERVE THE FOLLOWING GUIDELINES:

- Do not turn up the volume so high that you can't hear what's around you.
- Use caution or temporarily discontinue use in potentially hazardous situations.
- Do not use headphones while operating a motorized vehicle; the use of headphones may create a traffic hazard and is illegal in many areas.

5001a_A1_En

Contents

How to read this manual

The names of displays, menus, and buttons in this manual are enclosed in brackets. (e.g. [MASTER] channel, [ON/OFF], [File] menu)

- The Operating Instructions of rekordbox can be viewed from the rekordbox [Help] menu after installing rekordbox.

01 Before start

Features	5
----------------	---

02 Before you start

What's in the box.....	7
Discs/files playable on the CDJ-2000	7

03 Part Names and Functions

Control Panel.....	9
Rear Panel	10
Front Panel.....	10
Main unit display.....	11
Jog dial display section.....	11

04 Connections

Basic style.....	12
Using in combination with rekordbox.....	12
Using other brands of DJ software.....	13
Connections for relay play.....	13

05 Playback

Loading discs.....	14
Loading SD memory cards.....	14
Loading USB devices.....	14
Using the PRO DJ LINK function	14
Playback.....	15
Setting Cue	16
Setting Loop.....	16
Setting Hot Cue	17
Storing cue and loop points.....	18
Operating the jog dial	18
Operating the [NEEDLE SEARCH] pad	19
Operating the CDJ-2000 in combination with other devices	19
Using the [BROWSE] button	19
Using the [TAG LIST] button.....	20
Using the [INFO] button	21

06 Changing the settings

Using the [MENU/UTILITY] button.....	22
About the rekordbox software.....	23
About the driver software	26
Using other brands of DJ software.....	27

07 Additional information

Troubleshooting	28
About the liquid crystal display.....	29
Error messages	29
List of icons displayed on the main unit display section	29
Cautions on use	30
Handling discs	30
Disclaimer.....	31
Specifications.....	31

Before start

Features

The CDJ-2000 is a multi player for professional DJs, offering the variety of functions, durability and operability required for working in discos and nightclubs.

MULTI MEDIA, MULTI FORMAT

The CDJ-2000 can play not only discs (CDs and DVDs), but also music files recorded on SD memory cards and USB devices (flash memory drives and hard disks). Supported music file formats include not only music CD (CD-DA) and MP3 but also AAC, WAV and AIFF.

rekordbox™

The included rekordbox music management software can be used to prepare playlists, cues, loops, hot cues and other data required for DJ play unhurriedly at home ahead of time. This allows you to devote all your attention to DJ play at the disco/nightclub, with total assurance. From acquiring music files to DJ play, all steps in the cycle of the DJ's work can be accomplished smoothly.

rekordbox is an application for managing music files which are used for DJ play with a Pioneer DJ Player (i.e. CDJ-2000, CDJ-900).

Data that has been detected and measured, as well as any points which have been set and stored using rekordbox, can be used in combination with a Pioneer DJ Player (i.e. CDJ-2000, CDJ-900) to achieve outstanding DJ performance.

PRO DJ LINK

Functions include "SD & USB Export" using SD memory cards and USB devices (flash memory drives and hard discs) and "rekordbox LINK Export" using the computer on which rekordbox is installed.

❖ SD & USB Export

This function can be used to transfer rekordbox music files and management data using SD memory cards/USB devices. This eliminates the need to take your computer to the disco or club.

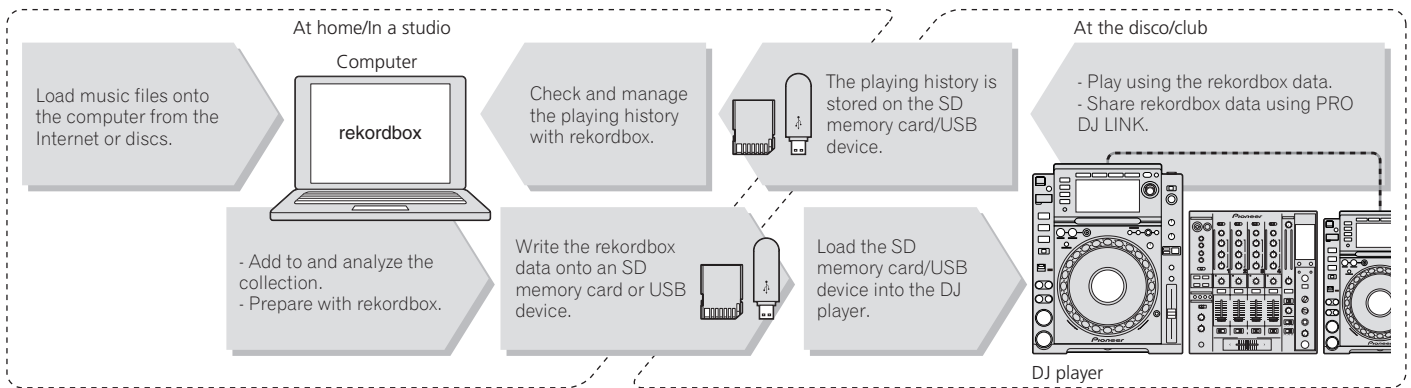

❖ rekordbox LINK Export

When the CDJ-2000 and computer are connected by LAN cable, the rekordbox music files and management data can be transferred directly between them. This eliminates the need to export data to SD memory cards/USB devices.

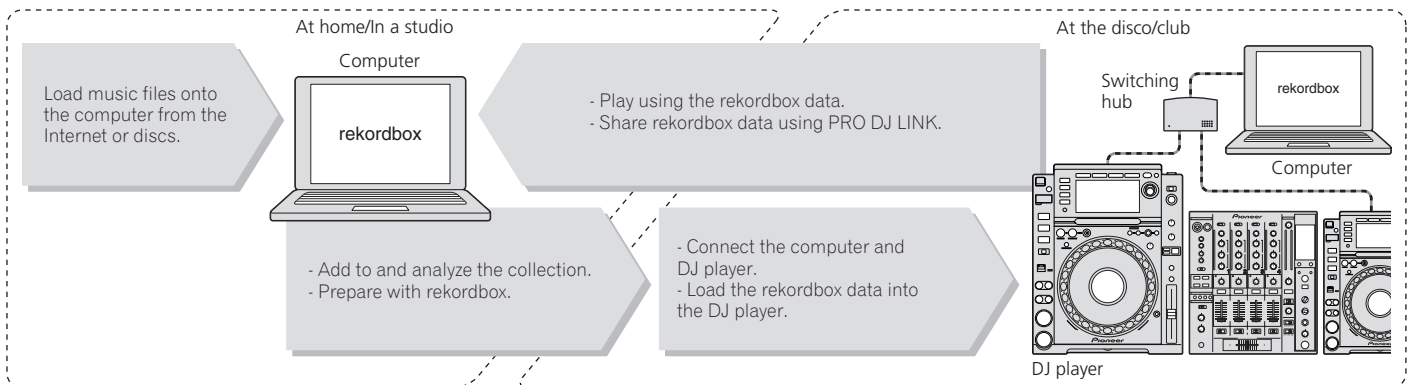

SOUND CARD

The CDJ-2000 is equipped with exclusive interface and MIDI interface for controlling the DJ software of other brands. There is also a built-in sound card, so other equipment can be connected easily.

DISPLAY

A large 6.1-inch color LCD is used to display not only text data but also jacket photos. The combination of a GUI displaying music file information in easily understandable fashion and a rotary selector with easy operation lets you select tracks with no stress.

WAVE DISPLAY

WAVE displays indicate the data with a higher resolution than previous Pioneer products.

NEEDLE SEARCH

When the NEEDLE SEARCH pad is touched with a finger, the sound near the position at which the pad is touched is played instantaneously. This makes for faster point searching than ever before.

TAG LIST

In addition to playlists prepared using rekordbox, tracks to be played next can be temporarily collected inside the CDJ-2000. The music files added to the tag list can be displayed as a list. This function is extremely convenient for selecting tracks during live performances.

KEYWORD SEARCH

Keyword searching, letter jumping and other functions let you quickly and precisely search for the desired music file.

HISTORY MEMORY

The CDJ-2000 is equipped with a history function storing the playing history of music files. Playlists can be created from this playing history using rekordbox.

0.5 FRAME STEP

The minimum frame has evolved from 1 (1/75 seconds) to 0.5 frames. This makes it possible to set the cue and loop points with greater precision to achieve accurate, advanced DJ play.

ADVANCED JOG DIAL

The jog ring illumination lights in four places, so the top and side edges of the jog dial are clearly visible, even in dark DJ booths. This can also be used to impress the audience.

QUANTIZE

The CDJ-2000 is equipped with a quantize function for putting a track on beat even when the button is pressed roughly, as long as the track has been analyzed with rekordbox. When setting real time cues and hot cues, the beat is automatically set to the beat closest to the position at which the button was pressed.

HIGH SOUND QUALITY

The CDJ-2000 is designed for thorough improvement of the sound quality, for both the digital and analog outputs.

For the digital circuitry, a high performance Wolfson D/A converter is used to faithfully reproduce even the most delicate sounds, achieving clear, high quality sound with a rich sense of mass and acoustic field.

For the analog circuitry, a hybrid OP amplifier is used to reduce to the utmost limits that inaudible noise of 20 kHz and higher that can blur the original sound. Unwanted digital noise is shut out to achieve clear, highly transparent sound faithful to the original.

Before you start

What's in the box

- Audio cable
- Power cable
- Control cord
- LAN cable
- Disc force eject pin
- CD-ROM (rekordbox)
- Warranty card
- Operating instructions (this document)

Discs/files playable on the CDJ-2000

Playable discs

Discs including the following marks on the disc label, package or jacket can be played.

Types of discs that can be played and marks



CD



CD-TEXT



CD-R



CD-RW



DVD-R



DVD-RW

DVD is a trademark of DVD Format/Logo Licensing Corporation.

Discs playable on this player are as shown below.

- CD-R/-RW discs recorded in music CD (CD-DA) format
- CD-R/-RW, DVD-R/-RW, DVD+R/+RW, DVD-R DL (dual layer) and DVD+R DL (dual layer) discs on which music files (MP3/AAC/WAV/AIFF) are recorded

❖ Discs that cannot be played

- DTS-CD
- Photo CDs
- Video CDs
- CD Graphics (CD-G) discs
- Unfinalized CDs
- DVD-Video discs
- DVD-Audio discs
- DVD-RAM discs
- Unfinalized DVDs

❖ Playback of discs created on a computer or DVD recorder

Depending on the application's settings and the computer's environment settings, it may not be possible to play discs created on a computer. Record discs in a format playable on the CDJ-2000. For details, contact your application's selling agent.

It may not be possible to play discs created on a computer or DVD recorder due to the disc's properties, scratches or dirt, or poor recording quality (dirt on the recording lens, etc.).

See *Handling discs* on page 30 for instructions on handling discs.

❖ Creating backup discs

When CD-R/-RW, DVD-R/-RW, DVD+R/+RW, DVD-R DL (dual layer) and DVD+R DL (dual layer) discs are paused or left in the pause mode at cue points for long periods of time, it may become difficult to play the disc that point, due to the properties of the disc. When a specific point is looped repeatedly an extremely large number of times, it may become difficult to play that point.

When playing valuable discs, we recommend making backup discs.

❖ Regarding copy protected CDs

This player is designed to conform to the specifications of the audio CD format. This player does not support the playback or function of discs that do not conform to these specifications.

❖ About DualDisc

This player is designed to conform to the specifications of the audio CD format. This player does not support the playback or function of discs that do not conform to these specifications.

❖ About 8 cm single CDs

8 cm single CDs cannot be played on the CDJ-2000. Do not mount 8 cm adapters on CDs and play them on the CDJ-2000. The adapter could fall off as the disc spins, damaging the disc or the player.

❖ About CD-Text

The CDJ-2000 supports CD-Text. Titles, album names and artist names recorded in CD-Text are displayed. When multiple text data is recorded, the first text data is displayed. The supported character codes are shown below.

- ASCII
- ISO-8859
- MS-JIS
- Mandarin Chinese character code

About CD playback

Music files (MP3/AAC/WAV/AIFF) recorded on CD-R/-RW, DVD-R/-RW, DVD+R/+RW, DVD-R DL (dual layer) and DVD+R DL (dual layer) discs can be played.

Folder layers	Max. 8 levels (files in folders beyond the 8th level cannot be played)
Max. number of folders	2 000 folders per disc (folders beyond the 2 000th folder cannot be displayed)
Max. number of files	<ul style="list-style-type: none"> • 999 files for each file format • 3 000 files per disc (files beyond the 3 000th folder cannot be displayed)

When there are many folders or files, some time may be required for loading.

About SD memory cards

Music files (MP3/AAC/WAV/AIFF) recorded on SD and SDHC memory cards conforming to SD standards can be played.

Such data as disc identification information, cue points, loop points and hot cues can be recorded on SD memory cards.

Folder layers	Max. 8 levels (files in folders beyond the 8th level cannot be played)
Max. number of folders	Unlimited (folders beyond the 10 000th folder within a single folder cannot be displayed)
Max. number of files	Unlimited (files beyond the 10 000th file within a single folder cannot be displayed)
Supported cards ^[1]	<ul style="list-style-type: none"> • SD memory cards: 8 MB – 2 GB • SDHC memory cards: 4 GB – 32 GB
Compatible formats	<ul style="list-style-type: none"> • SD memory cards: FAT12 and FAT16 (conforming to SD standards) • SDHC memory cards: FAT32 (conforming to SD standards)

[1] CPRM is not supported.

- SDHC memory cards can be used with devices supporting SDHC memory cards. They cannot be used with devices that only support SD memory cards.
- When using SD memory cards with a capacity of 4 GB or greater, use SD memory cards on which the SDHC logo is indicated.
- SD memory cards are shipped from the manufacturer in the standard format indicated above. If a non-formatted SD memory card is loaded, [FORMAT SD] is displayed and the card cannot be used.
- It may not be possible to use card formatted on a computer, digital camera, etc.
- Pioneer does not guarantee that all SD memory cards will operate on the CDJ-2000.

❖ Cautions on using SD memory cards

- SD memory cards are precision electronic devices. Handle them with care. Bending, dropping or subjecting SD memory cards to strong forces or shocks could break them. Also, do not use or store SD memory cards in environments where static electricity or electric noise tends to be produced. We recommend periodically making copies of valuable data.
- Please note that Pioneer will accept no responsibility whatsoever for loss of data recorded by the customer on SD memory cards or other direct or indirect problems resulting from connection to the CDJ-2000.
- After ejecting SD memory cards, store them in their dedicated case, etc.
- Depending on the SD memory card you are using, the desired performance may not be achieved.

About USB devices

Music files (MP3/AAC/WAV/AIFF) recorded on USB devices can be played. Such data as disc identification information, cue points, loop points and hot cues can be recorded on USB devices.

Folder layers	Max. 8 levels (files in folders beyond the 8th level cannot be played)
Max. number of folders	Unlimited (folders beyond the 10 000th folder within a single folder cannot be displayed)
Max. number of files	Unlimited (files beyond the 10 000th file within a single folder cannot be displayed)
Supported file systems	FAT, FAT32 and HFS+

- The CDJ-2000 supports such USB mass storage class USB devices as external hard discs, portable flash memory drives and digital audio players. External DVD/CD drives and other optical disc devices cannot be used.
- When there are many folders or files, some time may be required for loading.
- If multiple partitions are set for the USB device, the device may not be recognized.

❖ Cautions on using USB devices

- Some USB devices may not operate properly. Please note that Pioneer will accept no responsibility whatsoever for loss of data recorded on USB devices.
- USB hubs cannot be used.
- USB devices equipped with flash card readers may not operate.
- If a current above the allowable level is detected in the CDJ-2000's USB port, it could happen that a warning message is displayed, the power to the USB device is cut off and signal transfer is stopped. To restore normal operation, remove USB devices connected to the player, then press **USB STOP**. Avoid reusing the USB device for which the excess current was detected. If normal operation is not restored after performing the above operation (if signals are not transferred), try turning off the player's power then turning it back on.
- Depending on the USB device you are using, the desired performance may not be achieved.

About MP3 files

MP3 files can have a constant bit rate (CBR) or a variable bit rate (VBR). Both types of files can be played on the CDJ-2000, but the search and super fast search functions are slower with VBR files. If your priority is operability, we recommend recording MP3 files in CBR.

The CDJ-2000 supports MP3 files in the formats shown below.

Compatible formats	MPEG-1	Audio Layer-3 sampling frequencies of 32 kHz, 44.1 kHz and 48 kHz, and bit rates of 32 kbps – 320 kbps are supported.
	MPEG-2	Audio Layer-3 sampling frequencies of 16 kHz, 22.05 kHz and 24 kHz, and bit rates of 16 kbps – 160 kbps are supported.
Track information		ID3 tag versions 1.0, 1.1, 2.2, 2.3 and 2.4 are supported. Titles, album names, artist names, etc., are displayed here. ^[1] JPEG images embedded in ID3 tags are displayed as the jacket photo. ^[2]
File extension		.mp3

[1] To display characters written in a local code other than Unicode, change the [LAN-GUAGE] setting at [UTILITY] (page 22).

[2] Files larger than 800 x 800 dots cannot be displayed.

About AAC files

- AAC is the abbreviation of "Advanced Audio Coding", a basic format of audio compression technology used for MPEG-2 and MPEG-4.
- The file format and extension of AAC data depends on the application used to create the data.
- In addition to AAC files encoded with iTunes® and with the extension ".m4a", files with the extensions ".aac" and ".mp4" can also be played on the CDJ-2000. However, copyright protected AAC files purchased for example at the iTunes Music Store cannot be played. Also, some files may not be playable, depending on the iTunes version used to encode them.
- The CDJ-2000 supports AAC files in the formats shown below.

Compatible formats	MPEG-4 AAC LC	Sampling frequencies of 16 kHz, 22.05 kHz, 24 kHz, 32 kHz, 44.1 kHz and 48 kHz, and bit rates of 16 kbps – 320 kbps are supported.
Track information	aac	ID3 tag versions 1.0, 1.1, 2.2, 2.3 and 2.4 are supported. Titles, album names, artist names, etc., are displayed here. ^[1] JPEG images embedded in ID3 tags are displayed as the jacket photo. ^[2]
	Extensions other than aac	Meta tags (embedded tags) are supported. Titles, album names, artist names, etc., are displayed here. ^[1] JPEG images embedded in tags are displayed as the jacket photo. ^[2]
File extension		.m4a, .aac and .mp4

[1] To display characters written in a local code other than Unicode, change the [LAN-GUAGE] setting at [UTILITY] (page 22).

[2] Files larger than 800 x 800 dots cannot be displayed.

About WAV files

The CDJ-2000 supports WAV files in the formats shown below.

Compatible formats	The 16-/24-bit non-compressed PCM format and sampling frequencies of 44.1 kHz and 48 kHz are supported.
Track information	LST chunk Titles, album names, artist names, etc., are displayed here. ^[1]
File extension	.wav

[1] To display characters written in a local code other than Unicode, change the [LAN-GUAGE] setting at [UTILITY] (page 22).

About AIFF files

The CDJ-2000 supports AIFF files in the formats shown below.

Compatible formats	The 16-/24-bit non-compressed PCM format and sampling frequencies of 44.1 kHz and 48 kHz are supported. Titles, album names, artist names, etc., are displayed here. ^[1]
File extension	.aif, .aiff

[1] To display characters written in a local code other than Unicode, change the [LAN-GUAGE] setting at [UTILITY] (page 22).

About rekordbox

- rekordbox is an application for managing music files which are used for DJ play with a Pioneer DJ Player (i.e. CDJ-2000, CDJ-900). Data that has been detected and measured, as well as any points which have been set and stored using rekordbox, can be used in combination with a Pioneer DJ Player (i.e. CDJ-2000, CDJ-900) to achieve outstanding DJ performance.
- Install rekordbox from the included CD-ROM onto a computer. For instructions on using rekordbox, see *Using in combination with rekordbox* on page 12 and *About the rekordbox software* on page 23.

Part Names and Functions

Control Panel

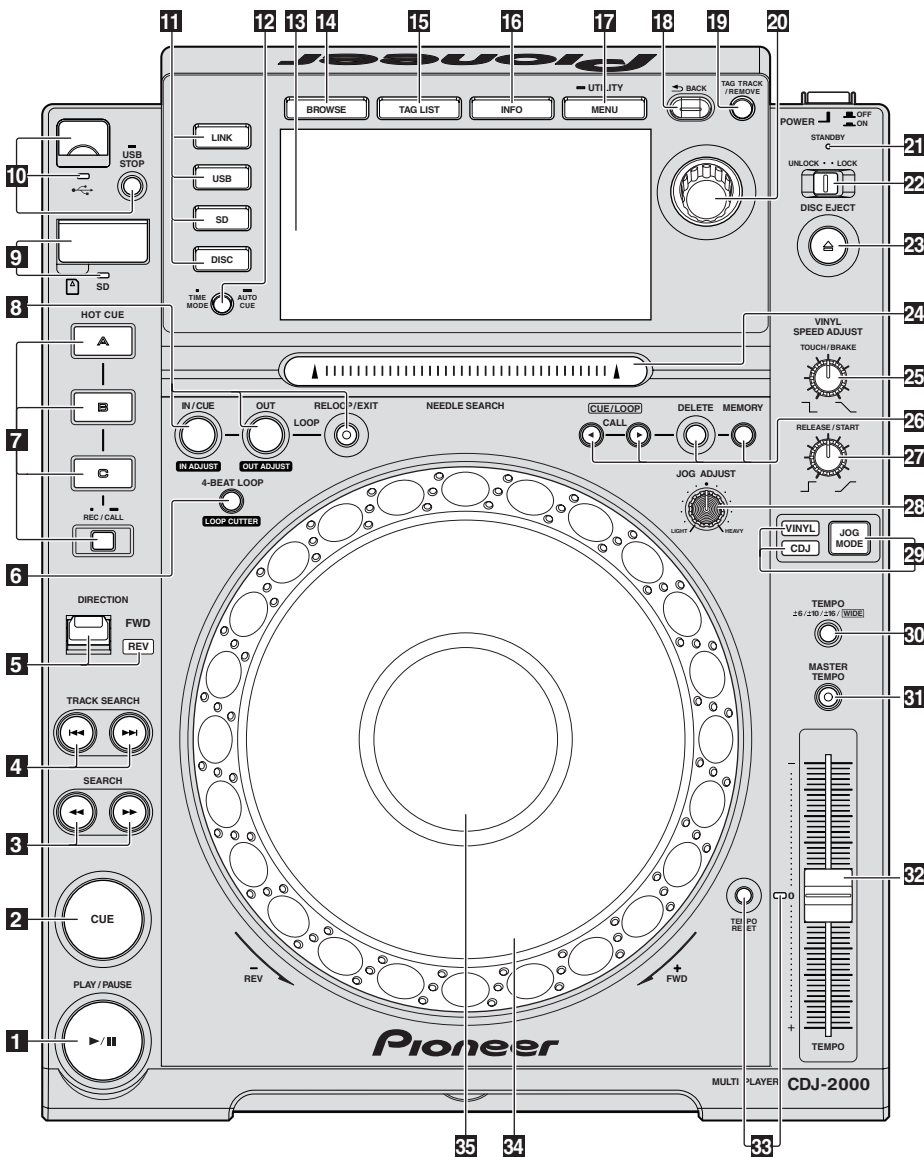

Rear Panel

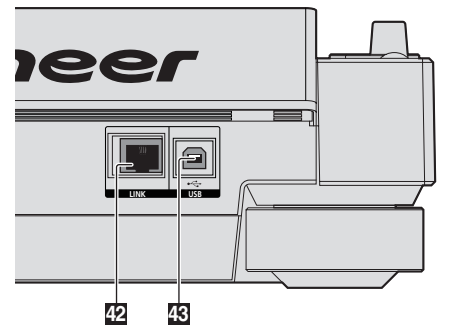
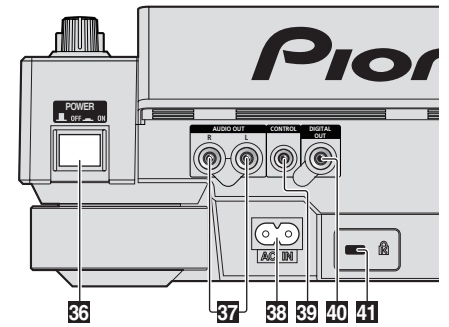

Front Panel

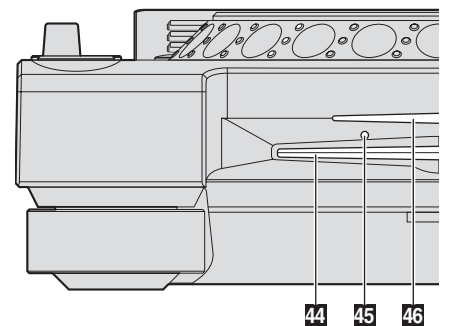

Control Panel

1 PLAY/PAUSE ►/|| and PLAY/PAUSE ►/|| indicator (page 15)

This lights when playing tracks and flashes when in the pause mode.

2 CUE and CUE indicator (page 16)

This lights when a cue point is set (except during track searching), and flashes when a new cue point can be set in the pause mode.

3 SEARCH ◀/▶ (page 15)

The track is forwarded/reversed while the button is held in.

4 TRACK SEARCH ◀◀/▶▶ (page 15)

Use these to search for the beginnings of tracks.

5 DIRECTION FWD REV (page 15)

Use this to turn reverse playback on and off.

REV indicator (page 15)

This lights when playing in the reverse direction.

6 4-BEAT LOOP/LOOP CUTTER (page 17)

Use this to set loops automatically. When pressed during loop playback, the loop is cut.

7 HOT CUE (A, B, C, REC/CALL) (page 17)

Use this to set, play and call out hot cues.

8 LOOP IN/CUE (IN ADJUST) (page 16)

Use this to set and fine-adjust the loop in point.

LOOP OUT (OUT ADJUST) (page 16)

Use this to set and fine-adjust the loop out point.

RELOOP/EXIT (page 16)

Use this to return to loop playback (reloop) or cancel loop playback (loop exit).

9 SD memory card door (page 14)

This opens and closes when loading and unloading SD memory cards.

SD memory card insertion slot (page 14)

Load SD memory cards here.

SD memory card indicator (page 14)

This flashes when communicating with the SD memory card.

10 USB device insertion slot (page 14)

Load the USB device here.

USB indicator (page 14)

This flashes when this unit is communicating with the USB device.

USB STOP (page 14)

Press for at least 2 seconds before disconnecting the USB device.

- 11 LINK (page 15)**
Press this to play music files on media loaded in other DJ players.
- USB (page 15)**
Press this to play the music files on a USB device.
- SD (page 15)**
Press this to play music files on the SD memory card.
- DISC (page 15)**
Press this to play music files on CDs, CD-ROMs or DVD-ROMs.
- 12 TIME MODE/AUTO CUE (page 16)**
When pressed once, the main unit display's time display mode (remaining time display or elapsed time display) switches.
When pressed for over 1 second, auto cue turns on and off.
- 13 Main unit display (page 11)**
- 14 BROWSE (page 19)**
Press this to display the [BROWSE] screen.
- 15 TAG LIST (page 20)**
Press this to display the [TAG LIST] screen.
- 16 INFO (page 21)**
Press this to display the [INFO] screen.
- 17 MENU/UTILITY (page 22)**
When pressed once, the menu screen is displayed.
The [UTILITY] screen is displayed when this is pressed for over 1 second.
- 18 BACK (page 19)**
Press this once to return to the previous screen.
Press for over 1 second to move to the top layer.
- 19 TAG TRACK/REMOVE (page 20)**
Use these to add and remove tracks from the tag list.
- 20 Rotary selector and indicator**
When selecting tracks or setting items, the cursor moves when the rotary selector is turned. Press the rotary selector to enter.
- 21 STANDBY indicator (page 22)**
This lights when in the standby mode.
- 22 UNLOCK, LOCK (page 14)**
This locks the player so that discs cannot be ejected and tracks cannot be loaded except when in the pause mode.
- 23 DISC EJECT▲ and DISC EJECT indicator (page 14)**
Use this to eject discs.
- 24 NEEDLE SEARCH pad (page 19)**
The sound is played from the position at which the pad is touched.
- 25 VINYL SPEED ADJUST TOUCH/BRAKE (page 18)**
This adjusts the speed at which playback stops when the top of the jog dial is pressed.
- 26 CUE/LOOP CALL◀/▶ (page 18)**
Use these to call out stored cue and loop points.
- DELETE (page 18)**
Use this to delete cue and loop points.
- MEMORY (page 18)**
Use this to store cue and loop points in the memory.
- 27 VINYL SPEED ADJUST RELEASE/START (page 18)**
This adjusts the speed at which playback returns to the normal speed when the top of the jog dial is released.
- 28 JOG ADJUST (page 18)**
This adjusts the load applied when the jog dial is spun.
- 29 JOG MODE, VINYL mode indicator and CDJ mode indicator (page 18)**
The mode switches between VINYL and CDJ each time this is pressed. The indicator for the selected mode lights.
- 30 TEMPO ±6/±10/±16/WIDE (page 15)**
Use this to switch the playing speed adjustment range.
- 31 MASTER TEMPO (page 15)**
Use this to turn the master tempo function on and off.
- 32 TEMPO (page 15)**
Use this to adjust the track playing speed.

- 33 TEMPO RESET and TEMPO RESET indicator**
Regardless of the position of the TEMPO dial, tracks are played at the original playing speed recorded on the disc, etc. The indicator lights when TEMPO RESET is turned on.
- 34 Jog dial (-REV/+FWD) and JOG RING ILLUMINATION (page 18)**
This can be used for such operations as scratching, pitch bending, etc.
- 35 Jog dial display section (page 11)**

Rear Panel

- 36 POWER ⏻ ON ■ OFF**
Press to turn the power on and off.
- 37 AUDIO OUT L/R (page 12)**
Connect the audio cables (included) here.
- 38 AC IN (page 12)**
Connect this to a power outlet.
Connect the power cord after all the connections between devices have been completed.
Be sure to use the included power cord.
- 39 CONTROL (page 19)**
Connect the control cord (included) here.
- 40 DIGITAL OUT**
Connect a digital coaxial cable here.
- 41 Kensington security slot**
- 42 LINK (page 12)**
Connect the LAN cable (included) here.
- 43 USB (page 12)**
Connect to a computer.

Front Panel

- 44 Disc insertion slot**
- 45 Disc force eject pin insertion hole**
- 46 Disc insertion slot indicator**

About ejecting discs by force

- If the disc cannot be ejected by pressing [DISC EJECT▲], the disc can be ejected forcibly by inserting the disc force eject pin all the way into the disc force eject pin insertion hole on the main unit's front panel.
- When forcibly ejecting a disc, be sure to do so following the procedure below.

1 Press [POWER] and wait at least 1 minute after the set's power has turned off.

Never forcibly eject a disc directly after turning off the set's power. Doing so is dangerous for the reasons described below.
The disc will still be spinning when ejected and could hit your fingers, etc., causing injury.
Also, the disc clamp will rotate in an unstable way, and the disc could get scratched.

2 Use the included disc force eject pin. (Do not use anything else.)

The included disc force eject pin is mounted on the CDJ-2000's bottom panel. When the pin is inserted all the way into the insertion hole, the disc is ejected 5 mm to 10 mm out of the disc insertion slot. Grasp the disc with your fingers and pull it out.

Main unit display

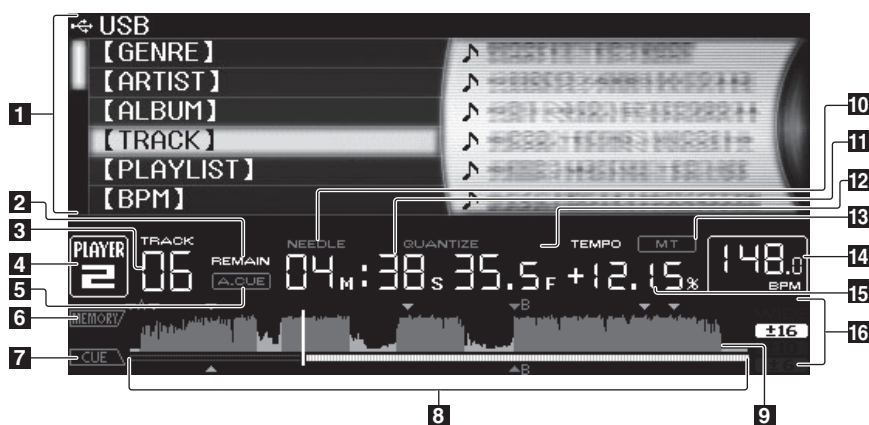

1 Information display section

2 REMAIN

This lights when the time display is set to the remaining time.

3 TRACK

This indicates the track number (01 – 99).

4 PLAYER

This indicates the player number (1 – 4) assigned to this CDJ-2000.

5 A. CUE (page 16)

This lights when auto cue is set.

6 MEMORY

Cue points, loop points and hot cues recorded on SD memory cards and USB devices are displayed as marks.

7 CUE

The positions of cue points, loop points and hot cues are displayed as marks.

8 Playing address display

The track is displayed as a bar graph. The current playback position is displayed as a white vertical line. When the elapsed time is displayed, the left edge of the graph lights. When the remaining time is displayed, the display turns off from the left side. The entire graph flashes slowly when there are less than 30 seconds remaining in the track, then begins flashing rapidly when less than 15 seconds remain.

9 WAVE display

This displays the WAVE display, guidance, etc.

10 NEEDLE

This lights when needle searching is possible.

11 Time display (minutes, seconds and frames)

There are 75 frames to a second.

12 QUANTIZE

This lights red when [QUANTIZE] is turned on.

When [QUANTIZE] is turned on, the loop points and hot cue are automatically set to the beat nearest the position at which [LOOP IN/CUE (IN ADJUST)], [LOOP OUT (OUT ADJUST)], [4-BEAT LOOP] or [HOT CUE] (A, B or C) was pressed.

The quantize function does not work in the following situations ([QUANTIZE] is displayed in gray):

- When playing tracks recorded on discs
- When playing music files that have not been analyzed with rekordbox
- In the pause mode

13 MT

This lights when the master tempo is set (page 15).

14 BPM

Displays BPM (Beats Per Minute) of the track currently being played.

15 Playing speed display

The number changes according to the position of [TEMPO].

16 Playing speed adjustment range display

This indicates the range in which the playing speed can be adjusted with respect to the original playing speed recorded on the medium.

Jog dial display section

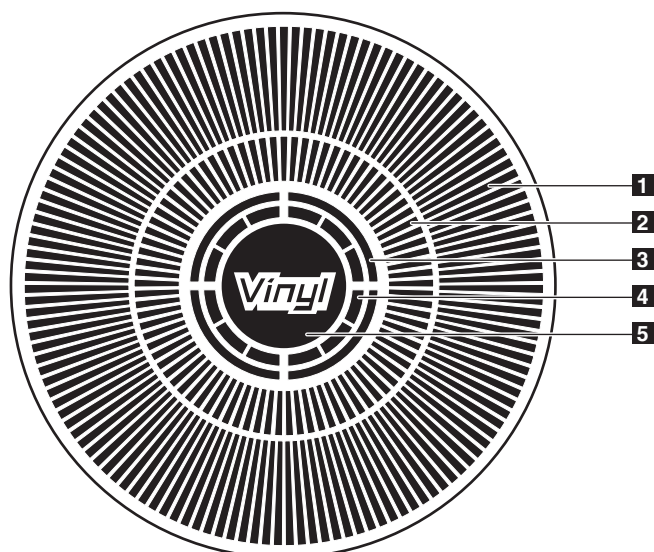

1 Operation display

This indicates the playing position, with one revolution equal to 135 frames. It turns during playback and stops in the pause mode.

2 Cue point display

3 Audio memory status display

This flashes when the audio memory is being written. It stops flashing, remaining lit, when writing is completed.

The operations below may not be possible while the audio memory is being written.

- Setting Cue Point during playback (Real Time Cue)
- Setting Hot Cue

The display also flashes when there is not enough memory due to scratch play.

4 Jog touch detection display

When the jog mode is set to VINYL, the top of the jog dial lights when pressed.

5 VINYL

This lights when the jog mode is set to VINYL (page 18).

Connections

Be sure to turn off the power and unplug the power cord from the power outlet whenever making or changing connections. Refer to the operating instructions for the component to be connected. Connect the power cord after all the connections between devices have been completed.

Do not disconnect the LAN cable when music files and/or information are being shared using PRO DJ LINK.

Basic style

- rekordbox music files and data can be transferred to the CDJ-2000 using USB devices (flash memory drives, hard discs, etc.), eliminating the need to bring a computer into the DJ booth. Playlist, cue, loop and hot cue information set with rekordbox in advanced can be used for DJ play.
- The contents of media loaded in DJ players (tracks, cue point memories, WAVE information, etc.) can be shared. For details, see *Using the PRO DJ LINK function* on page 14.
- Up to four units can be connected. A switching hub (commercially available) is required to connect three or more units. Use a switching hub of 100 Mbps or greater. Note that some switching hubs may not operate normally.

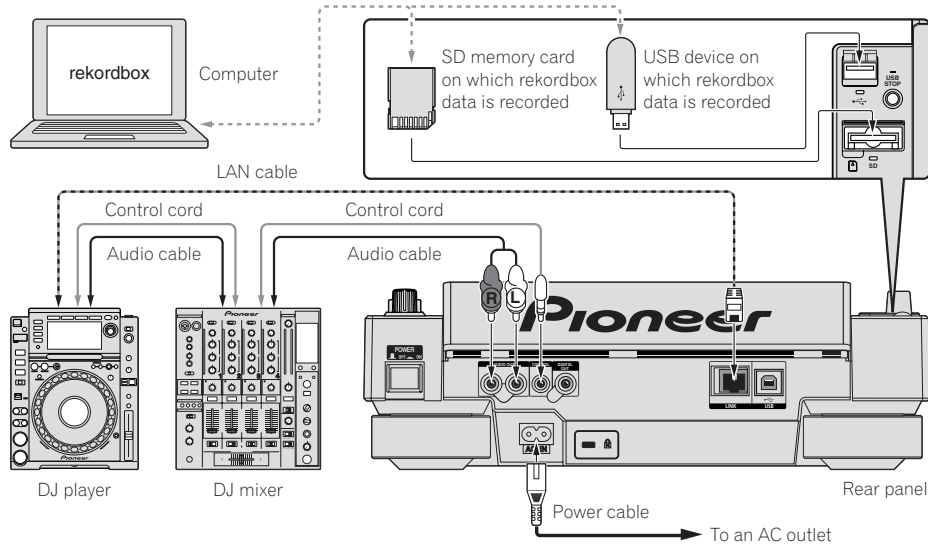

Using in combination with rekordbox

- When connected by LAN cable to a computer on which rekordbox is installed, tracks in rekordbox can be selected and played. For instructions on operating rekordbox on the computer, see the rekordbox manual. Instructions on operating rekordbox can be found in the rekordbox [Help] menu.
- Up to two computers can be connected.
- The contents of media loaded in the different DJ players (tracks, cue point memories, WAVE information, etc.) can be displayed (page 15).
- Up to four units can be connected. A switching hub (commercially available) is required to connect three or more units. Use a switching hub of 100 Mbps or greater. Note that some switching hubs may not operate normally.

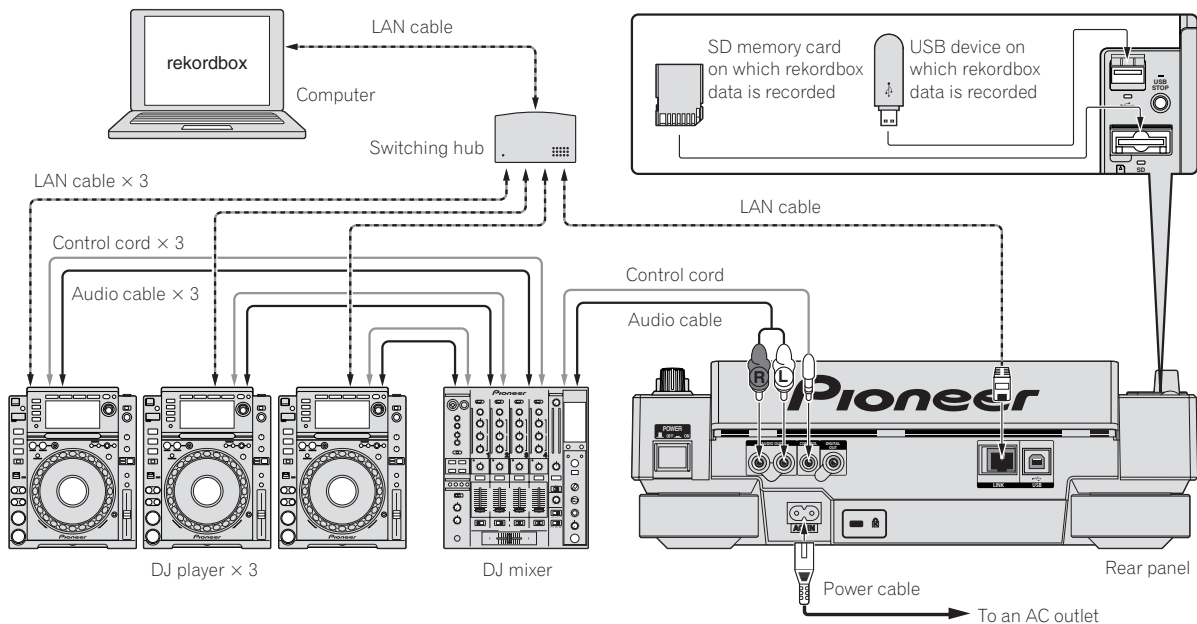

Using other brands of DJ software

With the CDJ-2000, the operating information of the buttons, tempo adjustment dial, etc., can also be output in universal MIDI format. When connected by USB cable to a computer on which MIDI-compatible DJ software is installed, the DJ software can be operated from the CDJ-2000. The sound of music files being played on the computer can also be output from the CDJ-2000. For details, see *About the driver software* on page 26 and *Using other brands of DJ software* on page 27.

- Connect a computer on which Mac OS X (10.4.6 or later), Windows Vista® or Windows® XP is installed.

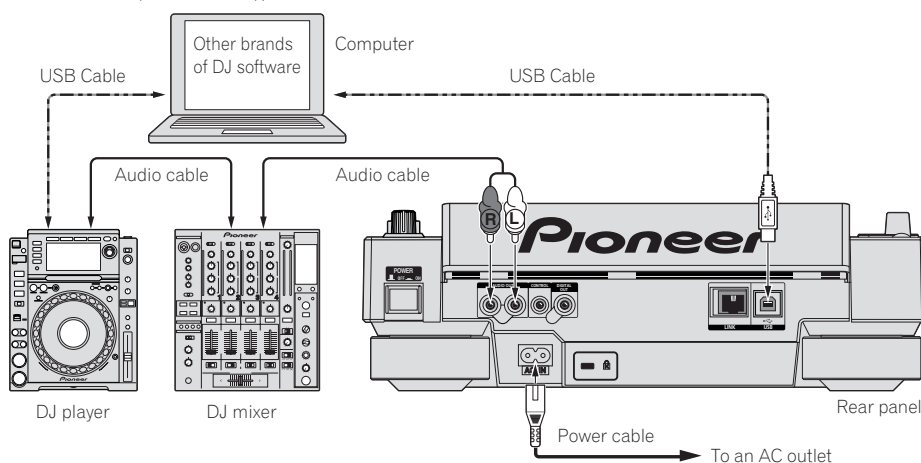

Connections for relay play

Relay play between two DJ players is possible by interconnecting the CDJ-2000 and a Pioneer DJ player using the **CONTROL** jacks (page 19).

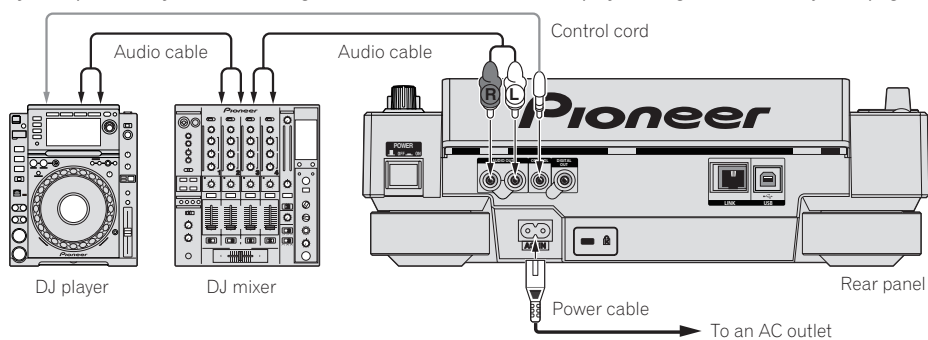

Playback

Loading discs

- Set the disc with the printed side facing up.
- Insert the disc into the disc insertion slot on the set's front panel.
- Do not insert two or more discs at once.
- Do not force discs into the set's disc insertion slot when the set's power is off. Doing so could damage the disc or the set.
- When the disc is being drawn in or ejected, do not apply any force to the disc in the direction opposite its movement. Doing so could damage the disc or the set.

1 Press [POWER].

Turn on the power of this unit.

2 Insert the disc into the disc insertion slot.

Playback starts.

- When auto cue is turned on, playback starts when [PLAY/PAUSE▶/II] is pressed. For details on the auto cue function, see *Setting auto cue* on page 16.

Ejecting discs

Press [DISC EJECT▲].

The disc is ejected from the disc insertion slot.

- If [DISC EJECT▲] is pressed by mistake, press [PLAY/PAUSE▶/II] immediately. The set is restored to the status it was in just before [DISC EJECT▲] was pressed. (No sound is output during this time.)
- When [UNLOCK/LOCK] is set to [LOCK], press [PLAY/PAUSE▶/II] to set the pause mode, then press [DISC EJECT▲].

Loading SD memory cards

1 Open the SD memory card door.

2 Insert the SD memory card.

Insert the SD memory card vertically, with the back side facing forward and the notch facing down. Push the card in slowly until it stops.

3 Close the SD memory card door.

The SD memory card indicator lights.

- When an SD memory card that has previously been loaded in the CDJ-2000 or a Pioneer DJ player is loaded, the number of discs for which WAVE information, etc., is recorded is displayed on the main unit display.

Ejecting SD memory cards from the set

Do not eject SD memory cards or turn off the CDJ-2000's power while the SD memory card indicator is flashing. Doing so could damage the data recorded on the card.

1 Open the SD memory card door.

The SD memory card indicator turns off.

2 Press the SD memory card in. When it pops back up, pull it out vertically.

- Do not forcibly insert or remove SD memory cards. Doing so could damage the SD memory card or the set.
- Do not insert any objects other than SD memory cards into the SD memory card insertion slot. Inserting coins or other metal objects could damage the internal circuitry, resulting in malfunction.

Loading USB devices

Insert the USB device into the USB port.

The USB indicator lights.

- When a USB device that has previously been loaded in the CDJ-2000 or a Pioneer DJ player is loaded, the number of discs for which WAVE information, etc., is recorded is displayed on the main unit display.

Removing USB devices from the set

- Be sure to follow the procedure below when removing USB devices from the set. Removing a USB device without following this procedure could erase the set's management data and make it impossible to read the USB device.
- When turning the set's power off, be sure to remove the USB device first.

1 Press [USB STOP] for over 2 second.

The USB indicator turns off.

2 Disconnect the USB device.

Using the PRO DJ LINK function

When two or more CDJ-2000s are connected by LAN cable, tracks recorded on SD memory cards or USB devices connected to other players can be loaded onto this unit.

1 Connect this unit and other DJ players using LAN cables.

2 Press [LINK].

Media loaded in another DJ player is displayed on this unit's display.

3 Select the medium and enter.

The medium's contents are displayed.

4 Select the track and enter.

The track is loaded into this unit.

- The information below can be shared among DJ players connected by PRO DJ LINK.
 - Tracks (music files)
 - TAG LIST (page 20)
 - INFO (page 21)
 - Disc cue points
 - Disc WAVE displays

Sharing disc information

1 Load an SD memory card or USB device into the DJ player connected by PRO DJ LINK.

2 Load a disc in the CDJ-2000.

When no SD memory card or USB device is loaded in this unit, the player number and check screen for DJ players in which SD memory cards or USB devices are loaded are displayed on this unit's display.

3 Press [MEMORY] on this unit.

The disc information set for this unit is registered on the SD memory card/USB device of the DJ player connected by PRO DJ LINK.

- When multiple DJ players are connected by PRO DJ LINK and SD memory cards/USB devices are loaded in two or more DJ players, discs are not registered in DJ players other than this one.
- If [DELETE] is pressed in step 3, the disc information is not registered on any DJ player. No disc information is registered on any DJ player until the SD memory card/USB device is loaded on the CDJ-2000. To register the disc information, press [DISC], then press [MENU/UTILITY] and select the player in which the information is to be registered.

Browsing libraries and folders

The browsing display differs depending on whether or not library information is recorded on the SD memory card/USB device.

- With library information → Library browsing: The music files are displayed by the categories set in rekordbox (album, artist, etc.).
- Without library information → Folder browsing: The folders/tracks on the medium are displayed with a tree structure.

The types of items on the category menu can be changed in rekordbox's preferences.

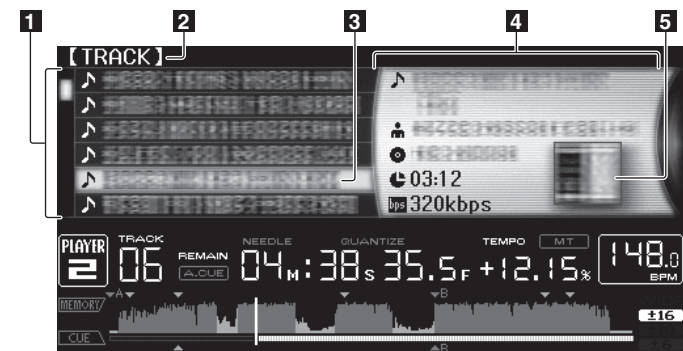

1 List of contents	The contents of the selected medium are displayed.
2 Uppermost level	Displays the name of the upper folder or media of the displayed item.
3 Cursor	Turn the rotary selector to move the cursor up and down.
4 Contents of selected item	The contents of the line selected with the cursor are displayed.
5 Jacket photo	When artwork is registered in rekordbox or when the ID3 tag contains a JPEG image, the image for the track selected with the cursor is displayed.

Playback

1 Load the medium in this unit.

2 Press [DISC], [SD], [USB] or [LINK].

The contents of the selected medium are displayed.

3 Turn the rotary selector.

Select the track. The category/folder/track information is displayed.

- Once the lowermost level in the folder is reached, press the rotary selector. Press [BACK] to return to the uppermost level.
- Press [BACK] for over 1 second or press the media button of the medium you are browsing to return to the uppermost level.

4 Press the rotary selector.

The track is loaded and playback begins.  is displayed to the left of the track that is playing, and the selected media button flashes.

- [TRACK SEARCH] can be used to select tracks within the currently playing track's category/folder.
- When a disc containing music files recorded with a hierarchical structure is loaded, playback starts from the tracks in the uppermost level.
- When [UNLOCK/LOCK] is set to [LOCK], press [PLAY/PAUSE] to set the pause mode, then press the rotary selector.

Pausing

During playback, press [PLAY/PAUSE] / [II].

The [PLAY/PAUSE] / [II] and CUE indicators flash. Press [PLAY/PAUSE] / [II] again to resume playback.

- If no operation is performed for 100 minutes while in the pause mode, the disc automatically stops spinning. When [PLAY/PAUSE] / [II] is pressed at this time, playback resumes from the first track. When auto cue is turned on, the set cues to the first track and pauses there.

❖ Resuming playback from the position playing just before the disc was ejected (Resume)

- After a disc is ejected, if that same disc is immediately reloaded in the CDJ-2000, playback resumes from the position playing just before the disc was ejected.
- The resume function only works when the same disc is ejected then reloaded before loading another disc.
- When [TRACK SEARCH] is pressed before starting playback, the set searches for the beginning of the track and playback starts.
- The resume function does not work for SD memory cards or USB devices.

Forward and reverse scanning

Press [SEARCH] / [FWD/REV].

When [SEARCH] / [FWD/REV] pressed and held in, the track is fast-forwarded or fast-reversed.

- When the music files are recorded in a folder structure, only tracks within the same category/folder are fast-forwarded/fast-reversed.

Finding the beginnings of tracks (Track Search)

Press [TRACK SEARCH] / [FWD/REV].

Press the [FWD/REV] to move to the beginning of the next track.

When [FWD/REV] is pressed, the beginning of the currently playing track is searched. When pressed twice consecutively, the set returns to the beginning of the previous track.

- When the music files are recorded in a folder structure, only tracks within the same category/folder are searched.
- When auto cue is turned on, the set searches for the beginning of the track and pauses there (page 16).

Adjusting the playing speed (Tempo control)

Move [TEMPO] up or down.

The tempo increases when moved to the [+] side (down), decreases when moved to the [-] side (up). The rate at which the playing speed is changed is indicated on the playing speed display.

❖ Selecting the range for adjusting the playing speed

Press [TEMPO ±6/±10/±16/WIDE].

The range of adjustment of the [TEMPO] control switches each time the button is pressed. The adjustment range setting is indicated on the playing speed adjustment range display.

- The tempo can be adjusted in units of 0.02 % when set to ±6 %, in steps of 0.05 % when set to ±10 %, in steps of 0.05 % when set to ±16 %, and in steps of 0.5 % when set to **WIDE**.
- The adjustment range is ±100 % when set to **WIDE**. When set to -100 %, playback stops.
- The adjustment range is set to ±10 % when the power is turned on.

Adjusting the playing speed without changing the pitch (Master Tempo)

Press [MASTER TEMPO].

The **MASTER TEMPO** indicator and [MT] on the main unit display light. The pitch does not change even when the playing speed is changed with the [TEMPO] control.

- The sound is digitally processed, so the sound quality decreases.

Playing in reverse

Set [DIRECTION FWD/REV] to [REV].

The **REV** indicator lights and the track plays in the reverse direction.

- When the music files are recorded in a folder structure, only tracks within the same category/folder can be played in reverse. Also note that reverse playback may not start immediately.
- The direction in which the playing speed is increased or decreased according to the direction in which the jog dial is turned is reversed.
- When such operations as track searching and loop playback are performed during reverse playback, the audio memory status display on the jog dial display section flashes and scratch play may not be possible.

Setting Cue

1 During playback, press [PLAY/PAUSE▶/II].

Playback is paused.

2 Press [CUE].

The point at which the track is paused is set as the cue point. The CUE indicator lights and the PLAY/PAUSE▶/II indicators flashes. No sound is output at this time.

- When a new cue point is set, the previously set cue point is canceled.
- For instructions on saving cue points. see *Storing cue and loop points* on page 18.

Adjusting the cue point position

1 Press [SEARCH◀◀/▶▶] while pausing at the cue point.

The CUE and PLAY/PAUSE▶/II indicators flash.

2 Press [SEARCH◀◀/▶▶].

The cue point can be fine-adjusted in steps of 0.5 frames.

- The same operation is possible using the jog dial.

3 Press [CUE].

The point at which the button was pressed is set as the cue point.

- When a new cue point is set, the previously set cue point is canceled.
- When the medium containing the track is removed, the cue point is canceled. For instructions on saving cue points. see *Storing cue and loop points* on page 18.

Returning to Cue Point (Back Cue)

During playback, press [CUE].

The set immediately returns to the currently set cue point and pauses.

- When [PLAY/PAUSE▶/II] is pressed, playback starts from the cue point.

Checking Cue Point (Cue Point Sampler)

Press and hold [CUE] after returning to the cue point.

Playback starts from the currently set cue point. Playback continues while [CUE] is pressed in.

- When the music files are recorded in a folder structure, the cue point can only be checked for tracks within the same category/folder.

Setting Cue Point during playback (Real Time Cue)

During playback, press [LOOP IN/CUE (IN ADJUST)] at the position at which you want to set the cue point.

The point at which the button was pressed is set as the cue point.

Setting auto cue

When a track is loaded or the track search operation is performed, the silent section at the beginning of the track is skipped and the cue point is automatically set at the point immediately before the sound starts.

Press [TIME MODE/AUTO CUE] for over 1 second.

Auto cue is turned on. [A. CUE] lights on the main unit display.

- The auto cue level setting remains in the memory, even when the power is turned off.

Changing the auto cue level

The sound pressure level for identifying a section as silent can be selected from among the following eight steps:

-36 dB, -42 dB, -48 dB, -54 dB, -60 dB, -66 dB, -72 dB and -78 dB

- The auto cue level setting remains in the memory, even when the power is turned off.
- There are two ways to change the auto cue level, as shown below.

❖ Changing procedure - [MENU/UTILITY]

1 Press [MENU/UTILITY] for over 1 second.

The [UTILITY] screen is displayed.

2 Select [AUTO CUE LEVEL] and enter.

3 Turn the rotary selector.

The auto cue level setting changes.

❖ Changing procedure - [TIME MODE/AUTO CUE]

1 Press [TIME MODE/AUTO CUE] for at least 5 seconds.

The auto cue level setting changing mode is set.

2 Press [CUE/LOOP CALL◀/▶].

The auto cue level setting changes.

- To cancel the changing mode, press [TIME MODE/AUTO CUE] again.

Setting Loop

1 During playback, press [LOOP IN/CUE (IN ADJUST)] at the position at which you want to start looping (the loop in point).

Loop In Point is set.

- This operation is not necessary if you have already set a Cue Point as a Loop In Point.

2 Press [LOOP OUT (OUT ADJUST)] at the position at which you want to stop looping (the loop out point).

The Loop Out Point is set, and Loop playback starts from the Loop In Point.

- When playing music files, looping can only be set within the same track.

Fine-adjusting the loop in point (loop in adjust)

1 During loop playback, press [LOOP IN/CUE (IN ADJUST)].

[LOOP IN/CUE (IN ADJUST)] switches to a fast flashing and [LOOP OUT (OUT ADJUST)] turns off.

The loop in point's time is displayed on the main unit display.

2 Press [SEARCH◀◀/▶▶].

The loop in point can be adjusted in units of 0.5 frames.

- The same operation is possible using the jog dial.
- The loop in point can be adjusted by ± 30 frames and must be in front of the loop out point.

3 Press [LOOP IN/CUE (IN ADJUST)].

- Normal loop playback resumes.
- Normal loop playback also resumes if no operation is performed for over 10 seconds.
- When playing music files, the loop in point can only be adjusted within the same track.

Fine-adjusting the loop out point (loop out adjust)

1 During loop playback, press [LOOP OUT (OUT ADJUST)].

[LOOP OUT (OUT ADJUST)] switches to a fast flashing and [LOOP IN/CUE (IN ADJUST)] turns off.

The loop out point's time is displayed on the main unit display.

2 Press [SEARCH◀◀/▶▶].

The loop out point can be adjusted in units of 0.5 frames.

- The same operation is possible using the jog dial.
- The loop out point adjustment range is anywhere after the loop in point.

3 Press [LOOP OUT (OUT ADJUST)].

Normal loop playback resumes.

- Normal loop playback also resumes if no operation is performed for over 10 seconds.
- When playing music files, the loop out point can only be adjusted within the same track.

Canceling Loop playback (Loop Exit)

During loop playback, press [RELOOP/EXIT].

Playback continues after the Loop Out Point without returning to the Loop In Point.

Returning to Loop playback (Reloop)

After canceling loop playback, press [RELOOP/EXIT] during playback.

Playback returns to the previously set Loop In Point, and Loop playback resumes.

Setting loops automatically (4-beat Loop)

During playback, press [4-BEAT LOOP/LOOP CUTTER].

A loop of 4 beats starting from the point at which the button was pressed is set automatically according to the BPM of the currently playing track, and loop playback starts.

- If the track's BPM cannot be detected, the BPM is set to 130.

❖ 8-beat loop

During playback, press [4-BEAT LOOP/LOOP CUTTER] for over 1 second.

A loop extending 8 beats from the point at which the button was pressed is set automatically and loop playback begins.

Cutting loops (Loop Cut)

During loop playback, press [4-BEAT LOOP/LOOP CUTTER].

The loop playing time is cut in half each time the button is pressed.

Extending loops

During loop playback, press [4-BEAT LOOP/LOOP CUTTER] while pressing in [LOOP OUT (OUT ADJUST)].

The loop playing time is doubled each time the button is pressed.

- The same operation can be performed as described below.
 - Press [SEARCH ◀▶] while pressing [LOOP OUT (OUT ADJUST)].
 - Turn the jog dial while pressing [LOOP OUT (OUT ADJUST)].

Setting loops automatically based on the track's tempo (quantized beat loop)

1 During loop playback, press [LOOP OUT (OUT ADJUST)].

The beat selection screen appears on the main unit display and [RELOOP/EXIT] flashes according to the BPM.

- When [LOOP OUT (OUT ADJUST)] is pressed again, the beat selection screen is canceled.

2 Touch the [NEEDLE SEARCH] pad.

The marker under the beat number for the touched position lights red.

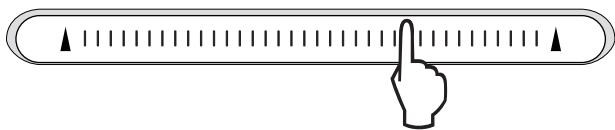
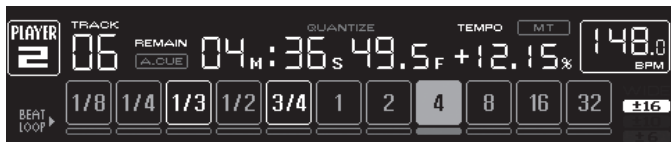

3 Release your finger from the [NEEDLE SEARCH] pad.

The number of loops for loop playback is set to the number of loops for which the marker is lit.

- When playing a track that has been analyzed using rekordbox, the next loop is set from the next beat.
- When playing a track that has not been analyzed, the next loop is set according to the BPM of the track being played.

Setting Hot Cue

1 Press [HOT CUE REC/CALL].

The set switches to the hot cue recording mode. The HOT CUE indicator (A, B, C) light red.

2 During playback or in the pause mode, press [HOT CUE] (A, B or C) at the point at which you want to set the hot cue.

The position at which the button was pressed or the currently playing loop is set at the [HOT CUE] button (note that the direction of playback is not recorded). The button's indicator flashes.

- While the hot cue is being recorded, it is not possible to record other [HOT CUE] buttons, set cue points, fast-forward/fast-reverse or scratch play.
- When an SD memory card or USB device is loaded in the player, the point information is recorded automatically.

- When a hot cue is set during scratch play, playback may stop temporarily.

Playing hot cues

1 Press [HOT CUE REC/CALL].

The hot cue playing mode is set.

- The indicators of buttons at which cue points are recorded light green.
- The indicators of buttons at which loop playback is recorded light orange.
- The indicators of the buttons at which nothing is recorded do not light.

2 During playback or in the pause mode, press [HOT CUE] (A, B or C).

Playback starts instantaneously from the point recorded at that button.

- For loop playback recorded at the [HOT CUE] buttons, the information differs from loop playback set using the [LOOP IN/CUE (IN ADJUST)] and [LOOP OUT (OUT ADJUST)] buttons. Loop playback can be canceled using the [RELOOP/EXIT] button and the loop out point can be fine-adjusted using the [LOOP OUT (OUT ADJUST)] button. Adjusting this directly changes the information recorded at the [HOT CUE] buttons (A, B and C).

Calling out Hot Cue

❖ Procedure for calling out hot cues (for discs)

1 Load an SD memory card/USB device in the CDJ-2000.

2 Load a disc in the CDJ-2000.

When the disc's hot cues are recorded on the SD memory card/USB device, the HOT CUE indicator (A, B or C) flashes.

3 Press the [HOT CUE] button (A, B or C) whose hot cue you want to call out.

The hot cue is called out. The HOT CUE (A, B, C) indicator lights.

- If you do not want to call out a hot cue, press [HOT CUE REC/CALL] without pressing [HOT CUE] (A, B or C). Buttons for which no hot cue was not called out turn off.
- When playing tracks recorded on media other than discs, hot cues cannot be called out even when a disc for which hot cues are recorded is loaded in the CDJ-2000.
- If you accidentally cancel the hot cue call out mode, eject the SD memory card/USB device, then reload it.

❖ Procedure for calling out hot cues (for SD memory cards/USB devices)

1 Load an SD memory card/USB device in the CDJ-2000.

2 Load the track whose hot cue you want to call out.

3 Press [HOT CUE REC/CALL] for over 1 second.

The set switches to the hot cue call out mode, and the HOT CUE indicators (A, B or C) at which hot cues are recorded flash.

4 Press the [HOT CUE] button (A, B or C) whose hot cue you want to call out.

The hot cue is called out. The HOT CUE (A, B, C) indicator lights.

- If you do not want to call out a hot cue, press [HOT CUE REC/CALL] without pressing [HOT CUE] (A, B or C). Buttons for which no hot cue was not called out turn off.
- If you accidentally cancel the hot cue call out mode, press [HOT CUE REC/CALL] again.

❖ Canceling the hot cue call out mode

Perform one of the operations below to cancel the hot cue call out mode.



The hot cue call out mode is not canceled when a different track is played.

1 Calling out hot cues A, B and C.

2 Press [HOT CUE REC/CALL].

Storing cue and loop points

- 1 Load an SD memory card/USB device in the CDJ-2000.
- 2 Set Cue Point or Loop Point.
- 3 Press [MEMORY].

 [MEMORY] or  [MEMORY] appears on the main unit display. The stored cue point appears on the playing address display. The point information is registered on the SD memory card/USB device.

- When both an SD memory card and USB device are loaded on the CDJ-2000, the SD memory card has priority.
- To store loop points, press [MEMORY] during loop playback. The stored loop points appear on the playing address display.
- The information is automatically recorded on the SD memory card/USB device.
 - Cue point or loop playback information set at [HOT CUE] (A, B and C)
 - Track's WAVE display information

Calling out saved cue or loop points

- 1 Load an SD memory card/USB device in the CDJ-2000.
- 2 Load the track whose cue or loop points you want to call out. Cue and loop points are displayed as marks on the playing address display.
- 3 Press [CUE/LOOP CALL ◀/▶]. Playback is moved to the selected point and paused.
 - When multiple points are recorded, the point moves each time the button is pressed.
- 4 Press [PLAY/PAUSE ▶/II]. Playback starts from the Cue or Loop point.

Deleting cue or loop points individually

- 1 Load an SD memory card/USB device in the CDJ-2000.
- 2 Load the track containing the cue point or loop points you want to delete. Cue and loop points are displayed as marks on the playing address display.
- 3 Press [CUE/LOOP CALL ◀/▶]. Playback is moved to the selected point and paused.
 - When multiple points are recorded, the point moves each time the button is pressed.
- 4 Press [DELETE].
 [DELETE] is displayed on the main unit display and the selected point information is deleted.

Deleting all cue and loop points for a disc

- 1 Load an SD memory card/USB device in the CDJ-2000. The cue or loop in point is displayed on the playing address display with a mark.
- 2 Press [DELETE] for at least 5 seconds. [DISC CUE/LOOP DATA-DELETE? PUSH MEMORY] appears on the main unit display.
- 3 Press [MEMORY]. All cue and loop points for the disc currently loaded in the CDJ-2000 are deleted.
 - The deletion mode is canceled when any button other than [MEMORY] is pressed.

Deleting all disc information recorded on the SD memory card/USB device

- 1 With no disc loaded in the CDJ-2000, press [DELETE] for at least 5 seconds. [DISC CUE/LOOP DATA-DELETE ALL? PUSH MEMORY] appears on the main unit display.
- 2 Press [MEMORY]. All the disc information recorded on the SD memory card/USB device is deleted.
 - The deletion mode is canceled when any button other than [MEMORY] is pressed.

Operating the jog dial

The top of the jog dial has an embedded switch. Do not place objects on the jog dial or subject it to strong forces. Also note that water or other liquids getting into the set will lead to malfunction.

The jog dial has two modes.

- VINYL mode: When the top of the jog dial is pressed during playback, playback stops, and when the jog dial is spun at this time sound is produced according to the direction in which the jog dial is spun.
- CDJ mode: When the top of the jog dial is pressed, playback stops, and such operations as scratch play are not possible.

Frame search [VINYL·CDJ]

In the pause mode, spin the jog dial.

The position at which the track is pausing can be moved in units of 0.5 frames.

- The position is moved in the direction of playback when the jog dial is spun clockwise, in the reverse direction when it is spun counterclockwise. The position moves 135 for one revolution of the jog dial.

Super fast search [VINYL·CDJ]

Spin the jog dial while pressing in [SEARCH ◀◀/▶▶].

The track is fast-forwarded/fast-reversed in the direction in which the jog dial is spun.

- When the [SEARCH ◀◀/▶▶] button is released, this function is canceled.
- When you stop the jog dial from spinning, normal playback resumes.
- The fast-forward/fast-reverse speed can be adjusted according to the speed at which the jog dial is spun.

❖ Super fast track search

When the jog dial is spun while pressing in [TRACK SEARCH! ◀◀/▶▶], the track advances at high speed in the direction in which the jog dial is spun.

Pitch bend [VINYL·CDJ]

During playback, spin the outer section of the jog dial.

The playing speed increases when spun clockwise, decreases when spun counterclockwise. When spinning is stopped, playback returns to the normal speed.

- When the jog mode is set to the CDJ mode, the same operation can be performed by spinning the top of the jog dial.

Scratch play [VINYL]

When the jog mode is set to the VINYL mode, tracks can be played according to the direction and speed at which the jog dial is spun by spinning the top of the jog dial while pressing it.

- 1 Press [JOG MODE]. Set the jog mode to VINYL.

- 2 During playback, press the top of the jog dial. Playback slows then stops.

- 3 Spin the jog dial in the desired direction and at the desired speed.

The sound is played according to the direction and speed at which the jog dial is spun by spinning the top of the jog dial while pressing it.

- 4 Release your hand from the top of the jog dial. Normal playback resumes.

❖ Adjusting the load when the jog dial is spun

Turn [JOG ADJUST].

The load gets heavier when turned clockwise, lighter when turned counterclockwise.

❖ Adjusting the time until which playback stops when the top of the jog dial is pressed

Turn [VINYL SPEED ADJUST TOUCH/BRAKE].

The speed increases when turned clockwise, decreases when turned counterclockwise.

- When the jog mode is set to VINYL, the speed at which playback stops when [PLAY/PAUSE ▶/II] is pressed changes simultaneously.

- ❖ **Adjusting the speed until which normal playback resumes when the top of the jog dial is released**

Turn [VINYL SPEED ADJUST RELEASE/START].

The speed increases when turned clockwise, decreases when turned counterclockwise.

- When the jog mode is set to VINYL, the speed at which playback starts when [PLAY/PAUSE▶/II] is pressed changes simultaneously.

Operating the [NEEDLE SEARCH] pad

- The [NEEDLE SEARCH] pad can only be operated in the following cases:
 - In the pause mode
 - While the jog dial is being pressed with the jog mode set to VINYL
- Touch the [NEEDLE SEARCH] pad with a finger to easily play the sound at the position at which the pad is touched. Move your finger while touching the pad to quickly move to the desired position.
- For several of the CDJ-2000's functions, this pad is used to input characters.

Playing from the position at which the pad was touched

Touch the [NEEDLE SEARCH] pad.

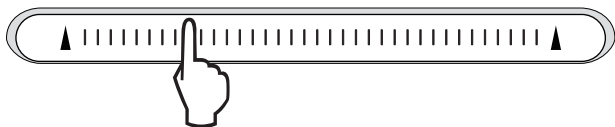

The track is played from the position at which the pad was released. The current playing position on the playing address display moves to directly over the position at which the pad was touched.

- The position of playback can be moved by moving your finger over the pad while touching it. Note that when this is done, the position on the playing address display may not be displayed properly and the sound may not be played properly.

Inputting characters

- ❖ **Inputting search characters using the [SEARCH] buttons**

1 Touch the [NEEDLE SEARCH] pad.

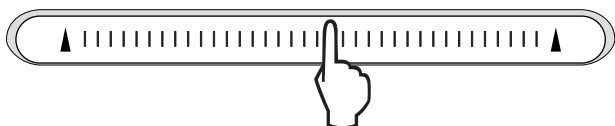

The character directly above the position touched is enlarged.

2 Release your finger from the [NEEDLE SEARCH] pad.

The enlarged character is input.

- To input more characters at this point, repeat the above procedure.
- The characters that can be input are letters A – Z, numbers 0 – 9 and symbols. The characters that can be input switch when the position just below [ABC] or [123] is pressed.
- When [X] is input, a single character is deleted. If input again, characters are deleted consecutively.

Operating the CDJ-2000 in combination with other devices

Starting playback using a DJ mixer's fader (Fader Start)

1 Connect the CDJ-2000 with a Pioneer DJ mixer using the included control cord.

For instructions on connecting, see *Basic style* on page 12.

2 Move the DJ mixer's channel fader or cross fader.

The DJ player's pause mode is canceled and the track is played instantaneously. Also refer to the operating instructions of the connected DJ mixer.

- When the channel fader or cross fader is set back to its original position, playback cues back to the set cue point and the pause mode is set (Back Cue).

Relay play on two DJ players

1 Connect the CDJ-2000 and a DJ mixer.

For instructions on connecting, see *Connections for relay play* on page 13.

2 Set the DJ mixer's cross fader to the center position.

3 Turn auto cue on for both DJ players.

The DJ players' auto cue indicators light.

4 Start playback on this unit.

The first track on this unit is played, and once it finished playback begins automatically on the other DJ player. This unit cues to the beginning of the next track and pauses. This operation is repeated for relay play between the two DJ players.

- The medium can be changed and the cue point set on the DJ player that is in standby.
- If the power of one DJ player is turned off during playback, playback may start on the other DJ player.
- The fader start function does not work during relay play.
- Relay play may not be possible if the two DJ players are not connected to the same DJ mixer.

Using the [BROWSE] button

Rearranging tracks (Sort menu)

When in the library browse mode, the tracks can be rearranged using the Sort menu. (The Sort menu is not displayed when in the folder browse mode.)

1 Press [MENU/UTILITY] while the tracks are displayed.

The Sort menu is displayed to the right of the information display screen.

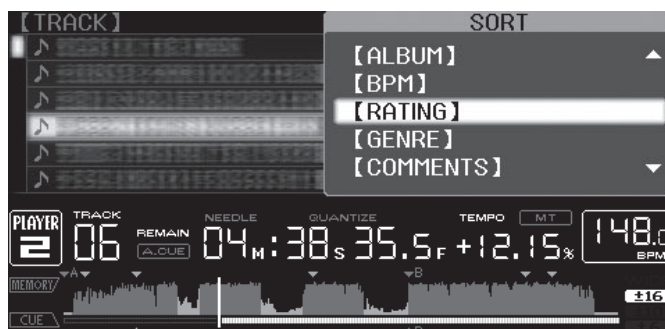

2 Select and enter the setting item.

The tracks are sorted according to the selected item. The track information is displayed.

- Sorting is canceled when [BACK] is pressed to return to the uppermost level.
- The types of sorting items on the Sort menu can be changed in the rekordbox preferences.

Searching for tracks (SEARCH)

- The search function can be used to search for tracks recorded on the media loaded in the set with [SEARCH].
- Tracks recorded on discs cannot be searched.
- Tracks recorded on media for which library browsing is not possible cannot be searched.

1 Select [SEARCH] and enter the setting item.

A character appears at the bottom of the main unit display.

2 Use the [NEEDLE SEARCH] pad to input a character.

Tracks including the character you have input are displayed.

- When more characters are input at this point, tracks starting with the character string you have input are displayed.
- When [BACK] is pressed, the category screen reappears.

Using the jump function

The jump function can be used to instantaneously move to the track, category or folder you want to play.

The jump function includes the two modes below.

- Letter jumping: Use this when the tracks are arranged or sorted in alphabetical order.
- Page jumping: Use this when the tracks are not arranged or sorted in alphabetical order. Turn the rotary selector to jump by page.

❖ In the letter jump mode

1 Press the rotary selector for at least 1 second.

The mode switches to the letter jump mode. The first letter of the selected track is enlarged.

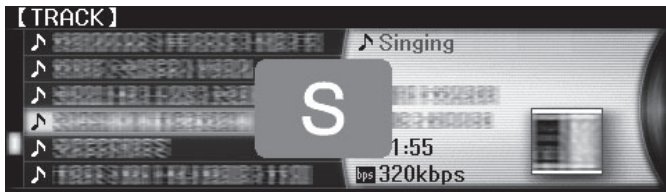

2 Select the character or symbol to which you want to jump and enter.

The display moves to the category starting with the selected character or symbol.

- The characters that can be displayed are letters A – Z, numbers 0 – 9 and symbols.

❖ In the page jump mode

1 Press the rotary selector for at least 1 second.

The mode switches to the page jump mode.

2 Select the page to which you want to jump and enter.

The display moves to the selected page.

Using hot cue banks

Hot cue banks set ahead of time in rekordbox can be registered at the CDJ-2000's [HOT CUE] buttons (A, B and C).

1 Load the medium on which the hot cue bank is registered in the CDJ-2000.

[HOT CUE BANK] appears in the category items.

2 Select [HOT CUE BANK] and enter the setting item.

The hot cue bank is displayed. The cursor is fixed to hot cue bank A. It cannot be moved using the rotary selector or other buttons.

3 Select the hot cue bank you want to call out and enter.

The hot cues registered in the hot cue bank are registered at the CDJ-2000's [HOT CUE] buttons (A, B or C). The indicators (A, B or C) light.

- When a new hot cue is registered at the CDJ-2000's [HOT CUE] buttons (A, B or C), all of the hot cue bank's point information is deleted.
- Hot cue banks cannot be deleted on the CDJ-2000.

Checking the playing history (HISTORY)

- The track playing history is recorded and displayed at [HISTORY].
- Playlists can be created based on the playing history at [HISTORY] using rekordbox. For details, see rekordbox's operating instructions.

1 Load an SD memory card/USB device in the CDJ-2000.

2 Playing tracks.

The currently playing track is recorded and displayed at [HISTORY].

- When a USB device, etc., is connected to the CDJ-2000 for the first time or reconnected, the new [HISTORY] is automatically created on the USB device.
- The name of [HISTORY] can be preset at [UTILITY] (page 22).
- If a track already recorded in [HISTORY] is played again after playing a different track, it is newly recorded in [HISTORY]. However, tracks played using

the [HOT CUE] buttons (A, B and C) are not recorded in the history (they are recorded when the hot cue is called out).

- The maximum number of tracks that can be recorded in [HISTORY] is 999. When a 1 000th track is recorded, the oldest item in the history is deleted.

❖ Deleting [HISTORY]

1 While [HISTORY] is selected, press [MENU/UTILITY].

The delete menu is displayed.

2 Select the range to be deleted and enter.

- [DELETE]: The [HISTORY] item selected with the cursor is deleted.
- [ALL DELETE]: The entire [HISTORY] is deleted.
- The [HISTORY] is deleted when [HISTORY] is converted into a playlist using rekordbox.

Using the [TAG LIST] button

Up to 100 tracks to be played next or selected according to the DJing situation can be collected and stored in the tag list.

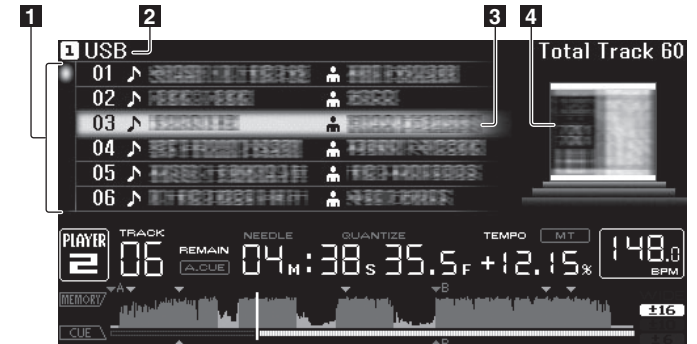

1 List of contents	The contents of the tag list are displayed here.
2 Medium name	The name of the medium on which the track is recorded is displayed here.
3 Cursor	Turn the rotary selector to move the cursor up and down.
4 Jacket photo	When artwork is registered in rekordbox or when the ID3 tag contains a JPEG image, the image for the track selected with the cursor is displayed.

Adding tracks to the tag list

Select the track, then press [TAG TRACK/REMOVE].

 is displayed to the left of the track.

- The number of tracks that can be added to the tag list is 100 per medium. If you attempt to add a 101st track, a warning message appears and the track cannot be added.
- Tracks can be recorded in the tag list ahead of time using rekordbox.
- When multiple DJ players are connected by PRO DJ LINK, the same tag list contents are displayed on all DJ players.
- When [TAG TRACK/REMOVE] is pressed while the information is displayed after pressing [INFO], the tracks loaded in this unit are added to the tag list.

❖ Adding categories or folders to the tag list

With the list of the tracks displayed on the right side of the information display screen, press [TAG TRACK/REMOVE].

The category name/folder name flashes, and the tracks in that category/folder are added to the tag list.

- When a category/folder including tracks already added to the tag list is selected and [TAG TRACK/REMOVE] is pressed, only the tracks not already on the tag list are added.
- When a folder is added while in the folder browse mode, the track names are registered as file names. The artist names are not registered.

❖ Adding playlists to the tag list

With the list of the tracks displayed on the right side of the information display screen, press [TAG TRACK/REMOVE].

The playlist name flashes, and the tracks in that playlist are added to the tag list.

- When a playlist including tracks that have already been added to the tag list is selected and [TAG TRACK/REMOVE] is pressed, only the tracks that were not previously added to the tag list are added.
- Playlists can also be added by pressing [TAG TRACK/REMOVE] while artwork is displayed on the information display screen.

Loading tracks from the tag list

1 Press [TAG LIST].

The tag list is displayed.

2 Select the track to be loaded and enter.

The track is loaded and playback starts.

Removing tracks from the tag list

1 Press [TAG LIST].

The tag list is displayed.

2 Select the track to be removed from the tag list, then press [TAG TRACK/REMOVE] for at least 1 second.

The track is removed from the tag list.

- If a track that has been added to the tag list is removed from the tag list while it is playing, the track is played to the end, then the stop mode is set. The next track is not played.
- When a medium is removed from the CDJ-2000, all the tracks recorded on that medium are removed from the tag list.

Transforming the tag list into a playlist

1 Press [TAG LIST].

The tag list is displayed.

2 Press [MENU/UTILITY].

[LIST MENU] is displayed.

3 Select [TAGLIST MENU] and enter.

[TAGLIST MENU] is displayed.

4 Select [CREATE PLAYLIST] and enter.

[CREATE PLAYLIST] is displayed.

5 Press [OK].

The contents of the tag list are converted into a playlist with the name [TAG LIST XXX].

- Only tracks being managed by rekordbox are converted into playlists.
- If no library information is recorded on the medium, the tag list cannot be converted into a playlist.

Using the [INFO] button

The details of the tracks loaded in the CDJ-2000 can be checked by pressing [INFO]. When DJ players are connected by PRO DJ LINK, the details of the tracks loaded in the other DJ players can also be checked.

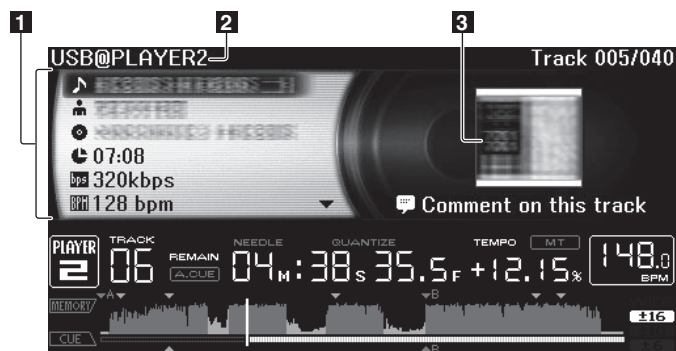

1 Track details	The details of the tracks loaded in the DJ player are displayed here.
2 Medium/player number	The place where the track information is stored is displayed here.
3 Jacket photo and comment	The jacket photo and comment about the track loaded in the DJ player are displayed here.

Checking the details of loaded tracks

While the track is playing, press [INFO].

The track's details are displayed.

Displaying details of tracks loaded in other DJ players

1 Connect this unit and the other DJ players by PRO DJ LINK.

2 Press [INFO], then press [MENU/UTILITY].

The [Link Info] screen appears.

3 Select the DJ player and enter.

The details of the tracks loaded in the selected DJ player are displayed.

- If no tracks are loaded in the selected DJ player, no details are displayed.

Using the information jump function

This function can be used to select items displayed in the details and move them to the category, etc., in which a track is included.

1 Display the track details.

2 Select and enter the setting item.

The library browse mode for the selected item is set.

- It may not be possible to select some items.
- When a track is selected, it is moved to the category in which the track was loaded.
- It is not possible to move items from the disc's details to tracks loaded in a DJ player connected by PRO DJ LINK.
- When an item for which only an icon is displayed is selected, that icon is moved to the corresponding category.

Changing the settings

Using the [MENU/UTILITY] button

Various settings on the CDJ-2000 can be changed by pressing [MENU/UTILITY].

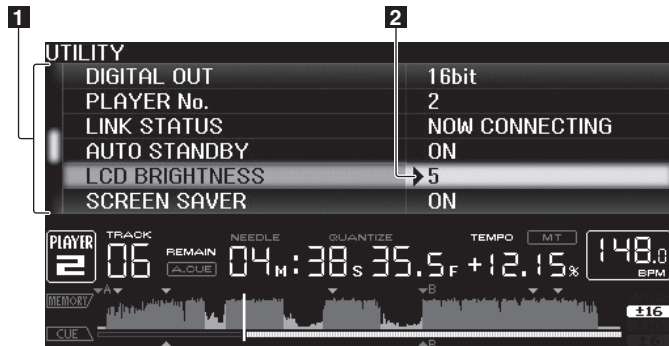

- | | | |
|---|--------------|--|
| 1 | Setting item | The CDJ-2000's settings items are displayed here. |
| 2 | Setting | The settings for the various items are displayed here. |

Changing the settings

1 Press [MENU/UTILITY] for over 1 second.

The [UTILITY] screen is displayed.

2 Select and enter the setting item.

The cursor moves to the setting.

3 Change the setting and enter.

The cursor returns to the setting.

- Press [BACK] before changing the setting to return to step 2.

4 Press [MENU/UTILITY].

Press [MENU/UTILITY] to return to the menu screen.

List of settings

The factory default settings are indicated in **bold**.

Options settings	Setting ranges	Descriptions
QUANTIZE	ON/OFF	For details, see QUANTIZE on page 11. Sets the method of connection of this unit and other brands of DJ software.
HID SETTING	STANDARD/ADVANCED	For information on compatibility with other brands of DJ software, see the website below. http://www.prodjnet.com/support/
AUTO CUE LEVEL	-36dB/-42dB/-48dB/-54dB/ -60dB /-66dB/-72dB/-78dB	For details, see <i>Changing the auto cue level</i> on page 16.
MIDI CHANNEL	1 – 16	–
LANGUAGE	–	The language used for the CDJ-2000's display can be selected here.
ART WORK (TAG LIST)	ON/OFF	When set to [ON], jacket photos are displayed on the tag list. When set to [OFF], jacket photos are not displayed.
TRACK INFORMATION	Track Info/ Track Info+Comments	Selects the method for displaying music file information.
PLAYLIST VIEW	LIST/ Track Info	Selects the method for displaying play-lists.
LIBRARY CREATOR	LIBRARY /FOLDER	This can only be selected when a medium on which a Pioneer MEP-7000 library is recorded is loaded.
HISTORY NAME	–	For details, refer to <i>Setting [HISTORY NAME]</i> on the right. Selects the method of display when connected by PRO DJ LINK to an ON AIR DISPLAY compatible mixer. Also refer to the operating instructions of the ON AIR DISPLAY compatible mixer (DJM-2000, etc.).
ON AIR DISPLAY	ON/OFF	–
JOG BRIGHTNESS	OFF/1/2	Selects the brightness of the JOG RING ILLUMINATION.
JOG INDICATOR	ON/OFF	Selects whether the JOG RING ILLUMINATION flashes or not when the track's remaining time is low.

Options settings	Setting ranges	Descriptions
DIGITAL OUT	16 bit/24 bit	This switches the number of bits of the audio signals output from the [DIGITAL OUT] terminal.
PLAYER No.	AUTO , 1 – 4	Sets this unit's player number. The player number cannot be changed when a medium is loaded in this unit.
LINK STATUS	–	When PRO DJ LINK connections are made, the connection status is displayed here.
AUTO STANDBY	ON/OFF	For details, see <i>Setting the auto standby mode</i> below.
LCD BRIGHTNESS	1 – 3 – 5	Sets the main unit display's brightness. When set to [ON], the screensaver starts up in the following cases: <ul style="list-style-type: none"> When no track is loaded in the CDJ-2000 for over 5 minutes When no operation is performed for over 100 minutes while in the pause or cue standby mode or when [END] is displayed on the main unit display.
SCREEN SAVER	ON/OFF	–
DUPLICATION	–	For details, see <i>Duplicating the settings onto another DJ player</i> below.
VERSION No.	–	Displays the CDJ-2000's software version.

Setting the auto standby mode

1 Select [AUTO STANDBY] and enter the setting item.

2 Select [ON] or [OFF] and enter.

When [AUTO STANDBY] is set to [ON], the power management function is activated in the following cases and the standby mode is set.

- When no operation at all is performed for over 4 hours with no disc, SD memory card or USB device loaded, no PRO DJ LINK connection and no computer connected to the USB port (on the main unit's rear panel).
- When the CDJ-2000 is operated, the standby mode is canceled.
- The CDJ-2000 is shipped with the power management function turned on. If you do not want to use the power management function, set [AUTO STANDBY] to [OFF].

Setting [HISTORY NAME]

The name of the [HISTORY] recorded on the SD memory card/USB device can be preset.

1 Select [HISTORY NAME] and enter the setting item.

2 Use the [NEEDLE SEARCH] pad to input a character.

3 Press the rotary selector to enter.

The [HISTORY NAME] setting is changed.

- If [HISTORY NAME] is not set, numbers are added sequentially after [HISTORY].
- The maximum number of characters that can be set for the [HISTORY] name is 32, including both letters, numbers and symbols.

Changing the language

1 Select [LANGUAGE] and enter the setting item.

2 Select the language and enter.

The language of the on-screen display is changed.

- To display characters written in a local code other than Unicode, change the [LANGUAGE] setting.

Duplicating the settings onto another DJ player

The [UTILITY] and other settings can be duplicated onto another DJ player.

1 Select [DUPLICATION] and enter.

2 Select [DEFAULT (PLAYER X)] or [PLAYER X] and enter.

— [DEFAULT (PLAYER X)]: The [UTILITY] settings are changed into the settings set upon purchase.

— [PLAYER X]: [DUPLICATED] is displayed on the specified player's display and this unit's [UTILITY] settings are duplicated onto the specified player.

- Players that are currently playing cannot be specified.
- The duplicated settings are as shown below.
 - [UTILITY] settings
QUANTIZE, AUTO CUE LEVEL, LANGUAGE, ART WORK (TAG LIST), TRACK INFORMATION, PLAYLIST VIEW, ON AIR DISPLAY, JOG BRIGHTNESS, JOG INDICATOR, LCD BRIGHTNESS
 - Other settings
TIME MODE, AUTO CUE, JOG MODE, TEMPO RANGE, MASTER TEMPO
- Some items are not duplicated.

About the rekordbox software

rekordbox is an application for managing music files which are used for DJ play with a Pioneer DJ Player (i.e. CDJ-2000, CDJ-900).

- rekordbox can be used to classify and search for music files stored on your computer and create playlists used for DJ performance.
- rekordbox allows you to detect, measure and adjust the beats, tempos (BPM) and other elements of your music files prior to performance.
- rekordbox can be used to set and store point information (for Cue, Loop, Hot Cue, etc.) prior to performance.

Not only can various types of point information and playlists prepared with rekordbox be used for playback on Pioneer DJ players, the playback history, number of times played, point information, etc., can also be fed back to rekordbox after playback.

Software end user license agreement

This Software End User License Agreement ("Agreement") is between you (both the individual installing the Program and any single legal entity for which the individual is acting) ("You" or "Your") and PIONEER CORPORATION ("Pioneer"). TAKING ANY STEP TO SET UP OR INSTALL THE PROGRAM MEANS THAT YOU ACCEPT ALL OF THE TERMS OF THIS LICENSE AGREEMENT. PERMISSION TO DOWNLOAD AND/OR USE THE PROGRAM IS EXPRESSLY CONDITIONED ON YOUR FOLLOWING THESE TERMS. WRITTEN OR ELECTRONIC APPROVAL IS NOT REQUIRED TO MAKE THIS AGREEMENT VALID AND ENFORCEABLE. IF YOU DO NOT AGREE TO ALL OF THE TERMS OF THIS AGREEMENT, YOU ARE NOT AUTHORIZED TO USE THE PROGRAM AND MUST STOP INSTALLING IT OR UNINSTALL IT, AS APPLICABLE.

1 Definitions

- 1 "Documentation" means written documentation, specifications and help content made generally available by Pioneer to aid in installing and using the Program.
- 2 "Program" means all or any part of Pioneer's software licensed to You by Pioneer under this Agreement.

2 Program license

- 1 Limited License. Subject to this Agreement's restrictions, Pioneer grants to You a limited, non-exclusive, nontransferable, license (without the right to sublicense):
 - a To install a single copy of the Program on the hard disk drive of Your computer, to use the Program only for Your personal purpose complying with this Agreement and the Documentation ("Authorized Use");
 - b To use the Documentation in support of Your Authorized Use; and
 - c To make one copy of the Program solely for backup purposes, provided that all titles and trademark, copyright and restricted rights notices are reproduced on the copy.
- 2 Restrictions. You will not copy or use the Program or Documentation except as expressly permitted by this Agreement. You will not transfer, sublicense, rent, lease or lend the Program, or use it for third-party training, commercial time-sharing or service bureau use. You will not Yourself or through any third party modify, reverse engineer, disassemble or decompile the Program, except to the extent expressly permitted by applicable law, and then only after You have notified Pioneer in writing of Your intended activities. You will not use the Program on multiple processors without Pioneer's prior written consent.
- 3 Ownership. Pioneer or its licensor retains all right, title and interest in and to all patent, copyright, trademark, trade secret and other intellectual property rights in the Program and Documentation, and any derivative works thereof. You do not acquire any other rights, express or implied, beyond the limited license set forth in this Agreement.
- 4 No Support. Pioneer has no obligation to provide support, maintenance, upgrades, modifications or new releases for the Program or Documentation under this Agreement.

3 Warranty disclaimer

THE PROGRAM AND DOCUMENTATION ARE PROVIDED "AS IS" WITHOUT ANY REPRESENTATIONS OR WARRANTIES, AND YOU AGREE TO USE THEM AT YOUR SOLE RISK. TO THE FULLEST EXTENT PERMISSIBLE BY LAW, PIONEER EXPRESSLY DISCLAIMS ALL WARRANTIES OF ANY KIND WITH RESPECT TO THE PROGRAM AND DOCUMENTATION, WHETHER EXPRESS, IMPLIED, STATUTORY, OR ARISING OUT OF COURSE OF PERFORMANCE, COURSE OF DEALING OR USAGE OF TRADE, INCLUDING ANY WARRANTIES OF MERCHANTABILITY, FITNESS FOR A PARTICULAR PURPOSE, SATISFACTORY QUALITY, ACCURACY, TITLE OR NON-INFRINGEMENT.

4 Damages and remedies for breach

You agree that any breach of this Agreement's restrictions would cause Pioneer irreparable harm for which money damages alone would be inadequate. In addition to damages and any other remedies to which Pioneer may be entitled, You agree that Pioneer may seek injunctive relief to prevent the actual, threatened or continued breach of this Agreement.

5 Termination

Pioneer may terminate this Agreement at any time upon Your breach of any provision. If this Agreement is terminated, You will stop using the Program,

permanently delete it from the computer where it resides, and destroy all copies of the Program and Documentation in Your possession, confirming to Pioneer in writing that You have done so. Sections 2.2, 2.3, 2.4, 3, 4, 5 and 6 will continue in effect after this Agreement's termination.

6 General terms

- 1 Limitation of Liability. In no event will Pioneer or its subsidiaries be liable in connection with this Agreement or its subject matter, under any theory of liability, for any indirect, incidental, special, consequential or punitive damages, or damages for lost profits, revenue, business, savings, data, use, or cost of substitute procurement, even if advised of the possibility of such damages or if such damages are foreseeable. In no event will Pioneer's liability for all damages exceed the amounts actually paid by You to Pioneer or its subsidiaries for the Program. The parties acknowledge that the liability limits and risk allocation in this Agreement are reflected in the Program price and are essential elements of the bargain between the parties, without which Pioneer would not have provided the Program or entered into this Agreement.
- 2 The limitations or exclusions of warranties and liability contained in this Agreement do not affect or prejudice Your statutory rights as consumer and shall apply to You only to the extent such limitations or exclusions are permitted under the laws of the jurisdiction where You are located.
- 3 Severability and Waiver. If any provision of this Agreement is held to be illegal, invalid or otherwise unenforceable, that provision will be enforced to the extent possible or, if incapable of enforcement, deemed to be severed and deleted from this Agreement, and the remainder will continue in full force and effect. The waiver by either party of any default or breach of this Agreement will not waive any other or subsequent default or breach.
- 4 No Assignment. You may not assign, sell, transfer, delegate or otherwise dispose of this Agreement or any rights or obligations under it, whether voluntarily or involuntarily, by operation of law or otherwise, without Pioneer's prior written consent. Any purported assignment, transfer or delegation by You will be null and void. Subject to the foregoing, this Agreement will be binding upon and will inure to the benefit of the parties and their respective successors and assigns.
- 5 Entire Agreement. This Agreement constitutes the entire agreement between the parties and supersedes all prior or contemporaneous agreements or representations, whether written or oral, concerning its subject matter. This Agreement may not be modified or amended without Pioneer's prior and express written consent, and no other act, document, usage or custom will be deemed to amend or modify this Agreement.
- 6 You agree that this Agreement shall be governed and construed by and under the laws of Japan.

Cautions on copyrights

rekordbox restricts playback and duplication of copyright-protected music contents.

- When coded data, etc., for protecting the copyright is embedded in the music contents, it may not be possible to operate the program normally.
- When rekordbox detects that coded data, etc., for protecting the copyright is embedded in the music contents, processing (playback, reading, etc.) may stop.

Recordings you have made are for your personal enjoyment and according to copyright laws may not be used without the consent of the copyright holder.

- Music recorded from CDs, etc., is protected by the copyright laws of individual countries and by international treaties. It is the full responsibility of the person who has recorded the music to ensure that it is used legally.
- When handling music downloaded from the Internet, etc., it is the full responsibility of the person who has downloaded the music to ensure that it is used in accordance with the contract concluded with the download site.

Cautions on Installation

Read the “*Software end user license agreement*” carefully before installing rekordbox.

❖ Supported operating systems

rekordbox is supported by the following operating systems:

- Mac OS X (10.4.6 and later)
 - Windows® 7 Home Premium/Professional/Ultimate
 - Windows Vista® Home Basic/Home Premium/Business/Ultimate (SP1 or later)
 - Windows® XP Home Edition/Professional (SP3 or later)
- * rekordbox is not supported on Windows® XP Professional x64 edition.

❖ Supported languages

The included CD-ROM contains installation programs and operating instructions in the following 12 languages:

- English, French, German, Italian, Dutch, Spanish, Portuguese, Russian, Chinese (simplified characters), Chinese (traditional characters), Korean, Japanese.
- * When using an operating system in any language besides the ones listed above, select [English] during the installation procedure.

❖ System requirements (minimum operating environment)

Check that the computer provides the operating environment described below before starting installation.

CPU	For Mac OS X	Macintosh computer equipped with a 1.83 GHz or greater Intel® Core™ Duo (or compatible) processor
	For Windows® 7, Windows Vista® and Windows® XP	PC/AT compatible computer equipped with a 2 GHz or greater Intel® Pentium® 4 (or compatible) processor
Required memory	1 GB or more of RAM	
Hard disk	250 MB or more of free space (not including space for storing music files, etc.)	
CD drive	Optical disc drive on which the CD-ROM can be read	
Sound	Audio output to speakers, headphones, etc. (internal or external audio device)	
Internet connection	For user registration and inquiries, use a web browser supporting 128-bit SSL (Safari 2.0 or greater, Internet Explorer® 6.0 or greater, etc.).	
USB port	A USB port for connection of a USB device (flash memory, hard disc, etc.) is required to transfer music files to the USB device.	
LAN port	An Ethernet LAN adapter (RJ45 port) for communicating with the DJ player is required to transfer music files to a Pioneer DJ player (i.e. CDJ-2000, CDJ-900).	

- Full functionality is not guaranteed on all computers, even those meeting the operating environment requirements described above.
- Even with the required memory capacity indicated for the operating environment above, in the cases described below the software may not provide full functionality and performance due to lack of memory. In this case, take the necessary measures to ensure sufficient free memory. We recommend adding extra memory in order to achieve stable performance.
 - When there are many tracks being managed in the rekordbox library
 - When resident programs and services are running
- Depending on the computer's power settings and other factors, the CPU and hard disk processing capacity may be insufficient. When using laptop computers in particular, always keep the AC power connected and adjust the computer's settings to maximize performance when using rekordbox.
- Note that problems may arise with the functionality of rekordbox depending on other software running on your computer.

Installing rekordbox

Read the "Cautions on Installation" carefully before installing rekordbox.

❖ Installation Procedure (Macintosh)

- Authorization of the computer's administrator is required to install and uninstall rekordbox. Have the name and password of the computer's administrator ready.

1 When the included CD-ROM is inserted into the computer's CD drive, the CD drive opens on the screen. Double-click the [CD_menu.app] icon.

- If the CD drive does not open on the screen when the CD-ROM is inserted, use Finder to open the CD drive, then double-click the [CD_menu.app] icon.

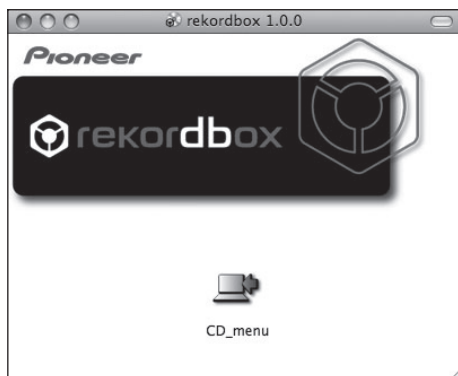

2 When the CD-ROM's menu is displayed, select [rekordbox: Install Music Management Software], then click [Start].

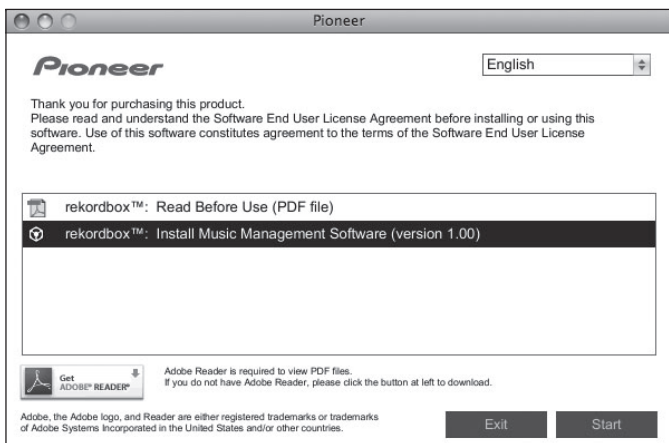

To close the CD-ROM menu, click [Exit].

3 Install rekordbox following the instructions on the screen.

Once installation of rekordbox is completed, the operating instructions can be opened from rekordbox's [Help] menu.

❖ Installation Procedure (Windows)

- Authorization of the computer's administrator is required to install and uninstall rekordbox. Log on as the user registered as the computer's administrator before installing rekordbox.

1 Insert the included CD-ROM into the computer's CD drive.

The CD-ROM menu is displayed.

- If the CD-ROM menu does not appear when the CD-ROM is inserted, open the CD drive from [Computer (or My Computer)] in the [Start] menu, then double-click the [CD_menu.exe] icon.

2 When the CD-ROM's menu is displayed, select [rekordbox: Install Music Management Software], then click [Start].

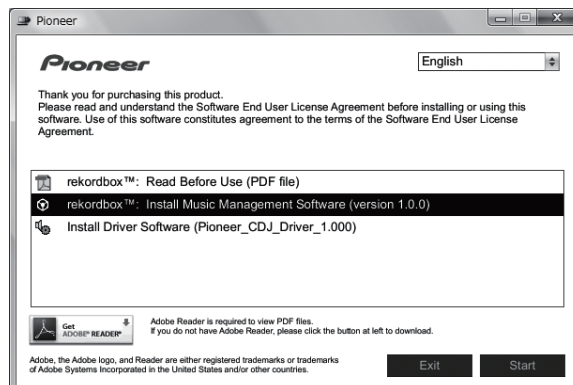

To close the CD-ROM menu, click [Exit].

3 Install rekordbox following the instructions on the screen.

Once installation of rekordbox is completed, the operating instructions can be opened from rekordbox's [Help] menu.

- To stop installation in progress, click [Cancel].

Using the support site

Before making an inquiry about rekordbox operations and technical support, refer to the operating instructions for rekordbox and check the FAQs published on the support site for rekordbox.

<Support Site for rekordbox>

<http://www.prodjnet.com/rekordbox/support/>

- To make an inquiry about rekordbox, you need to register as a user in advance on the support site for rekordbox.
- You need to enter the license key for your user registration. Have the license key ready. Also, be sure not to forget the login name (your e-mail address) and the password specified for your user registration, as well as the license key.
- Pioneer Corporation collects your personal information for the following purposes:
 - 1 To provide customer support for your purchased product
 - 2 To inform you of product or event information by e-mail
 - 3 To reflect your opinions collected by survey on product planning— Your personal information is kept confidential corresponding to the privacy policy set forth by our company.
— You can check our privacy policy on the support site for rekordbox.
- When you make an inquiry about rekordbox, be sure to provide us the information on the model name, specifications (CPU and memory capacity and peripheral devices connected), and operating system version of your computer, as well as specific descriptions of system malfunction.
— For an inquiry about configuring your computer with peripheral devices other than our products and the corresponding technical support, contact each manufacturer or retailer.
- rekordbox is subject to upgrade for enhanced function and performance. The upgrade program can be downloaded on the support site. We strongly recommend you upgrade your software on a regular basis to keep the latest updates on your system.

About the driver software

This driver software is an exclusive ASIO driver for outputting audio signals from the computer. To use the CDJ-2000 connected to a computer on which Windows is installed, install the driver software on the computer beforehand.

When using a computer on which a MAC operating system is installed, use the operating system's standard driver software.

Software end user license agreement

Carefully read the provisions of the Software end user license agreement (page 23) before installing or using the driver software. Using the driver software implies that you have consented to the Software end user license agreement.

Cautions on Installation

- Before installing the driver software, be sure to turn off the power of this unit and disconnect the USB cable from both this unit and your computer.
- If you connect this unit to your computer without installing the driver software first, an error may occur on your computer depending on the system environment.
- If you have discontinued the installation process in progress, step through the installation process again from the beginning according to the following procedure.
- Carefully read the provisions of the Software end user license agreement before installing the driver software for exclusive use with this unit.
- Before installing the driver software, terminate all other programs running on your computer.
- The driver software is compatible with the following OSs.
 - Windows® 7 Home Premium/Professional/Ultimate
 - Windows Vista® Home Basic/Home Premium/Business/Ultimate (SP1 or later)
 - Windows® XP Home Edition/Professional (SP3 or later)When using a 64-bit version of Windows® 7 or Windows Vista®, only 32-bit applications can be used. Windows® XP Professional x64 Edition is not supported.
- The included CD-ROM includes installation programs in the following 12 languages. English, French, German, Italian, Dutch, Spanish, Portuguese, Russian, Simplified Chinese, Traditional Chinese, Korean, and Japanese. If the language of your OS is one other than the ones listed above, select **[English]** following the instructions on the screen.

Installing the driver software

- Carefully read "Cautions on Installation" before installing the driver software.
- To install or uninstall the driver software, you need to be authorized by the administrator of your computer. Log on as the administrator of your computer before proceeding with the installation.

1 Insert the included CD-ROM into the computer's CD drive.

The CD-ROM menu is displayed.

- If the CD-ROM menu does not appear when the CD-ROM is inserted, open the CD drive from **[Computer]** (or **[My Computer]**) in the **[Start]** menu, then double-click the **[CD_menu.exe]** icon.

2 When the CD-ROM's menu is displayed, select **[Install Driver Software]**, then click **[Start]**.

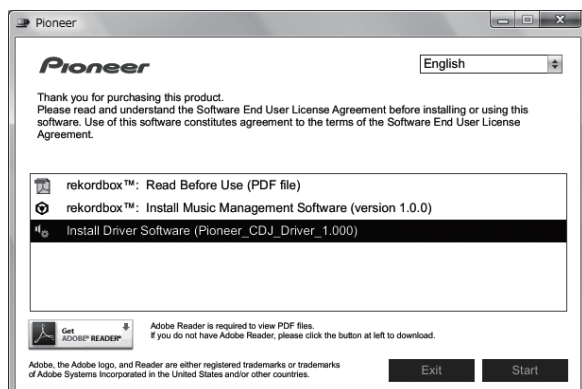

To close the CD-ROM menu, click **[Exit]**.

3 Proceed with installation according to the instructions on the screen.

If **[Windows Security]** appears on the screen while the installation is in progress, click **[Install this driver software anyway]** and continue with the installation.

- When installing on Windows XP

If **[Hardware Installation]** appears on the screen while the installation is in progress, click **[Continue Anyway]** and continue with the installation.

- When the installation program is completed, a completion message appears.

Connecting the CDJ-2000 and computer

1 Connect this unit to your computer via a USB cable.

2 Press **[POWER]**.

Turn on the power of this unit.

- The message **[Installing device driver software]** may appear when the CDJ-2000 is connected to the computer for the first time or when it is reconnected to the computer's USB port. Wait until the **[Your devices are ready for use]** message appears.
- When installing on Windows XP
 - **[Can Windows connect to Windows Update to search for software?]** may appear while the installation is in progress. Select **[No, not this time]** and click **[Next]** to continue with the installation.
 - **[What do you want the wizard to do?]** may appear while the installation is in progress. Select **[Install the software automatically (Recommended)]** and click **[Next]** to continue with the installation.
 - If **[Hardware Installation]** appears on the screen while the installation is in progress, click **[Continue Anyway]** and continue with the installation.

Adjusting the buffer size (Windows)

This unit functions as an audio device conforming to the ASIO standards.

- If an application using this unit as the default audio device (DJ software, etc.) is running, quit that application before adjusting the buffer size.

Click **Windows [Start] menu >[All Programs]>[Pioneer]>[Pioneer CDJ]>[Pioneer CDJ ASIO Settings Utility]**.

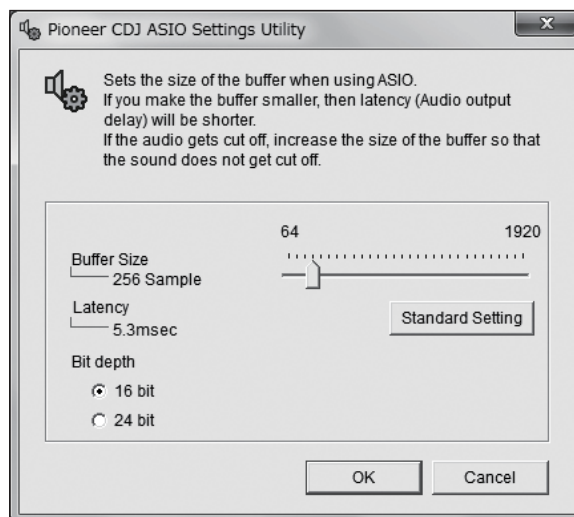

- A sufficiently large buffer size decreases the chance of sound dropout (sound interruption) but increases audio signal transmission delay (latency).
- For the bit number, specify the bit depth during ASIO playback.
- To specify "24 bit" for the bit number, the firmware must be updated to version 3 or later.

Checking the version of the driver software

Click Windows [Start] menu >[All Programs]>[Pioneer]>[Pioneer CDJ]>[Pioneer CDJ Version Display Utility].

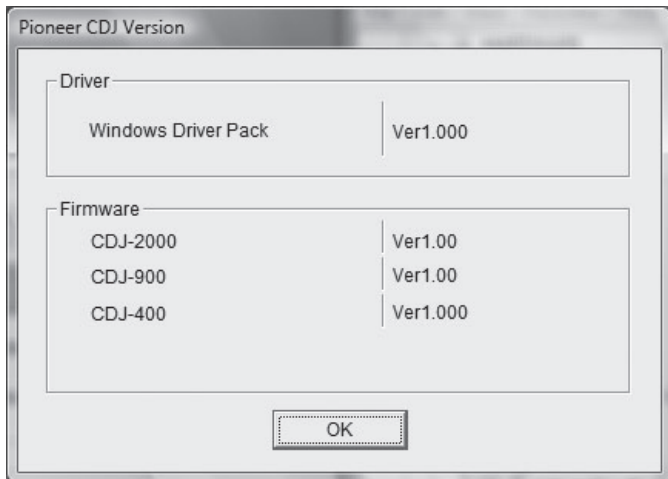

- You can check the firmware version of this unit on the screen.
- The firmware version is not displayed when the CDJ-2000 is not connected to the computer or when the CDJ-2000 and computer are not properly communicating.

Checking the latest information on the driver software

For the latest information on the driver software for exclusive use with this unit, visit our website shown below.
<http://www.prodjnet.com/support/>

Using other brands of DJ software

Operating DJ software by MIDI interface

The CDJ-2000 also outputs the operating data for the buttons and dials in MIDI format. If you connect a computer with a built-in MIDI-compatible DJ software via a USB cable, you can operate the DJ software on this unit. The sound of music files being played on the computer can also be output from the CDJ-2000. Before using the CDJ-2000 as an audio device, install the driver software on the computer (page 26). Also, the CDJ-2000 must be selected in the DJ software's settings. For details, see your DJ software's operating instructions.

1 Connect the USB port on this unit to your computer.

For instructions on connecting, see *Using other brands of DJ software* on page 13.

2 Press [BROWSE], then press [LINK].

[Control Mode] and [USB-MIDI] appear on the menu screen.

3 Select [Control Mode] and enter.

The connecting screen is displayed.

4 Select [USB-MIDI] and enter.

The CDJ-2000 switches to the control mode.

5 Start the DJ software.

Communication with the DJ software starts.

- The DJ software on the computer can be operated using the buttons and rotary selector on the CDJ-2000.
- It may not be possible to use some buttons to operate the DJ software.
- The control mode is canceled when a track is loaded in the CDJ-2000.
- For messages output by the CDJ-2000, see *List of MIDI Messages*.

❖ Changing the MIDI channel setting

1 Press [MENU/UTILITY] for over 1 second.

The utility screen appears.

2 Select [MIDI CHANNEL] and enter.

3 Turn the rotary selector.

Select the MIDI channel and change the setting. A setting from 1 – 16 can be selected.

4 Press the rotary selector to enter.

5 Press [MENU/UTILITY].

The previous screen reappears.

❖ List of MIDI Messages

SW Name	SW Type	MIDI Messages		Notes
		MSB	LSB	
JOG (TOUCH)	—	Bn	10 dd	A linear value corresponding to the speed, from stop to 4X: 64 for stop, 65 (0.06X) – 127 (4X) in the forward direction, 63 (0.06X) – 0 (4X) in the reverse direction.
TEMPO SLIDER	VR	Bn	1D dd	0 – 127, 0 on the – side, 127 on the + side
TOUCH/BRAKE	VR	Bn	1E dd	0 – 127, 0 (min.) on the left side, 127 (max.) on the right side
RELEASE/START	VR	Bn	1F dd	0 – 127, 0 (min.) on the left side, 127 (max.) on the right side
JOG RING	—	Bn	30 dd	A linear value corresponding to the speed from 0.5X to 4X: 64 when stopped (under 0.49X), 65 (0.5X) to 127 (4X) in the forward direction, 63 (0.5X) to 0 (4X) in the reverse direction.
ENCODER	General Purpose Controller	Bn	4F dd	98 – 127, 1 – 30 Difference of count from previous time is sent ($\pm 1 - \pm 30$) When over ± 30 , set at ± 30
PLAY/PAUSE	SW	9n	00 dd	OFF=0, ON=127
CUE	SW	9n	01 dd	OFF=0, ON=127
SEARCH FWD	SW	9n	02 dd	OFF=0, ON=127
SEARCH REV	SW	9n	03 dd	OFF=0, ON=127
TRACK SEARCH NEXT	SW	9n	04 dd	OFF=0, ON=127
TRACK SEARCH REV	SW	9n	05 dd	OFF=0, ON=127
LOOP IN	SW	9n	06 dd	OFF=0, ON=127
LOOP OUT	SW	9n	07 dd	OFF=0, ON=127
RELOOP	SW	9n	08 dd	OFF=0, ON=127
MEMORY	SW	9n	0A dd	OFF=0, ON=127
CALL NEXT	SW	9n	0B dd	OFF=0, ON=127
CALL PREV	SW	9n	0C dd	OFF=0, ON=127
DELETE	SW	9n	0D dd	OFF=0, ON=127
TIME/A.CUE	SW	9n	0E dd	OFF=0, ON=127
TEMPO RANGE	SW	9n	10 dd	OFF=0, ON=127
MASTER TEMPO	SW	9n	11 dd	OFF=0, ON=127
JOG MODE	SW	9n	12 dd	OFF=0, ON=127
HOT CUE A	SW	9n	18 dd	OFF=0, ON=127
HOT CUE B	SW	9n	19 dd	OFF=0, ON=127
HOT CUE C	SW	9n	1A dd	OFF=0, ON=127
HOT CUE REC/ CALL	SW	9n	1C dd	OFF=0, ON=127
TEMPO RESET	SW	9n	1D dd	OFF=0, ON=127
JOG TOUCH	SW	9n	20 dd	OFF=0, ON=127
REVERSE	SW	9n	21 dd	OFF=0, ON=127
4 BEAT LOOP	—	9n	2A dd	OFF=0, ON=127
EJECT	SW	9n	2F dd	OFF=0, ON=127
TAG TRACK	SW	9n	30 dd	OFF=0, ON=127
BACK	SW	9n	32 dd	OFF=0, ON=127
ENCODER PUSH	SW	9n	33 dd	OFF=0, ON=127
NEEDLE	Touch Sensor	Bn	1C dd	OFF = 0 1 to 127 position data from left to right side

n is the channel number.

Additional information

Troubleshooting

- Incorrect operation is often mistaken for trouble or malfunction. If you think that there is something wrong with this component, check the points below. Sometimes the trouble may lie in another component. Inspect the other components and electrical appliances being used. If the trouble cannot be rectified after checking the items below, ask your nearest Pioneer authorized service center or your dealer to carry out repair work.
- The CDJ-2000 may not operate properly due to such external causes as static electricity. If this happens, normal operation can sometimes be restored by turning the power off, waiting for the disc to stop completely, then turning the power back on.
- Non-finalized (partial discs) CD-R/-RW, DVD-R/-RW, DVD+R/+RW and DVD±R dual layer discs cannot be played on the CDJ-2000.
- Irregularly shaped discs other than standard 12 cm discs cannot be played on the CDJ-2000 (doing so will lead to damage or accidents).
- The BPM measured by the CDJ-2000 may differ from the BPM indicated on the disc or that of a Pioneer DJ mixer, etc. This is due to the different methods used for measuring the BPM, and is not a malfunction.

Problem	Check	Remedy
Disc cannot be ejected.	Is [UNLOCK/LOCK] set to [LOCK]?	Press [PLAY/PAUSE▶/II] to set the pause mode, then press [DISC EJECT▲].
	—	Set [UNLOCK/LOCK] to [UNLOCK], then press [DISC EJECT▲]. If the [DISC EJECT▲] button does not work, insert the pin in the disc force eject pin insertion hole to eject the disc.
Playback does not start when disc is loaded.	Is the disc or file playable?	See <i>Discs/files playable on the CDJ-2000</i> on page 7.
	Is the auto cue function activated?	Press [AUTO CUE] for at least 1 second to turn cancel the auto cue function.
File cannot be played.	Is the file copyright-protected (by DRM)?	Copyright-protected files cannot be played.
No sound is produced, or sound is distorted or noisy.	Are you operating the connected DJ mixer properly?	Check the operation of the DJ mixer.
	Is the CDJ-2000 placed near a TV?	Turn the TV's power off, or install the CDJ-2000 and TV away from one another.
Loud noise is produced or playback stops when a certain disc is played.	Is the disc scratched?	Scratched discs may not play.
	Is the disc dirty?	Wipe the dirt off the disc (page 30).
File information is not properly displayed.	Is [LANGUAGE] properly set?	Set [LANGUAGE] to the proper language.
Track search operation takes too long.	Is the information recorded in a language not supported by the CDJ-2000?	When creating files using DJ software, etc., record the information in a language supported by the CDJ-2000.
	Is the auto cue function activated?	Track searching may take some time when there are long silent sections between tracks. If track searching is not possible within 10 seconds, a cue point is set at the beginning of the track.
Back cue function does not work.	Is a cue point set?	Set the cue point (page 16).
Loop play function does not work.	Is a cue point set?	Set the cue point (page 16).
Settings are not stored in the memory.	Has the power been turned off directly after changing the setting?	After changing settings, wait at least 10 seconds before turning the power off.
USB device is not recognized.	Is the USB device properly connected?	Connect the device securely (all the way in).
	Is the USB device connected via a USB hub?	USB hubs cannot be used.
	Is the USB device supported by the CDJ-2000?	This player only supports USB mass storage class devices. This player supports portable flash memory and digital audio playback devices.
	Is the file format supported by the CDJ-2000?	Check the file format of the connected USB device. For the file formats supported by the CDJ-2000, see <i>About USB devices</i> on page 8.
—	—	Turn the power off then back on.
Cue points or loops of tracks recorded on SD memory cards/USB devices are not stored in the memory.	Is there sufficient free space on the SD memory card/USB device?	A maximum of 100 cue and loop points per disc can be recorded on SD memory cards/USB devices (10 per track for media other than discs). If you attempt to record more points than the limit, [POINT FULL] is displayed and the points cannot be recorded.
		If the SD memory card is write-protected, [CARD PROTECTED] is displayed and the points cannot be recorded.
		If there is not enough free space on the USB device or if the device is write-protected, [USB FULL] is displayed and the points cannot be recorded.
Cue points or loops of tracks recorded on SD memory cards/USB devices are not displayed.	Has the SD memory card/USB device been properly removed?	Points may not be displayed if the SD memory card/USB device is removed without performing the proper stopping procedure or if the CDJ-2000's power is turned off.
The playing address display is not displayed in the remaining time mode.	—	When playing files recorded in VBR, it may happen that the set cannot detect the length of the track immediately and that some time is required for the playing address display to appear.
Time is required to read SD memory cards/USB devices (flash memory drives and hard discs).	Is there a large number of folders or files recorded on the SD memory card/USB device?	When there are many folders or files, some time may be required for loading.
	Are files other than music files stored on the SD memory card/USB device?	When files other than music files are stored in folders, time is required to read them as well. Do not store files or folders other than music files on the USB device.
Library browsing is not possible.	Is a medium on which library information is recorded loaded?	The library browse mode is only set when media on which library information is recorded are loaded. When a medium on which no library information is recorded is loaded, the folder browse mode is set.
[HISTORY] is not displayed.	Is an SD memory card/USB device loaded?	The [HISTORY] function can only be used for DJ players on which an SD memory card/USB device is loaded.
Nothing is displayed.	Is the power management function activated?	The CDJ-2000 is shipped with the power management function turned on. If you do not want to use the power management function, set [AUTO STANDBY] to [OFF]. (page 22)

Problem	Check	Remedy
PRO DJ LINK does not work well.	Are the player numbers properly set?	Set [PLAYER No.] to [AUTO] or to a number different from the number currently set. (page 22)
	Is the LAN cable properly connected?	Connect the LAN cable properly to the [LINK] terminal.
	Is the switching hub's power turned on?	Turn the switching hub's power on.
	Is an unnecessary device connected to the switching hub?	Disconnect the unnecessary device from the switching hub.

About the liquid crystal display

































- Small black or shining points may appear on the liquid crystal display. This is a phenomenon inherent to liquid crystal displays; this is not a malfunction.
- When using in cold places, the liquid crystal display may be dark for a while after the CDJ-2000's power is turned on. It will reach the normal brightness after a while.
- When the liquid crystal display is exposed to direct sunlight, the light will reflect off it, making it difficult to see. Block the direct sunlight.

Error messages

When the CDJ-2000 cannot operate normally, an error code appears on the display. Take the necessary measures, referring to the table below. If an error code not indicated on the table below is displayed or if the same error code appears after the indicated action has been taken, contact your store of purchase or nearby Pioneer service station.

Error code	Error type	Description of error	Cause and action
E-7201	TOC READ ERROR	TOC data cannot be read.	
E-8301 E-8302 E-8303	PLAYER ERROR (XXXX)	Disc that cannot be played normally is loaded.	<ul style="list-style-type: none"> • Disc is cracked. → Replace the disc. • Disc is dirty. → Clean the disc. • If operation is normal with other discs, the problem is with that disc.
E-8304	DECODE ERROR	Music files that cannot be played normally are loaded.	Format is wrong. → Replace with music files in the proper format.
E-8305	DATA FORMAT ERROR		
E-8306	NO FILE	Track recorded in the library, playlist, etc., has been deleted from the SD memory card/USB device and cannot be played.	Do not delete that track from the SD memory card/USB device.
E-9101	MECHANICAL TIME OUT	Mechanical error (time out) during loading or ejecting of disc.	Displayed when mechanism operation is not completed within the specified time.

List of icons displayed on the main unit display section

	Genre		Player number (1 - 4)		Disc		File type		Sampling rate
	Artist		Registered in tag list		Label		Year		Comment
	Album		Tempo (BPM)		Key		Remixer name		WAIT
	Track/file name		Color		Bit rate		Original artist		rekordbox
	Playlist HISTORY Hot Cue Bank List		USB		Playing		Search		
	Rating		SD		Open folder		DJ play count		
	Time		Computer		Close folder		Date library added		

Cautions on use

About condensation

Water droplets (condensation) may form inside the unit (on operating parts and lenses) in the winter, for example, if the unit is moved from a cold place into a warm room or if the temperature in the room in which the unit is installed rises suddenly (through heating, etc.). The unit will not operate properly and will not be playable with condensation inside. Let the unit stand for 1 to 2 hours at room temperature (though this time depends on the conditions of the condensation) without turning on the power. The water droplets will evaporate and the unit will become playable. Condensation can occur in the summer as well if the unit is exposed to the direct wind from an air-conditioner, etc. If this happens, move the unit to a different location.

Cleaning the lens

The player's lens should not become dirty in normal use, but if for some reason it should malfunction due to dust or dirt, consult your nearest Pioneer authorized service center. Although lens cleaners for players are commercially available, we advise against using them since some may damage the lens.

Handling discs

Storing

- Always place discs in their cases and store them vertically, avoiding hot, humid places, places exposed to direct sunlight and extremely cold places.
 - Be sure to read the cautions included with the disc.
-

Cleaning discs

- Discs may not play if there are fingerprints or dust on them. In this case, use a cleaning cloth, etc., to gently wipe the disc from the inside towards the outside. Do not use dirty cleaning cloths.



- Do not use benzene, thinner or other volatile chemicals. Also do not use record spray or antistatic agents.
- For tough dirt, apply some water to a soft cloth, wring out thoroughly, wipe off the dirt, then wipe off the moisture with a dry cloth.
- Do not use damaged (cracked or warped) discs.
- Do not let the signal surface of discs get scratched or dirty.
- Do not place two discs in the disc tray, one on top of the other.
- Do not attach pieces of paper or stickers to discs. Doing so could warp discs, making it impossible to play them. Also note that rental discs often have labels attached to them, and the label's glue may have oozed out. Check that there is no glue around the edges of such labels before using rented discs.

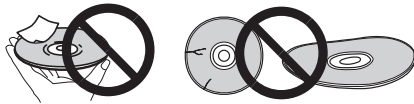

About specially shaped discs

Specially shaped discs (heart-shaped, hexagonal, etc.) cannot be played on this player. Do not attempt to play such discs, as they could damage the player.



About condensation on discs

Water droplets (condensation) may form on the surface of discs if they are moved from a cold place (particularly in winter) into a warm room. Discs may not play normally if there is condensation on them. Carefully wipe the water droplets off the surface of the disc before loading it.

Disclaimer

- Pioneer and rekordbox are trademarks or registered trademarks of the Pioneer Corporation.
- Microsoft®, Windows Vista®, Windows® and Internet Explorer® are registered trademarks or trademarks in the United States and other countries of the Microsoft Corporation of the United States.
- Apple, Macintosh, Mac OS, Safari, iTunes and Finder are registered trademarks of Apple Inc. in the United States and other countries.
- Pentium is a registered trademark of Intel Corporation.
- Adobe and Reader are either registered trademarks or trademarks of Adobe Systems Incorporated in the United States and/or other countries.
- ASIO is a trademark of Steinberg Media Technologies GmbH.
- The SD logo is a trademark.



- The SDHC logo is a trademark.



The names of companies and products mentioned herein are the trademarks of their respective owners.

This product has been licensed for nonprofit use. This product has not been licensed for commercial purposes (for profit-making use), such as broadcasting (terrestrial, satellite, cable or other types of broadcasting), streaming on the Internet, Intranet (a corporate network) or other types of networks or distributing of electronic information (online digital music distribution service). You need to acquire the corresponding licenses for such uses. For details, visit <http://www.mp3licensing.com>.



Fraunhofer Institut
Integrierte Schaltungen

The audio compression technology for MP3 is offered under the license of Fraunhofer IIS and Thomson Multimedia.

Specifications

Power requirements	AC 120 V, 60 Hz
Power consumption	28 W
Power consumption (standby)	0.4 W
Main unit weight	4.6 kg (10.1 lb)
External dimensions	320 mm (W) × 106.4 mm (H) × 405.7 mm (D) (12.6 in. (W) × 4.2 in. (H) × 16 in. (D))
Tolerable operating temperature	+5 °C to +35 °C (+41 °F to +95 °F)
Tolerable operating humidity	5 % to 85 % (no condensation)

Analog audio output (AUDIO OUT L/R)

Output terminal	RCA terminal
Output Level	2.0 Vrms (1 kHz)
Frequency response	4 Hz to 20 kHz
S/N ratio	115 dB
Total harmonic distortion	0.0018 %

Digital audio output (DIGITAL OUT)

Output terminal	RCA terminal
Output type	Coaxial digital (S/PDIF)
Output level	0.5 Vp-p (75 Ω)
Output format	44.1 kHz, 24 bit/16 bit

USB downstream section (USB)

Port	Type A
Power supply	5 V/500 mA or less

USB upstream section (USB)

Port	Type B
------	--------

LAN (PRO DJ LINK)

Rating	100Base-TX
--------	------------

Control output (CONTROL)

Port	Mini-jack
------	-----------

SD memory card section

File system	Conforming to "SD Specifications Part 2 File System Specification Version 2.00"
Max. memory capacity	32 GB

Main display

Display type	Active matrix TFT liquid crystal display (LCD)
Screen size	6.1-inch, wide
Supported languages	18 languages

- The articles concerning free repairs, etc., indicated on the warranty do not apply to the rekordbox music management software. Before installing or using rekordbox, carefully read the articles in *Software end user license agreement* on page 23.
- The specifications and design of this product are subject to change without notice.

To register your product, find the nearest authorized service location, to purchase replacement parts, operating instructions, or accessories, please go to one of following URLs :

Pour enregistrer votre produit, trouver le service après-vente agréé le plus proche et pour acheter des pièces de rechange, des modes d'emploi ou des accessoires, reportez-vous aux URL suivantes :

In the USA/Aux Etats-Unis

<http://www.pioneerelectronics.com>

In Canada/Aux Canada

<http://www.pioneerelectronics.ca>

S018_B1_EnFr

Published by Pioneer Corporation.
Copyright © 2010 Pioneer Corporation.
All rights reserved.

PIONEER CORPORATION

1-1, Shin-ogura, Saiwai-ku, Kawasaki-shi, Kanagawa 212-0031, Japan

PIONEER ELECTRONICS (USA) INC.

P.O. BOX 1540, Long Beach, California 90801-1540, U.S.A. TEL: (800) 421-1404

PIONEER ELECTRONICS OF CANADA, INC.

340 Ferrier Street, Unit 2, Markham, Ontario L3R 2Z5, Canada TEL: 1-877-283-5901, 905-479-4411

K002_PSV_CU

Printed in

<DRB1628-A>



Free Manuals Download Website

<http://myh66.com>

<http://usermanuals.us>

<http://www.somanuals.com>

<http://www.4manuals.cc>

<http://www.manual-lib.com>

<http://www.404manual.com>

<http://www.luxmanual.com>

<http://aubethermostatmanual.com>

Golf course search by state

<http://golfingnear.com>

Email search by domain

<http://emailbydomain.com>

Auto manuals search

<http://auto.somanuals.com>

TV manuals search

<http://tv.somanuals.com>