

Pioneer *sound.vision.soul*

DVD Recorder

DVR-231-S

DVR-231-AV

DVR-233-S



Register Your Product on

www.pioneerelectronics.com (US)

www.pioneerelectronics.ca (Canada)

Operating Instructions

RW
COMPATIBLE



The lightning flash with arrowhead, within an equilateral triangle, is intended to alert the user to the presence of uninsulated "dangerous voltage" within the product's enclosure that may be of sufficient magnitude to constitute a risk of electric shock to persons.

CAUTION

**RISK OF ELECTRIC SHOCK
DO NOT OPEN**

CAUTION:

TO PREVENT THE RISK OF ELECTRIC SHOCK, DO NOT REMOVE COVER (OR BACK). NO USER-SERVICEABLE PARTS INSIDE. REFER SERVICING TO QUALIFIED SERVICE PERSONNEL.



The exclamation point within an equilateral triangle is intended to alert the user to the presence of important operating and maintenance (servicing) instructions in the literature accompanying the appliance.

D1-4-2-3_En

IMPORTANT NOTICE – THE SERIAL NUMBER FOR THIS EQUIPMENT IS LOCATED IN THE REAR. PLEASE WRITE THIS SERIAL NUMBER ON YOUR ENCLOSED WARRANTY CARD AND KEEP IN A SECURE AREA. THIS IS FOR YOUR SECURITY.

D1-4-2-6-1_En

Information to User

Alteration or modifications carried out without appropriate authorization may invalidate the user's right to operate the equipment.

D8-10-2_En

NOTE: This equipment has been tested and found to comply with the limits for a Class B digital device, pursuant to Part 15 of the FCC Rules. These limits are designed to provide reasonable protection against harmful interference in a residential installation. This equipment generates, uses, and can radiate radio frequency energy and, if not installed and used in accordance with the instructions, may cause harmful interference to radio communications. However, there is no guarantee that interference will not occur in a particular installation. If this equipment does cause harmful interference to radio or television reception, which can be determined by turning the equipment off and on, the user is encouraged to try to correct the interference by one or more of the following measures:

- Reorient or relocate the receiving antenna.
- Increase the separation between the equipment and receiver.
- Connect the equipment into an outlet on a circuit different from that to which the receiver is connected.
- Consult the dealer or an experienced radio/TV technician for help.

D8-10-1-2_En

CAUTION : USE OF CONTROLS OR ADJUSTMENTS OR PERFORMANCE OF PROCEDURES OTHER THAN THOSE SPECIFIED HEREIN MAY RESULT IN HAZARDOUS RADIATION EXPOSURE.

CAUTION : THE USE OF OPTICAL INSTRUMENTS WITH THIS PRODUCT WILL INCREASE EYE HAZARD. D8-8-2-1_En

WARNING – TO PREVENT FIRE OR SHOCK HAZARD, DO NOT EXPOSE THIS APPLIANCE TO RAIN OR MOISTURE.

D1-4-2-1_En

CAUTION: This product satisfies FCC regulations when shielded cables and connectors are used to connect the unit to other equipment. To prevent electromagnetic interference with electric appliances such as radios and televisions, use shielded cables and connectors for connections.

D8-10-3a_En

This Class B digital apparatus complies with Canadian ICES-003.

Cet appareil numérique de la Classe B est conforme à la norme NMB-003 du Canada.

D8-10-1-3_EF

IMPORTANT SAFETY INSTRUCTIONS

READ INSTRUCTIONS — All the safety and operating instructions should be read before the product is operated.

RETAIN INSTRUCTIONS — The safety and operating instructions should be retained for future reference.

HEED WARNINGS — All warnings on the product and in the operating instructions should be adhered to.

FOLLOW INSTRUCTIONS — All operating and use instructions should be followed.

CLEANING — The product should be cleaned only with a polishing cloth or a soft dry cloth. Never clean with furniture wax, benzene, insecticides or other volatile liquids since they may corrode the cabinet.

ATTACHMENTS — Do not use attachments not recommended by the product manufacturer as they may cause hazards.

WATER AND MOISTURE — Do not use this product near water — for example, near a bathtub, wash bowl, kitchen sink, or laundry tub; in a wet basement; or near a swimming pool; and the like.

ACCESSORIES — Do not place this product on an unstable cart, stand, tripod, bracket, or table. The product may fall, causing serious injury to a child or adult, and serious damage to the product. Use only with a cart, stand, tripod, bracket, or table recommended by the manufacturer, or sold with the product. Any mounting of the product should follow the manufacturer's instructions, and should use a mounting accessory recommended by the manufacturer.

CART — A product and cart combination should be moved with care. Quick stops, excessive force, and uneven surfaces may cause the product and cart combination to overturn.



VENTILATION — Slots and openings in the cabinet are provided for ventilation and to ensure reliable operation of the product and to protect it from overheating, and these openings must not be blocked or covered. The openings should never be blocked by placing the product on a bed, sofa, rug, or other similar surface. This product should not be placed in a built-in installation such as a bookcase or rack unless proper ventilation is provided or the manufacturer's instructions have been adhered to.

POWER SOURCES — This product should be operated only from the type of power source indicated on the marking label. If you are not sure of the type of power supply to your home, consult your product dealer or local power company.

LOCATION — The appliance should be installed in a stable location.

NONUSE PERIODS — The power cord of the appliance should be unplugged from the outlet when left un-used for a long period of time.

GROUNDING OR POLARIZATION

- If this product is equipped with a polarized alternating current line plug (a plug having one blade wider than the other), it will fit into the outlet only one way. This is a safety feature. If you are unable to insert the plug fully into the outlet, try reversing the plug. If the plug should still fail to fit, contact your electrician to replace your obsolete outlet. Do not defeat the safety purpose of the polarized plug.
- If this product is equipped with a three-wire grounding type plug, a plug having a third (grounding) pin, it will only fit into a grounding type power outlet. This is a safety feature. If you are unable to insert the plug into the outlet, contact your electrician to replace your obsolete outlet. Do not defeat the safety purpose of the grounding type plug.

POWER-CORD PROTECTION — Power-supply cords should be routed so that they are not likely to be walked on or pinched by items placed upon or against them, paying particular attention to cords at plugs, convenience receptacles, and the point where they exit from the product.

OUTDOOR ANTENNA GROUNDING — If an outside antenna or cable system is connected to the product, be sure the antenna or cable system is grounded so as to provide some protection against voltage surges and built-up static charges. Article 810 of the National Electrical Code, ANSI/NFPA 70, provides information with regard to proper grounding of the mast and supporting structure, grounding of the lead-in wire to an antenna discharge unit, size of grounding conductors, location of antenna-discharge unit, connection to grounding electrodes, and requirements for the grounding electrode. See Figure A.

LIGHTNING — For added protection for this product during a lightning storm, or when it is left unattended and unused for long periods of time, unplug it from the wall outlet and disconnect the antenna or cable system. This will prevent damage to the product due to lightning and power-line surges.

POWER LINES — An outside antenna system should not be located in the vicinity of overhead power lines or other electric light or power circuits, or where it can fall into such power lines or circuits. When installing an outside antenna system, extreme care should be taken to keep from touching such power lines or circuits as contact with them might be fatal.

OVERLOADING — Do not overload wall outlets, extension cords, or integral convenience receptacles as this can result in a risk of fire or electric shock.

OBJECT AND LIQUID ENTRY — Never push objects of any kind into this product through openings as they may touch dangerous voltage points or short-out parts that could result in a fire or electric shock. Never spill liquid of any kind on the product.

SERVICING — Do not attempt to service this product yourself as opening or removing covers may expose you to dangerous voltage or other hazards. Refer all servicing to qualified service personnel.

DAMAGE REQUIRING SERVICE — Unplug this product from the wall outlet and refer servicing to qualified service personnel under the following conditions:

- When the power-supply cord or plug is damaged.
- If liquid has been spilled, or objects have fallen into the product.
- If the product has been exposed to rain or water.
- If the product does not operate normally by following the operating instructions. Adjust only those controls that are covered by the operating instructions as an improper adjustment of other controls may result in damage and will often require extensive work by a qualified technician to restore the product to its normal operation.
- If the product has been dropped or damaged in any way.
- When the product exhibits a distinct change in performance — this indicates a need for service.

REPLACEMENT PARTS — When replacement parts are required, be sure the service technician has used replacement parts specified by the manufacturer or have the same characteristics as the original part. Unauthorized substitutions may result in fire, electric shock, or other hazards.

SAFETY CHECK — Upon completion of any service or repairs to this product, ask the service technician to perform safety checks to determine that the product is in proper operating condition.

WALL OR CEILING MOUNTING — The product should not be mounted to a wall or ceiling.

HEAT — The product should be situated away from heat sources such as radiators, heat registers, stoves, or other products (including amplifiers) that produce heat.

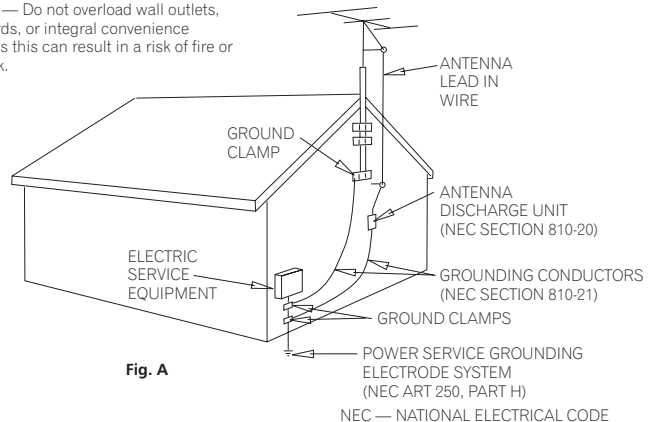

Fig. A

NEC — NATIONAL ELECTRICAL CODE

D1-4-2-En

DANGER

VISIBLE AND INVISIBLE LASER RADIATION WHEN OPEN. AVOID DIRECT EXPOSURE TO BEAM.

This product incorporates copyright protection technology that is protected by method claims of certain U.S. patents and other intellectual property rights owned by Macrovision Corporation and other rights owners. Use of this copyright protection technology must be authorized by Macrovision Corporation, and is intended for home and other limited viewing uses only unless otherwise authorized by Macrovision Corporation. Reverse engineering or disassembly is prohibited.

CAUTION – PREVENT ELECTRIC SHOCK DO NOT USE THIS (POLARIZED) PLUG WITH AN EXTENSION CORD, RECEPTACLE OR OTHER OUTLET UNLESS THE BLADES CAN BE FULLY INSERTED TO PREVENT BLADE EXPOSURE.

ATTENTION – POUR PREVENIR LES CHOCS ELECTRIQUES NE PAS UTILISER CETTE FICHE POLARISEE AVEC UN PROLONGATEUR UNE PRISE DE COURANT OU UNE AUTRE SORTIE DE COURANT, SAUF SI LES LAMES PEUVENT ETRE INSEREES A FOND SANS EN LAISSER AUCUNE PARTIE A DECOUVERT.

D2-4-4-1_EF

NOTE TO CATV SYSTEM INSTALLER

THIS REMINDER IS PROVIDED TO CALL THE CATV SYSTEM INSTALLER'S ATTENTION TO ARTICLE 820-40 OF THE NEC THAT PROVIDES GUIDELINES FOR PROPER GROUNDING AND, IN PARTICULAR, SPECIFIES THAT THE CABLE GROUND SHALL BE CONNECTED TO THE GROUNDING SYSTEM OF THE BUILDING, AS CLOSE TO THE POINT OF CABLE ENTRY AS PRACTICAL.

D1-4-2-8_En

Recording equipment and copyright: You may use this product only to reproduce or copy materials for which you own the copyright or have obtained permission to copy from the copyright owner or for which you otherwise have a legal right to reproduce or copy. Unless you own the copyright or have obtained permission from the copyright owner or otherwise have a legal right to reproduce or copy, you may be violating the law, including copyright law, and may be subject to payment of damages and other remedies.

K018US_En

POWER-CORD CAUTION

Handle the power cord by the plug. Do not pull out the plug by tugging the cord and never touch the power cord when your hands are wet as this could cause a short circuit or electric shock. Do not place the unit, a piece of furniture, etc., on the power cord, or pinch the cord. Never make a knot in the cord or tie it with other cords. The power cords should be routed such that they are not likely to be stepped on. A damaged power cord can cause a fire or give you an electrical shock. Check the power cord once in a while. When you find it damaged, ask your nearest PIONEER authorized service center or your dealer for a replacement.

S002_En

This product is for general household purposes. Any failure due to use for other than household purposes (such as long-term use for business purposes in a restaurant or use in a car or ship) and which requires repair will be charged for even during the warranty period.

K041_En

This product includes FontAvenue® fonts licenced by NEC corporation. FontAvenue is a registered trademark of NEC Corporation.

WARNING: Handling the cord on this product or cords associated with accessories sold with the product will expose you to lead, a chemical known to the State of California and other governmental entities to cause cancer and birth defects or other reproductive harm.

Wash hands after handling

D36-P4_En

This product contains mercury. Disposal of this material may be regulated due to environmental considerations. For disposal or recycling information, please contact your local authorities or the Electronics Industries Alliance : www.eiae.org.

K057_En



We Want You Listening For A Lifetime

Used wisely, your new sound equipment will provide a lifetime of fun and enjoyment. Since hearing damage from loud noise is often undetectable until it is too late, this manufacturer and the Electronic Industries Association's Consumer Electronics Group recommend you avoid prolonged exposure to excessive noise. This list of sound levels is included for your protection.

Decibel Level Example

30	Quiet library, soft whispers
40	Living room, refrigerator, bedroom away from traffic
50	Light traffic, normal conversation, quiet office
60	Air conditioner at 20 feet, sewing machine
70	Vacuum cleaner, hair dryer, noisy restaurant
80	Average city traffic, garbage disposals, alarm clock at two feet.

THE FOLLOWING NOISES CAN BE DANGEROUS UNDER CONSTANT EXPOSURE

90	Subway, motorcycle, truck traffic, lawn mower
100	Garbage truck, chain saw, pneumatic drill
120	Rock band concert in front of speakers, thunderclap
140	Gunshot blast, jet plane
180	Rocket launching pad

Information courtesy of the Deafness Research Foundation.



S001_En

Dear Customer:

Selecting fine audio equipment such as the unit you've just purchased is only the start of your musical enjoyment. Now it's time to consider how you can maximize the fun and excitement your equipment offers. This manufacturer and the Electronic Industries Association's Consumer Electronics Group want you to get the most out of your equipment by playing it at a safe level. One that lets the sound come through loud and clear without annoying blaring or distortion-and, most importantly, without affecting your sensitive hearing.

Sound can be deceiving. Over time your hearing "comfort level" adapts to higher volumes of sound. So what sounds "normal" can actually be loud and harmful to your hearing. Guard against this by setting your equipment at a safe level BEFORE your hearing adapts.

To establish a safe level:

- Start your volume control at a low setting.
- Slowly increase the sound until you can hear it comfortably and clearly, and without distortion.

Once you have established a comfortable sound level:

- Set the dial and leave it there.

Taking a minute to do this now will help to prevent hearing damage or loss in the future. After all, we want you listening for a lifetime.

CAUTION

This product is a class 1 laser product, but this product contains a laser diode higher than Class 1. To ensure continued safety, do not remove any covers or attempt to gain access to the inside of the product. Refer all servicing to qualified personnel.



The following caution label appears on your unit. Location: inside of the unit

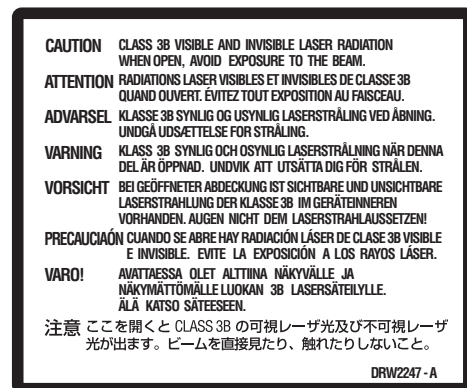

DRW2247 - A

D3-4-2-1-8_A_En

Contents

01 Before you start

Features	7
What's in the box	7
Putting the batteries in the remote control	8
Using the remote control	8
Disc / content format playback compatibility	8

02 Connecting up

Rear panel connections	10
Front panel connections	10
Easy connections	11
Using other types of video output	12
Connecting to a cable box or satellite receiver (1)	13
Connecting to a cable box or satellite receiver (2)	14
Connecting to an AV amplifier or receiver	15
Connecting other AV sources	16
Plugging in	16

03 Controls and displays

Front panel	17
Display	17
Remote control	18

04 Getting started

Switching on and setting up	20
Making your first recording	22
Using the built-in TV tuner	22
Basic playback	23
Displaying disc information on-screen	25

05 Playback

Introduction	27
Using the Disc Navigator to browse the contents of a disc	27
Navigating discs	28
Scanning discs	28
Playing in slow motion	29
Frame advance/frame reverse	29
The Play Mode menu	30
Displaying and switching subtitles	31
Switching DVD soundtracks	31
Switching audio channels	32
Switching camera angles	32

06 Recording

About DVD recording	33
Recording time and picture quality	33
Restrictions on video recording	34
Setting the picture quality/recording time	34
Basic recording from the TV	35
Setting a timer recording	35
Timer recording FAQ	38
Recording from an external component	39
Playing your recordings on other DVD players	39
Initializing a DVD-RW disc	40

07 Editing

Editing Titles (Title Edit)	41
Editing chapters (Chapter Edit)	43

08 The Initial Setup menu

Using the Initial Setup menu	45
Basic settings	45
Disc settings	49
Video settings	49
Audio settings	50
Recording settings	52
Playback settings	52

09 Additional information

Screen sizes and disc formats	56
Troubleshooting	57
Frequently asked questions	59
Language code list	60
Country/Area code list	60
On-screen displays and recorder displays	61
Handling discs	62
Storing discs	62
Damaged discs	62
Cleaning the pickup lens	62
Condensation	62
Hints on installation	62
Moving the recorder	63
Resetting the recorder	63
Additional information for cable/satellite/STB (set-top box) users	63
Glossary	63
Specifications	65

Chapter 1

Before you start

Features

- **Progressive scan-compatible**

Compared to standard interlaced video, progressive scan effectively doubles the amount of video information fed to your TV or monitor. (Check your TV/monitor for compatibility with this feature.)

- **Cinema surround sound in your home**

Connect this recorder to a Dolby Digital and/or DTS-compatible AV amp/receiver to enjoy full surround sound effects from Dolby Digital and DTS DVD discs.

- **Program up to 32 timer recordings**

You can program the recorder to record up to 32 programs, up to a month in advance, using the VCR Plus+[®] system*¹ for easy programming if you want. As well as single programs, you can specify daily or weekly recordings, too.

**¹ VCR Plus+ and PlusCode are registered trademarks of Gemstar Development Corporation.*

The VCR Plus+ system is manufactured under license from Gemstar Development Corporation.

- **One Touch Recording**

Use One Touch Recording to start recording immediately in 30 minute blocks. Each time you press the ● **REC** button, the recording time is extended by another 30 minutes.

- **Optimized recording**

Optimized recording adjusts the recording quality automatically if a timer recording will not fit onto a disc with the settings that you made. Note that the quality of recordings may be reduced if a longer recording time is used.

- **High quality 16-bit Linear PCM audio**

When recording using the high quality setting (**XP**), the audio is recorded in uncompressed 16-bit Linear PCM format. This delivers great sounding audio to accompany the high picture quality.

- **Find what you want to watch quickly and easily**

Unlike video tape that needs to be wound to the correct place, you can jump right to the part of a DVD disc that you want to watch. Search for a point on a disc by title, chapter or time.

- **Play Video mode recordings on a regular DVD player** **Video mode**

Discs recorded using the Video mode can be played back on regular DVD players, including computer DVD drives compatible with DVD-Video playback*².

**² 'DVD-Video format' recording: The use of the DVD-Video format for recording on DVD-R and DVD-RW discs is referred to as recording in 'Video mode' on Pioneer's DVD recorders. Supporting playback of DVD-R / DVD-RW discs is optional for manufacturers of DVD playback equipment, and there is DVD playback equipment that does not play DVD-R or DVD-RW discs recorded in the DVD-Video format.*

Note: 'Finalization' is required.

What's in the box

Please confirm that the following accessories are in the box when you open it.

- Remote control
- AA/R6P dry cell batteries x2
- Audio/video cable (red/white/yellow)
- RF antenna cable
- Power cable
- Blank DVD-RW disc
- Quick start guide
- These operating instructions
- Warranty card

Putting the batteries in the remote control

- 1 Open the battery compartment cover on the back of the remote control.

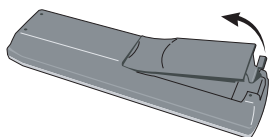

- 2 Insert two AA/R6P batteries into the battery compartment following the indications (+, -) inside the compartment.

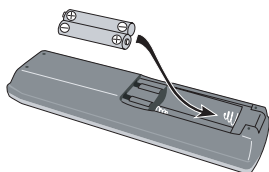

- 3 Close the cover.

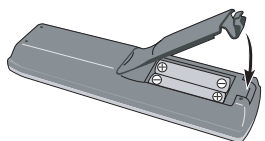

Note

Incorrect use of batteries can result in hazards such as leakage and bursting. Please observe the following:

- Don't mix new and old batteries together.
- Don't use different kinds of battery together—although they may look similar, different batteries may have different voltages.
- Make sure that the plus and minus ends of each battery match the indications in the battery compartment.
- Remove batteries from equipment that isn't going to be used for a month or more.
- When disposing of used batteries, please comply with governmental regulations or environmental public instruction's rules that apply in your country or area.

Using the remote control

Keep in mind the following when using the remote control:

- Make sure that there are no obstacles between the remote and the remote sensor on the unit.
- Remote operation may become unreliable if strong sunlight or fluorescent light is shining on the unit's remote sensor.
- Remote controllers for different devices can interfere with each other. Avoid using remotes for other equipment located close to this unit.
- Replace the batteries when you notice a fall off in the operating range of the remote.
- When the batteries run down or you change the batteries, the remote control mode is automatically reset. See *Remote Control* on page 48 to reset it.
- Use within the operating range and angle, as shown.

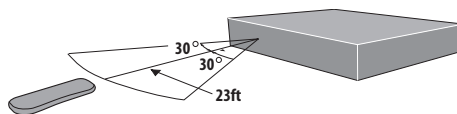

Disc / content format playback compatibility

General disc compatibility

This recorder is compatible with a wide range of disc types (media) and formats. Playable discs will generally feature one of the following logos on the disc and/or disc packaging. Note however that some disc types, such as recordable CD and DVD, may be in an unplayable format—see below for further compatibility information.



- **DVD** is a trademark of DVD Format/Logo Licensing Corporation.
- Playability of 'DualDisc'
 - The DVD-Audio content on DVD side of a DualDisc cannot be played with this product.

- The DVD-Video content on DVD side of a DualDisc may or may not be played with this product.
- Since audio content on 'non-DVD' side of a DualDisc is not compliant with the Compact Disc Digital Audio specification, it may or may not be played with this product.
- If you need further information about playability of DualDisc, please see 'Service & Support' on the Pioneer web site (www.pioneerelectronics.com)

DVD-R/RW compatibility

This recorder will play and record DVD-R/RW discs.

Compatible media:

- DVD-RW Ver. 1.1, Ver. 1.1 / 2x and Ver. 1.2 / 4x
- DVD-R Ver. 2.0, Ver. 2.0 / 4x / 8x and Ver. 2.1 / 16x

Recording formats:

- DVD-R: DVD-Video format (Video mode)
- DVD-RW: Video Recording (VR) format and DVD-Video format (Video mode)

Older models of DVD recorders and DVD writers may reject DVD-RW Ver. 1.2 / 4x discs. If you want to share DVD-RW discs between this recorder and an older recorder/writer, we recommend using Ver. 1.1 discs.

The following table shows older Pioneer DVD recorders' limited compatibility with DVD-RW Ver. 1.2 / 4x discs.

Model	Playable	Recordable
DVR-7000	Yes ^{1,2,3}	No
DVR-810H/DVR-57H DVR-210/DVR-310/DVR-510H	Yes ¹	No

¹ Discs should be finalized in this recorder before playing. Unfinalized VR mode and Video mode discs may not play.

² **Cannot read the CPRM information** will show in the display when you load a disc. However, this will not affect playback.

³ Copy-once protected disc titles will not play.

CD-R/RW compatibility

This recorder cannot record CD-R or CD-RW discs.

- Compatible formats: CD-Audio, Video CD
- Multi-session playback: No
- Unfinalized disc playback: CD-Audio only



Frequently asked questions

- *What's the difference between DVD-R and DVD-RW?*

The most important difference between DVD-R and DVD-RW is that DVD-R is a record-once medium, while DVD-RW is a re-recordable/erasable medium. You can re-record/erase a DVD-RW disc approximately 1,000 times.

For more information, see *About DVD recording* on page 33.

- *What's VR mode?*

VR (Video Recording) mode is a special mode designed for home DVD recording. It allows flexible editing of recorded material compared to 'Video mode'. On the other hand, Video mode discs are more compatible with other DVD players.

- *Can I play my recordable discs in a regular DVD player?*

Generally, DVD-R discs and DVD-RW discs recorded in Video mode* are playable in a regular DVD player, but they must be 'finalized' first. This process fixes the contents of the disc to make them readable to other DVD players as DVD-Video discs.

DVD-RW discs recorded in VR mode are playable in some players.



This label indicates playback compatibility with DVD-RW discs recorded in VR mode (Video Recording format). However, for discs recorded with a record-only-once encrypted program, playback can only be achieved using a CPRM compatible device.

Note that Pioneer cannot guarantee that discs recorded using this recorder will play on other players.

** 'DVD-Video format' recording: The use of the DVD-Video format for recording on DVD-R and DVD-RW discs is referred to as recording in 'Video mode' on Pioneer's DVD recorders. Supporting playback of DVD-R / DVD-RW discs is optional for manufacturers of DVD playback equipment, and there is DVD playback equipment that does not play DVD-R or DVD-RW discs recorded in the DVD-Video format.*

Note: 'Finalization' is required.

This recorder supports the recording of 'copy-once' broadcast programs using the CPRM copy protection system (see CPRM on page 34) on CPRM-compliant DVD-RW discs in VR mode. CPRM recordings can only be played on players that are specifically compatible with CPRM.

Chapter 2

Connecting up

Rear panel connections

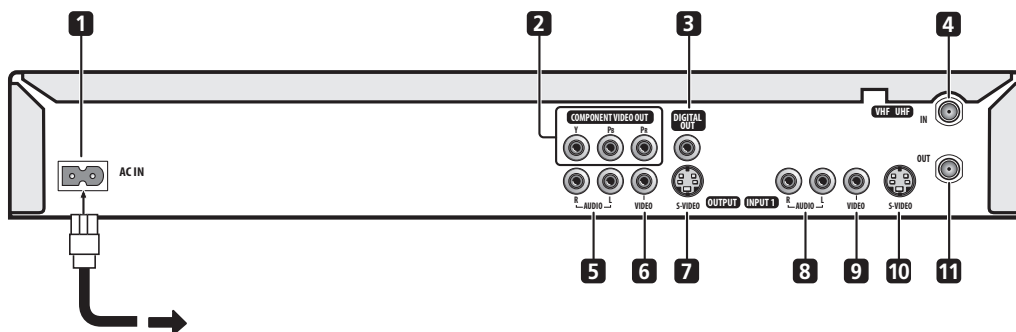

1 AC IN

Connect to a power outlet using the supplied power cable only.

2 COMPONENT VIDEO OUT

A high-quality video output for connecting to a TV or monitor with a component video input.

3 COAXIAL DIGITAL OUT

A digital audio output for connecting to an AV amp/receiver, Dolby Digital/DTS decoder or other equipment with a coaxial digital input.

4 VHF/UHF IN

Antenna input for connection to your TV antenna.

5 Analog audio output

Stereo analog audio output for connection to your TV or AV receiver.

6 Composite video output

Standard video output for connection to your TV or AV receiver.

7 S-video output

S-video video output for connection to your TV or AV receiver.

8 Analog audio input

Stereo analog audio input available for recording.

9 Composite video input

Standard video input available for recording.

10 S-video input

S-video input available for recording.

11 VHF/UHF OUT

Antenna output that passes through the antenna input signal to make it available for your VCR, TV, etc.

Front panel connections

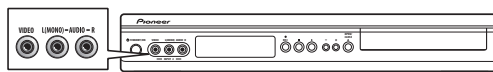

On the left side of the front panel there is a second audio/video input, consisting of a standard (composite) video jack, and stereo analog audio jacks.

Easy connections

The setup described here is a basic configuration that allows you to record TV programs on both this recorder and your VCR. When watching recordings from this recorder, set your TV to input 1; switch to input 2 to watch a video playing in the VCR.

Important

- This recorder is equipped with copy protection technology. Do not connect this recorder to your TV via a VCR (or your VCR via this recorder) using AV cables, as the picture from this recorder will not appear properly on your TV.
- Before making or changing any rear panel connections, make sure that all components are switched off and unplugged from the wall outlet.

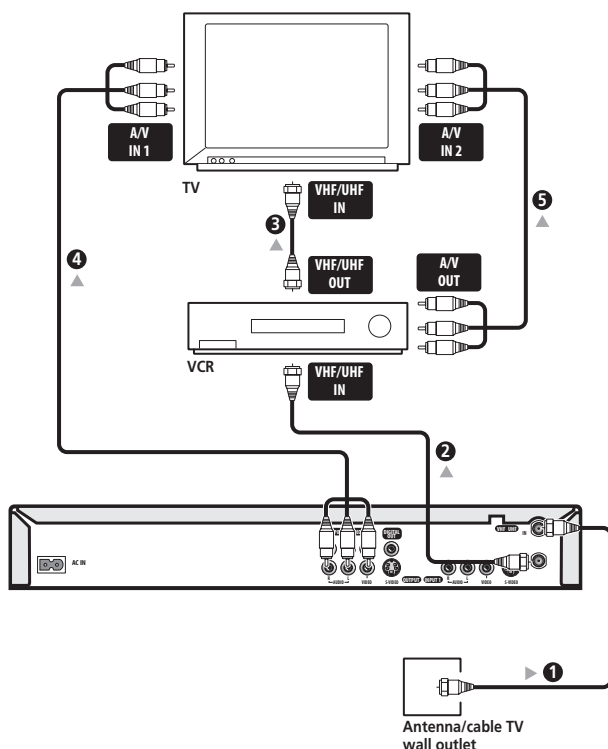

1 Connect your TV antenna/cable TV outlet to the VHF/UHF IN jack on this recorder.

2 Use an RF antenna cable (one is supplied) to connect the VHF/UHF OUT jack on this recorder to the antenna input on your VCR.

- If you are not connecting a VCR in the chain, connect this recorder directly to your TV and skip the next step.

3 Use an RF antenna cable to connect the antenna output on your VCR to the antenna input on your TV.

4 Connect the AUDIO and VIDEO OUTPUT jacks to a set of audio/video inputs on your TV.

Use the supplied three-pin audio/video cable. It is color-coded to help you match them up (red/white for the right/left audio connections and yellow for video). Make sure you match up the left and right outputs with their corresponding inputs for correct stereo sound.

5 Connect your VCR to your TV (A/V IN 2 above) using a set of audio and video cables.

Note

- See the following page if you want to use S-video or component video cables for the video connection.

Using other types of video output

This recorder has standard (composite), S-video and component video outputs. The main difference between them is the quality of the picture. S-video delivers a better picture than composite video, while component video gives better picture quality still. The variety of outputs also gives you the flexibility of connecting your particular equipment using the best connection type available.

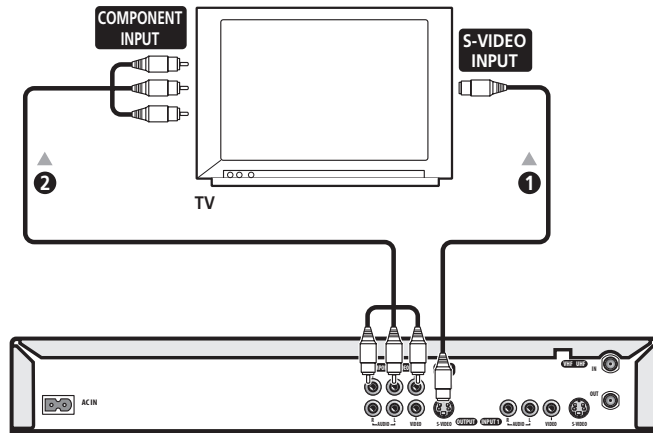

1 Connecting using an S-video output

S-video carries the picture as separate color and luminance (brightness) signals.

- Use an S-video cable (not supplied) to connect the S-VIDEO OUTPUT to an S-video input on your TV, monitor (or other equipment).

2 Connecting using the component video output

Component video carries the picture as two separate color signals, plus a luminance (brightness) signal.

See also *Video Out* on page 49 for how to set up the component video output for use with a progressive scan-compatible TV.

- Use a component video cable (not supplied) to connect the COMPONENT VIDEO OUT jacks to a component video input on your TV, monitor (or other equipment).

Connecting to a cable box or satellite receiver (1)

If you are using a cable box or satellite receiver with only a few scrambled channels, follow the setup on this page. If many or all the channels are scrambled, we recommend using the setup on the following page.

Using the setup on this page you can:

- Record unscrambled channels by selecting them on this recorder.
- Record scrambled channels by selecting them on the cable box/satellite tuner.
- Watch one channel while recording another.

Important

- Do not connect this recorder 'through' your VCR, satellite receiver or cable box. Always connect each component directly to your TV or AV amp/receiver.

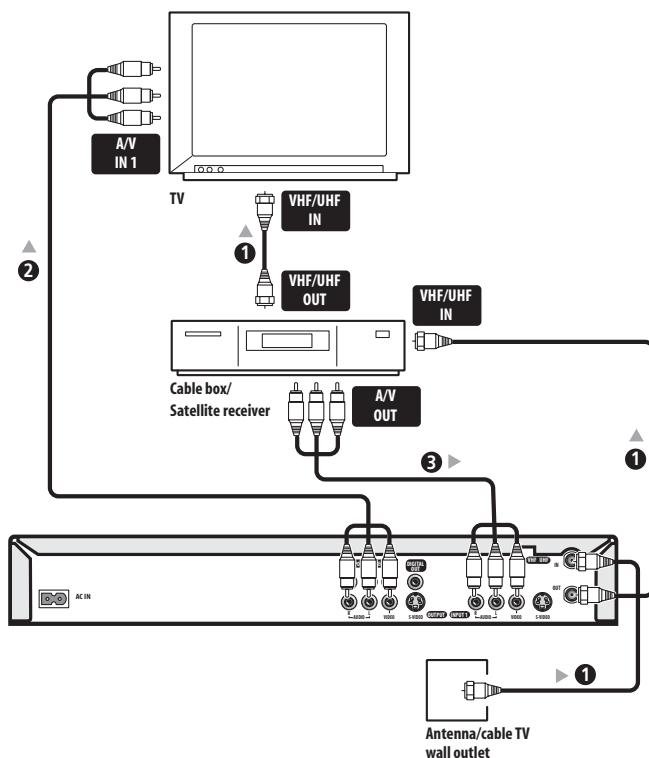

- 1 Connect RF antenna cables as shown.**
This enables you to watch and record TV channels.
- 2 Connect the AUDIO and VIDEO OUTPUT jacks on this recorder to a set of audio/video inputs on your TV using a set of A/V cables (as supplied).**
This enables you to watch the output from this recorder.
- 3 Connect the audio/video output of your cable box/satellite tuner to the INPUT 1 jacks on this recorder using a set of A/V cables.**
This enables you to record scrambled TV channels.

Note

The diagram shows standard video connections, but you can alternatively use the S-video or component video connections if they're available.

Connecting to a cable box or satellite receiver (2)

If many or all the channels you receive by cable or satellite are scrambled, we recommend using this setup.

Using the setup on this page you can:

- Record any channel by selecting it on the cable box/satellite tuner.

Important

- Do not connect this recorder 'through' your VCR, satellite receiver or cable box. Always connect each component directly to your TV or AV amp/receiver.

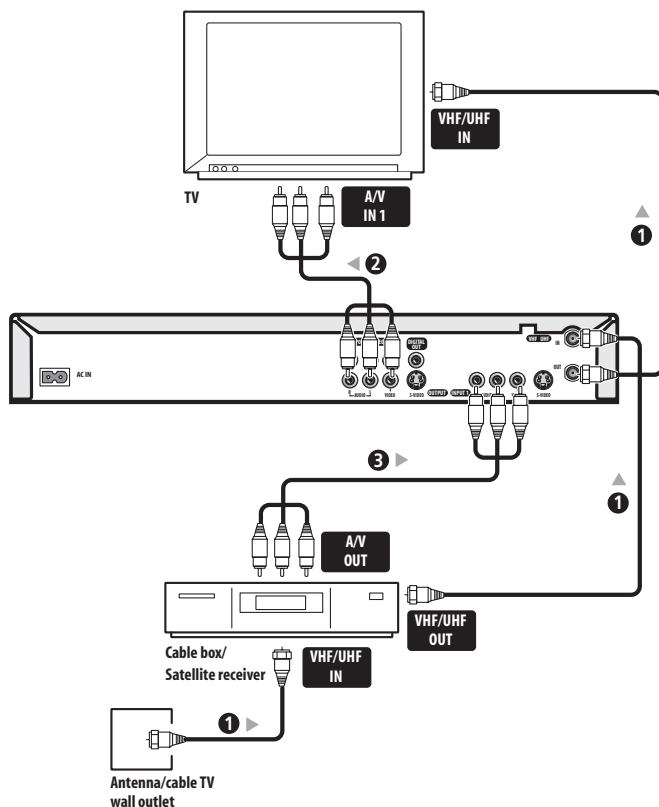

1 Connect the RF antenna cables as shown.

This enables you to watch and record TV channels.

2 Connect the AUDIO and VIDEO OUTPUT jacks on this recorder to a set of audio/video inputs on your TV using a set of A/V cables (as supplied).

This enables you to watch discs.

3 Connect the audio/video output of your cable box/satellite tuner to the INPUT 1 jacks on this recorder using a set of A/V cables.

This enables you to record scrambled TV channels.

Note

- The setup on this page does not allow you to watch one channel and record another.
- The diagram shows standard video connections, but you can alternatively use the S-video or component video connections if they're available.

Connecting to an AV amplifier or receiver

To enjoy multichannel surround sound you need to connect this recorder to an AV amp/receiver using the digital coaxial output. In addition to the digital connection, we recommend also connecting using the stereo analog connection.

You'll probably also want to connect a video output to your AV amp/receiver. Use the standard (composite) video output (as shown here), or the S-video or component video connections.

See also *Audio Out* on page 51 for how to set up the digital audio output. (Noise may be output from your speakers if the recorder is not set up to work with your AV amp/receiver.)

Important

- Do not connect this recorder to your TV 'through' your VCR or other component using A/V cables. Always connect it directly to your TV.

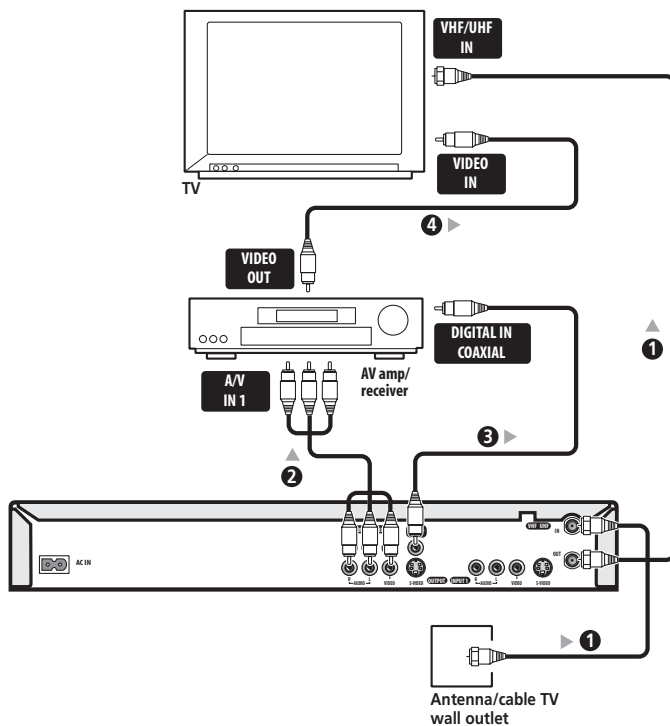

1 Connect RF antenna cables as shown.

This enables you to watch and record TV channels.

2 Connect the AUDIO and VIDEO OUTPUT jacks on this recorder to a set of audio/video inputs on your AV amp/receiver.

3 Use a coaxial digital audio cable (not supplied) to connect the COAXIAL DIGITAL OUT jack on this recorder to a coaxial digital input on your AV amp/receiver.

This enables you to listen to multichannel surround sound.

4 Connect the AV amp/receiver's video output to a video input on your TV.

Note

- The diagram shows standard video connections, but you can alternatively use the S-video or component video connections if they're available.
- If your AV amp/receiver doesn't have a coaxial digital input, but has an optical type, converter boxes that convert from coaxial to optical are available at specialist audio dealers.

Connecting other AV sources

Connecting a VCR or analog camcorder

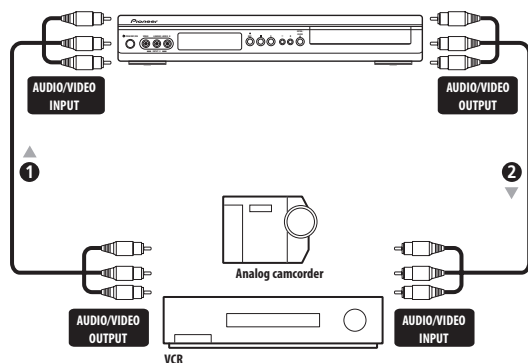

1 Connect a set of audio and video outputs of your VCR or camcorder to a set of inputs on this recorder. This enables you to record tapes from your VCR or camcorder.

- You can use standard video or S-video cables for the video connection.
- The front panel connections make convenient connections for a camcorder input (standard video connection only).

2 Connect a set of audio and video inputs of your VCR or camcorder to the outputs on the rear panel of this recorder.

This enables you to record from this recorder to your VCR or camcorder.

- You can use standard video or S-video cables for the video connection.

Plugging in

After checking all the connections, plug in the recorder.

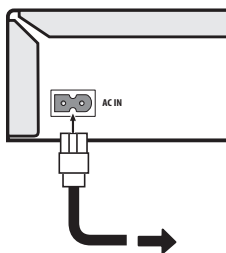

1 Use the supplied power cable to connect this recorder to a power outlet.

Chapter 3 Controls and displays

Front panel

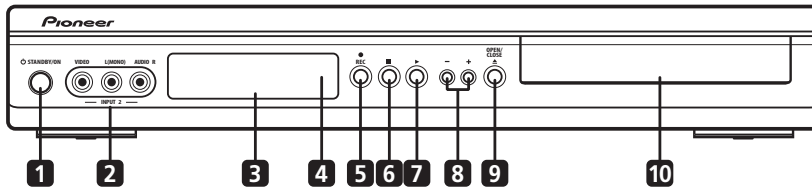

1 **STANDBY/ON**

Press to switch the recorder on/into standby.

2 **Front panel inputs** (page 10)

Audio/video inputs, convenient for connecting a video camera.

3 **Front panel display**

See below for details.

4 **IR remote sensor** (page 8)

5 **REC**

Press to start recording.

6

Press to stop playback or recording.

7

Press to start or restart playback (press while playing to pause playback).

8 **+/-** (page 22, 24)

Use to change TV channels, skip chapters/tracks, etc.

9 **OPEN/CLOSE**

Press to open/close the disc tray.

10 **Disc tray**

Display

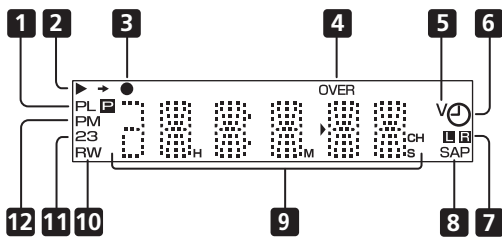

1 **PL**

Lights when a PlayList is playing (only applicable to some VR mode discs recorded on other recorders).

(page 49)

Lights when the component video output is set to progressive scan.

2

Lights during playback; blinks when paused.

3

Lights during recording; blinks when recording is paused.

4 **OVER** (page 51)

Lights when the analog audio input level is too high.

5 **V**

Lights when an unfinalized Video mode disc is loaded.

6 (page 35)

Lights when a timer recording has been set. (Indicator blinks if the timer has been set but there isn't a recordable disc loaded.)

7 (page 51)

Indicates which channels are recorded when Dual Mono is selected.

8 **SAP** (page 23)

Lights when the currently selected TV channel has a Second Audio Program channel.

9 **Character display**

Shows disc time information, channel number, messages, and so on.

10 **R / RW**

Indicates the type of recordable DVD loaded: DVD-R or DVD-RW.

11 2 3 (page 48)

Shows the remote control mode (if nothing is displayed, the remote control mode is 1).

12 PM

Lights to indicate PM (after midday) for the clock display.

Remote control

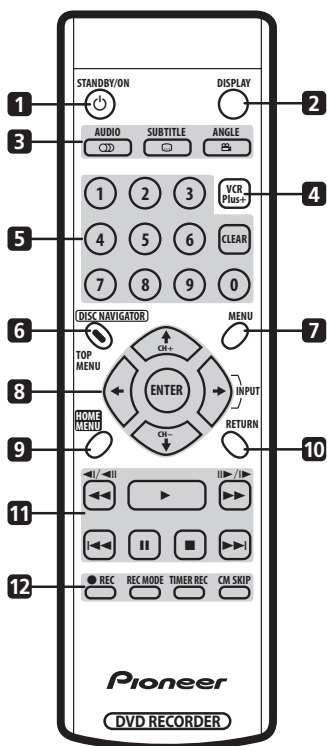
**1** **STANDBY/ON**

Press to switch the recorder on/into standby.

2 **DISPLAY**

Displays/changes the on-screen information displays.

3 **DVD playback functions****AUDIO** (page 23, 31, 32)

Changes the audio language or channel. (When the recorder is stopped, press to change the tuner audio.)

SUBTITLE (page 31)

Displays/changes the subtitles included in multilingual DVD-Video discs.

ANGLE (page 32)

Switches camera angles on discs with multi-angle scenes.

4 **VCR Plus+**

Press, then use the number buttons to enter a PlusCode® programming number for a timer recording.

5 **Number buttons, CLEAR**

Use the number buttons for track/chapter/title selection; channel selection, and so on.

Use **CLEAR** to clear an entry and start again.

6 **DISC NAVIGATOR, TOP MENU**

Press to display the Disc Navigator, or the 'top menu' when a DVD-Video disc is loaded.

7 **MENU** (page 24)

Press to display the menu of a DVD-Video disc.

8 **↑/↓/←/→ (cursor buttons), CH +/-, ENTER**

Used to navigate all on-screen displays. Press **ENTER** to select the currently highlighted option. The **→** (cursor right) button is also used to change the recording input.

Use the **CH +/-** buttons to change the channel of the built-in TV tuner.

9 **HOME MENU**

Press to display the Home Menu, from which you can navigate all the functions of the recorder.

10 **RETURN**

Press to go back one level in the on-screen menu or display.

11 **Playback and recording controls** (page 23)**◀◀ / ▶▶** (page 28)

Press to start reverse or forward scanning. Press again to change the speed.



Press to start playback.



Press to pause playback or recording.



Press to stop playback or recording.

◀◀ / ▶▶

Press to skip to the previous or next title/chapter/track; or to display the previous or next menu page.

◀◀ / ▶▶ (page 29)

While paused, press to show the previous or next video frame; press and hold to start slow-motion playback.

12 **● REC** (page 22)

Press to start recording. Press repeatedly to set the recording time in blocks of 30 mins.

REC MODE

Press repeatedly to change the recording mode (picture quality).

TIMER REC

Press to set a timer recording from the standard Timer Recording screen.

CM SKIP

Press repeatedly to skip progressively forward through the audio or video playing.

Chapter 4

Getting started

Switching on and setting up

When you switch the recorder on for the first time, you can make several basic settings using the Setup Navigator. This takes you through setting the clock and the internal TV tuner settings.

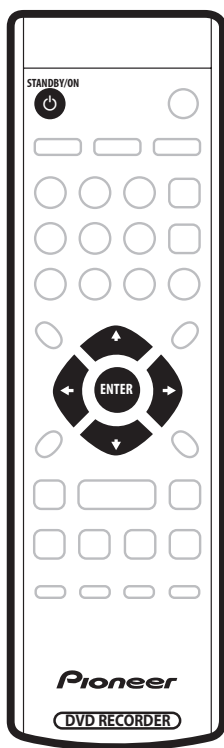

If you're using the recorder for the first time, we strongly recommend you use the Setup Navigator before starting to use the recorder.



1 Switch on your TV and set the video input to this recorder.

2 Press the  STANDBY/ON button on the remote control or the front panel to switch on.

When you switch on for the first time, your TV should display the Setup Navigator screen. (If the Setup Navigator doesn't appear, you can also access it from the Initial Setup menu; see page 45).



3 Use the / (cursor left/right) buttons to select English, French or Spanish as the on-screen display (OSD) language, then press ENTER.

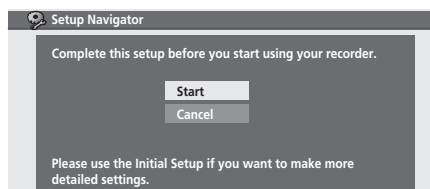

4 Press ENTER again to start setting up using the Setup Navigator.



• If you don't want to use the Setup Navigator, press  (cursor down) to select **Cancel**, then press **ENTER** to exit the Setup Navigator.

5 Use the / (cursor up/down) buttons to select 'Antenna' or 'Cable' depending on how you receive your terrestrial TV channels, then press ENTER.

You can also select **Do not set** if you don't need the recorder to retune all the channels (if you're using the Setup Navigator for a second time, for example).



After selecting **Antenna** or **Cable** the recorder starts automatic tuning. This takes a couple of minutes to complete.

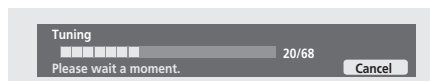

- 6 Use the **↑/↓** (cursor up/down) buttons to select 'Auto' or 'Manual' clock setting, then press **ENTER**.

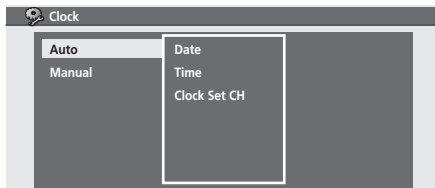

- **Auto clock setting**

Some TV channels broadcast time signals together with the program. This recorder can use these signals to set the clock automatically.

Use the **←/→** (cursor left/right) buttons to set 'Clock Set CH' to the channel preset number that broadcasts a time signal, then move the cursor down to 'Start' and press **ENTER**.

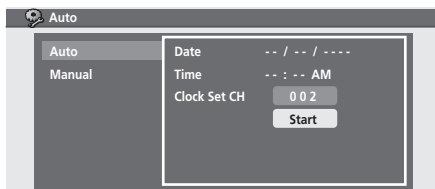

The recorder takes a short while to set the time. After you see that the time has been set, select **Next** to proceed.

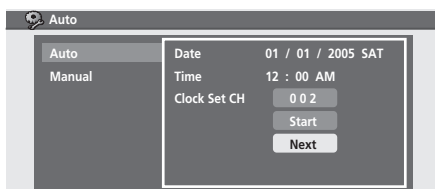

If the time could not be set automatically, press **RETURN** to go back to the previous screen and select **Manual**.

- **Manual clock setting**

If no stations in your area are broadcasting time signals, you can set the clock manually.

Use the **←/→** (cursor left/right) buttons to set your time zone.

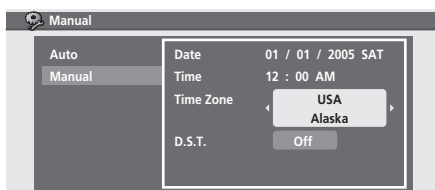

Press **↓** (cursor down) then use the **←/→** (cursor left/right) buttons to set D.S.T. to On or Off, then press **ENTER**.

Select **On** if you are currently using daylight saving time.

Set the current date and time.

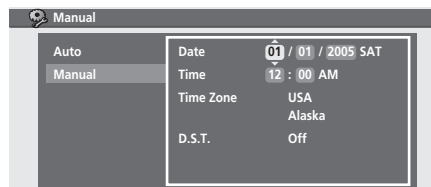

- Use the **↑/↓** (cursor up/down) buttons to change the value in the highlighted field.
- Use the **←/→** (cursor left/right) buttons to move from one field to another.
- Press **ENTER** to finish setting the time.

7 **That's it! Press ENTER to finish setting up.**

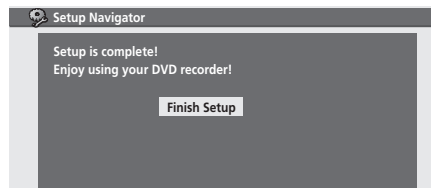

Other settings you can make

After setting up using the Setup Navigator, you should be ready to start enjoying your DVD recorder. It's possible, however, that you may want to make a couple of additional settings, depending on how the recorder is set up for TV broadcasts.

- **Manual channel setting** – This setting lets you skip channels where there is no station, as well as manually tune to stations. See *Manual CH Setup* on page 47.
- **VCR Plus+ channel setting** – This setting lets you assign guide channels to ensure that the VCR Plus+ programming system works correctly. See *Guide CH Setup* on page 47.

Making your first recording

This quick guide shows you how to make a basic recording of a TV program to a recordable DVD.

Recording is covered in much more detail in chapter 6 (*Recording*).

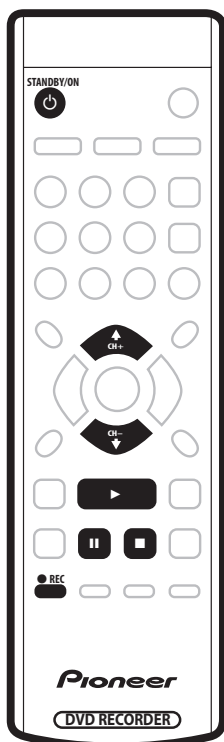

1 If they aren't already on, switch on your TV and this recorder.

Press **STANDBY/ON** to switch on.

- Make sure that the video input on your TV is set to this recorder.

2 Press **▲ OPEN/CLOSE** (front panel only) to open the disc tray.

3 Load a blank DVD-R or DVD-RW disc with the label side face-up, using the disc tray guide to align the disc.

- When you load a new, blank DVD-RW disc, the recorder will take a moment to initialize it for recording.

4 Use the **CH +/-** buttons to select the TV channel you want to record from.

- You can also use the **+/-** buttons on the front panel if the recorder is stopped.

- Antenna channels are numbered 2 through 69. Cable channels are numbered 1 through 125.

5 Press **● REC** to start recording.

- By default, the recording will be in **SP** (standard play) mode, which will give you around two hours of recording from a blank DVD disc. The different recording mode and their recommended uses are covered in mode detail in Chapter 6.
- You can pause recording by pressing **||**. Press **● REC** or **||** again to restart recording.

6 When you want to stop recording, press **■**.

Playing back your recording

The TV program you just recorded should be on the DVD disc as a single title with one or more chapters.

- Press **▶** to start playback.

If you want to stop playback before the end of the recording, press **■**.

Using the built-in TV tuner

Changing TV channels

There are three different ways to select TV channels. Note that you can't change the TV channel during playback, recording or during recording standby.

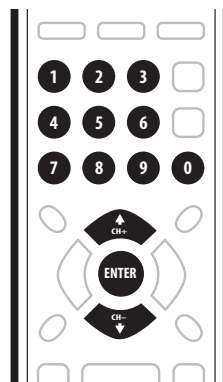

- **CH +/-** buttons on the remote
- **Number buttons** on the remote – For example, to select channel 4, press **4** then **ENTER**; for channel 34, press **3, 4, ENTER**; for channel 102, press **1, 0, 2, ENTER**. (If you don't press **ENTER**, the channel changes after a few seconds.)
- **+/-** buttons on the front panel

Note

- Antenna channels are numbered 2 through 69. Cable channels are numbered 1 through 125.

Changing audio channels

Some TV programs are broadcast with both a main and a Second Audio Program (SAP). You can change the TV audio using the **AUDIO** button.

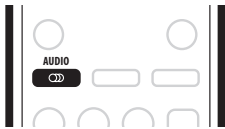

- **Press AUDIO to change the TV audio.**
The current audio channel is displayed on-screen.

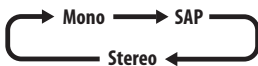

- If **SAP** is selected, but there is no SAP channel being broadcast, you will still hear the main audio channel.
- If the sound is poor quality when set to **Stereo**, you can often improve it by changing to **Mono**.

Basic playback

This section shows you how to use your recorder for playback of discs (DVD, CD, etc.). More playback features, such as repeat play, are covered in the next chapter.

Important

- Throughout this manual, the term 'DVD' means playback-only DVD-Video discs and DVD-R/RW. If a function is specific to a particular kind of DVD disc, it is specified.
- Some DVD-Video discs don't allow certain playback controls to operate at certain points in the disc. This is not a malfunction.
- VR mode discs recorded on another DVD recorder may contain a Playlist of titles. These can be found after the Original titles on the disc. See also *Using the Disc Navigator to browse the contents of a disc* on page 27.

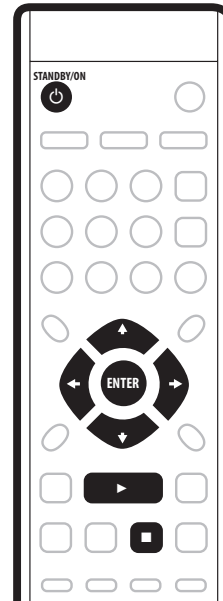
**1 Press  STANDBY/ON to switch on.**



Also turn on your TV and make sure that it is set to the correct video input.

2 Press  OPEN/CLOSE (front panel only) to open the disc tray.**3 Load a disc.**

Load a disc with the label side facing up, using the disc tray guide to align the disc (if you're loading a double-sided DVD-Video disc, load it with the side you want to play face down).

- If you want to play a DTS audio CD, please first read the note on page 24.
- Please see *Disc / content format playback compatibility* on page 8 if you want to play a Dual Disc (DVD/CD hybrid disc).

4 Press  to start playback.

- If you're playing a DVD-Video or Video CD, a disc menu may appear when you start playback. Use the / (cursor) buttons and **ENTER** to navigate DVD disc menus, and the number buttons and **ENTER** for Video CD menus.
- See the following sections for more details on playing specific kinds of discs.

5 To stop playback, press .**6 When you've finished using the recorder, eject the disc and switch the recorder back into standby.**

- To open/close the disc tray, press  **OPEN/CLOSE**. Remove the disc before putting the recorder into standby.



- Press **STANDBY/ON** to switch the recorder into standby.



Playing DVD discs



The table below shows the basic playback controls for DVD-Video, and recordable DVD discs.

 Press to start or restart playback. If **RESUME** is displayed on-screen, playback starts from the place last stopped.

 Press to pause playback; press again to restart playback.

 Press to stop playback. You can resume playback from the same point by pressing . (Press  again to cancel the resume function.)

  • During playback, press to start scanning. Press repeatedly to increase the scanning speed.
• Press and hold while paused to start slow-motion playback. Press repeatedly to change the playback speed.
• While paused, press to advance a single frame in either direction.



  Press to skip to previous/next chapter/title. (You can also use the front panel **+/-** buttons to do this during playback.)

 (Commercial skip). Each press skips forward progressively up to a maximum of ten minutes.

 • *Except VR mode:* during playback, enter a chapter number then press **ENTER** to skip directly to that chapter within the currently playing title.

On some discs, you can also use the number buttons to select numbered items in the disc menu.

- *VR mode only:* during playback, enter a title number then press **ENTER**.
- *All:* Press **CLEAR** to clear a number entry and start again.

  Press to display the 'top' menu or menu of a DVD-Video disc (these are often the same).

 Use the cursor buttons to navigate DVD-Video disc menus; press **ENTER** to select items.

 Press to return to the previous level of a DVD-Video disc menu.



Playing audio CDs



The table below shows the basic playback controls for audio CDs.

 Press to start playback.

 Press to pause playback; press again to restart playback.

 Press to stop playback.

  Press to start scanning. Press again to increase the scanning speed. (There are two scan speeds; the current scan speed is shown on-screen.)

  Press to skip to previous/next track. (You can also use the front panel **+/-** buttons to do this during playback.)

 During playback, enter a track number then press **ENTER** to skip directly to that track.
Press **CLEAR** to clear a number entry and start again.

Note

- If you want to play a DTS audio CD, make sure the recorder is connected to a DTS-compatible amp/receiver with a digital connection. Noise will be output through the analog outputs. Also make sure that **STEREO** is selected using the **AUDIO** button (see *Switching audio channels* on page 32).



Playing Video CDs

The table below shows the basic playback controls for Video CDs.

Some discs feature Playback Control (PBC for short) menus. These discs show PBC in the display when you load them and display a menu on-screen from where you can select what to watch.

 Press to start or restart playback. If **RESUME** is displayed on-screen, playback starts from the place last stopped.

 Press to pause playback; press again to restart playback.

 Press to stop playback. You can resume playback from the same point by pressing . (Press  again to cancel the resume function.)



- During playback, press to start scanning. Press repeatedly to increase the scanning speed.
- Press and hold while paused to start slow-motion playback. Press repeatedly to change the playback speed (forward direction only).
- While paused, press to advance a single frame (forward direction only).



- Press to skip to previous/next track. (You can also use the front panel +/- buttons to do this during playback.)
When a PBC menu is displayed, press to display the previous/next page.



- (Commercial skip) Each press skips forward progressively up to a maximum of ten minutes.



- During playback, enter a track number then press **ENTER** to skip directly to that track.

- Press **CLEAR** to clear a number entry and start again.



- While a PBC menu screen is displayed, use to select numbered menu items.



- Press to display the disc menu of a Video CD playing in PBC mode.



Note

- When playing in PBC mode, some playback features, such as search and repeat play are not available.

Displaying disc information on-screen

You can display various on-screen information about the disc loaded.

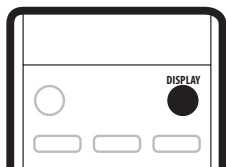

1 Press DISPLAY repeatedly to display/change the on-screen information.

- The on-screen display automatically disappears after 20 minutes.

2 To hide the information display, press DISPLAY repeatedly until it disappears.

The example displays below are a guide only; actual displays vary according to the disc loaded, etc.

Stop display 1



1 Original or PlayList

VR mode DVD-RW discs edited on other DVD recorders may contain Original and PlayList content. (See also the note on page 26 about PlayLists.)

2 Disc type and mode

Shows the disc type (**DVD-VIDEO**, **DVD-R**, **DVD-RW**, **CD**, **No Disk** etc.), and the disc mode for recordable DVD, if applicable (**VR** or **Video**). Note that finalized DVD-R/RW Video mode discs are shown as **DVD-VIDEO**.

Shows **PBC**, if Video CD playback control is on.

3 Current date and time

4 Station call letters or TV channel

Shows the station call letters or TV channel preset for the built-in TV tuner.

5 Audio mode

Shows the broadcast audio mode for the current channel preset (**Mono**, **Stereo**, etc.).

Stop display 2

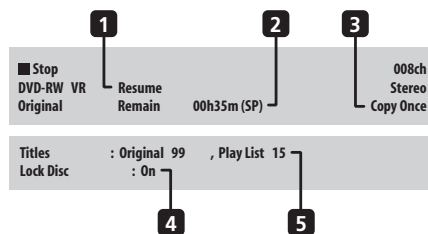

1 Resume

Shows **Resume** if playback can be resumed from the last place stopped.

2 Recording mode and Recording time available

Shows the current recording mode (**XP**, **SP**, **LP**, etc.), and the total recording time available on the disc.

Finalized Video mode DVD-R/RW discs are shown as **DVD-R Finalized** or **DVD-RW Finalized**.

3 Copy control information

Shows recording restrictions.

- 4 Lock Disc On or Off
- 5 Number of titles/tracks on disc

Play display 1

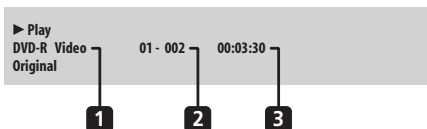

1 Disc type and mode

Shows the disc type (**DVD-R**, **DVD-RW**, **CD**, **No Disk** etc.), and the disc mode for recordable DVD, if applicable (**VR** or **Video**). Shows **PBC** if a Video CD is in playback control (PBC) mode.

2 Current title and chapter number

(For CD/Video CD, shows current track)

3 Elapsed title time

(For CD, shows elapsed track time; for Video CD, shows elapsed disc time.)

Play display 2

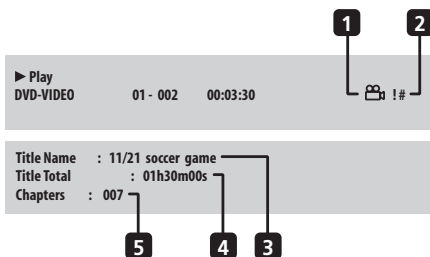

1 Angle indicator

Lights during multi-angle scenes.

2 Copy protected material (!) / PureCinema indicator (#)

Shows '!' if the playback material is copy-once protected.

Shows '#' if the current video is 24 fps, progressive scan.

3 Current title name

4 Total running time of title

5 Total number of chapters in title

Recording display

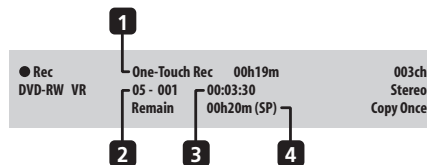

1 Timer recording start and stop time or remaining time of one-touch recording

Shows the start and stop times if the current recording is a timer recording. Shows the remaining recording time if the current recording is the one-touch recording.

2 Current title and chapter number

3 Elapsed recording time

4 Recording mode and Recording time available

Shows the current recording mode (**XP**, **SP**, **LP**, etc.), and the available recording time on the disc.



Note

- The Video mode disc displays become the same as a DVD-Video disc once the disc is finalized.
- The total recording time figure shown in parenthesis is calculated based on a 12cm/4.7GB disc at the displayed record setting.
- Recording and playback times for TV recordings are approximately 0.1% shorter than the actual time. This is because of the slightly different frame rates of TV broadcasts versus DVD.
- This recorder can play PlayLists on discs recorded using other recorders. However, these PlayLists cannot be edited.
- **Copy Once** or **Can't Record** messages may appear in the stop or recording displays. These indicate that the broadcast TV program contains copy control information.

Chapter 5 Playback

Introduction

Most of the features described in this chapter make use of on-screen displays. Navigate these using the **↑/↓/←/→** (cursor buttons) and **ENTER**. To go back one level from any screen, use the **RETURN** button. Remember also that the button guide at the bottom of every screen shows which buttons do what.

Many of the functions covered in this chapter apply to DVD discs, Video CDs and CDs, although the exact operation of some varies slightly with the kind of disc loaded. The following icons are provided to help you quickly identify which instructions you need for which kind of disc.

- DVD** Any kind of DVD, DVD-R or DVD-RW
- DVD-Video** Commercially produced DVD or finalized Video mode DVD-R/RW
- Video mode** Video mode DVD-R/RW (unfinalized)
- VR mode** VR mode DVD-RW
- CD** Audio CD
- Video CD** Video CD

- Some DVD-Video discs don't allow certain playback controls to operate at certain points in the disc. This is not a malfunction.
- When playing Video CDs, some functions are not available in PBC mode.
- Playability of 'DualDisc'
 - The DVD-Audio content on DVD side of a DualDisc cannot be played with this product.
 - The DVD-Video content on DVD side of a DualDisc may or may not be played with this product.
 - Since audio content on 'non-DVD' side of a DualDisc is not compliant with the Compact Disc Digital Audio specification, it may or may not be played with this product.
 - If you need further information about playability of DualDisc, please see 'Service & Support' on the Pioneer web site (www.pioneerelectronics.com)

Using the Disc Navigator to browse the contents of a disc

VR mode **Video mode**

Use the Disc Navigator to browse the contents of a recordable disc and start playback.

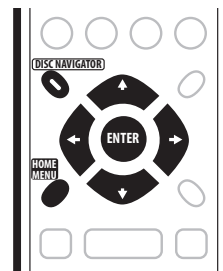

1 Press HOME MENU and select 'Disc Navigator' from the on-screen display.

Alternatively, you can press **DISC NAVIGATOR** to go straight to the Disc Navigator screen.

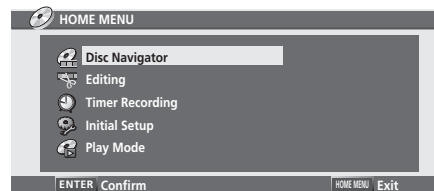

2 Use the **←/→** (cursor left/right) buttons to select a title to play.

- You can also use the front panel **+ / -** buttons.

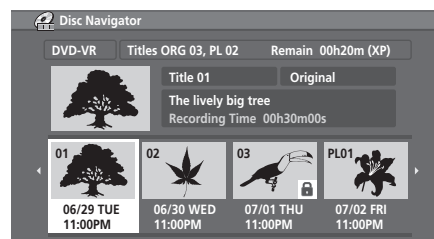

- Some VR mode DVDs recorded on other recorders may have a PlayList of virtual content. PlayList titles appear in the Disc Navigator after the 'Original' titles.

3 Press ENTER to start playback.

Note

- The Disc Navigator is only accessible when there is a disc loaded.
- Another way to find a particular place on a disc is to use the time search mode. See *Search Mode* on page 30.

Navigating discs

ALL

During playback you can easily jump to another title, chapter or track on a disc using the number buttons on the remote.

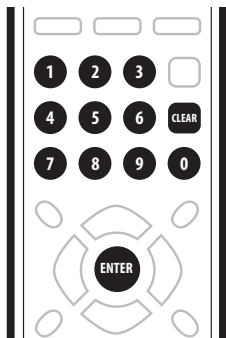

DVD-Video Video mode

1 During playback use the number buttons to enter a chapter number within the current title.

For example, for chapter 6, press **6**; for chapter 24, press **2**, then **4**.

- To clear and start again, press **CLEAR**.

2 Optionally: Press ENTER.

Otherwise, just wait a few seconds and playback will jump to the new chapter.

VR mode

1 During playback, use the number buttons to input a title number.

For example, for title 6, press **6**; for title 24, press **2**, then **4**.

- To clear and start again, press **CLEAR**.

2 Optionally: Press ENTER.

Otherwise, just wait a few seconds and playback will jump to the new title.

CD

Video CD

1 During playback, use the number buttons to input a track number.

For example, for track 6, press **6**; for track 24, press **2**, then **4**.

- To clear and start again, press **CLEAR**.

2 Optionally: Press ENTER.

Otherwise, just wait a few seconds and playback will jump to the new track.

Scanning discs

You can fast scan discs at various speeds, forwards or backward.

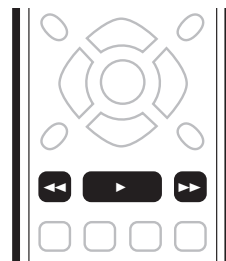
**1 During playback, press ◀ or ▶ to start reverse or forward scanning.**

- The scanning speed is shown on-screen.

2 Press the same button repeatedly to increase the scanning speed.

DVD

Forward:

Scan1 → Scan2 → Scan3 → Scan4

Reverse:

Reverse → Scan1 → Scan2 → Scan3 → Scan4

CD

Video CD

Forward/Reverse:

Scan1 → Scan2

3 To resume normal playback, press ▶.**Note**

- Depending on the disc, reverse playback may not be smooth.
- Sound can be heard while scanning audio CDs (analog output only).
- No subtitles are displayed while scanning DVD-Video discs.

- When scanning DVDs with Dolby Digital or Linear PCM sound on forward **Scan1**, Linear PCM is output from the coaxial digital output. No sound is output when using other scan speeds.
- Depending on the disc, normal playback may automatically resume when a new chapter is reached on a DVD disc.

Playing in slow motion

DVD Video CD

You can play video at various slow motion speeds. DVDs can be played in slow motion in either direction, while Video CDs can only be played forwards in slow motion.

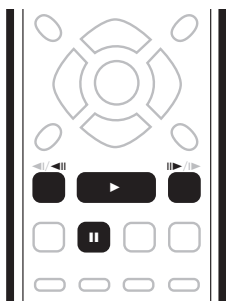

- 1 During playback, press **II PAUSE**.
- 2 Press and hold **◀◀** or **▶▶** until slow motion reverse or forward playback starts.
- 3 Press the same button repeatedly to change the slow motion speed.

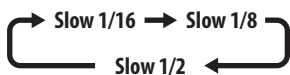

- 4 To resume normal playback, press **▶**.

Note

- Reverse slow-motion playback may not be as smooth as forward and may be better with some discs than others.
- Depending on the disc, normal playback may automatically resume when a new chapter is reached on a DVD disc.
- No sound is output during slow-motion playback.

Frame advance/frame reverse

DVD Video CD

You can step forwards or backwards a frame at a time through a DVD. With Video CDs, you can only use frame advance.

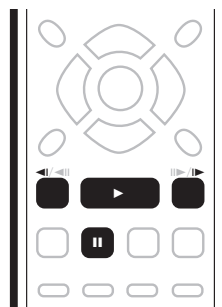

- 1 During playback, press **II PAUSE**.
- 2 Press **◀◀** or **▶▶** to go backwards or forwards one frame.
- 3 To resume normal playback, press **▶**.

Note

- Depending on the disc, normal playback may automatically resume when a new chapter is reached on a DVD disc.

The Play Mode menu

ALL

The Play Mode menu gives you access to search and repeat play functions.



Important

- You can't use the Play Mode features with Video CDs playing in PBC mode, or while a DVD disc menu is being displayed. For other restrictions, see the following sections.

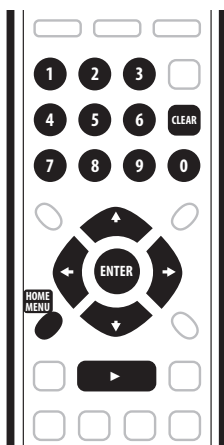

- Press **HOME MENU** and select 'Play Mode'.

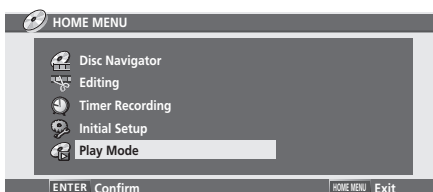

- Use the **↑/↓** (cursor up/down) buttons and **ENTER** to navigate.
 - To exit the Play Mode menu, press **HOME MENU**.

Search Mode

ALL

The Search Mode feature lets you start playback from a specified point in a disc by time or by title/chapter/track number.

- Select 'Search Mode' from the Play Mode menu.
- Select one of the search options.
- Use the number buttons to enter a title/chapter/track number or the search time (in hours, minutes & seconds).

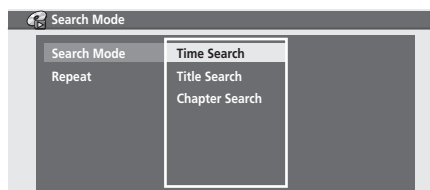

Time Search (DVD): For example, for 25 minutes into the current title, press **2, 5, 0, 0**. For 1 hour and 15 minutes and 20 seconds into the title, press **1, 1, 5, 2, 0**.

Time Search (Video CD): For example, for 45 minutes into the disc, press **4, 5, 0, 0**.

- You can also use the **↑/↓** (cursor up/down) buttons and **ENTER** to input a time.

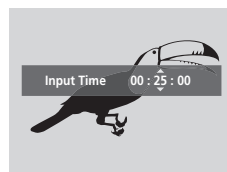

Title/Chapter/Track Search: For example, for track 6, press **6**.

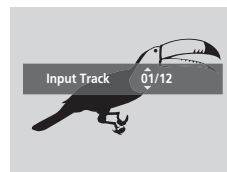

- Press **ENTER**.



Tip

- You can often select what you want to watch on a DVD disc from the disc menu. Press **MENU** or **TOP MENU** to display the disc menu.

Note

- When using time search, playback may occasionally start slightly before or after the time you input.

Repeat play

ALL

There are various repeat play options, depending on the kind of disc loaded.

1 Select 'Repeat' from the Play Mode menu.



2 Use the ↑/↓ (cursor up/down) buttons to select a repeat play mode.

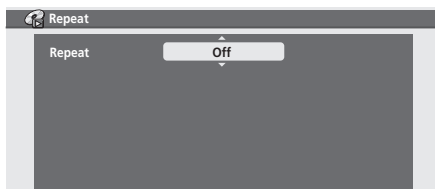

VR mode

- For VR mode DVD discs, select **Disc**, **Title** or **Chapter** (or **Off**).

DVD-Video Video mode

- For DVD-Video and Video mode DVD discs, select **Title** or **Chapter** (or **Off**).

CD Video CD

- For CDs and Video CDs, select **Disc** or **Track** (or **Off**).

3 To resume normal playback, select 'Off' from the Repeat Play menu.

Displaying and switching subtitles

DVD-Video

Some DVD discs have subtitles in one or more languages, which you can switch during playback. Check the disc packaging for details of the subtitle options.

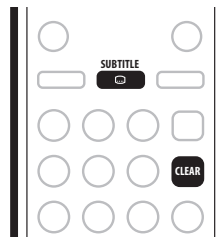

1 Press SUBTITLE repeatedly to select a subtitle option.

The current subtitle language is shown on-screen.

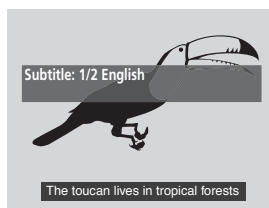

2 To switch off subtitles, press SUBTITLE repeatedly until 'Off' is displayed.

Note

- Some discs only allow you to change subtitle language from the disc menu. Press **TOP MENU** to access.
- To set subtitle preferences, see *Language* on page 54.

Switching DVD soundtracks

DVD-Video

When playing a DVD disc recorded with two or more soundtracks (often in different languages), you can switch the soundtrack during playback.

Check the disc packaging for details of the soundtrack options.

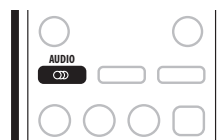

- Press **AUDIO** repeatedly to select an audio soundtrack.

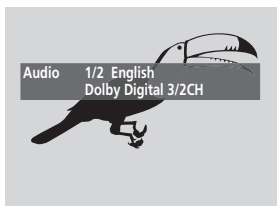

Note

- The sound may drop out momentarily when switching soundtracks.
- Some discs only allow you to change audio language from the disc menu. Press **TOP MENU** to access.
- To set audio language preferences, see *Language* on page 54.
- Some discs feature both Dolby Digital and DTS soundtracks. There is no analog audio output when DTS is selected. To listen to the DTS soundtrack, connect this recorder to a DTS decoder or AV amp/receiver with built-in DTS decoder via the digital output. See *Connecting to an AV amplifier or receiver* on page 15 for connection details.

Switching audio channels

VR mode CD Video CD

For VR mode content that has both a main and a SAP (Secondary Audio Program) audio channel, you can switch between main (L), SAP (R), or both (L+R).

When playing Video CDs and audio CDs you can switch between stereo, just the left channel or just the right channel.

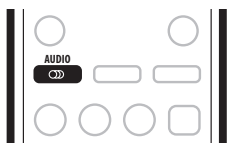

- 1 To display/switch the audio channel, press **AUDIO** repeatedly.

The audio channel(s) currently playing are indicated on-screen.

VR mode

- **L+R** – Both channels (default)
- **L** – Left/main channel only
- **R** – Right/SAP channel only

CD Video CD

- **Stereo** – Stereo (default)
- **1/L** – Left channel only
- **2/R** – Right channel only

Note

- When playing a Dual Mono recording on a VR mode disc, if you are listening to the Dolby Digital soundtrack via the digital output, you cannot switch the audio channel. Set **Dolby Digital** to **Dolby Digital -> PCM** (see *Audio Out* on page 51) or listen via the analog outputs if you need to switch the audio channel.

Switching camera angles

DVD-Video

Some DVD-Video discs feature scenes shot from two or more angles—check the disc box for details: it should be marked with a  icon if it contains multi-angle scenes. When a multi-angle scene is playing, the same icon appears on screen to let you know that other angles are available.

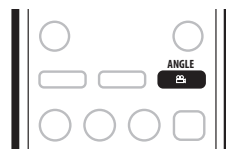

- To switch the camera angle, press **ANGLE**.
- The angle number is displayed on-screen.
- If the disc was paused, playback starts again with the new angle.

Note

- You can also change the angle from some DVD-Video disc menus. Press **TOP MENU** to access.

Chapter 6

Recording

About DVD recording

This recorder can record on both DVD-R and DVD-RW media. The main difference between the two is that DVD-R discs can only be recorded once, while DVD-RW can be recorded, erased and re-recorded many times.

A further difference between the two disc types is that only DVD-RW can be initialized for *VR mode* recording, which offers much more comprehensive editing functions compared to *Video mode* recording.

The big advantage, however, of Video mode is its compatibility with standard DVD players, most of which will not play VR mode DVD-RW discs (see also the notes below).

While DVD-R discs can only be recorded using the Video mode, you can initialize a DVD-RW disc for Video or VR mode recordings. Once initialized (any previous content is erased in this operation), all recordings on that disc will be in the chosen recording mode.



Important

- You cannot play, edit or record on unfinalized DVD-R/RW discs recorded in Video mode on other DVD recorders. (Likewise, unfinalized Video mode discs recorded on this recorder are not playable on other players/recorders.)
- This recorder cannot record onto CD-R or CD-RW discs.
- Pioneer takes no responsibility for recording failure due to power cuts, defective discs, or damage to the recorder.
- Fingerprints, dirt and small scratches on a disc can affect playback and/or recording performance. Please take proper care of your discs.



Note

- Some DVD players, such as some Pioneer models, are compatible with VR mode DVD-RW discs. Check the operating instructions for your player for VR mode compatibility information.
- The maximum number of titles that can be recorded on a DVD-R/RW disc is 99.
- The maximum number of chapters recordable on a DVD-R/RW disc is 999.

Recording time and picture quality

There are six preset recording quality modes:

- **XP** – Highest quality setting, gives about one hour of recording time.
- **SP** (Standard Play) – Default quality, used for most applications, gives about two hours of recording time.
- **LP** (Long Play) – Lower video quality than **SP**, but doubles the recording time to about four hours.
- **EP** (Extended Play) – Lower video quality than **LP**, but this gives about six hours of recording time.
- **SLP** (Super Long Play) – Lower video quality than **EP**, but this gives about eight hours of recording time.
- **SEP** (Super Extended Play) – Lowest video quality, but gives about ten hours of recording time.

Please note that there is a trade-off between recording time and quality. The longer the possible recording time, the lower the recorded picture quality. You may wish to try recording different kinds of program in different modes to determine the combination of picture quality and recording time that suits your needs.

We recommend that the **XP** mode be used for recording fast moving or action programs.

In all except the **XP** mode, sound is recorded in two channel Dolby Digital format. When set to **XP**, sound is recorded in high quality, uncompressed Linear PCM format.

If the broadcast audio has a SAP channel and you are recording in Video mode, or in VR mode on the **XP** setting, use the **AUDIO** button to select the **Mono**, **Stereo** or **SAP** audio channel to record before recording starts.



Note

- Note that all recording times (both here and those shown by the recorder) are only approximate. This is because of the way that the video is recorded; you may get slightly more or slightly less, depending on what you're recording.

Restrictions on video recording

- You cannot record copy-protected video using this recorder. Copy-protected video includes DVD-Video discs and some satellite broadcasts. If copy-protected material is encountered during a recording, recording will pause automatically and an error message will be displayed on-screen.
- Video that is 'copy-once only' can only be recorded on a DVD-RW disc in VR mode (see below).
- When recording a TV broadcast or through an external input, you can display copy control information on screen. (see *Displaying disc information on-screen* on page 25).

CPRM

CPRM is a copy protection system with scramble system regarding the recording of 'copy once' broadcast programs. CPRM stands for *Content Protection for Recordable Media*.

This recorder is CPRM compatible, which means that you can record copy-once broadcast programs, but you cannot then make a copy of those recordings. CPRM recordings can only be made on CPRM-compatible DVD-RW (ver. 1.1 or higher) discs formatted in VR mode.

DVD CPRM recordings can only be played on players that are specifically compatible with CPRM.

Recording equipment and copyright

You may use this product only to reproduce or copy materials for which you own the copyright or have obtained permission to copy from the copyright owner or for which you otherwise have a legal right to reproduce or copy. Unless you own the copyright or have obtained permission from the copyright owner or otherwise have a legal right to reproduce or copy, you may be violating the law, including copyright law, and may be subject to payment of damages and other remedies.

- This product incorporates copyright protection technology that is protected by method claims of certain U. S. patents and other intellectual property rights owned by Macrovision Corporation and other rights owners. Use of this copyright protection technology must be authorized by Macrovision Corporation, and is intended for home and other limited viewing uses only unless otherwise authorized by Macrovision Corporation. Reverse engineering or disassembly is prohibited.

Setting the picture quality/recording time

VR mode Video mode

Before starting a recording, you will usually want to set the picture quality/recording time. There are six standard settings available, which allow you to choose a balance between picture quality and recording time.

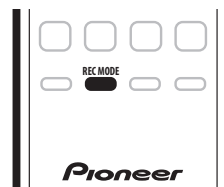

- **Press REC MODE repeatedly to select a recording setting.**

- **XP** – Fine picture quality
- **SP** – Standard play
- **LP** – Long play
- **EP** – Extended play
- **SLP** – Super Long Play
- **SEP** – Super Extended Play

The setting is indicated in the front panel display, and shown on-screen together with the recording time for a blank recordable disc. If a recordable disc is loaded, the approximate remaining recording time for that disc is also shown. (Note that if the On Screen display setting (see *Display* on page 48) is **Off** then this information is not displayed.)

Basic recording from the TV

VR mode Video mode

Follow the instructions below to record a TV program. Recording starts immediately and continues until the disc is full or you stop the recording.

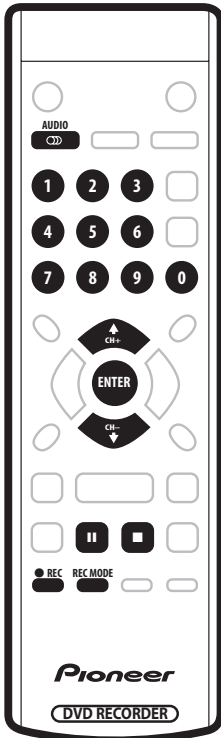

1 Load a recordable disc.

- If you load a new blank DVD-RW disc, the recorder takes a short while to initialize the disc.

2 Use the CH +/- buttons to select the TV channel to record.

The front panel display shows the channel number:



- While the recorder is stopped, you can also use the number buttons on the remote to select the channel. (For channel 6, press **6** then **ENTER**; for channel 24, press **2, 4** then **ENTER**)
- If the recorder is stopped, you can also use the +/- buttons on the front panel to select the channel number.

3 Use the REC MODE button to set the picture quality/recording time.

- See *Setting the picture quality/recording time* above for detailed instructions.

4 If the broadcast audio has a SAP channel (Second Audio Program), press AUDIO to select the audio channel to record.

Press repeatedly to switch between **Mono**, **Stereo** and **SAP** audio channels.

- When recording in VR mode, both mono and SAP audio channels are recorded, allowing you to switch the audio channel on playback. The only exception to this is when the picture quality is set to **XP**, in which case you do need to select the audio channel before recording.

5 Press ● REC to start recording.

If you want to set a recording end time, press the ● **REC** button repeatedly. The recording time increases in 30 minute increments, up to a maximum of ten hours. The time the recording will end is shown on-screen and in the front panel display. When the recording ends, the recorder automatically switches into standby.

- To cancel the set recording time, press ● **REC**.
- If you want to pause recording at any time, press **II**. Press again to restart the recording. (If recording in VR mode, a new chapter is started after recording restarts)

6 To stop the recording, press ■.

- If you set the recording time in the previous step, you can still stop the recording anytime by pressing ■.
- Recording will stop automatically when there is no more space on the DVD.

Setting a timer recording

VR mode Video mode

Using the timer recording features you can program up to 32 timer recordings up to a month in advance. Timer recording programs can be set to record just once, every day, or every week.

You can set the recorder so that it will adjust the recording quality to try and fit the recording on to the disc if it would not otherwise fit at the recording quality you set (see *Optimized Rec* on page 52 for more on this).

Important

- A timer recording can't be set if:
 - There are already 32 timer programs waiting to be recorded.

- Timer recording will not start if:
 - The recorder is already recording.
 - A disc is being initialized, finalized or unfinalized.
- Except when finalizing Video mode discs, timer recording will start when the operation preventing timer recording has finished.
- If a disc is playing when a timer recording is due to start, playback will automatically stop to allow the recording to start.
- The timer indicator lights in the front panel display when the timer is active. If the indicator is blinking it means that there is no disc loaded, or the disc loaded is not recordable.
- Approximately two minutes before a timer recording is set to start, the recorder will go into timer recording standby (assuming that a recordable disc is loaded). In timer recording standby you cannot use some functions.

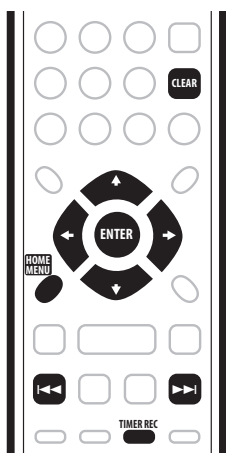

1 Press TIMER REC then select 'Timer Rec (View)' to display the Timer Recording screen.



- You can also access the Timer Recording screen from the Home Menu (press **HOME MENU**, select **Timer Recording**, then **Timer Rec (View)**).

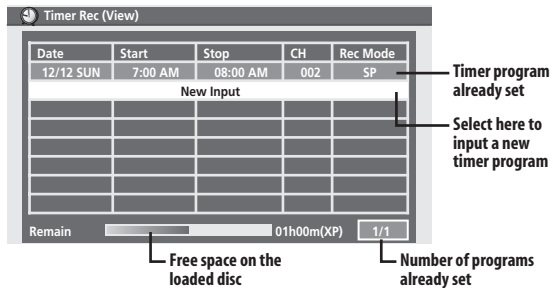

- If there are more than eight timer programs already set, press **▶▶** to switch page (go back using the **◀◀** button).
- You can also clear a timer program before it's started by highlighting it and pressing **CLEAR**.

2 Select 'New Input' to set a new timer program, then press ENTER.

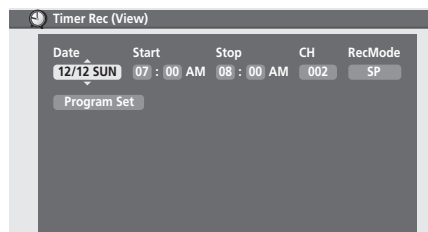

3 Enter the timer recording settings.

Use the **◀/▶** buttons to select a field; use the **↑/↓** buttons to change the value.

- **Date** – Choose a date up to one month in advance, or select a daily or weekly program.
- **Start** – Set the recording start time.
- **Stop** – Set the recording end time (maximum length of a timer recording is 10 hours).
- **CH** – Choose a channel (2–69 or 1–125 for antenna or cable channels respectively, excluding skip channels), or one of the external inputs from which to record.
- **RecMode** – Select **XP**, **SP**, **LP**, **EP**, **SLP** or **SEP** (See *Recording time and picture quality* on page 33).

4 After entering all the timer recording information, highlight 'Program Set' and press ENTER.

The timer recording list screen is displayed again. The timer program you just input appears in the list.

5 To exit the timer recording screen, press HOME MENU.

- If you change the **Auto Channel Setting** (from cable to antenna or the other way around), existing timer programs will be erased.

Timer recording using the VCR Plus+® programming system

This system makes programming timer recordings very simple. Most TV guides publish PlusCode numbers with their program details. If you want to make a timer recording of a program, you just input the corresponding code. The date, start, stop and channel settings are made automatically. All you have to do is tell the recorder the recording mode, and whether it's a once-only recording or a regular recording.

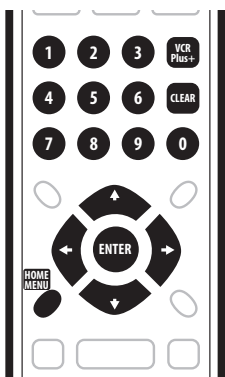

1 Press 'VCR Plus+' to display the VCR Plus+ program screen.

You can also access this screen from the Home Menu (press **HOME MENU**, select **Timer Recording**, then **VCR Plus+**).

2 Use the number buttons to enter a PlusCode number, then press ENTER.

To clear the last digit entered, press **CLEAR**.

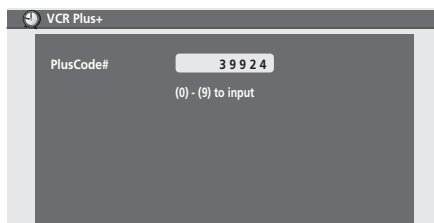

3 If you want to change the recording quality, use the ←/→ buttons to highlight Rec Mode, then use the ↑/↓ buttons to change.

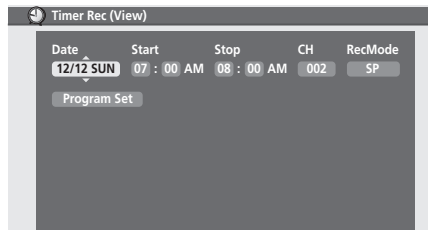

- See also *Recording time and picture quality* on page 33 and *Setting the picture quality/recording time* on page 34.

4 After making the settings, press ENTER.

- If you haven't set up the guide channels (or at least the guide channel for the PlusCode number that you entered), the recorder will prompt you to enter the channel number that the TV program is showing on.



Tip

- You can check the timer program settings by pressing **TIMER REC** to display the timer recording screen.

Extending a timer recording in progress

You can extend a timer recording beyond the programmed end time in two different ways. This can be useful if a broadcast program overruns, for example.

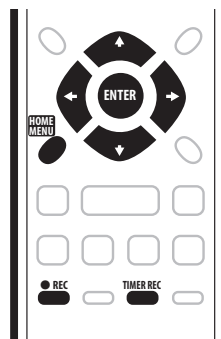

Moving the end time by 30-minute blocks

1 During timer recording, press and hold ● REC for three seconds.

The timer indicator disappears from the front panel display.

- 2 Press ● REC repeatedly to extend recording in 30 minute increments.

Programming a new end time

- 1 During timer recording, press **TIMER REC** to display the **Timer Recording** screen.

You can also access the Timer Recording screen from the Home Menu (press **HOME MENU**, select **Timer Recording**, then **Timer Rec (View)**).

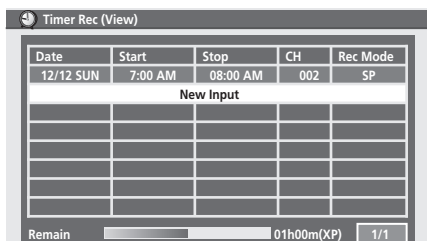

- 2 Use the **↑** button to highlight the current timer recording, then press **ENTER**. A screen showing details of the timer recording appears. From this screen, only the recording stop time can be changed.

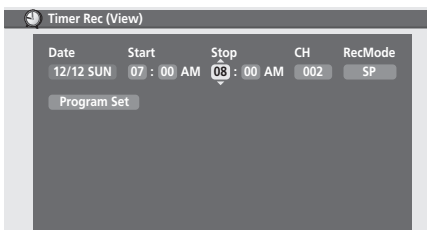

- 3 Set a new **Stop** time for the timer recording. Use the **←/→** buttons to select the hour or minute field, then use the **↑/↓** buttons to change the time.
- 4 Press **ENTER** to set the new time and exit the screen. Recording will continue until the new stop time is reached.

Canceling and stopping a timer recording in progress

After a timer recording has started, you can cancel the program (but continue recording), or stop recording completely if you need to.

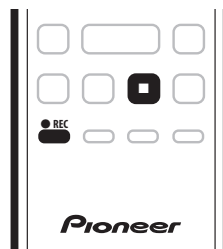

- 1 During timer recording, press and hold ● REC for three seconds.

Only the program is canceled (the timer indicator disappears); recording continues so that you can manually stop recording whenever you like.

- 2 When you want to stop recording completely, press ■.

Preventing use of the recorder before a timer recording (child lock)

You can make all the front panel and remote control buttons inoperative using the child lock feature. This is useful when you set a timer recording and want to make sure that the timer settings are not changed before recording has finished.

- 1 If the recorder is on, switch it into standby.
- 2 Press and hold ■ on the front panel for three seconds to lock the controls.

The front panel display briefly shows **LOCK**. If any buttons are pressed on the remote or front panel, **LOCK** is briefly displayed again.

- To unlock the recorder, press and hold ■ on the front panel for three seconds until the display shows **UNLOCK**.
- To cancel a timer recording when the recorder is locked, first unlock the recorder (see above), then press and hold ● REC for three seconds.

Timer recording FAQ



Frequently Asked Questions

- *Even though the timer is set, the recorder doesn't start recording!*
Check that the disc loaded is recordable, not locked (see *Lock Disc* on page 49), and that there are fewer than 99 titles already on the DVD.
- *The recorder won't let me enter a timer program! Why not?*
You can't enter a timer program if the clock isn't set.

- *What happens when two or more timer programs overlap?*

Basically, the program with the earlier recording start time has priority. However, the recorder will start recording the program with the later start time after the earlier program is finished. If two programs have the same times (but different channels, for example), the program set most recently takes priority.

Recording from an external component

VR mode **Video mode**

You can record from an external component, such as a camcorder or VCR, connected to one of the recorder's external inputs.

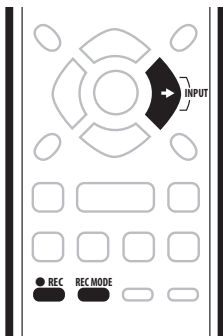

- 1 **Make sure that the component you want to record from is connected properly to the DVD recorder.**

See Chapter 2 (*Connecting up*) for connection options.

- 2 **Press INPUT repeatedly to select one of the external inputs to record from.**

There are two analog inputs. The current input is shown on-screen and in the front panel display:

- **L1** – Input 1
- **L2** – Input 2 (front panel)

Check that the **Audio In** setting for **Dual Mono Recording** is as you want it (see *Audio In* on page 51).

- If the aspect ratio is distorted (squashed or stretched), adjust on the source component or your TV before recording.

- 3 **Set up the recorder.**

- Use **REC MODE** to set the recording quality. See *Setting the picture quality/recording time* on page 34 for detailed information.

- 4 **Press ● REC when you're ready to start recording.**

Note

- If your source is copy-protected using CopyGuard, you will not be able to record it. See *Restrictions on video recording* on page 34 for more details.

Playing your recordings on other DVD players

VR mode **Video mode**

Most regular DVD players can play finalized discs recorded in Video mode. A number of players (including many Pioneer models) can also play DVD-RW discs recorded in VR mode, finalized or not. Check the manual that came with the player to check what kinds of discs it will play.

When you finalize a Video mode disc, a title menu is created from which you can select titles when you play the disc. These menus are navigated in the usual way, pressing **MENU** or **TOP MENU** to display the menu, then using the **↑/↓/←/→** (cursor buttons) followed by **ENTER** to select titles and start playback.

Finalizing a disc

VR mode **Video mode**

Finalizing 'fixes' the recordings in place so that the disc can be played on a regular DVD player or computer equipped with a suitable DVD-ROM drive.

Important

- Once you've finalized a disc recorded in Video mode, you can't edit or record anything else on that disc. However, the finalization on a DVD-RW disc maybe 'undone'; see *Undo Finalize* on page 49 for how to do this.
- A VR mode disc can still be recorded and edited on this recorder even after finalizing.

- 1 **Load the disc you want to finalize.**

Make sure that the recorder is stopped before proceeding.

- 2 **Press HOME MENU and select 'Initial Setup'.**

- 3 **Press ↓ to select 'Disc'.**

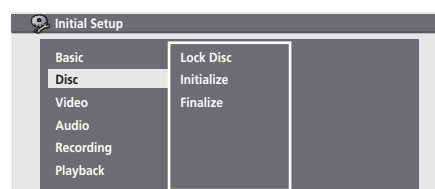

4 Select 'Finalize'.

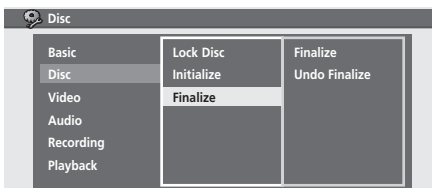

5 Select Finalize 'Start'.



6 Video mode only: All the titles on the disc are displayed.

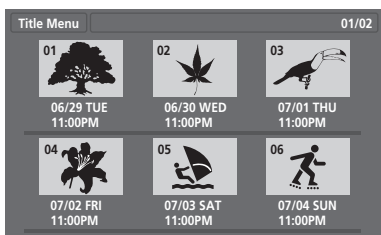

7 The recorder will now start finalizing the disc. during finalization:



- How long finalization takes depends on the type of disc, how much is recorded on the disc and the number of titles on the disc. A disc recorded in VR mode can take up to one hour to finalize. A disc recorded in Video mode can take up to 20 minutes.

Initializing a DVD-RW disc

DVD-RW

When you first load a blank disc, the recorder will initialize it automatically for recording. You can also manually initialize DVD-RW discs.

You can initialize a disc for either Video mode recording or VR mode recording.



Important

- Initializing a disc will erase everything recorded on it. Make sure there is nothing on the disc that you want to keep!
- You may not be able to re-initialize a disc in a different format if it was originally initialized on an older DVD recorder.

1 Press HOME MENU and select 'Initial Setup'.

2 Press ↓ to select 'Disc'.

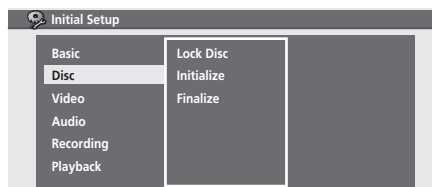

3 Select 'Initialize'

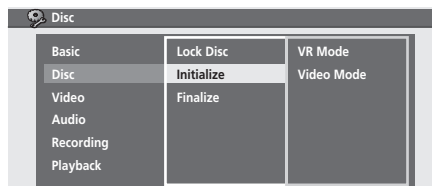

4 Select 'Video Mode' or 'VR Mode' from the initialize options.



5 Select 'Start'.

It takes about 30 seconds to initialize the disc.

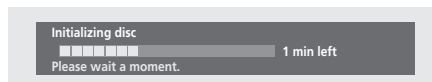

Note

- By default, the recorder initializes blank DVD-RW discs for VR mode recording. See *DVD-RW Auto Init* on page 52 if you want to change the default to Video mode.
- If a disc was previously finalized on an older DVD recorder, you may not be able to re-initialize and/or initialize it for Video mode recording.

Chapter 7 Editing

Using this recorder you can edit video content on unfinalized Video mode and VR mode DVD discs. More detailed editing is possible on VR mode discs, which can be edited at the chapter level. Video mode discs can only be edited at the title level.

Once a Video mode disc has been finalized, further editing is not possible.

1 Press HOME MENU and select 'Editing' from the on-screen display.

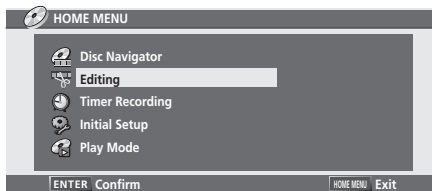

2 Use the ↑/↓ buttons to select 'Title Edit' or 'Chapter Edit' from the Editing menu.

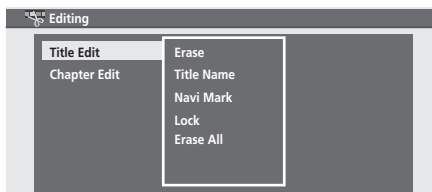

The following title editing functions are available:

- **Erase** – Erase a title (page 41)
- **Title Name** – Name or rename a title (page 42)
- **Navi Mark** (VR mode only) – Change the thumbnail image of a title (page 42)
- **Lock** (VR mode only) – Lock or unlock a title to prevent accidental changes being made (page 43)
- **Erase All** – Erase all titles (page 43)

The following chapter editing functions are available for VR mode discs only:

- **Erase** – Erase a chapter (page 43)
- **Divide** – Divide a chapter into two new chapters (page 44)
- **Combine** – Combine two chapters into one (page 44)

Editing Titles (Title Edit)

Erase

VR mode **Video mode**

Use this command to erase individual titles from a disc.

When erasing Original content from a VR mode DVD-RW, the available recording time will increase as titles are erased. Erasing a title from a Video mode DVD-RW disc increases the available recording time only if it is the last title on the disc.

Since DVD-R is not erasable/rewritable, erased titles do not free up space on the disc, even though they are not visible anymore.

1 Select 'Erase' from the Title Edit menu options.

2 Use the ←/→ buttons to select the title you want to erase, then press ENTER.

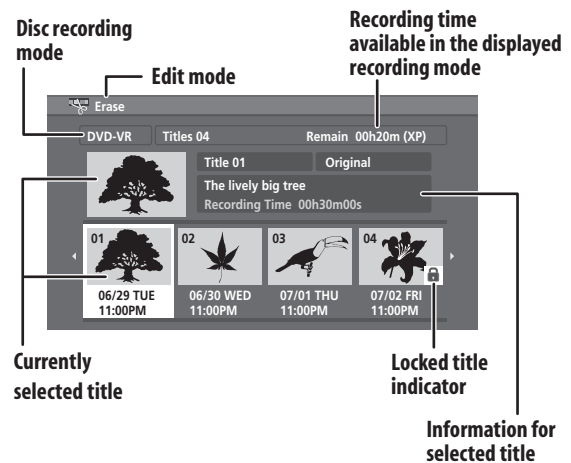

3 Highlight 'Yes' to confirm, or 'No' to cancel, then press ENTER.

When the last title is erased, you will automatically be taken back to the Home Menu.

4 Press RETURN to go back to the Title Edit menu options, or select another title to erase.

Title Name

VR mode Video mode

You can give titles names up to 64 characters long for VR mode recordings and 32 characters for Video mode recordings.

- 1 Select 'Title Name' from the Title Edit menu options.
- 2 Use the \leftarrow/\rightarrow buttons to select the title you want to name, then press ENTER to go to the name input screen.
- 3 Input a name for the selected title.

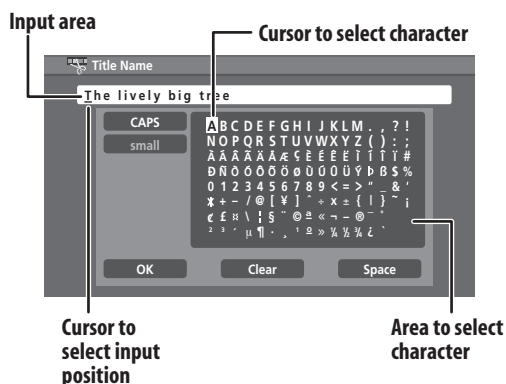

- A name generated automatically by the recorder will already be in the name input section of the screen.
 - Use the $\uparrow/\downarrow/\leftarrow/\rightarrow$ (cursor buttons) and ENTER to select characters.
 - Select **CAPS** or **small** to change to upper or lower-case.
 - Use the **CLEAR** button to delete characters directly (press and hold for two seconds to delete the whole name).
 - For discs formatted on a different DVD recorder, you will see only a limited character set.
- 4 Highlight 'OK' then press ENTER to enter the name and return to the title selection screen.
 - To return to the title selection screen without saving changes to the title name, press RETURN.
 - 5 Press RETURN to go back to the Title Edit menu options, or select another title to name.

Navigation Mark (Navi Mark)

VR mode

Use this function to select a frame from a title to use as that title's thumbnail image in the Disc Navigator.

- 1 Select 'Navi Mark' from the Title Edit menu options.
- 2 Use the \leftarrow/\rightarrow buttons to select the title then press ENTER.
- 3 Use the playback controls (\blacktriangleright , \parallel , $\blacktriangleright\blacktriangleright$, $\parallel\blacktriangleright$, etc.) to find the frame you want to use for the thumbnail picture.

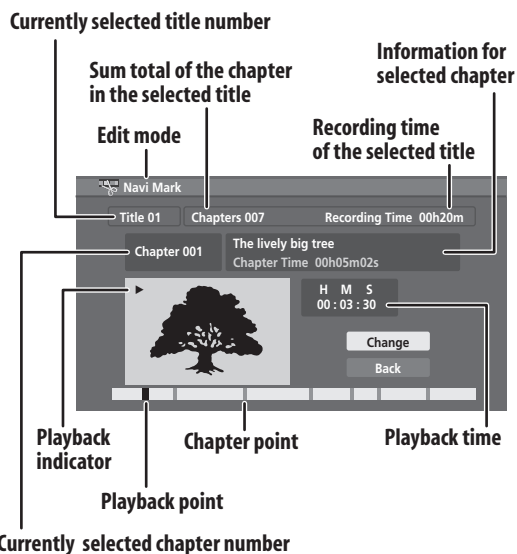

- 4 When the frame you want to use is displayed, select 'Change' then press ENTER.
- 5 To return to the title selection screen, press RETURN, or select 'Back' then press ENTER.
- 6 Press RETURN to go back to the Title Edit menu options, or select another title to change.

Lock

VR mode

You can lock a title so that it can't be edited or erased accidentally. If you do need to edit it, you can always unlock it later.

- 1 Select 'Lock' from the Title Edit menu options.
- 2 Use the \leftarrow/\rightarrow buttons to select the title you want to lock (or unlock), then press ENTER.

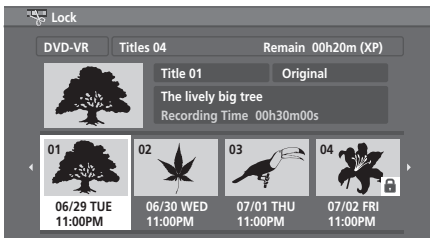

An unlocked title will become locked; a locked title will be unlocked. Locked titles are displayed with a padlock icon.

- 3 Press RETURN to go back to the Title Edit menu options, or select another title to lock/unlock.

Erase All

VR mode Video mode

This command erases all unlocked titles from the disc (see also *Lock* on page 43).

When editing a DVD-RW, the available recording time will increase when titles are erased. Since DVD-R is not erasable/rewritable, the erased titles do not free up space on the disc, even though they are not visible anymore.

- 1 Select 'Erase All' from the Title Edit menu options.

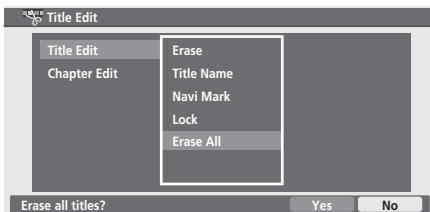

- 2 Select 'Yes' to confirm, or 'No' to cancel, then press ENTER.

When all titles are erased, you will automatically be taken back to the Home Menu.

Editing chapters (Chapter Edit)

VR mode

When editing VR mode DVDs you can edit individual chapters within a title, with commands for erasing, combining and dividing.

Erase

VR mode

Use this command to erase individual chapters from a title.

- 1 Select 'Erase' from the Chapter Edit menu options.
- 2 Use the \leftarrow/\rightarrow buttons to select the title containing the chapters you want to erase, then press ENTER.

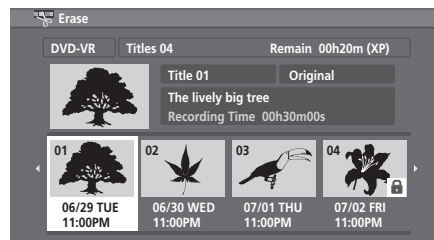

- 3 Use the $\uparrow/\downarrow/\leftarrow/\rightarrow$ (cursor buttons) to select the chapter you want to erase, then press ENTER.

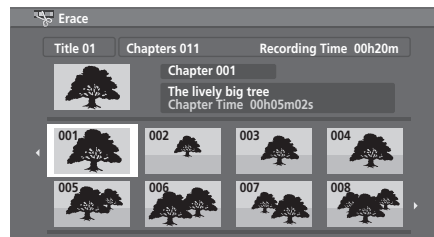

- 4 Highlight 'Yes' to confirm, or 'No' to cancel, then press ENTER.

- 5 To return to the title selection screen, press RETURN.

- 6 Press RETURN to go back to the Chapter Edit menu options, or \leftarrow select another title to edit.

Divide

VR mode

Use this command to divide a chapter into two new ones.

- 1 Select 'Divide' from the Chapter Edit menu options.
- 2 Use the \leftarrow/\rightarrow buttons to select the title containing the chapter you want to divide, then press ENTER.
- 3 Use the $\uparrow/\downarrow/\leftarrow/\rightarrow$ (cursor buttons) to select the chapter, then press ENTER.

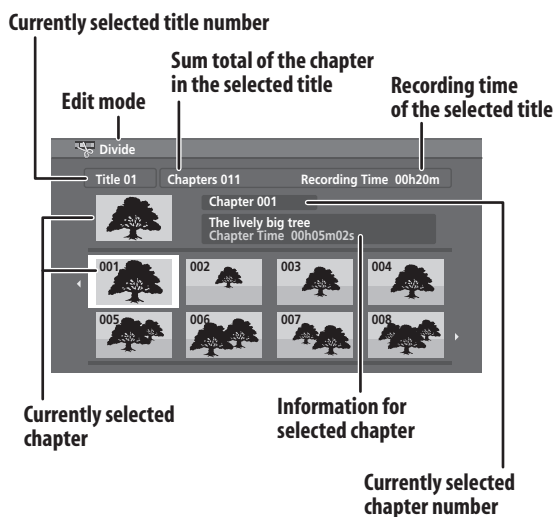

- 4 Use the playback controls (\blacktriangleright , \parallel , \blacktriangleleft , \blacktriangleright , etc.) to find the place you want to divide the chapter.

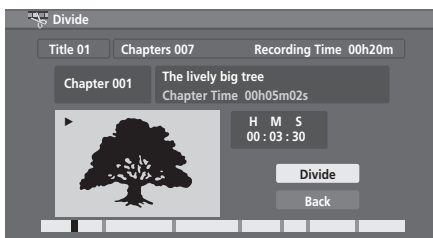

- 5 Select 'Divide' and press ENTER to divide the chapter.
- 6 To return to the chapter selection screen, press RETURN, or select 'Back' then press ENTER.
- 7 Press RETURN to go back to the Chapter Edit menu options, or select another title to edit.

Note

- When divided, both of the new chapters must be longer than three seconds.

Combine

VR mode

Use this function to combine two adjacent chapters into one.

- 1 Select 'Combine' from the Chapter Edit menu options.
- 2 Use the \leftarrow/\rightarrow buttons to select the title containing the chapters you want to combine, then press ENTER.

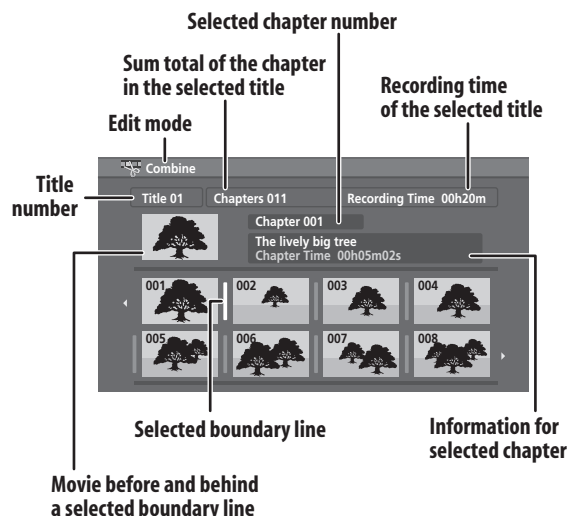

- 3 Highlight the bar divider between the two chapters you want to combine, then press ENTER.

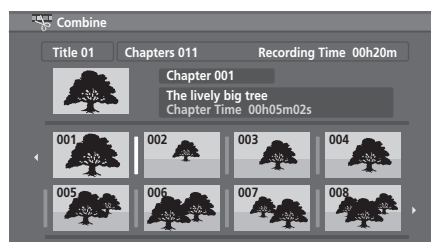

- 4 To return to the title selection screen, press RETURN.
- 5 Press RETURN to go back to the Chapter Edit menu options, or select another title to edit.

Note

- It may not always be possible to combine two chapters, even though they are adjacent. If a chapter has been divided into three, then the middle chapter erased, it is not possible to combine the two remaining chapters into one.

Chapter 8

The Initial Setup menu

Using the Initial Setup menu

The Initial Setup menu is where you can set various recorder options for sound, picture, language and so on.

- Press **HOME MENU** and select 'Initial Setup'.

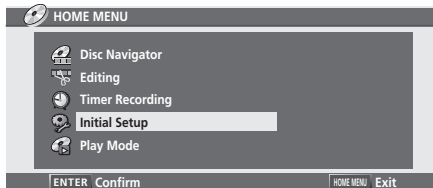

- Some settings can only be changed when the recorder is stopped. during playback these settings are grayed out in the Initial Setup menu.
- Except for the Setup Navigator, menu screens are exited automatically after 20 minutes of inactivity.

Basic settings

Clock

The date (month, day, year) and time must be set before you can use any of the timer recording features.

The clock can be set automatically if there is a broadcast station transmitting clock signals, or manually. Select **Auto** to set the clock automatically or **Manual** to display the clock setting screen.

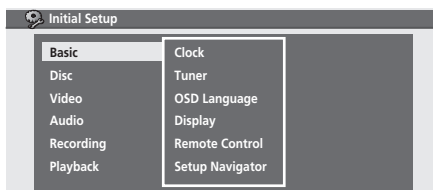

- **Auto clock setting**
Some TV channels broadcast time signals together with the program. This recorder can use these signals to set the clock automatically.

- 1 Select 'Auto'.

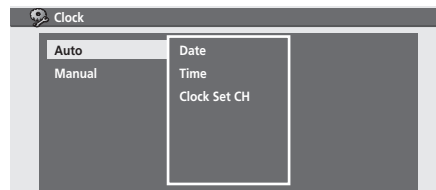

- 2 Set 'Clock Set CH' to the channel preset number that broadcasts a clock signal.

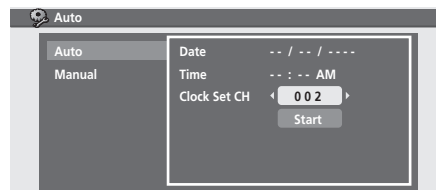

- 3 Move the cursor down to 'Start' and press **ENTER**.

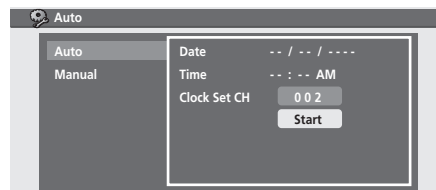

The time and date is displayed when the recorder has successfully set the clock.

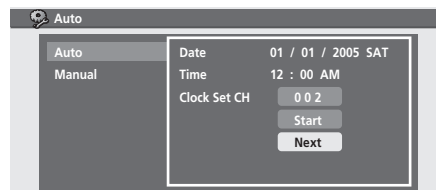

- If the time could not be set, press **RETURN** to go back to the previous screen and select **Manual**.
- **Manual clock setting**
If no stations in your area are broadcasting time signals, you can set the clock manually:

1 Select 'Manual'.

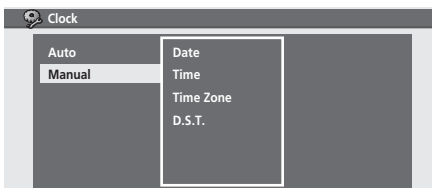

2 Use the ←/→ buttons to set your time zone, then press ENTER.

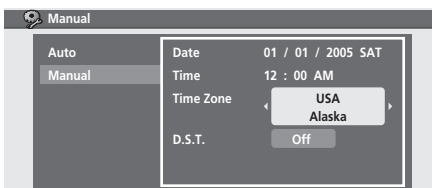

3 Press ↓ then use the ←/→ buttons to set daylight saving time (D.S.T.) On or Off, then press ENTER.

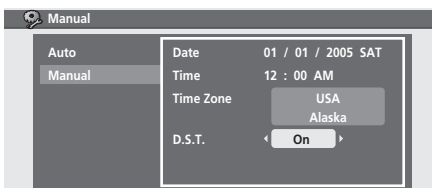

4 Set the current date and time.

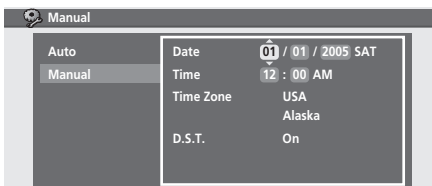

Use the ↑/↓ buttons to change the value in the highlighted field.

Use the ←/→ buttons to move from one field to another.

5 Press ENTER to finish setting the time.

Tuner

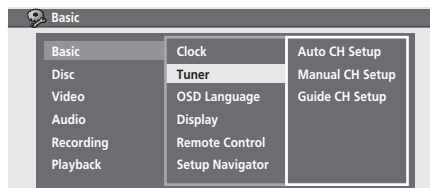

Auto CH Setup

- Default setting: **Antenna**

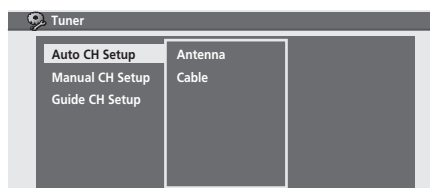

Auto Channel Setting automatically tunes the built-in TV tuner to terrestrial broadcast TV channels or cable channels.

1 Select 'Antenna' or 'Cable', depending on how you receive your TV channels.

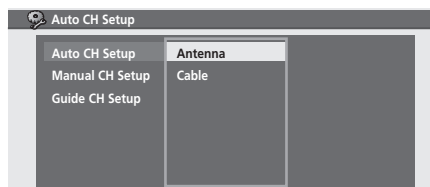

2 Wait for the automatic tuning to finish.

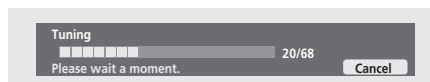

After automatic tuning has finished, a channel mapping summary screen is displayed.

CH	Skip	CH	Skip	CH	Skip
002	On	009	Off	017	Off
003	On	010	Off	018	Off
004	On	011	Off	019	Off
005	On	012	Off	020	Off
006	On	013	Off	021	Off
007	On	014	Off	022	Off
008	Off	015	Off	023	Off
		016	Off	024	Off

3 Press ENTER to return to the main menu screen.

Note

- If you want to cancel before tuning has finished, press **ENTER**.
- You can manually tune and skip blank channels using the Manual CH Setting, below.

Manual CH Setup

- Default setting: *n/a*

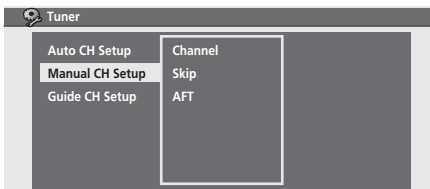

From the manual channel setup screen you can manually fine tune channels and set channels to skip. The skip function lets you skip channels where there is no station so that as you change channels using the **CHANNEL +/-** buttons or the number buttons, you only change to channels that have a station.

1 Select 'Manual CH Setup' to display the manual channel setup screen.

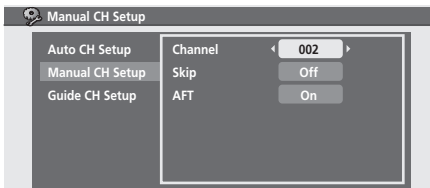

- Use the **↑/↓** buttons to change the guide channel for setting.
- If you want to skip the displayed channel (because there is no station assigned to that channel), change the **Skip** setting to **On**.
- If you want to manually tune the displayed channel, change the **AFT** (Auto Fine Tuning) setting to **Off**, then move down to **Level** to manually tune to a station.

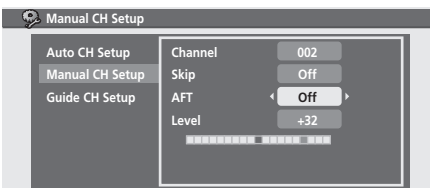

2 To return to the Initial Setup menu, press ENTER.

Guide CH Setup

- Default setting: *n/a*

Guide channels are used by the VCR Plus+ system so that the channel number specified in the VCR Plus+ programming numbers can be guaranteed to correspond to the correct station.

1 Select 'Guide CH Setup', then 'Guide CH'.

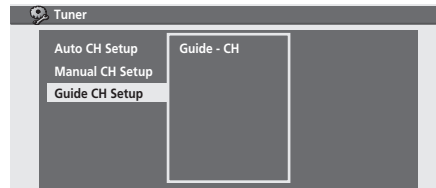

2 Assign channel numbers to the guide channels as necessary.

Look in your TV guide to see which channel numbers should be assigned to which guide channels.

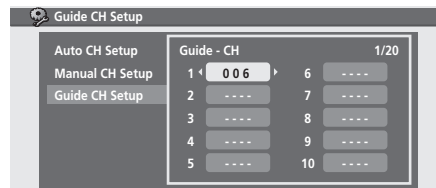

- Use the **↑/↓** buttons to change the guide channel for setting.
- Use the **←/→** buttons to change the channel number.
- Use the **PREV / NEXT** button to display the previous/next 10 guide channels.

3 To return to the previous screen, press ENTER or RETURN.

OSD Language

- Default setting: **English**

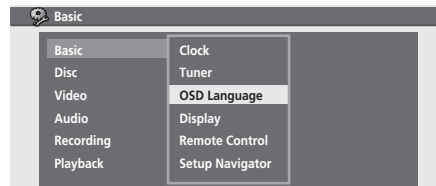

This sets the language of the on-screen menus and displays.

- Select 'OSD Language' then use the \leftarrow/\rightarrow buttons to select a language option.

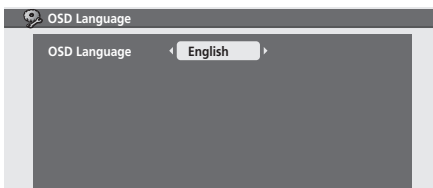

Display

- Default setting: **On**

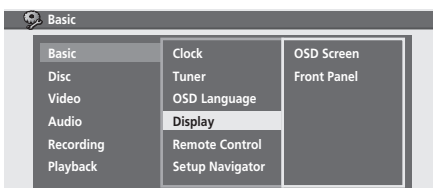

You can have the recorder show or hide on-screen operation displays (for Play, Stop, etc.), and choose whether to switch the front panel display on or off when the recorder is in standby.

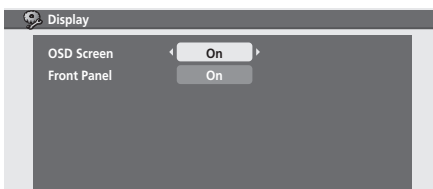

Remote Control

- Default setting: **Recorder1**

You only need to set this if you are using more than one Pioneer DVD recorder in the same room.

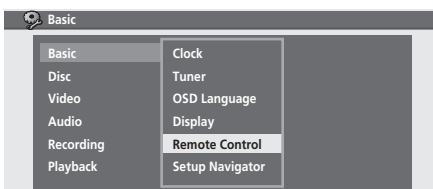

So that each remote control operates only its own recorder, make this setting different for each recorder and remote in the room.

There are three different recorder IDs. When set to **Recorder2** or **Recorder3**, the remote control mode is shown in the front panel display.



After selecting a new recorder ID, you have to confirm the change by selecting **Yes** or **No** (use the \leftarrow/\rightarrow buttons), then pressing **ENTER**.

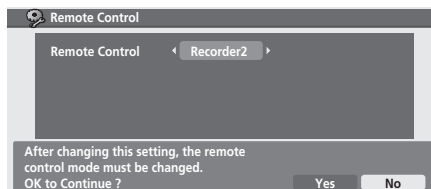

Note that as soon as you change the recorder ID, the remote becomes inoperative until you change the remote to the same ID.

To set the remote, press and hold **RETURN** and a number button (**1**, **2** or **3**) for five seconds.

Setup Navigator

- Default setting: *n/a*

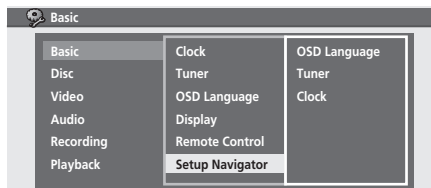

The Setup Navigator appears automatically when you switch on the recorder for the first time (or after resetting the recorder). It is also available from the Initial Settings menu should you need it at any other time.

See also *Switching on and setting up* on page 20.

Disc settings

Lock Disc

VR mode

- Default setting: **Off**

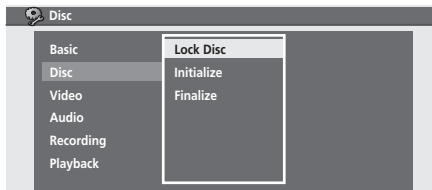

Set to **On** to prevent accidental recording, editing or erasing of the disc loaded. If you need to unlock the disc to make edits, select **Off**.

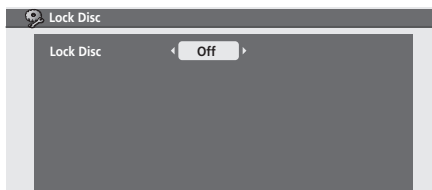

Important

- A locked disc can still be initialized (which will completely erase the disc).

Initialize

See *Initializing a DVD-RW disc* on page 40 for detailed instructions on this option.

Finalize

Finalizing 'fixes' the recordings in place so that the disc can be played on a regular DVD player or computer equipped with a suitable DVD-ROM drive.

See *Playing your recordings on other DVD players* on page 39 for detailed instructions.

Undo Finalize

You can undo the finalization on DVD-RW discs recorded on this recorder in Video mode. You need to do this if you want to record more material or edit material already on the disc.

You can also undo the finalization of VR mode discs which have been finalized on other DVD recorders. If when you load a disc the message **This disc cannot be recorded. Undo the finalization** is displayed, use this command to be able to record on the disc using this recorder.

Select **Finalize**, then **Undo Finalize Start** from the finalize options screen.

Video settings

Video Out

- Default setting: **Interlace**

You only need to make this setting if you connected this recorder to your TV using the component video jacks.

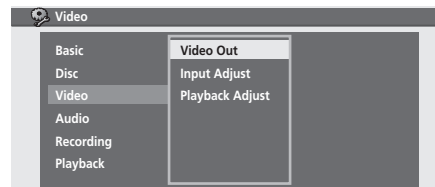

If your TV is compatible with progressive-scan component video, set this **Progressive** for the highest quality picture. If your TV is not compatible with progressive-scan video, leave it set to **Interlace**.

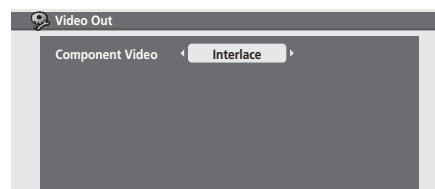

- See also *Progressive scan video* in the glossary on page 64.

Important

If you switch to **Progressive** when using a TV that is not compatible with progressive-scan video, you will not be able to see anything displayed on your TV. If this happens, press and hold the **+** button on the front panel, then press **⏻ STANDBY/ON**. This will set the recorder's video output back to **Interlace**.

Compatibility of this unit with progressive-scan TVs

Consumers should note that not all high-definition television sets are fully compatible with this product and may cause artifacts to be displayed in the picture. In case of 525 progressive scan picture problems, it is recommended that the user switch the connection to the 'standard definition' output (Interlace). If there are questions regarding our TV set compatibility with this model, please contact our customer service center.

This recorder is compatible with the following Pioneer displays and monitors

Plasma display

- PDP-505HD, PDP-502MX, PDP-5030HD, PDP-4330HD, Pro-1000HD, Pro-800HD, PDP-5031, PDP-4300, Pro-1000HDI, Pro-800HDI, PDP-5040HD, PDP-4340HD, Pro-1110HD, Pro-910HD, Pro-810HD, Pro-1010HD, Pro-920HD, Pro-1120HD, PDP-4345HD, PDP-5045HD, PDP-4350HD, PDP-5050HD, PDP-4304, PDP-5004, PDP-4300

Projection monitor receiver

- Pro-700HD, Pro-710HD, Pro-610HD, Pro-510HD, Pro-720HD, Pro-620HD, Pro-520HD, SD-641HD5, SD-582HD5, SD-532HD5, SD-533HD5, SD-643HD5, Pro-730HD, Pro-630HD, Pro-530HD, Pro-730HDI, Pro-530HDI, Pro-730HD, Pro-630HD, Pro-530HD

Input Adjust

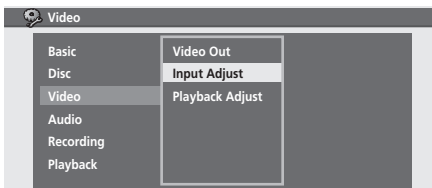

Use this setting to adjust the brightness/color separation of the video input.

From the Input Adjust screen, use the **←/→** buttons to adjust the **3-D Y/C** setting from **Off** to **Max**.

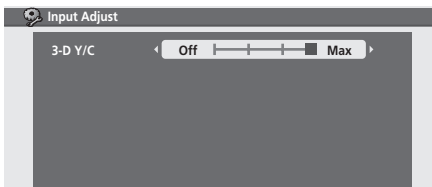

Press **ENTER** to confirm and exit the screen.

Playback Adjust

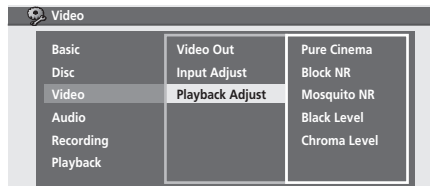

Use the various Playback Adjust settings to adjust the picture quality of the video output.

From the Playback Adjust screen, use the **↑/↓** buttons to select a setting, then use the **←/→** buttons to adjust it.

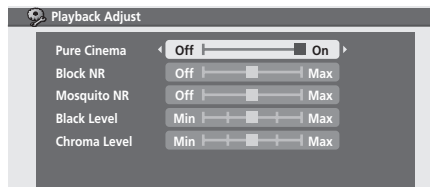

- **Pure Cinema** – This setting optimizes the picture for film material when the video output is set to progressive scan. Usually it is best set to **On**, but try switching it **Off** if the picture appears unnatural.
- **Block NR** – Adjusts the amount of noise reduction applied to the block noise (artifacts visible in areas of flat color, caused by MPEG compression).
- **Mosquito NR** – Adjusts the amount of noise reduction applied to the mosquito noise (artifacts visible around the edge of an image, caused by MPEG compression).
- **Black Level** – Adjusts the intensity of black.
- **Chroma Level** – Adjusts how rich colors appear.

Press **ENTER** to exit the screen.

Audio settings

Audio Adjust setting



Use the Audio Adjust setting to adjust the dynamic range of the audio output when playing DVDs with Dolby Digital sound.

From the Audio Adjust screen, use the **←/→** buttons to adjust the **Audio DRC** setting **On** or **Off**. (**Off** leaves the dynamic range untouched; **On** 'squashes' the dynamic range, making it good for lower-level listening.)

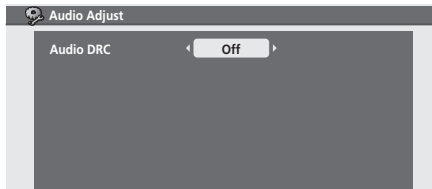

Press **ENTER** to confirm and exit the screen.

Audio In

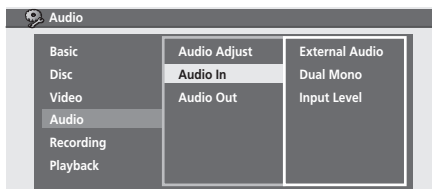

Use the Audio In settings to specify which channel(s) of a dual mono source to record and adjust the analog audio input level.

From the Audio In screen, use the **↑/↓** buttons to select a setting, then use the **←/→** buttons to adjust it.



- **External Audio** – Select **Stereo** if the external audio input is regular stereo, or **Dual Mono** if each channel carries a separate soundtrack.
- **Dual Mono Rec** – When recording a dual mono source from an external input in Video mode or VR mode set to **XP**, you can choose to record the **L** (left), or the **R** (right) audio channel.
- **Input Level** – Use to attenuate the analog audio input level. (External input only)

Note

- Except in **XP** recording mode, if you're recording in VR mode, both channels will be recorded and you can switch them as you like on playback.

Audio Out

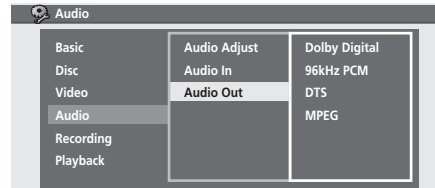

Use the various Audio Out settings to make sure that the digital audio output is compatible with your AV receiver (or other connected component). You may need to check the operating instructions that came with your AV receiver to see which digital formats it's compatible with.

From the Audio Out screen, use the **↑/↓** buttons to select a setting, then use the **←/→** buttons to adjust it.

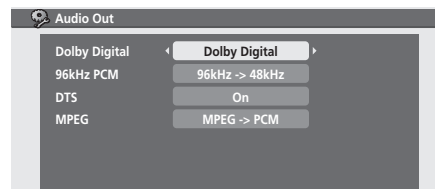

- **Dolby Digital** – If your AV receiver, etc. is Dolby Digital compatible, set to **Dolby Digital**, otherwise set to **Dolby Digital -> PCM**.
- **96 kHz PCM** – If your AV receiver, etc. is compatible with high sampling rate audio (88.2 / 96 kHz), set to **96kHz**, otherwise set to **96kHz -> 48kHz**.
- **DTS** – If your AV receiver, etc. has a built-in DTS decoder, set to **On**, otherwise set to **Off**. (See also *Important* below.)
- **MPEG** – If your AV receiver, etc. is MPEG audio compatible, set to **MPEG**, otherwise set to **MPEG -> PCM**.

Important

- If you set **DTS** to **On** with a non-DTS compatible amplifier, noise will be output when you play a DTS disc.
- When set to **On**, there is no analog audio output when playing a DTS DVD-Video disc.
- When playing a DTS audio CD (even when **DTS** is **Off**), noise is output from the analog outputs. *Do not play this through your amplifier and speakers.*
- When playing a DTS audio CD, make sure that **Stereo** is selected using the **AUDIO** button. See *Switching DVD soundtracks* on page 31.

Recording settings

Optimized Rec

- Default setting: **Off**

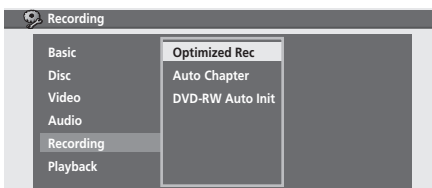

On the default setting, if a timer program (Standard or VCR Plus+ programming system) is set but there isn't enough space on the disc at the recording quality set, the recording will start, but it will be cut off when the disc is full.

Set **Optimized Rec** to **On** to have the recorder automatically adjust the recording quality to fit the available disc space.



Note

- The quality of recordings may be reduced if a longer recording time is used.
- If, even on recording level **SEP**, there is insufficient space available on the disc, the recording is made on **SEP** but recording will stop once the disc is full.
- Optimized Recording only compensates for the first (earliest starting) timer program if more than one has been set.

Auto Chapter

- Default setting: **On**

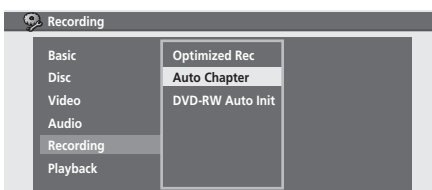

On the default setting, a new chapter is started approximately every 15 minutes when recording in Video mode.

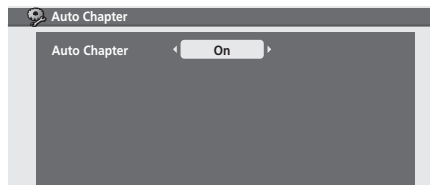

DVD-RW Auto Init.

- Default setting: **VR Mode**

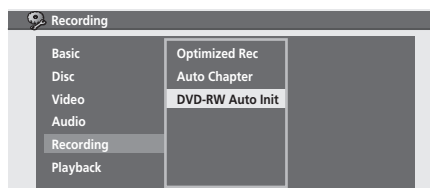

When you load a new, blank DVD-RW disc the recorder automatically initializes it for recording. You can set it to initialize the disc for **VR mode** or **Video mode** recording.

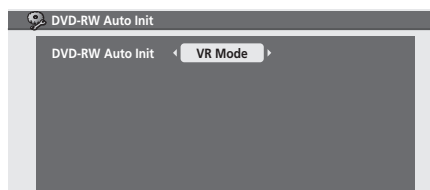

Playback settings

Parental Lock

Some DVD-Video discs feature a Parental Lock level. If the recorder is set to a lower level than the disc, it will require you to enter a password before the disc will play. This gives you some control about what your children watch on your DVD recorder.

Some discs also support the Country/Area code feature. The recorder does not play certain scenes on these discs depending on the Country/Area code you set.

Before you can set the Parental Lock level or the Country/Area code you must set a password. As the password owner you can change the Parental Lock level or Country/Area code whenever you like. You can also change the password.

Note

- Not all discs use the Parental Lock feature. These discs will always play without requiring the password first.
- If you forget the password, you can reset the recorder to its factory settings (see *Resetting the recorder* on page 63), then set a new password.

Set Password

- Default password: *none*

The password you set will enable you to change the Parental Lock level and Country/Area code setting. It is also the password that you will need to enter if you want to play a disc with a parental lock level higher than the recorder.

1 Select 'Set Password'.



2 Use the number buttons to input a four-digit password.



3 Press ENTER to set the password.

Change Password

To change your password, confirm your existing password then enter a new one.

1 Select 'Change Password'.

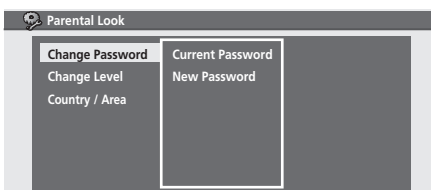

2 Use the number buttons to enter your existing password.

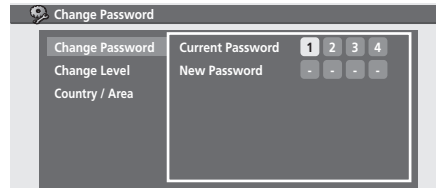

3 Press ENTER.

4 Enter a new password.

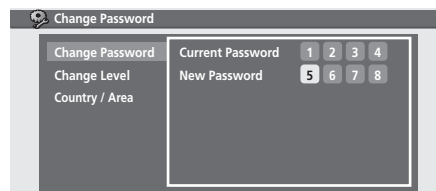

5 Press ENTER.

Change Level

- Default level: **Off**

1 Select 'Level'.

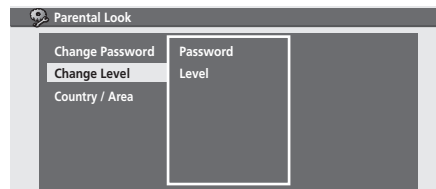

2 Use number buttons to enter your password, then press ENTER.

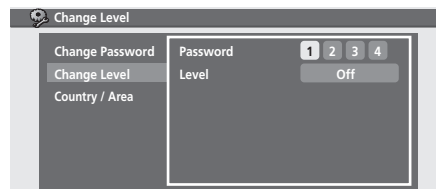

3 Use the ←/→ buttons to select a new parental lock level.

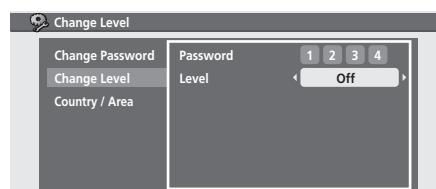

4 Press ENTER to set the new Parental Lock level.

Country/Area

- Default Country/Area code: **us (2119)**

1 Select 'Country / Area'.

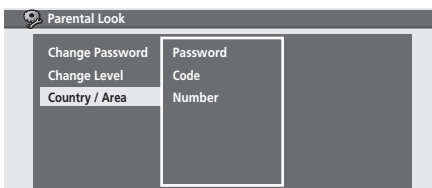

2 Use number buttons to enter your password, then press ENTER.

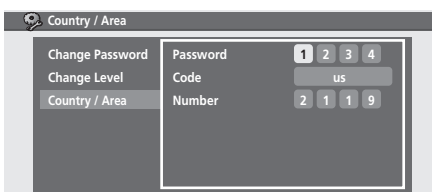

3 Select a Country/Area code.

- You may also want to refer to the *Country/Area code list* on page 60.

There are two ways you can set the Country/Area code:

- Select by code letter: Use the \leftarrow/\rightarrow buttons to change the code.

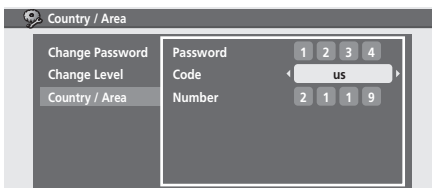

- Select by code number: Press \downarrow then use the number buttons to enter the four-digit Country/Area code (you can find the *Country/Area code list* on page 60.)

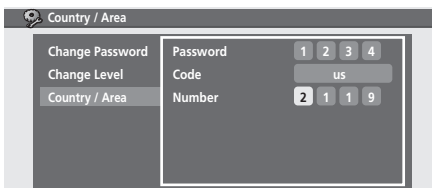

4 Press ENTER to set the new Country/Area code.

Note

- Changing the Country/Area code does not take effect until the next disc is loaded (or the current disc is reloaded).

Language

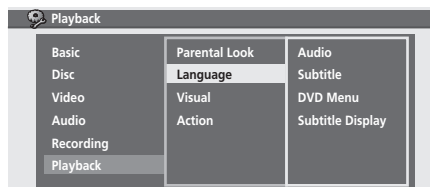

Use the various Language settings to set the default audio, subtitle and menu languages for DVD discs, as well as subtitle display behavior.

From the Language screen, use the \uparrow/\downarrow buttons to select a setting, then use the \leftarrow/\rightarrow buttons to adjust it.

If you want to choose a language other than English, French or Spanish for audio, subtitles and menus, select **Other** then select another language (see *Selecting 'Other' languages* below).

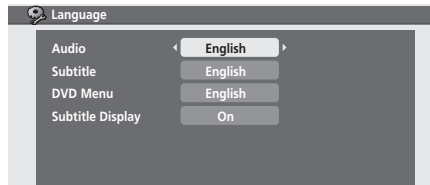

- **Audio** – This setting is your preferred audio language for DVD discs. If the language you specify here is recorded on a disc, the recorder automatically plays the disc in that language.
- **Subtitle** – This setting is your preferred subtitle language for DVD discs. If the language you specify here is recorded on a disc, the recorder automatically plays the disc with those subtitles.
- **DVD Menu** – Some multilingual discs have disc menus in several languages. This setting specifies in which language the disc menus should appear. Leave on the default setting (**w/Subtitle Language**) for menus to appear in the same language as your **Subtitle** language.
- **Subtitle Display** – When set to **On**, the recorder displays subtitles according to the **Subtitle** setting. Set to **Off** to switch subtitles off altogether (although you may find that some discs override this setting).



Tip

- You can switch between the audio and subtitle languages recorded on a DVD disc any time during playback using the **AUDIO** and **SUBTITLE** buttons. (This does not affect these settings.)

Selecting 'Other' languages

1 Select 'Other' from the language list.

This option appears in the settings for DVD Menu Language, Audio Language, and Subtitle Language.

2 Select the language you want.



- Select by language name: Use the **←/→** buttons to change the language.
- Select by code number: Press **↓** then use the number buttons to enter the four-digit language code.

See *Language code list* on page 60 for a list of available languages and corresponding codes.

3 Press ENTER to confirm and exit the screen.

Visual settings

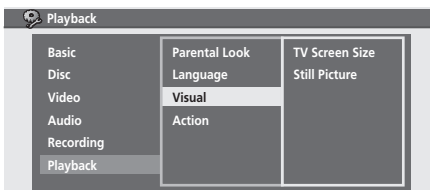

Use the Visual settings to specify the kind of TV you have and how still frames should appear when you pause playback of a disc.

From the Visual screen, use the **↑/↓** buttons to select a setting, then use the **←/→** buttons to adjust it.

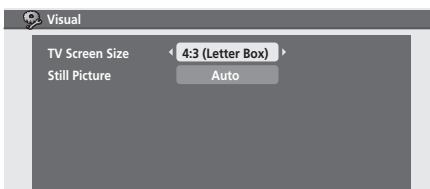

- TV Screen Size** – If you have a widescreen TV, select the **16:9** setting—widescreen DVD software is then shown using the full screen area. When playing software recorded in conventional (4:3) format, the settings on your TV will determine how the material is presented—see the manual that came with your TV for details on what options are available.

If you have a conventional TV, choose either **4:3 (Letter Box)** or **4:3 (Pan & Scan)**. In Letter Box mode, widescreen software is shown with black bars at the top and bottom of the screen. Pan & Scan chops the sides off widescreen material to make it fit the 4:3 screen (so even though the picture looks larger on the screen, you're actually seeing less of the movie). See *Screen sizes and disc formats* on page 56 for more information.

- Still Picture** – The recorder uses one of two processes when displaying a still frame from a DVD disc. The default **Auto** setting automatically chooses the best setting each time.

The **Frame** setting produces a sharper image, but more prone to shake than field stills.

Action settings

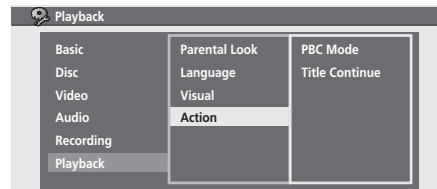

Use the Action settings to specify Video CD playback and DVD title playback behavior.

From the Action screen, use the **↑/↓** buttons to select a setting, then use the **←/→** buttons to adjust it.













- PBC Mode** – Set to **On** to have the recorder automatically start playing Video CDs in playback control (PBC) mode, if possible. Set to **Off** if you prefer to use 'manual' playback.
- Title Continue** – (VR mode only) Set to **On** to have the recorder start playing the following title immediately after the previous one ends. When set to **Off**, when a title finishes the disc menu is displayed.

Chapter 9

Additional information

Screen sizes and disc formats

When viewing on a standard TV or monitor		
Screen format of disc	Setting	Appearance
16:9 	4:3 (Letter Box) 	The program is shown in widescreen with black bars at the top and bottom of the screen.
	4:3 (Pan & Scan) 	The sides of the program are cropped so that the picture fills the whole screen.
4:3 	16:9 	The program appears squashed. Set to either 4:3 (Letter Box) or 4:3 (Pan & Scan) .
	4:3 (Letter Box) 4:3 (Pan & Scan) 	The program is presented correctly on either setting.
When viewing on a widescreen TV or monitor		
Screen format of disc	Setting	Appearance
16:9 	16:9 	The program is presented in widescreen.
4:3 		Your TV will determine how the picture is presented—check the manual that came with the TV for details.
		

Troubleshooting

Incorrect operation is often mistaken for trouble and malfunction. If you think there is something wrong with this component, please check the points below. Sometimes the trouble may lie in another component. Investigate the other components and electrical appliances being used. If the trouble cannot be rectified even after checking the points below, ask your nearest Pioneer authorized service center or your dealer to carry out repair work.

General

Problem	Remedy
The disc is automatically ejected after closing the disc tray	<ul style="list-style-type: none"> • Check that the disc is not a DVD-RAM, DVD+R/RW, dual disc (DVD/CD hybrid disc) or other incompatible format disc (page 8). • Check that the disc is loaded properly (aligned in disc tray and label-side up). • Take out the disc and clean it (page 62). • Check that the disc has a region code compatible with the recorder (page 64).
No picture	<ul style="list-style-type: none"> • Check that everything is connected properly (page 10). • Check that the connected TV and/or the AV amp/receiver is set to the correct input. • Make sure that the disc is NTSC format. • The recorder may be set to progressive-scan with an incompatible TV. Reset to interlace by pressing and holding the + button (front panel) then pressing ⏻ STANDBY/ON (front panel).
Can't play a disc	<ul style="list-style-type: none"> • Check that the disc is not a DVD-RAM, DVD+R/RW, dual disc (DVD/CD hybrid disc) or other incompatible format disc (page 8). • Take out the disc and clean it (page 62). • Check that the disc is loaded properly (aligned in disc tray and label-side up). • There may be condensation in the recorder. Leave the recorder for an hour or so for the condensation to evaporate.
All settings are reset	<ul style="list-style-type: none"> • If the recorder is unplugged (or there is a power failure) while the recorder is on, all the settings will be lost. • Make sure that you switch the recorder into standby before unplugging the power cord.
Screen goes blank and controls are inoperative	<ul style="list-style-type: none"> • Press ■ then restart playback.
Remote control does not work	<ul style="list-style-type: none"> • Set the remote control to the same ID number as the recorder (page 48). (When the batteries run down, the remote mode is automatically reset to 1.) • Use the remote within its operating range (page 8). • Replace the batteries (page 8).
No sound or sound is distorted	<ul style="list-style-type: none"> • Make sure that the amp/receiver or TV is set to the correct input and the volume turned up. • There is no sound when the picture is paused, or during scanning (even forwards at regular play speed) or slow motion play. Press ▶ to resume regular playback. • DTS discs can only be played if this recorder is connected to a DTS decoder or DTS compatible amp/receiver. If you have connected a suitable decoder, also make sure that the Initial Setup > Audio > Audio Out > DTS setting is On. • Some 96kHz discs do not output audio through the digital jack. In this case, switch the input of your amp/receiver to analog. • Check the audio cable connections (page 10). • If the sound is distorted, try cleaning the cable plugs.
The picture from the external input is distorted	<ul style="list-style-type: none"> • If the video signal from the external component is copy-protected, you cannot connect via this recorder. Connect the component directly to your TV.

Problem	Remedy
Screen is stretched vertically or horizontally	<ul style="list-style-type: none"> • Make sure that the TV Screen Size setting (page 55) is correct for the kind of TV you have (see also page 56). • If you have a widescreen TV, check its aspect ratio settings. • This recorder's input switches into wide mode automatically according to the input signal. When the unit connected is not compatible with ID-1, set the connected component to output 4:3 aspect ratio (standard) video.
Can't play a disc recorded using this recorder on another player	<ul style="list-style-type: none"> • If the disc was recorded in Video mode, make sure that it's finalized (page 39). • Some players will not play recordable DVD discs, even when recorded in Video mode and finalized. • If the disc was recorded in VR mode, the other player must be specifically RW compatible in order to play it (page 8). • Discs recorded with copy-once material cannot be played on non-CPRM compatible players (page 34).
During playback the picture is dark or distorted	<ul style="list-style-type: none"> • When a copy-protected disc is played via a VCR, the picture will not display correctly. Connect the recorder directly to your TV.
Can't record or does not record successfully	<ul style="list-style-type: none"> • Check that there is some remaining blank space on the DVD. • Check that the disc isn't already finalized. • A DVD disc may contain up to 99 (Original) titles and 999 chapters. Check that these limits have not been reached. • Check that the source you are trying to record is not copy protected. • For a VR formatted disc, check that the disc isn't locked (page 48). • The power may have failed during recording.
Timer program doesn't record successfully	<ul style="list-style-type: none"> • When setting the recording channel, make sure you set the recorder's built-in TV tuner, not the TV's built-in tuner. • When recording to a Video mode disc, programs that are copy-once protected cannot be recorded. Use a VR mode formatted disc for copy-once material (page 34). • Two timer programs may have overlapped, in which case only the earlier one will record completely. • The power may have failed during recording.
After briefly unplugging or after a power failure the front panel display shows '---'	<ul style="list-style-type: none"> • Reset the clock and other recorder settings to use the recorder again.
Front panel display shows 'LOCK' when a button is pressed	<ul style="list-style-type: none"> • The Child Lock is on; turn off in order to use the recorder (page 38).
The picture freezes and the front panel and remote control buttons stop working	<ul style="list-style-type: none"> • Press the front panel ⏻ STANDBY/ON button to switch the power off, then switch back on and restart playback. If the power fails to switch off, press and hold ⏻ STANDBY/ON for 10 seconds until the power switches off.
	<ul style="list-style-type: none"> • If the unit does not operate normally due to external effects such as static electricity, disconnect the power plug from the outlet and insert again to return to normal operating conditions.

Frequently asked questions

In this section you can find answers to frequently asked questions on how to use your DVD recorder and what it can do.

- *What kind of discs can I use for recording?*

You can use DVD-R and DVD-RW discs for recording. DVD-RAM, CD-R and CD-RW discs are not recordable using this recorder.

See *General disc compatibility* on page 8 for more details.

- *Can I watch recordings made using this recorder on other DVD players?*

Yes. Use a DVD-R disc for you recordings (these are always recorded in Video mode). After recording, finalize the disc to make it playable on other DVD players (note that you cannot make further recordings on the disc after finalizing it).

If you want to use a DVD-RW disc, make sure that it's initialized for recording in Video mode. As with a DVD-R, finalize the disc after recording to make it playable in other players.

See also *Playing your recordings on other DVD players* on page 39.

- *Can I edit recordings, or erase parts of recordings from a disc?*

Yes. Recording to a VR mode DVD-RW disc gives you the most flexibility when editing. By default, when you load a new DVD-RW disc into the recorder it is initialized for recording in VR mode.

See also *Editing* on page 41.

- *Can I play a VR mode DVD-RW disc in another DVD player?*

Look for the 'RW Compatible' mark on the other DVD player to see if it will play VR mode DVD-RW discs. If the player does not recognize the disc when you load it, try finalizing it in the recorder, then try again.

See also *Playing your recordings on other DVD players* on page 39.

- *Can I record a copy-once protected program from a subscription satellite or cable channel?*

Yes, but you'll need to use a CPRM-compatible DVD-RW disc initialized for VR mode recording. (Look on the disc package to see if it is CPRM compatible.)

See also *CPRM* on page 34.

- *I changed the batteries in the remote control and now it doesn't work!*

Most likely the remote control ID does not match the recorder. After changing the batteries, the remote ID is reset to 1; if the recorder is set to something else, the remote will not work with it.

See *Remote Control* on page 48 for how to set the ID of the recorder and the remote.

Language code list

Language (Language code letter), **Language code**

Japanese (ja), 1001	Bhutani (dz), 0426	Kirghiz (ky), 1125	Sinhalese (si), 1909
English (en), 0514	Esperanto (eo), 0515	Latin (la), 1201	Slovak (sk), 1911
French (fr), 0618	Estonian (et), 0520	Lingala (ln), 1214	Slovenian (sl), 1912
German (de), 0405	Basque (eu), 0521	Laothian (lo), 1215	Samoa (sm), 1913
Italian (it), 0920	Persian (fa), 0601	Lithuanian (lt), 1220	Shona (sn), 1914
Spanish (es), 0519	Finnish (fi), 0609	Latvian (lv), 1222	Somali (so), 1915
Chinese (zh), 2608	Fiji (fj), 0610	Malagasy (mg), 1307	Albanian (sq), 1917
Dutch (nl), 1412	Faroe (fo), 0615	Maori (mi), 1309	Serbian (sr), 1918
Portuguese (pt), 1620	Frisian (fy), 0625	Macedonian (mk), 1311	Siswati (ss), 1919
Swedish (sv), 1922	Irish (ga), 0701	Malayalam (ml), 1312	Sesotho (st), 1920
Russian (ru), 1821	Scots-Gaelic (gd), 0704	Mongolian (mn), 1314	Sundanese (su), 1921
Korean (ko), 1115	Galician (gl), 0712	Moldavian (mo), 1315	Swahili (sw), 1923
Greek (el), 0512	Guarani (gn), 0714	Marathi (mr), 1318	Tamil (ta), 2001
Afar (aa), 0101	Gujarati (gu), 0721	Malay (ms), 1319	Telugu (te), 2005
Abkhazian (ab), 0102	Hausa (ha), 0801	Maltese (mt), 1320	Tajik (tg), 2007
Afrikaans (af), 0106	Hindi (hi), 0809	Burmese (my), 1325	Thai (th), 2008
Amharic (am), 0113	Croatian (hr), 0818	Nauru (na), 1401	Tigrinya (ti), 2009
Arabic (ar), 0118	Hungarian (hu), 0821	Nepali (ne), 1405	Turkmen (tk), 2011
Assamese (as), 0119	Armenian (hy), 0825	Norwegian (no), 1415	Tagalog (tl), 2012
Aymara (ay), 0125	Interlingua (ia), 0901	Occitan (oc), 1503	Setswana (tn), 2014
Azerbaijani (az), 0126	Interlingue (ie), 0905	Oromo (om), 1513	Tonga (to), 2015
Bashkir (ba), 0201	Inupiak (ik), 0911	Oriya (or), 1518	Turkish (tr), 2018
Byelorussian (be), 0205	Indonesian (in), 0914	Panjabi (pa), 1601	Tsonga (ts), 2019
Bulgarian (bg), 0207	Icelandic (is), 0919	Polish (pl), 1612	Tatar (tt), 2020
Bihari (bh), 0208	Hebrew (iw), 0923	Pashto, Pushto (ps), 1619	Twi (tw), 2023
Bislama (bi), 0209	Yiddish (ji), 1009	Quechua (qu), 1721	Ukrainian (uk), 2111
Bengali (bn), 0214	Javanese (jw), 1023	Rhaeto-Romance (rm), 1813	Urdu (ur), 2118
Tibetan (bo), 0215	Georgian (ka), 1101	Kirundi (rn), 1814	Uzbek (uz), 2126
Breton (br), 0218	Kazakh (kk), 1111	Romanian (ro), 1815	Vietnamese (vi), 2209
Catalan (ca), 0301	Greenlandic (kl), 1112	Kinyarwanda (rw), 1823	Volapük (vo), 2215
Corsican (co), 0315	Cambodian (km), 1113	Sanskrit (sa), 1901	Wolof (wo), 2315
Czech (cs), 0319	Kannada (kn), 1114	Sindhi (sd), 1904	Xhosa (xh), 2408
Welsh (cy), 0325	Kashmiri (ks), 1119	Sangho (sg), 1907	Yoruba (yo), 2515
Danish (da), 0401	Kurdish (ku), 1121	Serbo-Croatian (sh), 1908	Zulu (zu), 2621

Country/Area code list

Country/Area, **Country/Area code**, Country/Area code letter

Argentina, 0118 , ar	Finland, 0609 , fi	Malaysia, 1325 , my	Singapore, 1907 , sg
Australia, 0121 , au	France, 0618 , fr	Mexico, 1324 , mx	Spain, 0519 , es
Austria, 0120 , at	Germany, 0405 , de	Netherlands, 1412 , nl	Sweden, 1905 , se
Belgium, 0205 , be	Hong Kong, 0811 , hk	New Zealand, 1426 , nz	Switzerland, 0308 , ch
Brazil, 0218 , br	India, 0914 , in	Norway, 1415 , no	Taiwan, 2023 , tw
Canada, 0301 , ca	Indonesia, 0904 , id	Pakistan, 1611 , pk	Thailand, 2008 , th
Chile, 0312 , cl	Italy, 0920 , it	Philippines, 1608 , ph	United Kingdom, 0702 , gb
China, 0314 , cn	Japan, 1016 , jp	Portugal, 1620 , pt	USA, 2119 , us
Denmark, 0411 , dk	Korea, Republic of, 1118 , kr	Russian Federation, 1821 , ru	

On-screen displays and recorder displays

The table below shows a list of error messages that you may encounter when using the recorder and an explanation of their meaning.

Message	Explanation/Action
<ul style="list-style-type: none"> • Initializing disc. Please wait a moment. 	When you load a blank DVD-RW disc, the recorder automatically initializes it.
<ul style="list-style-type: none"> • Incompatible region number. 	The disc loaded has an incompatible region number for the recorder and so will not play.
<ul style="list-style-type: none"> • Cannot record any more titles. • No more space for file management data. • Cannot add any more chapter marks. 	The disc control data limit has been reached, or the maximum number of chapters and/or titles has been reached. Erase titles/chapters or combine chapters.
<ul style="list-style-type: none"> • This disc cannot be recorded. Undo the finalization. 	The disc was finalized on a non-Pioneer DVD recorder. Undo the finalization in order to recording/editing.
<ul style="list-style-type: none"> • Cannot play this disc. • This disc cannot be recorded. • Cannot read the CPRM information. • Could not record the information to the disc. • Cannot edit. • Could not initialize disc. • Could not complete finalization successfully. • Could not undo finalization successfully. • Could not successfully unlock the disc. 	The disc may be dirty or damaged. Take out the disc, clean it and retry. If the error persists, use a new disc. If the error appears even with a new disc, please consult a Pioneer Service Center.
<ul style="list-style-type: none"> • Incompatible or unreadable disc. 	The disc loaded is a DVD-RAM, DVD+R/RW or some other incompatible disc type. This display may also appear if the disc is dirty or damaged.
<ul style="list-style-type: none"> • Cannot record to a disc that is not CPRM compatible. • Cannot record this content using Video mode recording. 	The video source is copy-once protected. Use a VR mode DVD-RW disc with CPRM for recording.
<ul style="list-style-type: none"> • This content is copy protected. 	The video source is copy-protected and cannot be recorded.
<ul style="list-style-type: none"> • Incorrect CPRM information. 	The recorder could not read the CPRM information. The recorder may be damaged—please consult a Pioneer Service Center.
<ul style="list-style-type: none"> • The audio will conform to the [Dual Mono Recording] setting. 	When recording from an external input in Video mode, or in VR mode set to XP , audio is recorded in Linear PCM format. You can only record the left or right channel; not both.
<ul style="list-style-type: none"> • Operation stopped due to power failure. 	If during recording the power plug is disconnected from the power outlet, this message will be displayed the next time the recorder is switched on. In this case, the recording will not be recoverable.
<ul style="list-style-type: none"> • Repairing disc. 	This message is displayed when, due to damage or recording conditions, the recorder attempts to repair a disc.
<ul style="list-style-type: none"> • Could not repair the disc. 	The recorder was unable to repair the disc.
<ul style="list-style-type: none"> • Overheating has stopped operation. Press DISPLAY to clear this message. 	The internal temperature of the recorder has exceeded the operating limit. If this message reappears, please contact a Pioneer authorized service center.

Handling discs

When holding discs of any type, take care not to leave fingerprints, dirt or scratches on the disc surface. Hold the disc by its edge or by the center hole and edge.

Damaged or dirty discs can affect playback and recording performance. Take care also not to scratch the label side of the disc. Although not as fragile as the recorded side, scratches can still result in a disc becoming unusable.

Should a disc become marked with fingerprints, dust, etc., clean using a soft, dry cloth, wiping the disc lightly from the center to the outside edge as shown in the diagram below.



If necessary, use a cloth soaked in alcohol, or a commercially available CD/DVD cleaning kit to clean a disc more thoroughly. Never use benzene, thinner or other cleaning agents, including products designed for cleaning vinyl records.

Storing discs

Although CDs and DVD discs are more durable than vinyl records, you should still take care to handle and store discs correctly. When you're not using a disc, return it to its case and store upright. Avoid leaving discs in excessively cold, humid, or hot environments (including under direct sunlight).

Don't glue paper or put stickers onto the disc, or use a pencil, ball-point pen or other sharp-tipped writing instrument. These could all damage the disc.



For more detailed care information see the instructions that come with discs.

Do not load more than one disc into the recorder.

Damaged discs

Discs spin at high speed inside the recorder. If you can see that a disc is cracked, chipped, warped, or otherwise damaged, don't risk using it; you could end up damaging the recorder.

This recorder is designed for use with conventional, fully circular discs only. Use of shaped discs is not recommended for this product. Pioneer disclaims all liability arising in connection with the use of shaped discs.

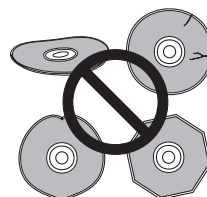

Cleaning the pickup lens

The DVD recorder's lens should not become dirty in normal use, but if for some reason it should malfunction due to dust or dirt, consult your nearest Pioneer-authorized service center. Although lens cleaners for CD players are commercially available, we do not recommend using them since some may damage the lens.

Condensation

Condensation may form inside the recorder if it is brought into a warm room from outside, or if the temperature of the room rises quickly. Although the condensation won't damage the recorder, it may temporarily impair its performance. For this reason you should leave it to adjust to the warmer temperature for about an hour before switching on and using.

Hints on installation

We want you to enjoy using this unit for years to come, so please bear in mind the following points when choosing a suitable location for it:

do...

- ✓ Use in a well-ventilated room.
- ✓ Place on a solid, flat, level surface, such as a table, shelf or stereo rack.

don't...

- ✗ Use in a place exposed to high temperatures or humidity, including near radiators and other heat-generating appliances.
- ✗ Place on a window sill or other place where the recorder will be exposed to direct sunlight.
- ✗ Use in a dusty or damp environment or in a room where it will be exposed to excessive cigarette smoke.

- ✗ Place directly on top of an amplifier, or other component in your stereo system that becomes hot in use.
- ✗ Use near a television or monitor as you may experience interference—especially if the television uses an indoor antenna.
- ✗ Use in a kitchen or other room where the recorder may be exposed to smoke or steam.
- ✗ Use on a thick rug or carpet, or cover with cloth—this may prevent proper cooling of the unit.
- ✗ Place on an unstable surface, or one that is not large enough to support all four of the unit's feet.

Moving the recorder

If you need to move the recorder, first remove the disc, if there's one loaded, and close the disc tray. Next, press **⏻ STANDBY/ON** to switch the power to standby, checking that the **OFF** indication in the display goes off. Lastly, disconnect the power cord. Never lift or move the unit during playback or recording—discs rotate at a high speed and may be damaged.

Resetting the recorder

If you need to, you can reset the recorder to all its factory settings.

- 1 **Make sure that the recorder is on.**
- 2 **Press and hold **■ STOP** and press **⏻ STANDBY/ON**.**

The recorder turns off with all settings reset.

Additional information for cable/satellite/STB (set-top box) users

The following instructions show how to use the timer features of your STB with this recorder.

Setting up

- 1 **Connect the STB's audio/video outputs to a set of audio/video inputs on this recorder.**
- 2 **Switch on both the STB and this recorder and switch the recorder's input function to the STB (L1 or L2).**

To check that everything is connected properly, switch on your TV and select this recorder as the video input. You should see whatever the STB is tuned to.

3 Program the IR controller supplied with your STB to send start/stop recording codes for a Pioneer VCR.

See the manual that came with the STB for how to do this.

Only the **REC** and **STOP** codes have any effect when used with this recorder:

- **REC** – Start recording
- **STOP** – Stop recording

4 Position the IR controller so that it will control this recorder.

The IR sensor on the recorder is located just above the  mark on the front panel.

Making a timer recording

1 Set the timer on the STB.

See the manual that came with your STB for how to do this.

2 Switch on this recorder.

You must leave the recorder on until the recording finishes.

- At the programmed times, the STB will start and stop recording on this recorder.

Glossary

Analog audio

An electrical signal that directly represents sound. Compare this to digital audio which can be an electrical signal, but is an indirect representation of sound. See also *digital audio*.

Aspect ratio

The width of a TV screen relative to its height. Conventional TVs are 4:3 (in other words, the screen is almost square); widescreen models are 16:9 (the screen is almost twice as wide as it is high).

Chapter

Just as a book is split up into several chapters, a title on a DVD disc is usually divided into chapters. See also *Title*.

Digital audio

An indirect representation of sound by numbers. During recording, the sound is measured at discrete intervals (44,100 times a second for CD audio) by an analog-to-digital converter, generating a stream of numbers. On playback, a digital-to-analog converter generates an analog signal based on these numbers. See also *Sampling frequency* and *Analog audio*.

Dolby Digital



Dolby® Digital Recording enables consumers to record high-quality video with stereo sound on recordable DVD discs. The technology, when utilized instead of PCM recording, also saves recordable disc space, allowing for higher video resolution or extended recording time on each DVD. DVDs created using Dolby Digital Recording will play back on all DVD-Video players.

Manufactured under license from Dolby Laboratories. "Dolby" and the double-d symbol are trademarks of Dolby Laboratories.

DTS



DTS stands for Digital Theater System. DTS is a surround system different from Dolby Digital that has become a popular surround sound format for movies.

"DTS" and "DTS digital Out" are registered trademarks of digital Theater Systems, Inc.

Dynamic range

The difference between the quietest and loudest sounds possible in an audio signal (without distorting or getting lost in noise). Dolby Digital and DTS soundtracks are capable of a wide dynamic range, delivering dramatic cinema-like effects.

MPEG audio

MPEG) (Multichannel

An audio format used on Video CDs and some DVD discs. This unit can convert MPEG audio to PCM format for wider compatibility with digital recorders and AV amp/receivers. See also *PCM*.

MPEG video

The video format used for Video CDs and DVDs. Video CD uses the older MPEG-1 standard, while DVD uses the newer and much better quality MPEG-2 standard.

PCM (Pulse Code Modulation)

The most common system of encoding digital audio, found on CDs and DAT. Excellent quality, but requires a lot of data compared to formats such as Dolby Digital and MPEG audio. For compatibility with digital audio recorders (CD, MD and DAT) and AV amp/receivers with digital inputs, this unit can convert Dolby Digital and MPEG audio to PCM. See also *Digital audio*.

PBC (PlayBack Control) (Video CD only)

A system of navigating a Video CD through on-screen menus recorded onto the disc. Especially good for discs that you would normally not watch from beginning to end all at once—karaoke discs, for example.

Progressive scan video

Also called non-interlaced video, this method of displaying a picture updates all the lines in one pass, resulting in a more stable, flicker-free image than interlaced video (for a given scanning rate).

PureCinema

Video on a DVD disc may be either video material (originally shot on video) or film material (originally shot on film). Video material has a frame rate of 30 frames/second, compared to 24 frames/second for film. This recorder converts film material to 60 frames/second (in progressive scan mode). PureCinema adjusts the picture so that it matches more closely the picture quality of a cinema screen.

Regions (DVD only)



(example region code marks)

Regions associate discs and players with particular areas of the world. This unit will only play discs that have compatible region codes. You can find the region code of your unit by looking on the rear panel. Some discs are compatible with more than one region (or all regions).

Sampling frequency

The rate at which sound is measured to be turned into digital audio data. The higher the rate, the better the sound quality, but the more digital information is generated. Standard CD audio has a sampling frequency of 44.1kHz, which means 44,100 samples (measurements) per second. See also *Digital audio*.

Title

A collection of chapters on a DVD disc. See also *Chapter*.

Track

Audio CDs and Video CDs use tracks to divide up the content of a disc. The DVD equivalent is called a chapter. See also *Chapter*.

Specifications

General

System	DVD-Video, DVD-R/RW, Video-CD, CD, CD-R/RW (CD-DA)
Power requirements	120 V, 60 Hz
Power Consumption	22 W
Power consumption in standby mode	0.38 W (Front panel display: off)
Weight	7 lb. 4 oz. / 3.3 kg
Dimensions	16 9/16 (W) x 2 11/16 (H) x 13 1/16 (D) in. 420 (W) x 69 (H) x 332 (D) mm
Operating temperature	+5°C to +35°C
Operating humidity	.5% to 85% (no condensation)
TV format	NTSC

Recording

Recording format	DVD Video Recording DVD-VIDEO
------------------	----------------------------------

Recordable discs

DVD-RW (DVD Re-recordable disc)
DVD-R (DVD Recordable disc)

Video recording format

Sampling frequency	13.5MHz
Compression format	MPEG

Audio recording format

Sampling frequency	48kHz
Compression format	Dolby Digital or Linear PCM (uncompressed)

Recording time

XP (XP)	Approx. 1 hour
Standard Play (SP)	Approx. 2 hours
Long Play (LP)	Approx. 4 hours
Extended Play (EP)	Approx. 6 hours
Super Long Play (SLP)	Approx. 8 hours
Super Extended Play (SEP)	Approx. 10 hours

Tuner

Receivable channels

VHF	2–13ch
UHF	14–69ch
CATV	C1–C125ch

Timer

Programs	1 month/32 programs
Clock	Quartz lock (12-hour digital display)

Input/Output

VHF/UHF antenna input/output terminal	VHF/UHF set 75 Ω (F-shape connector)
Video input	Input 1 (rear), 2 (front)
Input level	1 Vp-p (75 Ω)
Jacks	RCA jack
Video output	Output 1
Output level	1 Vp-p (75 Ω)
Jacks	RCA jack
S-Video input	Input 1
Y (luminance) - Input level	1 Vp-p (75 Ω)
C (color) - Input level	286 mVp-p (75 Ω)
Jacks	.4 pin mini DIN
S-Video output	Output 1
Y (luminance) - Output level	1 Vp-p (75 Ω)
C (color) - Output level	286 mVp-p (75 Ω)
Jacks	.4 pin mini DIN
Component video output	
Output level	Y: 1.0 Vp-p (75 Ω) PB, PR: 0.7 Vp-p (75 Ω)
Jacks	RCA jacks
Audio input	Input 1 (rear), 2 (front) L/R
Input level	
during audio input	2V rms (Input impedance: more than 22 kΩ)
Jacks	RCA jacks
Audio output	Output 1 L/R
during audio output	2V rms (Output impedance: less than 1.5 kΩ)
Jacks	RCA jacks
Digital Audio output	Coaxial digital output 1
Jacks	RCA jack

Supplied accessories

Remote control	1
dry cell batteries (AA/R6P)	2
Audio / Video cable (red/white/yellow)	1
RF antenna cable	1
Power cable	1
Warranty card	1
Blank DVD-RW disc	1
Quick start guide	1
Operating Instructions	1

Note: The specifications and design of this product are subject to change without notice, due to improvement.

Index

A

Audio

- digital output settings **51**
- input settings **51**
- setting preferences for audio language **54**
- setting which channel to record **35**
- switching on playback **31, 32**
- switching TV audio **23**

C

CD Audio

- compatibility **8**
- playback controls for **24, 27 – 32**

D

Dolby Digital

- adjusting the dynamic range **50**
- dual mono sources and **32**
- explained **64**
- output setting **51**

DTS

- CD audio encoded with **24, 51**
- explained **64**
- output setting **51**

DVD

- aspect ratios **55, 56**
- compatibility **9, 39, 58**
- DVD-R vs. DVD-RW **9, 33, 43**
- finalizing **9, 39, 49**
- initializing a DVD-RW **40, 52**
- playback controls for **24, 27 – 32**
- Video mode vs. VR mode **9, 33, 41**

E

Editing **41 – 44**

- Video mode vs. VR mode **41**

L

Language

- audio **31, 54**
- code list **60**
- DVD menu **54**
- setting for menus and displays (OSD) **20, 46, 47**
- settings for DVD playback **54**
- subtitle **31, 54**

P

Picture quality

- recording time vs. **33**
- setting for playback **50**
- setting for recording **34**
- video connections and **12**

Playback **23 – 32**

- on-screen displays **26**
- parental lock for DVD-Video **52**
- picture quality settings for **50**
- settings **52**

Progressive scan video **26**

R

Recording **33 – 40**

- automatic chapter marking **52**
- copy-protection and **34**
- copyright and **34**
- on-screen displays **26**
- optimized **52**
- settings **52**
- timer programs **35 – 38**
- TV programs **22, 35, 37**
- using an external input **39, 51**
- Video mode vs. VR mode **33**

Remote control

- buttons explained **18**
- changing the batteries **8**
- operating range **8**
- setting the remote ID **48**

S

Subtitles

- setting preferences for **54**
- switching **31**

T

TV channels

- automatic tuning **20**
- changing **22**
- manual setting **47**
- numbering **23, 46**
- recording **22, 35, 37**
- SAP audio channels and **17, 23, 32, 33, 35**
- VCR Plus+ Guide channels **37, 47**

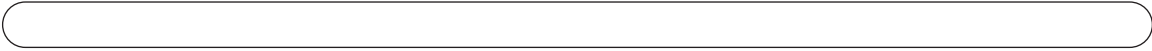

V

Video CD

compatibility **8**

playback control (PBC) **24, 55**

playback controls for **24, 27 – 32**

Should this product require service in the U.S.A. and you wish to locate the nearest Pioneer Authorized Independent Service Company, or if you wish to purchase replacement parts, operating instructions, service manuals, or accessories, please call the number shown below.

8 0 0 - 4 2 1 - 1 4 0 4

Please do not ship your product to Pioneer without first calling the Customer Support Division at the above listed number for assistance.

Pioneer Electronics Service, Inc.
Customer Support Division
P.O. BOX 1760, Long Beach,
CA 90801-1760, U.S.A.

For warranty information please see the Limited Warranty sheet included with your product.

Should this product require service in Canada, please contact a Pioneer Canadian Authorized Dealer to locate the nearest Pioneer Authorized Service Company in Canada.
Alternatively, please contact the Customer Satisfaction Department at the following address:

Pioneer Electronics of Canada, Inc.
Customer Satisfaction Department
300 Allstate Parkway, Markham, Ontario L3R OP2
(905)479-4411
1(877)283-5901

For warranty information please see the Limited Warranty sheet included with your product.

Si ce produit doit être réparé au Canada, veuillez vous adresser à un distributeur autorisé Pioneer du Canada pour obtenir le nom du Centre de Service Autorisé Pioneer le plus près de chez-vous. Vous pouvez aussi contacter le Service à la clientèle de Pioneer:

Pioneer Electroniques du Canada, Inc.
Service à la clientèle
300, Allstate Parkway, Markham, Ontario L3R OP2
(905)479-4411
1(877)283-5901

Pour obtenir des renseignements sur la garantie, veuillez vous reporter au feuillet sur la garantie restreinte qui accompagne le produit.

S018D_enfr

Published by Pioneer Corporation.
Copyright © 2004 Pioneer Corporation.
All rights reserved.

PIONEER CORPORATION

4-1, Meguro 1-Chome, Meguro-ku, Tokyo 153-8654, Japan

PIONEER ELECTRONICS (USA) INC.

P.O. BOX 1540, Long Beach, California 90810-1540, U.S.A. TEL: (800) 421-1404

PIONEER ELECTRONICS OF CANADA, INC.

300 Allstate Parkway, Markham, Ontario L3R OP2, Canada TEL: (905) 479-4411

PIONEER EUROPE NV

Haven 1087, Keetberglaan 1, B-9120 Melsele, Belgium TEL: 03/570.05.11

PIONEER ELECTRONICS ASIACENTRE PTE. LTD.

253 Alexandra Road, #04-01, Singapore 159936 TEL: 656-472-1111

PIONEER ELECTRONICS AUSTRALIA PTY. LTD.

178-184 Boundary Road, Braeside, Victoria 3195, Australia, TEL: (03) 9586-6300

PIONEER ELECTRONICS DE MEXICO S.A. DE C.V.

Blvd.Manuel Avila Camacho 138 10 piso Col.Lomas de Chapultepec, Mexico,D.F. 11000 TEL: 55-9178-4270

K002E

Printed in China

<VRB1365-A>

Free Manuals Download Website

<http://myh66.com>

<http://usermanuals.us>

<http://www.somanuals.com>

<http://www.4manuals.cc>

<http://www.manual-lib.com>

<http://www.404manual.com>

<http://www.luxmanual.com>

<http://aubethermostatmanual.com>

Golf course search by state

<http://golfingnear.com>

Email search by domain

<http://emailbydomain.com>

Auto manuals search

<http://auto.somanuals.com>

TV manuals search

<http://tv.somanuals.com>