

PLUS

DATA PROJECTOR

V-1080/V-807

User's Manual

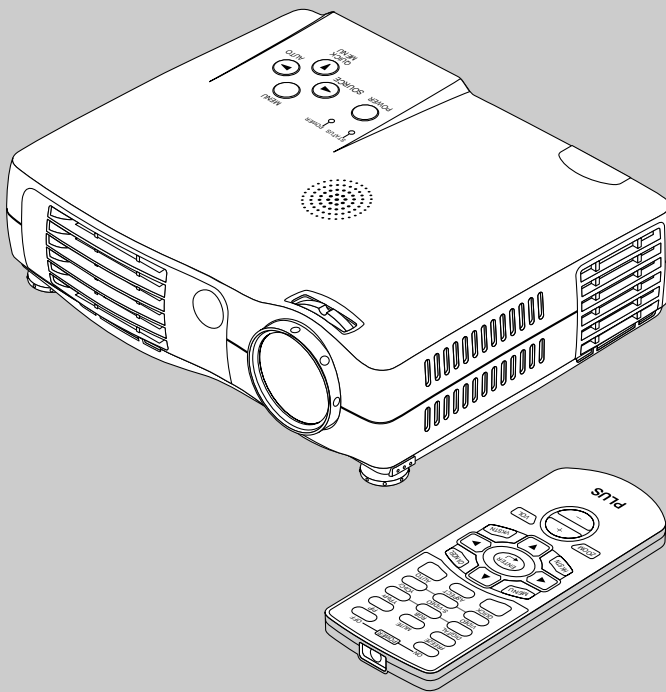

IMPORTANT

Digital Light Processing, DLP, Digital Micromirror Device and DMD are all trademarks of Texas Instruments.

Windows 98, Windows 95, and Windows 3.1 are registered trademarks in the United States and other countries of Microsoft Corporation.

IBM is a registered trademark of International Business Machines Corporation.

Macintosh and MAC are trademarks of Apple Computer Inc.

Other names of companies and products mentioned are trademarks and registered trade-marks of the respective companies. TM , ® and © marks are not used in this document.

IMPORTANT SAFETY INFORMATION

Precautions

Please read this manual carefully before using your PLUS V-1080 / V-807 Data Projector and keep the manual handy for future reference.



CAUTION

TO PREVENT SHOCK, DO NOT OPEN THE CABINET. NO USER-SERVICEABLE PARTS INSIDE. REFER SERVICING TO QUALIFIED PLUS SERVICE PERSONNEL.



This symbol warns the user that uninsulated voltage within the unit may have sufficient magnitude to cause electric shock. Therefore, it is dangerous to make any kind of contact with any part inside of this unit.



This symbol alerts the user that important literature concerning the operation and maintenance of this unit has been included. Therefore, it should be read carefully in order to avoid any problems.

The above cautions are given on the bottom of the product.

WARNING

TO PREVENT FIRE OR SHOCK, DO NOT EXPOSE THIS UNIT TO RAIN OR MOISTURE. DO NOT USE THIS UNIT'S GROUNDED PLUG WITH AN EXTENSION CORD OR IN AN OUTLET UNLESS ALL THREE PRONGS CAN BE FULLY INSERTED. DO NOT OPEN THE CABINET. THERE ARE HIGH-VOLTAGE COMPONENTS INSIDE. ALL SERVICING MUST BE DONE BY QUALIFIED PLUS SERVICE PERSONNEL.

WARNING

This is a class A product. In a domestic environment this product may cause radio interference in which case the user may be required to take adequate measures.

RF Interference

WARNING

The Federal Communications Commission does not allow any modifications or changes to the unit EXCEPT those specified by PLUS Technologies in this manual. Failure to comply with this government regulation could void your right to operate this equipment. This equipment has been tested and found to comply with the limits for a Class A digital device, pursuant to Part 15 of the FCC Rules. These limits are designed to provide reasonable protection against harmful interference when the equipment is operated in a commercial environment. This equipment generates, uses, and can radiate radio frequency energy and, if not installed and used in accordance with the instruction manual, may cause harmful interference to radio communications. Operation of this equipment in a residential area is likely to cause harmful interference in which case the user will be required to correct the interference at his own expense.

Important Safeguards

These safety instructions are to ensure the long life of the unit and to prevent fire and shock. Please read them carefully and heed all warnings.

Installation

- For best results, use the unit in a darkened room.
- Place the unit on a flat, level surface in a dry area away from dust and moisture.
- Do not place the unit in direct sunlight, near heaters or heat radiating appliances.
- Exposure to direct sunlight, smoke or steam can harm internal components.
- Handle the unit carefully. Dropping or jarring can damage internal components.
- Do not place heavy objects on top of the unit.

Power Supply

- The unit is designed to operate on a power supply of 100 - 240 V 50/60 Hz AC. Ensure that your power supply fits these requirements before attempting to use the unit.
- For PLUGGABLE EQUIPMENT, the socket-outlet shall be installed near the equipment and shall be accessible.
- Handle the power cable carefully and avoid excessive bending. A damaged cord can cause electric shock or fire.
- Disconnect the power cable (mains lead) from the power outlet after using the unit. Before disconnecting the power cable, make sure that the POWER indicator lights in amber (not blinking or in green).

Cleaning

- Disconnect the power cable (mains lead) from the unit.
- Clean the cabinet of the unit periodically with a damp cloth. If heavily soiled, use a mild detergent. Never use strong detergents or solvents such as alcohol or thinner.
- Use a blower or lens paper to clean the lens, and be careful not to scratch or mar the lens.
- Clean the ventilation slots and speaker grills on the unit periodically using a vacuum cleaner. If accumulated dust blocks the ventilation slots, the unit will overheat, which may cause the unit to malfunction.
Use a soft brush attachment when using the vacuum cleaner. Do not use a hard attachment, such as a crevice tool, to prevent the damage to the unit.

Lamp Replacement

- Be sure to replace the lamp when the Status indicator comes on. If you continue to use the lamp after 1000 hours of usage, the lamp will turn off.

IMPORTANT SAFETY INFORMATION

Fire and Shock Precautions

- Ensure that there is sufficient ventilation and that vents are unobstructed to prevent the buildup of heat inside the unit. Allow at least 10 cm (3 inches) of space between the unit and walls.
- Prevent foreign objects such as paper clips and bits of paper from falling into the unit. Do not attempt to retrieve any objects that fell into the unit. Do not insert any metal objects such as a wire or screwdriver into the unit. If something should fall into the unit, immediately disconnect the power cable from the unit and have the object removed by a qualified PLUS service person.
- Do not place any liquids on top of the unit.
- **Do not look into the lens while the unit is on. Serious damage to your eyes could result.**

Carrying around

When carrying the unit around, please use the carrying case that comes with it and, to protect the lens from scratches, always shut the sliding lens cap. Also, do not subject the unit to strong mechanical shock.

Major Features

■ **Book-sized, lightweight (at about 0.9 kg/2.0 lbs) and small high-intensity mobile projector**

DMD™ and the synergistic effects of our own optical design serve to improve the optical utilization efficiency. The three light sources (RGB) required in color expression are reproduced with one DMD™. These factors have enabled a design that offers both high intensity and small size/lightweight features.

■ **Sharp, clear picture**

The absence of RGB color infidelity and the inconspicuous gaps between the individual dots permit the display of small characters and diagrams with distinct clarity. An up-close look reveals the difference even more.

■ **Beautiful reproduction of high-quality images from DVD**

Faithful reproduction of color tones gives rise to the display of natural images. High-quality images such as those from DVD and other sources bring out the display capabilities that are an essential strength of the digital projector.

■ **Heightened effectiveness with picture in picture**

The video image is projected as a sub-picture within the personal computer picture. This expands the usefulness of the projector even more.

■ **Digital technology corrects the horizontal and vertical keystone distortion of the projected picture**

New technology is used to correct the horizontal keystone distortion in addition to the regular keystone correction. This permits even simpler setup adjustments.

■ **Connection permitted for personal computers equipped with DVI connectors**

Inclusion of a DVI connector allows the input of analog RGB signals as well as digital RGB signals. (The supplied conversion cable supports personal computers having a regular analog RGB connector. See the Table of Supported Frequencies on Page 69 for information about display resolution.)

Table of Contents

Preparation and Background Knowledge

IMPORTANT SAFETY INFORMATION	E-2
Major Features	E-5
Table of Contents	E-6
Checking the Supplied Accessories	E-8
Names of the Main Unit Parts	E-10
Names of the Remote Control Parts	E-12
Preparing the Remote Control	E-13
Button Battery Replacement	E-13
Remote Control Range	E-14

Setup and Projection

The Procedure Up to Projecting to the Screen	E-15
-----------------------------------------------------------	------

Placement Guide

V-807 Screen Size and Projection Distance	E-16
V-1080 Screen Size and Projection Distance	E-17

Connecting Personal Computers and Video Equipment

Connections with PC Connectors

Personal Computers with a DVI Connector	E-18
Personal Computers with a Mini D-Sub 15-Pin Connector	E-19
To Output the External Output Signal of a Notebook Computer	E-20

Connections with Video Connectors

Video Equipment with VIDEO Connectors	E-21
Video Equipment with S-VIDEO Connectors	E-21

Connections with Component Signals

When the Video Connectors are Y, Cb, and Cr Connectors	E-22
When the Video Connectors are Y, Pb, and Pr Connectors	E-22

Connections with Audio Connectors	E-23
-----------------------------------------	------

Power Cable Connections and Switching the Power On/Off

Operating	E-24
Finishing	E-25

Adjustment of the Projection Screen

Projection Screen Position Adjustment	E-26
Making Adjustments with the Adjusters	E-27
Focus Adjustment	E-27

General Operation

Input Selection	E-28
Automatic Adjustment of Analog RGB	E-29
Selection of Aspect Ratio	E-30
Projecting a Sub-Picture	E-31
Freezing a Moving Picture	E-31
Cancelling Video and Audio Temporarily	E-31
Using the Quick Menu	E-32
Correcting Keystone Distortion of the Projection Screen	E-34
Enlargement of the Image and Video Movement	E-35
Adjustment of the Volume	E-36

Menu Operations

Menu Operation Method	E-37
Names and Functions of the Parts	E-37
Names and Functions of the Remote Control Buttons that Operate Via a Menu	E-37
Names and Functions of the Main Unit Buttons Used in Menu Operation	E-38
Names and Functions of Menu Screen Parts	E-38
Performing Menu Operations	E-39
Selecting Another Menu Name with Remote Control Operation	E-43
List of Item Names Offering Input Selection and Adjustments/Settings	E-44

Adjustments and Settings

Picture	
Brightness / Contrast / Color / Tint / Sharpness	E-46
Picture Adjustment / Fine Picture / H Position / V Position	E-47
Reset	E-48
Color	
Gamma	E-49
Color Temp.	E-49
Color System	E-50
Color Space	E-50
View	
Aspect	E-51
Filter	E-52
Projection	E-52
Keystone	E-53
Picture in Picture	E-54
Setup	
Language	E-55
Auto Source	E-55
Auto Power Off	E-56
On Screen	E-56
Menu Position	E-57
YPbPr	E-57
Background	E-57
White Balance	E-58
Info.	
Status	E-59
Factory Default	E-59
Lamp Timer Reset	E-59
Resolution / Frequency	E-60
Lamp Timer	E-60

Miscellaneous

When the STATUS Indicator is Lit/Flashes	E-61
Troubleshooting	E-63
Cleaning	E-65
Replacing the Lamp Cartridge	E-66
Specifications	E-69
Table of Supported Frequencies	E-70
Cabinet Dimensions	E-71

Checking the Supplied Accessories

Remove the main unit and the accessories from the box and check that the following items are included.

Remote control (includes one button battery) [1]

This controls the projector. Please remove the transportation insulation sheet at time of purchase. (See Page E-13.)

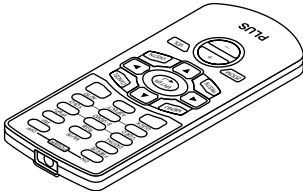

Power cable (1.8 m / 5.9 feet) [1]

This power cable supplies power to the unit. See Page E-24 about connections.

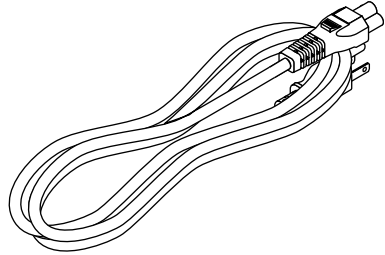

DVI / Mini D-sub 15-pin conversion cable (19 cm / 0.6 feet) [1]

This is used when the monitor connector of the personal computer is a mini D-sub 15-pin connector. See Page E-19, 22 about connections.

No. 772708000

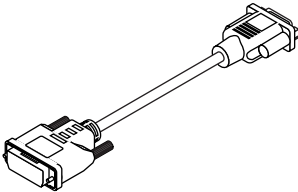

RGB signal cable (Mini D-sub 15-pin, 2 m / 6.6 feet) [1]

This is used when the monitor connector of the personal computer is a mini D-sub 15-pin connector. See Pages E-19 about connections.

No. 772709000

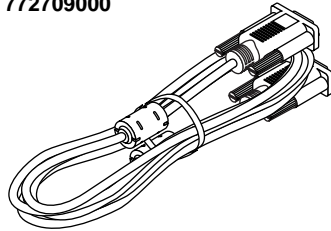

S-Video cable (3.5 mm diameter plug / Mini DIN 4-pin plug, 1.5 m / 4.9 feet) [1]

This cable is used in the connection of video equipment that has an S-video connector. Connections are described on Page E-21.

No. 772705000

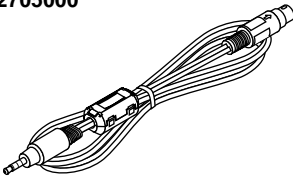

Video cable (3.5 mm diameter plug / RCA pin plug, 1.5 m / 4.9 feet) [1]

This cable is used in the connection of video equipment that has an RCA jack type video connector. Connections are described on Page E-21.

No. 772704000

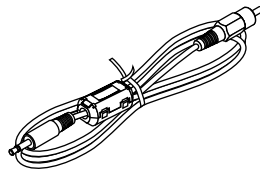

Audio cable (2.5 mm diameter plug / RCA pin plug, 1.5 m / 4.9 feet) [1]

This cable is used with equipment that has phono type audio jacks. Connections are described on Page E-23.

No. 772706000

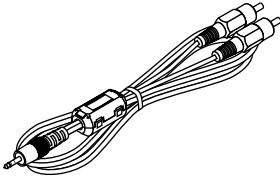

User's Manual (CD-ROM edition) [1] User's Manual (Simplified Edition) [1]

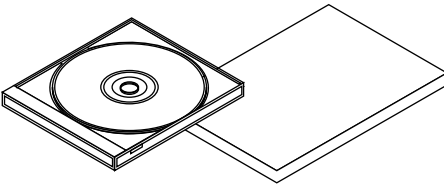

Soft pouch (for projector and accessories) [1]

This pouch is used when storing or moving the projector. The pouch is made up of two portions that are joined by hook-and-loop tape to form a single item. The pouch can be separated into two pieces.

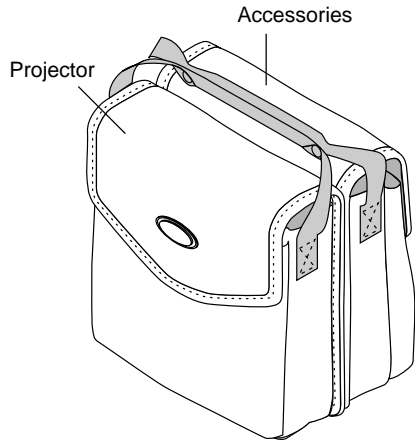

Precautions

- * Leave the power cable plugged in (for 5 to 10 minutes) until the projector returns to room temperature before placing the projector inside the soft pouch. Placing the projector into the pouch soon after switching off the power could cause the projector to break down.
- * Be sure to attach the lens cap and place the projector into the soft pouch with the lens facing upward.

Names of the Main Unit Parts

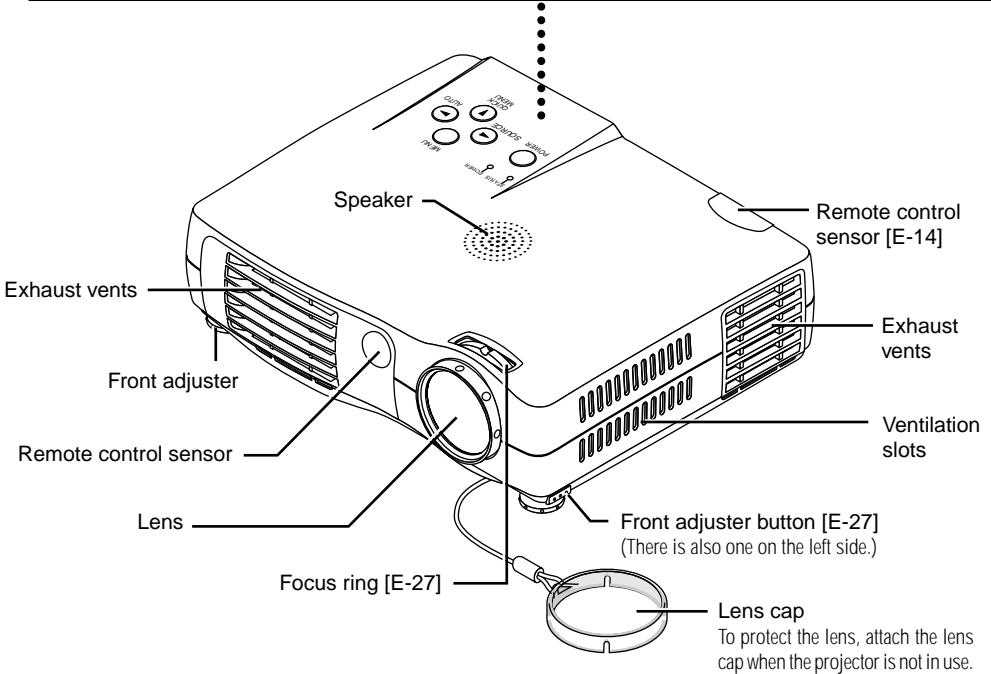
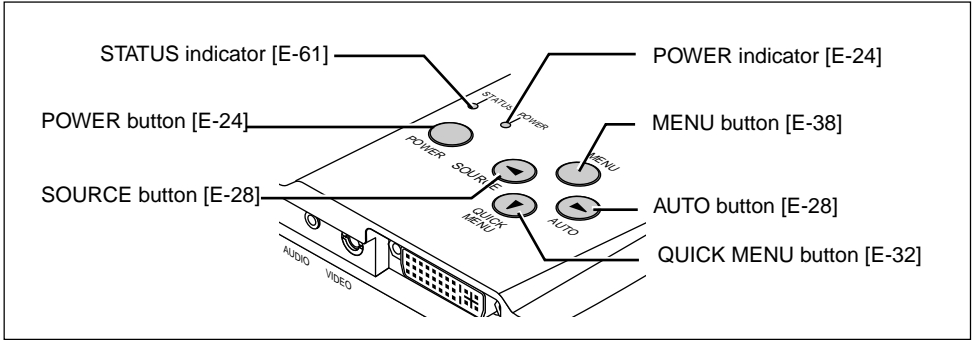

Precautions

The ventilation slots discharge the heat of the lamp and care must be taken not to come into contact with them.

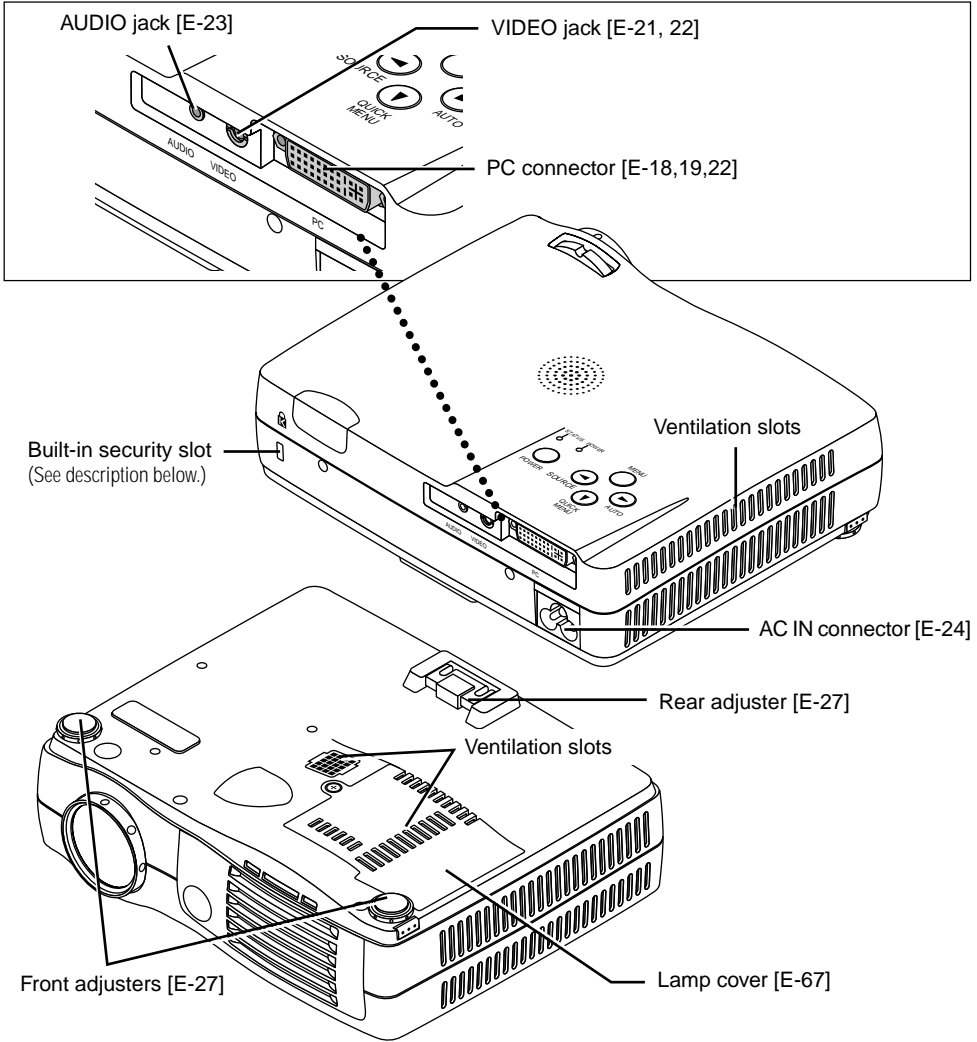

Built-in Security Slot

This security slot supports the MicroSaver Security System manufactured by Kensington Microware Inc.

Names of the Remote Control Parts

Infrared transmitter [E-14]

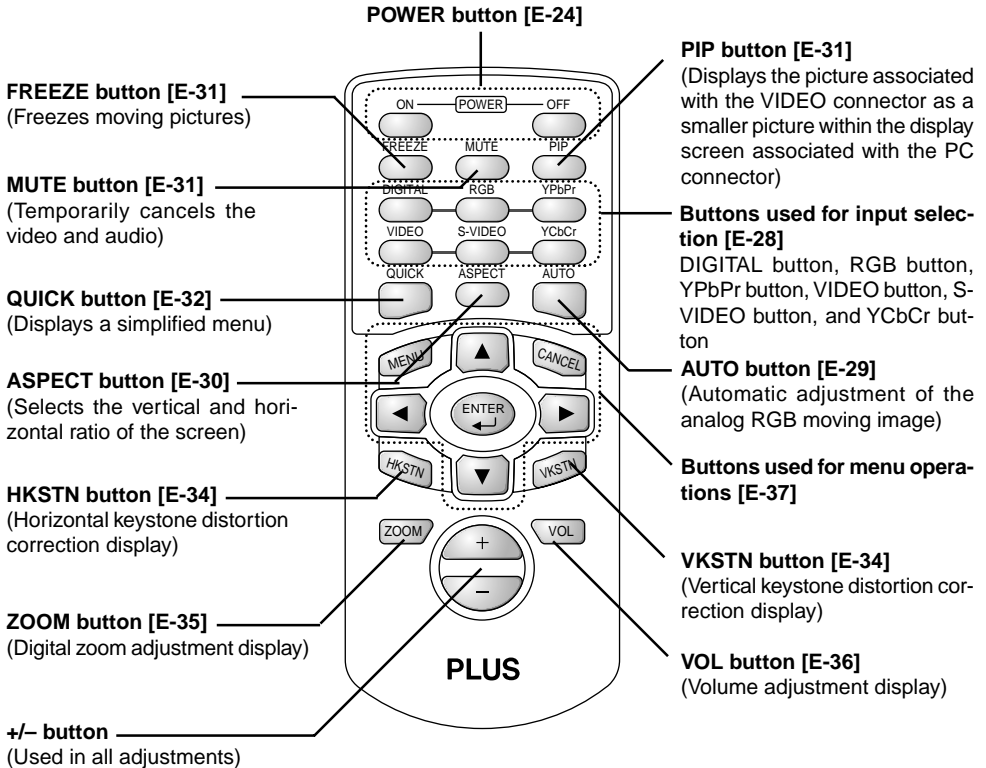
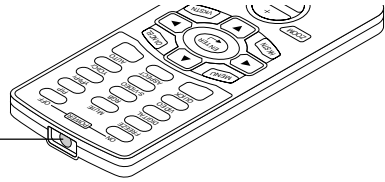

Precautions

Handling of the Remote Control

- * Do not drop the remote control or handle it inappropriately.
- * Do not expose the remote control to water or other liquids. Should the remote control become wet, wipe it dry immediately.
- * Try to avoid use in hot and/or humid locations.
- * Please keep button batteries out of the reach of children. If a battery is swallowed, promptly obtain the medical care of a doctor.
- * Remove the batteries from the remote control when it is not going to be used for a long period.
- * Some operations (such as menu operations) are available only through the use of the remote control and attention should be given to its careful handling.

Preparing the Remote Control

Button Battery Replacement

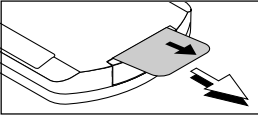

Using the remote control for the first time

The battery compartment is fitted with a transportation insulation sheet at the time of shipping. Pull out the sheet and remove it. The remote control is now ready for use.

Replacement Method

- 1 Insert the tip of a ballpoint pen or some other pointed object into the hole of the battery holder, then pull out to open.

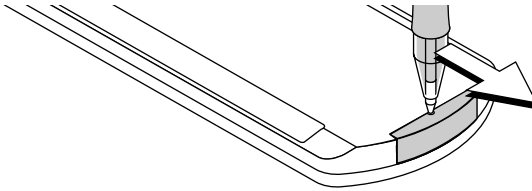

- 2 Remove the old battery and install a new button battery with (+) side facing upward in the battery holder.

Purchase a CR2025 type battery for replacement.

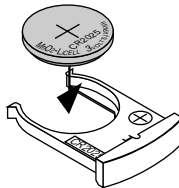

- 3 Insert the battery holder into the remote control and push in until the battery holder closes with a "click" sound.

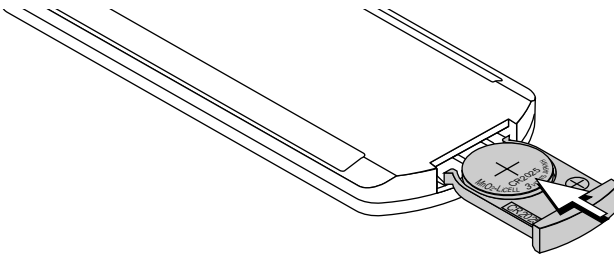

Preparing the Remote Control

Remote Control Range

Point the infrared transmitter of the remote control toward the remote control sensor located at the front or rear of the main unit and operate.

Reception of the remote control signal should generally be possible within the range illustrated below.

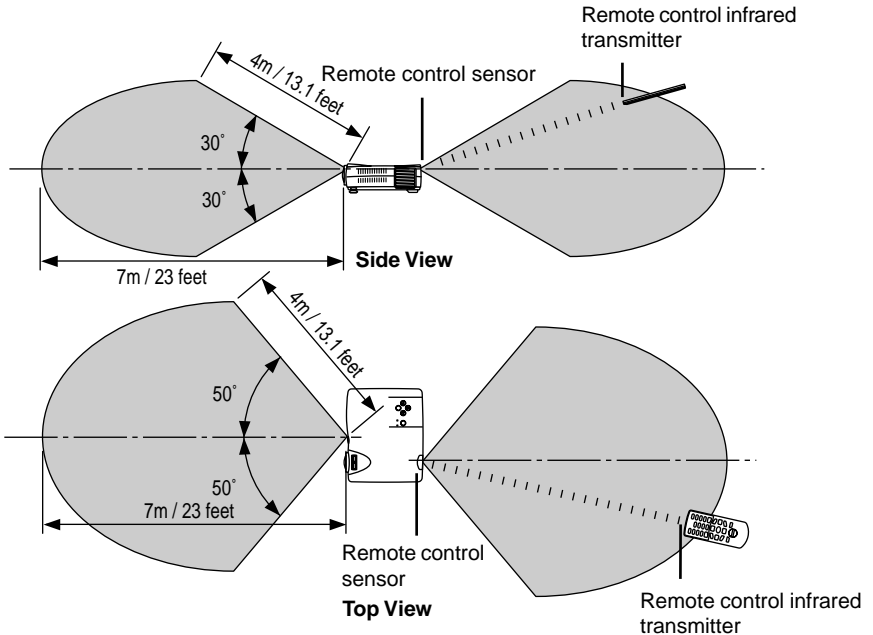

Note

- * Exposure of the main unit's remote control sensor or the remote control infrared transmitter to bright light or the obstruction of the signal by an obstacle located in the pathway may prevent operation.
- * The remote control will not function when the battery is exhausted.

The Procedure Up to Projecting to the Screen

Perform setup adjustments in the following order.

1 Position the projector

See "Projection Distance and Screen Size" on Pages E-16 and E-17.
Determine the locations to set up the screen and the projector.

2 Connect the video equipment and personal computer

Connect your equipment to the projector.

When the personal computer has a DVI connector or a mini D-sub 15-pin connector

See "Connections with PC Connectors" on Page E-18.

When the video equipment has a video connector or an S-video connector

See "Connections with Mini D-Sub 15-Pin Connectors" on Page E-19.

When the video equipment has a YCbCr connector or a YPbPr connector

See "Connections with Component Signals" on Page E-22.

When playing the audio through the built-in speaker of the projector

See "Connections with the AUDIO Jack" on Page E-23.

3 Connecting the power cable and switching on the power

See "Operating" on Page E-24.

See "Finishing" on Page E-25.

4 Switching on the power of the personal computer and video equipment

5 Properly adjust the projection image to the screen

See "Projection Screen Position Adjustment" on Page E-26.

6 Focusing

See "Focus Adjustment" on Page E-27.

7 Selecting input equipment

See "Input Selection" on Page E-28.

8 Adjust the screen or video image

Adjust the image to the optimum condition as required.

See the Table of Contents for the adjustment items.

Note

* Please purchase a screen.

* A DVI-D cable (order code 28-697), which is available separately, is required for connections with the DVI connector of the personal computer.

* A component cable (order code 28-698), which is available separately, is required to connect a DVD player or other equipment with YCbCr connectors.

* A component cable (order code 28-690), which is available separately, is required to connect high definition (HD) video equipment or other equipment with YPbPr connectors.

Placement Guide

- Use this information as a guide to find out about the screen size when the projector is placed at a certain location, or to find out the approximate size of a screen that will be required.
- The projection distance over which focussing is adjustable is 1.2 m (3.9 feet) to 6.9 m (22.6 feet) from the front of the main unit lens for V-807 and 1.2 m (3.9 feet) to 6.6 m (21.7 feet) for V-1080. The projector should be placed within this range.
- Please see the projection distance table for the model of projector that you have purchased.

V-807 Screen Size and Projection Distance

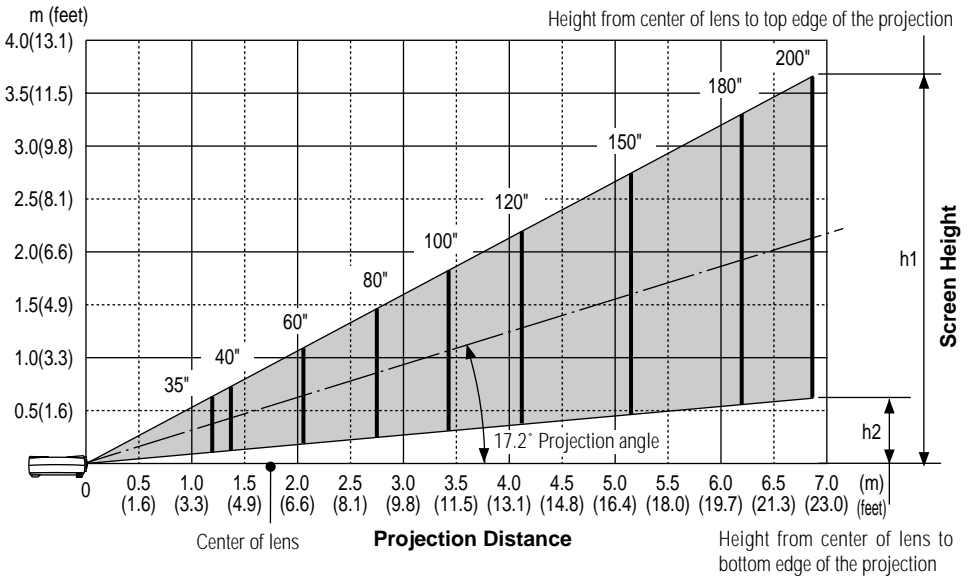

Screen Size Designation (Inches)	Screen Size Width x Height		Projection Distance		Height h1		Height h2	
	(m)	(feet)	(m)	(feet)	(m)	(feet)	(m)	(feet)
35"	0.71 × 0.53	2.33 × 1.74	1.20	3.94	0.64	2.10	0.11	0.36
40"	0.81 × 0.61	2.66 × 2.00	1.37	4.49	0.73	2.40	0.12	0.39
60"	1.22 × 0.91	4.00 × 2.99	2.06	6.76	1.09	3.58	0.18	0.59
80"	1.63 × 1.22	5.35 × 4.00	2.75	9.02	1.46	4.79	0.24	0.79
100"	2.02 × 1.52	6.63 × 4.99	3.43	11.25	1.82	5.97	0.30	0.98
120"	2.44 × 1.83	8.00 × 6.00	4.12	13.52	2.19	7.19	0.36	1.18
150"	3.05 × 2.29	10.00 × 7.51	5.15	16.90	2.74	8.99	0.45	1.48
180"	3.66 × 2.74	12.00 × 8.99	6.18	20.28	3.29	10.79	0.54	1.77
200"	4.06 × 3.05	13.32 × 10.00	6.87	22.54	3.65	11.98	0.60	1.97

* There is a tolerance of $\pm 5\%$ due to design values.

* This table uses the lens apex and lens center as references and requires that the projector be in a horizontal condition (with front and rear adjusters fully withdrawn).

V-1080 Screen Size and Projection Distance

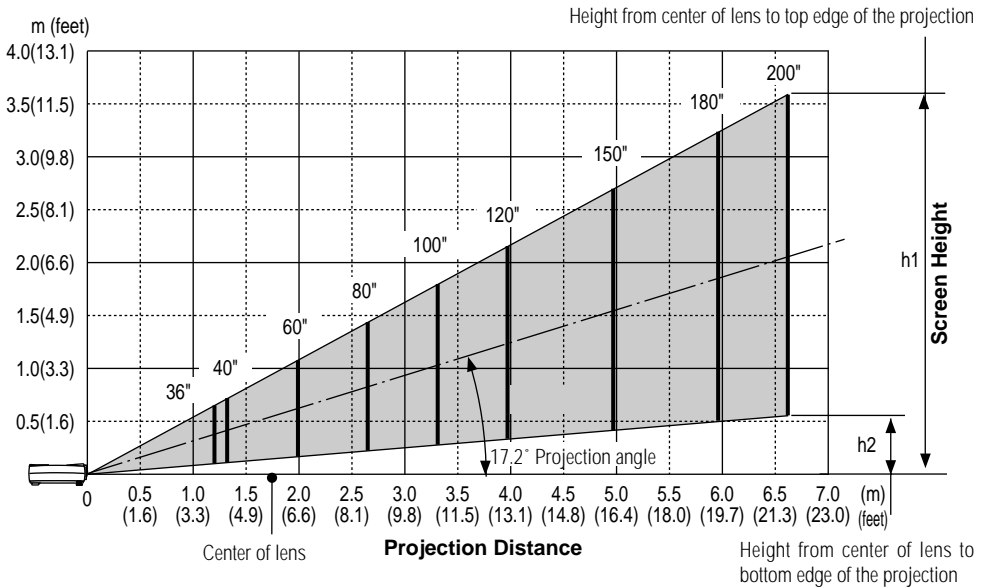

Screen Size Designation (Inches)	Screen Size Width x Height		Projection Distance		Height h1		Height h2	
	(m)	(feet)	(m)	(feet)	(m)	(feet)	(m)	(feet)
36"	0.74 × 0.55	2.43 × 1.80	1.20	3.94	0.65	2.13	0.10	0.33
40"	0.81 × 0.61	2.66 × 2.00	1.32	4.33	0.72	2.36	0.11	0.36
60"	1.22 × 0.91	4.00 × 2.99	1.99	6.53	1.07	3.51	0.16	0.52
80"	1.63 × 1.22	5.35 × 4.00	2.65	8.69	1.43	4.69	0.21	0.69
100"	2.02 × 1.52	6.63 × 4.99	3.31	10.86	1.79	5.87	0.26	0.85
120"	2.44 × 1.83	8.00 × 6.00	3.97	13.02	2.14	7.02	0.31	1.02
150"	3.05 × 2.29	10.00 × 7.51	4.97	16.31	2.68	8.79	0.39	1.28
180"	3.66 × 2.74	12.00 × 8.99	5.96	19.55	3.21	10.53	0.47	1.54
200"	4.06 × 3.05	13.32 × 10.00	6.62	21.72	3.57	11.71	0.52	1.71

* There is a tolerance of ±5% due to design values.

* This table uses the lens apex and lens center as references and requires that the projector be in a horizontal condition (with front and rear adjusters fully withdrawn).

Connecting Personal Computers and Video Equipment

- Connecting this unit with a personal computer permits presentation data to be projected as a large screen display at conferences, lectures, and on other occasions. Furthermore, connecting this unit to a DVD player or other video equipment source in combination with an audio/video amplifier and speaker system will allow you to enjoy convincing home theater.

Connections with PC Connectors

Please check the following matters before making connections to the personal computer.

- * Suitable resolution for V-807 is 800 x 600 dots (S-VGA), and the displayable resolution is XGA (1024 x 768 dots).
- * Suitable resolution for V-1080 is 1024 x 768 dots (XGA), and the displayable resolution is S-XGA (1280 x 1024 dots).
Note that input of a resolution that exceeds the displayable resolution will cease to be projected and should this be the case, you will need to change the resolution to a displayable resolution at the computer side. Check with "Table of Supported Frequencies" on Page E-70.
- * The setting method of the personal computer will differ depending on the personal computer that you are using. For information, read the instruction manual for your personal computer, read the on-line help, or contact the manufacturer of your personal computer.

Personal Computers with a DVI Connector

- * Make the connection with a DVI-D cable and the PC connector of the projector.
When connecting, arrange the connectors in the proper orientation and plug in. Turn the screw knobs and fasten to the connector of the main unit.
- * Switch the input selection of the projector to "Digital RGB".

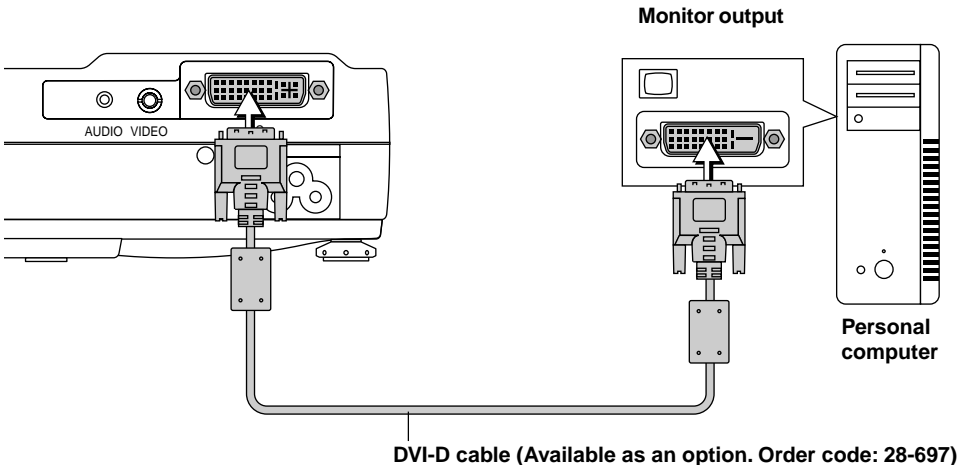

Note

This projector uses a 29-pin DVI connector that supports the digital interface. Digital signal TMDS (Transition Minimized Differential Signalling) of the DVI (Digital Visual Interface) standard is used.

Personal Computers with a Mini D-Sub 15-Pin Connector

- * Make the connection to the projector's PC connector and the mini D-sub 15-pin connector through the use of a DVI/mini D-sub 15-pin conversion cable.
- * When connecting, arrange the connectors in the proper orientation and plug in. Turn the screw knobs and fasten to the connector of the main unit.
- * Switch the input selection of the projector to "Analog RGB".

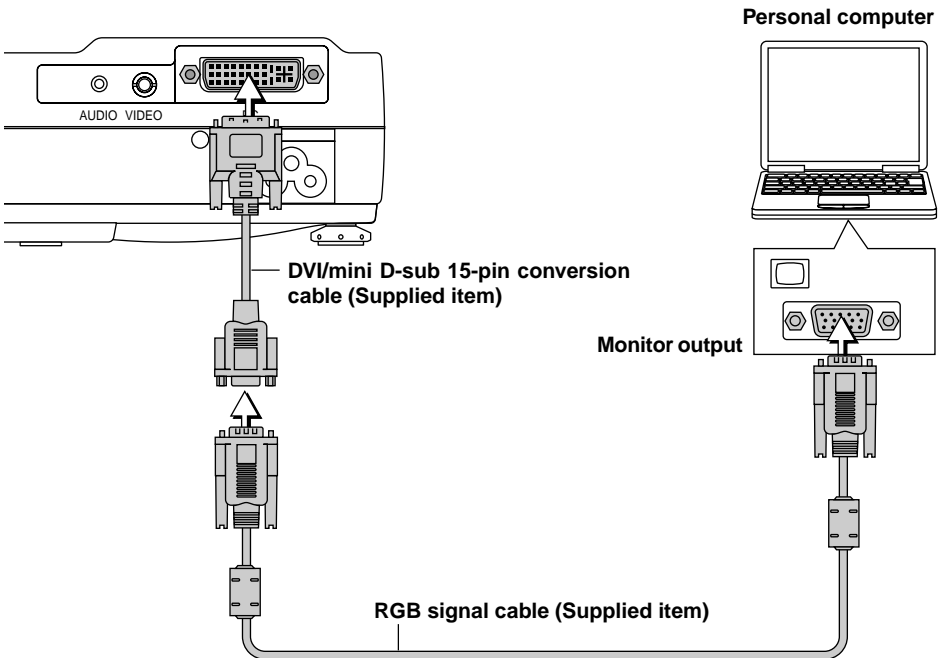

Note

- * Before making connections, check the power of the projector and the equipment to be connected is switched off.
- * When projection will be with a notebook computer connected, knowledge will be required for the cable connection and notebook computer startup procedure as well as the operation that follows startup. Please consult the instruction manual of your notebook computer or the on-line help.

To Output the External Output Signal of a Notebook Computer

When projection will be with a notebook computer connected, knowledge will be required for the cable connection and notebook computer startup procedure as well as the operation that follows notebook startup. Please consult the instruction manual of your notebook computer or the on-line help while performing the following procedure.

- 1 Check whether a signal is being sent from the notebook computer to the projector. An indication appearing on the liquid crystal display of the notebook computer does not necessarily mean that an external output signal is being output.
- 2 Should a sign not be output from the notebook computer, please try the operation described below. For an IBM PC/AT, DOS/V computer, press the [Fn] key plus any one of the [F1] to [F12] keys. (See the table below.)

Manufacturer	Model	Key
akia	All computers	Fn + F2
COMPAQ	ARMADA Series	Fn + F4
	PRESARIO Series	Fn + F3
DELL	All computers	Fn + F8
FUJITSU	All computers	Fn + F10
GATEWAY	All computers	Fn + F3
IBM	All computers	Fn + F7
NEC	All computers	Fn + F3
Panasonic	All computers	Fn + F3
SHARP	All computers	Fn + F5
SONY	All computers	Fn + F7
SOTEC	All computers	Fn + F3
TOSHIBA	All computers	Fn + F5

Note: Table information is current to June 2001.

Note

When the liquid crystal display of the notebook computer and the projector are displayed at the same time, the projected image might not be correct even though the liquid crystal display shows a correct indication. Should this occur, stop the simultaneous display of the notebook computer and try the mode with external output only. (Try an operation such as that described in aforementioned Step 2 and try closing the liquid crystal panel which might result in external output only.)

Connections with Video Connectors

Video Equipment with VIDEO Connectors

- * Make the connection to the VIDEO connector of the projector using a video cable.
- * Switch the input selection of the projector to "Video".

Video Equipment with S-VIDEO Connectors

- * Make the connection to the VIDEO connector of the projector using an S-video cable.
- * Switch the input selection of the projector to "S-Video".

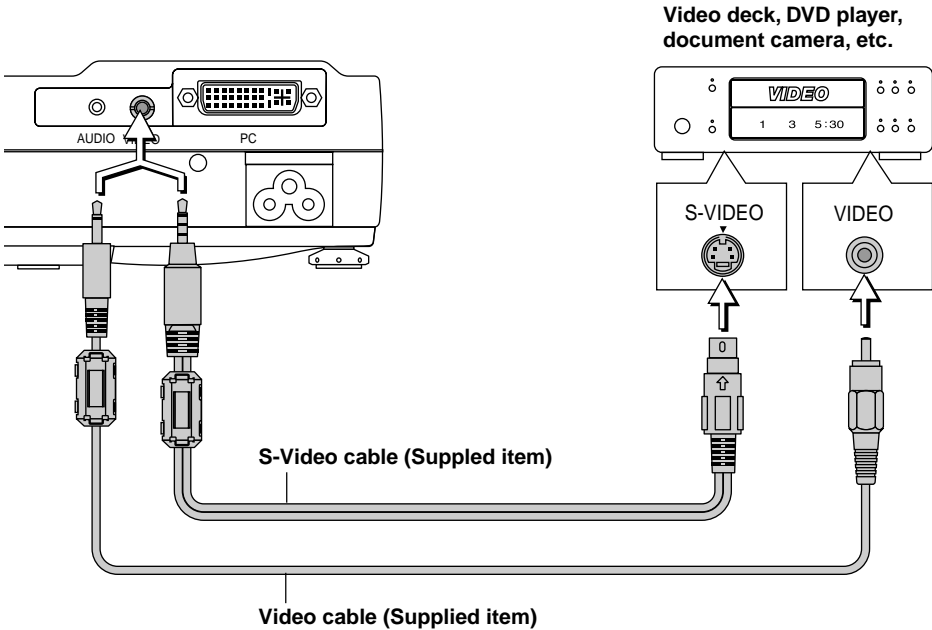

Note

This projector's video cable and S-video cable are special cables. When purchasing extension cables, please contact your dealer.

Connections with Component Signals

When the Video Connectors are Y, Cb, and Cr Connectors

- * Make the connection to the projector's VIDEO connector using a component signal cable.
- * Switch the input selection of the projector to "YCbCr".

When the Video Connectors are Y, Pb, and Pr Connectors

- * Connect a DVI/mini D-sub 15-pin conversion cable to the PC connector of the projector, then make a further connection using a component cable (which is available as an option).
- * Switch the input selection of the projector to "YPbPr".

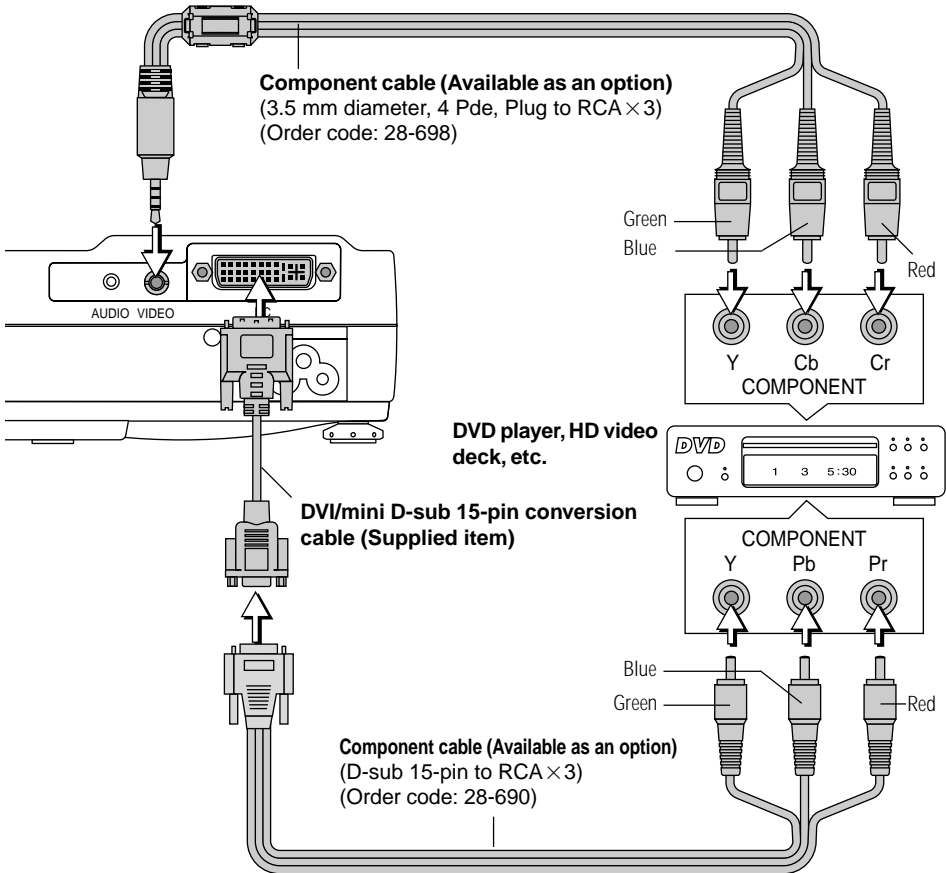

Note

YCbCr cannot accept the input of signals other than NTSC 3.58 and PAL.

Connections with Audio Connectors

- * Make the connection to the projector's AUDIO jack using an audio cable.
- * The built-in speaker of the projector provides monaural audio.
- * To enjoy convincing audio reproduction, please connect the audio output of the video equipment to your audio system.

Video equipment, personal computer

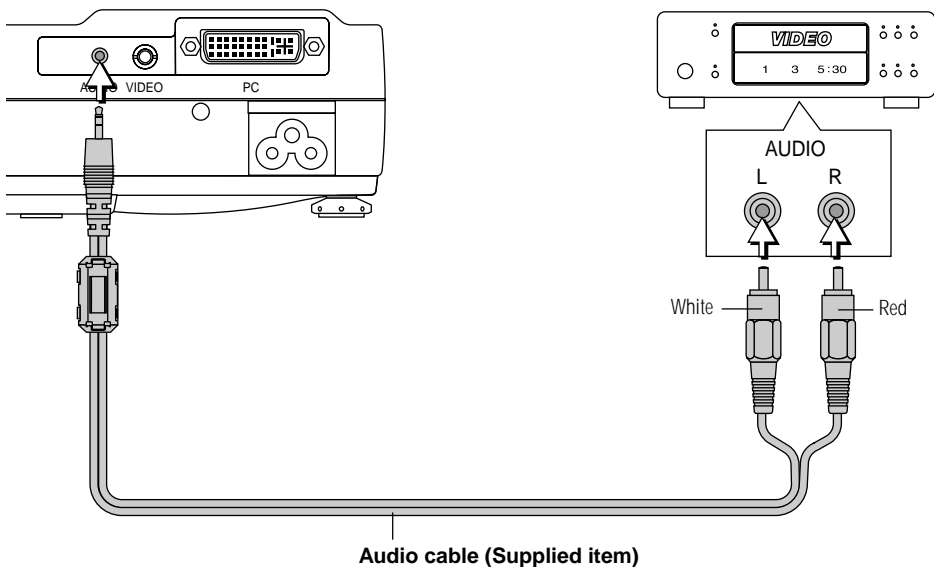

Note

The AUDIO jack of the projector is a 2.5 mm diameter stereo mini jack. Connection is not possible using the common (3.5 mm diameter) stereo mini jack cable from the headphone jack of the personal computer or video equipment.

Power Cable Connections and Switching the Power On/Off

There is an order in which the power cable is connected and the power is switched on/off.

Operating

1 Connect the AC IN connector of the projector and the power outlet using the supplied power cable.

The POWER indicator will light amber, the cooling fan will rotate at low speed, and the unit will enter the standby mode.

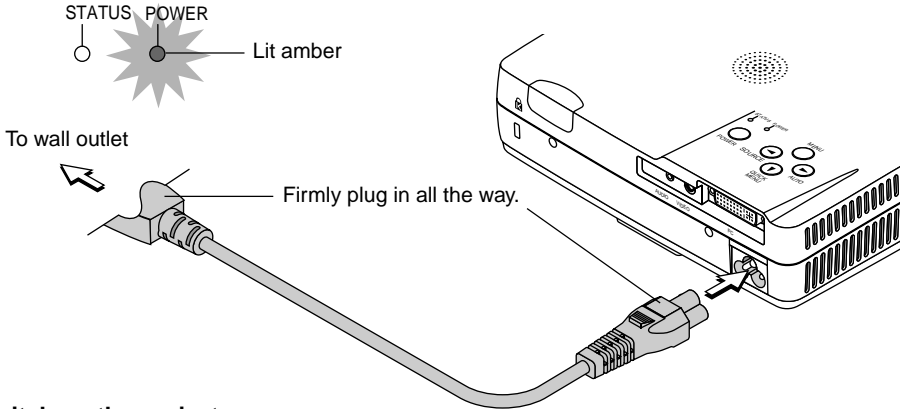

2 Switch on the projector power

Main unit operation: Press and hold the POWER button for a while.

Remote control operation: Press the POWER ON button.

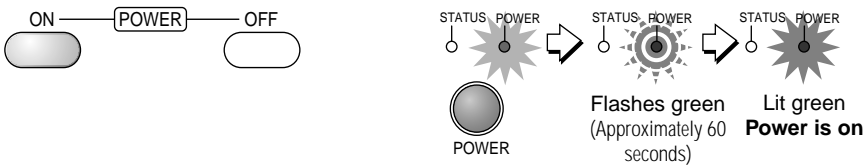

The POWER indicator changes to a flashing green and lights steadily after about 60 seconds. The projection screen brightens after about 40 seconds.

The projector is now capable of regular projection.

3 Switch on the power of the connected equipment

Note

When the power plug will be unplugged from the power outlet, please place the projector near the power outlet so that it may be reached easily.

Finishing

1 Switch off the power of the connected equipment

2 Switch off the power of the projector

Main unit operation: Press and hold the POWER button for a while.

Remote control operation: Press the POWER OFF button.

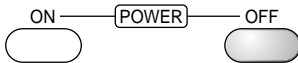

The "Power Off" indication will appear. When the red bar extends fully (in about 5 seconds), the projection screen will go off and the unit will enter the power off operation.

Note

- * The operation can be cancelled by pressing a button other than the POWER button.
- * One more press of the POWER (POWER OFF) button will switch off the power.

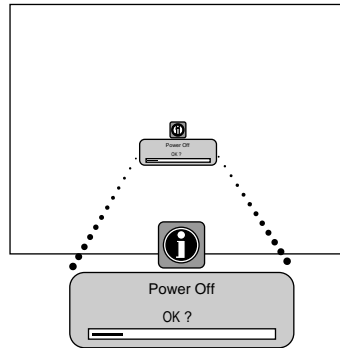

The POWER indicator changes to flashing amber and lights a steady amber after about 60 seconds (when the unit enters the standby mode).

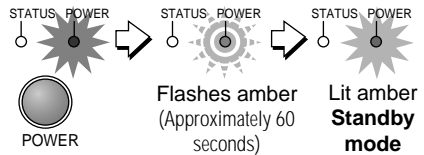

3 Unplug the power cable

Check that the POWER indicator is lit in amber and then unplug the power cable.

The POWER indicator will go off when the power cable is unplugged.

Warning

Under normal circumstances, please do not unplug the power cable unless the POWER indicator is lit in amber. Doing so may shorten the life of the lamp or result in breakdown of the projector.

Do not unplug the power cable while the POWER indicator is flashing amber. Doing so may shorten the life of the lamp or damage the projector.

Adjustment of the Projection Screen

Switch on the power of the connected equipment and make the adjustments with the video signal being input to the projector.

Projection Screen Position Adjustment

Adjust the projection image to the screen.

Check that the screen is set level and vertically.

- (1) If the image is shifted to the left or right, move the main unit horizontally. (Align the center of the screen and the center of the lens of the main unit.)
- (2) If the image is shifted vertically, move the image up or down with the adjuster. See "Making Adjustments with the Adjusters" on Page E-27.
- (3) If the image is slanted, adjust by turning the right or left front adjuster. See "Making Adjustments with the Adjusters" on Page E-27.
- (4) A projection image such as that illustrated in the diagram is the result of the projector not being perpendicular to the screen. Set the projector so that it is pointing straight toward the screen.
- (5) If the image shows keystone distortion, adjust using remote control or menu operations. See "Correcting Keystone Distortion of the Projection Image" on Page E-34.

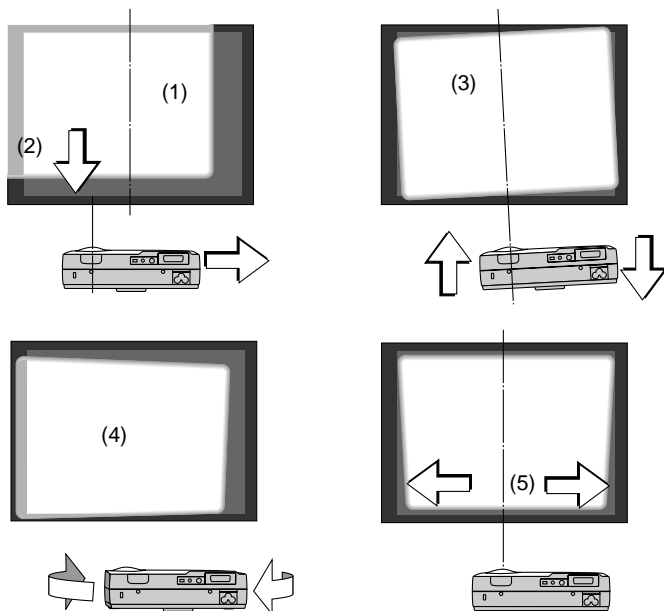

Note

The projection image can be turned upside down or turned left to right using menu operations. See "Projection" on Page E-52.

Making Adjustments with the Adjusters

Raising the projection image

While viewing the projection image, press hand hold the front adjuster buttons located at the left and right (1) and, raise the projector to align the image with the screen, then release your fingers (2).

Turn the left and right front adjusters for fine adjustment. Adjust so that there is no shaking of the projector.

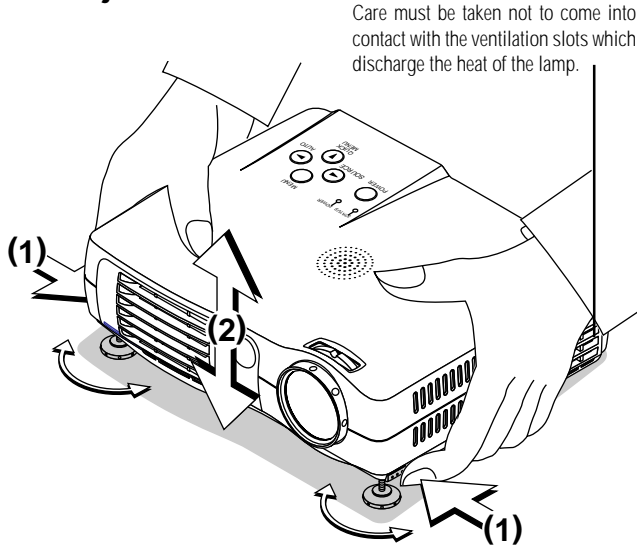

Care must be taken not to come into contact with the ventilation slots which discharge the heat of the lamp.

Lowering the projection image

Lower the front adjusters using the operation described above. Raise the rear adjuster. Turn the left and right front adjusters to make fine adjustments. Adjust so that there is no shaking of the projector.

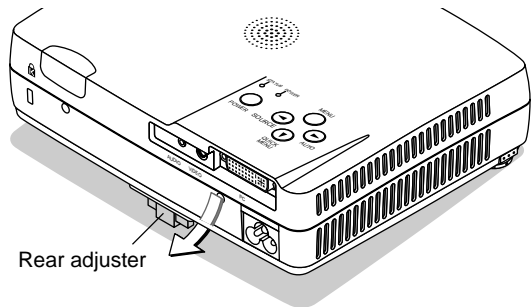

Focus Adjustment

Turn the focus ring to the right or left and adjust the focus.

Should the size of the projection image extend beyond the screen or be smaller than the screen, move the projector forward or backward and readjust the focus.

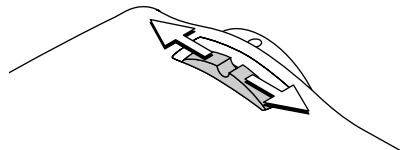

General Operation

This section describes the use of direct operation with the main unit or remote control buttons. For information about operation using the menu, see "Menu Operation Method" on Page E-37 and the various items on Pages E-46 to E-60.

Input Selection

This operation selects the input signal to be projected.

Main unit operation: Press the SOURCE button.
(It will not function while the menu or the quick menu is displayed.)

When Auto Source is On

If there is no input signal at the source that was previously used, the projector automatically selects another source that has the next input signal.

When Auto Source is Off

Each press of the button switches the selection one step in the sequence of Analog RGB → YPbPr → Digital RGB → VIDEO → S-VIDEO → YCbCr.

Remote control operation: Press the desired input selection button.

When Auto Source is On

When an input signal is not present at the selected source, the projector automatically selects the next source that has an input signal.

When Auto Source is Off

The projector switches to the selected source regardless of whether an input signal is present.

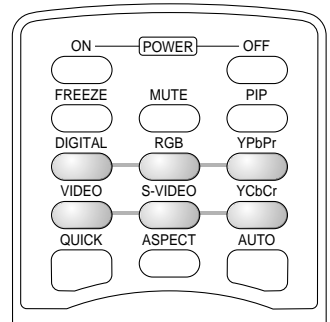
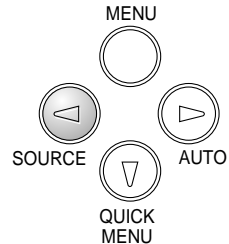

Note

- * When you do not operate source selection, the projector will assume the input selection condition that was previously used.
- * See "Auto Source" on Page E-55 for information about the Auto Source on and off conditions.
- * YPbPr input selection will not be possible when YPbPr is set invalidly. See "YPbPr" on Page E-57.

Automatic Adjustment of Analog RGB

This function automatically adjusts the position shift of the analog RGB input signal, the size of the picture, vertical striping, and color infidelity.

Normally, this function is adjusted automatically at the time of signal selection.

Main unit operation/Remote control operation: Press the AUTO button. (This will not function while the menu or the quick menu is displayed.)

A press of the AUTO button starts the automatic adjustment.

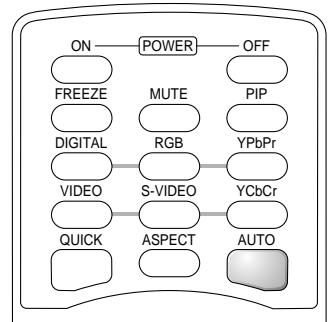
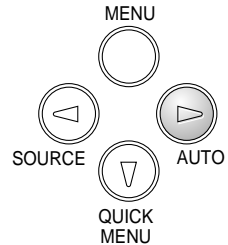

Note

- * If the display position is shifted, vertical lines appear on the picture, or the projection is not good even after using automatic adjustment, please perform image adjustment manually. See "Picture Adj. / Fine Picture / H Position / V Position" on Page E-47.
- * When the image extends beyond the boundaries of the screen or is smaller than the screen, set Aspect to "Auto". See "Selection of Aspect Ratio" on Page E-30 and "Aspect" on Page E-51.

General Operation

Selection of Aspect Ratio

This function selects horizontal and vertical picture proportions of the input signal.

Press the ASPECT button while viewing the projected image and select the aspect ratio.

Personal Computer Image
(when selecting digital RGB or analog RGB)

Each press of the ASPECT button advances the selection one step in the sequence of Auto → Direct → Real, and then repeats.

- Auto Automatically enlarges or reduces the image to project a full screen in a ratio of 4:3
- Direct Maintains the aspect ratio and projects a picture of the maximum displayable size
- Real Projects the input signal without pixel conversion

Image of the Video Equipment
(when selecting VIDEO, S-VIDEO, YCbCr, or YPbPr)

Each press of the ASPECT button advances the selection one step in the sequence of Auto → Wide → Zoom, and then repeats.

- Auto While maintaining the aspect ratio, projects a full screen so that no portions extend beyond the boundaries of the screen. The top and bottom of the 16:9 image becomes black.
- Wide Projects to fill the full width with the entire image at 16:9.
- Zoom Projects only the 4:3 portion within 16:9 image to fill the screen.

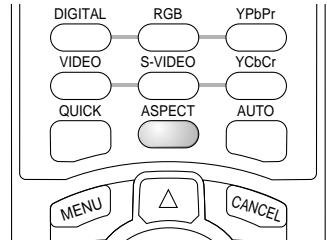

Note

Please note that using this monitor for the purpose of commercial gain or the attraction of public attention in a venue such as a coffee shop or hotel and projecting a 4:3 screen in wide mode or leaving a squeezed screen as a compressed image raises concern about the infringement of copyrights which are protected by copyright law.

Projecting a Sub-Picture

This function displays the video image (i.e., the picture of the VIDEO connector input) on the personal computer screen (i.e., the PC connector input screen) as a sub-picture.

Each press of the PIP button advances the screen size of the sub-picture one step in the sequence of Small → Medium → Large → Off (i.e., the sub-picture display is off), and then repeats.

Note

- * The sub-picture cannot be displayed when the main screen receives the image from the VIDEO connector.
- * The sub-picture cannot be displayed when picture in picture is set to off. The size of the sub-picture can be selected. See "Using the Quick Menu" on Page 32 and "Picture in Picture" on Page E-54.
- * To change the display position of the sub-picture, see "Picture in Picture" on Page E-54.
- * The main picture is termed the Analog RGB, Digital RGB, or YPbPr input screen, whereas the sub-picture is termed the VIDEO, S-VIDEO, and YCbCr input screen.

Sub-picture

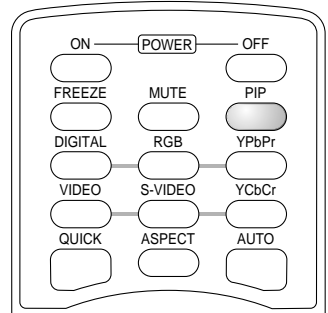
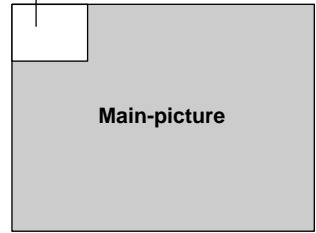

Freezing a Moving Picture

This function is used to stop and view a moving picture. Note that the input image continues to advance even though the picture there is a still picture condition.

A press of the FREEZE button changes the screen to a still picture. A further press returns the screen to a moving picture.

Note

During a picture in picture display, both the main picture and the sub-picture become still pictures.

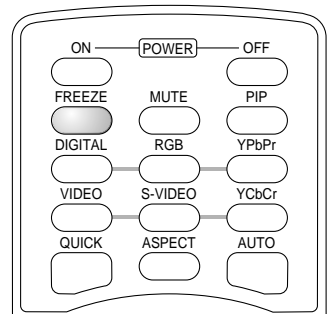

Cancelling Video and Audio Temporarily

This function is used to cancel the video and audio at the same time.

Press the MUTE button to cancel the video and the audio. A further press brings a return to the original condition.

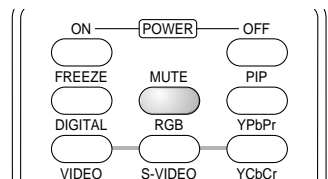

Using the Quick Menu

This function permits frequently used adjustments to be performed quickly.

Note that the Quick Menu will not be displayed unless the signal of the connected equipment is input. Please select the input that you wish to adjust.

Main unit operation

- (1) A press of the QUICK MENU button brings up the quick adjustment display. Further presses allow selection of the desired adjustment display.
- (2) Press the ◀ or ▶ button to make the adjustment.
- (3) To close the display immediately, press the MENU button. In the absence of operations for a period of about 10 seconds, the display will close automatically.

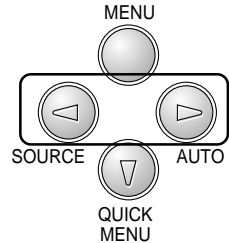

Remote control operation

- (1) A press of the QUICK MENU button brings up the quick adjustment display. Further presses cause the adjustment display to change in sequence. The adjustment display can be selected with use of either the cursor ▲ or ▼ button.
- (2) Press the cursor ◀ or ▶ button to make the adjustment.
- (3) To close the display immediately, press the CANCEL button. In the absence of operations for a period of about 10 seconds, the display will close automatically.

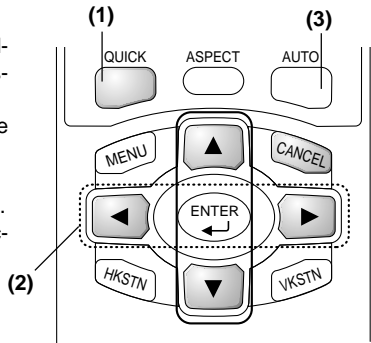

Content of Adjustments and Settings

Example: Brightness adjustment display



Brightness	Adjusts the brightness of the image. Brightness decreases in the (-) direction and increases in the (+) direction.
Contrast	Adjusts the contrast of the image. Contrast becomes less distinct in the (-) direction and more pronounced in the (+) direction.
V Keystone	Corrects (vertical) keystone distortion of the screen. Adjusts the left and right edges of the screen so that they are parallel.
H Keystone	Corrects (horizontal) keystone distortion of the screen. Adjusts the up and down edges of the screen so that they are parallel.
Picture in Picture	The picture from the VIDEO jack is displayed as a sub-picture on the input screen from the PC connector. This function selects either the size of the sub-picture (i.e., large, medium, or small) or off (i.e., no display). (Neither the adjustment display nor the picture will be output unless the signal is input to the PC connector.) See Page E-54 for information about changing the display position of the sub-picture.
Volume	This function adjusts the volume of the built-in speaker. The volume decreases in the (-) direction and increases in the (+) direction.

Correcting Keystone Distortion of the Projection Screen

This adjustment is used when the projection screen is distorted.

Note that extreme distortion cannot be corrected and in such circumstances the projector should be placed to face the screen straight on beforehand.

Adjustment Method

- (1) To adjust up-down distortion (e.g., Screen Example 1), press the HKSTN button. The horizontal keystone adjustment display will appear.



To adjust left-right distortion (e.g., Screen Example 2), press the VKSTN button. The vertical keystone adjustment display will appear.



- (2) While viewing the screen, press the (+) button or the (-) button and adjust the vertical or horizontal edges to be parallel. In Screen Example 3, horizontal and vertical keystone distortion should be adjusted.
- (3) To close the display immediately, press the CANCEL button. In the absence of operations for a period of about 10 seconds, the display will close automatically.

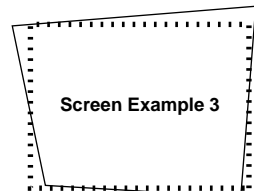
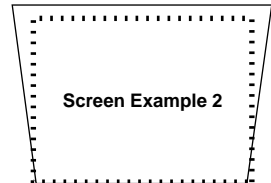
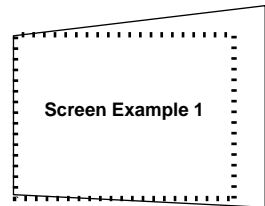
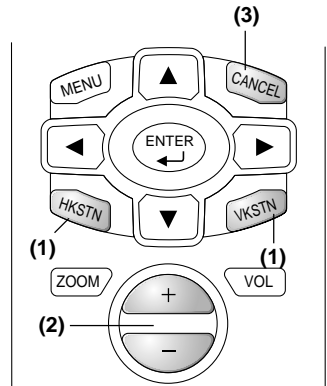

Note

- * The keystone adjustment values can be overwritten and saved. See "Keystone" on Page E-53.
- * Overcompensation of the horizontal keystone correction value will result in a narrowing of the vertical keystone adjustment range. Likewise, overcompensation of the vertical keystone correction value results in a narrowed horizontal adjustment range.
- * Note that the adjustment range will differ depending on the adjustment conditions.
- * The screen examples have been depicted in an exaggerated form to aid in description.

Enlargement of the Image and Video Movement

This function digitally enlarges the personal computer image and video image (up to 10 times).

- Press the ZOOM button.
The zoom selection display will appear.



- Enlarge to the desired size.
Each press of the (+) button enlarges the image and each press of the (-) button makes the image smaller (returning it to 1:1).
- Pressing the cursor (▲▼◀▶) buttons at the time of the zoom operation will cause the display position to move.
(There will not be any movement when zoom is at 0.)
- To close the display immediately, press the CANCEL button.
In the absence of operations for a period of about 10 seconds, the display will close automatically.

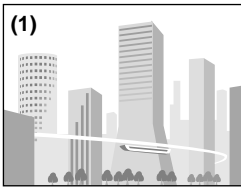
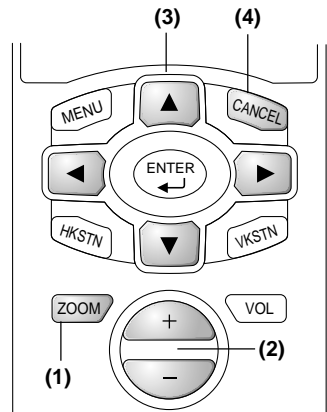

(No enlargement)

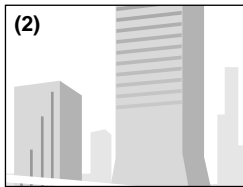

(Approximately 2 times enlargement)

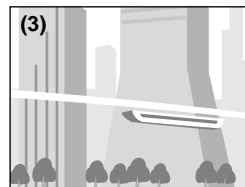

(Movement)

The image can also be moved in the following circumstances.

- * When "Aspect" is set to "Real" by the signal of the personal computer, and the input resolution is higher than the display resolution of the projector.
- * When "Aspect" is set to "Zoom" by the video signal.

Note

- * Zoom and image movement functions are cancelled when the input is switched.
- * The greater the zoom enlargement, the less distinct the image will appear. The reason for this is that the dots are being digitally corrected so that they are not conspicuous.
- * Movement of the screen will not be possible when the menu screen is being displayed.

Adjustment of the Volume

This function adjusts the volume of the built-in speaker.

- (1) Press the VOL button.
The volume adjustment display will appear.



- (2) Adjust the volume.
The (+) button increases the volume and the (-) button decreases the volume.
- (3) To close the display immediately, press the CANCEL button.
In the absence of operations for a period of about 10 seconds, the display will close automatically.

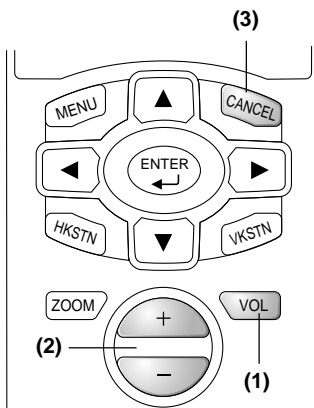

Menu Operation Method

- This section describes only the menu operation method. Please see this page should you need information while performing menu operations.
- For information about a menu function, adjustment, or setting, please see one of the pages containing such descriptions.
- Adjustments and settings are made by projecting an image and adjusting to an optimum condition.
- The remote control should be pointed toward the remote control sensor of the projector and operated.
- To return the various items that have been changed via the menu to their standard values (i.e., default values at time of shipping from the factory), see "Factory Default" on Page E-59. (Some items will not return to their initial values.)
- The adjustment/setting items and contents will differ depending on the input selection and the adjustment/setting items that can be used with the input signal are displayed on the menu.

Names and Functions of the Parts

Names and Functions of the Remote Control Buttons that Operate Via a Menu

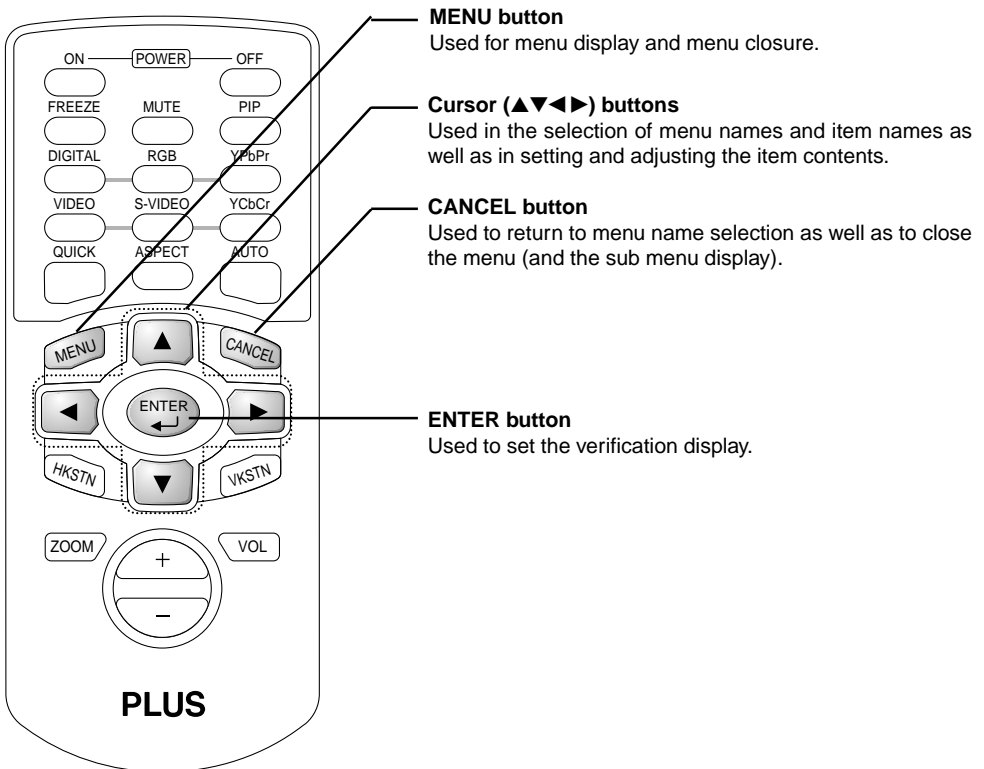

Names and Functions of the Main Unit Buttons Used in Menu Operation

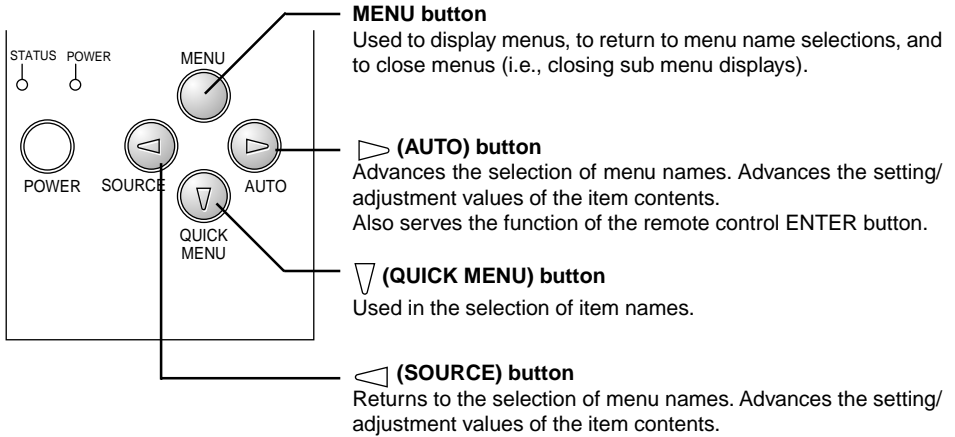

Names and Functions of Menu Screen Parts

Menu Names

These are the menu titles. When a menu is selected, the display changes to the title screen. The selected menu name appears in red.

Cursor (dark blue)

The setting/adjustment of the cursor position can be performed.

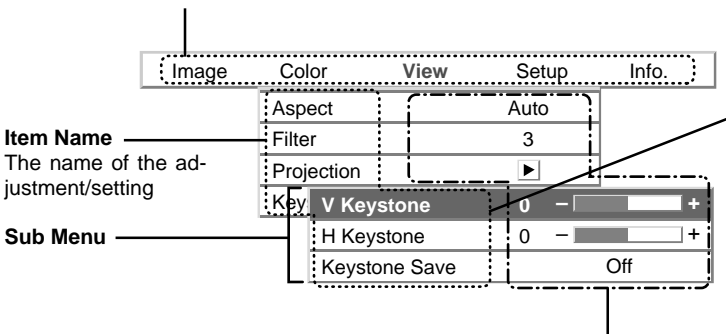

Adjustment bar setting contents

Adjustment bar: Indicates the adjustment condition by increases or decreases in bar length
Setting contents: Displays the set contents

▶ Icon: Displays the sub menu or setting contents

Performing Menu Operations

- The menu operations of the main unit buttons differ from those of the remote control buttons.
When both the main unit and remote control button operations are the same, the operation is described under the remote control operation; however, only when different, the operation will also be described under "Main unit operation".
- When a signal is not being input, only "Color", "Setup" and "Info." can be selected.
("Color" can be selected for Video and S-Video source only.)
- When a button is pressed and the next button operation is not entered within 30 seconds, the menu display will close.
- Adjustment and settings values will be maintained in storage even when the power has been switched off or the power plug has been disconnected.
(Note that some items are not stored.)

Preparation

**Switch on the power of the connected equipment, start the play operation or another operation, and input the signal to the projector.
Select the input that you wish to adjust.**

The menu display of the description diagram depicts an example in which the "H Keystone" item name is selected.

Menu Display

1 Press the MENU button to display the menu

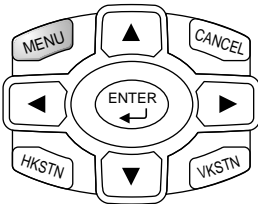

Image	Color	View	Setup	Info.
Brightness	0	—	▬	+
Contrast	0	—	▬	+
Color	0	—	▬	+
Tint	0	—	▬	+
Sharpness	0	—	▬	+
Reset			▶	

The menu name that existed when the menu was closed previously will be displayed.

Note

A press of the main unit MENU button will change the function of the SOURCE button, AUTO button, and QUICK MENU button to that of cursor buttons.

Selection of the Menu Name

2 Press the cursor (◀▶) button to select the menu name

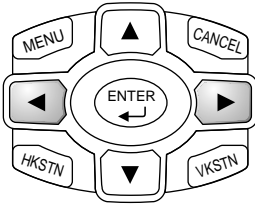

		Red		
Image	Color	View	Setup	Info.
	Aspect		Auto	
	Filter		3	
	Projection		▶	
	Keystone		▶	

Each press of the cursor (▶) button advances the selection one step in the sequence of "Color" → "View" → "Setup" → "Info." → "Image". Each press of the cursor (◀) button causes a return of one step.

The selected menu name will appear in red.

Note

At the time of menu name selection, check that the item name cursor is not being displayed.

To cancel the display of the cursor, press the CANCEL button on the remote control or the MENU button on the main unit.

Displaying the Cursor

3 Press the cursor (▼) button to display the cursor

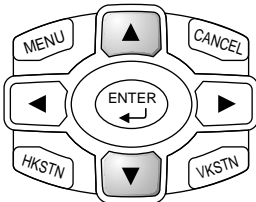

		Cursor: Dark blue		
Image	Color	View	Setup	Info.
	Aspect		Auto	
	Filter		3	
	Projection		▶	
	Keystone		▶	

This condition allows selection of the item name.

Selection of the Item Name

4 Press the cursor (▲▼) button to align the cursor with the item name

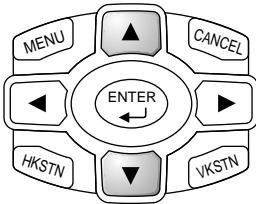

Image	Color	View	Setup	Info.
	Aspect		Auto	
	Filter		3	
	Projection		▶	
	Keystone		▶	

Main unit operation: Press the ▾ (QUICK MENU) button. When the cursor has moved to the very bottom of the items, another press will move it to the very top of the items.

Press the cursor (▶) button since the "Keystone" example of the description diagram displays the ▶ icon. The sub menu will be displayed.

Press the cursor (▼) button and align the cursor with the desired item name.

When the ▶ icon is displayed and depending on the item contents, a press of the cursor (▶) button will result in the setting display, a resetting of the adjustment value, or a resetting verification display. Please see the various item descriptions.

Image	Color	View	Setup	Info.
	Aspect		Auto	
	Filter		3	
	Projection		▶	
	Key	V Keystone	0 - [] +	
		H Keystone	0 - [] +	
		Keystone Save		Off

Making Adjustments/Settings

5 Press the cursor (◀▶) button and make the adjustment (or setting) while viewing the image

When a button is pressed, the image will also change.

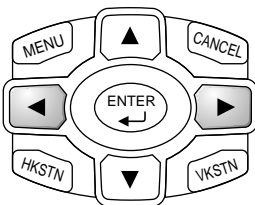

Image	Color	View	Setup	Info.
	Aspect		Auto	
	Filter		3	
	Projection		▶	
	Key	V Keystone	0 - [] +	
		H Keystone	0 - [] +	
		Keystone Save		Off

Adjustment display: Each press of the button results in a change of 1 point and continued presses cause changes to proceed in order.

Setting display: The setting contents display changes with each press of the button.

Closing the Menu

6 Press the MENU button and close the menu display

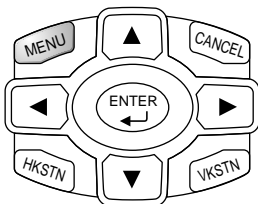

Main unit operation: Press the MENU button and cancel the cursor display.

When a sub menu is displayed, press the MENU button to close the sub menu, then press again to cancel the cursor. This condition allows the menu name to be selected.

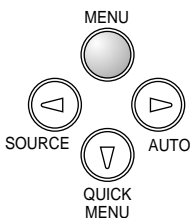

	Image	Color	View	Setup	Info.
Cursor	Aspect		Auto		
	Filter		3		
	Projection		▶		
	Keystone		▶		

A press of the MENU button while the cursor is not displayed will close the menu display.

	Image	Color	View	Setup	Info.
	Aspect		Auto		
	Filter		3		
	Projection		▶		
	Keystone		▶		

Selecting Another Menu Name with Remote Control Operation

When a sub menu is displayed, press the CANCEL button and close the sub menu. Press the CANCEL button again and cancel the cursor display.

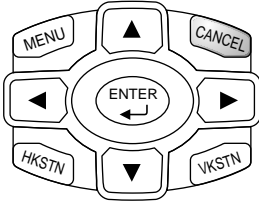

Press the cursor (◀▶) button and select the menu name. (Selection of the menu name is not possible while the cursor is displayed.)

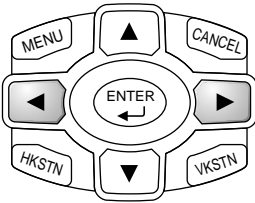

Image	Color	View	Setup	Info.
	Aspect		Auto	
	Filter		3	
	Projection		▶	
	Keystone		▶	

Image	Color	View	Setup	Info.
	Aspect		Auto	
	Filter		3	
	Projection		▶	
	Keystone		▶	

Image	Color	View	Setup	Info.
	Brightness	0	– [] +	
	Contrast	0	– [] +	
	Color	0	– [] +	
	Tint	0	– [] +	
	Sharpness	0	– [] +	
	Reset		▶	

Note

A press of the QUICK button while the menu is displayed will close the menu and display the quick menu. A press of the MENU button while the quick menu is displayed will close the quick menu and display the menu.

List of Item Names Offering Input Selection and Adjustments/Settings

The item names that can be adjusted/set will differ depending on the input signal.

[Example of Menu Display Items at the Time of Input Signal Video Selection]

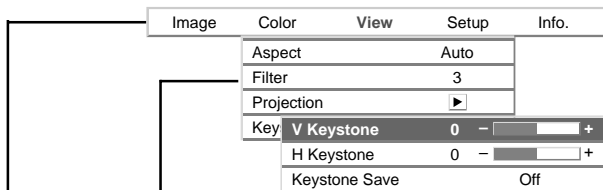

Menu Name	Item Name	Sub Menu Item Name	Input Signal						Reference Page	
			Analog RGB	Digital RGB	YPbPr	YCbCr	Video	S-Video		
Image	Brightness		<input type="radio"/>	<input type="radio"/>	<input type="radio"/>	<input type="radio"/>	<input type="radio"/>	<input type="radio"/>	E-46	
	Contrast		<input type="radio"/>	<input type="radio"/>	<input type="radio"/>	<input type="radio"/>	<input type="radio"/>	<input type="radio"/>	E-46	
	Picture Adj.		<input type="radio"/>						E-47	
	Fine Picture		<input type="radio"/>						E-47	
	H Position		<input type="radio"/>						E-47	
	V Position		<input type="radio"/>						E-47	
	Color					<input type="radio"/>	<input type="radio"/>	<input type="radio"/>	E-46	
	Tint						<input type="radio"/>	<input type="radio"/>	E-46	
	Sharpness					<input type="radio"/>	<input type="radio"/>	<input type="radio"/>	E-46	
Reset			<input type="radio"/>	<input type="radio"/>	<input type="radio"/>	<input type="radio"/>	<input type="radio"/>	<input type="radio"/>	E-48	
Color	Gamma		<input type="radio"/>	<input type="radio"/>	<input type="radio"/>	<input type="radio"/>	<input type="radio"/>	<input type="radio"/>	E-49	
	Color Temp.		<input type="radio"/>	<input type="radio"/>	<input type="radio"/>	<input type="radio"/>	<input type="radio"/>	<input type="radio"/>	E-49	
	Color System					<input type="radio"/>	<input type="radio"/>	<input type="radio"/>	E-50	
	Color Space				<input type="radio"/>	<input type="radio"/>			E-50	
View	Aspect		<input type="radio"/>	<input type="radio"/>	<input type="radio"/>	<input type="radio"/>	<input type="radio"/>	<input type="radio"/>	E-51	
	Filter		<input type="radio"/>	<input type="radio"/>	<input type="radio"/>	<input type="radio"/>	<input type="radio"/>	<input type="radio"/>	E-52	
	Projection	Vertical Flip		<input type="radio"/>	<input type="radio"/>	<input type="radio"/>	<input type="radio"/>	<input type="radio"/>	<input type="radio"/>	E-52
		Horizontal Flip		<input type="radio"/>	<input type="radio"/>	<input type="radio"/>	<input type="radio"/>	<input type="radio"/>	<input type="radio"/>	E-52
	Keystone	V Keystone		<input type="radio"/>	<input type="radio"/>	<input type="radio"/>	<input type="radio"/>	<input type="radio"/>	<input type="radio"/>	E-53
		H Keystone		<input type="radio"/>	<input type="radio"/>	<input type="radio"/>	<input type="radio"/>	<input type="radio"/>	<input type="radio"/>	E-53
		Keystone Save		<input type="radio"/>	<input type="radio"/>	<input type="radio"/>	<input type="radio"/>	<input type="radio"/>	<input type="radio"/>	E-54
	Picture in Picture	Size		<input type="radio"/>	<input type="radio"/>	<input type="radio"/>				E-54
Position			<input type="radio"/>	<input type="radio"/>	<input type="radio"/>				E-54	

"Tint" can be adjusted only at the time of NTSC composite/S signal input.

[Example of Menu Display Items at the Time of Input Signal Video Selection]

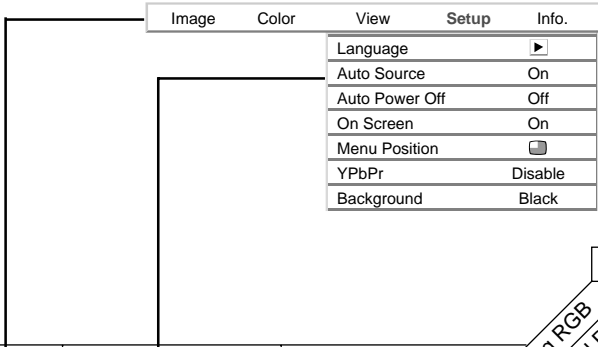

Menu Name	Item Name	Sub Menu Item Name	Input Signal						Reference Page
			Analog RGB	Digital RGB	YPbPr	YCbCr	Video	S-Video	
Setup	Language		<input type="radio"/>	<input type="radio"/>	<input type="radio"/>	<input type="radio"/>	<input type="radio"/>	<input type="radio"/>	E-55
	Auto Source		<input type="radio"/>	<input type="radio"/>	<input type="radio"/>	<input type="radio"/>	<input type="radio"/>	<input type="radio"/>	E-55
	Auto Power Off		<input type="radio"/>	<input type="radio"/>	<input type="radio"/>	<input type="radio"/>	<input type="radio"/>	<input type="radio"/>	E-56
	On Screen		<input type="radio"/>	<input type="radio"/>	<input type="radio"/>	<input type="radio"/>	<input type="radio"/>	<input type="radio"/>	E-56
	Menu Position		<input type="radio"/>	<input type="radio"/>	<input type="radio"/>	<input type="radio"/>	<input type="radio"/>	<input type="radio"/>	E-57
	YPbPr		<input type="radio"/>	<input type="radio"/>	<input type="radio"/>	<input type="radio"/>	<input type="radio"/>	<input type="radio"/>	E-57
	Background		<input type="radio"/>	<input type="radio"/>	<input type="radio"/>	<input type="radio"/>	<input type="radio"/>	<input type="radio"/>	E-57
	White Balance		<input type="radio"/>						E-58
Info.	Status		<input type="radio"/>	<input type="radio"/>	<input type="radio"/>	<input type="radio"/>	<input type="radio"/>	<input type="radio"/>	E-59
	Factory Default		<input type="radio"/>	<input type="radio"/>	<input type="radio"/>	<input type="radio"/>	<input type="radio"/>	<input type="radio"/>	E-59
	Lamp Timer Reset		<input type="radio"/>	<input type="radio"/>	<input type="radio"/>	<input type="radio"/>	<input type="radio"/>	<input type="radio"/>	E-59
	Resolution		<input type="radio"/>	<input type="radio"/>					E-60
	Frequency		<input type="radio"/>	<input type="radio"/>					E-60
	Lamp Timer		<input type="radio"/>	<input type="radio"/>	<input type="radio"/>	<input type="radio"/>	<input type="radio"/>	<input type="radio"/>	E-60

Picture

- Perform this operation while projecting the picture for which the adjustment/setting will be made.
- Select the menu name "Picture".

See "Menu Operation Method" on Pages E-37 to E-45 for information about performing menu operations. The item name display will differ depending on the input signal. See "List of Item Names Offering Input Selection and Adjustments/Settings" on Pages E-44 and E-45.

Brightness / Contrast / Color / Tint / Sharpness

Picture qualities such as brightness and contrast will change depending on the whether the room is bright or dark. Please adjust to suit your preference.

Select the desired item name and then adjust with the cursor (◀▶) buttons.

Brightness	0	-	<input type="text"/>	+
Contrast	0	-	<input type="text"/>	+
Color	0	-	<input type="text"/>	+
Tint	0	-	<input type="text"/>	+
Sharpness	0	-	<input type="text"/>	+
Reset			<input type="button" value="▶"/>	

Item Name	Cursor (◀) Button	Cursor (▶) Button
Brightness	Darker	Brighter
Contrast	Less contrast	More contrast
Color	Less dense color	Denser color
Tint	More red	More green
Sharpness	Softer image	Sharper image

Note

- * The adjustment values of the adjustable items are stored according to input source.
- * "Tint" can be adjusted only at the time of NTSC composite/S signal input.

Picture Adj. / Fine Picture / H Position / V Position

These adjustments are available when analog RGB signals are input.

Usually, automatic adjustment is performed at the time of signal selection, but when automatic adjustment is not effective, these adjustments can be performed.

Brightness	0	-	+
Contrast	0	-	+
Picture Adj.	-32	-	+
Fine Picture	26	-	+
H Position	0	-	+
V Position	0	-	+
Reset			▶

Note

When the image extends beyond the boundaries of the screen or is smaller than the screen, check that the "View" → "Aspect" setting is set to "Auto". See "Aspect" on Page E-51.

Picture Adj. (Picture Adjustment)

Adjust this when bright and dark vertical bands appear on the screen.

Select the "Picture Adj." item name and adjust with the cursor (◀▶) buttons so that the vertical bands disappear and brightness becomes uniform across the screen.

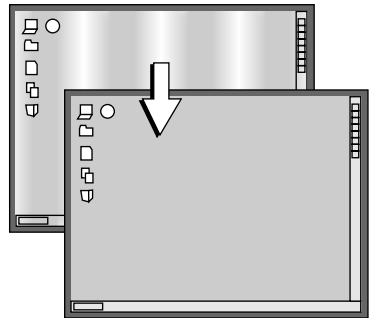
**Fine Picture**

Adjust this when the picture shows a lack of color fidelity or flickering.

Select the "Fine Picture" item name and adjust with the cursor (◀▶) buttons so that the lack of color fidelity or the flickering disappears.

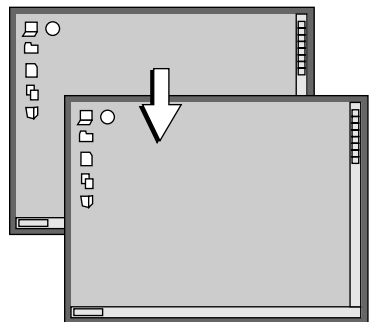

Picture

H Position

Adjust this when the picture is shifted to the left or right.

Select the "H Position" item name and adjust with the cursor (◀▶) buttons.

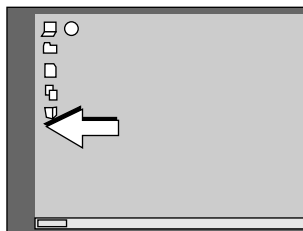

V Position

Adjust this when the picture is shifted up or down.

Select the "V Position" item name and adjust with the cursor (◀▶) buttons.

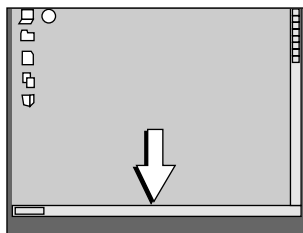

Reset

This function resets (i.e., returns to the standard settings) the adjustment/setting value of the "Image" menu name.

A press of the cursor (▶) button forces the reset.

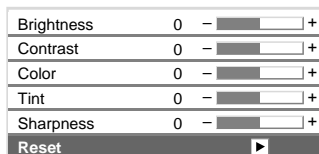

Note

* The item name "Fine Picture" at the time of analog RGB input will not be reset.

* "Reset" of the menu name "Image" can be reset for each input source.

* To reset the adjustments/settings of all the menu items (while noting that there are some items that cannot be reset), see "Factory Default" on Page E-59.

Color

- Select the menu name "Color".

See "Menu Operation Method" on Pages E-37 to E-45 for information about performing menu operations. The item name display will differ depending on the input signal. See "List of Item Names Offering Input Selection and Adjustments/Settings" on Pages E-44 and E-45.

Gamma

Gamma corrects the proportion of change of the dark portions from the bright portions of the input signal.

Set this to reproduce natural color tone or to distinctly project a personal computer picture in a bright conference room.

Select the "Gamma" item name and select the setting contents with the cursor (◀▶) buttons.

Gamma	Normal
Color Temp.	Normal
Color System	Auto

Normal Correction with standard settings
Natural Corrects for natural color tones
Real Corrects with emphasis on brightness

Color Temp.

The screen color is affected by the color of the illumination and other extraneous light.

This function adjusts the white, which is the reference color for video equipment, and improves the quality of color reproduction. Adjustment can also be used to enhance skin colors.

Select the item name "Color Temp." and select the setting contents with the cursor (◀▶) buttons.

Gamma	Normal
Color Temp.	Normal
Color System	Auto

Low Produces warm whites (reddish)
Medium Produces warm whites (yellowish)
Normal Produces the white of sunlight
High Produces cool whites (bluish)

Color System

This function sets the color system of the video signal. Normally, this should be set to Auto. Set this function when the system cannot be identified with Auto.

Select item name "Color System" and select the setting contents with the cursor (◀▶) buttons.

- Auto Automatic identification
- NTSC Fixes the setting to NTSC
- PAL Fixes the setting to PAL
- SECAM Fixes the setting to SECAM

Gamma	Normal
Color Temp.	Normal
Color System	Auto

Color Space

Set this function when a component signal (YCbCr or YPbPr) is projected and the image is extremely red or extremely green.

Select the item name "Color Space" and use the cursor (◀▶) buttons to select a color space setting that provides a normal image.

Selection contents at the time of YCbCr input
YCbCr601, YCbCr709, YCbCrSMPT

Selection contents at the time of YPbPr input
YPbPr601, YPbPr709, YPbPrSMPT

Gamma	Normal
Color Temp.	Normal
Color System	Auto
Color Space	YCbCr601

Gamma	Normal
Color Temp.	Normal
Color Space	YPbPr601

Note

* When the component signal undergoes conversion processing to red, green, and blue which express the image of the projector, the correct color cannot be reproduced unless a system compliant with the color difference conversion system of the input signal is used. Color Space serves to make this selection.

View

- Perform this operation while projecting the picture for which the adjustment/setting will be made.
 - Select the menu name "View".
- See "Menu Operation Method" on Pages E-37 to E-45 for information about performing menu operations. The item name display will differ depending on the input signal. See "List of Item Names Offering Input Selection and Adjustments/Settings" on Pages E-44 and E-45.

Aspect

This function sets the horizontal and vertical picture proportions of the input signal.

Select the item name "ASPECT" and select the setting contents with the cursor (◀▶) buttons.

Aspect	Auto
Filter	3
Projection	▶
Keystone	▶
Picture in Picture	▶

Personal Computer Signal

- Auto Automatically enlarges or reduces the image to project a full screen in a ratio of 4:3
- Direct Maintains the aspect ratio and projects a picture of the maximum displayable size
- Real Projects the input signal without pixel conversion

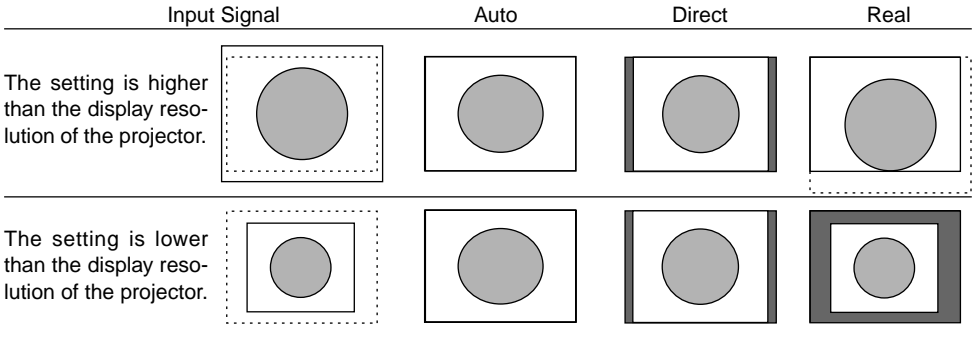

Video Signals

- Auto While maintaining the aspect ratio, projects a full screen so that no portions extend beyond the boundaries of the screen. The top and bottom of the 16:9 image becomes black.
- Wide Projects to fill the full width with the entire image at 16:9.
(This feature is used to project a squeezed image in a proper aspect ratio.)
- Zoom Projects only the 4:3 portion within 16:9 image to fill the screen.
(Portion that extend off screen is cut.)

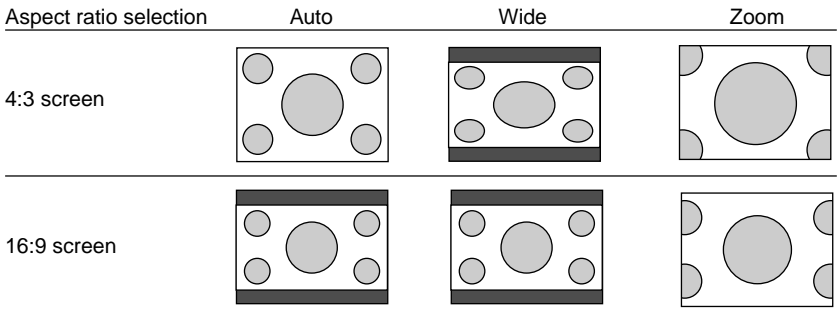

Filter

This function sets the sharpness when the input signal is adjusted to the resolution of the projector and enlarged or reduced.

Select the item name "Filter" and select the setting contents with the cursor (◀▶) buttons.

Aspect	Auto
Filter	3
Projection	▶
Keystone	▶
Picture in Picture	▶

Smaller numerical values result in a sharper picture and larger values result in a softer picture. Please select your desired setting value.

Projection

This function selects the projection orientation to the screen. It is set when the projector projects to the front or the rear of the screen.

1. Select item name "Projection" and press the cursor (▶) button. The sub menu will open.

Aspect	Auto
Filter	3
Projection	▶
Keystone	▶

2. Select "Vertical Flip" or "Horizontal Flip" with the cursor (▲▼) buttons and set to "On" or "Off" with the cursor (◀▶) buttons (or with the main unit (∇) button).

Aspect	Auto	
Filter	3	
Projec	Vertical Flip	Off
Keyst	Horizontal Flip	Off

"Vertical Flip" Off
"Horizontal Flip" Off



"Vertical Flip" Off
"Horizontal Flip" On



"Vertical Flip" On
"Horizontal Flip" On



"Vertical Flip" On
"Horizontal Flip" Off

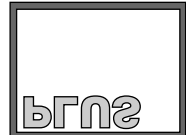

Keystone

This function corrects the keystone distortion of the projected picture on the screen. Adjust so that the edges are parallel in the vertical and the horizontal directions.

1. Select item name "Keystone" and press the cursor (▶) button. The sub menu will open.
2. Select "V Keystone" or "H Keystone" with the cursor (▲▼) buttons and adjust with the cursor (◀▶) buttons (or with the main unit (∇) button).

Aspect	Auto
Filter	3
Projection	▶
Keystone	▶

Aspect	Auto			
Filter	3			
Projection	▶			
Key	V Keystone	0	-	+
	H Keystone	0	-	+
	Keystone Save			Off

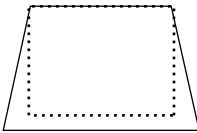

Vertical keystone
(-) direction

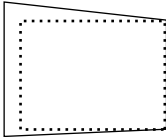

Horizontal keystone
(-) direction

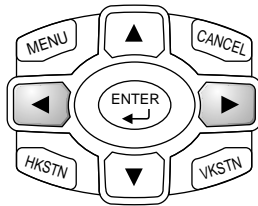

Pressing the button corrects the projected picture in the direction of the dotted screen outline.

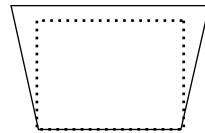

Vertical keystone
(+) direction

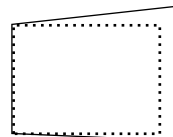

Horizontal keystone
(+) direction

Note

- * Overcompensation of the vertical keystone correction value will result in a narrowing of the horizontal keystone adjustment range. Likewise, overcompensation of the horizontal keystone correction value results in a narrowed vertical adjustment range.
- * Menus and other on-screen displays are not adjusted.

Keystone Save

This function is used to save the keystone adjustment values.

Setting Keystone Save to on will set the previous keystone adjustment values when projecting after the power cable has been disconnected and then reconnected.

1. Select item name "Keystone" and press the cursor (▶) button. The sub menu will open.
2. Select "Keystone Save" with the cursor (▲▼) buttons and set with the cursor (◀▶) buttons (or with the main unit (√) button).

Aspect	Auto
Filter	3
Projection	▶
Key	V Keystone 0 - <input type="text"/> +
	H Keystone 0 - <input type="text"/> +
Keystone Save	Off

Off The keystone adjustment values return to the initial values when the power cable is unplugged.

On The keystone adjustment values are retained in storage even when the power cable has been unplugged.

Note

Regardless of whether Keystone Save is set to "On" or "Off", when projection is from the standby condition, the picture is projected using the previous keystone adjustment values.

Picture in Picture

This function displays the picture from the VIDEO jack as a sub-picture on the input screen (i.e., the main picture) from the PC connector.

1. Select item name "Picture in Picture" and press the cursor (▶) button. The sub menu will open.
2. Select "Size" or "Position" with the cursor (▲▼) buttons and set with the cursor (◀▶) buttons (or with the main unit (√) button).

Aspect	Auto
Filter	3
Projection	▶
Keystone	▶
Picture in P	▶
Aspect	Auto
Filter	3
Projection	▶
Keystone	▶
Picture in P	Size Off
	Position <input type="checkbox"/>

Size Settings

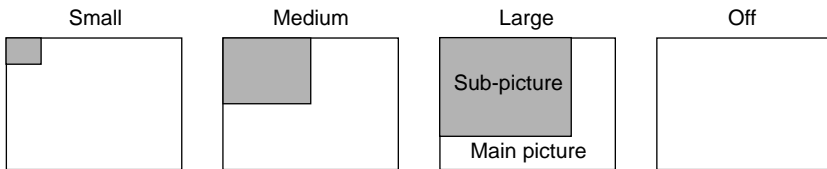

Position Settings

- Display at upper left of main screen
- Display at upper right of main screen
- Display at center of main screen
- Display at lower left of main screen
- Display at lower right of main screen

Note

- Sizes of a sub-picture vary depending on the signal input to the PC connector.
- The adjustment display and picture will not appear unless a signal is input to the PC connector.
- Some types of signal for a main picture cannot be set to "Small" or "Large".

Setup

- Select menu name "Setup".

See "Menu Operation Method" on Pages E-37 to E-45 for information about performing menu operations. The item name display will differ depending on the input signal. See "List of Item Names Offering Input Selection and Adjustments/Settings" on Pages E-44 and E-45.

Language

This function sets the language that is displayed on screen in the messages and menu displays.

1. Select item name "Language" and press the cursor (▶) button.
The selection display will open.
2. Select with the cursor (▲▼) buttons (or with the main unit (∇) button).

Language	▶
Auto Source	On
Auto Power Off	Off
On Screen	On
Menu Position	☐
YPbPr	Disable
Background	Black

Language	English
Auto Source	Deutsch
Auto Power Off	Français
On Screen	Italiano
Menu Position	Español
YPbPr	Svenska
Background	中文
	日本語

Auto Source

The Auto Source function automatically detects the input signal when the power supply is switched on and when the input is switched.

Select the item name "Auto Source" and select the setting contents with the cursor (◀▶) buttons.

- On Switches on the automatic detection function
Off Switches off the automatic detection function

Order of Signal Detection

The search is repeated in the order of Analog RGB → YPbPr → Digital RGB → Video → S-Video → YCbCr. When a signal is detected, the search is stopped and the image is projected.

Language	▶
Auto Source	On
Auto Power Off	Off
On Screen	On
Menu Position	☐
YPbPr	Disable
Background	Black

Note

Set "YPbPr" to "Enable" (i.e., valid) when inputting a component signal YPbPr.
When "YPbPr" is set to "Disable", detection is not possible.

Setup

Auto Power Off

This function switches off the projector power automatically when the input of the projector enters a no-signal condition.

Select item name "Auto Power Off" and select the setting contents with the cursor (◀▶) buttons.

On The power is switched off when there is no signal.

Off The power is not switch off even when there is no signal.

Operation when Function is On

- * The "No Signal Power Off" display appears when a no-signal condition continues for approximately 10 seconds. The power is switched off about 5 minutes after this.
- * If a signal is input during the appearance of the display and an operation button other than the POWER button is pressed, the display is closed and the function is cancelled.

Language	▶
Auto Source	On
Auto Power Off	Off
On Screen	On
Menu Position	☐
YPbPr	Disable
Background	Black

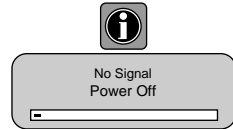

Note

Some video decks and other equipment output a blue background or other video when playback ends. When this happens, a signal is being input to the projector and Auto Power Off is not activated.

On Screen

This function switches on or off messages that are displayed in a black frame.

Select item name "On Screen" and select the setting contents with the cursor (◀▶) buttons.

On The message is displayed.

Off The message is not displayed.

Language	▶
Auto Source	On
Auto Power Off	Off
On Screen	On
Menu Position	☐
YPbPr	Disable
Background	Black

Example of a display when the ASPECT button is pressed

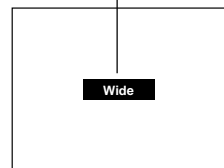

Note

Even when set to off, messages that are not in a black frame will be displayed.

Menu Position

This function sets the display position of the menu.

Select item name "Menu Position" and select the setting contents with the cursor (◀▶) buttons.

- Displays on the left side
- Displays on the right side

Language	▶
Auto Source	On
Auto Power Off	Off
On Screen	On
Menu Position	<input checked="" type="checkbox"/>
YPbPr	Disable
Background	Black

YPbPr

This setting causes the projector not to accept component YPbPr signals.

Select item name "YPbPr" and select the setting contents with the cursor (◀▶) buttons.

- Disable Function is made invalid and input selection is not permitted
- Enable Function is made valid and input selection is made possible.

Language	▶
Auto Source	On
Auto Power Off	Off
On Screen	On
Menu Position	<input type="checkbox"/>
YPbPr	Disable
Background	Black

Background

This function sets the screen color when the input source is no-signal.

Select item name "Background" and select the setting contents with the cursor (◀▶) buttons.

- Black Sets a black screen when there is no signal
- Blue Sets a blue screen when there is no signal

Language	▶
Auto Source	On
Auto Power Off	Off
On Screen	On
Menu Position	<input type="checkbox"/>
YPbPr	Disable
Background	Black

White Balance

This function automatically adjusts the black level and the white level of the analog RGB input signal so that they suit the personal computer. This serves to improve color reproducibility.

Language	▶
Auto Source	On
Auto Power Off	Off
On Screen	On
Menu Position	☐
YPbPr	Disable
Background	Black
White Balance	▶

1. Select item name "White Balance" and press the cursor (▶) button.
The display changes to the "Input Black Signal" display.
2. The background of the screen of the connected PC is set to black.
3. Press the (▶) cursor button. The display changes to "Adjusting Black" and the black level is adjusted.

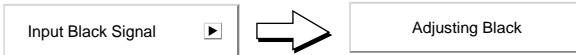

4. The adjustment of the black level is completed and the display changes to "Input White Signal".
5. The background of the screen of the connected PC is set to white.
6. Press the (▶) cursor button. The display changes to "Adjusting White" and the white level is adjusted.

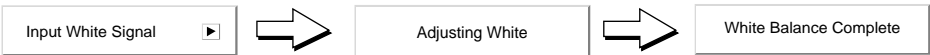

"White Balance Complete" is displayed for a while and the adjustment is completed.

Info.

- Select menu name "Info".

See "Menu Operation Method" on Pages E-37 to E-45 for information about performing menu operations. The item name display will differ depending on the input signal. See "List of Item Names Offering Input Selection and Adjustments/Settings" on Pages E-44 and E-45.

Status

This displays information about the equipment.

Select item name "Status" and press the cursor (▶) button.

Display Contents:

Projector model, firmware version, and the internet home page address of PLUS Vision Corp.

Status	▶
Factory Default	▶
Lamp Timer Reset	▶
Lamp Timer	12h



Factory Default

This function returns the adjustments and settings of all the input sources to the standard factory default values.

Select item name "Factory Default" and press the cursor (▶) button.

The display "Press "ENTER" to set Factory Default" will appear.

A press of the ENTER button sets the factory defaults. Main unit operation: Press the ▷ (AUTO) button.

Items that are not set to the factory default:

Projection method, YPbPr, Language, and Lamp Timer

Status	▶
Factory Default	▶
Lamp Timer Reset	▶
Lamp Timer	12h

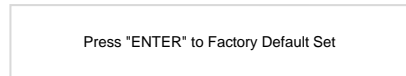

Lamp Timer Reset

This function resets the lamp timer. Be sure to perform the reset operation when the lamp cartridge has been replaced.

Select item name "Lamp Timer Reset" and press the cursor (▶) button.

The display "Press "ENTER" to reset lamp timer." appears.

A press of the ENTER button resets the timer. Main unit operation: Press the ▷ (AUTO) button.

Status	▶
Factory Default	▶
Lamp Timer Reset	▶
Lamp Timer	12h

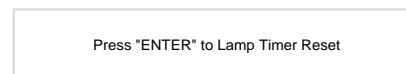

Info.

Resolution / Frequency

This function displays the resolution and frequency of the detected input signal.

This information will not be displayed unless an analog RGB or digital RGB signal is input and an Analog RGB or Digital RGB input selection is made.

Status	▶
Factory Default	▶
Lamp Timer Reset	▶
Resolution	1024 × 768
Frequency	60Hz, 48kHz
Lamp Timer	12h

Lamp Timer

This function displays the lamp timer.

When the lamp timer exceeds 1,000 hours, "Replace the Lamp Cartridge." is displayed on the screen for 10 seconds at one minute intervals.

Replace the lamp with a new one.

See "Replacing the lamp cartridge" on Page E-66 for information about lamp cartridge replacement.







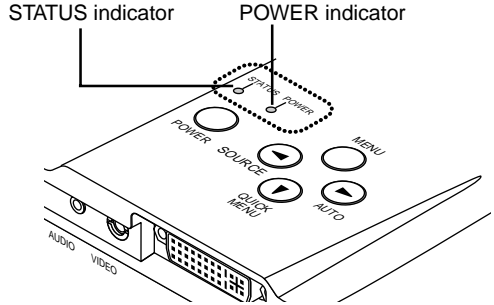

Status	▶
Factory Default	▶
Lamp Timer Reset	▶
Lamp Timer	12h

When 1,100 is exceeded, "Warning!! System Shutdown" is display for 10 seconds and the power is switched off.



When the STATUS Indicator is Lit/Flashes

When the STATUS indicator of the main unit operation panel is lit or flashes, notification is being given of the irregularities described.

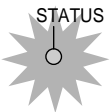
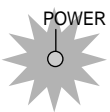
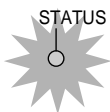

STATUS Indicator	POWER Indicator	Action to Take
 <p>Flashes red (0.5 s lit / 0.5 s off)</p>	 <p>Lit red</p>	<p>The temperature has become abnormally high.</p> <ul style="list-style-type: none"> * The thermal protector is activated. If the room temperature is high, move the projector to a cool location. If the internal temperature of the projector is high, check the ventilation holes of the cooling fan and clean them if they are obstructed. * When the thermal protector is activated, the power is switched off and even if the power is soon switched back on, the power might not actually be supplied to the projector. Should this happen, wait one minute and then switch the power on again.
 <p>Flashes red (1 s lit / 1 s off)</p>	 <p>When the lamp burns out during operation: Flashes amber for 60 seconds and then is lit amber When the lamp does not light from the beginning: Lit amber</p>	<p>The lamp will not light up.</p> <p>Wait one minute or longer while the lamp lighting voltage irregularity detection protector is activated and switch the power on again. If the problem still persists, unplug the power cable and contact your dealer.</p>
 <p>Flashes red (0.5 s lit / 0.5 s off)</p>	 <p>Lit amber</p>	<p>The fan is stopped.</p> <p>Unplug the power cable and request service from your dealer.</p>
 <p>Flashes red (1 s lit / 1 s off)</p>	 <p>Lit red</p>	<p>The lamp cover is open.</p> <p>The lamp cover is not attached properly. Attach it properly.</p>

When the STATUS Indicator is Lit/Flashes

STATUS Indicator	POWER Indicator	Action to Take
 <p>Lit red</p>	 <p>When power is on: Lit green When power is off: Lit amber</p>	<p>It is timer to replace the lamp. The lamp timer has exceeded 1,000 hours. Replace the lamp cartridge.</p>
 <p>Lit red</p>	 <p>Lit amber after 60 seconds of flashing in amber</p>	<p>The lamp's service life has ended. The lamp timer has exceeded 1,100 hours. The lamp will not light. Replace the lamp cartridge.</p>

Thermal Protector

When the internal temperature of the projector becomes abnormally high, the STATUS indicator will flash red (at a rate of once per second) and the POWER indicator will light red.

The thermal protector is activated and the power of the projector is switched off simultaneously.

Should this occur, proceed with the following actions.

1. Switch off the power and disconnect the power plug from the wall outlet.

2. Check the following matters and take the required measures.

When the projector is being used in a location that has a high ambient temperature, set it up again in a cool location. Check the outflow and intake holes and clean them if they are obstructed.

3. Wait about 60 minutes until the temperature of the projector drops.

If after having performed the above matters, the problem still has not been solved, please contact your store of purchase.

Troubleshooting

Check the following matters before requesting servicing.

Problem	Check	Reference Page
No power	* Has the power plug become disconnected from the outlet?	E-24
	* Is the lamp cover properly attached?	E-68
	* Has the internal temperature become high? When the internal temperature becomes very high, to protect the unit the power will not switch on.	E-62
	* Has the lamp timer exceeded 1,100 hours? The power will no longer switch on once the timer has exceeded 1,100 hours.	E-62
No video	* Has the connected input been selected?	E-28
	* Is the cable of the input connector properly connected?	E-18 – 22
	* If there is connection to a personal computer, is a signal being output from the personal computer?	E-20
	* Has a signal that is higher than the supported frequency of the projector been input?	E-70
	* Check that the image adjustment brightness and contrast are not set to minimum.	E-32, 46
	* Has the lamp burned out?	E-62
	* Is the STATUS indicator flashing?	E-61
Distorted video	* Is the projector installed properly?	E-26
	* Is the keystone adjustment properly adjusted?	E-34, 53
Blurred video	* Is the lens properly focussed?	E-27
	* Are the projection screen and the projector installed at the proper distance?	E-16, 17
	* Has the projection distance exceeded the focussing range?	E-16, 17
	* Is there condensation on the lens and other parts? When the projector has been stored in a cold location and the power is switched on in a warm location, there may be condensation on the lens and other internal optical parts. Should this occur, wait several minutes until the condensation disappears.	–
Image position is shifted and doesn't display properly	* Is the input signal being supported for resolution and frequency? Check the resolution of your personal computer.	E-70
Image is broken	* When the image is broken in the horizontal or vertical direction, or the image does not fill the entire screen, select a suitable aspect ratio.	E-30, 51
Overall color of image is strange	* When a component signal is being input, the color space setting is different. Perform the color space setting.	E-50

Troubleshooting

Problem	Check	Reference Page
Menu name cannot be selected	* Other than for "Setup" and "Info.", selection is not permitted unless a signal is input to the projector and an image or picture is projected.	–
Pressing the PIP button does not display a sub-picture	* There will not be a display unless the personal computer screen is being projected. An image will not be output unless a video image is being input.	E-31
Remote control does not function	* Has the transportation insulation sheet been removed? * Is an obstacle located between the remote control and the remote control sensor of the main unit? * Is the remote control out of range for its signal to reach the sensor? * Is there strong light or a fluorescent lamp in the vicinity of the sensor? * Are the batteries weak? Try directing the remote control toward the remote control sensor from a close distance and operating it. If there is difficulty in changing settings, the batteries are weak. Replace the batteries with new ones.	E-13 – E-14 – –
STATUS indicator lights or flashes	* See the STATUS indicator list.	E-61

Cleaning

- Be certain to disconnect the power plug from the power outlet before cleaning.
- Do not spray or otherwise expose the projector, lens, or screen to volatile substances such as insecticides. Do not leave rubber or vinyl products in contact with the projector for long periods. Doing so could cause them to undergo qualitative changes or the coatings may peel, etc.

Cleaning a Soiled Projector Main Unit

- * Wipe with a lint-free, soft, dry cloth.
When very dirty, wipe with a cloth that has been moistened with a diluted neutral detergent, then finish with a dry cloth. If a chemically-treated cloth is going to be used, please follow any written warnings.
- * Do not wipe with thinner, benzene, or other solvents. Doing so could cause them to undergo qualitative changes or the coatings may peel, etc.
- * When removing the dust of the outflow and intake holes, use the brush attachment on a vacuum cleaner to clean out the dust. Avoid using the vacuum directly without attaching the adapter as well as the use of a nozzle adapter.
- * Do not scratch or otherwise hit the projector body with your nails or other hard object, since this will cause scratches.

Dirty Lens

- * Clean using the same method you would use to clean a camera lens: Use a commercial blower for camera use or cleaning paper for eye glasses. Be careful not to scratch the lens at this time.

Dust of the Intake and Outflow Holes

Dust that collects in the intake and outflow holes will obstruct the ventilation and cause the internal temperature to rise which could cause damage. Clean this area carefully. As a guideline, clean at least every 100 hours.

- * Switch off the power, check that the POWER indicator has changed to a steadily lit amber, then unplug the power cable.
- * Clean out the holes from the outside using a vacuum cleaner. Use the brush adapter of the vacuum cleaner to do this. Avoid using the vacuum directly without attaching the adapter as well as the use of a nozzle adapter.

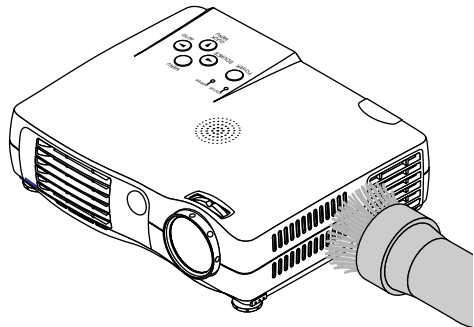

Cleaning the Inside of the Projector

Cleaning of the inside of the projector is required about once a year. Failure to clean over a long period while dust has collected inside the projector could cause a fire or breakdown. Do not clean the inside of the projector by yourself. Please be sure to contact your dealer.

Replacing the Lamp Cartridge

The lamp as a light source used in the unit has a lifespan. The rated lamp life is about 1,000 hours. The rated lamp life is the average life of the lamps produced and tested (under the test conditions of our company) for a long term, however, it may become shorter depending on the conditions of usage.

After the lamp has been operating for 1000 hours or longer, the STATUS indicator will light and total lamp usage will be displayed on the screen.

The unit will not turn on after 1100 hours. When this happens, replace the lamp cartridge with a new one. Follow the procedures below for replacement.

The rated lamp life is about 1,000 hours. The rated lamp life is the average life of the lamps produced and tested (under the test conditions of our company) for a long term, however, it may become shorter depending on the conditions of usage.

After the lamp has been operating for 1000 hours or longer, the STATUS indicator on the control panel will light and the "LAMP USAGE" icon which shows hours of total lamp usage will be displayed on the screen.

When this happens, turn off the unit and replace the lamp cartridge with a new one. The unit will not turn on after 1100 hours. (It will go off if it is in use.)

CAUTION

- DO NOT TOUCH THE LAMP immediately after it has been used. It will be extremely hot. Allow at least one hour for the lamp to cool before handling.
- DO NOT LOOSEN ANY SCREWS except for those mentioned in the instructions below. There is danger of electric shock.

CAUTION

Do not use a lamp cartridge other than the PLUS replacement lamp cartridge. Order this from your PLUS dealer using the unit model number (see "Note" below).

Note

- When the lamp usage time reaches 1100 hours, it becomes impossible to switch on the power and menus are not displayed. In such a case, see "If the unit doesn't go on because lamp usage exceeds 1100 hours" on page 25.
- Obtain a replacement lamp cartridge at the store where the unit was purchased. Please specify the following information when ordering a replacement lamp cartridge:

Model name : V-120

Product code : 28-060

PREPARATION Turn the projector upside down and place it on a soft cloth that has been prepared in advance to prevent scratches. This will assist in lamp cartridge replacement. After replacement, return the projector to the original condition.

1. Disconnect the power cable.
2. Turn the projector upside down.
3. Remove the lamp cover.

- (1) Turn the screw that fastens the lamp cover counterclockwise until it turns freely. (The screw will not come out.)
- (2) Lift the lamp cover a little and pull it off in the direction of the arrow.

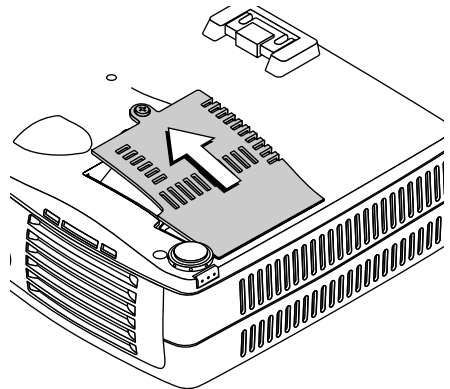
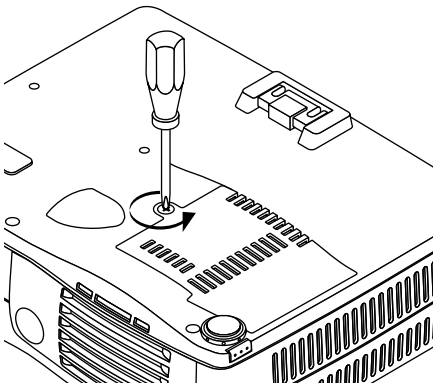

4. Remove the lamp cartridge

- (1) Turn the 2 screws that fasten the lamp cartridge counterclockwise until they turn freely. (The screws will not come out.)
- (2) Grasp the handle of the lamp cartridge, pull it upward and remove the lamp cartridge.

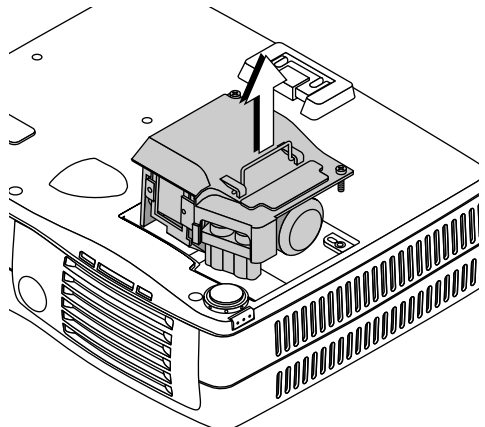
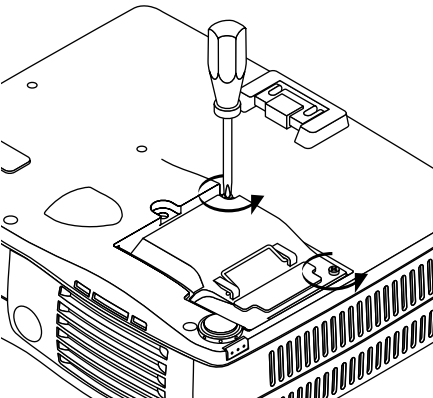

5. Install the new lamp cartridge

- (1) Slowly push in the lamp cartridge with the socket facing forward. (Align the lamp cartridge screw with the screw hole of the projector.)
- (2) Turn the 2 screws of the lamp cartridge clockwise to tighten.

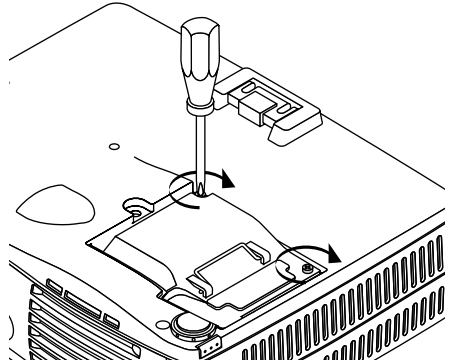
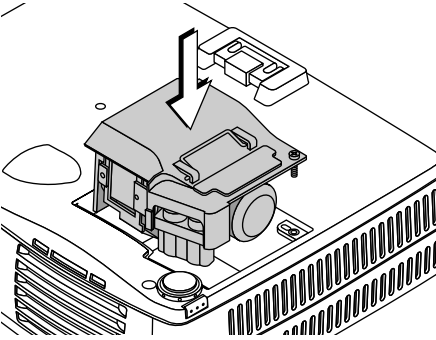

6. Install the lamp cover

- (1) First insert the front edge of the lamp cover into the groove, then close the lamp cover.
- (2) Turn the screw of the lamp cover clockwise to tighten.

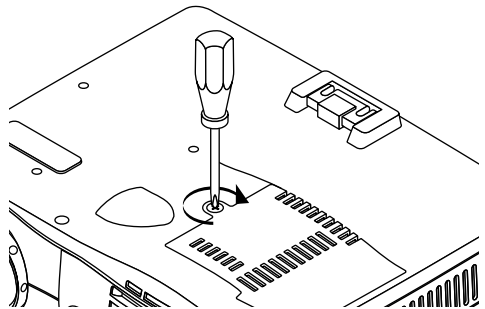
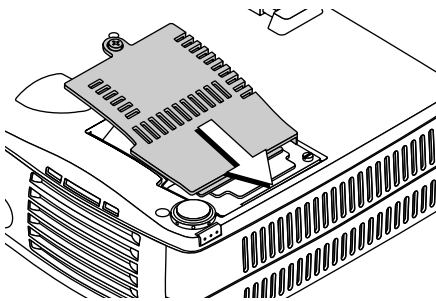

7. Reset the lamp timer to zero.

Plug in the power cable and switch on the power before resetting.
Select [Info.] → [Lamp Timer Reset] and then reset the hours indication.

NOTE: The projector will no longer start when the lamp timer exceeds 1,100 hours. As a result, it will not be possible to reset the lamp timer through timer operations. Should this situation arise, set to the standby condition and press the SOURCE button and the ASPECT button of the main unit at the same time for at least 5 seconds. When reset, the STATUS indicator will go off. Please obtain a replacement lamp from your dealer. When ordering, please specify a V-1080/V-807 special replacement lamp type V-120 (order code 28-060).

Specifications

Optical

DMD™	Single Chip Digital Micro Device (DMD™) V-1080: 1024 × 768 dots V-807: 800 × 600 dots
Lamp	120 W high-pressure mercury lamp
Image size	V-1080: 36 inch to 200 inch V-807: 35 inch to 200 inch
Light Output	800 ANSI lumens
Contrast Ratio	800:1 (Full on/off)

Electrical

Inputs	Video (NTSC3.58/NTSC4.43/PAL/PAL_N/PAL_M/PAL60/SECAM) RGB (Horizontal :15 to 85 kHz, Vertical 50 to 120 Hz)
Color Reproduction	Full color (16,770,000 colors)
Resolution	V-1080: SXGA (Compression), XGA(True), SVGA/VGA (Expansion/True) V-807: XGA (Compression), SVGA (True), VGA (Expansion/True)
Input Current	1.8 A
Power Requirement	100 - 240 V AC, 50/60 Hz
Power Consumption	160 watts

Mechanical

Dimensions Excluding Stand	18.0 cm (W) × 4.5 cm (H) × 14.1 cm (D) 7.1 in.(W) × 1.8 in.(H) × 5.6 in.(D)
Weight	Approximately 0.9 kg / 1.98 lbs
Operational Temperatures	Data projector: 5° to 35°C (41° to 95°F), 30 to 85% humidity
Regulations	UL Approved (UL 1950, CSA 950) Meets FCC Class A requirements Meets EMC Directive (EN55022, EN55024) Meets Low Voltage Directive (EN60950)



* Specifications and design are subject to change without notice.

Table of Supported Frequency

The unit automatically determines PC signals to select the appropriate resolution.

Some signals may require manual adjustments. See "Picture Adj./Fine Picture /H Position / V Position" on pages E-47 and E-48.

Signal	Resolution	Frequency (kHz)	H. Refresh Rate (Hz)	Digital		Analog	
				V-1080	V-807	V-1080	V-807
VESA	640 × 350	31.5	70.1	—	—	○	○
	640 × 350	37.9	85.1	—	—	○	○
	720 × 350	31.5	70.0	—	—	○	○
	640 × 400	31.5	70.1	—	—	○	○
	640 × 400	37.9	85.1	—	—	○	○
	720 × 400	31.5	70.0	○	○	○	○
	720 × 400	37.9	85.0	—	—	○	○
	640 × 480	31.5	60.0	○	○	○	○
	640 × 480	37.9	72.8	—	—	○	○
	640 × 480	37.5	75.0	—	—	○	○
	640 × 480	43.3	85.0	—	—	○	○
	800 × 600	35.2	56.3	—	—	○	○
	800 × 600	37.9	60.3	○	○	○	○
	800 × 600	46.9	75.0	—	—	○	○
	800 × 600	48.1	72.2	—	—	○	○
	800 × 600	53.7	85.1	—	—	○	○
	1024 × 768	48.4	60.0	○	○	○	○
	1024 × 768	56.5	70.1	—	—	○	○
	1024 × 768	57.7	72.0	—	—	○	○
	1024 × 768	60.0	75.0	—	—	○	○
	1024 × 768	68.7	85.0	—	—	○	○
	1280 × 1024	64.0	60.0	○	○	○	—
	1280 × 1024	80.0	75.0	—	—	○	—
1280 × 1024	91.1	85.0	—	—	○	—	
NEC(PC-9800)	640 × 400	24.8	56.4	—	—	○	○
	640 × 400	31.5	70.1	—	—	○	○
	640 × 480	31.5	60.0	—	—	○	○
	640 × 480	37.5	75.0	—	—	○	○
	800 × 600	37.9	60.3	—	—	○	○
	800 × 600	46.9	75.0	—	—	○	○
	1120 × 750	50.0	60.1	—	—	○	○
	1024 × 768	56.5	70.1	—	—	○	○
	1024 × 768	60.0	75.0	—	—	○	○
	1280 × 1024	64.6	59.9	—	—	○	—
Apple Macintosh	640 × 480	35.0	66.7	—	—	○	○
	832 × 624	49.7	74.5	—	—	○	○
	1024 × 768	60.2	74.9	—	—	○	○
Sun	1152 × 870	68.7	75.1	—	—	○	○
	1152 × 900	61.8	66.0	—	—	○	○
SGI	1280 × 1024	81.1	76.1	—	—	○	○
	1024 × 768	49.7	60.4	—	—	○	○
HP	1280 × 1024	63.9	60.0	—	—	○	—
	1152 × 900	71.7	76.1	—	—	○	○
	1280 × 1024	78.1	72.0	—	—	○	—

○ : Supported frequency

— : Not supported frequency

V-1080: The native resolution of the panel is 1024×768. Resolutions other than 1024×768 may be displayed with uneven size of text or lines.

V-807: The native resolution of the panel is 800×600. Resolutions other than 800×600 may be displayed with uneven size of text or lines.

Cabinet Dimensions

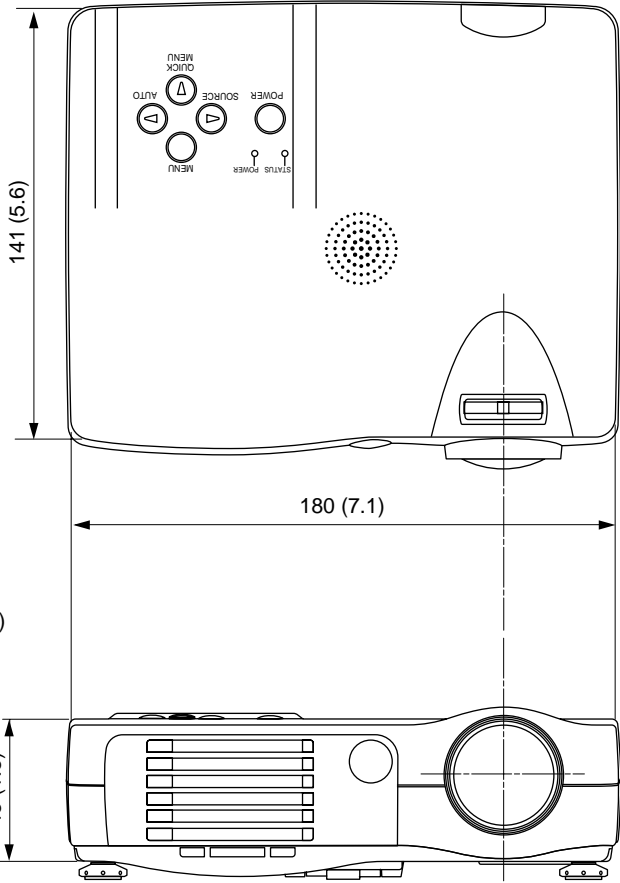
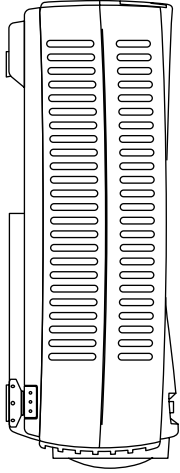

Unit: mm (inch)

PLUS Vision Corp.

20-11, Otowa 1-chome, Bunkyo-ku, Tokyo, 112-0013 JAPAN

www.plus-vision.com

TEL: +81-(0)3-3942-3157

FAX: +81-(0)3-3942-3160



PLUS Industrial Corporation is certified to ISO 9001.
Certificate No. Q1001219118017.



Otowa Head Office and PLUSLAND of PLUS Corporation
and PLUS Industrial Corporation are certified to ISO 14001.
Certificate No. NQE-9809008A.

* PLUS Vision Corp. is certified to ISO 14001 as a member of the PLUS group.

©2001, PLUS Vision Corp.

Free Manuals Download Website

<http://myh66.com>

<http://usermanuals.us>

<http://www.somanuals.com>

<http://www.4manuals.cc>

<http://www.manual-lib.com>

<http://www.404manual.com>

<http://www.luxmanual.com>

<http://aubethermostatmanual.com>

Golf course search by state

<http://golfingnear.com>

Email search by domain

<http://emailbydomain.com>

Auto manuals search

<http://auto.somanuals.com>

TV manuals search

<http://tv.somanuals.com>