

Operation Manual

Multi-CD control High power CD/MP3/WMA player
with FM/AM tuner

DEH-P1Y

English

Español

Português (B)

SUPER  **TUNER III** 

Thank you for buying this Pioneer product.

Please read through these operating instructions so you will know how to operate your model properly. *After you have finished reading the instructions, keep this manual in a safe place for future reference.*

01 Before You Start

- About this manual 5
- Precautions 5
- Features 5
- About WMA 5
- Resetting the microprocessor 6
- Protecting your unit from theft 6
 - Removing the front panel 7
 - Attaching the front panel 7
- About the demo mode 7
 - Reverse mode 7
 - Feature demo 7
- Use and care of the remote control 8
 - Installing the battery 8
 - Using the remote control 8
 - FUNCTION button and AUDIO button 8

02 What's What

- Head unit 10
- Remote control 11

03 Basic Operations

- Turning the unit on 12
- Selecting a source 12
- Loading a disc 12
- Adjusting the volume 13
- Turning the unit off 13

04 Tuner

- Listening to the radio 14
- Introduction of advanced tuner operation 15
- Storing broadcast frequencies 15
- Recalling broadcast frequencies 15
- Storing the strongest broadcast frequencies 16
- Selecting stations from the preset channel list 16

Tuning in strong signals 16

05 Built-in CD Player

- Playing a CD 18
- Selecting a track directly 18
- Introduction of advanced built-in CD player operation 19
- Repeating play 19
- Playing tracks in a random order 19
- Scanning tracks of a CD 20
- Pausing CD playback 20
- Selecting the search method 20
- Searching every 10 tracks in the current disc 20
- Using compression and BMX 21
- Entering disc titles 21
- Using CD TEXT functions 22
 - Displaying titles on CD TEXT discs 22
 - Scrolling titles in the display 22
 - Selecting tracks from the track title list 22

06 MP3/WMA/WAV Player

- Playing MP3/WMA/WAV 23
- Selecting a track directly in the current folder 24
- Introduction of advanced built-in CD player (MP3/WMA/WAV) operation 24
- Repeating play 25
- Playing tracks in a random order 25
- Scanning folders and tracks 25
- Pausing MP3/WMA/WAV playback 26
- Selecting the search method 26
- Searching every 10 tracks in the current disc 26
- Switching the tag display 26
- Using compression and BMX 27

- Displaying text information on MP3/WMA/WAV disc **27**
 - When playing back an MP3/WMA disc **27**
 - When playing back a WAV disc **27**
- Scrolling text information in the display **28**
- Selecting tracks from the file name list **28**

07 Multi-CD Player

- Playing a CD **29**
- Selecting a track directly **29**
- 50-disc multi-CD player **30**
- Introduction of advanced multi-CD player operation **30**
- Repeating play **31**
- Playing tracks in a random order **31**
- Scanning CDs and tracks **31**
- Pausing CD playback **32**
- Using ITS playlists **32**
 - Creating a playlist with ITS programming **32**
 - Playback from your ITS playlist **32**
 - Erasing a track from your ITS playlist **33**
 - Erasing a CD from your ITS playlist **33**
- Using disc title functions **33**
 - Entering disc titles **33**
 - Selecting discs from the disc title list **34**
- Using CD TEXT functions **34**
 - Displaying titles on CD TEXT discs **34**
 - Scrolling titles in the display **35**
 - Selecting tracks from the track title list **35**
- Using compression and bass emphasis **35**

08 TV tuner

- Watching the TV tuner **36**
- Introduction of advanced TV tuner operation **37**
- Storing broadcast stations **37**
- Recalling broadcast stations **37**
- Storing the strongest broadcast stations sequentially **37**
- Selecting stations from the preset channel list **38**

09 DVD Player

- Playing a disc **39**
- Selecting a disc **39**
- Introduction of advanced DVD player operation **40**
- Repeating play **40**
- Pausing disc playback **40**
- Playing tracks in a random order **41**
- Scanning tracks of a CD **41**
- Using ITS playlist and disc title functions **41**
- Using disc title functions **41**
 - Entering disc titles **41**

10 Audio Adjustments

- Introduction of audio adjustments **42**
- Compensating for equalizer curves (EQ-EX) **42**
- Setting the sound focus equalizer (SFEQ) **43**
- Using balance adjustment **43**
- Using the equalizer **44**
 - Recalling equalizer curves **44**
 - Adjusting equalizer curves **44**
 - Fine-adjusting equalizer curve **44**
- Adjusting bass and treble **45**
- Adjusting loudness **45**
- Using subwoofer output **46**
 - Adjusting subwoofer settings **46**

- Using nonfading output **46**
 - Adjusting nonfading output level **47**
- Using the high pass filter **47**
- Adjusting source levels **47**
- Using automatic sound levelizer **48**

11 Initial Settings

- Adjusting initial settings **49**
- Setting the clock **49**
- Setting the FM tuning step **49**
- Setting the AM tuning step **50**
- Switching the warning tone **50**
- Switching the auxiliary setting **50**
- Switching the dimmer setting **50**
- Adjusting the brightness **51**
- Setting the rear output and subwoofer controller **51**
- Switching the telephone muting/attenuation **51**
- Switching the motion screen **52**
- Switching the Ever Scroll **52**
- Switching the flap auto open **52**

12 Other Functions

- Turning the clock display on or off **53**
- Using the AUX source **53**
 - Selecting AUX as the source **53**
 - Setting the AUX title **53**
- Using different entertainment displays **54**
- Rewriting the entertainment displays **54**
- Using the PGM button **54**

Additional Information

- Understanding built-in CD player error messages **56**
- Understanding error message on rewriting the entertainment displays **56**
- CD player and care **56**
- CD-R/CD-RW discs **57**

- MP3, WMA and WAV files **57**
 - MP3 additional information **58**
 - WMA additional information **58**
 - WAV additional information **59**
- About folders and MP3/WMA/WAV files **59**
- Terms **60**
- Specifications **62**

Before You Start

About this manual

This unit features a number of sophisticated functions ensuring superior reception and operation. All the functions have been designed for the easiest possible use, but many are not self-explanatory. This operation manual will help you benefit fully from this unit's potential and to maximize your listening enjoyment. We recommend that you familiarize yourself with the functions and their operation by reading through the manual before you begin using this unit. It is especially important that you read and observe precautions noted on this page and in other sections. □

Precautions

CAUTION:
USE OF CONTROL OR ADJUSTMENT OR PERFORMANCE OF PROCEDURES OTHER THAN THOSE SPECIFIED HEREIN MAY RESULT IN HAZARDOUS RADIATION EXPOSURE.

CAUTION:
THE USE OF OPTICAL INSTRUMENTS WITH THIS PRODUCT WILL INCREASE EYE HAZARD.

- Keep this manual handy as a reference for operating procedures and precautions.
- Always keep the volume low enough so that you can hear sounds from outside the vehicle.
- Protect this unit from moisture.
- If the battery is disconnected or discharged, the preset memory will be erased and must be reprogrammed.
- If this unit does not operate properly, contact your dealer or nearest authorized Pioneer Service Station. □

Features

CD playback

Music CD/CD-R/CD-RW playback is possible.

MP3 file playback

You can play back MP3 files recorded on CD-ROM/CD-R/CD-RW (ISO9660 Level 1/Level 2 standard recordings).

- Supply of this product only conveys a license for private, non-commercial use and does not convey a license nor imply any right to use this product in any commercial (i.e. revenue-generating) real time broadcasting (terrestrial, satellite, cable and/or any other media), broadcasting/streaming via internet, intranets and/or other networks or in other electronic content distribution systems, such as pay-audio or audio-on-demand applications. An independent license for such use is required. For details, please visit <http://www.mp3licensing.com>.

WMA file playback

You can play back WMA files recorded on CD-ROM/CD-R/CD-RW (ISO9660 Level 1/Level 2 standard recordings).

WAV file playback

You can play back WAV files recorded on CD-ROM/CD-R/CD-RW (Linear PCM (LPCM)/MS ADPCM recordings). □

About WMA



The Windows Media™ logo printed on the box indicates that this unit can play back WMA data.

WMA is short for Windows Media Audio and refers to an audio compression technology that is developed by Microsoft Corporation. WMA data can be encoded by using Windows Media Player version 7 or later.

Microsoft, Windows Media, and the Windows logo are trademarks, or registered trademarks of Microsoft Corporation in the United States and/or other countries.



Notes

- With some applications used to encode WMA files, this unit may not operate correctly.
- With some applications used to encode WMA files, album names and other text information may not be correctly displayed. 

Resetting the microprocessor

The microprocessor must be reset under the following conditions:

- Prior to using this unit for the first time after installation
- If the unit fails to operate properly
- When strange or incorrect messages appear on the display

- **Press RESET with a pen tip or other pointed instrument.**

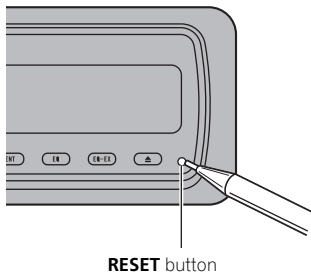

Protecting your unit from theft

The front panel can be detached from the head unit and stored in the protective case provided to discourage theft.

- If the front panel is not detached from the head unit within five seconds of turning off the ignition, a warning tone will sound.
- You can turn off the warning tone. See *Switching the warning tone* on page 50.



Important

- Never use force or grip the display and the buttons too tightly when removing or attaching.
- Avoid subjecting the front panel to excessive shocks.
- Keep the front panel out of direct sunlight and high temperatures.
- A few seconds after turning the ignition switch to on or off, the front panel automatically moves. When this happens, your fingers may become jammed in the panel, so keep your hands away from it.
- When removing the front panel, be sure to hold the corrugated release button on the rear of the front panel while pulling.

Before You Start

Removing the front panel

- 1 Press EJECT to open the front panel.

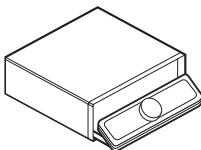

- 2 Slide and remove the front panel toward you.

Take care not to grip it too tightly or to drop the front panel and protect it from contact with water or other fluids to prevent permanent damage.

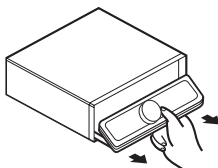

- 3 Put the front panel into the protective case provided for safe keeping.

Attaching the front panel

- 1 Make sure the inner cover is closed.
- 2 Replace the front panel by clipping it into place.

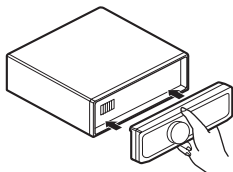

About the demo mode

This unit features two demonstration modes. One is the reverse mode, the other is the feature demo mode.

- You cannot cancel a demo mode when the front panel is open.
- When the front panel is open, **BAND**, **ENTERTAINMENT**, **EQ** and **EQ-EX** are not available.

Important

The red lead (ACC) of this unit should be connected to a terminal coupled with ignition switch on/off operations. If this is not done, the vehicle battery may be drained.

Reverse mode

If you do not perform an operation within about 30 seconds, screen indications start to reverse, and then continue reversing every 10 seconds. Pressing **BAND** when power to this unit is turned off while the ignition switch is set to ACC or ON cancels the reverse mode. Press **BAND** again to start the reverse mode.

Feature demo

The feature demo automatically starts when power to this unit is turned off while the ignition switch is set to ACC or ON. Pressing **ENTERTAINMENT** during feature demo operation cancels the feature demo mode. Press **ENTERTAINMENT** again to start the feature mode. Remember that if the feature demo continues operating when the car engine is turned off, it may drain battery power. ■

Use and care of the remote control

Installing the battery

Slide the tray out on the back of the remote control and insert the battery with the plus (+) and minus (-) poles pointing in the proper direction.

- When using for the first time, pull out the film protruding from the tray.

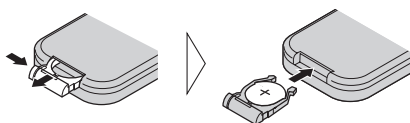

! WARNING

Keep the battery out of the reach of children. Should the battery be swallowed, immediately consult a doctor.

! CAUTION

- Use only one **CR2025 (3 V)** lithium battery.
- Remove the battery if the remote control is not used for a month or longer.
- Do not recharge, disassemble, heat or dispose of the battery in fire.
- Do not handle the battery with metallic tools.
- Do not store the battery with metallic materials.
- In the event of battery leakage, wipe the remote control completely clean and install a new battery.
- When disposing of used batteries, please comply with governmental regulations or environmental public institutions' rules that apply in your country/area.

Using the remote control

Point the remote control in the direction of the front panel to operate.

- The remote control may not function properly in direct sunlight.

! Important

- Do not store the remote control in high temperatures or direct sunlight.
- Do not let the remote control fall onto the floor, where it may become jammed under the brake or accelerator pedal.

FUNCTION button and AUDIO button

You can also select the desired mode by **FUNCTION** button and **AUDIO** button on the remote control. But operation of **FUNCTION** button and **AUDIO** button on the remote control differs from the operation of **Multi-Control** on the head unit. When operating the remote control, switch through the modes as described below to select the mode.

FUNCTION button operation

- **Press FUNCTION to select the desired mode (e.g., built-in CD player).**

Press **FUNCTION** repeatedly to switch between the following modes:

Repeat (repeat play)—**Random** (random play)—**Scan** (scan play)—**Pause** (pause)—**FF/REV** (search method)—**Tag Read** (tag display)—**COMP/BMX** (compression and BMX)—disc title input

! Note

Refer to *Introduction of advanced built-in CD player operation* on page 19.

Before You Start

AUDIO button operation

- Press **AUDIO** to select the desired mode.

Press **AUDIO** repeatedly to switch between the following modes:

Fad (balance adjustment)—**EQ** (equalizer curve adjustment)—**Bass** (bass and treble level adjustment)—**Loud** (loudness)
—**Sub-W1** (subwoofer on/off setting)/**NonFad** (nonfading output on/off setting)—**Sub-W2** (subwoofer setting)/**NonFad** (nonfading output setting)—**HPF** (high pass filter)—**SLA** (source level adjustment)—**ASL** (automatic sound levelizer)



Note

Refer to *Introduction of audio adjustments* on page 42. 

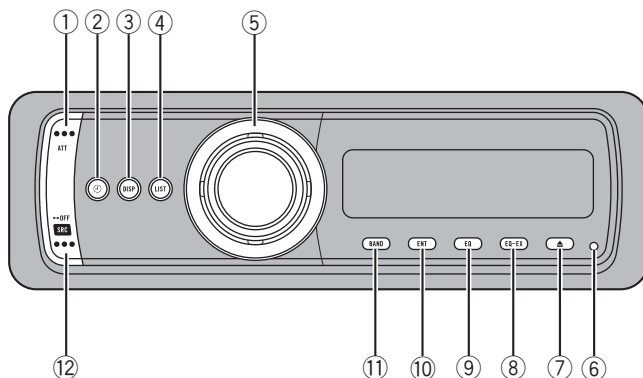

Head unit

① ATT button

Press to quickly lower the volume level, by about 90%. Press once more to return to the original volume level.

② CLOCK button

Press to change to the clock display.

③ DISPLAY button

Press to select different displays.

④ LIST button

Press to display the disc title list, track title list, folder list, file list or preset channel list according to the source.

⑤ Multi-Control

Move to do manual seek tuning, fast forward, reverse and track search controls. Also used for controlling functions. Turn it to increase or decrease the volume.

⑥ RESET button

Press to reset the microprocessor.

⑦ EJECT button

Press to eject a CD from your built-in CD player.

⑧ EQ-EX button

Press and hold to switch between EQ-EX and SFEQ functions. Press to operate each function.

⑨ EQ button

Press to select various equalizer curves.

⑩ ENTERTAINMENT button

Press to change to the entertainment display.

⑪ BAND button

Press to select among three FM bands and one AM band and to cancel the control mode of functions.

⑫ SOURCE button

This unit is turned on by selecting a source. Press to cycle through all the available sources. ■

What's What

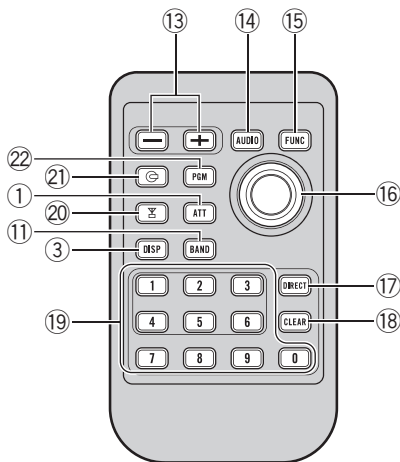

Remote control

Operation is the same as when using the buttons on the head unit.

- ⑬ **VOLUME buttons**
Press to increase or decrease the volume.
- ⑭ **AUDIO button**
Press to select various sound quality controls.
- ⑮ **FUNCTION button**
Press to select functions.
- ⑯ **Joystick**
Move to do manual seek tuning, fast forward, reverse and track search controls. Also used for controlling functions. Functions are the same as **Multi-Control** except for volume control.
- ⑰ **DIRECT button**
Press to directly select the desired track.

- ⑱ **CLEAR button**
Press to cancel the input number when **NUMBER** are used.
- ⑲ **NUMBER buttons**
Press to directly select the desired track, preset tuning or disc. Buttons **1-6** can operate the preset tuning for the tuner or disc number search for the multi-CD player.
- ⑳ **TUNER button**
Press to select the tuner as the source.
- ㉑ **CD button**
Press to select the built-in or multi-CD player as the source.
- ㉒ **PGM button**
Press to operate the preprogrammed functions for each source. (Refer to *Using the PGM button* on page 54.) ▣

Turning the unit on

- **Press SOURCE to turn the unit on.**

When you select a source the unit is turned on. 

Selecting a source

You can select a source you want to listen to. To switch to the built-in CD player, load a disc in the unit (refer to page 18).

- **When using the head unit, press SOURCE to select a source.**

Press **SOURCE** repeatedly to switch between the following sources:

Tuner—Television—DVD player/Multi-DVD player—Built-in CD player—Multi-CD player—External unit 1—External unit 2—AUX

- **When using the remote control, press TUNER or CD to select a source.**

Press each button repeatedly to switch between the following sources:

TUNER: Tuner—Television—Sources off
CD: DVD player/Multi-DVD player—Built-in CD player—Multi-CD player—Sources off

Notes

- In the following cases, the sound source will not change:
 - When there is no unit corresponding to the selected source connected to this unit.
 - When there is no disc in the unit.
 - When there is no disc in the DVD player.
 - When there is no magazine in the multi-CD player.
 - When there is no magazine in the multi-DVD player.
 - When the AUX (auxiliary input) is set to off (refer to page 50).

- External unit refers to a Pioneer product (such as one available in the future) that, although incompatible as a source, enables control of basic functions by this unit. Two external units can be controlled by this unit. When two external units are connected, the allocation of them to external unit 1 or external unit 2 is automatically set by this unit.
- When this unit's blue/white lead is connected to the vehicle's auto-antenna relay control terminal, the vehicle's antenna extends when this unit's source is turned on. To retract the antenna, turn the source off. 

Loading a disc

- 1 Press EJECT to open the front panel.**

CD loading slot appears.

- After a CD has been inserted, press **SOURCE** to select the built-in CD player.

- 2 Insert a CD into the CD loading slot.**

Front panel is closed automatically, and playback will start.

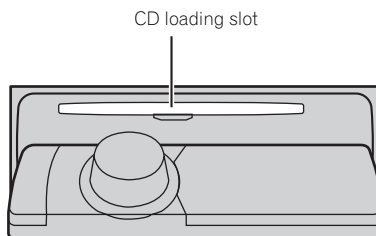

- You can eject a CD by pressing **EJECT**.

Notes

- The built-in CD player plays one, standard, 12-cm or 8-cm (single) CD at a time. Do not use an adapter when playing 8-cm CDs.
- Do not insert anything other than a CD into the CD loading slot.

Basic Operations

- There is sometimes a delay between starting up CD playback and the sound being issued. When being read in, **Format Read** is displayed.
- If you cannot insert a disc completely or if after you insert a disc the disc does not play, check that the label side of the disc is up. Press **EJECT** to eject the disc, and check the disc for damage before inserting it again.
- If the built-in CD player does not operate properly, an error message such as **ERROR-11** may be displayed. Refer to *Understanding built-in CD player error messages* on page 56.
- You can eject the CD by pressing and holding **EJECT** with opening the front panel when the CD loading or ejecting cannot operate properly.

Adjusting the volume

- Use **Multi-Control** to adjust the sound level.

With the head unit, rotate **Multi-Control** to increase or decrease the volume.

With the remote control, press **VOLUME** to increase or decrease the volume.

Volume bar and power output mode (40W or 60W) are displayed while volume is adjusted.



- Please refer to the installation manual for the power setting switch.

Turning the unit off

- Press **SOURCE** and hold until the unit turns off.

Listening to the radio

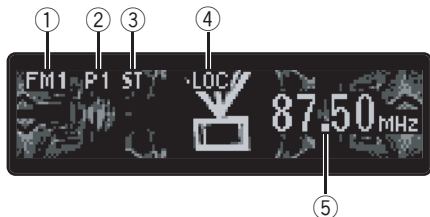

These are the basic steps necessary to operate the radio. More advanced tuner operation is explained starting on the next page.



Important

If you are using this unit in North, Central or South America, reset the AM tuning step (see *Setting the AM tuning step* on page 50).

① Band indicator

Shows which band the radio is tuned to, AM or FM.

② Preset number indicator

Shows which preset has been selected.

③ Stereo (ST) indicator

Shows that the frequency selected is being broadcast in stereo.

④ LOC indicator

Shows when local seek tuning is on.

⑤ Frequency indicator

Shows to which frequency the tuner is tuned.

1 Press SOURCE to select the tuner.

Press **SOURCE** until you see **Tuner** displayed.

2 Press BAND to select a band.

Press **BAND** until the desired band is displayed, **FM1**, **FM2**, **FM3** for FM or **AM**.

3 To perform manual tuning, push Multi-Control left or right.

The frequencies move up or down step by step.

4 To perform seek tuning, push and hold Multi-Control left or right for about one second and release.

The tuner will scan the frequencies until a broadcast strong enough for good reception is found.

- You can cancel seek tuning by pushing **Multi-Control** left or right.
- If you push and hold **Multi-Control** left or right you can skip stations. Seek tuning starts as soon as you release **Multi-Control**. 

Introduction of advanced tuner operation

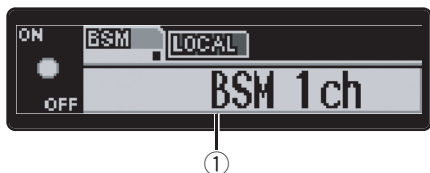

① Function display

Shows the function status.

1 Press Multi-Control to display the main menu.

FUNCTION and **AUDIO** appear on the display.

2 Use Multi-Control to select FUNCTION.

Turn to change the menu option; press to select.

The function name appears on the display.

3 Turn Multi-Control to select the function.

Turn **Multi-Control** clockwise to switch between the functions in the following order:

BSM (best stations memory)—**Local** (local seek tuning)

- You can also switch between the functions in the reverse order by turning **Multi-Control** counterclockwise.

- To return to the frequency display, press

BAND.



Note

If you do not operate the function within about 30 seconds, the display is automatically returned to the frequency display. ▢

Storing broadcast frequencies

You can easily store up to six broadcast frequencies for later recall.

1 When you find a frequency that you want to store in memory press LIST to switch to the preset channel list mode.

2 Use Multi-Control to select the preset number.

Turn to change the preset number; press to select. **1–6** is displayed as the preset tuning number is selected.

3 Press Multi-Control and hold to store the radio station frequency in memory.

The selected radio station frequency has been stored in memory.

- If you do not operate the list within about 8 seconds, the preset channel list mode is cancelled automatically.



Notes

- Up to 18 FM stations, six for each of the three FM bands, and six AM stations can be stored in memory.
- You can also store radio station frequencies assigned to preset tuning numbers by pressing and holding one of the preset tuning buttons **1–6** on the remote control. ▢

Recalling broadcast frequencies

You can recall radio station frequencies assigned to preset tuning numbers.

● Push Multi-Control up or down to recall radio station frequencies.

Pushing **Multi-Control** up or down selects the preset tuning number. **P1 – P6** is displayed as the preset tuning number is selected.

The radio station frequency assigned to the preset tuning number is recalled from memory.

- If you do not operate the list within about 8 seconds, the preset channel list mode is cancelled automatically.

Note

You can also recall radio station frequencies assigned to preset tuning numbers by pressing one of the preset tuning buttons **1–6** on the remote control. 

Storing the strongest broadcast frequencies

BSM (best stations memory) lets you automatically store the six strongest broadcast frequencies under preset tuning buttons **1–6** and once stored there you can tune in to those frequencies with the touch of a button.

1 Use Multi-Control to select BSM.

BSM appears in the display.

2 Press Multi-Control to turn BSM on.

BSM begins to flash. While **BSM** is flashing the six strongest broadcast frequencies will be stored under preset tuning numbers **1–6** in the order of their signal strength. When finished, the preset channel list appears.

- To cancel the storage process, press **Multi-Control**.

3 Use Multi-Control to select the desired station.

Turn to change the station; press to select.

- You can also change the station by pushing **Multi-Control** up or down.

Note

Storing broadcast frequencies with BSM may replace broadcast frequencies you have saved using buttons **1–6**. 

Selecting stations from the preset channel list

The preset channel list lets you see the list of preset stations and select one of them to receive.

1 Press LIST to switch to the preset channel list mode during the frequency display.

2 Use Multi-Control to select the desired station.

Turn to change the station; press to select.

- You can also change the station by pushing **Multi-Control** up or down.

- If you do not operate the list within about 8 seconds, the preset channel list mode is cancelled automatically. 

Tuning in strong signals

Local seek tuning lets you tune in only those radio stations with sufficiently strong signals for good reception.

1 Use Multi-Control to select Local.

Local appears in the display.

2 Press Multi-Control to turn local seek tuning on.

Local seek sensitivity (e.g., **Local 2**) appears in the display.

Tuner

- To turn local seek tuning off, press **Multi-Control** again.

3 Push **Multi-Control** left or right to set the sensitivity.

There are four levels of sensitivity for FM and two levels for AM:

FM: **Local 1—Local 2—Local 3—Local 4**

AM: **Local 1—Local 2**

The **Local 4** setting allows reception of only the strongest stations, while lower settings let you receive progressively weaker stations. 

Playing a CD

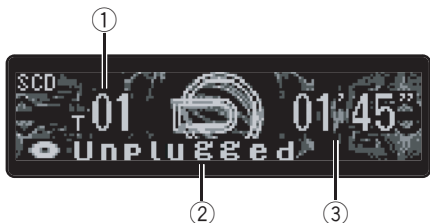

These are the basic steps necessary to play a CD with your built-in CD player. More advanced CD operation is explained starting on the next page.

① Track number indicator

Shows the track currently playing.

② Disc title indicator

Shows the title of the currently playing disc.

- If no title has been entered for the currently playing disc, nothing is displayed.

③ Play time indicator

Shows the elapsed playing time of the current track.

1 Press SOURCE to select the built-in CD player.

Press **SOURCE** until you see **Compact Disc** displayed.

- If no disc is loaded in the unit, you cannot select **Compact Disc** (built-in CD player). Insert a disc in the unit. (Refer to page 12.)

2 To perform fast forward or reverse, push and hold Multi-Control left or right.

- If you select **ROUGH SEARCH**, pushing and holding **Multi-Control** left or right enables you to search every 10 tracks in the current disc. (Refer to *Selecting the search method* on page 20.)

3 To skip back or forward to another track, push Multi-Control left or right.

Pushing **Multi-Control** right skips to the start of the next track. Pushing **Multi-Control** left once skips to the start of the current track. Pushing again will skip to the previous track.

Note

When a CD TEXT disc is inserted, the disc title automatically begins to scroll in the display. When **Ever Scroll** is set to **ON** at the initial setting, the disc title scrolls continuously. About **Ever Scroll**, refer to *Switching the Ever Scroll* on page 52. ▣

Selecting a track directly

When using the remote control, you can select a track directly by entering the desired track number.

- You cannot operate this mode from function display.

1 Press DIRECT.

Track number input display appears.

2 Press NUMBER buttons to enter the desired track number.

- You can cancel the input number by pressing **CLEAR**.

3 Press DIRECT.

The track of entered number will play.

Note

After entering the number input mode, if you do not perform an operation within about eight seconds, the mode is automatically canceled. ▣

Built-in CD Player

Introduction of advanced built-in CD player operation

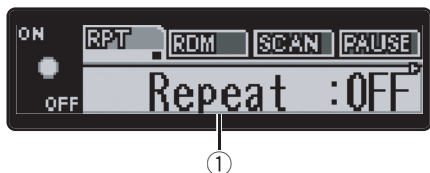

① Function display

Shows the function status.

1 Press Multi-Control to display the main menu.

FUNCTION and **AUDIO** appear on the display.

2 Use Multi-Control to select **FUNCTION**.

Turn to change the menu option; press to select.

The function name appears on the display.

3 Turn Multi-Control to select the function.

Turn **Multi-Control** clockwise to switch between the functions in the following order:

Repeat (repeat play)—**Random** (random play)—**Scan** (scan play)—**Pause** (pause)—**FF/REV** (search method)—**Tag Read** (tag display)—**COMP/BMX** (compression and BMX)—disc title input

- You can also switch between the functions in the reverse order by turning **Multi-Control** counterclockwise.
- To return to the playback display, press **BAND**.



Notes

- When playing audio data (CD-DA), tag display is not effective even if you turn **Tag Read** (tag display) on. (Refer to page 26.)

- If you do not operate the function within about 30 seconds, the display is automatically returned to the playback display.

Repeating play

Repeat play lets you hear the same track over again.

1 Use Multi-Control to select **Repeat**.

Repeat appears in the display.

2 Press Multi-Control to turn repeat play on.

Repeat :ON appears in the display. The track currently playing will play to the end and then repeat.

- To turn repeat play off, press **Multi-Control** again.



Note

If you perform track search or fast forward/reverse, repeat play is automatically cancelled.

Playing tracks in a random order

Random play lets you play back tracks on the CD in a random order.

1 Use Multi-Control to select **Random**.

Random appears in the display.

2 Press Multi-Control to turn random play on.

Random :ON appears in the display. Tracks will play in a random order.

- To turn random play off, press **Multi-Control** again.

Scanning tracks of a CD

Scan play lets you hear the first 10 seconds of each track on the CD.

1 Use Multi-Control to select Scan.

Scan appears in the display.

2 Press Multi-Control to turn scan play on.

Scan:ON appears in the display. The first 10 seconds of each track is played.

3 When you find the desired track press Multi-Control to turn scan play off.

Scan:OFF appears in the display. The track will continue to play.

- If the display has automatically returned to the playback display, select **Scan** again by using **Multi-Control**.



Note

After scanning of a CD is finished, normal playback of the tracks will begin again. 

Pausing CD playback

Pause lets you temporarily stop playback of the CD.

1 Use Multi-Control to select Pause.

Pause appears in the display.

2 Press Multi-Control to turn pause on.

Pause:ON appears in the display. Play of the current track pauses.

- To turn pause off, press **Multi-Control** again. 

Selecting the search method

You can switch the search method between fast forward/reverse and searching every 10 tracks.

1 Use Multi-Control to select FF/REV.

FF/REV appears in the display.

- If the search method **ROUGH SEARCH** has been previously selected, **ROUGH SEARCH** will be displayed.

2 Press Multi-Control to select the search method.

Press **Multi-Control** until the desired search method appears in the display.

- **FF/REV** – Fast forward and reverse
- **ROUGH SEARCH** – Searching every 10 tracks 

Searching every 10 tracks in the current disc

If a disc contains over 10 tracks, you can search every 10 tracks. When a disc contains a lot of tracks, you can roughly search for the track you want to play.

1 Select the search method **ROUGH SEARCH**.

Refer to *Selecting the search method* on this page.

2 Push and hold Multi-Control left or right to search every 10 tracks on a disc.

- If a disc contains less than 10 tracks, pushing and holding **Multi-Control** right recalls the last track of the disc. Also, if the remaining number of tracks after searching every 10 tracks is less than 10, pushing and holding **Multi-Control** right recalls the last track of the disc.
- If a disc contains less than 10 tracks, pushing and holding **Multi-Control** left recalls the first

Built-in CD Player

track of the disc. Also, if the remaining number of tracks after searching every 10 tracks is less than 10, pushing and holding **Multi-Control** left recalls the first track of the disc. 

Using compression and BMX

Using the COMP (compression) and BMX functions let you adjust the sound playback quality of the CD player. Each of the functions have a two-step adjustment. The COMP function balances the output of louder and softer sounds at higher volumes. BMX controls sound reverberations to give playback a fuller sound. Listen to each of the effects as you select through them and use the one that best enhances the playback of the track or CD that you are listening to.

1 Use Multi-Control to select COMP/BMX. COMP/BMX appears in the display.

2 Press Multi-Control to select your favorite setting.

Press **Multi-Control** repeatedly to switch between the following settings:

COMP/BMX :OFF—COMP 1—COMP 2—
COMP/BMX :OFF—BMX1—BMX2 

Entering disc titles

You can input CD titles and display the title. The next time you insert a CD for which you have entered a title, the title of that CD will be displayed.

Use the disc title input feature to store up to 48 CD titles in the unit. Each title can be up to 10 characters long.

- When playing a CD TEXT disc, you cannot switch to disc title input display. The disc

title will have already been recorded on a CD TEXT disc.

1 Play the CD that you want to enter a title for.

2 Use Multi-Control to select disc title input display.

3 Press DISPLAY to select the desired character type.

Press **DISPLAY** repeatedly to switch between the following character types:
Alphabet (upper case)—Alphabet (lower case)
—European letters, such as those with accents (e.g. á, à, ä, ç)—Numbers and symbols

4 Push Multi-Control up or down to select a letter of the alphabet.

Each pushing **Multi-Control** up will display a letter of the alphabet in **A B C ... X Y Z**, numbers and symbols in **1 2 3 ... @ # <** order. Each pushing **Multi-Control** down will display a letter in the reverse order, such as **Z Y X ... C B A**.



5 Push Multi-Control right to move the cursor to the next character position.

When the letter you want is displayed, push **Multi-Control** right to move the cursor to the next position and then select the next letter. Push **Multi-Control** left to move backwards in the display.

6 Move the cursor to the last position by pushing Multi-Control right after entering the title.

When you push **Multi-Control** right one more time, the entered title is stored in memory.

7 Press BAND to return to the playback display.



Notes

- Titles remain in memory, even after the disc has been removed from the unit, and are recalled when the disc is reinserted.
- After data for 48 discs has been stored in memory, data for a new disc will overwrite the oldest one.
- If you connect a multi-CD player, you can input disc titles for up to 100 discs.

Using CD TEXT functions

Some discs have certain information encoded on the disc during manufacture. These discs may contain such information as the CD title, track title, artist's name and playback time and are called CD TEXT discs. Only these specially encoded CD TEXT discs support the functions listed below.

Displaying titles on CD TEXT discs

You can display the title of any disc that has had a disc title entered.

● Press DISPLAY.

Press **DISPLAY** repeatedly to switch between the following settings:

- ▶: track title — ◂: disc title and ◂: disc artist name — ◂: disc artist name and ▶: track title
- ▶: track title and ▶: track artist name —▶: track artist name and ▶: track title
- If specific information has not been recorded on a CD TEXT disc, title or name is not displayed.

Scrolling titles in the display

This unit can display the first 17 letters of disc title, disc artist name, track title and track artist name. When the text information is longer than 17 letters, you can scroll the display as follows.

● Press DISPLAY and hold until the title begins to scroll through the display.

The titles scroll.



Note

When Ever Scroll is set to ON at the initial setting, CD text information scrolls continuously in the display. If you want to display the first 17 characters of text information temporarily and scroll from the beginning, press and hold **DISPLAY**. About Ever Scroll, refer to *Switching the Ever Scroll* on page 52.

Selecting tracks from the track title list

Track title list lets you see the list of track titles on a CD TEXT disc and select one of them to play back.

1 Press LIST to switch to the track title list mode.

2 Use Multi-Control to select the desired track title.

- Turn to change the track title; press to play.
 - You can also change the track title by pushing **Multi-Control** up or down.
 - If you do not operate the list within about 8 seconds, the track title list mode is cancelled automatically.

MP3/WMA/WAV Player

Playing MP3/WMA/WAV

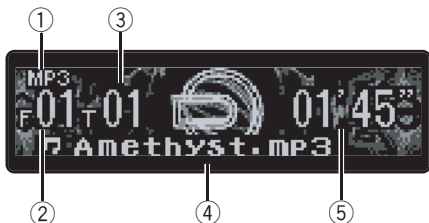

These are the basic steps necessary to play an MP3/WMA/WAV with your built-in CD player. More advanced MP3/WMA/WAV operation is explained starting on the next page.

① MP3/WMA/WAV indicator

Shows the type of file currently playing.

② Folder number indicator

Shows the number of folder currently playing.

③ Track number indicator

Shows the track (file) currently playing.

④ File name indicator

Shows the name of file currently playing.

⑤ Play time indicator

Shows the elapsed playing time of the current track (file).

1 Press SOURCE to select the built-in CD player.

Press **SOURCE** until you see **Compact Disc** displayed.

- If no disc is loaded in the unit, you cannot select **Compact Disc** (built-in CD player). Insert a disc in the unit. (Refer to page 12.)

2 Push Multi-Control up or down to select a folder.

- You cannot select a folder that does not have an MP3/WMA/WAV file recorded in it.
- To return to folder 01 (ROOT), press and hold **BAND**. However, if folder 01 (ROOT) contains no files, playback commences with folder 02.

3 To perform fast forward or reverse, push and hold Multi-Control left or right.

- This is fast forward and reverse operation only for the file being played. This operation is canceled when the previous or next file is reached.
- If you select **ROUGH SEARCH**, pushing and holding **Multi-Control** left or right enables you to search every 10 tracks in the current folder. (Refer to *Selecting the search method* on page 26.)

4 To skip back or forward to another track, push Multi-Control left or right.

Pushing **Multi-Control** right skips to the start of the next track. Pushing **Multi-Control** left once skips to the start of the current track. Pushing again will skip to the previous track.



Notes

- When playing discs with MP3/WMA/WAV files and audio data (CD-DA) such as CD-EXTRA and MIXED-MODE CDs, both types can be played only by switching mode between MP3/WMA/WAV and CD-DA with **BAND**.
- If you have switched between playback of MP3/WMA/WAV files and audio data (CD-DA), playback starts at the first track on the disc.
- The built-in CD player can play back an MP3/WMA/WAV file recorded on CD-ROM. (Refer to page 57 for files that can be played back.)
- Playback is carried out in order of file number. Folders are skipped if they contain no files. (If folder 01 (ROOT) contains no files, playback commences with folder 02.)

- When playing back files recorded as VBR (variable bit rate) files, the play time will not be correctly displayed if fast forward or reverse operations are used.
- If the inserted disc contains no files that can be played back, **No Audio** is displayed.
- If the inserted disc contains WMA files that are protected by digital rights management (DRM), **TRK SKIPPED** is displayed while the protected file is skipped.
- If all the files on the inserted disc are secured by DRM, **PROTECT** is displayed.
- There is no sound on fast forward or reverse.

Selecting a track directly in the current folder

When using the remote control, you can select a track directly by entering the desired track number.

- You cannot operate this mode from function display.

1 Press DIRECT.

Track number input display appears.

2 Press NUMBER buttons to enter the desired track number.

- You can cancel the input number by pressing **CLEAR**.

3 Press DIRECT.

The track of entered number will play.



Note

After entering the number input mode, if you do not perform an operation within about eight seconds, the mode is automatically canceled.

Introduction of advanced built-in CD player (MP3/WMA/WAV) operation



① Function display

Shows the function status.

1 Press Multi-Control to display the main menu.

FUNCTION and **AUDIO** appear on the display.

2 Use Multi-Control to select FUNCTION.

Turn to change the menu option; press to select.

The function name appears on the display.

3 Turn Multi-Control to select the function.

Turn **Multi-Control** clockwise to switch between the functions in the following order:
Repeat (repeat play)—**Random** (random play)
 —**Scan** (scan play)—**Pause** (pause)—**FF/REV** (search method)—**Tag Read** (tag display)
 —**COMP/BMX** (compression and BMX)

- You can also switch between the functions in the reverse order by turning **Multi-Control** counterclockwise.
- To return to the playback display, press **BAND**.



Note

If you do not operate the function within about 30 seconds, the display is automatically returned to the playback display.

MP3/WMA/WAV Player

Repeating play

For MP3/WMA/WAV playback, there are three repeat play ranges: **FOLDER** (folder repeat), **TRK** (one-track repeat) and **DISC** (repeat all tracks).

1 Use Multi-Control to select Repeat.

Repeat appears in the display.

2 Press Multi-Control to select the repeat range.

Press **Multi-Control** repeatedly until the desired repeat range appears in the display.

- **FOLDER** – Repeat the current folder
- **TRK** – Repeat just the current track
- **DISC** – Repeat all tracks

Notes

- If you select another folder during repeat play, the repeat play range changes to **DISC**.
- If you perform track search or fast forward/reverse during **TRK**, the repeat play range changes to **FOLDER**.
- When **FOLDER** is selected, it is not possible to play back a subfolder of that folder. 

Playing tracks in a random order

Random play lets you play back tracks in a random order within the repeat range, **FOLDER** and **DISC**.

1 Select the repeat range.

Refer to *Repeating play* on this page.

2 Use Multi-Control to select Random.

Random appears in the display.

3 Press Multi-Control to turn random play on.

Random :ON appears in the display. Tracks will play in a random order within the previously selected **FOLDER** or **DISC** ranges.

- To turn random play off, press **Multi-Control** again. 

Scanning folders and tracks

While you are using **FOLDER**, the beginning of each track in the selected folder plays for about 10 seconds. When you are using **DISC**, the beginning of the first track of each folder is played for about 10 seconds.

1 Select the repeat range.

Refer to *Repeating play* on this page.

2 Use Multi-Control to select Scan.

Scan appears in the display.

3 Press Multi-Control to turn scan play on.

Scan :ON appears in the display. The first 10 seconds of each track of the current folder (or the first track of each folder) is played.

4 When you find the desired track (or folder) press Multi-Control to turn scan play off.

Scan :OFF appears in the display. The track (or folder) will continue to play.

- If the display has automatically returned to the playback display, select **Scan** again by using **Multi-Control**.

Note

After track or folder scanning is finished, normal playback of the tracks will begin again. 

Pausing MP3/WMA/WAV playback

Pause lets you temporarily stop playback of the MP3/WMA/WAV.

1 Use Multi-Control to select Pause.

Pause appears in the display.

2 Press Multi-Control to turn pause on.

Pause:ON appears in the display. Play of the current track pauses.

- To turn pause off, press **Multi-Control** again. 

Selecting the search method

You can switch the search method between fast forward/reverse and searching every 10 tracks.

1 Use Multi-Control to select FF/REV.

FF/REV appears in the display.

- If the search method **ROUGH SEARCH** has been previously selected, **ROUGH SEARCH** will be displayed.

2 Press Multi-Control to select the search method.

Press **Multi-Control** until the desired search method appears in the display.

- **FF/REV** – Fast forward and reverse
- **ROUGH SEARCH** – Searching every 10 tracks 

Searching every 10 tracks in the current disc

If a disc contains over 10 tracks, you can search every 10 tracks. When a disc contains

a lot of tracks, you can roughly search for the track you want to play.

1 Select the search method **ROUGH SEARCH**.

Refer to *Selecting the search method* on page 20.

2 Push and hold Multi-Control left or right to search every 10 tracks on a disc.

- If a disc contains less than 10 tracks, pushing and holding **Multi-Control** right recalls the last track of the disc. Also, if the remaining number of tracks after searching every 10 tracks is less than 10, pushing and holding **Multi-Control** right recalls the last track of the disc.
- If a disc contains less than 10 tracks, pushing and holding **Multi-Control** left recalls the first track of the disc. Also, if the remaining number of tracks after searching every 10 tracks is less than 10, pushing and holding **Multi-Control** left recalls the first track of the disc. 

Switching the tag display

It is possible to turn the tag display on or off, if MP3/WMA disc contains text information such as track title and artist name.

- If you turn the tag display off, time to playback will be shorter than when this function is turned on.

1 Use Multi-Control to select Tag Read.

Tag Read appears in the display.

2 Press Multi-Control to turn tag display on.

Tag Read:ON appears in the display.

- To turn tag display off, press **Multi-Control** again.

MP3/WMA/WAV Player



Note

When you turn the tag display on, the unit returns to the beginning of the current track in order to read the text information.

Using compression and BMX

Using the COMP (compression) and BMX functions let you adjust the sound playback quality of the CD player. Each of the functions have a two-step adjustment. The COMP function balances the output of louder and softer sounds at higher volumes. BMX controls sound reverberations to give playback a fuller sound. Listen to each of the effects as you select through them and use the one that best enhances the playback of the track or CD that you are listening to.

1 Use Multi-Control to select COMP.

COMP appears in the display.

2 Press Multi-Control to select your favorite setting.

Press **Multi-Control** repeatedly to switch between the following settings:

COMP/BMX :OFF—COMP 1—COMP 2—
COMP/BMX :OFF—BMX1—BMX2

Displaying text information on MP3/WMA/WAV disc

Text information recorded on an MP3/WMA/WAV disc can be displayed.

When playing back an MP3/WMA disc

● Press DISPLAY.

Press **DISPLAY** repeatedly to switch between the following settings:

: file name—: folder name and : file name—: file name and : folder name—: track title and : artist name—: artist name and : album title—: album title and : track title—: comment and bit rate

- When playing back MP3 files recorded as VBR (variable bit rate) files, the bit rate value is not displayed even after switching to bit rate. (**VBR** will be displayed.)
- When playing back WMA files recorded as VBR (variable bit rate) files, the average bit rate value is displayed.
- When you have turned tag display off, you cannot switch to track title, artist name, album title or comment.
- If specific information has not been recorded on an MP3/WMA disc, title or name is not displayed.
- With some applications used to encode WMA files, album names and other text information may not be correctly displayed.

When playing back a WAV disc

● Press DISPLAY.

Press **DISPLAY** repeatedly to switch between the following settings:

: file name—: folder name and : file name—: file name and : folder name—sampling frequency

- If specific information has not been recorded on a WAV disc, name is not displayed.
- You can only play back WAV files in the frequencies 16, 22.05, 24, 32, 44.1 and 48 kHz (LPCM), or 22.05 and 44.1 kHz (MS ADPCM). The sampling frequency shown in the display may be rounded.

Scrolling text information in the display

This unit can display the first 17 letters only of folder name, file name, track title, artist name, album title and comment. When the recorded information is longer than 17 letters, you can scroll the text to the left so that the rest of the text information can be seen.

- **Press DISPLAY and hold until the text information begins to scroll through the display.**

The text information scrolls.



Notes

- Unlike MP3 and WMA file format, WAV files display only folder name and file name.
- When Ever Scroll is set to ON at the initial setting, CD text information scrolls continuously in the display. If you want to display the first 17 characters of text information temporarily and scroll from the beginning, press and hold **DISPLAY**. About Ever Scroll, refer to *Switching the Ever Scroll* on page 52. 

Selecting tracks from the file name list

File name list lets you see the list of file names (or folder names) and select one of them to playback.

- 1 Press LIST to switch to the file name list mode.**

Names of files and folders appear in the display.

- 2 Use Multi-Control to select the desired file name (or folder name).**

Turn to change the name of file or folder; press to play; push right to see a list of the files (or folders) in the selected folder.

- You can also change the name of file or folder by pushing **Multi-Control** up or down.
- To return to the previous list (the folder one level higher), push **Multi-Control** left.
- If you do not operate the list within about 8 seconds, the file name list mode is cancelled automatically. 

Multi-CD Player

Playing a CD



You can use this unit to control a multi-CD player, which is sold separately.

These are the basic steps necessary to play a CD with your multi-CD player. More advanced CD operation is explained starting on the next page.

① Disc number indicator

Shows the disc currently playing.

② Track number indicator

Shows the track currently playing.

③ Disc title indicator

Shows the title of the currently playing disc.

- If no title has been entered for the currently playing disc, nothing is displayed.

④ Play time indicator

Shows the elapsed playing time of the current track.

1 Press SOURCE to select the multi-CD player.

Press **SOURCE** until you see **Multi CD** displayed.

2 Push Multi-Control up or down to select a disc you want to listen to.

3 To perform fast forward or reverse, push and hold Multi-Control left or right.

4 To skip back or forward to another track, push Multi-Control left or right.

Pushing **Multi-Control** right skips to the start of the next track. Pushing **Multi-Control** left once skips to the start of the current track. Pushing again will skip to the previous track.



Notes

- When the multi-CD player performs the preparatory operations, **Ready** is displayed.
- If the multi-CD player does not operate properly, an error message such as **ERROR-11** may be displayed. Refer to the multi-CD player owner's manual.
- If there are no discs in the multi-CD player magazine, **No Disc** is displayed.
- When you select a CD TEXT disc on a CD TEXT compatible multi-CD player, the disc and track titles automatically begin to scroll in the display. When Ever Scroll function is ON at the initial setting, the disc and track titles scroll continuously. About Ever Scroll, refer to *Switching the Ever Scroll* on page 52.

Selecting a track directly

When using the remote control, you can select a track directly by entering the desired track number.

- You cannot operate this mode from function display.

1 Press DIRECT.

Track number input display appears.

2 Press NUMBER buttons to enter the desired track number.

- You can cancel the input number by pressing **CLEAR**.

3 Press DIRECT.

The track of entered number will play.

**Note**

After entering the number input mode, if you do not perform an operation within about eight seconds, the mode is automatically canceled. □

50-disc multi-CD player

Only those functions described in this manual are supported for 50-disc multi-CD players.

This unit is not designed to operate disc title list functions with a 50-disc multi-CD player.

About the disc title list functions, please refer to *Selecting discs from the disc title list* on page 34. □

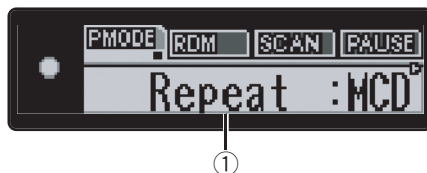
Introduction of advanced multi-CD player operation**① Function display**

Shows the function status.

1 Press Multi-Control to display the main menu.

FUNCTION and **AUDIO** appear on the display.

2 Use Multi-Control to select FUNCTION.

Turn to change the menu option; press to select.

The function name appears on the display.

3 Turn Multi-Control to select the function.

Turn **Multi-Control** clockwise to switch between the functions in the following order:

Repeat (repeat play)—**Random** (random play)—**Scan** (scan play)—**Pause** (pause)—**COMP** (compression and DBE)—**ITS Play** (ITS play)—**ITS** (ITS programming)—disc title input

- You can also switch between the functions in the reverse order by turning **Multi-Control** counterclockwise.
- To return to the playback display, press **BAND**.

**Notes**

- When playing a CD TEXT disc on a CD TEXT compatible multi-CD player, you cannot switch to disc title input. The disc title will have already been recorded on a CD TEXT disc.

Multi-CD Player

- If you do not operate the function within about 30 seconds, the display is automatically returned to the playback display. 

Repeating play

There are three repeat play ranges for the multi-CD player: **MCD** (multi-CD player repeat), **TRK** (one-track repeat) and **DISC** (disc repeat).

1 Use Multi-Control to select Repeat.

Repeat appears in the display.

2 Press Multi-Control to select the repeat range.

Press **Multi-Control** repeatedly until the desired repeat range appears in the display.

- **MCD** – Repeat all discs in the multi-CD player
- **TRK** – Repeat just the current track
- **DISC** – Repeat the current disc

Notes

- If you select other discs during repeat play, the repeat play range changes to **MCD**.
- If you perform track search or fast forward/reverse during **TRK**, the repeat play range changes to **DISC**. 

Playing tracks in a random order

Random play lets you play back tracks in a random order within the repeat range, **MCD** and **DISC**.

1 Select the repeat range.

Refer to *Repeating play* on this page.

2 Use Multi-Control to select Random.

Random appears in the display.

3 Press Multi-Control to turn random play on.

Random :ON appears in the display. Tracks will play in a random order within the previously selected **MCD** or **DISC** ranges.

- To turn random play off, press **Multi-Control** again. 

Scanning CDs and tracks

While you are using **DISC**, the beginning of each track on the selected disc plays for about 10 seconds. When you are using **MCD**, the beginning of the first track of each disc is played for about 10 seconds.

1 Select the repeat range.

Refer to *Repeating play* on this page.

2 Use Multi-Control to select Scan.

Scan appears in the display.

3 Press Multi-Control to turn scan play on.

Scan :ON appears in the display. The first 10 seconds of each track of the current disc (or the first track of each disc) is played.

4 When you find the desired track (or disc) press Multi-Control to turn scan play off.

Scan :OFF appears in the display. The track (or disc) will continue to play.

- If the display has automatically returned to the playback display, select **Scan** again by using **Multi-Control**.

**Note**

After track or disc scanning is finished, normal playback of the tracks will begin again.

Pausing CD playback

Pause lets you temporarily stop playback of the CD.

1 Use Multi-Control to select Pause.

Pause appears in the display.

2 Press Multi-Control to turn pause on.

Pause:ON appears in the display. Play of the current track pauses.

- To turn pause off, press **Multi-Control** again.

Using ITS playlists

ITS (instant track selection) lets you make a playlist of favorite tracks from those in the multi-CD player magazine. After you have added your favorite tracks to the playlist you can turn on ITS play and play just those selections.

Creating a playlist with ITS programming

You can use ITS to enter and play back up to 99 tracks per disc, up to 100 discs (with the disc titles). (With multi-CD players sold before the CDX-P1250 and CDX-P650, up to 24 tracks can be stored in the playlist.)

1 Play a CD that you want to program.

Push **Multi-Control** up or down to select the CD.

2 Use Multi-Control to select ITS.

ITS appears in the display.

3 Select the desired track by pushing Multi-Control left or right.**4 Push Multi-Control up to store the currently playing track in the playlist.**

ITS Input is displayed briefly and the currently playing selection is added to your playlist. The display then shows **ITS** again.

5 Press BAND to return to the playback display.**Note**

After data for 100 discs has been stored in memory, data for a new disc will overwrite the oldest one.

Playback from your ITS playlist

ITS play lets you listen to the tracks that you have entered into your ITS playlist. When you turn on ITS play, tracks from your ITS playlist in the multi-CD player will begin to play.

1 Select the repeat range.

Refer to *Repeating play* on the previous page.

2 Use Multi-Control to select ITS Play.

ITS Play appears in the display.

3 Press Multi-Control to turn ITS play on.

ITS Play:ON appears in the display. Playback begins of those tracks from your playlist within the previously selected **MCD** or **DISC** ranges.

- If no tracks in the current range are programmed for ITS play then **ITS Empty** is displayed.
- To turn ITS play off, press **Multi-Control** again.

Multi-CD Player

Erasing a track from your ITS playlist

When you want to delete a track from your ITS playlist, you can if ITS play is on. If ITS play is already on, skip to step 2. If ITS play is not already on, use **Multi-Control**.

1 Play the CD with the track you want to delete from your ITS playlist, and turn ITS play on.

Refer to *Playback from your ITS playlist* on the previous page.

2 Use Multi-Control to select ITS. ITS appears in the display.

3 Select the desired track by pushing Multi-Control left or right.

4 Push Multi-Control down to erase the track from your ITS playlist.

The currently playing selection is erased from your ITS playlist and playback of the next track from your ITS playlist begins.

- If there are no tracks from your playlist in the current range, **ITS Empty** is displayed and normal play resumes.

5 Press BAND to return to the playback display.

Erasing a CD from your ITS playlist

When you want to delete all tracks of a CD from your ITS playlist, you can if ITS play is off.

1 Play the CD that you want to delete.

Push **Multi-Control** up or down to select the CD.

2 Use Multi-Control to select ITS. ITS appears in the display.

3 Push Multi-Control down to erase all tracks on the currently playing CD from your ITS playlist.

All tracks on the currently playing CD are erased from your playlist and **ITS Clear** is displayed.

4 Press BAND to return to the playback display.

Using disc title functions

You can input CD titles and display the titles. Then you can easily search for and play a desired disc.

Entering disc titles

Use the disc title input feature to store up to 100 CD titles (with ITS playlist) into the multi-CD player. Each title can be up to 10 characters long.

1 Play the CD that you want to enter a title for.

Push **Multi-Control** up or down to select the CD.

2 Use Multi-Control to select disc title input display.

3 Press DISPLAY to select the desired character type.

Press **DISPLAY** repeatedly to switch between the following character types:
 Alphabet (upper case)—Alphabet (lower case)
 —European letters, such as those with accents (e.g. **á, à, ä, ç**)—Numbers and symbols

4 Push Multi-Control up or down to select a letter of the alphabet.

Each pushing **Multi-Control** up will display a letter of the alphabet in **A B C ... X Y Z**, numbers and symbols in **1 2 3 ... @ # <** order. Each pushing **Multi-Control** down will display a letter in the reverse order, such as **Z Y X ... C B A**.



5 Push Multi-Control right to move the cursor to the next character position.

When the letter you want is displayed, push **Multi-Control** right to move the cursor to the next position and then select the next letter. Push **Multi-Control** left to move backwards in the display.

6 Move the cursor to the last position by pushing Multi-Control right after entering the title.

When you push **Multi-Control** right one more time, the entered title is stored in memory.

7 Press BAND to return to the playback display.



Notes

- Titles remain in memory, even after the disc has been removed from the magazine, and are recalled when the disc is reinserted.
- After data for 100 discs has been stored in memory, data for a new disc will overwrite the oldest one.

Selecting discs from the disc title list

Disc title list lets you see the list of disc titles that have been entered into the multi-CD player and select one of them to play back.

1 Press LIST to switch to the disc title list mode during the playback display.

2 Use Multi-Control to select the desired disc title.

Turn to change the disc title; press to play.

- You can also change the disc title by pushing **Multi-Control** up or down.
- If no title has been entered for a disc, **NO TITLE** will be displayed.
- **No Disc** is displayed next to the disc number when there is no disc in the magazine.

Using CD TEXT functions

You can use these functions only with a CD TEXT compatible multi-CD player.

Some discs have certain information encoded on the disc during manufacture. These discs may contain such information as the CD title, track title, artist's name and playback time and are called CD TEXT discs. Only these specially encoded CD TEXT discs support the functions listed below.

Displaying titles on CD TEXT discs

● Press DISPLAY.

Press **DISPLAY** repeatedly to switch between the following settings:

: track title — : disc title and : disc artist name — : disc artist name and : track title — : track title and : track artist name — : track artist name and : track title

Multi-CD Player

- If specific information has not been recorded on a CD TEXT disc, **No XXXX** will be displayed (e.g., **No T-Artist Name**).

Scrolling titles in the display

This unit can display the first 17 letters of disc title, disc artist name, track title and track artist name. When the text information is longer than 17 letters, you can scroll the display as follows.

- **Press DISPLAY and hold until the title begins to scroll through the display.**

The titles scroll.

Note

When Ever Scroll is set to ON at the initial setting, CD text information scrolls continuously in the display. If you want to display the first 17 characters of text information temporarily and scroll from the beginning, press and hold **DISPLAY**. About Ever Scroll, refer to *Switching the Ever Scroll* on page 52.

Selecting tracks from the track title list

Track title list lets you see the list of track titles on a CD TEXT disc and select one of them to play back.

- 1 Press LIST to switch to the disc title list mode during the playback display.**

- If you want to display the track title list of the currently playing disc, push **Multi-Control** right.

- 2 Use Multi-Control to select the desired disc title of CD TEXT.**

Turn to change the disc title; press to play.

- You can also change the disc title by pushing **Multi-Control** up or down.

- If no title has been entered for a disc, **NO TITLE** will be displayed.
- **No Disc** is displayed next to the disc number when there is no disc in the magazine.

- 3 Push Multi-Control right to switch to the track title list.**

- 4 Use Multi-Control to select the desired track title.**

Turn to change the track title; press to play.

- You can also change the track title by pushing **Multi-Control** up or down. 

Using compression and bass emphasis

You can use these functions only with a multi-CD player that supports them.

Using COMP (compression) and DBE (dynamic bass emphasis) functions lets you adjust the sound playback quality of the multi-CD player. Each of the functions has a two-step adjustment. The COMP function balances the output of louder and softer sounds at higher volumes. DBE boosts bass levels to give playback a fuller sound. Listen to each of the effects as you select them and use the one that best enhances the playback of the track or CD that you are listening to.

- 1 Use Multi-Control to select COMP.**

COMP appears in the display.

- If the multi-CD player does not support COMP/DBE, **No Comp.** is displayed when you attempt to select it.

- 2 Press Multi-Control to select your favorite setting.**

Press **Multi-Control** repeatedly to switch between the following settings:

**COMP OFF—COMP 1—COMP 2—
COMP OFF—DBE 1—DBE 2** 

Watching the TV tuner



You can use this unit to control a TV tuner, which is sold separately.

For details concerning operation, refer to the TV tuner's operation manuals. This section provides information on TV operations with this unit which differs from that described in the TV tuner's operation manual.

① Band indicator

Shows which band the TV tuner is tuned to.

② Preset number indicator

Shows which preset has been selected.

③ Channel indicator

Shows which channel the TV tuner is tuned to.

1 Press SOURCE to select the TV.

Press **SOURCE** until you see **Television** displayed.

2 Press BAND to select a band.

Press **BAND** until the desired band is displayed, **TV1** or **TV2**.

3 To perform manual tuning, push Multi-Control left or right.

The channels move up or down step by step.

4 To perform seek tuning, push and hold Multi-Control left or right for about one second and release.

The tuner will scan the channels until a broadcast strong enough for good reception is found.

- You can cancel seek tuning by pushing **Multi-Control** left or right.
- If you push and hold **Multi-Control** left or right you can skip broadcasting channels. Seek tuning starts as soon as you release **Multi-Control**. 

Introduction of advanced TV tuner operation



① Function display

Shows the function names.

1 Press Multi-Control to display the main menu.

FUNCTION and **AUDIO** appear on the display.

2 Use Multi-Control to select FUNCTION.

Turn to change the menu option; press to select.

BSSM appears on the display.

- To return to the frequency display, press **BAND**.



Note

If you do not operate the function within about 30 seconds, the display is automatically returned to the TV picture. 

Storing broadcast stations

You can easily store up to 12 broadcast stations for later recall.

1 When you find a station that you want to store in memory press LIST to switch to the preset channel list mode.

2 Use Multi-Control to select the preset number.

Turn to change the preset number; press to select. **1-12** is displayed as the preset number is selected.

3 Press Multi-Control and hold to store the broadcast station in memory.

The selected broadcast station has been stored in memory.

- If you do not operate the list within about 8 seconds, the preset channel list mode is cancelled automatically.



Note

Up to 24 stations, 12 for each of two TV bands, can be stored in memory. 

Recalling broadcast stations

You can recall broadcast station assigned to preset numbers.

● Push Multi-Control up or down to recall broadcast stations.

Pushing **Multi-Control** up or down selects the preset number. **P01 - P12** is displayed as the preset number is selected.

The broadcast station assigned to the preset number is recalled from memory. 

Storing the strongest broadcast stations sequentially

1 Use Multi-Control and select FUNCTION to display BSSM.

2 Press Multi-Control to turn BSSM on.

BSSM begins to flash. While **BSSM** is flashing the 12 strongest broadcast stations will be stored in order from the lowest channel up. When finished, **BSSM** stops flashing.

- To cancel the storage process, press **Multi-Control**.

3 Use Multi-Control to select the desired station.

Turn to change the station; press to select.

- You can also change the station by pushing **Multi-Control** up or down.
- If you do not operate the list within about 8 seconds, the preset channel list mode is cancelled automatically.

**Note**

Storing broadcast stations with BSSM may replace broadcast stations you have saved using **P 1—P12**. 

Selecting stations from the preset channel list

The preset channel list lets you see the list of preset stations and select one of them to receive.

1 Press LIST to switch to the preset channel list mode during the frequency display.**2 Use Multi-Control to select the desired station.**

Turn to change the station; press to select.

- You can also change the station by pushing **Multi-Control** up or down.
- If you do not operate the list within about 8 seconds, the preset channel list mode is cancelled automatically. 

DVD Player

Playing a disc

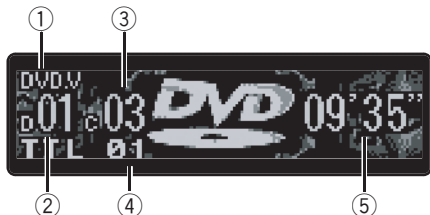

You can use this unit to control a DVD player or multi-DVD player, which is sold separately.

For details concerning operation, refer to the DVD player's or multi-DVD player's operation manual. This section provides information on DVD operations with this unit which differs from that described in the DVD player's or multi-DVD player's operation manual.

These are the basic steps necessary to play a DVD video with your DVD player. More advanced DVD video operation is explained starting on the next page.

- ① **DVD.V/CD indicator**
Shows the type of disc currently playing.
- ② **Disc number indicator**
Shows the disc currently playing.
- ③ **Chapter/track number indicator**
Shows the chapter/track currently playing.
- ④ **Title number indicator**
Shows the title currently playing.
- ⑤ **Play time indicator**
Shows the elapsed playing time of the current track.

1 Press SOURCE to select the DVD player/multi-DVD player.

Press **SOURCE** until you see **DVD** displayed.

2 To perform fast forward or reverse, push and hold Multi-Control left or right.

3 To skip back or forward to another chapter/track, push Multi-Control left or right.

Selecting a disc

- You can operate this function only when a multi-DVD player is connected to this unit.
- **Push Multi-Control up or down to select the desired disc.**

Introduction of advanced DVD player operation



① Function display

Shows the function names.

1 Press Multi-Control to display the main menu.

FUNCTION and **AUDIO** appear on the display.

2 Use Multi-Control to select **FUNCTION**.

Turn to change the menu option; press to select.

The function name appears on the display.

3 Turn Multi-Control to select the function.

Turn **Multi-Control** clockwise to switch between the functions in the following order:

During DVD video or Video CD playback

Repeat (repeat play)—**Pause** (pause)

During CD playback

Repeat (repeat play)—**Random** (random play)—**Scan** (scan play)—**Pause** (pause)—**ITS Play** (ITS play)—**ITS** (ITS input)—disc title input

▪ You can also switch between the functions in the reverse order by turning **Multi-Control** counterclockwise.

▪ To return to the playback display, press **BAND**.



Note

When using this unit with multi-DVD player, you can switch to **ITS Play**, **ITS** and disc title input. □

Repeating play

- During PBC playback of Video CDs, this function cannot be operated.

1 Use Multi-Control to select Repeat.

Repeat appears in the display.

2 Press Multi-Control to select the repeat range.

During DVD video playback

Press **Multi-Control** repeatedly until the desired repeat range appears in the display.

- **DISC** – Repeat the current disc
- **CHAP** – Repeat just the current chapter
- **TITLE** – Repeat just the current title

During Video CD or CD playback

Press **Multi-Control** to turn repeat play on or off.



Notes

- If you select other discs during repeat play, the repeat play range changes to **DISC**.
- If you perform track search or fast forward/reverse during **TRK**, the repeat play range changes to **DISC**. □

Pausing disc playback

1 Use Multi-Control to select Pause.

Pause appears in the display.

2 Press Multi-Control to turn pause on.

Pause:ON appears in the display. Play of the current track pauses.

- To turn pause off, press **Multi-Control** again. □

DVD Player

Playing tracks in a random order

- You can operate this function only during CD playback.

1 Use Multi-Control to select Random.

Random appears in the display.

2 Press Multi-Control to turn random play on.

Random :ON appears in the display. Tracks will play in a random order.

- To turn random play off, press **Multi-Control** again. 

Scanning tracks of a CD

- You can operate this function only during CD playback.

1 Use Multi-Control to select Scan.

Scan appears in the display.

2 Press Multi-Control to turn scan play on.

Scan :ON appears in the display. The first 10 seconds of each track is played.

3 When you find the desired track press Multi-Control to turn scan play off.

Scan :OFF appears in the display. The track will continue to play.

- If the display has automatically returned to the playback display, select **Scan** again by using **Multi-Control**. 

Using ITS playlist and disc title functions

- You can operate these functions only when a multi-DVD player is connected to this unit.
- This function differs slightly from ITS playback with a multi-CD player. With multi-DVD player, ITS playback applies only to the CD playing. For details, refer to *Using ITS playlists* on page 32. 

Using disc title functions

You can input CD titles and display the titles. Then you can easily search for and play a desired disc.

Entering disc titles

Disc title input lets you input CD titles up to 10 letters long into the multi-DVD player. For details concerning operation, refer to *Entering disc titles* on page 33.

- You can operate this function only when a multi-DVD player is connected to this unit. 

Introduction of audio adjustments

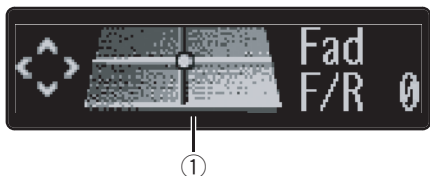

① Audio display

Shows the audio adjustments status.

1 Press Multi-Control to display the main menu.

FUNCTION and **AUDIO** appear on the display.

2 Use Multi-Control to select **AUDIO**.

Turn to change the menu option; press to select.

The audio function name appears on the display.

3 Turn Multi-Control to select the audio function.

Turn **Multi-Control** clockwise to switch between the audio functions in the following order:

Fad (balance adjustment)—**EQ** (equalizer curve adjustment)—**F 80 Q 1W** (equalizer curve fine adjustment)—**Bass** (bass and treble level adjustment)—**Bass** (bass and treble frequency adjustment)—**Loud** (loudness)—**Sub-W1** (subwoofer on/off setting)/**NonFad** (nonfading output on/off setting)—**Sub-W2** (subwoofer setting)/**NonFad** (nonfading output setting)—**HPF** (high pass filter)—**SLA** (source level adjustment)—**ASL** (automatic sound levelizer)

- If EQ-EX function has been selected and only when EQ-EX is turned on and **CUSTOM** is selected as the equalizer curve, you can switch to **Bass**.

- When the subwoofer controller setting is only **PREOUT:FULL**, you cannot switch to **Sub-W1**. (Refer to page 51.)
- You can select the **Sub-W2** only when subwoofer output is turned on in the **Sub-W1**.
- When the subwoofer controller setting is only **PREOUT:FULL**, you can switch to the nonfading output on/off setting. (Refer to page 51.)
- You can select the nonfading output setting only when nonfading output is turned on in the nonfading output on/off setting.
- When selecting the FM tuner as the source, you cannot switch to **SLA**.
- To return to the display of each source, press **BAND**.



Note

If you do not operate the audio function within about 30 seconds, the display is automatically returned to the source display. 

Compensating for equalizer curves (EQ-EX)

The EQ-EX function smoothes the effects of each equalizer curve. Furthermore, you can adjust bass and treble for each source when **CUSTOM** curve is selected.

- If SFEQ has been previously selected, press **EQ-EX** and hold until **EQ-EX** indicator appears in the display.
- **Press EQ-EX to turn EQ-EX on.** **EQ-EX ON** appears in the display. EQ-EX is now on.
 - To turn EQ-EX off, press **EQ-EX**. 

Audio Adjustments

Setting the sound focus equalizer (SFEQ)

Clarifying the sound image of vocals and instruments allows the simple staging of a natural, pleasant sound environment. Even greater listening enjoyment will be obtained if seating positions are chosen carefully. **FRT1** boosts the treble on the front output and the bass on the rear output. **FRT2** boosts the treble and the bass on the front output and the bass on the rear output. (The bass boost is the same for both front and rear.) For both **FRT1** and **FRT2**, **H** setting provides a more pronounced effect than **L** setting.

1 Press EQ-EX and hold to switch to SFEQ function.

Press **EQ-EX** and hold until **SFEQ** indicator appears in the display.

- To switch to EQ-EX function, press **EQ-EX** and hold.

2 Press EQ-EX to select the desired SFEQ setting.

Press **EQ-EX** repeatedly to switch between the following settings:

FRT1-H (front 1-high)—**FRT1-L** (front 1-low)
—**FRT2-H** (front 2-high)—**FRT2-L** (front 2-low)
—**CUSTOM** (custom)—**SFEQ OFF** (off)

3 Push Multi-Control left or right to select the desired position.

Push **Multi-Control** left or right until the desired position appears in the display.

LEFT (left)—**CENTER** (center)—**RIGHT** (right)

Notes

- If you adjust the bass or treble, **CUSTOM** memorizes an SFEQ setting in which the bass and treble are adjusted for personal preference.
- If you switch the SFEQ setting, the HPF function is automatically turned off. By turning the

HPF function on after selecting the SFEQ setting, you can combine HPF function with SFEQ function. 

Using balance adjustment

You can select a fader/balance setting that provides an ideal listening environment in all occupied seats.

1 Use Multi-Control to select Fad.

Fad appears in the display.

- If the balance setting has been previously adjusted, **Bal** will be displayed.

2 Push Multi-Control up or down to adjust front/rear speaker balance.

Each pushing **Multi-Control** up or down moves the front/rear speaker balance towards the front or the rear.

Fad F 15 – Fad R 15 is displayed as the front/rear speaker balance moves from front to rear.

- **Fad F/R 0** is the proper setting when only two speakers are used.
- When the rear output setting is

REAR SP:S/W, you cannot adjust front/rear speaker balance. Refer to *Setting the rear output and subwoofer controller* on page 51.

3 Push Multi-Control left or right to adjust left/right speaker balance.

Each pushing **Multi-Control** left or right moves the left/right speaker balance towards the left or the right.

Bal L 9 – Bal R 9 is displayed as the left/right speaker balance moves from left to right. 

Using the equalizer

The equalizer lets you adjust the equalization to match car interior acoustic characteristics as desired.

Recalling equalizer curves

There are six stored equalizer curves which you can easily recall at any time. Here is a list of the equalizer curves:

Display	Equalizer curve
SUPER BASS	Super bass
POWERFUL	Powerful
NATURAL	Natural
VOCAL	Vocal
CUSTOM	Custom
FLAT	Flat

- **CUSTOM** is an adjusted equalizer curve that you create.
- A separate **CUSTOM** curve can be created for each source. (The built-in CD player and the multi-CD player are set to the same equalizer adjustment setting automatically.) If you make adjustments, the equalizer curve settings will be memorized in **CUSTOM**.
- When **FLAT** is selected no supplement or correction is made to the sound. This is useful to check the effect of the equalizer curves by switching alternatively between **FLAT** and a set equalizer curve.

● Press EQ to select the equalizer.

Press **EQ** repeatedly to switch between the following equalizers:

SUPER BASS—POWERFUL—NATURAL—VOCAL—CUSTOM—FLAT

Adjusting equalizer curves

You can adjust the currently selected equalizer curve setting as desired. Adjusted equalizer curve settings are memorized in **CUSTOM**.

1 Use Multi-Control to select EQ.

EQ appears in the display.

2 Push Multi-Control left or right to select the equalizer band to adjust.

Each pushing **Multi-Control** left or right selects equalizer bands in the following order:

EQ LOW (low)—**EQ MID** (mid)—**EQ HIGH** (high)

3 Push Multi-Control up or down to adjust the level of the equalizer band.

Each pushing **Multi-Control** up or down increases or decreases the level of the equalization band.

+6 — -6 is displayed as the level is increased or decreased.

- You can then select another band and adjust the level.



Note

If you make adjustments, **CUSTOM** curve is updated.

Fine-adjusting equalizer curve

You can adjust the center frequency and the Q factor (curve characteristics) of each currently selected curve band (**EQ LOW**/**EQ MID**/**EQ HIGH**).

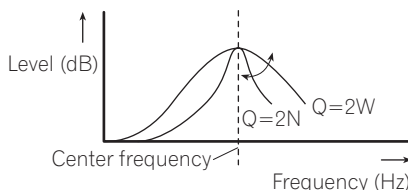

Audio Adjustments

1 Use Multi-Control to select frequency and the Q factor display.

Frequency and the Q factor (e.g., **F 80 Q 1W**) appears in the display.

2 Push Multi-Control left or right to select the desired frequency.

Each pushing **Multi-Control** left or right selects frequencies in the following order:

Low: **40—80—100—160** (Hz)

Mid: **200—500—1k—2k** (Hz)

High: **3.15k—8k—10k—12.5k** (Hz)

3 Push Multi-Control up or down to select the desired Q factor.

Each pushing **Multi-Control** up or down selects Q factor in the following order:

2N—1N—1W—2W

Note

If you make adjustments, **CUSTOM** curve is updated. 

Adjusting bass and treble

You can adjust bass and treble settings.

- If EQ-EX function has been selected and EQ-EX turned on and **CUSTOM** selected as the equalizer curve, you can adjust bass and treble settings.
- If SFEQ has been set to **FRT1**, bass adjustment affects only the rear output: front output cannot be adjusted.
- If SFEQ has been set to **FRT1** or **FRT2**, treble adjustment affects only the front output: rear output cannot be adjusted.

1 Use Multi-Control to select Bass (bass and treble level adjustment).

Bass appears in the display.

- If the treble level has been previously adjusted, **Treble** will be displayed.

2 Push Multi-Control left or right to select bass or treble.

Pushing **Multi-Control** left and **Bass** is displayed. Pushing **Multi-Control** right and **Treble** is displayed.

3 Push Multi-Control up or down to adjust the level.

Each pushing **Multi-Control** up or down increases or decreases the selected bass or treble level. **+6—-6** is displayed as the level is increased or decreased.

4 Turn Multi-Control clockwise to select Bass (bass and treble frequency adjustment).

Bass appears in the display.

- If the treble frequency has been previously adjusted, **Treble** will be displayed.

5 Push Multi-Control left or right to select the desired frequency.

Each pushing **Multi-Control** left or right selects frequencies in the following order:

Bass: **40—63—100—160** (Hz)

Treble: **2.5k—4k—6.3k—10k** (Hz) 

Adjusting loudness

Loudness compensates for deficiencies in the low- and high-sound ranges at low volume.

1 Use Multi-Control to select Loud.

Loud appears in the display.

2 Press Multi-Control to turn loudness on.

Loudness level (e.g., **Loud MID**) appears in the display.

Audio Adjustments

3 Push Multi-Control left or right to select a desired level.

Each pushing **Multi-Control** left or right selects level in the following order:
LOW (low)—**MID** (mid)—**HIGH** (high)

4 To turn loudness off, press Multi-Control again.

Loud OFF appears in the display. 

Using subwoofer output

This unit is equipped with a subwoofer output which can be turned on or off.

1 Use Multi-Control to select Sub-W1.

Sub-W1 appears in the display.

- When the subwoofer controller setting is **PREOUT:FULL**, you cannot select **Sub-W1**.

2 Press Multi-Control to turn subwoofer output on.

Sub-W1 Normal appears in the display. Subwoofer output is now on.

- To turn subwoofer output off, press **Multi-Control** again.

3 Push Multi-Control left or right to select the phase of subwoofer output.

Push **Multi-Control** left to select reverse phase and **Rev.** appears in the display. Push **Multi-Control** right to select normal phase and **Normal** appears in the display.

Adjusting subwoofer settings

When the subwoofer output is on, you can adjust the cut-off frequency and the output level of the subwoofer.

1 Use Multi-Control to select Sub-W2.

Sub-W2 appears in the display.

- When the subwoofer output is on, you can select **Sub-W2**.

2 Push Multi-Control left or right to select cut-off frequency.

Each pushing **Multi-Control** left or right selects cut-off frequencies in the following order:
50—80—125 (Hz)

Only frequencies lower than those in the selected range are outputted from the subwoofer.

3 Push Multi-Control up or down to adjust the output level of the subwoofer.

Each pushing **Multi-Control** up or down increases or decreases the level of the subwoofer. **+6—-6** is displayed as the level is increased or decreased. 

Using nonfading output

When the nonfading output setting is on, the audio signal does not pass through this unit's low pass filter (for the subwoofer), but is outputted through the RCA output.

1 Use Multi-Control to select nonfading output on/off setting.

NonFad ON appears in the display.

- When the subwoofer controller setting is only **PREOUT:FULL**, you can switch to the nonfading output on/off setting. (Refer to page 51.)

2 Press Multi-Control to turn nonfading output on.

NonFad ON appears in the display. Nonfading output is now on.

- To turn nonfading output off, press **Multi-Control** again.

Audio Adjustments

Adjusting nonfading output level

When the nonfading output is on, you can adjust the level of nonfading output.

1 Use Multi-Control to select nonfading output setting.

NonFad 0 appears in the display.

2 Push Multi-Control up or down to adjust the nonfading output level.

Each pushing **Multi-Control** up or down increases or decreases the level of the nonfading output. **+6 – -6** is displayed as the level is increased or decreased. 

Using the high pass filter

When you do not want low sounds from the subwoofer output frequency range to play from the front or rear speakers, turn on the HPF (high pass filter). Only frequencies higher than those in the selected range are outputted from the front or rear speakers.

1 Use Multi-Control to select HPF.

HPF appears in the display.

2 Press Multi-Control to turn high pass filter on.

HPF 80 Hz appears in the display. High pass filter is now on.

- To turn high pass filter off, press

Multi-Control again.

3 Push Multi-Control left or right to select cut-off frequency.

Each pushing **Multi-Control** left or right selects cut-off frequencies in the following order: **50—80—125 (Hz)**

Only frequencies higher than those in the selected range are outputted from the front or rear speakers.



Note

If you switch the SFEQ setting, the HPF function is automatically turned off. By turning the HPF function on after selecting the SFEQ setting, you can combine HPF function with SFEQ function. 

Adjusting source levels

SLA (source level adjustment) lets you adjust the volume level of each source to prevent radical changes in volume when switching between sources.

- Settings are based on the FM tuner volume level, which remains unchanged.

1 Compare the FM tuner volume level with the level of the source you wish to adjust.

2 Use Multi-Control to select SLA.

SLA appears in the display.

3 Push Multi-Control up or down to adjust the source volume.

Each pushing **Multi-Control** up or down increases or decreases the source volume.

SLA +4 – SLA -4 is displayed as the source volume is increased or decreased.



Notes

- The AM tuner volume level can also be adjusted with source level adjustments.
- The built-in CD player and the multi-CD player are set to the same source level adjustment volume automatically.
- External unit 1 and external unit 2 are set to the same source level adjustment volume automatically. 

Using automatic sound levelizer

During driving, noise in the car changes according to the driving speed and road conditions. The automatic sound levelizer (ASL) monitors such varying noise and automatically increases the volume level, if this noise becomes greater. The sensitivity (variation of volume level to noise level) of ASL can be set to one of five levels.

1 Use Multi-Control to select ASL.

ASL appears in the display.

2 Press Multi-Control to turn ASL on.

ASL MID appears in the display.

- To turn ASL off, press **Multi-Control** again.

3 Push Multi-Control left or right to select the desired ASL level.

Each pushing **Multi-Control** left or right selects ASL level in the following order:

LOW (low)—**MID-L** (mid-low)—**MID** (mid)
—**MID-H** (mid-high)—**HIGH** (high)

Initial Settings

Adjusting initial settings



Initial settings lets you perform initial setup of different settings for this unit.

① Function display

Shows the function status.

1 Press SOURCE and hold until the unit turns off.

2 Press Multi-Control and hold until the clock appears in the display.

3 Turn Multi-Control to select one of the initial settings.

Turn **Multi-Control** clockwise to switch between the functions in the following order: **Clock**—**FM Step** (FM tuning step)—**AM Step** (AM tuning step)—**Warning** (warning tone)—**AUX** (auxiliary input)—**Dimmer** (dimmer)—**Brightness** (brightness)—**REAR SP** (rear output and subwoofer controller)—**Telephone** (telephone muting/attenuation)—**Motion** (motion screen)—**EVER-SCROLL** (ever scroll)—**Auto Open** (flap auto open)

Use the following instructions to operate each particular setting.

- To cancel initial settings, press **BAND**.

Setting the clock

Use these instructions to set the clock.

1 Use Multi-Control to select clock.

Clock appears in the display.

2 Push Multi-Control left or right to select the segment of the clock display you wish to set.

Pushing **Multi-Control** left or right will select one segment of the clock display:
Hour—Minute

As you select segments of the clock display the segment selected will blink.



3 Push Multi-Control up or down to set the clock.

Pushing **Multi-Control** up will increase the selected hour or minute. Pushing **Multi-Control** down will decrease the selected hour or minute.



Notes

- You can match the clock to a time signal by pressing **Multi-Control**.
 - If the minute is **00—29**, the minutes are rounded down. (e.g., **10:18** becomes **10:00**.)
 - If the minute is **30—59**, the minutes are rounded up. (e.g., **10:36** becomes **11:00**.)
- Even when the sources are off, the clock display appears on the display.

Setting the FM tuning step

The FM tuning step employed by seek tuning can be switched between 100 kHz, the preset step, and 50 kHz.

1 Use Multi-Control to select FM Step.

FM Step appears in the display.

2 Press Multi-Control to select the FM tuning step.

Pressing **Multi-Control** repeatedly will switch the FM tuning step between 50 kHz and 100 kHz. The selected FM tuning step will appear in the display.

**Note**

If seek tuning is performed in 50 kHz steps, stations may be tuned in imprecisely. Tune in the stations with manual tuning or use seek tuning again. 

Setting the AM tuning step

The AM tuning step can be switched between 9 kHz, the preset step, and 10 kHz. When using the tuner in North, Central or South America, reset the tuning step from 9 kHz (531 – 1,602 kHz allowable) to 10 kHz (530 – 1,640 kHz allowable).

1 Use Multi-Control to select AM Step.

AM Step appears in the display.

2 Press Multi-Control to select the AM tuning step.

Pressing **Multi-Control** repeatedly will switch the AM tuning step between 9 kHz and 10 kHz. The selected AM tuning step will appear in the display. 

Switching the warning tone

If the front panel is not detached from the head unit within four seconds of turning off the ignition, a warning tone will sound. You can turn off the warning tone.

1 Use Multi-Control to select Warning.

Warning appears in the display.

2 Press Multi-Control to turn warning tone on.

Warning:ON appears in the display.

- To turn warning tone off, press **Multi-Control** again. 

Switching the auxiliary setting

It is possible to use auxiliary equipment with this unit. Activate the auxiliary setting when using auxiliary equipment connected to this unit.

1 Use Multi-Control to select AUX.

AUX appears in the display.

2 Press Multi-Control to turn AUX on.

AUX:ON appears in the display.

- To turn AUX off, press **Multi-Control** again. 

Switching the dimmer setting

To prevent the display from being too bright at night, the display is automatically dimmed when the car's headlights are turned on. You can turn the dimmer on or off.

1 Use Multi-Control to select Dimmer.

Dimmer appears in the display.

2 Press Multi-Control to turn dimmer on.

Dimmer:ON appears in the display.

- To turn dimmer off, press **Multi-Control** again. 

Initial Settings

Adjusting the brightness

You can adjust the display brightness. Initially this mode is set to 12.

1 Use Multi-Control to select Brightness.
Brightness appears in the display.

2 Push Multi-Control left or right to adjust the brightness level.

Each pushing **Multi-Control** left or right increases or decreases the brightness level. **0 – 15** is displayed as the level is increased or decreased. 

Setting the rear output and subwoofer controller

This unit's rear output (rear speaker leads output and RCA rear output) can be used for full-range speaker (**REAR SP:FULL**) or subwoofer (**REAR SP:S/W**) connection. If you switch the rear output setting to the **REAR SP:S/W**, you can connect a rear speaker lead directly to a subwoofer without using an auxiliary amp. Initially, the unit is set for rear full-range speaker connection (**REAR SP:FULL**). When rear output is connected to full range speakers (when **REAR SP:FULL** is selected), you can connect the RCA subwoofer output to a subwoofer. In this case, you can select whether to use the subwoofer controller's (low pass filter, phase) built-in **PREOUT:S/W** or the auxiliary **PREOUT:FULL**.

1 Use Multi-Control to select REAR SP.
REAR SP appears in the display.

2 Press Multi-Control to switch the rear output setting.

Pressing **Multi-Control** will switch between **REAR SP:FULL** (full-range speaker) and

REAR SP:S/W (subwoofer) and that status will be displayed.

- When no subwoofer is connected to the rear output, select **REAR SP:FULL**.

- When a subwoofer is connected to the rear output, set for subwoofer **REAR SP:S/W**.

- When the rear output setting is **REAR SP:S/W**, you cannot change the subwoofer controller.

3 Push Multi-Control left or right to switch the subwoofer output or nonfading output (full-range RCA output).

Each pushing **Multi-Control** left or right will switch between **PREOUT:S/W** and **PREOUT:FULL** and that status will be displayed.



Notes

- Even if you change this setting, there is no output unless you turn the nonfading output (refer to *Using nonfading output* on page 46) or subwoofer output (refer to *Using subwoofer output* on page 46) in the audio menu on.
- If you change the subwoofer controller, subwoofer output and nonfading output in the audio menu return to the factory settings.
- Both rear speaker leads output and RCA rear output are switched simultaneously in this setting. 

Switching the telephone muting/attenuation

Sound from this system is muted or attenuated automatically when a call is made or received using a cellular telephone connected to this unit.

- The sound is turned off, **MUTE** or **ATT** is displayed and no audio adjustment is possible.

- Operation returns to normal when the phone connection is ended.

1 Use Multi-Control to select Telephone.
Telephone appears in the display.

2 Press Multi-Control to switch the telephone muting/attenuation.

Pressing **Multi-Control** will switch between **Telephone:ATT** (attenuation) and **Telephone:MUTE** (muting) and that status will be displayed. 

Switching the motion screen

You can turn the moving source icon display on or off. When off is selected, the moving source icon disappears after opening screen is displayed.

1 Use Multi-Control to select Motion.
Motion appears in the display.

2 Press Multi-Control to turn the motion screen on.

Motion:ON appears in the display.

- To turn the motion screen off, press **Multi-Control** again. 

Switching the Ever Scroll

When Ever Scroll is set to ON, CD text information scrolls continuously in the display. Set to OFF if you prefer the information to scroll just once.

1 Use Multi-Control to select EVER-SCROLL.
EVER-SCROLL appears in the display.

2 Press Multi-Control to turn the Ever Scroll on.

EVER-SCROLL:ON appears in the display.

- To turn the Ever Scroll off, press **Multi-Control** again. 

Switching the flap auto open

For theft protection, the front panel opens automatically and easily detaches. Flap auto open is on as a default.

1 Use Multi-Control to select Auto Open.
Auto Open appears in the display.

2 Press Multi-Control to turn the flap auto open on.

Auto Open:ON appears in the display.

- To turn the flap auto open off, press **Multi-Control** again. 

Other Functions

Turning the clock display on or off

You can turn the clock display on or off.

● Press **CLOCK** to turn the clock display on or off.

Each press of **CLOCK** turns the clock display on or off.

- The clock display disappears temporarily when you perform other operations, but the clock display appears again after 6 seconds.



Note

Even when the sources are off, the clock display appears on the display. Pressing **CLOCK** turns the clock display on or off. ▣

Using the AUX source

An IP-BUS-RCA Interconnector such as the CD-RB20/CD-RB10 (sold separately) lets you connect this unit to auxiliary equipment featuring RCA output. For more details, refer to the IP-BUS-RCA Interconnector owner's manual.

Selecting AUX as the source

● Press **SOURCE** to select **AUX** as the source.

Press **SOURCE** until **AUX** appears in the display.

- If the auxiliary setting is not turned on, **AUX** cannot be selected. For more details, see *Switching the auxiliary setting* on page 50.

Setting the AUX title

The title displayed for the **AUX** source can be changed.

1 After you have selected **AUX** as the source, use **Multi-Control** and select **FUNCTION** to display **TITLE**.

2 Press **DISPLAY** to select the desired character type.

Press **DISPLAY** repeatedly to switch between the following character types:
 Alphabet (upper case)—Alphabet (lower case)
 —European letters, such as those with accents (e.g. **á, à, ä, ç**)—Numbers and symbols

3 Push **Multi-Control** up or down to select a letter of the alphabet.

Each pushing **Multi-Control** up will display a letter of the alphabet in **A B C ... X Y Z**, numbers and symbols in **1 2 3 ... @ # <** order. Each pushing **Multi-Control** down will display a letter in the reverse order, such as **Z Y X ... C B A**.



4 Push **Multi-Control** right to move the cursor to the next character position.

When the letter you want is displayed, push **Multi-Control** right to move the cursor to the next position and then select the next letter. Push **Multi-Control** left to move backwards in the display.

5 Move the cursor to the last position by pushing **Multi-Control** right after entering the title.

When you push **Multi-Control** right one more time, the entered title is stored in memory.

6 Press **BAND** to return to the playback display. ▣

Using different entertainment displays

You can enjoy entertainment displays while listening to each sound source.

● Press ENTERTAINMENT.

Each time you press **ENTERTAINMENT** the display changes in the following order:
 Source icon display—Back ground visual 1—
 Back ground visual 2—Back ground visual 3—
 Back ground visual 4—Back ground picture 1—
 Back ground picture 2—Movie screen 1—
 Movie screen 2—Level meter 1—Level meter 2—
 Entertainment clock 

Rewriting the entertainment displays

You can rewrite the entertainment display. Please create or download the data using your Computer, and record it on CD-R. For details, please visit <http://www.pioneer.co.jp/car/pclink3b/>.

Important

Once the rewriting process has started, do not open the front panel or turn the ignition off, until it is completed.

1 Press SOURCE and hold until the unit turns off.

2 Press and hold ENTERTAINMENT and DISPLAY until the unit goes into download mode.

Front panel is opened automatically and then **DOWNLOAD READY** and **INSERT DISC** is displayed.

- If a disc is loaded in the unit, it is ejected automatically.

3 Insert the disc containing the rewritten data into the CD loading slot.

DOWNLOAD READY appears in the display, and then data rewriting will start automatically. **NOW LOADING** is displayed during rewriting.

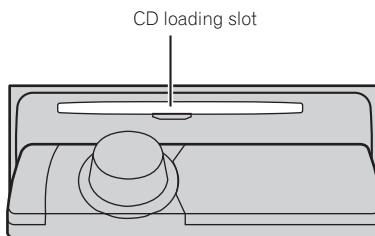

4 After FINISHED is displayed, press EJECT to open the front panel and eject the disc.

Download mode is exited and unit turns off.



Notes

- Do not insert anything other than a CD into the CD loading slot.
- It can take several minutes to complete this operation.
- During download mode, buttons other than **EJECT** are inactive.
- To cancel download mode, press **EJECT**.
- If the rewriting process does not operate properly, an error message such as **CD ERROR** may be displayed. Refer to *Understanding error message on rewriting the entertainment displays* on page 56. 

Using the PGM button

You can operate the preprogrammed functions for each source by using **PGM** on the remote control.

Other Functions

- **Press PGM to turn pause on when selecting built-in CD player or multi-CD player as the source.**

- To turn pause off, press **PGM** again.

- **Press PGM and hold to turn BSM on when selecting tuner as the source.**

Press **PGM** and hold until the BSM turns on.

- To cancel the storage process, press **PGM** again.

- **Press PGM and hold to turn BSSM on when selecting television as the source.**

Press **PGM** and hold until the BSSM turns on.

- To cancel the storage process, press **PGM** again. 

Additional Information

Understanding built-in CD player error messages

When problems occur during CD play an error message may appear on the display. If an error message appears, refer to the table below to see what the problem is and the suggested method of correcting the problem. If the error cannot be corrected, contact your dealer or your nearest Pioneer Service Center.

- If no sound is emitted from the speakers, and the error message **POWER IC DAMAGE** is displayed, the battery may be dead. Have the unit serviced as soon as possible.
- When the battery is low, the error message **Error DC/DC conv** may be displayed when you try to adjust the volume or equalizers. Turn the source on and off and turn the ACC on and off. If the message is still displayed, have the unit serviced as soon as possible.

Message	Cause	Action
ERROR-11, 12, 17, 30	Dirty disc	Clean disc.
ERROR-11, 12, 17, 30	Scratched disc	Replace disc.
ERROR-10, 11, 12, 17, 30, A0	Electrical or mechanical	Turn the ignition ON and OFF, or switch to a different source, then back to the CD player.
ERROR-22, 23	The CD format cannot be played back	Replace disc.
ERROR-44	All tracks are skip tracks	Replace disc.
Error ACC line, POWER IC DAMAGE	Leads and connectors are incorrectly connected.	Confirm once more that all connections are correct.



Understanding error message on rewriting the entertainment displays

When problems occur during rewriting the entertainment displays an error message may appear on the display. If an error message appears refer to the table below to see what the problem is and the suggested method of correcting the problem. If the error cannot be corrected, contact your dealer or your nearest Pioneer Service Center.

Message	Cause	Action
CD ERROR	CD player error	Press EJECT and check the disc.
CD ERROR A0	Electrical error	Turn the ignition ON and OFF.
DISC ERROR	The disc does not contain the necessary data	Press EJECT and replace the disc.
DOWNLOAD ERROR, TRANSMIT ERROR	Writing error	Press EJECT and retry the rewriting.



CD player and care

- Use only CDs that have either of the two Compact Disc Digital Audio marks as shown below.



Additional Information

- Use only normal, round CDs. If you insert irregular, non-round, shaped CDs they may jam in the CD player or not play properly.



- Check all CDs for cracks, scratches or warping before playing. CDs that have cracks, scratches or are warped may not play properly. Do not use such discs.
- Avoid touching the recorded (non-printed) surface when handling the disc.
- Store discs in their cases when not in use.
- Keep discs out of direct sunlight and do not expose the discs to high temperatures.
- Do not attach labels, write on or apply chemicals to the surface of the discs.
- To clean a CD, wipe the disc with a soft cloth outward from the center.



- If the heater is used in cold weather, moisture may form on components inside the CD player. Condensation may cause the CD player to malfunction. If you think that condensation is a problem turn off the CD player for an hour or so to allow it to dry out and wipe any damp discs with a soft cloth to remove the moisture.
- Road shocks may interrupt CD playback.

CD-R/CD-RW discs

- When CD-R/CD-RW discs are used, playback is possible only for discs which have been finalized.

- It may not be possible to play back CD-R/CD-RW discs recorded on a music CD recorder or a personal computer because of disc characteristics, scratches or dirt on the disc, or dirt, condensation, etc., on the lens of this unit.
- Playback of discs recorded on a personal computer may not be possible, depending on the application settings and the environment. Please record with the correct format. (For details, contact the manufacturer of the application.)
- Playback of CD-R/CD-RW discs may become impossible in case of direct exposure to sunlight, high temperatures, or the storage conditions in the vehicle.
- Titles and other text information recorded on a CD-R/CD-RW disc may not be displayed by this unit (in the case of audio data (CD-DA)).
- This unit conforms to the track skip function of the CD-R/CD-RW disc. The tracks containing the track skip information are skipped automatically (in case of audio data (CD-DA)).
- If you insert a CD-RW disc into this unit, time to playback will be longer than when you insert a conventional CD or CD-R disc.
- Read the precautions with CD-R/CD-RW discs before using them.

MP3, WMA and WAV files

- MP3 is short for MPEG Audio Layer 3 and refers to an audio compression technology standard.
- WMA is short for Windows Media™ Audio and refers to an audio compression technology that is developed by Microsoft Corporation. WMA data can be encoded by using Windows Media Player version 7 or later.
- WAV is short for waveform. It is a standard audio file format for Windows®.

Additional Information

- With some applications used to encode WMA files, this unit may not operate correctly.
- With some applications used to encode WMA files, album names and other text information may not be correctly displayed.
- This unit allows playback of MP3/WMA/WAV files on CD-ROM, CD-R and CD-RW discs. Disc recordings compatible with level 1 and level 2 of ISO9660 and with the Romeo and Joliet file system can be played back.
- It is possible to play back multi-session compatible recorded discs.
- MP3/WMA/WAV files are not compatible with packet write data transfer.
- The maximum number of characters which can be displayed for a file name, including the extension (.mp3, .wma or .wav), is 64, from the first character.
- The maximum number of characters which can be displayed for a folder name is 64.
- In case of files recorded according to the Romeo file system, only the first 64 characters can be displayed.
- When playing discs with MP3/WMA/WAV files and audio data (CD-DA) such as CD-EXTRA and MIXED-MODE CDs, both types can be played only by switching mode between MP3/WMA/WAV and CD-DA.
- The folder selection sequence for playback and other operations becomes the writing sequence used by the writing software. For this reason, the expected sequence at the time of playback may not coincide with the actual playback sequence. However, there also is some writing software which permits setting of the playback order.



Important

- When naming an MP3/WMA/WAV file, add the corresponding filename extension (.mp3, .wma or .wav).

- This unit plays back files with the filename extension (.mp3, .wma or .wav) as an MP3/WMA/WAV file. To prevent noise and malfunctions, do not use these extensions for files other than MP3/WMA/WAV files.

MP3 additional information

- Files are compatible with the ID3 Tag Ver. 1.0, 1.1, 2.2, 2.3 and 2.4 formats for display of album (disc title), track (track title), artist (track artist) and comments. Ver. 2.x of ID3 Tag is given priority when both Ver. 1.x and Ver. 2.x exist.
- The emphasis function is valid only when MP3 files of 32, 44.1 and 48 kHz frequencies are played back. (16, 22.05, 24, 32, 44.1, 48 kHz sampling frequencies can be played back.)
- There is no m3u playlist compatibility.
- There is no compatibility with the MP3i (MP3 interactive) or mp3 PRO formats.
- The sound quality of MP3 files generally becomes better with an increased bit rate. This unit can play recordings with bit rates from 8 kbps to 320 kbps, but in order to be able to enjoy sound of a certain quality, we recommend using only discs recorded with a bit rate of at least 128 kbps.

WMA additional information

- This unit plays back WMA files encoded by Windows Media Player version 7, 7.1, 8 and 9.
- You can only play back WMA files in the frequencies 32, 44.1 and 48 kHz.
- The sound quality of WMA files generally becomes better with an increased bit rate. This unit can play recordings with bit rates from 48 kbps to 320 kbps (CBR) or from 48 kbps to 384 kbps (VBR), but in order to be able to enjoy sound of a certain quality, we

Additional Information

recommend using discs recorded with a higher bit rate.

- This unit doesn't support the following formats.
 - Windows Media Audio 9 Professional (5.1ch)
 - Windows Media Audio 9 Lossless
 - Windows Media Audio 9 Voice

WAV additional information

- This unit plays back WAV files encoded in Linear PCM (LPCM) format or MS ADPCM format.
- You can only play back WAV files in the frequencies 16, 22.05, 24, 32, 44.1 and 48 kHz (LPCM), or 22.05 and 44.1 kHz (MS ADPCM). The sampling frequency shown in the display may be rounded.
- The sound quality of WAV files generally becomes better with a larger number of quantization bits. This unit can play recordings with 8 and 16 (LPCM) or 4 (MS ADPCM) quantization bits, but in order to be able to enjoy sound of a certain quality, we recommend using discs recorded with the larger number of quantization bits.

About folders and MP3/WMA/WAV files

- An outline of a CD-ROM with MP3/WMA/WAV files on it is shown below. Subfolders are shown as folders in the folder currently selected.

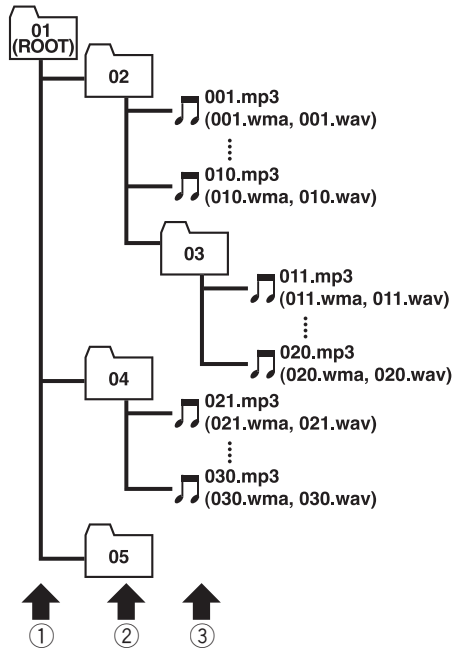

- ① **First level**
- ② **Second level**
- ③ **Third level**

Notes

- This unit assigns folder numbers. The user can not assign folder numbers.
- It is not possible to check folders that do not include MP3/WMA/WAV files. (These folders will be skipped without displaying the folder number.)
- MP3/WMA/WAV files in up to 8 tiers of folders can be played back. However, there is a delay in the start of playback on discs with numerous tiers. For this reason we recommend creating discs with no more than 2 tiers.
- It is possible to play back up to 99 folders on one disc.

Additional Information

Terms

Bit rate

This expresses data volume per second, or bps units (bits per second). The higher the rate, the more information is available to reproduce the sound. Using the same encoding method (such as MP3), the higher the rate, the better the sound.

ID3 tag

This is a method of embedding track-related information in an MP3 file. This embedded information can include the track title, the artist's name, the album title, the music genre, the year of production, comments and other data. The contents can be freely edited using software with ID3 Tag editing functions. Although the tags are restricted as to the number of characters, the information can be viewed when the track is played back.

ISO9660 format

This is the international standard for the format logic of CD-ROM folders and files. For the ISO9660 format, there are regulations for the following two levels.

Level 1:

The file name is in 8.3 format (the name consists of up to 8 characters, half-byte English capital letters and half-byte numerals and the “_” sign, with a file-extension of three characters.)

Level 2:

The file name can have up to 31 characters (including the separation mark “.” and a file extension). Each folder contains less than 8 hierarchies.

Extended formats

Joliet:

File names can have up to 64 characters.

Romeo:

File names can have up to 128 characters.

Linear PCM (LPCM)/Pulse code modulation

This stands for linear pulse code modulation, which is the signal recording system used for music CDs and DVDs.

m3u

Playlists created using the “WINAMP” software have a playlist file extension (.m3u).

MP3

MP3 is short for MPEG Audio Layer 3. It is an audio compression standard set by a working group (MPEG) of the ISO (International Standards Organization). MP3 is able to compress audio data to about 1/10th the level of a conventional disc.

MS ADPCM

This stands for Microsoft adaptive differential pulse code modulation, which is the signal recording system used for the multimedia software of Microsoft Corporation.

Multi-session

Multi-session is a recording method that allows additional data to be recorded later. When recording data on a CD-ROM, CD-R or CD-RW, etc., all data from beginning to end is treated as a single unit or session. Multi-session is a method of recording more than 2 sessions on one disc.

Number of quantization bits

The number of quantization bits is one factor in the overall sound quality; the higher the “bit-depth”, the better the sound quality. However, increasing the bit-depth also increases the amount of data and therefore storage space required.

Packet write

This is a general term for a method of writing on CD-R, etc., at the time required for a file,

Additional Information

just as is done with files on floppy or hard discs.

VBR

VBR is short for variable bit rate. Generally speaking CBR (constant bit rate) is more widely used. But by flexibly adjusting the bit rate according to the needs of audio compression, it is possible to achieve compression-priority sound quality.

WAV

WAV is short for waveform. It is a standard audio file format for Windows®.

WMA

WMA is short for Windows Media™ Audio and refers to an audio compression technology that is developed by Microsoft Corporation. WMA data can be encoded by using Windows Media Player version 7 or later. Microsoft, Windows Media, and the Windows logo are trademarks, or registered trademarks of Microsoft Corporation in the United States and/or other countries. ▣

Additional Information

Specifications

General

Rated power source	14.4 V DC (allowable voltage range: 12.0 – 14.4 V DC)
Grounding system	Negative type
Max. current consumption	20.0 A
Dimensions (W × H × D):	
DIN	
Chassis	178 × 50 × 159 mm
Nose	188 × 58 × 19 mm
D	
Chassis	178 × 50 × 164 mm
Nose	170 × 45 × 14 mm
Weight	1.6 kg

Audio

(When in 60W mode)

Continuous power output is 27 W per channel minimum into 4 ohms, both channels driven 50 to 15,000 Hz with no more than 5% THD.

(When in 40W mode)

Continuous power output is 20 W per channel minimum into 4 ohms, both channels driven 50 to 15,000 Hz with no more than 5% THD.

Maximum power output	60W × 4 (When in 60W mode)
Maximum power output	40W × 4 (When in 40W mode)

Load impedance	4 Ω (4 – 8 Ω allowable)
Preout max output level/output impedance	6.5 V/100Ω

Equalizer (3-Band Parametric Equalizer):

Low	
Frequency	40/80/100/160 Hz
Q Factor	0.35/0.59/0.95/1.15 (+6 dB when boosted)
Gain	±12dB
Mid	
Frequency	200/500/1k/2k Hz
Q Factor	0.35/0.59/0.95/1.15 (+6 dB when boosted)
Gain	±12dB
High	
Frequency	3.15k/8k/10k/12.5k Hz
Q Factor	0.35/0.59/0.95/1.15 (+6 dB when boosted)
Gain	±12dB

Loudness contour

Low	+3.5 dB (100 Hz), +3 dB (10 kHz)
Mid	+10 dB (100 Hz), +6.5 dB (10 kHz)
High	+11 dB (100 Hz), +11 dB (10 kHz) (volume: –30 dB)

Tone controls:

Bass	
Frequency	40/63/100/160 Hz
Gain	±12dB
Treble	
Frequency	2.5k/4k/6.3k/10k Hz
Gain	±12dB

HPF:

Frequency	50/80/125 Hz
Slope	–12 dB/oct

Subwoofer:

Frequency	50/80/125 Hz
Slope	–18 dB/oct
Gain	±12dB
Phase	Normal/Reverse

CD player

System	Compact disc audio system
Usable discs	Compact disc
Signal format:	
Sampling frequency	44.1 kHz
Number of quantization bits	16; linear
Frequency characteristics ...	5 – 20,000 Hz (±1 dB)
Signal-to-noise ratio	94 dB (1 kHz) (IEC-A net- work)
Dynamic range	92 dB (1 kHz)
Number of channels	2 (stereo)
MP3 decoding format	MPEG-1 & 2 Audio Layer 3
WMA decoding format	Ver. 7, 7.1, 8, 9
WAV signal format	Linear PCM & MS ADPCM

FM tuner

Frequency range	87.5 – 108.0 MHz
Usable sensitivity	8 dBf (0.7 μV/75 Ω mono, S/N: 30 dB)
50 dB quieting sensitivity	10 dBf (0.9 μV/75 Ω mono)
Signal-to-noise ratio	75 dB (IEC-A network)
Distortion	0.3 % (at 65 dBf, 1 kHz, stereo)
.....	0.1 % (at 65 dBf, 1 kHz, mono)
Frequency response	30 – 15,000 Hz (±3 dB)

PIONEER CORPORATION

4-1, MEGURO 1-CHOME, MEGURO-KU, TOKYO 153-8654, JAPAN

PIONEER ELECTRONICS (USA) INC.

P.O. Box 1540, Long Beach, California 90801-1540, U.S.A.

TEL: (800) 421-1404

PIONEER EUROPE NV

Haven 1087, Keetberglaan 1, B-9120 Melsele, Belgium

TEL: (0) 3/570.05.11

PIONEER ELECTRONICS ASIACENTRE PTE. LTD.

253 Alexandra Road, #04-01, Singapore 159936

TEL: 65-6472-1111

PIONEER ELECTRONICS AUSTRALIA PTY. LTD.

178-184 Boundary Road, Braeside, Victoria 3195, Australia

TEL: (03) 9586-6300

PIONEER ELECTRONICS OF CANADA, INC.

300 Allstate Parkway, Markham, Ontario L3R OP2, Canada

TEL: 1-877-283-5901

PIONEER ELECTRONICS DE MEXICO, S.A. de C.V.

Bldv.Manuel Avila Camacho 138 10 piso

Col.Lomas de Chapultepec, Mexico, D.F. 11000

TEL: 55-9178-4270

先鋒股份有限公司

總公司：台北市中山北路二段44號13樓

電話：(02) 2521-3588

先鋒電子（香港）有限公司

香港九龍尖沙咀海港城世界商業中心

9樓901-6室

電話：(0852) 2848-6488

Published by Pioneer Corporation.

Copyright © 2004 by Pioneer Corporation.

All rights reserved.

Printed in Thailand

Free Manuals Download Website

<http://myh66.com>

<http://usermanuals.us>

<http://www.somanuals.com>

<http://www.4manuals.cc>

<http://www.manual-lib.com>

<http://www.404manual.com>

<http://www.luxmanual.com>

<http://aubethermostatmanual.com>

Golf course search by state

<http://golfingnear.com>

Email search by domain

<http://emailbydomain.com>

Auto manuals search

<http://auto.somanuals.com>

TV manuals search

<http://tv.somanuals.com>