

***Pioneer***

REMIX STATION

# RMX-500

<http://pioneerdj.com/support/>

The Pioneer DJ support site shown above offers FAQs, information on software and various other types of information and services to allow you to use your product in greater comfort.

## Operating Instructions (Basic Edition)

# IMPORTANT



The lightning flash with arrowhead symbol, within an equilateral triangle, is intended to alert the user to the presence of uninsulated "dangerous voltage" within the product's enclosure that may be of sufficient magnitude to constitute a risk of electric shock to persons.

## CAUTION

**RISK OF ELECTRIC SHOCK  
DO NOT OPEN**

**CAUTION:**  
TO PREVENT THE RISK OF ELECTRIC SHOCK, DO NOT REMOVE COVER (OR BACK). NO USER-SERVICEABLE PARTS INSIDE. REFER SERVICING TO QUALIFIED SERVICE PERSONNEL.



The exclamation point within an equilateral triangle is intended to alert the user to the presence of important operating and maintenance (servicing) instructions in the literature accompanying the appliance.

D3-4-2-1-1b\_A1\_En

# IMPORTANT SAFETY INSTRUCTIONS

- 1) Read these instructions.
- 2) Keep these instructions.
- 3) Heed all warnings.
- 4) Follow all instructions.
- 5) Do not use this apparatus near water.
- 6) Clean only with dry cloth.
- 7) Do not block any ventilation openings. Install in accordance with the manufacturer's instructions.
- 8) Do not install near any heat sources such as radiators, heat registers, stoves, or other apparatus (including amplifiers) that produce heat.
- 9) Do not defeat the safety purpose of the polarized or grounding-type plug. A polarized plug has two blades with one wider than the other. A grounding type plug has two blades and a third grounding prong. The wide blade or the third prong are provided for your safety. If the provided plug does not fit into your outlet, consult an electrician for replacement of the obsolete outlet.
- 10) Protect the power cord from being walked on or pinched particularly at plugs, convenience receptacles, and the point where they exit from the apparatus.
- 11) Only use attachments/accessories specified by the manufacturer.
- 12) Use only with the cart, stand, tripod, bracket, or table specified by the manufacturer, or sold with the apparatus. When a cart is used, use caution when moving the cart/apparatus combination to avoid injury from tip-over.
- 13) Unplug this apparatus during lightning storms or when unused for long periods of time.
- 14) Refer all servicing to qualified service personnel. Servicing is required when the apparatus has been damaged in any way, such as power-supply cord or plug is damaged, liquid has been spilled or objects have fallen into the apparatus, the apparatus has been exposed to rain or moisture, does not operate normally, or has been dropped.



D3-7-13-69\_En

## NOTE:

This equipment has been tested and found to comply with the limits for a Class B digital device, pursuant to Part 15 of the FCC Rules. These limits are designed to provide reasonable protection against harmful interference in a residential installation. This equipment generates, uses, and can radiate radio frequency energy and, if not installed and used in accordance with the instructions, may cause harmful interference to radio communications. However, there is no guarantee that interference will not occur in a particular installation. If this equipment does cause harmful interference to radio or television reception, which can be determined by turning the equipment off and on, the user is encouraged to try to correct the interference by one or more of the following measures:

- Reorient or relocate the receiving antenna.
- Increase the separation between the equipment and receiver.
- Connect the equipment into an outlet on a circuit different from that to which the receiver is connected.
- Consult the dealer or an experienced radio/TV technician for help.

D8-10-1-2\_A1\_En

## FEDERAL COMMUNICATIONS COMMISSION DECLARATION OF CONFORMITY

This device complies with part 15 of the FCC Rules. Operation is subject to the following two conditions: (1) This device may not cause harmful interference, and (2) this device must accept any interference received, including interference that may cause undesired operation.

Product Name: REMIX STATION

Model Number: RMX-500

Responsible Party Name: PIONEER ELECTRONICS (USA) INC.  
SERVICE SUPPORT DIVISION

Address: 1925 E. DOMINGUEZ ST. LONG BEACH, CA 90810-1003, U.S.A.

Phone: 1-800-421-1404

URL: <http://www.pioneerelectronics.com>

D8-10-4\*\_C1\_En

## WARNING

This equipment is not waterproof. To prevent a fire or shock hazard, do not place any container filled with liquid near this equipment (such as a vase or flower pot) or expose it to dripping, splashing, rain or moisture.

D3-4-2-1-3\_A1\_En

## WARNING

To prevent a fire hazard, do not place any naked flame sources (such as a lighted candle) on the equipment.

D3-4-2-1-7a\_A1\_En

## Operating Environment

Operating environment temperature and humidity:  
+5 °C to +35 °C (+41 °F to +95 °F); less than 85 %RH  
(cooling vents not blocked)

Do not install this unit in a poorly ventilated area, or in locations exposed to high humidity or direct sunlight (or strong artificial light).

D3-4-2-1-7c\*\_A2\_En

## CAUTION

The **ON, STANDBY** switch on this unit will not completely shut off all power from the AC outlet. Since the power cord serves as the main disconnect device for the unit, you will need to unplug it from the AC outlet to shut down all power. Therefore, make sure the unit has been installed so that the power cord can be easily unplugged from the AC outlet in case of an accident. To avoid fire hazard, the power cord should also be unplugged from the AC outlet when left unused for a long period of time (for example, when on vacation).

D3-4-2-2-2a\*\_A1\_En

When using this product, confirm the safety information shown on the bottom of the unit.

D3-4-2-2-4\_B1\_En

## Information to User

Alterations or modifications carried out without appropriate authorization may invalidate the user's right to operate the equipment.

D8-10-2\_A1\_En

## CAUTION

This product satisfies FCC regulations when shielded cables (with Ferrite-cores attached) and connectors are used to connect the unit to other equipment. To prevent electromagnetic interference with electric appliances such as radios and televisions, use shielded cables (with Ferrite-cores attached) and connectors for connections.

D8-10-3b\_A1\_En

## IMPORTANT NOTICE

THE MODEL NUMBER AND SERIAL NUMBER OF THIS EQUIPMENT ARE ON THE REAR OR BOTTOM. RECORD THESE NUMBERS ON PAGE 19 FOR FUTURE REFERENCE.

D36-AP9-3\*\_A1\_En

**WARNING:** Handling the cord on this product or cords associated with accessories sold with the product may expose you to chemicals listed on proposition 65 known to the State of California and other governmental entities to cause cancer and birth defect or other reproductive harm.

***Wash hands after handling.***

D36-P5\_B1\_En

This product is for general household purposes. Any failure due to use for other than household purposes (such as long-term use for business purposes in a restaurant or use in a car or ship) and which requires repair will be charged for even during the warranty period.

K041\_A1\_En

## **The Safety of Your Ears is in Your Hands**

Get the most out of your equipment by playing it at a safe level – a level that lets the sound come through clearly without annoying blaring or distortion and, most importantly, without affecting your sensitive hearing. Sound can be deceiving. Over time, your hearing “comfort level” adapts to higher volumes of sound, so what sounds “normal” can actually be loud and harmful to your hearing. Guard against this by setting your equipment at a safe level BEFORE your hearing adapts.

### **ESTABLISH A SAFE LEVEL:**

- Set your volume control at a low setting.
- Slowly increase the sound until you can hear it comfortably and clearly, without distortion.
- Once you have established a comfortable sound level, set the dial and leave it there.

### **BE SURE TO OBSERVE THE FOLLOWING GUIDELINES:**

- Do not turn up the volume so high that you can't hear what's around you.
- Use caution or temporarily discontinue use in potentially hazardous situations.
- Do not use headphones while operating a motorized vehicle; the use of headphones may create a traffic hazard and is illegal in many areas.

S001a\_A1\_En

### **POWER-CORD CAUTION**

Handle the power cord by the plug. Do not pull out the plug by tugging the cord and never touch the power cord when your hands are wet as this could cause a short circuit or electric shock. Do not place the unit, a piece of furniture, etc., on the power cord, or pinch the cord. Never make a knot in the cord or tie it with other cords. The power cords should be routed such that they are not likely to be stepped on. A damaged power cord can cause a fire or give you an electrical shock. Check the power cord once in a while. When you find it damaged, ask your nearest PIONEER authorized service center or your dealer for a replacement.

S002\*\_A1\_En

---

---

# Contents

## How to read this manual

- Thank you for buying this Pioneer product.  
Be sure to read this booklet and the "Operating Instructions" provided on the Pioneer DJ support site. Both include important information that should be fully understood before using this product. After you have finished reading the instructions, put them away in a safe place for future reference.
- In this manual, names of channels and buttons indicated on the product, names of menus in the software, etc., are indicated within square brackets ([ ]). (e.g. [MASTER] channel, [ON/OFF], [File] menu)

## 01 Before start

Features .....	6
What's in the box .....	6
Acquiring this unit's Operating Instructions .....	6
Connecting the input/output terminals.....	7
Starting up and preparing this unit.....	9

## 02 Operation

Setting the BPM.....	10
RHYTHM FX section .....	11
SCENE FX section.....	12
RELEASE FX section.....	13
Switching the audio signal path.....	13
Customizing the effect parameters.....	13

## 03 Additional information

Troubleshooting .....	14
About trademarks and registered trademarks .....	14
Cautions on copyrights .....	14
General Disclaimer.....	14
Specifications.....	15

---

---

# Before start

---

## Features

This unit is a remix station for DJs consisting of three effect sections. The **[PRESSURE]** controllers newly adopted for the RHYTHM FX and SCENE FX sections allow effects to be adjusted not only by turning the controller as before, but also according to the strength with which the controller is pressed in.

Furthermore, the internal effect type can be switched to achieve highly individualistic DJ remixing performances with more intuitive operation than ever before.

The "RMX-500 Plug-in" Plug-in software allows this unit to be operated on music creation applications. In addition, by connecting this unit to a computer, this unit can be used as a controller to create music with the same feeling as when conducting a DJ performance.

---

## RHYTHM FX

New rhythms can be created by cutting up the currently playing track or adding internal sound sources.

Effects and internal drum sound sources can be used for loop playback with a variety of rhythms.

---

## SCENE FX

The currently playing track can be emphasized or breaks can be created at any position to produce new developments for tracks.

Effects and echoes can be combined to achieve unique renderings.

---

## RELEASE FX

Effect sounds can be blended smoothly with the currently playing track.

---

## QUANTIZE

The beat positions of tracks are analyzed in real time and the effects and the timing for producing the sound are adjusted automatically. The sound is played in tempo with the track, even when buttons are operated roughly.

---

## RMX-500 Plug-in

A VST/AU/RTAS Plug-in letting you launch the functions of this unit on a computer is provided. With it, the RMX-500 can be used as a controller.

---

## SOUND CARD

This unit is equipped with "sound card/USB audio interface".

---

## What's in the box

- USB cable
- AC adapter
- Power cord
- Warranty card (page 19 of this manual)
- Operating Instructions (Basic Edition) (this document)

---

## Acquiring this unit's Operating Instructions

The various instructions are sometimes provided as files in PDF format. Adobe® Reader® must be installed in order to view files in PDF format.

**1 Launch a web browser on the computer and access the Pioneer DJ support site below.**

<http://pioneerdj.com/support/>

**2 On the Pioneer DJ support site, click "Manuals" under "RMX-500".**

**3 Click on the required language on the download page.**

Downloading of the operating instructions begins.

## Connecting the input/output terminals

Be sure to turn off the power and unplug the power cord from the power outlet whenever making or changing connections.

Connect the power cord after all the connections between devices have been completed.

Be sure to use the power cord, AC adapter and USB cable included with this product.

Refer to the operating instructions for the component to be connected.

Power to this unit is supplied by the AC adapter or by USB bus power.

This unit can be used by connecting it to a computer using a USB cable, even without connecting the AC adapter.

- Connect this unit and the computer directly using the included USB cable.
- Do not connect via a USB hub.
- Connect the computer to which this unit is to be connected to an AC power supply.
- The brightness of the buttons that light is dimmer when using on USB bus power.
- When running on USB bus power, the unit may not operate in the following cases:
  - When the power supply capacity of the computer's USB port is insufficient.
  - When other USB devices are connected to the computer.
  - When headphones with an impedance of less than  $32\ \Omega$  are connected.
  - When a monaural jack is connected to the [PHONES] terminal.
- This unit may restart if the AC adapter or USB cable is disconnected during operation.

## Example of connections

### ❖ To connect to the DJ mixer's [MASTER OUT] terminals

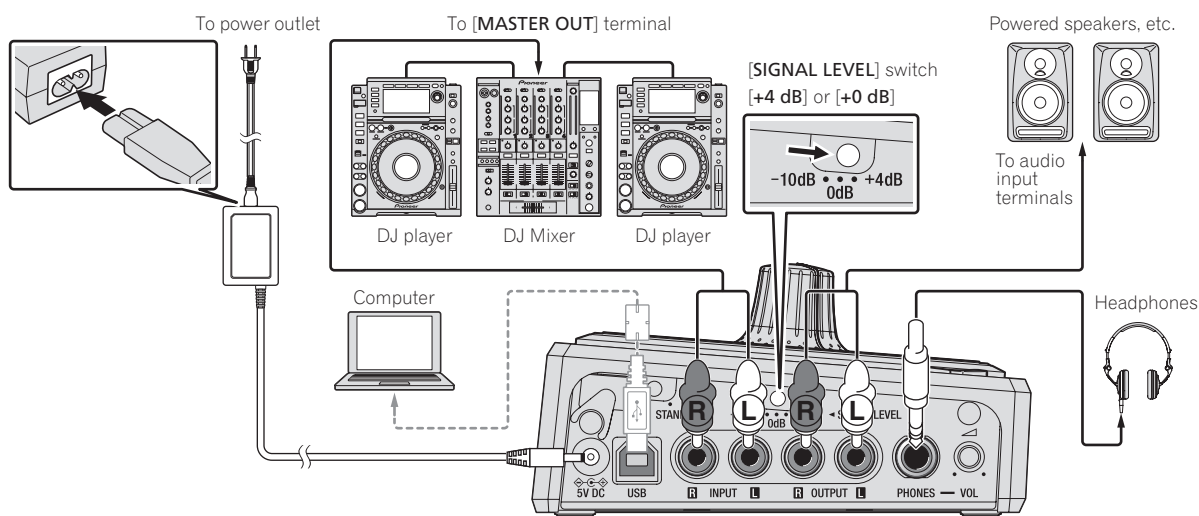

### ❖ To connect to the DJ controller's [MASTER OUT] terminals

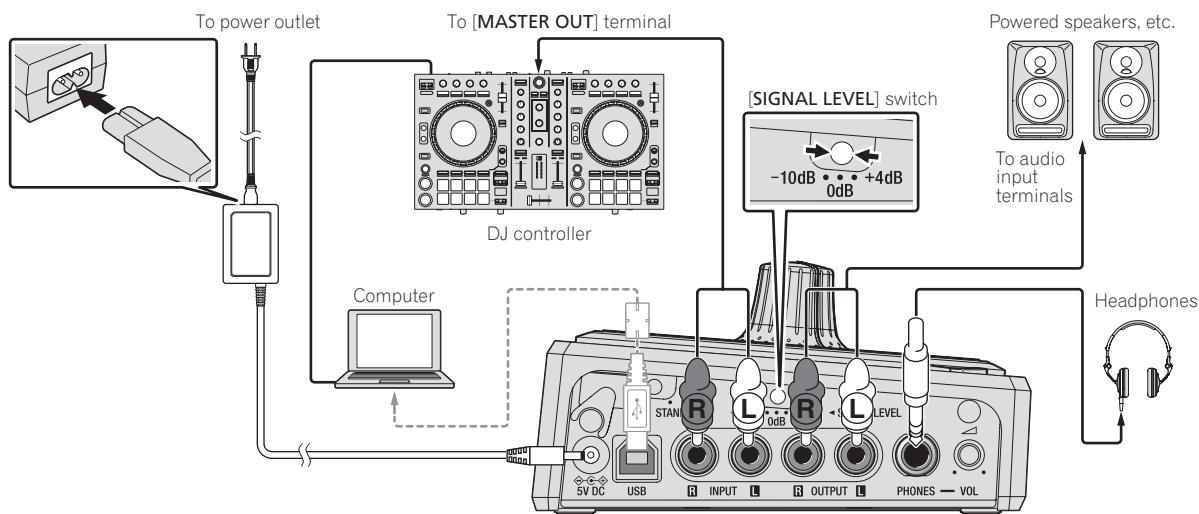

## ❖ To connect to the [SEND] and [RETURN] terminals on the DJ mixer

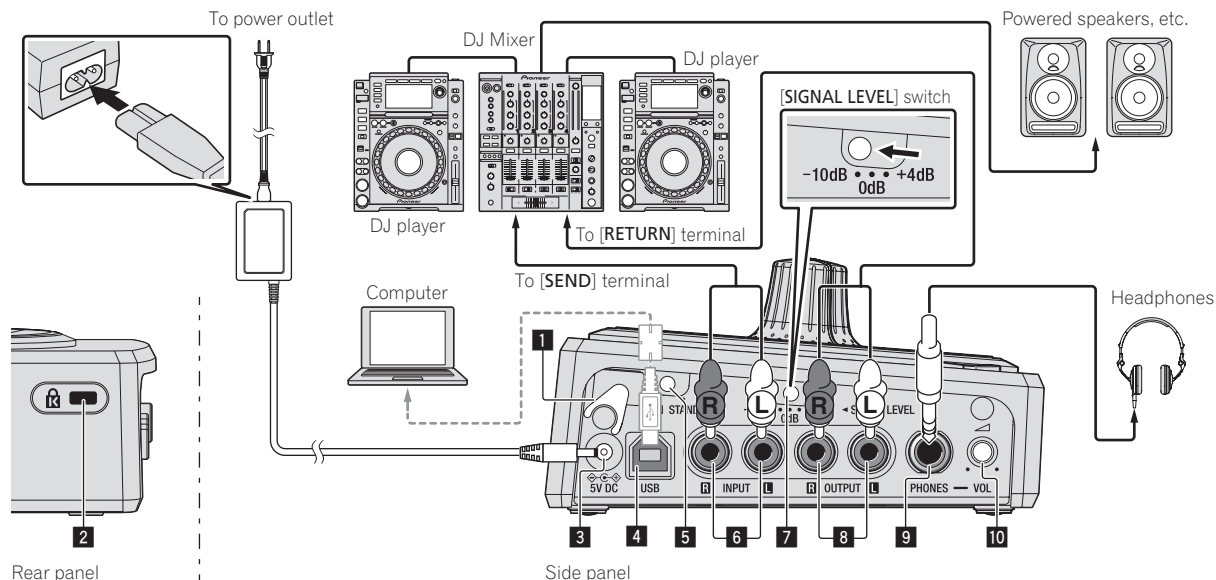

### 1 Cord hook

Hook the AC adapters' power cord here.

- The sound will be interrupted if the AC adapter's power cord is disconnected from the unit during playback.

### Using the cord hook

Hook the AC adapter's power cord onto the cord hook to fasten it in place. This prevents the power cord from being accidentally pulled, causing the plug to get disconnected from the terminal.

- As shown in the diagram below, extend the tip of the power cord to side of this unit and hook the power cord onto the cord hook.

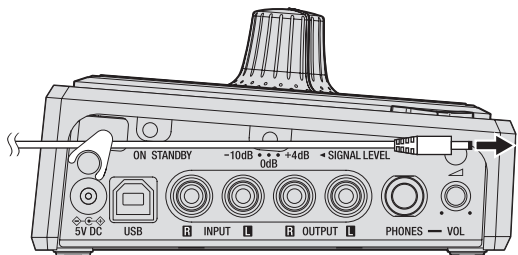

- Turn the tip of the power cord so that it is facing towards you, then turn it back to create a ring as shown in the diagram and insert it into the [5V DC] terminal of this unit.

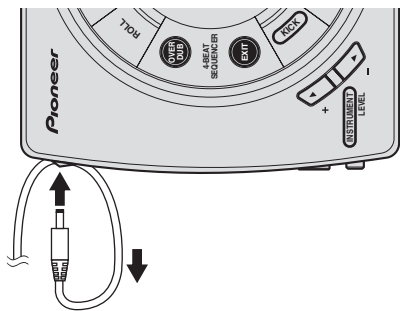

### 2 Kensington security slot

### 3 5V DC terminal

Connect the included AC adapter's DC plug here. Wait until all connections of the equipment are completed before connecting the power cord.

Be sure to use the power cord and AC adapter included with this product.

### 4 USB port

Connect to a computer.

- Connect this unit and the computer directly using the included USB cable.
- A USB hub cannot be used.

### 5 ON, STANDBY switch

This switches this unit's power between on and standby.

### 6 INPUT terminals

Connect to the external output terminals of a DJ mixer, DJ controller, DJ player, etc.

### 7 SIGNAL LEVEL switch

This switches this unit's input/output gain.

Set as shown below, according to the devices connected to this unit.

- [+4 dB]: Select this when connecting to a DJ mixer's [MASTER OUT] terminals.
- [+0 dB]: Select this when connected to the [MASTER OUT] terminals of a DJ mixer or DJ controller.
- [-10 dB]: Select this when connected to a DJ mixer's [SEND] and [RETURN] terminals.

### 8 OUTPUT terminals

Connect these to the external input terminals of powered speakers, a DJ mixer, etc.

### ⚠ CAUTION

Interconnect the equipment in such a way that the flow of the audio signals does not loop. If looped connections are made, the circuitry could produce oscillations that may damage the speakers, etc.

Examples of looped connections to be avoided

- Connecting a DJ mixer's output to this unit's input terminals then inputting this unit's output to the same DJ mixer's input terminals.
- Connecting the output from a DJ mixer's [SEND] terminals to this unit's input terminals then inputting this unit's output to input terminals other than the [RETURN] terminals on the same DJ mixer.

### 9 PHONES terminals

Connect headphones here.

- Connect headphones with an impedance of 32 Ω or more. Headphones with an impedance of less than 32 Ω are not supported.

### 10 HEADPHONES VOL control

Adjusts the audio level output from the [PHONES] terminal.



## Starting up and preparing this unit

- 1 Connect following the instructions at *Connecting the input/output terminals* on page 7.
- 2 Slide the [ON, STANDBY] switch on the rear panel of this unit to the [ON] position.

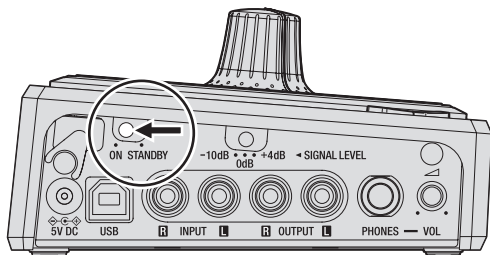

- 3 Check the audio level of the sound that is being input and output using the peak level indicators.

The brightness and color of the peak level indicators change according to the audio level of the sound that is being input and output.

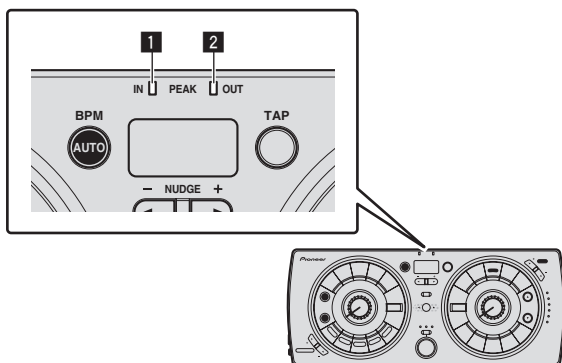

- 1 **INPUT** peak level indicator
- 2 **OUTPUT** peak level indicator
- Green: Permissible level
- Orange: Appropriate level
- Red: Excessive level

- If the peak level indicator lights red, the audio level of the input sound is too high. Switch the [SIGNAL LEVEL] switch or lower the output level of the connected device.
- This unit does not have a function for adjusting the input/output audio level. To adjust the input/output audio level, operate the devices connected to this unit.

# Operation

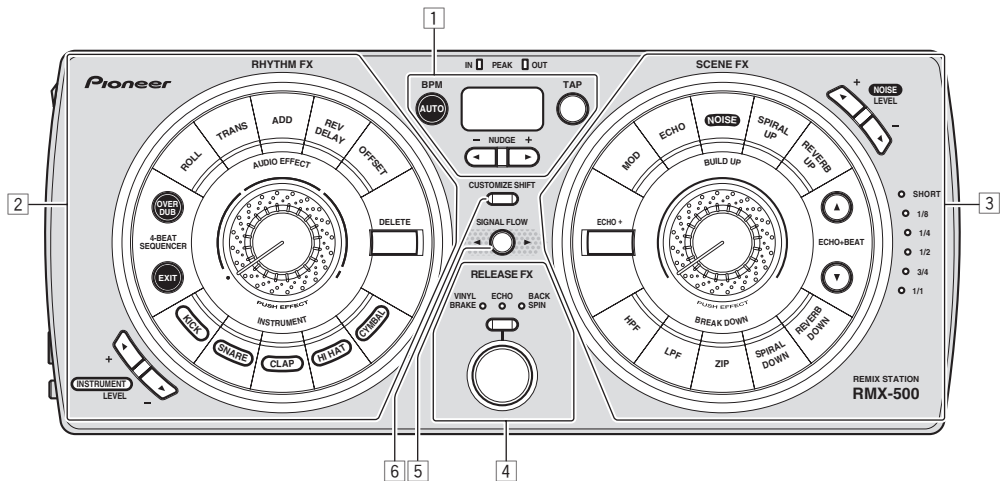

- 1 **Setting the BPM (page 10)**
- 2 **RHYTHM FX section (page 11)**
- 3 **SCENE FX section (page 12)**
- 4 **RELEASE FX section (page 13)**
- 5 **Switching the audio signal path (page 13)**
- 6 **Customizing the effect parameters (page 13)**

## Setting the BPM

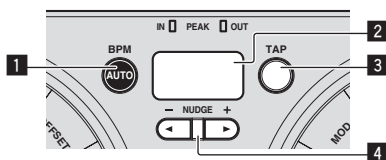

### 1 AUTO button

Switches the BPM measurement mode.

- **[AUTO]**: The BPM is measured automatically from the audio signal that is being input. The **[AUTO]** mode is set when this unit's power is turned on.
- **[TAP]**: The BPM is input manually by tapping the **[TAP]** button with a finger.
- The **[AUTO]** BPM measurement range is BPM = 70 to 180. With some tracks it may not be possible to measure the BPM correctly. If the BPM cannot be measured, the BPM value on the display flashes. In such cases, use the **[TAP]** button to input the BPM manually.

### 2 BPM display

When the BPM measurement mode is set to auto, this displays the automatically detected BPM value. If the value cannot be detected, the previously detected BPM value flashes.

When the BPM measurement mode is set to manual, this displays the manually input BPM value.

### 3 TAP button

Tap the button with a finger to input the BPM manually.

### 4 NUDGE (+, -) button

These fine-adjust the cycle and the timing for producing the sound of internal sound sources, etc.

## Inputting the BPM manually

Tap the **[TAP]** button at least 2 times in rhythm with the beat (in quarter notes) of the sound being played.

The interval at which the **[TAP]** button was tapped is set as the BPM.

- The BPM can be set manually in units of 1 by pressing a **[NUDGE (+, -)]** button while pressing the **[TAP]** button.
- The BPM can be set manually in units of 0.1 by pressing the **[AUTO]** button while pressing the **[TAP]** button, then pressing a **[NUDGE (+, -)]** button while pressing the two buttons.

## RHYTHM FX section

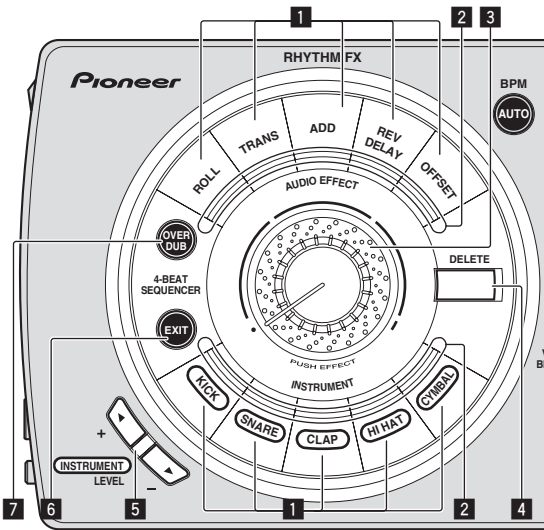

### 1 RHYTHM FX buttons

These turn the RHYTHM FX effects on and off.

### 2 RHYTHM FX indicator

This flashes when an effect is on.

### 3 RHYTHM FX control

This adjusts the selected RHYTHM FX effect.

### 4 DELETE button

This button can be used to delete the operations of the [RHYTHM FX] buttons that were recorded using the 4-BEAT SEQUENCER function, one button at a time.

### 5 Internal sound source volume adjustment buttons

These adjust the volume of the internal sound sources.

### 6 EXIT button

This lights when the 4-BEAT SEQUENCER function is on. When the button is pressed, the 4-BEAT SEQUENCER function turns off.

### 7 OVERDUB button

The 4-BEAT SEQUENCER function turns on. The operations of the [RHYTHM FX] buttons are recorded and the sound is played in a loop.

## Using the RHYTHM FX function

### 1 Press one of the [RHYTHM FX] buttons.

Select the RHYTHM FX effect type.

The button that was pressed flashes.

- Internal sound sources are preset at each of the [KICK], [SNARE], [CLAP], [HI HAT] and [CYMBAL] buttons.
- For details on the types of effects, see the Pioneer DJ support site below.  
<http://pioneerdj.com/support/>

### 2 Turn the [RHYTHM FX] control.

The effect is applied to the sound.

- The strength of the effect increases when the control is turned clockwise. The strength of the effect is maximum when the control is turned fully clockwise.
- The strength of the effect decreases when the control is turned counterclockwise. When turned fully counterclockwise, the original sound is output, with no effect applied.

### 3 Press the [RHYTHM FX] control.

A sound processing or sound adding effect is applied, depending on the type of effect that is selected.

- The sound processing or sound adding effect changes according to the strength with which the control is pressed in.
- When the selected [RHYTHM FX] button is pressed again, the effect turns off.

## Using the 4-BEAT SEQUENCER function

The order and timing at which the [RHYTHM FX] buttons are pressed are recorded and the sound is played in a loop.

### 1 Press the [OVERDUB] button.

When the [OVERDUB] button is pressed, the 4-BEAT SEQUENCER function turns on and the [OVERDUB] button flashes brightly.

While the [OVERDUB] button is flashing brightly, the operations of the [RHYTHM FX] buttons are recorded and loop playback continues.

When the [OVERDUB] button is pressed again, it starts flashing dimly and loop playback continues, but additional operations of the [RHYTHM FX] buttons are not recorded.

- When the 4-BEAT SEQUENCER function is on, RHYTHM FX effects are only applied while the corresponding [RHYTHM FX] button is being pressed.

### 2 While pressing the [DELETE] button, press the [RHYTHM FX] button whose recorded operation you want to delete.

When the [DELETE] button is pressed, the [RHYTHM FX] buttons whose operations are recorded light. When a lit button is pressed, the button turns off and the operation of that [RHYTHM FX] button which was recorded is deleted.

### 3 Press the [EXIT] button.

When the [EXIT] button is pressed, all the operations of the [RHYTHM FX] buttons that were recorded with the 4-BEAT SEQUENCER function are deleted. The 4-BEAT SEQUENCER function turns off and loop playback stops.

## SCENE FX section

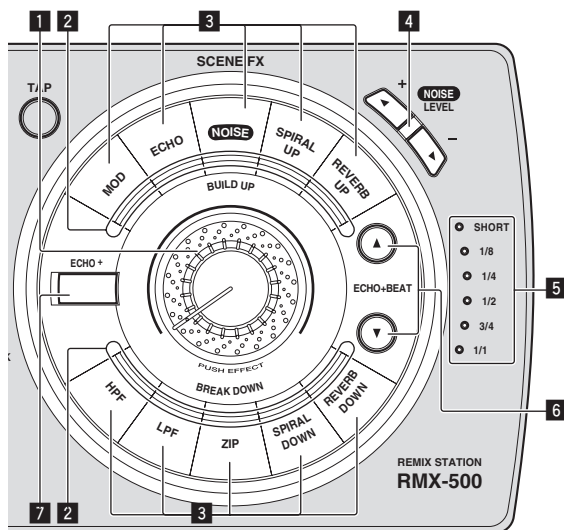

## Using the ECHO + function

An [ECHO] effect can be applied over the SCENE FX effect and output.

**1 Use the [BEAT (▲, ▼)] buttons to select the multiple for synchronizing the [ECHO] effect.**

**2 Press the [ECHO +] button.**

The ECHO + function turns on.

The [ECHO] effect is applied over the selected effect and output.

- When the [ECHO +] button is pressed again, the ECHO + function turns off.

### 1 SCENE FX control

This adjusts the selected SCENE FX effect.

### 2 SCENE FX indicator

This flashes when an effect is on.

### 3 SCENE FX buttons

These turn the SCENE FX effects on and off.

### 4 NOISE volume adjustment buttons

These adjust the volume of the [NOISE] effect applied to the input sound or the output sound.

### 5 ECHO + beat select indicators

The indicator for the beat for which the ECHO + function synchronizes lights.

### 6 BEAT (▲, ▼) button

Selects the beat multiple for synchronizing the ECHO + function.

### 7 ECHO + button

This turns the ECHO + function on and off.

## Using the SCENE FX function

### 1 Press one of the [SCENE FX] buttons.

Select the SCENE FX effect type.

The button that was pressed flashes.

- For details on the types of effects, see the Pioneer DJ support site below.  
<http://pioneerdj.com/support/>

### 2 Turn the [SCENE FX] control.

The effect is applied to the sound.

- The strength of the effect increases when the control is turned clockwise. The strength of the effect is maximum when the control is turned fully clockwise.
- The strength of the effect decreases when the control is turned counterclockwise. When turned fully counterclockwise, the original sound is output, with no effect applied.

### 3 Press the [SCENE FX] control.

An additional effect is applied to the sound.

- The additional effect changes according to the strength with which the control is pressed in.
- When the selected [SCENE FX] button is pressed again, the effect turns off.

## RELEASE FX section

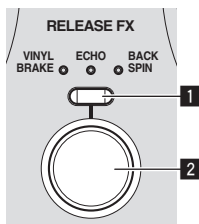

### 1 RELEASE FX type selection button

This switches the type of RELEASE FX effect.

### 2 RELEASE FX button

These turn the RELEASE FX effects on and off.

## Using the RELEASE FX function

### 1 Press the [RELEASE FX] type selection button.

Select the RELEASE FX effect type.

- For details on the types of effects, see the Pioneer DJ support site below.  
<http://pioneerdj.com/support/>

### 2 Press the [RELEASE FX] button.

This turns the effect on.

The effect is applied to the sound.

- When you release your finger from the button, the effect turns off. The RHYTHM FX and SCENE FX effects that were on up to this point also turn off.

## Switching the audio signal path

The audio signals input to this unit's [INPUT] terminals pass through the effect circuitry inside this unit and are then output from this unit's [OUTPUT] terminals.

This unit's effect circuitry includes three sections, positioned in the following order: the RHYTHM FX section, the SCENE FX section, and the RELEASE FX section.

Of these three effect sections, the order of the RHYTHM FX and SCENE FX sections can be inverted.

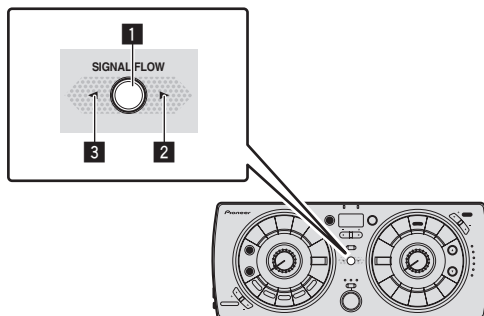

### Press the [SIGNAL FLOW] (1) button.

The audio signal path switches as shown on the diagram below each time the button is pressed.

- When the right indicator (2) is lit

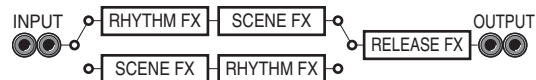

- When the left indicator (3) is lit

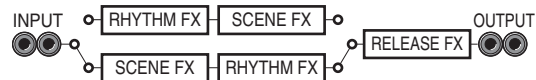

## Customizing the effect parameters

The [CUSTOMIZE SHIFT] button can be used to customize the parameters of this unit's effects.

The customized parameters are immediately reflected in this unit's operation.

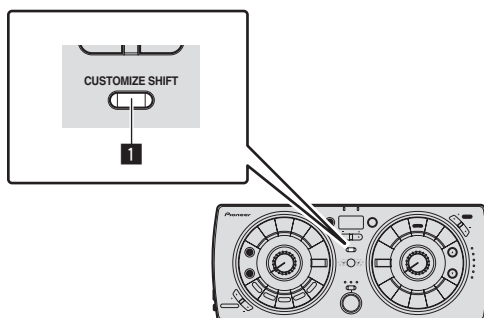

### While pressing the [CUSTOMIZE SHIFT] button (1), press the button of the effect you want to customize.

The type and beat of the respective effect switches.

- The effect type and beat can only be customized while the [CUSTOMIZE SHIFT] button is being pressed.
- Buttons that are not lit cannot be customized.
- For the RELEASE FX function, the selected effect's beat switches each time the [RELEASE FX] button is pressed.

---

---

# Additional information

---

---

## Troubleshooting

- Incorrect operation is often mistaken for trouble or malfunction. If you think that there is something wrong with this component, check the points below and the **[FAQ]** for the **[RMX-500]** on the Pioneer DJ support site. <http://pioneerdj.com/support/>  
Sometimes the problem may lie in another component. Inspect the other components and electrical appliances being used. If the problem cannot be rectified, ask your nearest Pioneer authorized service center or your dealer to carry out repair work.
- The player may not operate properly due to static electricity or other external influences. In such cases, normal operation may be restored by unplugging the power cord then plugging it back in.

Problem	Check	Remedy
The power is not turned on.	Are the included power cord and AC adapter properly connected?	Properly connect the included power cord to a power outlet. Properly connect the power cord to the included AC adapter. (page 7)
	Is the <b>[ON, STANDBY]</b> switch for power supply set to <b>[ON]</b> ?	Connect the included AC adapter's DC plug properly to this unit. Set the <b>[ON, STANDBY]</b> switch for power supply to <b>[ON]</b> .
	When power is being supplied by USB bus, is the included USB cable properly connected? Are you using a USB hub?	Connect the included USB cable properly. (page 7)
No sound or small sound.	Are the connection cables properly connected?	Connect the connection cables properly. (page 7)
	Are the terminals and plugs dirty?	Clean the terminals and plugs before making connections.
	Is the <b>[INPUT]</b> peak level indicator lit?	Adjust the output level of the connected device.
Distorted sound.	Is the <b>[INPUT]</b> peak level indicator or the <b>[OUTPUT]</b> peak level indicator lit red?	Switch the <b>[SIGNAL LEVEL]</b> selector switch according to the output level of the connected device. (page 8) Adjust the output level of the connected device.
	Tempo <b>(BPM)</b> cannot be measured or measurement value of tempo <b>(BPM)</b> is implausible.	Adjust the output level of the connected device and switch the <b>[SIGNAL LEVEL]</b> selector switch according to the output level of the connected device so that the <b>[INPUT]</b> peak level indicator lights at an appropriate level. For some tracks, it may not be possible to measure the tempo <b>(BPM)</b> . Use the <b>[TAP]</b> button to input the tempo manually. (page 10)
Customized settings are not stored.	Did you turn the power off immediately after customizing the settings?	Wait at least 10 seconds after customizing settings before turning the power off.
Value of the measured tempo <b>(BPM)</b> differs from value recorded on CD, or tempo <b>(BPM)</b> values displayed on DJ player, DJ mixer, DJ software and this unit differ.	—	The values may differ slightly due to the different ways in which the <b>BPM</b> is measured.
This unit is not recognized after it has been connected to a computer.	Is the included USB cable properly connected?	Connect this unit and computer directly, not via a USB hub.

---

---

## About trademarks and registered trademarks

- Pioneer is a registered trademark of PIONEER CORPORATION.
- VST is a trademark of Steinberg Media Technologies GmbH.
- The Audio Units logo is a trademark of Apple Inc.
- RTAS is a registered trademark of Avid Technology, Inc. or its subsidiaries in the United States and/or other countries.

The names of companies and products mentioned herein are the trademarks of their respective owners.

---

---

## Cautions on copyrights

Recordings you have made are for your personal enjoyment and according to copyright laws may not be used without the consent of the copyright holder.

- Music recorded from CDs, etc., is protected by the copyright laws of individual countries and by international treaties. It is the full responsibility of the person who has recorded the music to ensure that it is used legally.
- When handling music downloaded from the Internet, etc., it is the full responsibility of the person who has downloaded the music to ensure that it is used in accordance with the contract concluded with the download site.

---

---

## General Disclaimer

Please note that Pioneer will accept no responsibility whatsoever concerning legality, morality, operation stability, etc., when using software that was downloaded by the user. Problems may occur in operation of downloaded software, depending on the operating environment of the computer being used and the downloaded software or compatibility with other software.

Please note that Pioneer will accept no responsibility whatsoever for loss of information the user has registered using downloaded software. Write down the information you have registered in a note, etc., for safe keeping.

## Specifications

### AC adapter

Power.....	AC 100 V to 240 V, 50 Hz/60 Hz
Rated current.....	0.4 A
Rated output.....	DC 5 V, 2 A

### General – Main Unit

Power consumption (when using AC adapter).....	600 mA
Power consumption (when using USB bus power).....	500 mA
Main unit weight.....	0.93 kg (2.1 lb)
Max. dimensions.....	306 mm (W) × 67 mm (H) × 132 mm (D) (12 in. (W) × 2.6 in. (H) × 5.2 in. (D))
Tolerable operating temperature.....	+5 °C to +35 °C (+41 °F to +95 °F)
Tolerable operating humidity.....	5 % to 85 % (no condensation)

### Audio Section

Sampling rate.....	48 kHz
A/D, D/A converter.....	24 bits
Frequency response.....	20 Hz to 20 kHz
S/N ratio ( <b>OUTPUT</b> , rated output, A-WEIGHTED).....	96 dB
Total harmonic distortion ( <b>OUTPUT</b> , 20 Hz – 20 kHz BW).....	0.006 %
Headroom.....	15 dB
Standard input level/standard output level (10 k $\Omega$ load)	
SIGNAL LEVEL switch (+4 dB).....	+4 dBu
SIGNAL LEVEL switch (+0 dB).....	+0 dBu
SIGNAL LEVEL switch (-10 dB).....	-10 dBV
Input impedance	
<b>INPUT</b> .....	30 k $\Omega$
Output impedance	
<b>OUTPUT</b> .....	1 k $\Omega$ or less
<b>PHONES</b> .....	10 $\Omega$ or less

### Input / Output terminals

<b>INPUT</b> input terminals	
RCA pin jacks.....	1 set
<b>OUTPUT</b> output terminal	
RCA pin jacks.....	1 set
<b>PHONES</b> output terminal	
Stereo phone jack ( $\varnothing$ 6.3 mm).....	1 set
<b>USB</b> terminal	
B type (stereo 1 in/1 out).....	1 set

- The specifications and design of this product are subject to change without notice.











PIONEER ELECTRONICS (USA) INC.  
**LIMITED WARRANTY**  
 WARRANTY VALID ONLY IN THE U.S.A. AND CANADA

**WARRANTY**

Pioneer Electronics (USA) Inc. (PUSA) warrants that products distributed by PUSA in the U.S.A. and Canada that fail to function properly under normal use due to a manufacturing defect when installed and operated according to the owner's manual enclosed with the unit will be repaired or replaced with a unit of comparable value, at the option of PUSA, without charge to you for parts or actual repair work. Parts supplied under this warranty may be new or rebuilt at the option of PUSA.

**THIS LIMITED WARRANTY APPLIES TO THE ORIGINAL OR ANY SUBSEQUENT OWNER OF THIS PIONEER PRODUCT DURING THE WARRANTY PERIOD PROVIDED THE PRODUCT WAS PURCHASED FROM AN AUTHORIZED PIONEER DISTRIBUTOR/DEALER IN THE U.S.A. OR CANADA. YOU WILL BE REQUIRED TO PROVIDE A SALES RECEIPT OR OTHER VALID PROOF OF PURCHASE SHOWING THE DATE OF ORIGINAL PURCHASE OR, IF RENTED, YOUR RENTAL CONTRACT SHOWING THE PLACE AND DATE OF FIRST RENTAL. IN THE EVENT SERVICE IS REQUIRED, THE PRODUCT MUST BE DELIVERED WITHIN THE WARRANTY PERIOD, TRANSPORTATION PREPAID, ONLY FROM WITHIN THE U.S.A. AS EXPLAINED IN THIS DOCUMENT. YOU WILL BE RESPONSIBLE FOR REMOVAL AND INSTALLATION OF THE PRODUCT. PUSA WILL PAY TO RETURN THE REPAIRED OR REPLACEMENT PRODUCT TO YOU WITHIN THE U.S.A.**

**PRODUCT WARRANTY PERIOD**

	<u>Parts</u>	<u>Labor</u>
<b>DJ Audio and Video</b> .....	1 Year	1 Year

The warranty period for retail customers who rent the product commences upon the date product is first put into use (a) during the rental period or (b) retail sale, whichever occurs first.

**WHAT IS NOT COVERED**

**IF THIS PRODUCT WAS PURCHASED FROM AN UNAUTHORIZED DISTRIBUTOR, THERE ARE NO WARRANTIES, EXPRESS OR IMPLIED, INCLUDING THE IMPLIED WARRANTY OF MERCHANTABILITY AND THE IMPLIED WARRANTY OF FITNESS FOR A PARTICULAR PURPOSE AND THIS PRODUCT IS SOLD STRICTLY "AS IS" AND "WITH ALL FAULTS". PIONEER SHALL NOT BE LIABLE FOR ANY CONSEQUENTIAL AND/OR INCIDENTAL DAMAGES.**

**THIS WARRANTY DOES NOT APPLY IF THE PRODUCT HAS BEEN SUBJECTED TO POWER IN EXCESS OF ITS PUBLISHED POWER RATING.**

**THIS WARRANTY DOES NOT COVER THE CABINET OR ANY APPEARANCE ITEM, USER ATTACHED ANTENNA, ANY DAMAGE TO RECORDS OR RECORDING TAPES OR DISCS, ANY DAMAGE TO THE PRODUCT RESULTING FROM ALTERATIONS, MODIFICATIONS NOT AUTHORIZED IN WRITING BY PIONEER, ACCIDENT, MISUSE OR ABUSE, DAMAGE DUE TO LIGHTNING OR TO POWER SURGES, SUBSEQUENT DAMAGE FROM LEAKING, DAMAGE FROM INOPERATIVE BATTERIES, OR THE USE OF BATTERIES NOT CONFORMING TO THOSE SPECIFIED IN THE OWNER'S MANUAL.**

**THIS WARRANTY DOES NOT COVER THE COST OF PARTS OR LABOR WHICH WOULD BE OTHERWISE PROVIDED WITHOUT CHARGE UNDER THIS WARRANTY OBTAINED FROM ANY SOURCE OTHER THAN A PIONEER AUTHORIZED SERVICE COMPANY OR OTHER DESIGNATED LOCATION. THIS WARRANTY DOES NOT COVER DEFECTS OR DAMAGE CAUSED BY THE USE OF UNAUTHORIZED PARTS OR LABOR OR FROM IMPROPER MAINTENANCE.**

**ALTERED, DEFACED, OR REMOVED SERIAL NUMBERS VOID THIS ENTIRE WARRANTY**

**NO OTHER WARRANTIES**

**PIONEER LIMITS ITS OBLIGATIONS UNDER ANY IMPLIED WARRANTIES INCLUDING, BUT NOT LIMITED TO, THE IMPLIED WARRANTIES OF MERCHANTABILITY AND FITNESS FOR A PARTICULAR PURPOSE, TO A PERIOD NOT TO EXCEED THE WARRANTY PERIOD. NO WARRANTIES SHALL APPLY AFTER THE WARRANTY PERIOD. SOME STATES DO NOT ALLOW LIMITATIONS ON HOW LONG AN IMPLIED WARRANTY LASTS AND SOME STATES DO NOT ALLOW THE EXCLUSIONS OR LIMITATIONS OF INCIDENTAL OR CONSEQUENTIAL DAMAGES, SO THE ABOVE LIMITATIONS OR EXCLUSIONS MAY NOT APPLY TO YOU. THIS WARRANTY GIVES YOU SPECIFIC LEGAL RIGHTS AND YOU MAY HAVE OTHER RIGHTS WHICH MAY VARY FROM STATE TO STATE.**

**TO OBTAIN SERVICE**

PUSA has appointed a number of Authorized Service Companies throughout the U.S.A. and Canada should your product require service. To receive warranty service you need to present your sales receipt or, if rented, your rental contract showing place and date of original owner's transaction. If shipping the unit you will need to package it carefully and send it, transportation prepaid by a traceable, insured method, to an Authorized Service Company. Package the product using adequate padding material to prevent damage in transit. The original container is ideal for this purpose. Include your name, address and telephone number where you can be reached during business hours.

On all complaints and concerns in the U.S.A. and Canada call Customer Support at 1-800-872-4159.

For hook-up and operation of your unit or to locate an Authorized Service Company, please call or write:  
 CUSTOMER SUPPORT  
 PIONEER ELECTRONICS (USA) INC.  
 P.O. BOX 1720  
 LONG BEACH, CALIFORNIA 90801  
 1-800-872-4159  
<http://www.pioneerelectronics.com>

**DISPUTE RESOLUTION**

Following our response to any initial request to Customer Support, should a dispute arise between you and Pioneer, Pioneer makes available its Complaint Resolution Program to resolve the dispute. The Complaint Resolution Program is available to you without charge. You are required to use the Complaint Resolution Program before you exercise any rights under, or seek any remedies, created by Title I of the Magnuson-Moss Warranty-Federal Trade Commission Improvement Act, 15 U.S.C. 2301 *et seq.*

To use the Complaint Resolution Program call 1-800-872-4159 and explain to the customer service representative the problem you are experiencing, steps you have taken to have the product repaired during the warranty period and the name of the authorized Distributor/Dealer from whom the Pioneer product was purchased. After the complaint has been explained to the representative, a resolution number will be issued. Within 40 days of receiving your complaint, Pioneer will investigate the dispute and will either: (1) respond to your complaint in writing informing you what action Pioneer will take, and in what time period, to resolve the dispute; or (2) respond to your complaint in writing informing you why it will not take any action.

**RECORD THE PLACE AND DATE OF PURCHASE FOR FUTURE REFERENCE**

Model No. \_\_\_\_\_ Serial No. \_\_\_\_\_ Purchase Date \_\_\_\_\_

Purchased From \_\_\_\_\_

KEEP THIS INFORMATION AND YOUR SALES RECEIPT IN A SAFE PLACE

UCP0212

To register your product, find the nearest authorized service location, to purchase replacement parts, operating instructions, or accessories, please go to one of following URLs :

Pour enregistrer votre produit, trouver le service après-vente agréé le plus proche et pour acheter des pièces de rechange, des modes d'emploi ou des accessoires, reportez-vous aux URL suivantes :

**In the USA & Canada/Aux Etats-Unis & Canada**  
**<http://www.pioneerelectronics.com>**

S018\_B1\_EnFr\_PSV

© 2013 PIONEER CORPORATION.  
All rights reserved.

---

**PIONEER CORPORATION**

1-1, Shin-ogura, Saiwai-ku, Kawasaki-shi, Kanagawa 212-0031, Japan

**PIONEER ELECTRONICS (USA) INC.**

P.O. BOX 1720, Long Beach, California 90801-1720, U.S.A. TEL: (800) 421-1404

K002\_PSV\_CU

Printed in

<DRH1252-A>



## Free Manuals Download Website

<http://myh66.com>

<http://usermanuals.us>

<http://www.somanuals.com>

<http://www.4manuals.cc>

<http://www.manual-lib.com>

<http://www.404manual.com>

<http://www.luxmanual.com>

<http://aubethermostatmanual.com>

Golf course search by state

<http://golfingnear.com>

Email search by domain

<http://emailbydomain.com>

Auto manuals search

<http://auto.somanuals.com>

TV manuals search

<http://tv.somanuals.com>