

***Pioneer***

**ELITE**

**PROJECTION MONITOR RECEIVER**

**PRO-610HD**

**PRO-510HD**

**Operating Instructions**

# FEATURES

## Progressive Scan/HDTV READY

Combination with the SH-D09 digital tuner, sold separately, makes it possible to receive all ATSC 18 formats. All SDTV and HDTV signals are converted to 1080i signals and displayed at high resolution.

## Dual System Component Input for NTSC/Progressive

Connection to a DVD player with a component output terminal makes possible high-picture-quality display superior to that of S-VIDEO terminal connection. Also handles high resolution component input (1080i, 480p), which will function as an interface for high-quality images in future.

## DUAL TUNER (SPLIT screen and SEARCH screen function)

Two TV tuners are provided, making it possible to split the screen vertically in two and display moving images simultaneously on them. In addition, the channel search function makes it possible to check, etc., on the program in the back. Its convenience will be limited only by your imagination.

## Fully Illuminated Remote Control Unit

A fully illuminated universal remote control is used that makes it possible to operate other devices. Remote operations can thus be performed easily even in dark rooms and similar environments.

## Highly Detailed Image Display Technology

The 0.52mm ultrafine-pitch screen, Hi Band Video Amplifier circuit, Progressive contour correction circuit and various other technologies for creating high picture quality make the display of highly detailed images possible.

## Lens System for HDTV

Adoption of a lens system for high-resolution HDTV that faithfully reproduces HDTV 1080i signals allows highly color-saturated images to be displayed at high resolution.

## Whole Screen IR Receiver

The remote control sensor is installed behind the screen, allowing you to operate this monitor with the remote control unit in those installations where only the screen is revealed.

## 3D Y/C Separation Circuit

This three-dimensional Y/C separation circuit reproduces clearer picture quality.

## Scan Velocity Modulation Circuit

Precise images from progressive scanning can be displayed in even greater detail, owing to the Scan Velocity Modulation (SVM) circuit. In accordance with image type and preference, the level of effect can be changed in terms of three stages.

## Tinted Protective Screen

The accompanying protective screen is tinted, not only to protect the screen but to allow viewers to enjoy high-contrast images.

## Pioneer's PURECINEMA Format Converter

An advanced and exclusive I/P (Interlace/Progressive) format converter developed by Pioneer, called "PURECINEMA", delivers a high-resolution progressive picture. It reproduces film material in a very smooth and film-like image. This is perfect technology for movie lovers.

## Multi-Point Convergence System

Thanks to new convergence system digital technology, not only can the center of the screen be adjusted, so can an amazing 72 other points (full mode) across the viewing area. This makes it possible to display clear images with no color distortion around the entire screen.

The adjustment is easily done using the remote control.

## Program Block (V. CHIP)

You can block selected programs based on the established rating system for television and movies.

The TV Parental Guidelines are used to rate television programming: <TV-Y>, <TV-Y7>, <TV-G>, <TV-PG>, <TV-14> and <TV-MA>.

The Motion Picture Association of America (MPAA) guidelines are used to rate movies: <G>, <PG>, <PG-13>, <R>, <NC-17>, <X> and <NR>.

In order to block programming you feel is inappropriate, rating limits can be set on both systems using the remote control and a password.

This equipment has been tested and found to comply with the limits for a Class B digital device, pursuant to Part 15 of the FCC Rules. These limits are designed to provide reasonable protection against harmful interference in a residential installation. This equipment generates, uses, and can radiate radio frequency energy and, if not installed and used in accordance with the instructions, may cause harmful interference to radio communications. However, there is no guarantee that interference will not occur in a particular installation. If this equipment does cause harmful interference to radio or television reception, which can be determined by turning the equipment off and on, the user is encouraged to try to correct the interference by one or more of the following measures:

- Reorient or relocate the receiving antenna.
- Increase the separation between the equipment and receiver.
- Connect the equipment into an outlet on a circuit different from that to which the receiver is connected.
- Consult the dealer or an experienced radio/TV technician for help.

Thank you for purchasing this PIONEER Projection Monitor Receiver.

Please read the precautionary instructions enclosed with these operating instructions please do so before proceeding. After learning how to operate the Projection Monitor, be sure to keep this manual handy for future reference.

**Read and understand these 'Operating Instructions' before operating your Monitor. Follow the 'IMPORTANT SAFETY INSTRUCTIONS AND WARNINGS' section and all the warnings on the product.**

### IMPORTANT NOTICE

The model number and the serial number of this Projection Monitor are located on the rear panel.

Please write the serial number on the enclosed warranty card and keep it in a safe place for future reference.

In this manual, we refer to the 'PROJECTION MONITOR RECEIVER', as the 'Projection Monitor' or the 'Monitor'.

### Note on the SPLIT screen and SEARCH screen functions

The SPLIT screen and SEARCH screen functions provided in this monitor are intended for private viewing only.

Use of the above video processing functions for profitmaking purpose or for public viewing (clubs, hotels, etc.) without prior authorization from the transmitter and/or owner of the video program (s) may be an infringement of existing copyright laws.

### WARNING:

**TO REDUCE THE RISK OF THE FIRE OR ELECTRIC SHOCK, DO NOT EXPOSE THIS APPLIANCE TO WET LOCATIONS.**

### CAUTION:

**TO PREVENT ELECTRIC SHOCK DO NOT USE THIS (POLARIZED) PLUG WITH AN EXTENSION CORD, RECEPTACLE OR OTHER OUTLET UNLESS THE BLADES CAN BE FULLY INSERTED TO PREVENT BLADE EXPOSURE.**

### ATTENTION:

**POUR EVITER UNE DECHARGE ELECTRIQUE, NE PAS UTILISER CETTE PRISE (POLARISEE) AVEC UNE RALLONGE, UNE PRISE OU UNE AUTRE SORTIE A MOINS QUE LES LAMES PUISSENT ETRE COMPLETEMENT INTRODUITES ET NE SOIENT PAS EXPOSEES.**

### Note to CATV system installer:

*This reminder is provided to call the CATV system installer's attention to Article 820-40 of NEC that provides guidelines for proper grounding and, in particular, specifies that the cable ground should be connected to the grounding system of the building, as close to the point of cable entry as practical.*

### Information to User

Alteration or modifications carried out without appropriate authorization may invalidate the user's right to operate the equipment.

## IMPORTANT



The lightning flash with arrowhead symbol, within an equilateral triangle, is intended to alert the user to the presence of uninsulated "dangerous voltage" within the product's enclosure that may be of sufficient magnitude to constitute a risk of electric shock to persons.

### CAUTION

**RISK OF ELECTRIC SHOCK  
DO NOT OPEN**

#### CAUTION:

TO PREVENT THE RISK OF ELECTRIC SHOCK, DO NOT REMOVE COVER (OR BACK). NO USER-SERVICEABLE PARTS INSIDE. REFER SERVICING TO QUALIFIED SERVICE PERSONNEL.



The exclamation point within an equilateral triangle is intended to alert the user to the presence of important operating and maintenance (servicing) instructions in the literature accompanying the appliance.

## NOTICE ON ADVERSE EFFECTS ON THE TV TUBE

**When playing TV games, operating computers or displaying still pictures with your Monitor, be sure to keep in mind the following points;**

- 1. Select the 'GAME' mode. (Refer to page 48 of the Operating Instructions)**
- 2. Do not use your Monitor for more than two hours.**
- 3. Watch normal TV broadcast's for three times longer than the time of playing TV games, operating computers or displaying still pictures.**

**Still patterns can scar the Monitor causing performance damage to the CRT.**

The following symbols are found in this manual and on the labels on the product. They alert the operators and service personnel of this equipment to potentially dangerous conditions.

 This symbol indicates an action that is prohibited.

**⚠ WARNING**  
 This symbol refers to a hazard or unsafe practice which can result in severe personal injury or death.

**⚠ CAUTION**  
 This symbol refers to a hazard or unsafe practice which can result in personal injury or property damage.

## **⚠ WARNING**

# **IMPORTANT SAFETY INSTRUCTIONS AND WARNINGS**

- Read all of these instructions.
- Keep these instructions for later use.
- Follow all warnings and instructions marked on the Monitor.

### **FOR YOUR PERSONAL SAFETY**

1. This Monitor is equipped with a polarized alternating current line plug (a plug having one blade wider than the other). This plug will fit into the power outlet only one way. This is a safety feature.



If you are unable to insert the plug fully into the outlet, try reversing the plug. If the plug should still fail to fit, contact your electrician to replace your obsolete outlet. Do not defeat the safety purpose of the polarized plug.

2. If the power cord or plug becomes damaged or frayed, unplug this Monitor from the wall outlet and refer to qualified service personnel for servicing.



3. Do not overload wall outlets and extension cords as this can result in fire or electrical shock.



4. Do not allow anything to rest on or roll over the power cord, and do not place the Monitor where the power cord may be subject to traffic or abuse. This may result in electrical or fire hazard.

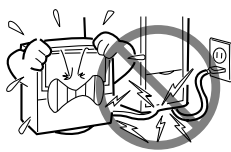

5. Do not attempt to service this Monitor yourself as opening or removing covers may expose you to dangerous voltage or other hazards. Refer all servicing to qualified personnel.



6. Never push the objects of any kind into this Monitor through cabinet slots as they may touch dangerous voltage points or short out parts that could result in a fire or electric shock. Never spill liquid of any kind on the Monitor.



7. If the Monitor has been dropped or the cabinet has been damaged, unplug this Monitor from the wall outlet and refer to qualified service personnel for servicing.



8. If liquid has been spilled into the Monitor, unplug the Monitor from the wall outlet and refer servicing to qualified service personnel.



9. Do not subject your Monitor to impact of any kind. Be particularly careful not to damage the screen surface.



10. Unplug the Monitor from the wall outlet before cleaning. Do not use liquid cleaners or spray-type cleaners. Use a damp cloth for cleaning.



11-1. Do not place this Monitor on an unstable, uneven or an inclined location. The Monitor may overturn, causing serious injury (to a person), and serious damage to the appliance.

11-2. Be careful when placing the Monitor on a cart to move it. Quick stops, excessive force, and uneven surfaces may cause the Monitor and cart to overturn.



### PROTECTION AND LOCATION OF YOUR PROJECTION MONITOR RECEIVER

12. •Do not use the Monitor near water, for example, near a bathtub, washbowl, kitchen sink, or laundry tub, in a wet basement, or near a swimming pool, etc.



•Never expose the Monitor to rain water.

If the Monitor system has been exposed to rain or water, unplug the Monitor from the wall outlet and refer servicing to qualified service personnel.



13. Choose a place where light (artificial or sunlight) does not shine directly on the screen.

14. Avoid dusty places since the buildup of dust inside the Monitor's chassis may result in the malfunctioning, when high humidity persists.



15. •The Monitor has slots, or openings in the cabinet for ventilation purposes to ensure the reliable operation of the Monitor, and to protect it from overheating. These openings must not be blocked or covered.



•Never cover the slots or openings with cloth or other material.

•Never block the bottom ventilation slots of the Monitor by placing it on a bed, sofa, rug, etc.



•Never place the Monitor near or over a radiator or heat register.

•Never place the Monitor in a built-in enclosure such as a bookcase, unless proper ventilation is provided.



16. If an outside antenna is connected through other equipment, be sure the antenna system is grounded so as to provide protection against voltage surges and built-up static charges. In the U. S. A., section 810 of the National Electrical Code, ANSI/NFPA 70, provides information on proper grounding of the mast and supporting structure, grounding of the lead-in wire to an antenna-discharge unit, size of grounding conductors, location of antenna-discharge unit, connection to grounding electrode, and requirements for the grounding electrode.

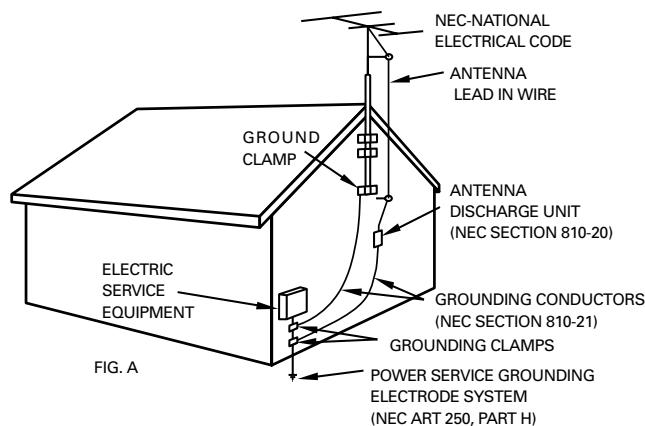
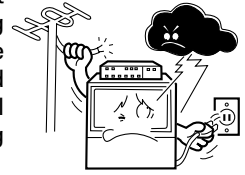

FIG. A  
**EXAMPLE OF ANTENNA GROUNDING IN NATIONAL ELECTRICAL CODE INSTRUCTIONS**

17. An outdoor antenna system should not be located in the vicinity of overhead power lines/ electric lights or power circuits, or where it can fall onto such power lines or circuits. When installing an outdoor antenna system, extreme care should be taken to keep it from touching such power lines or circuits as contact with them might be fatal.



18. For added protection during a lightning storm, or when it is left unattended and unused for long periods of time, unplug the Monitor from the wall outlet and disconnect the antenna. This will prevent damage due to lightning and power-line surges.



## OPERATION OF YOUR PROJECTION MONITOR RECEIVER

19. The Monitor should be operated only from the type of power source indicated on the marking label. If you are not sure of the type of power supply at your home, consult your dealer or local power company.

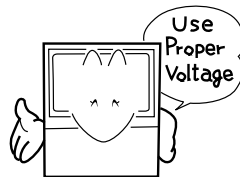

24. It is normal for some Monitor to make occasional snapping or popping sounds, particularly when being turned on or off. If the snapping or popping is continuous or frequent, unplug the Monitor and consult your dealer or service technician.

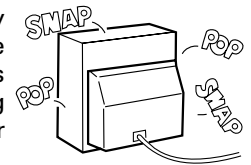

20. If you are unable to restore normal operation by following the detailed procedure in your operating instructions, unplug it from the wall outlet and refer to qualified service personnel for servicing. Do not adjust other controls than those described in this manual. Improper adjustments may result in damage and will often require extensive work by a qualified technician to restore the Monitor to normal operation.



## FOR SERVICING AND MODIFICATION

25. Do not use attachments not recommended by the Monitor's manufacturer as they may result in the risk of fire, electrical shock or injury to persons.

26. When replacement parts are required, be sure the service technician uses replacement parts specified by the manufacturer that have the same characteristics as the original part. Unauthorized substitutions may result in fire, electrical shock, or injury.

21. If your Monitor is to remain unused for a period of time, for instance, when you go on a holiday, turn the Monitor 'off' and unplug it from the wall outlet.



27. Upon completion of any service or repairs to the Monitor, ask the service technician to perform routine safety checks to determine that the Monitor is in a safe operating condition.

TV SERVICE DEPT.

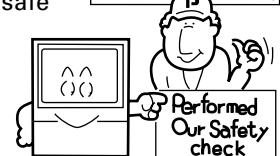

## IF THE PROJECTION MONITOR RECEIVER DOES NOT OPERATE PROPERLY

22. If you are unable to restore normal operation by following the detailed procedure in your operating instructions, do not attempt any further adjustment. Unplug the Monitor and call your dealer or service technician.



23. Whenever the Monitor is damaged or fails, or there is a distinct change in performance, unplug the Monitor and have it checked by a professional service technician.

# CONTENTS

---

## INTRODUCTION

HOW TO READ THIS OPERATING INSTRUCTIONS .....	8
INSTALLING THE MONITOR .....	9

---

## BASIC OPERATIONS

BEFORE USE .....	12
CONNECTING THE ANTENNA .....	14
CONNECTING VIDEO/AUDIO EQUIPMENT .....	16
FRONT PANEL FUNCTIONS .....	20
REMOTE CONTROL UNIT FUNCTIONS .....	22
TO WATCH TV .....	24
CHECKING THE MENU .....	26
AUTO CHANNEL PRESET .....	28
CONVERGENCE ADJUSTMENT .....	30

---

## BASIC FUNCTIONS

PROGRAM BLOCK (V. CHIP) FUNCTION .....	32
CHANGING PASSWORD .....	36
CHANGING SCREEN SIZE .....	38
MULTI-SCREEN FUNCTION .....	40
CLOSED CAPTION DECODE FUNCTION .....	42
CHANGING CHANNEL SET UP .....	43
PICTURE ADJUSTMENTS .....	48
SOUND ADJUSTMENTS .....	55
DPO FUNCTION .....	59
MULTI-POINT CONVERGENCE ADJUSTMENT .....	60

---

## VARIOUS FUNCTIONS

CONNECTION WITH RECEIVER (1) .....	62
CONNECTION WITH RECEIVER (2) .....	63
CONNECTING THE SYSTEM REMOTE CONTROL .....	67
REMOTE CODE SET UP .....	68

---

## OTHERS













USING THE DIGITAL TUNER TO WATCH DTV .....	78
MENU INDEX .....	86
TROUBLESHOOTING .....	88
SPECIFICATIONS .....	90

# HOW TO READ THIS OPERATING INSTRUCTIONS

The following page is an example of the way that basic operating instructions are shown in this manual. The explanation method varies from page to page.

## AUTO CHANNEL PRESET

The broadcast frequencies that can be received depend on your area. Memorize the broadcast stations that can be received in your area in the preset.

- 1 Select TV.** 
- 2 Press MENU and select SET UP by using the ▲ or ▼ button and then pressing SET/ENTER. (Refer to page 26.)**
- 3 Select CHANNEL SET UP in the same way.**  
  
- 4 Select AUTO CHANNEL PRESET .**  
  
- 5 Select ANTENNA , then select A or B.**  
    
  

**NOTE:**  
The CHANNEL SET UP cannot be selected unless the function is set up for TV.

**28**  
<ARB1527>

**Explanation of the function on this page.**

**Operating procedure**

**Screen during operation**

**Buttons operated**

**The button that is operated is shown in dark gray.**

**Precautions etc.**



# INSTALLING THE MONITOR

## INSTALLATION PRECAUTIONS:

- **Keep away from magnetic fields**  
The picture may be distorted if strong magnetic fields are nearby. External speakers should be set at least 2 feet (60cm) away from the Projection Monitor. Electric fans and other motor driven appliances and toys may also be sources of magnetism.
- Bright light or direct sunlight will dull the picture. Position the Projection Monitor so that the screen faces away from windows.
- While the Projection Monitor is operating, it is cooled by airflow through ventilation holes in the rear and bottom. Therefore, avoid placing it in a location where the cooling airflow is hindered (e. g. against a wall).
- Avoid places subject to extremely high temperatures or humidity, or to temperatures of 41°F (5°C) or lower. Also avoid dusty places.
- If setting the Projection Monitor on a floor made of soft material, make sure that the floor will not be damaged by the weight of the Projection Monitor.
- Do not put the Projection Monitor on a surface that is tilted, unsteady or prone to shake or vibrate. A shaky or slanted platform is dangerous.
- Cover shiny surfaces (floor and walls) with non reflective materials (carpet, rugs, wallpaper, etc.).

## CARE OF YOUR PROJECTION MONITOR

### DO NOT:

- Do not use strong cleansers, solvents, polishes, or chemically treated cloths to clean the screen or cabinet.
- Do not touch or scratch the screen.
- Do not fasten or place rubber or vinyl items on the Monitor.
- Do not stick adhesive tape onto the Monitor.
- Do not put any object on the Monitor.

### DO:

- Use a soft cloth to dust the screen and cabinet.
- Handle the screen with care to avoid scratches or damages.
- Ask your dealer or a Pioneer authorized service center to clean the interior of the monitor in your area if the picture brightness is too low even with the max. level. This may be caused by dust buildup inside.

## OPERATING PRECAUTIONS

### Optimum viewing distance

10 to 23 feet is the range recommended for viewing comfort.

### Adjust room illumination

Excessively bright or dim lighting may strain your eyes. Draw the curtains if necessary to shut out direct sunlight.

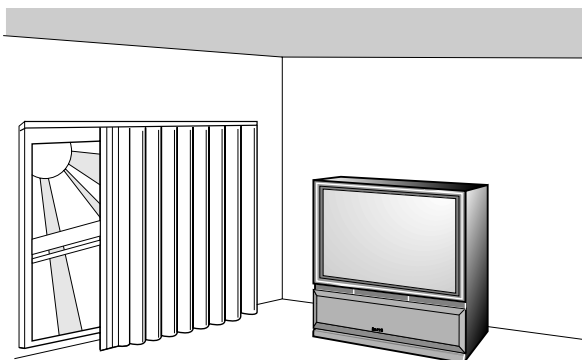

### Condensation and picture blurring

- If the room temperature suddenly rises (or if the Projection Monitor is moved from a cool place to a hot place), condensation may form on the lenses resulting in picture distortion or color fading. If this occurs, simply wait a while (with the power switch ON) and the condensation will disappear.
- A gradual change in temperature can prevent condensation from forming.

## HOW TO ATTACH THE PROVIDED PROTECTIVE SCREEN

**WE RECOMMEND ATTACHING THE PROTECTIVE SCREEN BEFORE USING THE MONITOR.**

To improve the image reproduction characteristics of the monitor and to protect the screen from damage or dust, attach the provided protective screen to the screen frame of the monitor following the given procedure.

If you decide not to install the protective screen, attach the upper and lower panel frames as indicated and attach the corresponding trim. If the protective screen is not being used, store it on a flat surface. Do not lean it against a wall, as it will become warped. Keep the microform cushion and cardboard container for screen storage. Please note that the monitor does not use the side frame covers when the protective screen is not attached to the monitor.

### PARTS INCLUDED FOR PROTECTIVE SCREEN INSTALLATION:

- 1 PROTECTIVE SCREEN WITH EDGE GUARDS
- 2 PANEL FRAMES (MOUNTS)
- 2 SIDE FRAME COVERS (TRIMS)
- 2 FRAME COVERS (TRIMS)
- 10 or 6 PANEL FRAME ATTACHING SCREWS (FASTENERS)  
(Screw quantity depend on model)

### HOW TO ATTACH UPPER AND LOWER TRIM ONLY

Attach upper and lower panel frames as indicated then follow step 5 on HOW TO ATTACH THE PROTECTIVE SCREEN.

<SIDE VIEW>

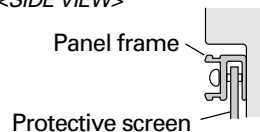

When the protective screen is attached.

<SIDE VIEW>

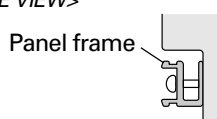

When the protective screen is not attached.

### CAUTION: BEFORE ATTACHING THE PROTECTIVE SCREEN

- Do not handle the screen by yourself. Have someone assist you when attaching or carrying the screen to prevent any accidents.
- Use a large-sized Phillips-head screwdriver for screwing and unscrewing fasteners.
- Handle the screen with care to avoid injury and to avoid leaving fingerprints on the screen surface.
- Carefully peel the vinyl covering from the front and back of the protective screen. Inspect the screen and brush off any plastic shavings or particles from the screen surface.

### HOW TO ATTACH THE PROTECTIVE SCREEN

1. Attach the lower panel frame to the monitor using five or three screws starting with the center screw. (Screw quantity depend on model.)

*Do not overtighten the screws.*

*Overtightened screws may cause the protective screen to warp.*

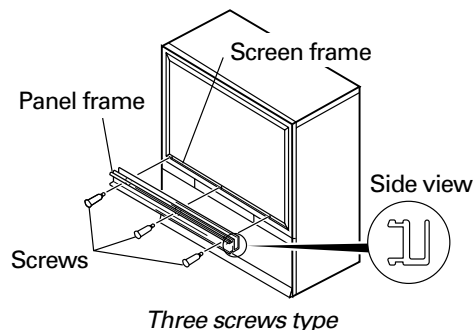
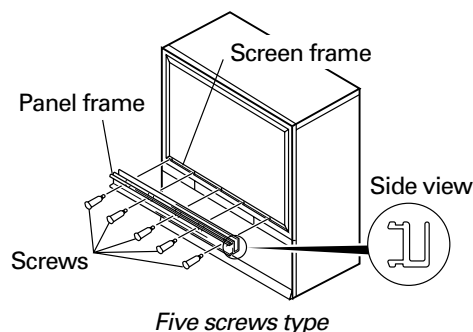

2. Insert the protective screen into the lower panel frame making sure the labeled side is to be front and the label is to be at the bottom left-hand corner.

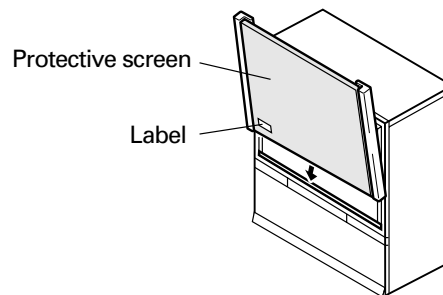

3. While holding the screen in place, attach the upper panel frame to the screen and fasten five or three screws starting with the center screw.  
*Do not overtighten the screws. Overtightened screws may cause the protective screen to warp.*

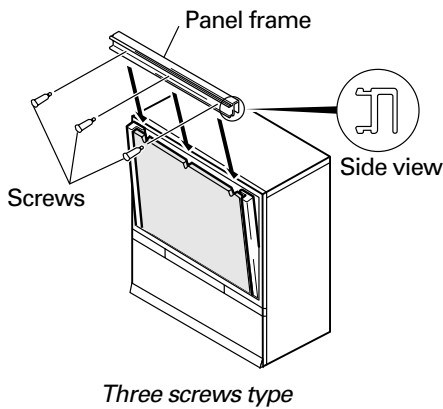
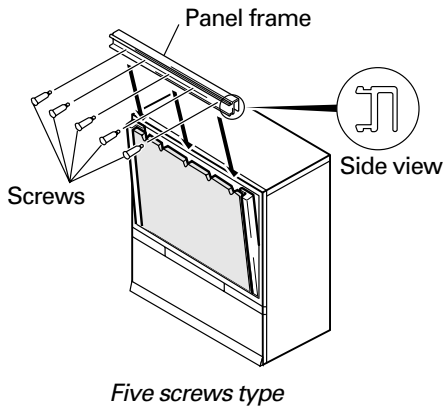

4. Attach side frame covers:
  - 1) Peel off adhesive strip from rear side of the frame cover.
  - 2) Attach side frame cover along the aluminium edge guards leaving a space of approximately 0 to 1/32 in. (0 to 1 mm) from the upper panel frame.

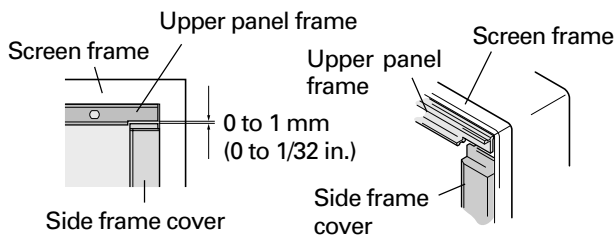

5. Attach the remaining frame covers to the upper and lower panel frames: first, insert the edge of the frame cover into the outer groove of the panel frame, then starting at one end, push the inner part of the frame cover over the inner edge of the panel frame snapping it into place.

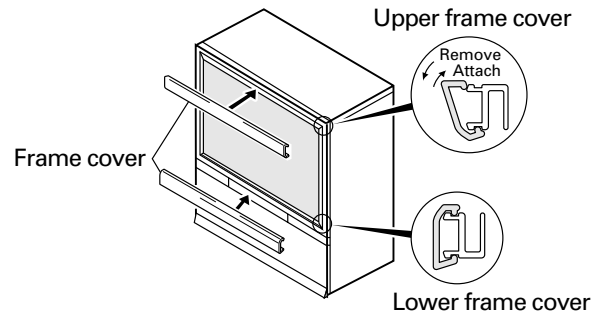

#### HOW TO REMOVE THE PROTECTIVE SCREEN

- 1) First, remove the frame covers only from the upper and lower panel frames. Care must be taken to avoid scratching the protective screen or frame covers.
- 2) Remove the screws from the upper panel frame and remove the upper panel frame.
- 3) Remove the protective screen from the lower panel frame and remove the lower panel frame. Reattach panel frames and frame covers as indicated in HOW TO ATTACH UPPER AND LOWER TRIM ONLY.

#### NOTES FOR CARE AND CLEANING OF SCREEN:

- Do not hit or throw anything onto the protective screen, as a damaged protective screen may cause injury.
- If the protective screen surface is dirty, wipe it with a cloth dipped in warm water with mild detergent and then wrung out. Wipe it dry with a soft, dry cloth.
- Never use paint thinner or other cleaners to clean the protective screen as they may contain harmful chemicals that will damage the finish of the screen.

# BEFORE USE

Before you watch the TV, perform the following procedure.

For viewing DTV broadcasts, the SH-D09 digital tuner (sold separately) is necessary.  
For connecting the digital tuner, see page 78.

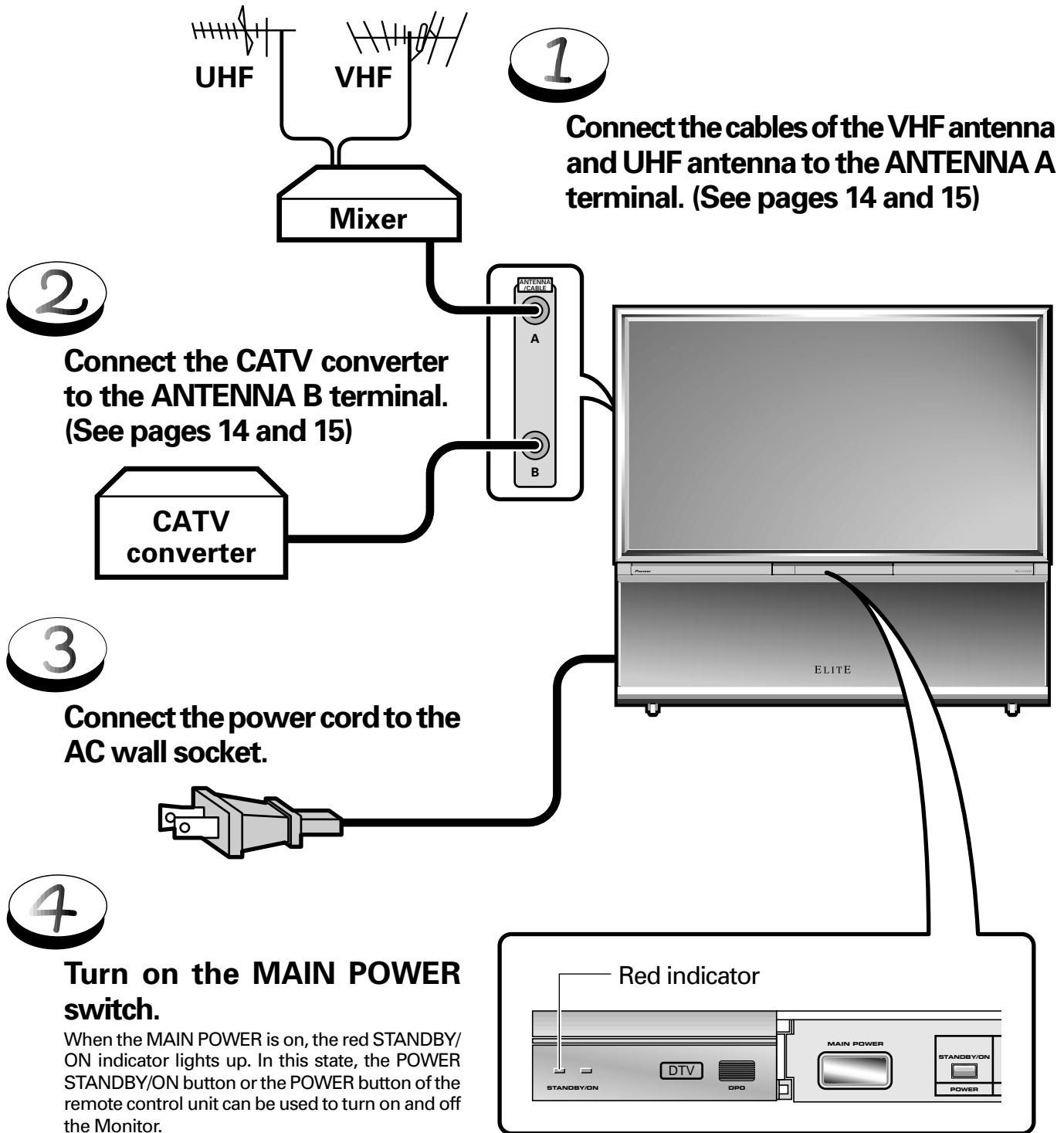

5

## Inserting batteries into the remote control unit

1.

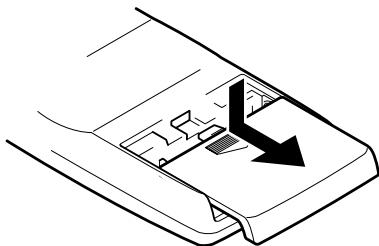

2.

Two DURACELL® 'AA' MN1500 1.5V  
ALKALINE dry cell batteries

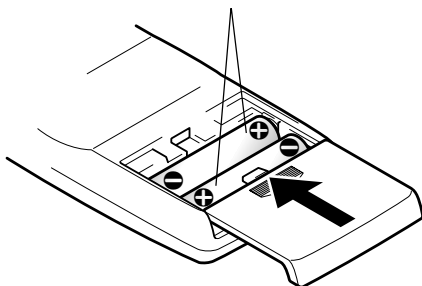

### ⚠ CAUTION

Incorrect use of batteries may lead to leakage or rupture. Always be sure to follow these instructions.

A.

Never mix new and used batteries.

B.

Batteries of the same size may have different voltages depending on their type. Do not mix different types of batteries.

### Remote control operation range

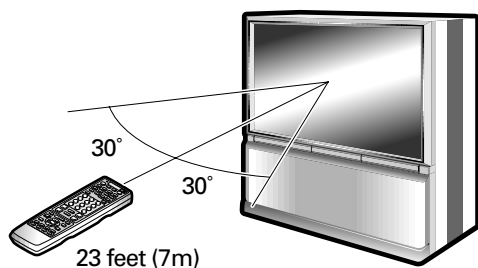

- Furniture and other obstacles may block the infrared light beam so that it cannot reach the sensor behind the Projection Monitor's screen.
- Performance of the remote control unit is adversely affected by strong fluorescent light. Keep such lights away from the screen in particular.

### Battery replacement

Replace the batteries when any of the following phenomena is observed.

- The transmitting LED does not blink even when the TV POWER button is pressed.
- The remote control operation range has reduced.

When replacing the batteries, prepare new batteries before removing the old batteries.

Be sure to close the battery case cover after battery replacement.

#### NOTE:

- Even when batteries are removed, learned commands remain in memory for about 15 minutes.
- If you remove the batteries, and press a button, the memory is erased in a few seconds.

# CONNECTING THE ANTENNA

- A good color picture depends on a good TV signal. So does good multichannel (stereo program and SAP) sound. Ask your dealer for advice on how to install your external antenna to receive the best possible signal.
- If you subscribe to Cable TV or have a central antenna for your building, you will not need an external antenna.

Connect the TV signal source to your Monitor properly. Use a 75-ohm coaxial cable with an F-type connector and connect the cable as shown in the illustration.

## Connecting VHF/UHF antenna

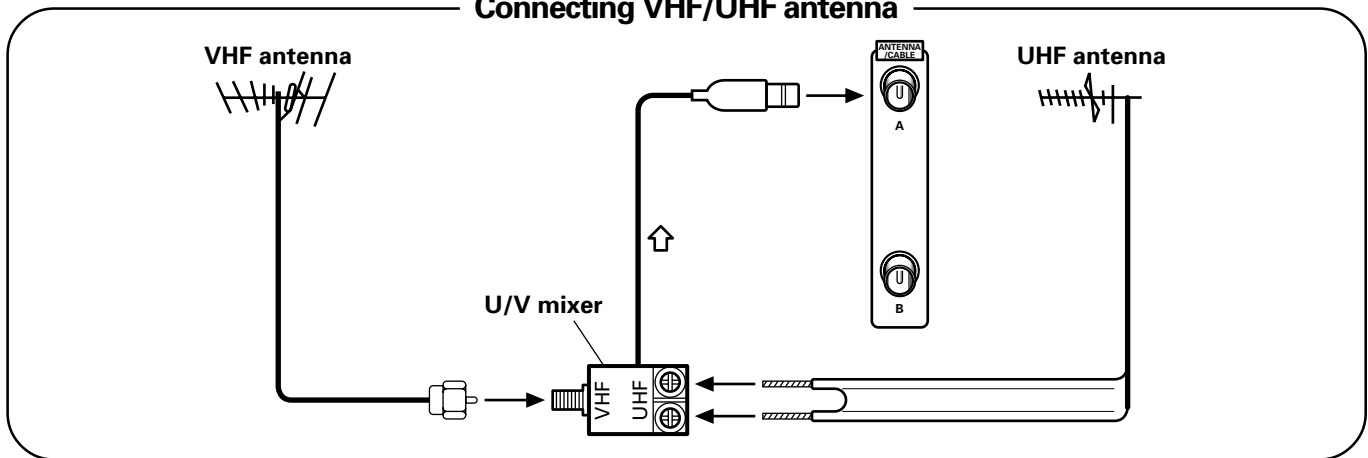

## Connecting VHF/UHF antenna with VCR

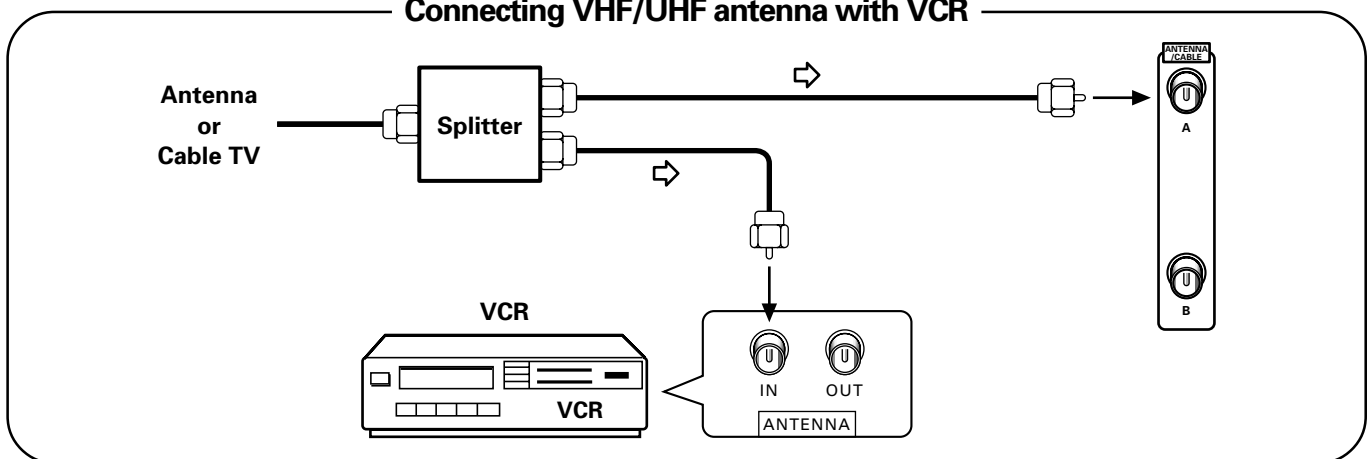

## Connecting the CATV converter

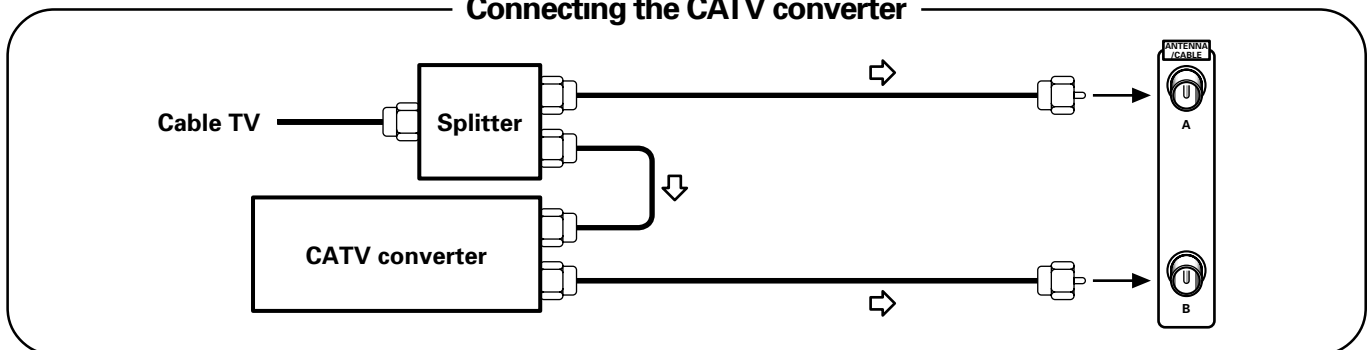

Connecting the CATV converter with VCR

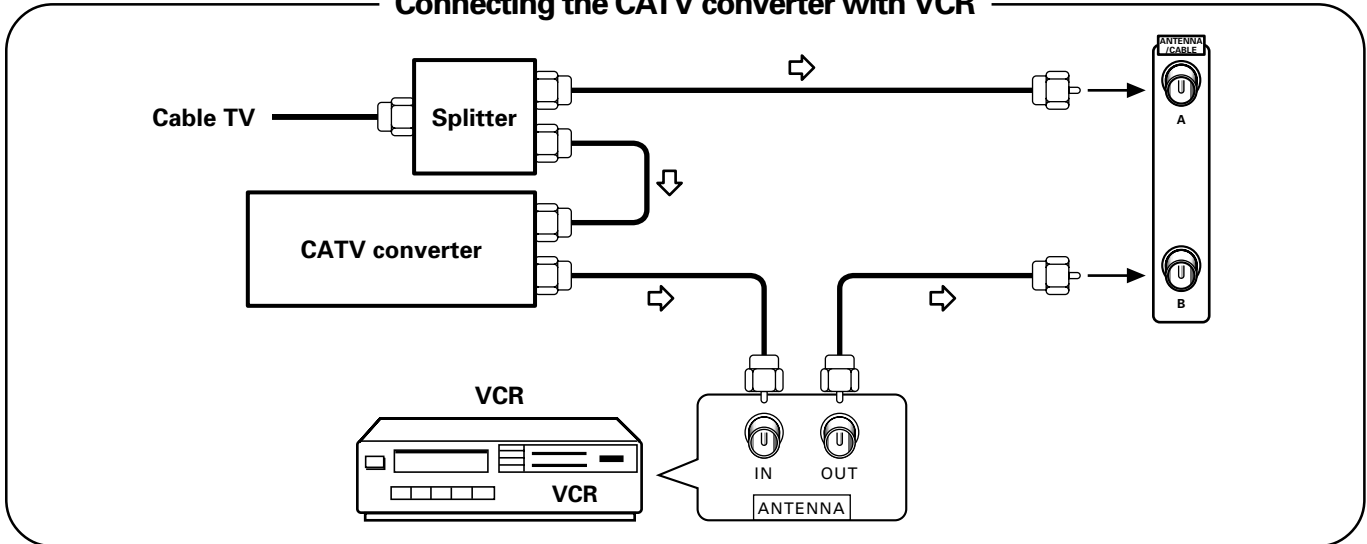

Connecting VHF/UHF antenna and CATV converter

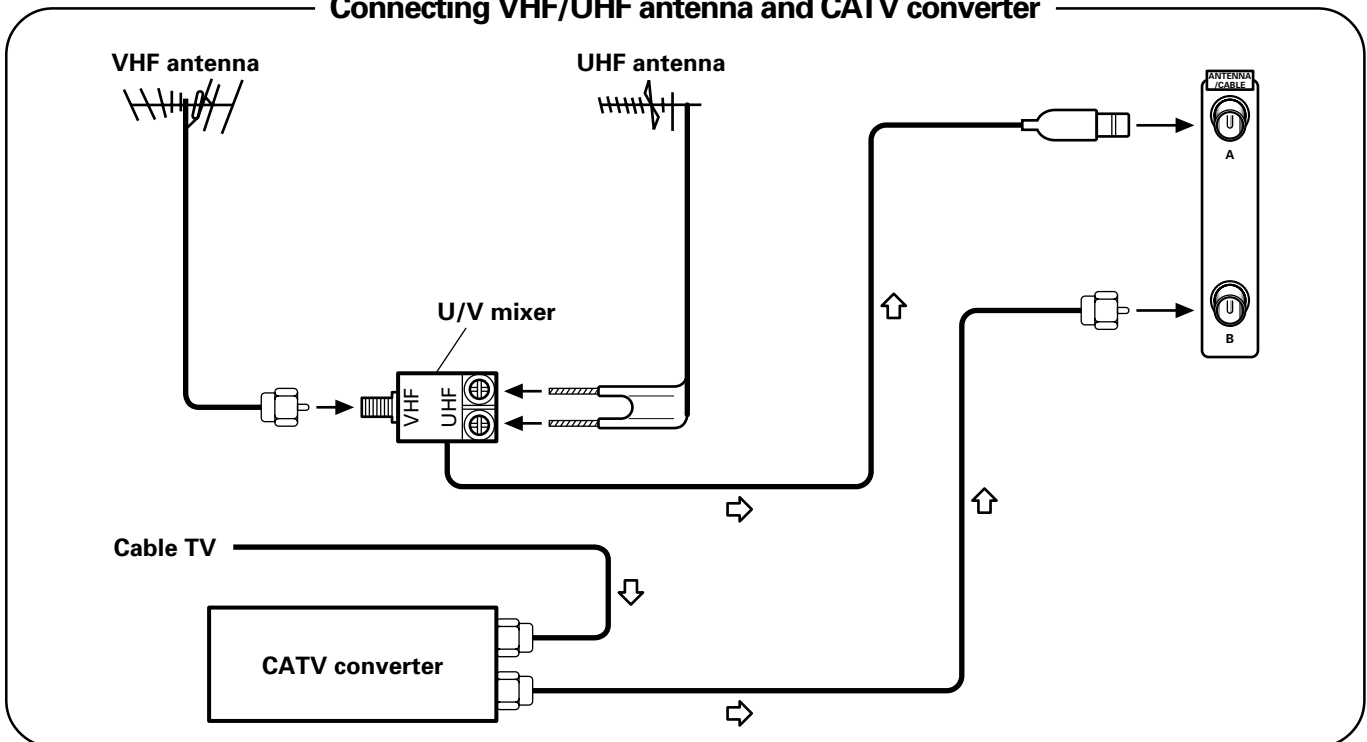

# CONNECTING VIDEO/AUDIO EQUIPMENT

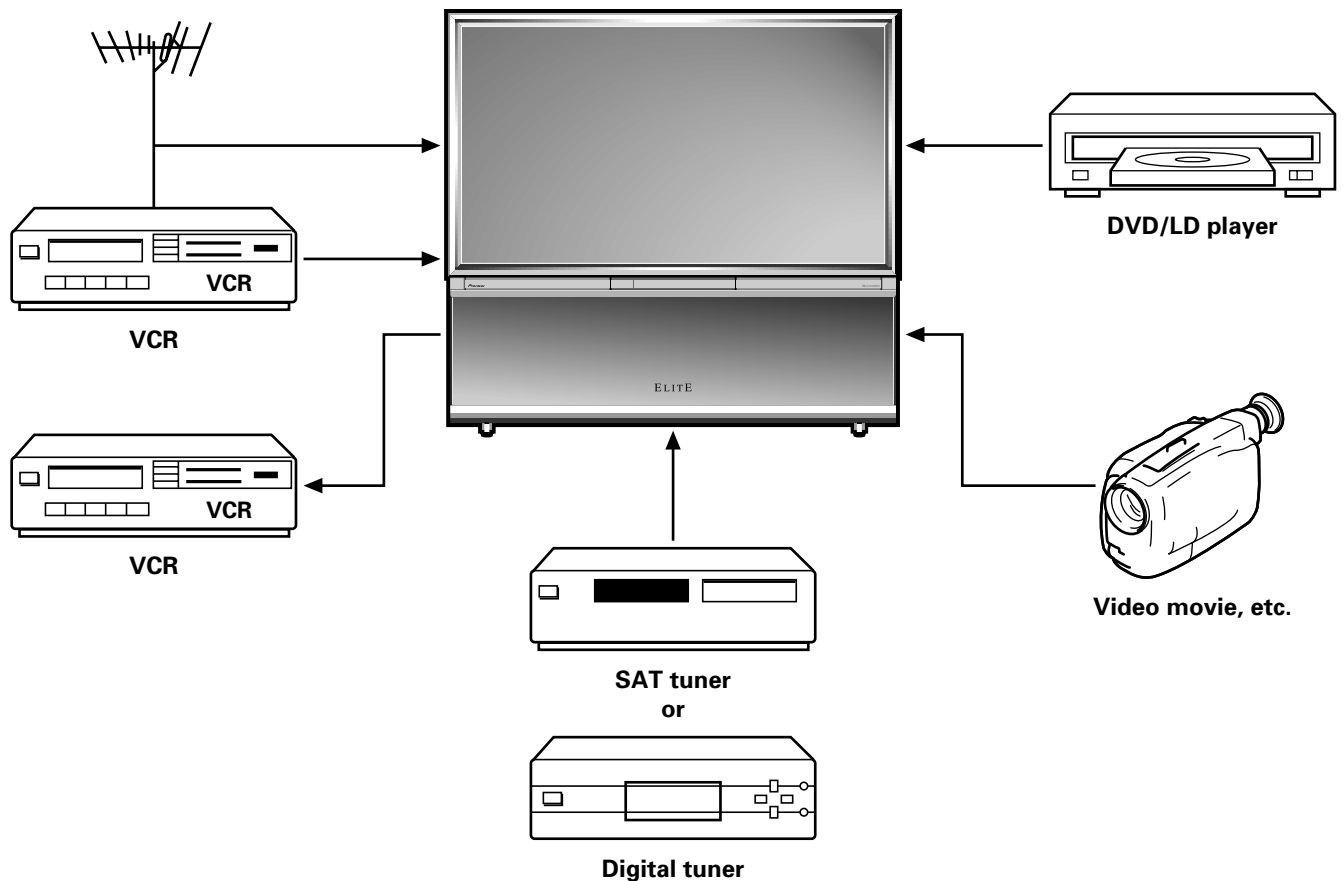

- Refer to the instructions of your VCR or DVD/LD player for the detailed connections.
- Before making or changing connections, set the power switch to off and unplug the power cord from the AC outlet.
- If both the VIDEO terminal (pin-jack type) and S-VIDEO terminal are connected, the signals from the S-VIDEO terminal will have priority.

- Only the INPUT 1 and INPUT 2 jacks can input the component video signal.
- When the component signal and other signals are input to the INPUT 1 or INPUT 2 jacks, the component signal will be given priority.



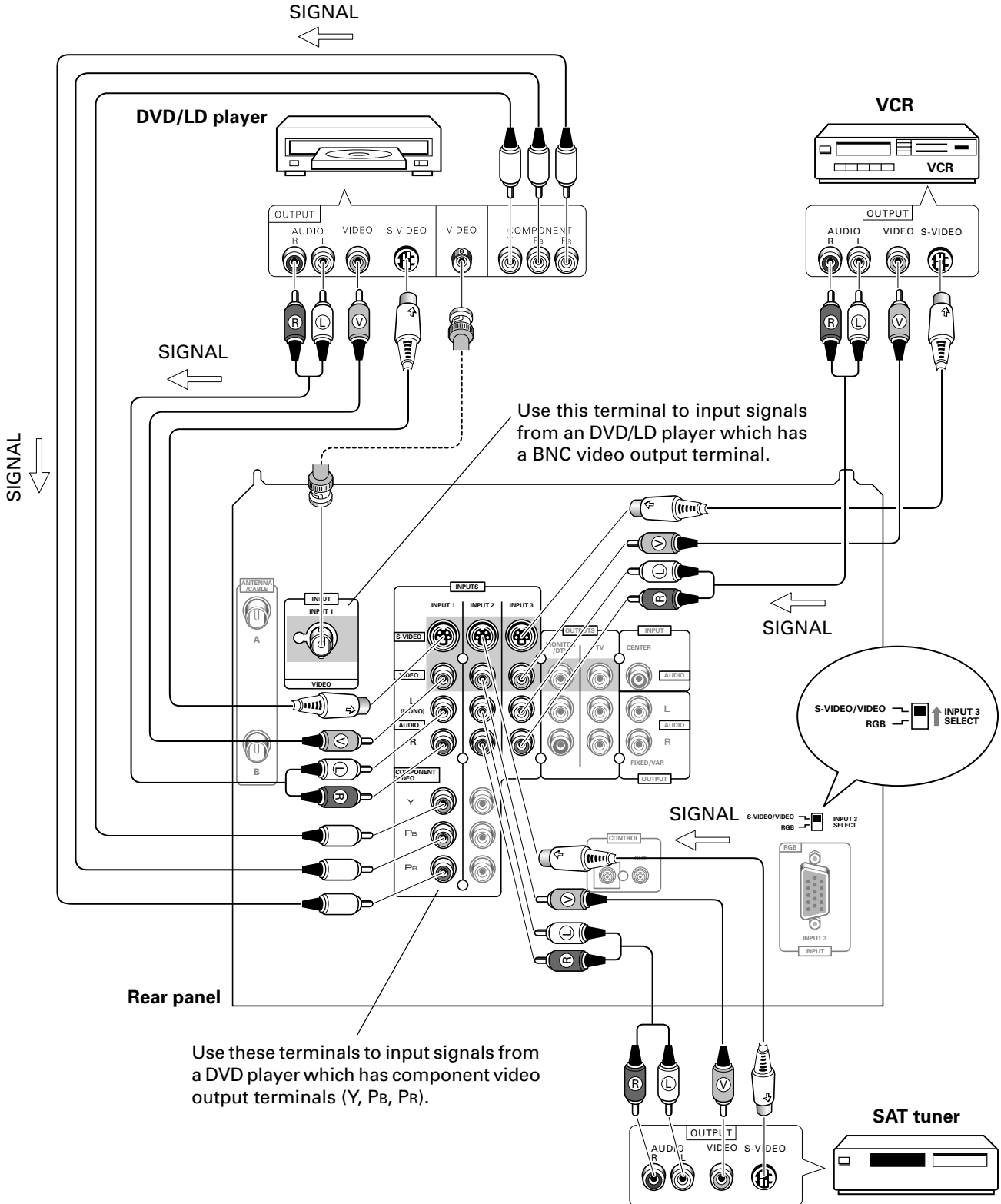

Use these terminals to input signals from a DVD player which has component video output terminals (Y, Pb, Pr).

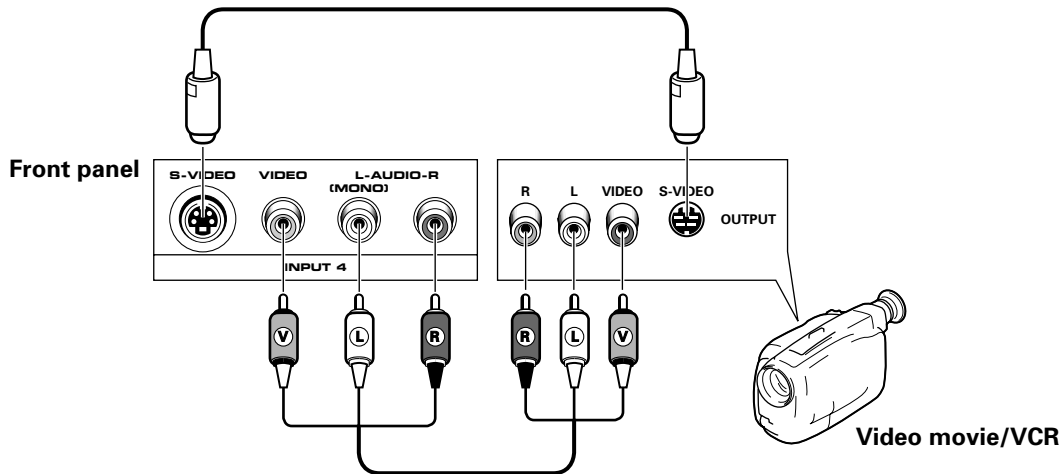

### INPUT jacks

There are 4 sets of inputs for VCR and DVD/LD players. Use RCA-type pin plug cords (the same as those used in Hi-Fi systems) for connections. When the audio source to be connected is monaural, connect the source to the L-(MONO) jack.

### MONITOR OUTPUT jacks

These are used for connecting the monitor to a VCR for recording, or for linking it to another monitor. These jacks output the video and audio signals of the source currently selected by the INPUT SELECTOR. Connect these output jacks to your VCR's inputs. Connect the VCR's outputs to the monitor's VIDEO inputs.

### S-VIDEO INPUT jacks

- Inputs S-VHS video signals or signals from a DVD/LD player that has an S-VIDEO output jack.
- When the signal input from the S-VIDEO INPUT jack is output from the MONITOR OUTPUT jack, the output signal will be a composite of Y and C.

### COMPONENT VIDEO INPUT jack

Inputs three signals – Y, P<sub>B</sub> (C<sub>B</sub>) and P<sub>R</sub> (C<sub>R</sub>) – output from DVD players and the like.

Input formats in which images can be received.

	Format	Horizontal frequency	Vertical frequency
DVD player, etc.	480 i	15.734 kHz	60 Hz
Digital tuner, etc.	1080 i	33.75 kHz	60 Hz
	480 p	31.468 kHz	60 Hz

### RGB INPUT jack

Inputs five signals – R, G, B, H and V – output from digital tuners and the like.

Input format in which images can be received.

	Format	Horizontal frequency	Vertical frequency
Digital tuner	1080 i	33.75 kHz	60 Hz

### NOTES:

- SPLIT screen, FREEZE screen and SEARCH screen functions cannot be used when 1080i or 480p component signals are input.
- Signals from MONITOR OUTPUT jacks will not be output when component signals or RGB signals are input.
- The RGB input jack is designed for use in connecting a digital tuner with RGB signal output, and it should accordingly never be used for connecting to a personal computer or other device.

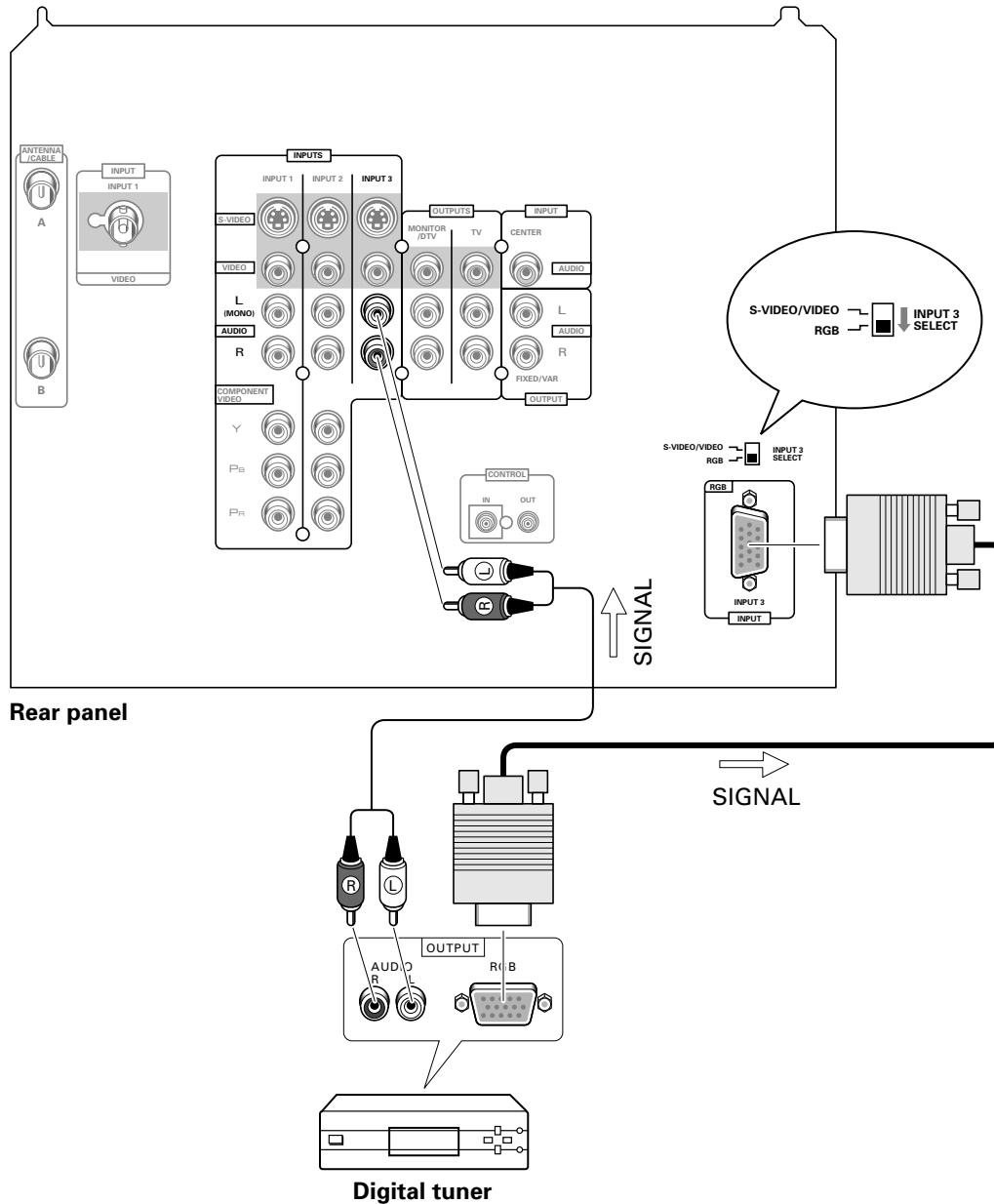

**NOTE:**  
 Setting the INPUT 3 SELECT switch to 'RGB' will cause all S-Video and composite images input from the INPUT 3 jack to be suppressed. Similarly, setting the INPUT 3 SELECT switch to 'S-VIDEO/VIDEO' will cause all images input from the RGB input jack to be suppressed.

# FRONT PANEL FUNCTIONS

A flip-down door conceals the control panel. Push gently and release, to open the door. To close the door, lift it back up into place.

**NOTE:**

If you accidentally pull the door, it may not shut properly. Push the door back in to shut it.

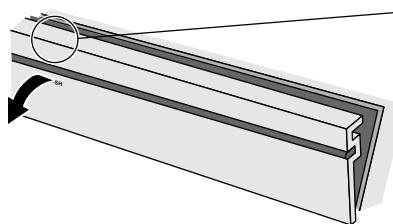
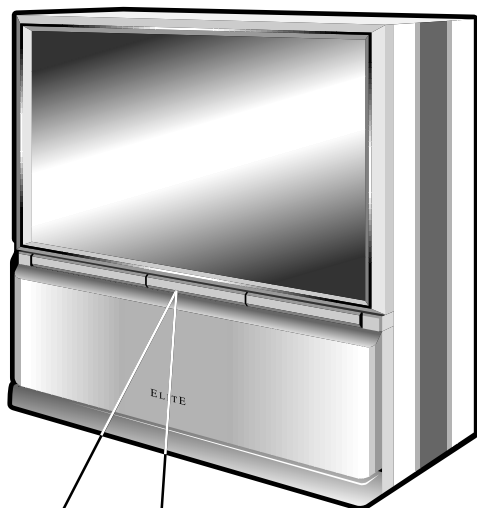

In some cases, the door may only open slightly when pushed. In such cases, open the door with your finger as shown in the figure at left.

① **POWER STANDBY/ON indicator**

red: STANDBY

green: ON

② **DTV indicator**

Lights when receiving a digital television broadcast.

If the SH-D09 digital tuner (sold separately) has been connected, the DTV indicator may still blink even when the power has been turned off. (This is not a defect.)

③ **DPO sensor**

Sensor to detect the room brightness.

④ **MAIN POWER switch**

Press once to turn on the main power (STANDBY mode). Press again to turn off the main power.

⑤ **POWER button (STANDBY/ON)**

Press once to turn on the Monitor. Press again to turn off the Monitor.

⑥ **INPUT SELECTOR button**

Press to select your program source. Each press of the INPUT SELECTOR changes the selection to the next source.

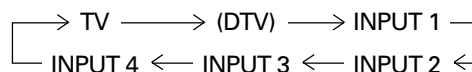

⑦ **CHANNEL buttons**

Press plus (+) or minus (-) to tune to a higher or lower channel. Only the preset channels can be tuned in using these buttons.

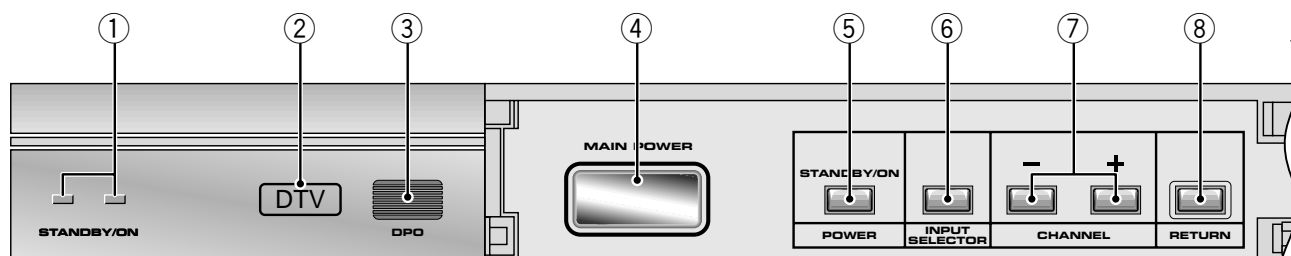

**⑧ RETURN button**

Press to set the Projection Monitor to its initial mode.

**Initial mode**

Input selector:	Set to TV.
TV channel:	Remains at the last channel set.
VOLUME:	Remains at the last setting.
MUTING:	OFF
PICTURE	
MODE:	STD
Parameters:	Set to 0.
3D Y/C LEVEL:	3
3D NR LEVEL:	3
COLOR TEMP:	STD
FLESH TONE:	ON
PURECINEMA:	HQ
SVM	HIGH
SOUND	
MTS:	MAIN
Parameters:	Set to 0.
SURROUND:	OFF
SUPER BASS:	OFF
SCREEN	
MODE:	NATURAL WIDE
V. POSITION:	Set to 0.
CC:	OFF
DPO:	OFF
SYSTEM IN/OUT	
SPEAKER:	NORMAL
AUDIO OUT:	FIXED
SYSTEM MODE:	OFF
DTV OUT:	OFF (When the SH-D09 is connected)

- When this button is pressed while adjusting the MULTI-POINT convergence, the MULTI-POINT convergence returns to the initial mode.

**⑨ VOLUME buttons**

Press plus (+) button to increase the volume, press minus (-) button to decrease it.

**⑩ INPUT 4 jacks**

These inputs are for Video Movie and VCR. Use RCA-type pin plug cords (the same as those used in Hi-Fi systems) and S-VIDEO cords for connections. When the audio source to be connected is monaural, connect the source to the L-(MONO) jack.

**CAUTION:**

Do not press any operation button on the Projection Monitor or the remote control unit while recording. Signals from the MONITOR OUTPUT jacks may be temporarily interrupted when a button is pressed.

**ATTENTION**

The Projection Monitor Receiver will not function properly in the following cases.

- An electrical discharge in the CRT.
- Lightning storms.
- High static electricity environment.
- Poor voltage regulation in the power source.

If the Projection Monitor does not operate properly, reset it as follows:

1. Turn off the power of the unit with the ④ MAIN POWER switch.
2. After approximately 1 minute, turn on the power with ④ MAIN POWER switch and ⑤ POWER button.

If the normal operation cannot be restored after the above treatment, immediately unplug the power cord and call your nearest PIONEER-authorized service center.

**NOTE:**

On rare occasions, an electrical discharge may occur inside the CRT. It makes a short, sharp pop and either no sound is produced or the volume level changes by itself. The SPLIT screen and SEARCH screen functions will be cancelled automatically if an electrical discharge occurs when this function is engaged.

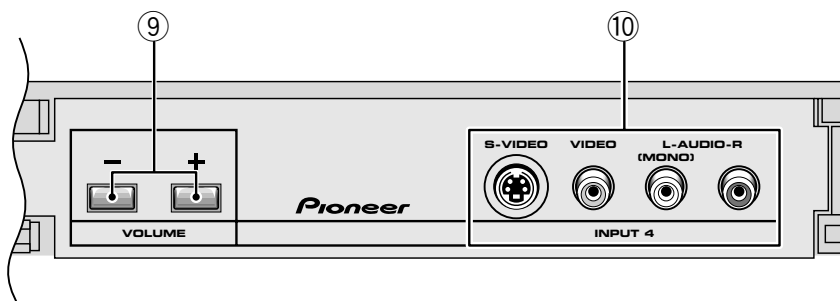

# REMOTE CONTROL UNIT FUNCTIONS

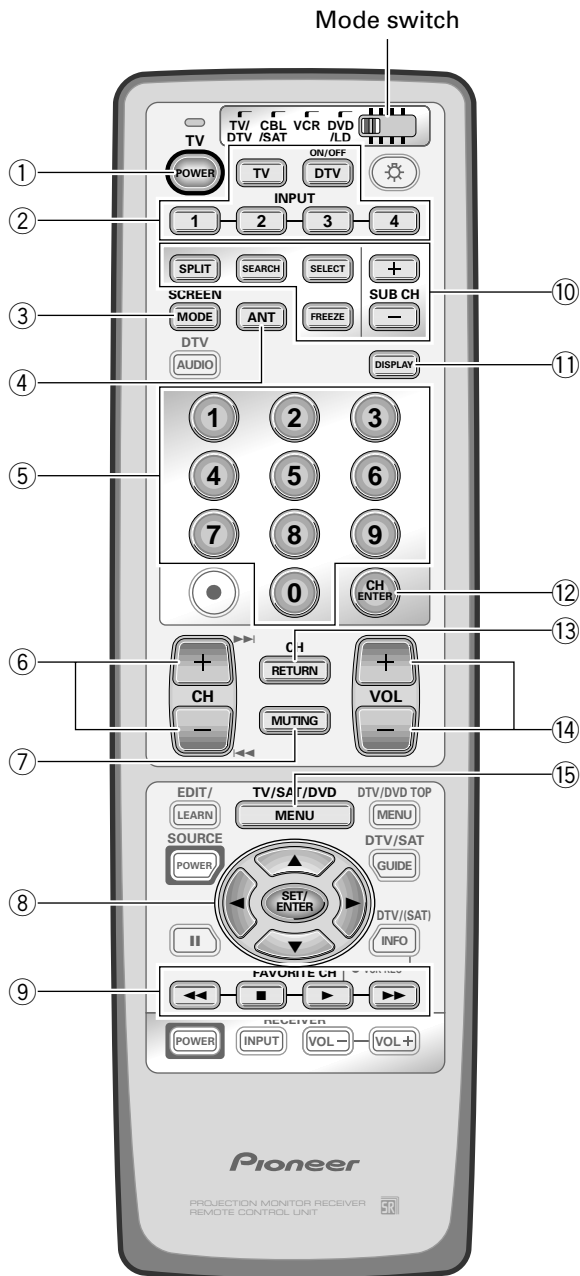

Set the mode switch to TV/DTV.

- ① **TV POWER button (STANDBY/ON)**  
Turns the power of the monitor on and off.
- ② **Input Selector buttons (TV, DTV\*<sup>1</sup>, INPUT 1 to INPUT 4)**  
Press the button to select the source you wish to watch. The screen will display your selection.
- ③ **SCREEN MODE button**  
Press to select the SCREEN MODE.
- ④ **ANT (antenna selector) button**  
Press to switch between ANTENNA-A and ANTENNA-B when you wish to watch TV.
- ⑤ **Direct channel selection buttons**  
Press the button (or buttons) that corresponds to the channel that you wish to watch.
- ⑥ **CH (channel) +, - button**  
Press plus (+) or minus (-) to tune in a higher or lower channel. Only the preset channels can be tuned in using these buttons.
- ⑦ **MUTING button**  
Press to temporarily turn off the sound. Press again to return to the previous volume level.
- ⑧ **Select/Adjust/Set buttons (SET/ENTER, ◀, ▶, ▲, ▼)**  
◀, ▶, ▲, ▼: Press to select or adjust items on the menu screen.  
SET/ENTER: Press to activate the selected function.
- ⑨ **FAVORITE CH buttons**  
These buttons call up the channels that have been assigned to them.

**⑩ SPLIT/SEARCH screen buttons**

- SPLIT:** Press to turn the SPLIT screen function on and off.
- SEARCH:** Press to select the SEARCH screen mode.
- SELECT:** Selects the screen for switching the channel or input source.\*2
- FREEZE:** When this button is pressed with the regular screen, the screen will change to the SPLIT screen and the picture at the time the button was pressed will become the sub-picture, displayed as a frozen image.
- SUB CH +, -:** Used to switch the channel for the sub-picture of the SPLIT screen.

**⑪ DISPLAY button**

Press to display the input source, channel, setting and other screen indicators for a few seconds.

**⑫ CH ENTER button**

Fix the selected channel with the direct channel selection buttons.

**⑬ CH RETURN (channel return) button**

Press to switch between the current channel and the channel you were watching immediately before.

**⑭ VOL (volume) +, – buttons**

Press plus (+) button to increase the volume, press minus (-) button to decrease it.  
Volume level will appear on the screen as numbers and a bar graph. The maximum volume level is "63".  
The display will disappear from the screen after 2 seconds.

**⑮ MENU button**

Press to turn on the menu screen for use in function selection.  
Press again to return to normal TV screen.

\*1 For viewing DTV broadcasts, the SH-D09 digital tuner (sold separately) is necessary.

\*2 With the 9-SEARCH screen, the search picture's input source and channel cannot be switched.

# TO WATCH TV

## Best Horizontal and Vertical Viewing Angle

- The optimum viewing angle is 140° in horizontal and 45° in vertical.
- Watch from at least 10 feet (3m) away from the screen (optimum viewing distance is 10 to 23 feet).

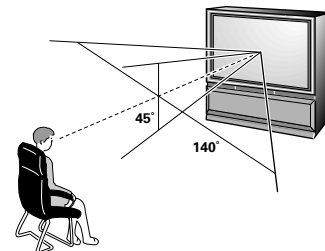

## Remote control unit



## Control panel of the monitor

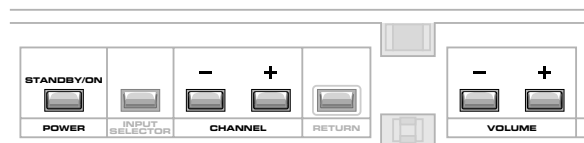

## Turn on the MAIN POWER switch.

### 1 Turn on the POWER.

The green STANDBY/ON indicator lights up.

Remote control unit

Control panel of the monitor



Green indicator

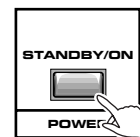

### 2 Set the mode switch to TV/DTV and then press the TV button.

Remote control unit

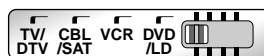

### 3 Select antenna A or B.

Check the input signals at the ANTENNA A and B terminals.

Remote control unit



ANT . A CH 2

### 4 Select a channel.

There are three methods for this.

#### ① Select by pressing the number button

(Example)

Channel 5 → **5** → **CH ENTER**  
 (Or press **0** and then press **5** within 2 seconds of during so.)

Channel 12 Press **1** and then press **2** within 2 seconds of during so. → **CH ENTER**

- After pressing a number button, even if you do not press the CH ENTER button, the channel will be switched to the one selected within 2 seconds.
- Depending on the channel, this switch may occur immediately after the number button is pressed.



	VHF L	MID		VHF H	SUPER	HYPER								UHF
TV	2-6	—		7-13	—	—								14-69
CATV	2-6 (STD)	A-5(95)	A(14)	7-13	J(23) Q(30)	W+1(37)	W+11(47)	W+21(57)	W+31(67)	W+41(77)	W+51(87)	W+61(102)	W+71(112)	W+81(122)
		A-4(96)	B(15)		K(24) R(31)	W+2(38)	W+12(48)	W+22(58)	W+32(68)	W+42(78)	W+52(88)	W+62(103)	W+72(113)	W+82(123)
		A-3(97)	C(16)		L(25) S(32)	W+3(39)	W+13(49)	W+23(59)	W+33(69)	W+43(79)	W+53(89)	W+63(104)	W+73(114)	W+83(124)
		A-2(98)	D(17)		M(26) T(33)	W+4(40)	W+14(50)	W+24(60)	W+34(70)	W+44(80)	W+54(90)	W+64(105)	W+74(115)	W+84(125)
		A-1(99)	E(18)		N(27) U(34)	W+5(41)	W+15(51)	W+25(61)	W+35(71)	W+45(81)	W+55(91)	W+65(106)	W+75(116)	
	1-6 (HRC) (IRC)		F(19)		O(28) V(35)	W+6(42)	W+16(52)	W+26(62)	W+36(72)	W+46(82)	W+56(92)	W+66(107)	W+76(117)	
			G(20)		P(29) W(36)	W+7(43)	W+17(53)	W+27(63)	W+37(73)	W+47(83)	W+57(93)	W+67(108)	W+77(118)	
			H(21)			W+8(44)	W+18(54)	W+28(64)	W+38(74)	W+48(84)	W+58(94)	W+68(109)	W+78(119)	
			I(22)			W+9(45)	W+19(55)	W+29(65)	W+39(75)	W+49(85)	W+59(100)	W+69(110)	W+79(120)	
							W+10(46)	W+20(56)	W+30(66)	W+40(76)	W+50(86)	W+60(101)	W+70(111)	W+80(121)

## CABLE (CATV) CHANNEL ASSIGNMENT TABLE

In the cable tuning mode, channels can only be assigned to numbers 01 to 125. The specific channel number assignments and the corresponding alphabet designation are shown at the bottom left of the channel table.

For example: Channel number '14' corresponds to midband cable channel 'A'.

### NOTE:

Cable (CATV) services can vary according to area. The channel number assignments shown in the channel table may not correspond with the channel numbers used by your local cable company. Direct tuning to cable channels without using the cable company converter 'or preselector' will depend on the specific channels in use by the cable company. Direct tuning to cable channels is limited to unencoded (unscrambled) channels only. Check with your local cable company for compatibility requirements.

## To turn off the sound

Press the MUTING button.



When mute is turned on, a volume indicator will appear in red on the screen (and will disappear in a few seconds).

If the MUTING button is pressed while a closed caption signal is being received, CC/TEXT will be displayed.

Press MUTING again to return to the previous volume level.

## Auto power off function

If the monitor is receiving no input signals in TV mode, its power will turn off (go on standby) after some time has passed.

### ② Select using the TV CH+/- button

The channels will switch according to the order set by channel preset (See page 28).

Remote control unit



Control panel of the monitor

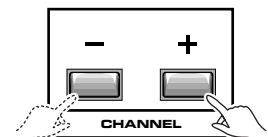

### ③ Select using the FAVORITE CH button

Select your desired channel from the 4 in the memory of each button: blue, green, red and yellow.

Remote control unit

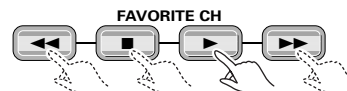

- Each time the button is pressed, the channel will be changed in order of the 4 channels in that button's memory.
- The desired channels can be set. (See page 46.)
- When you select a channel using the FAVORITE CH button, step 3 (Select antenna A or B) is not necessary.

## 5 Adjust the volume.

Remote control unit



Control panel of the monitor

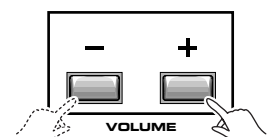

# CHECKING THE MENU

Press MENU on the remote control unit.  
 The MAIN MENU will be displayed on the screen.  
 Select the desired menu item using ▲ or ▼ button of the remote control unit, and press SET/ENTER button to perform the desired operations and settings.

- When the menu screen appears, the mode will switch from SCREEN to FULL. When all menu selections have been made, the previous screen mode will be restored.

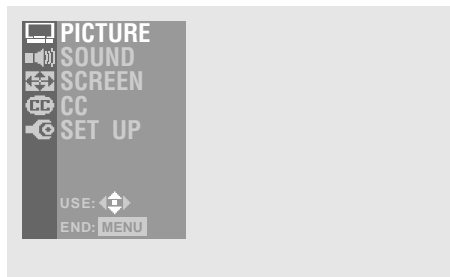
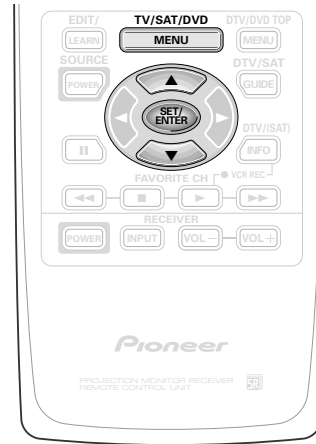

PICTURE adjustment menu (See page 48)

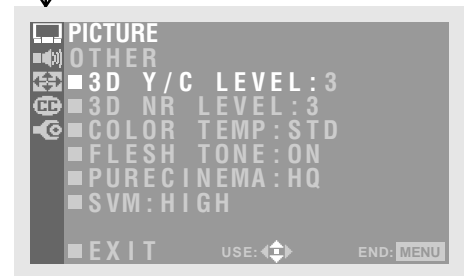
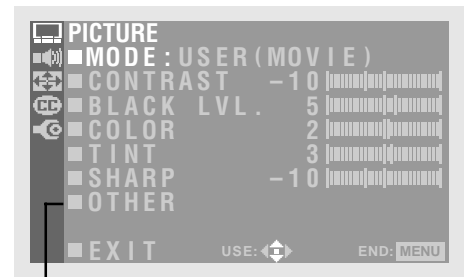

SOUND adjustment menu (See page 55)

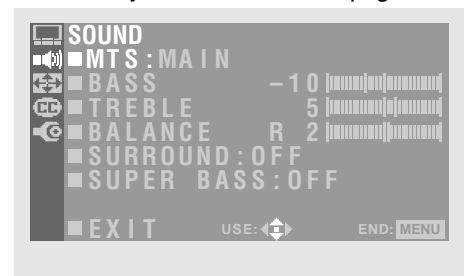
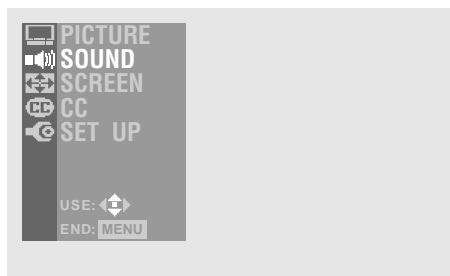
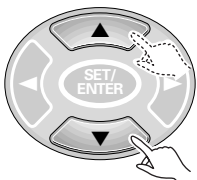

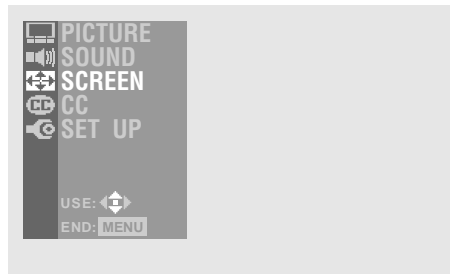
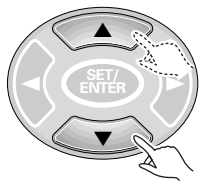

SCREEN setting menu (See page 39)

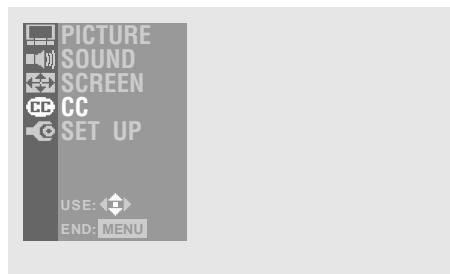
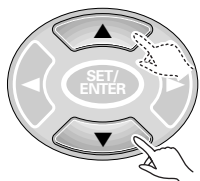

Closed Caption menu (See page 42)

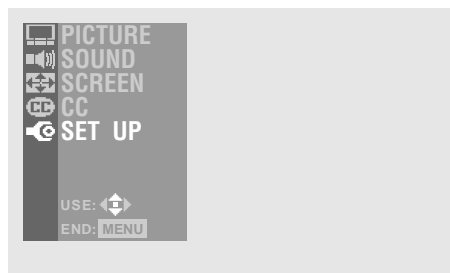
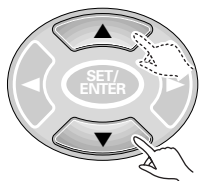
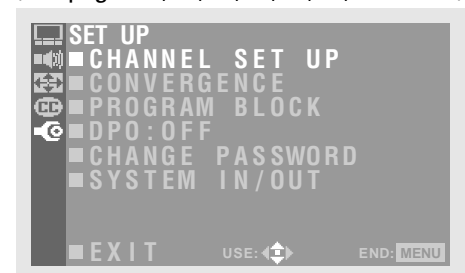
SET UP menu  
(See pages 28, 30, 33, 36, 43, 59, 62 and 83)**On screen indicators**

USE: Indicates in light cyan the buttons that can be used on the menu screen displayed.

END: End is for turning off the menu screen by pressing the MENU button.

EXIT: To return to the previous menu screen, use the ▲ or ▼ button to move to EXIT and then press SET/ENTER.

# AUTO CHANNEL PRESET

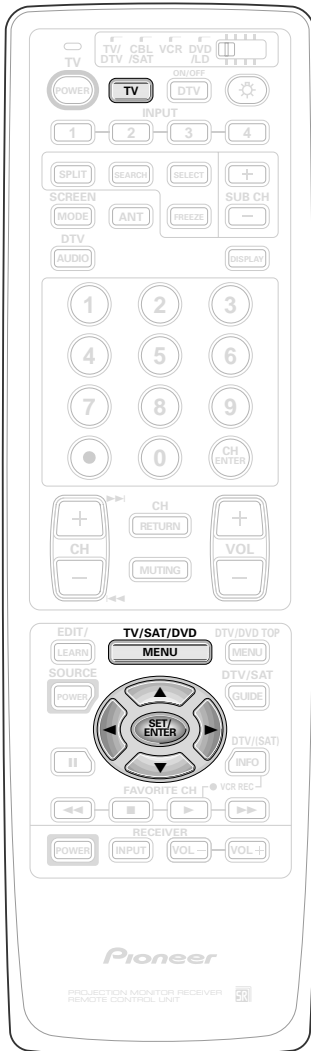

The broadcast frequencies that can be received depend on your area. Memorize the broadcast stations that can be received in your area in the preset.

## 1 Select TV.



## 2 Press MENU and select SET UP by using the ▲ or ▼ button and then pressing SET/ENTER. (Refer to page 26.)

## 3 Select CHANNEL SET UP in the same way.

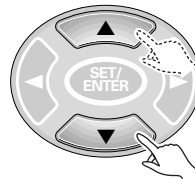

## 4 Select AUTO CHANNEL PRESET .

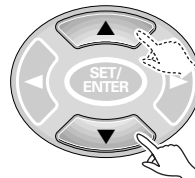

## 5 Select ANTENNA , then select A or B.

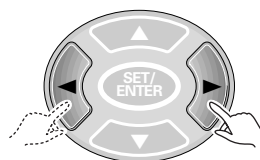
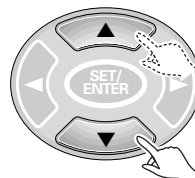

**NOTE:**  
The CHANNEL SET UP cannot be selected unless the function is set up for TV.

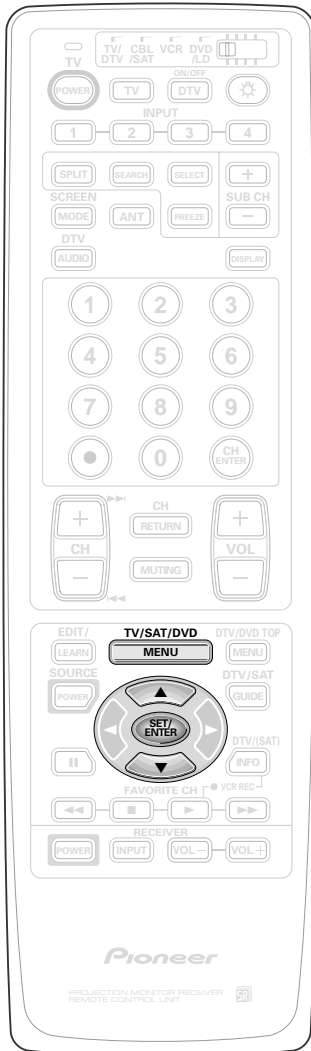

## 6 Select **TV/CABLE MODE** , then select the broadcast system to be received from **AIR, CATV STD, CATV HRC** or **CATV IRC**.

- Ask your dealer or cable service station for the mode of your local CATV system.

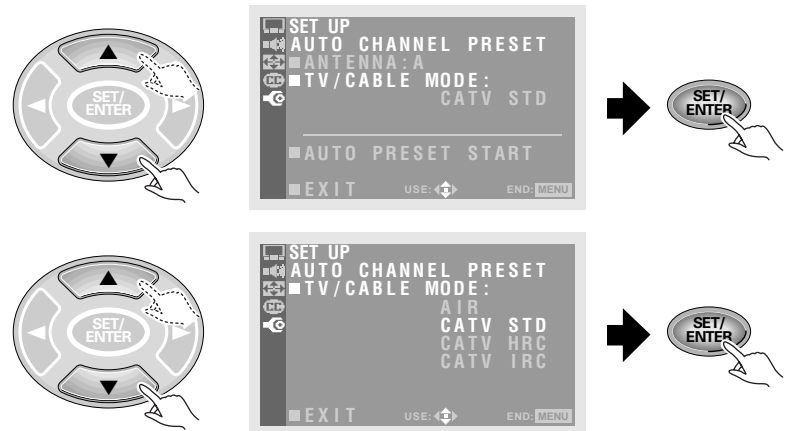

## 7 Select **AUTO PRESET START** .



- AUTO CHANNEL PRESET starts.

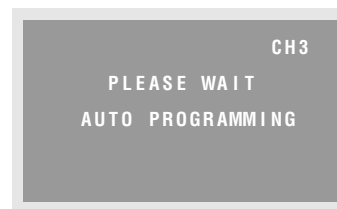

- When AUTO CHANNEL PRESET ends, the Monitor will return to step 5. Perform steps 5 to 7 if the other antenna is being used.

## 8 After setting, press **MENU** to turn the menu off.



**NOTE:**  
If **AUTO CHANNEL PRESET** is not performed, refer to the steps on page 43 and onwards to preset channels.

# CONVERGENCE ADJUSTMENT

Earth magnetism may deviate the color misconvergence in some areas. After setting up the TV, or if the picture color is misconverged, be sure to realign color convergence, after the TV has warmed up for 30 minutes or more.

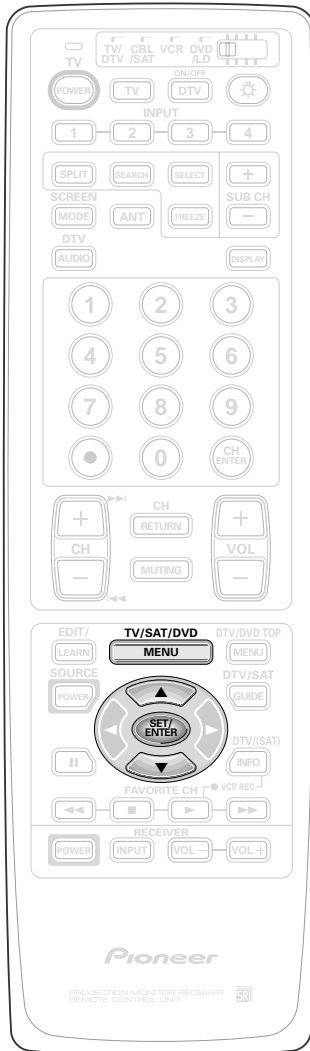

**1** Press **MENU** and select **SET UP** by using the **▲** or **▼** button and then pressing **SET/ENTER**. (Refer to page 26.)

**2** Select **CONVERGENCE** in the same way.

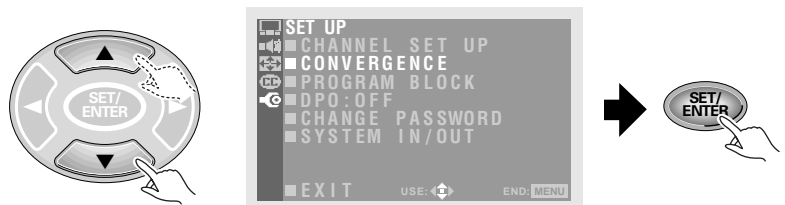

**3** Select screen mode.



- Center convergence adjustment will be accessed.

**When the cross pattern is white**

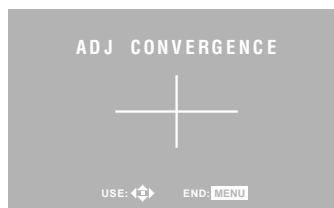

The color is converged. Press SET button twice, proceed onto page 60 and perform MULTI-POINT convergence.

**If the cross pattern shows other colors or when one side of the white line is red or blue**

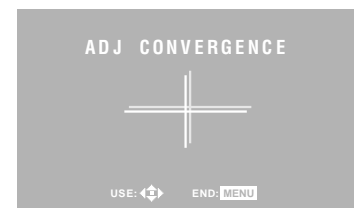

It indicates that the color is misconverged. Proceed onto step 4 and perform the adjustment.

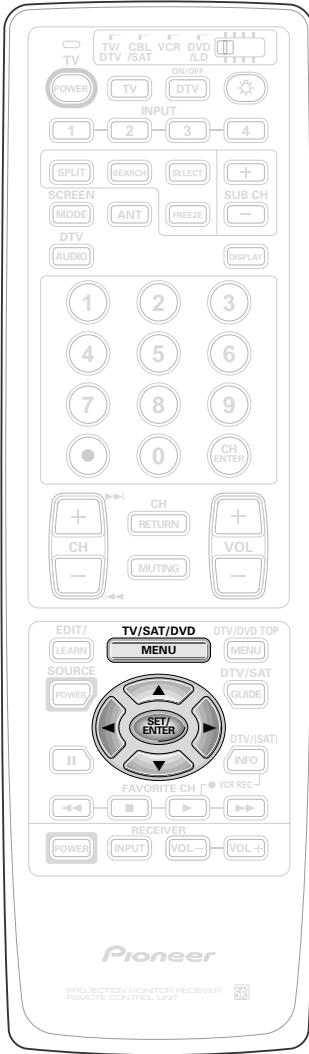

#### 4 Move the red line onto the green line.

Move the vertical line.

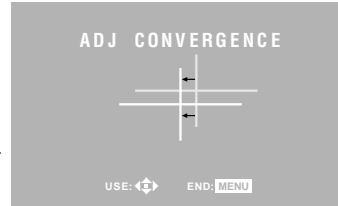
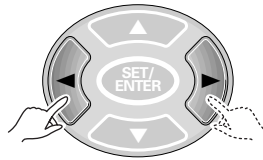

Move the horizontal line.

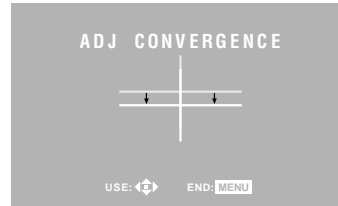
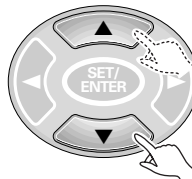

#### 5 Move the blue line onto the yellow line.

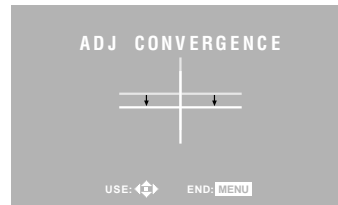
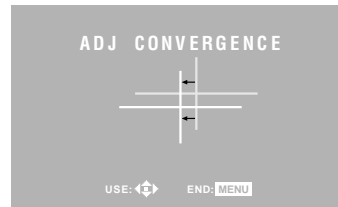
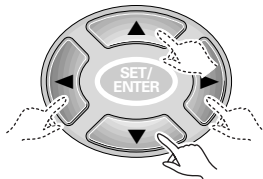

- When ADJ CENTER POINT is selected, center convergence adjustment will be accessed.
- Select ADJ MULTI-POINT to perform fine convergence tuning. See page 60 for further information on multi-point convergence adjustment.

#### 6 After completing the convergence adjustment, press MENU to turn the menu off.

# PROGRAM BLOCK (V. CHIP) FUNCTION

Since laws have been passed in the United States requiring a way of blocking undesirable programming, the V-chip has become a required component in television sets. The V-chip is a computer chip which decodes signals added to broadcast signals transmitted by television broadcasters. These signals are classified by programming content (e.g., amount of violence or sexual content) and age, and viewers may specify settings which block certain types of programming. Program blocking may be set to a specific level judged by parents to be harmful to children depending on their age or the content of the programming in question, and the V-chip makes it impossible for such children to view programs with ratings exceeding the specified level.

The V-chip uses the following rating system.

## MPAA RATING

RATING		
Age-Base	G	GENERAL AUDIENCES. All ages admitted.
	PG	PARENTAL GUIDANCE SUGGESTED. Some material may not be suitable for children.
	PG-13	PARENTAL STRONGLY CAUTIONED. Some material may be inappropriate for children under 13.
	R	RESTRICTED. Under 17 requires accompanying parent or adult guardian.
	NC-17	NO ONE 17 AND UNDER ADMITTED.
	X	X Rating is an older rating that is unified with NC-17 but may be encoded on older movie's data.
	NR	NOT RATED

## TV PARENTAL GUIDELINES

RATING		Description and Content Themes				
		FV	D	L	S	V
Age-Base	TV-Y	–	–	–	–	–
	TV-Y7	○	–	–	–	–
	TV-G	–	–	–	–	–
	TV-PG	–	○	○	○	○
	TV-14	–	○	○	○	○
	TV-MA	–	–	○	○	○

FV: Fantasy Violence  
D: Sexually Suggestive Dialog  
L: Adult Language  
S: Sexual Situations  
V: Violence

**TV-Y** All Children. This program is designed to be appropriate for all children.

**TV-Y7** Directed to Older Children. This program is designed for children age 7 and above.  
Note: For those programs where fantasy violence may be more intense or more combative than other programs in this category, such programs will be designated TV-Y7-FV.

**TV-G** General Audience. Most parents would find this program suitable for all ages.

**TV-PG** Parental Guidance Suggested. This program contains material that parents may find unsuitable for younger children.  
The program contains one or more of the following:  
(D) Some suggestive dialogue  
(L) Infrequent coarse language  
(V) Moderate violence  
(S) Some sexual situations

**TV-14** Parents Strongly Cautioned. This program contains some material that many parents would find unsuitable for children under 14 years of age.  
This program contains one or more of the following:  
(D) Intensely suggestive dialogue  
(L) Strong coarse language  
(S) Intense sexual situations  
(V) Intense violence

**TV-MA** Mature Audience Only. This program is specifically designed to be viewed by adults and therefore may be unsuitable for children under 17.  
This program contains one or more of the following:  
(L) Crude indecent language  
(S) Explicit sexual activity  
(V) Graphic violence



## SETTING THE PROGRAM BLOCKING LEVEL

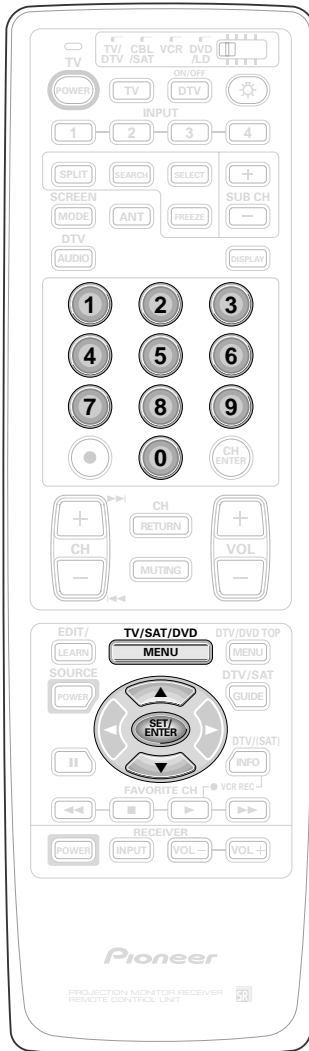

**1** Press **MENU** and select **SET UP** by using the **▲** or **▼** button and then pressing **SET/ENTER**. (Refer to page 26.)

**2** Select **PROGRAM BLOCK** in the same way.

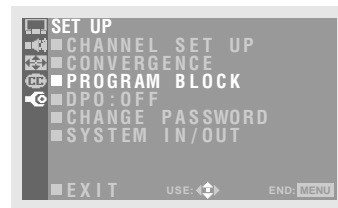
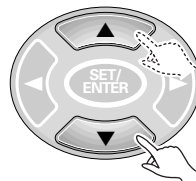

**3** Enter password.

- Press numeric buttons '0' through '9' to enter a four-digit password.
- If the password has not been changed as described in Changing Password (p. 36), enter the default password of '1234'.
- If you wish to change the password, see p. 36 Changing Password for instructions on how to do so.

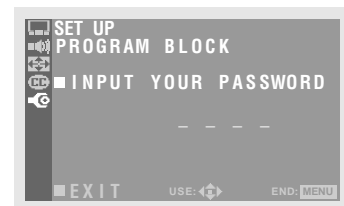
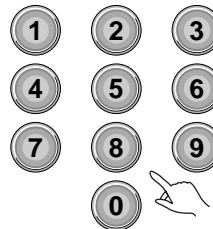

**4** Select **BLOCK**.

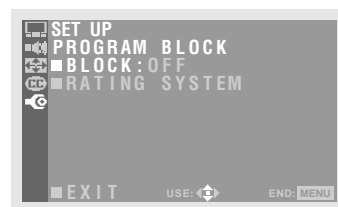
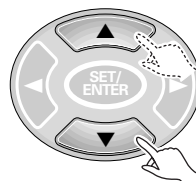

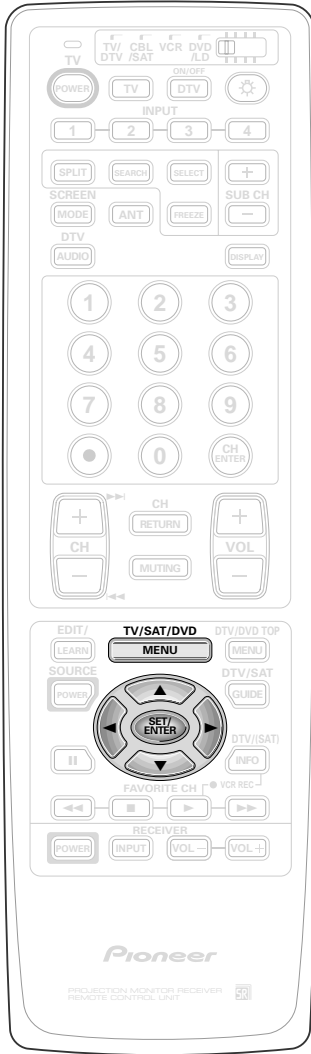

### 5 Set BLOCK to ON.

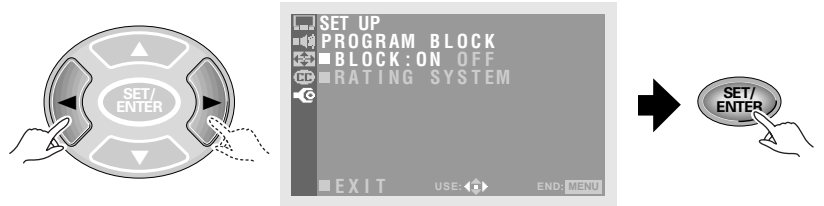

### 6 Select MPA A RATING or TV PARENTAL GUIDELINES .



### 7 Select and then confirm the rank of the MPA A RATING.

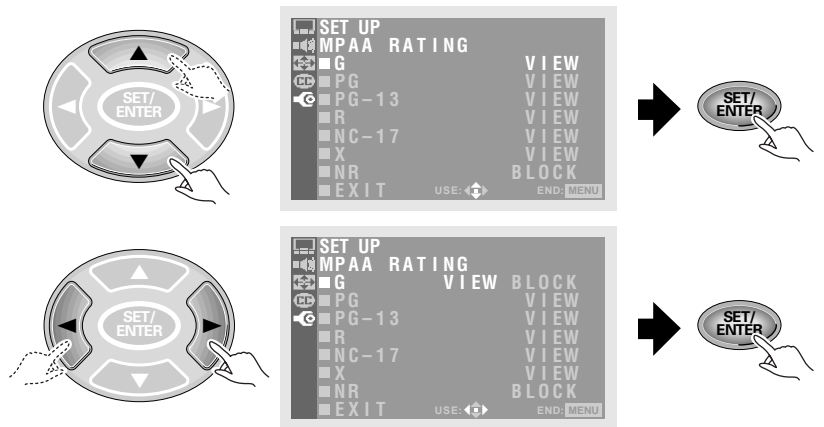

### 8 Select and confirm the rank of the TV PARENTAL GUIDELINES.



**NOTE:**

- Blocking programming with a low rating will cause all programming with a higher rating also to be blocked.
- The 'NR' (not rated) of the MPA A RATING may be set to 'View' or 'Block' without regarded to other ratings.

- Each time the SET/ENTER button is pressed, the setting will toggle between 'B' (Block) and 'V' (View).

## 9 After setting, press MENU to turn the menu off.



### HOW TO REMOVE BLOCKING FROM A PROGRAM IN PROGRESS

When a selected program or a program on a channel to which you have just changed has a rating higher than the current program blocking rating, the picture and sound will cut off and an enter password screen will appear.

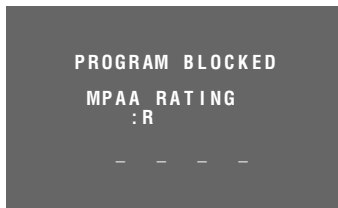

Once the password has been entered, blocking will be removed.

**NOTE:**

Even when a password has been entered to cancel a block, if the monitor power is turn OFF then turned ON again, the Program Blocked screen will appear.

### REMOVING BLOCKING IN MULTI-SCREEN MODE

- Just as in normal single-screen mode, programs are blocked in SPLIT screen and SEARCH screen mode (see pages 40 and 41), but blocking may be removed only from the Main picture. To remove blocking from a Sub picture or Search picture screen, switch to the Main picture for that channel and then remove blocking.
- When viewing in FREEZE screen (p. 40) mode, only programming on the Moving screen to the left will be blocked and the programming on the Still screen to the right will be displayed as is.

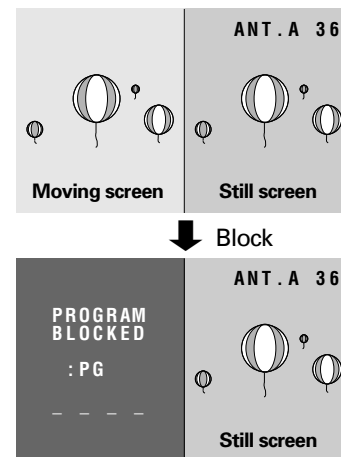

- When blocking is on during SEARCH screen mode, the screen at search picture side will be blocked out (mute) without displaying: "PROGRAM BLOCKED".

# CHANGING PASSWORD

A password must be entered to turn program blocking on and off. While the password is set to '1234' at shipping time, it is strongly recommended that the password be changed after purchase.

Note that this password is also used as the password required for the SH-D09 digital tuner (sold separately).

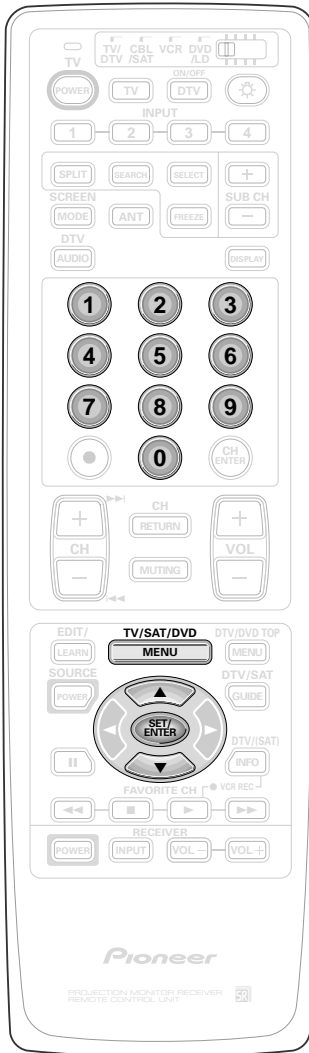

**1** Press **MENU** and select **SET UP** by using the **▲** or **▼** button and then pressing **SET/ENTER**. (Refer to page 26.)

**2** Select **CHANGE PASSWORD** in the same way.

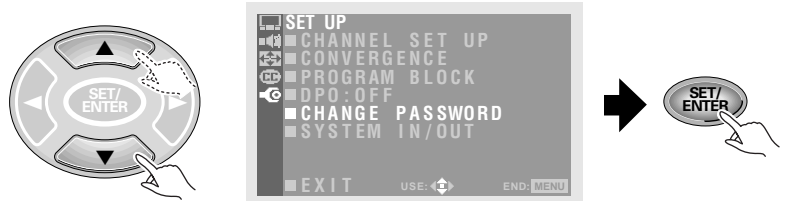

**3** Enter current password.

- Press numeric buttons '0' through '9' to enter a four-digit password.
- If no password has been set, enter the default password of '1234'.

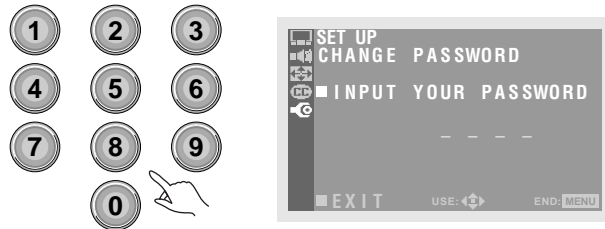

Cut along dotted line and file after reading.

## If you forget the password

When the message 'INPUT YOUR PASSWORD' shown in step 3 is displayed, press the RETURN button on the front panel and hold it down for 3 seconds or longer. The password will become "1234".

PRO-610HD PRO-510HD

PROGRAM BLOCK password No.

--	--	--	--

## 4 Enter new password.

- Press numeric buttons '0' through '9' to enter a four-digit password and press the SET/ENTER button.



## 5 After setting, press MENU to turn the menu off.



# CHANGING SCREEN SIZE

## SETTING SCREEN MODE

The size of the picture or the picture's range projected on the screen can be changed between five screen sizes.

### Press the SCREEN MODE button.

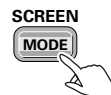

- Each time the SCREEN MODE button is pressed, the mode changes in the following order.

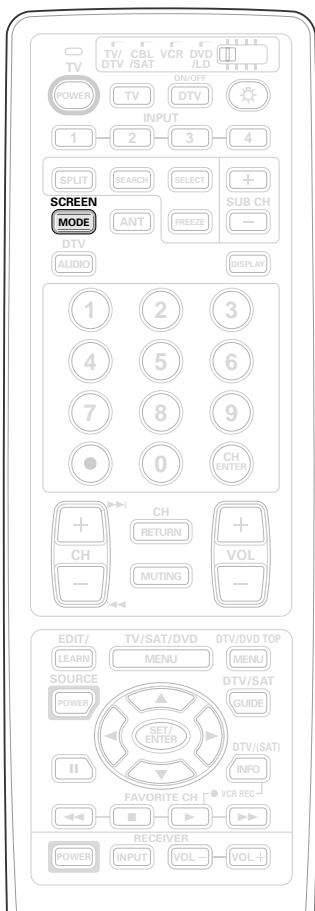
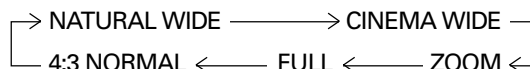

#### NATURAL WIDE

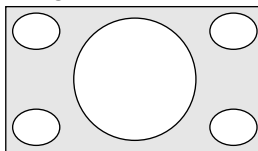

Suitable for when viewing news or sports programs. Movies or sports programs can be viewed with an expansive powerful image.

#### CINEMA WIDE

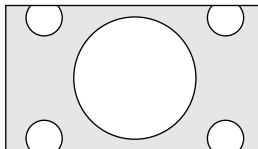

Mainly suitable for viewing Vista size and other such movie images. Provides a more expansive, powerful image. This screen size is convenient when viewing a Cinemascope size image that has subtitles.

#### ZOOM

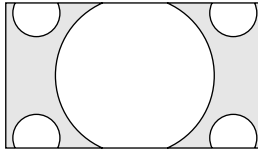

Mainly suitable for viewing Cinemascope size and other such movie images. Provides a more expansive, powerful image.

#### FULL

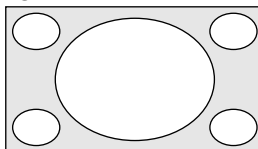

Suitable for wide screen images.

#### 4:3 NORMAL

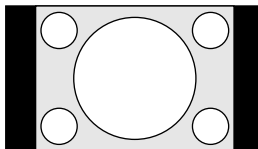

Suitable for when viewing news or sit coms. The video software can be viewed in its original screen frame size.

#### NOTES:

- This Monitor is provided with modes to deal with screens of various aspect ratios. It is recommended that programs and software be watched in the appropriate mode.
- When 4:3 images are fully displayed on a wide TV screen in the NATURAL WIDE mode, CINEMA WIDE mode, ZOOM mode, or FULL mode, some parts of the images may be cut off or distorted.
- When 1080i or 480p component signals or RGB signals are input, SCREEN MODE will be limited to FULL.
- For watching a DTV broadcast, see the SH-D09 digital tuner (sold separately) operating instructions for SCREEN MODE.
- Continuous operation for extended periods in 4:3 NORMAL mode may burn out the screen. We thus recommend that this mode be used only in conjunction with another SCREEN mode.

## TO ADJUST THE SCREEN POSITION

In the CINEMA WIDE or ZOOM mode, the screen position can be adjusted to the top or bottom.

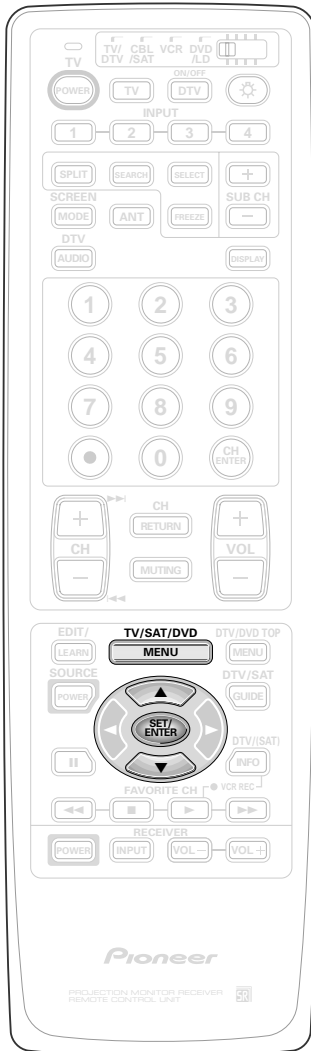

**1** Press **MENU** and select **SCREEN** by using the **▲** or **▼** button and then pressing **SET/ENTER**. (Refer to page 26.)

**2** Select **V. POSITION** in the same way.

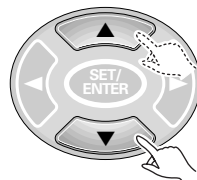

**3** Adjust the screen position.

- Adjustable range  
 CINEMA WIDE mode : -15 to 15  
 ZOOM mode : -25 to 25

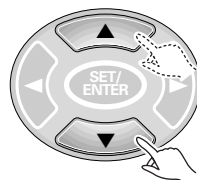

**4** After adjusting, press **MENU** to turn the menu off.



**NOTE:**  
 Screen position cannot be adjusted in **NATURAL WIDE**, **FULL**, or **4:3 NORMAL** mode.

# MULTI-SCREEN FUNCTION

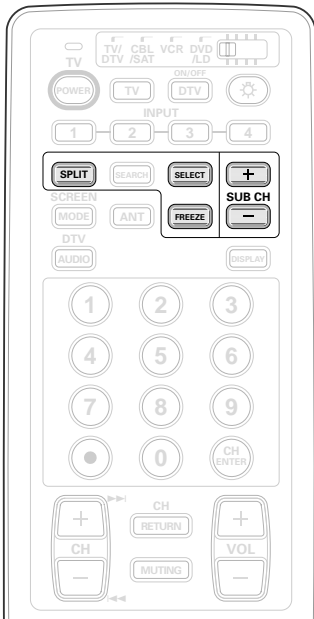

## VIEWING TWO SCREENS (SPLIT screen)

The screen can be split vertically, making it possible to view different images on the left and right.

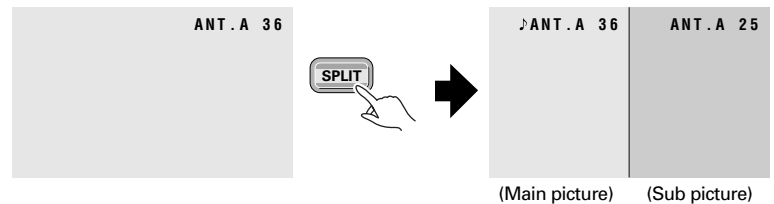

### Press the SPLIT button.



- The screen on which  is displayed is the main picture, and the other screen is the sub-picture. Sound will be output for the main picture.
- Regular operations can be performed on the main picture.
- When the SUB CH +/- buttons are pressed, the channel for the sub-picture will be changed.
- When the SELECT button is pressed, the  will move to the other screen.
- The MONITOR OUTPUT terminal outputs the main picture signal.
- Pressing the SPLIT button again will restore the original screen.

## MAKING NOTES ON PROGRAM CONTENT (FREEZE screen)

The screen can be frozen, such as for taking down a recipe from a cooking program or an address for entering a quiz or the like.

### Press the FREEZE button.

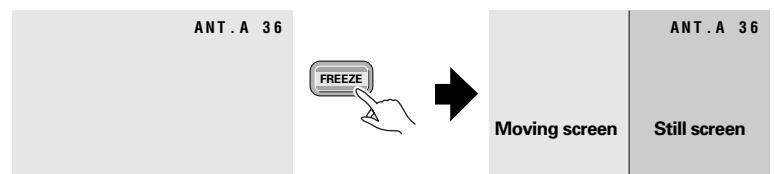

- This function is operable only with the normal screen.
- Pressing the FREEZE button again will restore the original screen.

#### NOTES:

- The same image cannot be viewed as both the main picture and the sub-picture.
- Pressing the MENU button in SPLIT or FREEZE screen mode restores the screen display to normal and displays the menu on screen.
- These functions cannot be used while watching a DTV broadcast using the SH-D09 digital tuner (sold separately).
- These functions cannot be used when INPUT 1 or INPUT 2 is receiving a 1080i or 480p component signal (or the signals might not be received or noise might be generated).
- When a TV broadcast is being received, the screen on the right will not show the antenna B signal.
- RGB signals input from INPUT3 cannot be displayed.
- Continuous operation for extended periods in SPLIT or FREEZE screen mode may burn out the screen. We thus recommend that these modes only be used in conjunction with the normal screen mode.
- If the non-interlace signal for a TV game etc. is entered to the left screen during SPLIT screen mode, the right screen may be disrupted. If this occurs, use the right screen for TV game etc. entry.



## SEARCHING FOR A PROGRAM ON A DIFFERENT CHANNEL (SEARCH screen)

The screen on the right side can be made into nine or three different screens, making it possible to search for programs or enjoy multiple images.

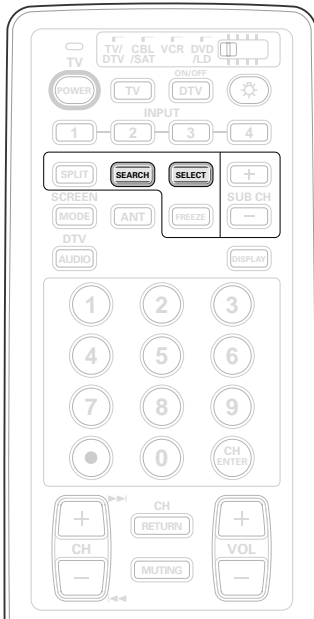

### Press the SEARCH button.



- Each time the SEARCH button is pressed, the screen mode changes in the following order.

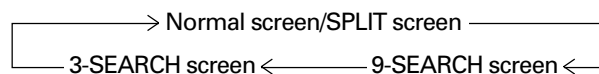

#### ① 9-SEARCH screen

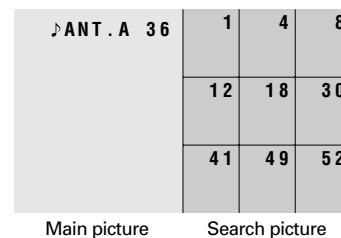

- On the search picture, the antenna A preset channel (see page 28) will be displayed as a frozen image. If 9 or more channels have been preset, the screens will automatically be switched and displayed.
- The search picture cannot be operated.
- If the channel or input source is changed, SEARCH screen mode will turn off.

#### ② 3-SEARCH screen



- Press the SELECT button to select image that you wish to switch the channel or input source to. When the color of the channel or input indicator changes to yellow, screen operations can be performed. (Use only the selector buttons, direct channel selection buttons and CH +/- buttons.)
- Sound output is limited to the main picture.

- Pressing the MENU button in SEARCH screen mode restores the screen display to normal and displays the menu on screen.
- These functions cannot be used while watching a DTV broadcast using the SH-D09 digital tuner (sold separately).
- These functions cannot be used when INPUT 1 or INPUT 2 is receiving a 1080i or 480p component signal (or the signals might not be received or noise might be generated).
- RGB signals input from INPUT3 cannot be displayed.
- Continuous operation for extended periods in SEARCH screen mode may burn out the screen. We thus recommend that these modes only be used in conjunction with the normal screen mode.
- The only channels displayed on the SEARCH screen will be those with input signals input from antenna A. Antenna B channels cannot be displayed on this screen.
- If the non-interlace signal for a TV game etc. is entered to the left screen during 9-SEARCH screen or 3-SEARCH screen modes, the screen may be disrupted.

# CLOSED CAPTION DECODE FUNCTION

The closed caption broadcasting multiplexes caption signals (character information) in the video signal to allow the displaying of characters on the screen. This unit incorporates a closed caption decoder which allows, with the use of the remote control unit, to display character information when receiving character-multiplexed broadcasting signals (closed caption broadcasting) or playing a video cassette or Video Disc with the  mark etc..

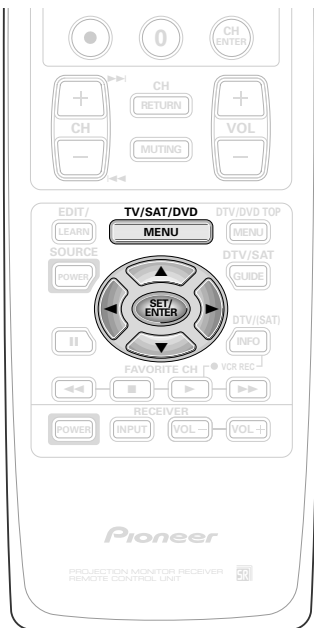

**1** Press **MENU** and select **CC** by using the **▲** or **▼** button and then pressing **SET/ENTER**. (Refer to page 26.)

**2** Select **CC** in the same way.



**3** Set **CC** to **ON**.



**4** Select **MODE**.



**5** Select the desired **CC** (Closed Caption **CC-1** to **CC-4**) or **TEXT** (**TEXT-1** to **TEXT-4**).

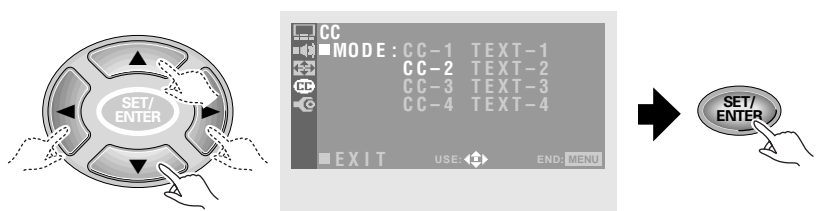

**6** After setting, press **MENU** to turn the menu off.



## NOTES:

- When a video cassette or Video Disc carrying the  mark etc. is played, the closed caption signal may not be output depending on the VCR or Video disc player.
- During TV broadcast reception, closed caption signal may not be decoded properly if the receiving broadcast signal is weak.
- Closed caption signal may not be decoded properly depending on the recording condition of the video cassette tape.
- The character information will not be displayed while the menu is displayed. To turn on the character information, press the **MENU** button and turn off the **MENU**.
- This function cannot be used when 1080i or 480p component signals are input.
- When closed caption is turned on for watching a DTV broadcast (sold separately), closed caption mode will be fixed to **CC-1**.

# CHANGING CHANNEL SET UP

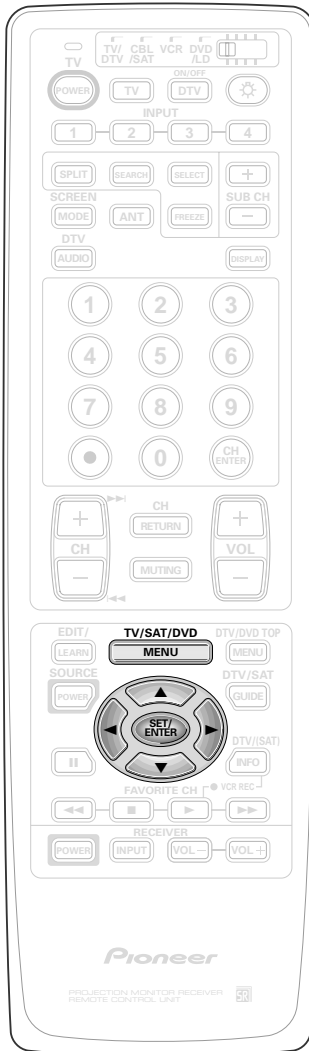

## TO ADD OR DELETE PRESET CHANNELS

Broadcast stations preset by auto channel preset which are unnecessary can be deleted. Broadcast stations to be watched that were not preset by auto channel preset can be preset.

ADD ..... Manually presets channels that were not preset by AUTO CHANNEL PRESET.

DEL ..... Deletes channels that are not required for reception. The deleted channels can be skipped when selecting channels with the + and - CH (channel) buttons.

- Perform the following after completing AUTO CHANNEL PRESET.

**1** Press **MENU** and select **SET UP** by using the **▲** or **▼** button and then pressing **SET/ENTER**. (Refer to page 26.)

**2** Select **CHANNEL SET UP** in the same way.

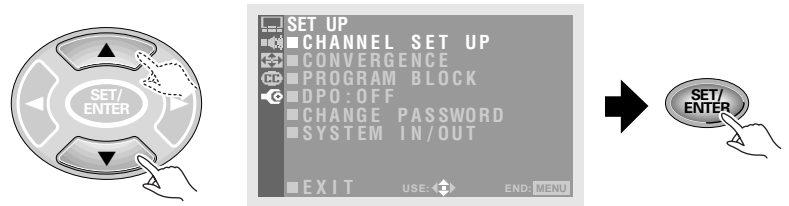

**3** Select **CHANNEL ADD/DEL**.



**4** Select **ANTENNA**, then select **A** or **B**.

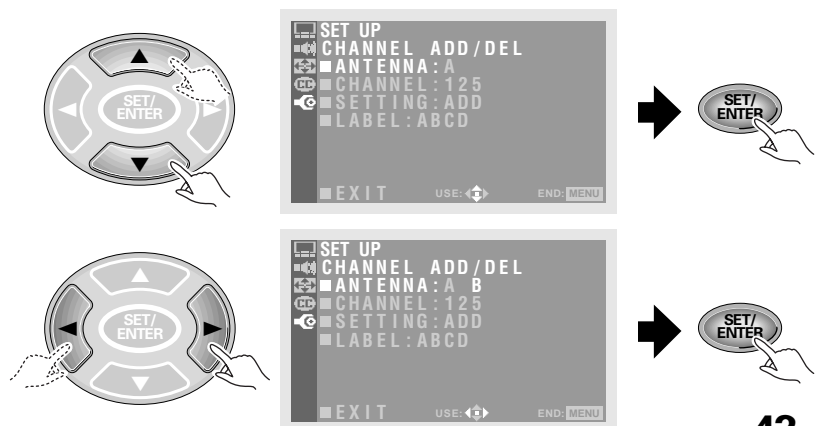

## 5 Select CHANNEL , then select a channel.

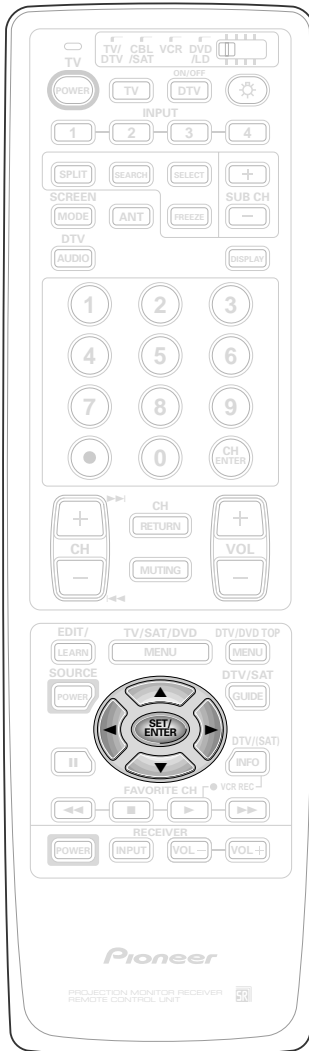

## 6 Select SETTING , then select ADD (addition) or DEL (deletion).

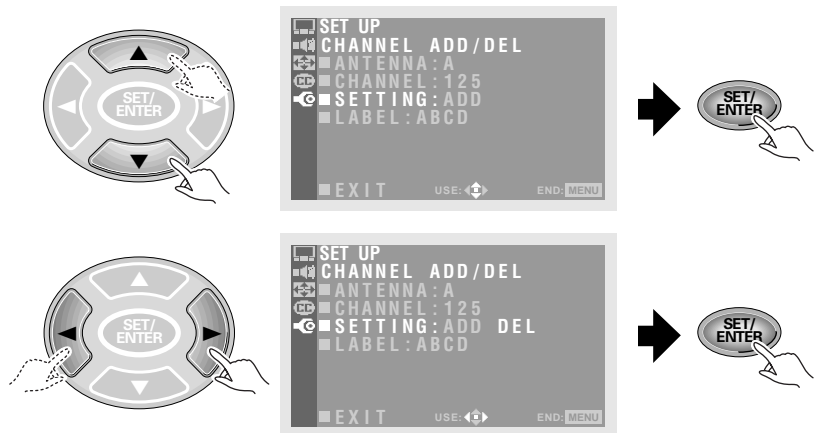

## 7 Select LABEL and input the label characters.

- When ADD has been selected in step 6, a label of 4 characters can be input for the added channel.

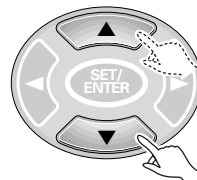
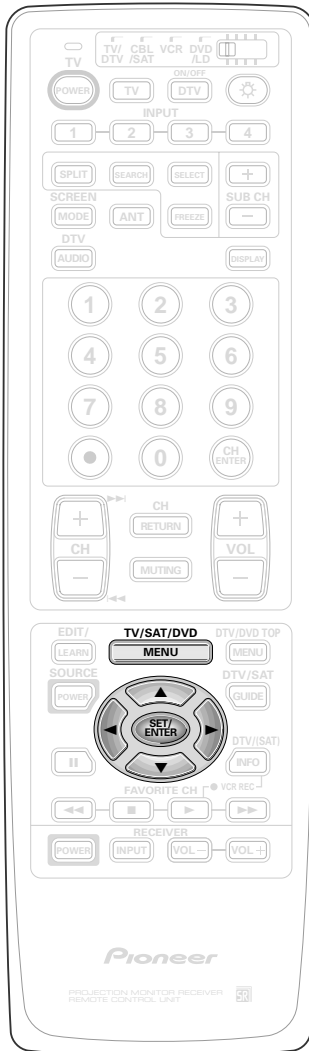

- Input the first character.  
When  is selected, a space can be input.  
When  is selected and input, label character input mode will terminate.

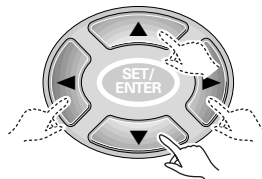

- Input the second to fourth characters as well.

## 8 Repeat steps 4 to 7 to add and delete other channels.

## 9 After setting, press MENU to turn the menu off.



## FAVORITE CHANNEL SET UP

Assigning your favorite channels to the four buttons (blue, green, red and yellow) on the remote control unit makes it easy to call them up. Four channels can be assigned to each button, making it possible to set a total of 16 channels.

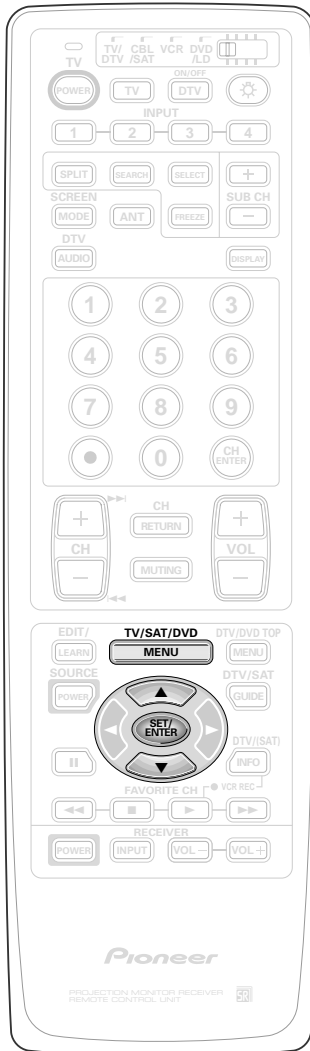

**1 Press MENU and select SET UP by using the ▲ or ▼ button and then pressing SET/ENTER. (Refer to page 26.)**

**2 Select CHANNEL SET UP in the same way.**

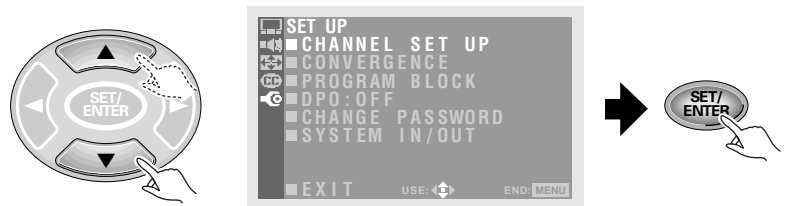

**3 Select FAVORITE CHANNEL .**



**4 Select the color of the button you wish to set.**



**NOTE:**

A channel set for DEL with CHANNEL ADD/DEL (page 43) cannot be set as a FAVORITE CHANNEL.

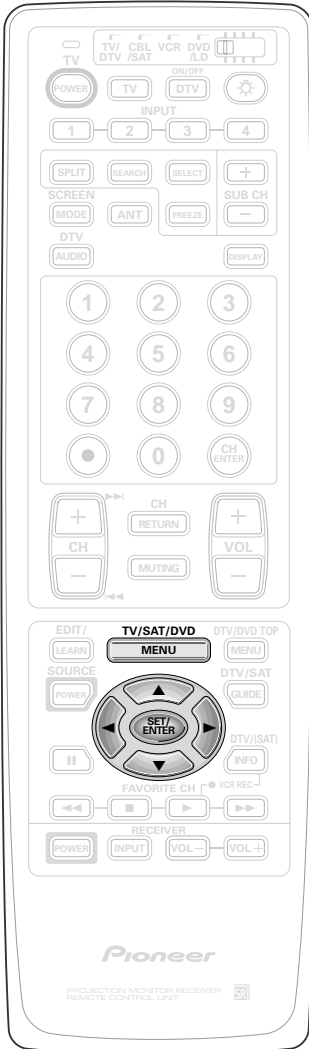

## 5 Select number.

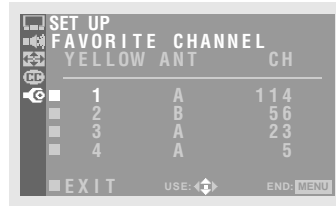
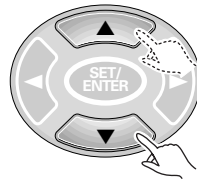

## 6 Select antenna.

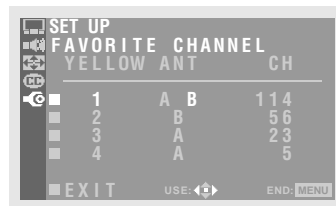

- If you made a mistake during setting, press SET to select the incorrect entry and set it correctly.

## 7 Select the channel.

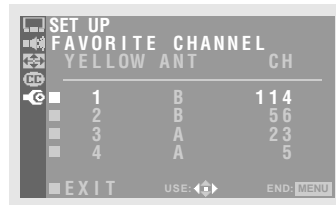
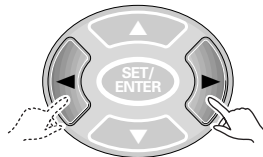

## 8 To set another number, repeat steps 5 to 7.

To set a button of a different color, repeat steps 4 to 7.

- To return to step 4, press either the ▲ or the ▼ button to select EXIT and then press the SET/ENTER button.

## 9 After setting, press MENU to turn the menu off.



# PICTURE ADJUSTMENTS

This device has three types of picture quality settings in memory. You can select your favorite from them or set the picture quality you desire and store it in memory.

## RECALL THE DESIRED SETTINGS

**1** Press **MENU** and select **PICTURE** by using the **▲** or **▼** button and then pressing **SET/ENTER**. (Refer to page 26.)

**2** Select **MODE** in the same way.

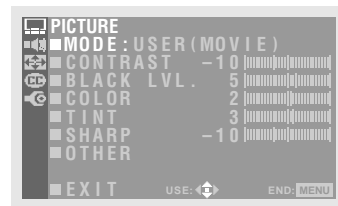
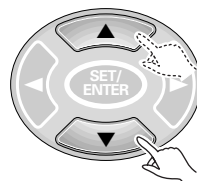

**3** Select the desired setting.

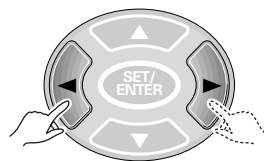

- STD ..... Sets standard picture quality.
- MOVIE ..... Reduces contrast making dark images easier to see. Effective for movies that have many dark images such as night scenes etc..
- GAME ..... Lowers the relative contrast of TV game and personal computer images to minimize discomfort to the eyes. This will minimize bad effects such as discolored spots or stains on the CRT of the Monitor.
- USER ..... Calls up the picture quality the user has set. See page 49 for setting.

**4** After setting, press **MENU** to turn the menu off.



### NOTE:

MOVIE or GAME mode may not be selected when receiving RGB input.

### NOTES on GAME mode setting:

- We do not recommend the use of the Monitor for video games, still pictures, or computers due to the potential damage to the CRTs. In the event a consumer needs to use these devices for a short period of time, the GAME mode will minimize potential damage to the CRTs by lowering the relative contrast.
- All signals output from the Projection Monitor will be unaffected. Only the original output signal is sent through the output jacks.



## STORING THE SET PICTURE QUALITY IN MEMORY

USER mode can be set for each input source: TV , DTV and INPUT 1 to INPUT 4.

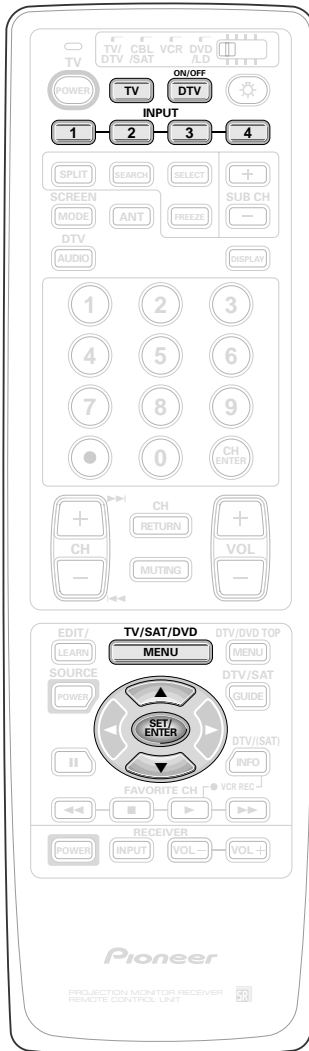

**1** Select the input source and show the image on the screen.

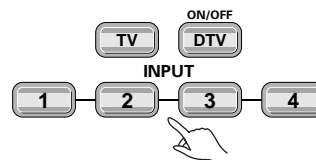

If VCR or DVD/LD has been selected, start playback for the relevant device.

**2** Press MENU and select **PICTURE** .

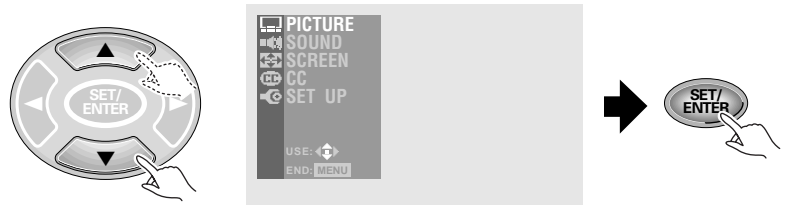

**3** Adjust the desired picture quality. (Refer to steps 2 and 3 on page 50.)

- If any mode (STD, MOVIE, or GAME) is adjusted, USER mode will be entered.
- The last mode that was adjusted will become the USER sub mode (indicated in parentheses).
- A USER mode can be stored for TV , DTV and the four input sources.

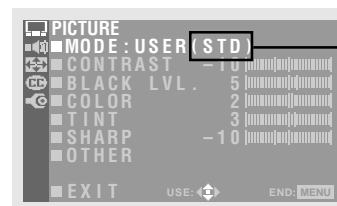

Indicates the adjusted picture quality setting that is the base for USER mode.

**4** After adjusting, press MENU to turn the menu off.



**NOTE:**  
When the input source is DTV in USER mode, this setting will only be possible if the digital tuner has been connected.

## TO ADJUST THE PICTURE QUALITY

The CONTRAST , BLACK LEVEL (brightness), COLOR, TINT and SHARP (sharpness) can be adjusted.

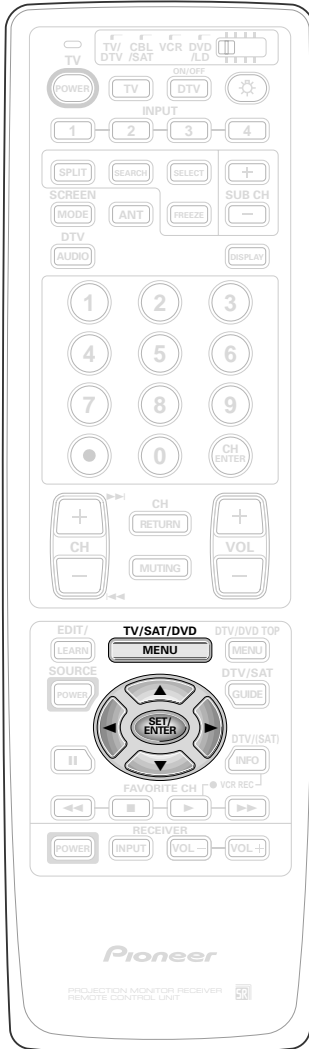

**1 Press MENU and select PICTURE .**  
(Refer to page 26.)

**2 Select the adjustment item.**



**3 Adjust by pressing ◀ or ▶ .**

- The adjusting range is -30 to 30.
- The numerical value comes down to press ◀ and comes up to press ▶.



- The set picture quality will be stored in memory as USER mode (see page 49).
- Repeat steps 2 and 3 for other items.

**4 After adjusting, press MENU to turn the menu off.**



**NOTES:**

- The COLOR, TINT, and SHARP settings may not be changed when receiving RGB input.
- When DPO is on, CONTRAST, BLACK LEVEL and COLOR cannot be adjusted. (See page 59.)
- When picture quality has been adjusted, the user mode data will be overwritten with the new settings.

## OTHER PICTURE QUALITY ADJUSTMENTS

The following six fine adjustments are available.

- ① 3D Y/C LEVEL
- ② 3D NR LEVEL
- ③ COLOR TEMP (Color Temperature)
- ④ FLESH TONE
- ⑤ PURECINEMA
- ⑥ SVM (Scan Velocity Modulation)

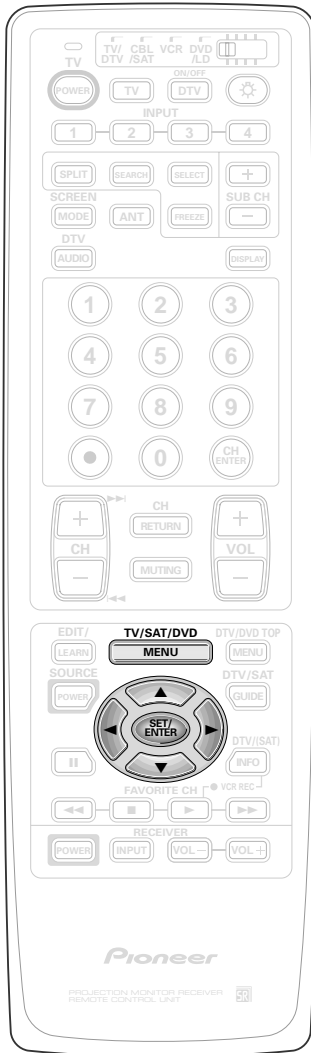

**1** Press **MENU** and select **PICTURE** .  
(Refer to page 26.)

**2** Select **OTHER** .

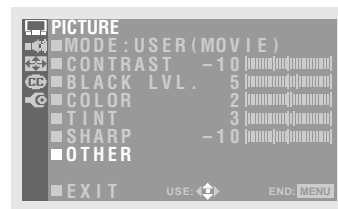
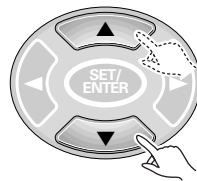

**3** ① To adjust **3D Y/C LEVEL**

Perform this adjustment when noises appear at the color borders of the image.

**NOTE:**

*This function can be used only when viewing a source that has been connected to the antenna or composite video input terminal.*

Select **3D Y/C LEVEL** .

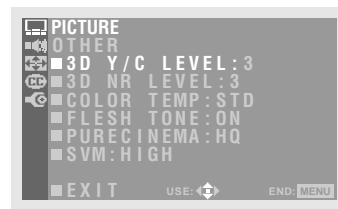
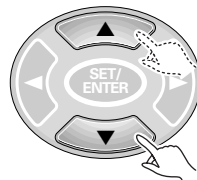

Select the desired level.

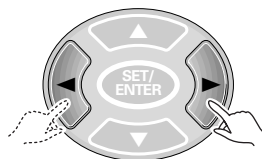

1 ↔ 2 ↔ 3 ↔ 4 ↔ 5

Suitable for software using dynamic images

Suitable for software using still images

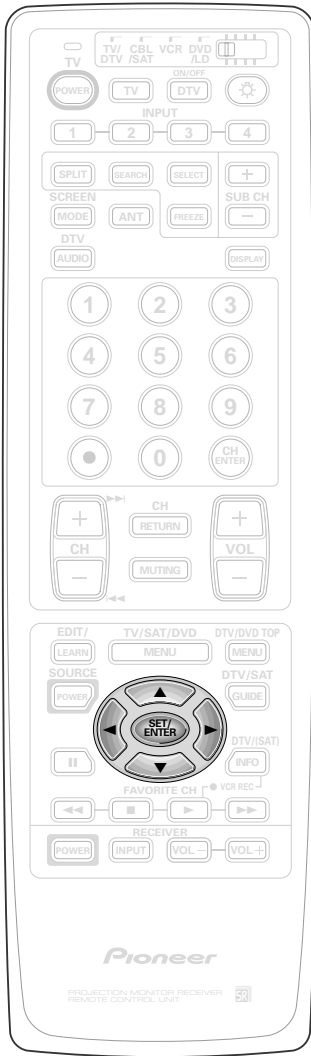

## ② To adjust 3D NR LEVEL

Reduces the noise level of the luminance and chrominance signals when there is S-VIDEO input.

**NOTE:**

*This function can be used only when viewing a source that has been connected to the S-VIDEO input terminal.*

### Select 3D NR LEVEL .

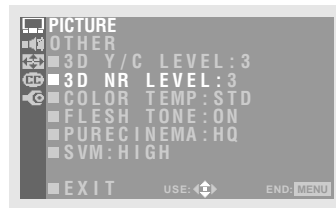
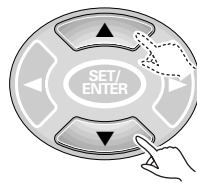

### Select the desired level.

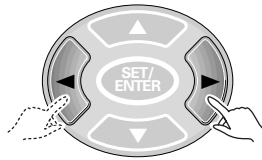

1 ↔ 2 ↔ 3 ↔ 4 ↔ 5

Low noise reduction

High noise reduction

## ③ To adjust COLOR TEMPERATURE

This function enables the image to be set to five different tones.

### Select COLOR TEMP .

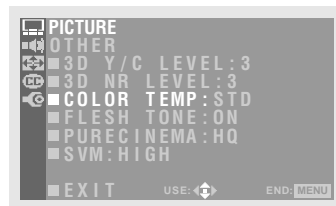
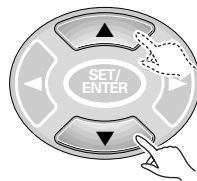

### Select the desired tone of the image.

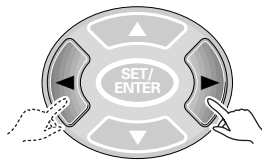

- NEWS ..... Coolest color
- LIVE ..... Cooler color
- STD ..... Normal color
- FILM ..... Warmer color
- B&W ..... Warmest color

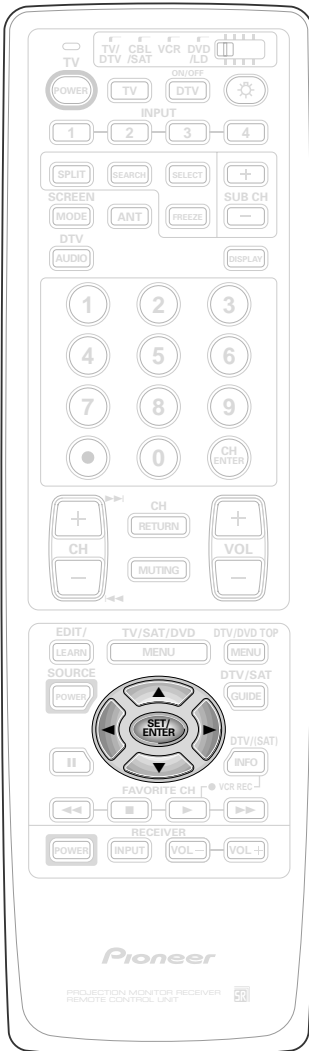

#### ④ To adjust FLESH TONE

By the time video signals from a broadcast station arrive at your projection monitor (on air or cable TV), they have experienced significant degradation.

Flesh tone reduces color noise, improves color uniformity and corrects unnatural flesh tones to give your natural images.

**NOTE:**

*This function cannot be used when 1080i or 480p component signals have been input or when a DTV broadcast is being watched (with the digital tuner, sold separately).*

Select **FLESH TONE** .

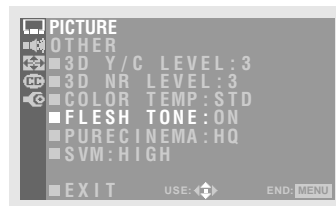
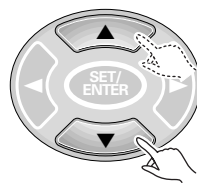

Set **FLESH TONE** to ON.

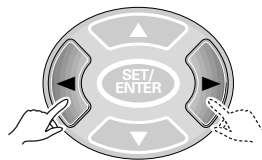

#### ⑤ To adjust PURECINEMA

This function automatically detects movie film recorded at 24 frames per second, and converts it into a high quality progressive video image delivering the picture at the same rate as it was recorded.

**NOTE:**

*This function cannot be used when 1080i or 480p component signals have been input or when a DTV broadcast is being watched (with the digital tuner, sold separately).*

Select **PURECINEMA** .

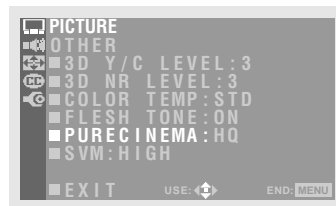
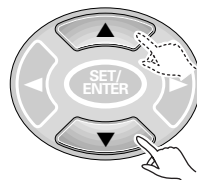

**NOTE on PURECINEMA adjustment:**  
Normally, this function should be set to "HQ" (High Quality), however, occasionally this setting may cause slight syncopation problems with the audio track. If you are bothered by this, select "STD" (Standard) or "OFF". If "OFF" is selected, normal progressive signal processing is performed.

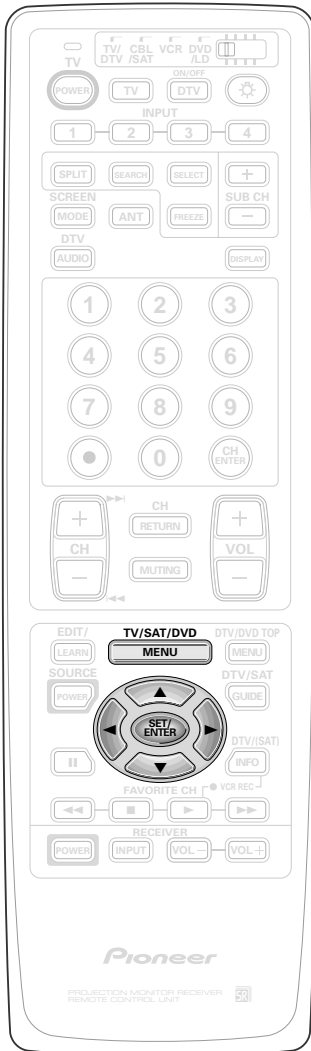

Select the desired PURECINEMA mode.



- HQ ..... Maximum PURECINEMA effects.
- STD ..... Standard PURECINEMA effects.
- OFF ..... No PURECINEMA effects

### ⑥ To adjust Scan Velocity Modulation (SVM)

Screen contour definition can be selected as desired.

**NOTE:**

*This function cannot be used when SCREEN MODE is 4:3 NORMAL or PICTURE MODE is GAME.*

Select SVM .

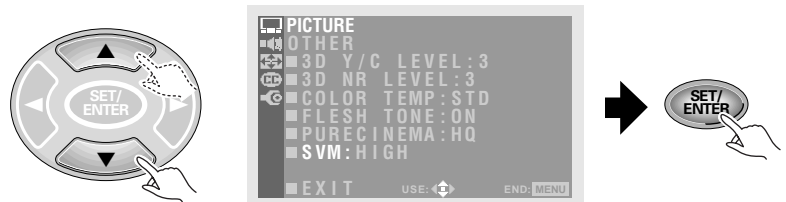

Select the desired SVM mode.



- OFF ..... Provides a soft picture.
- MID ..... Provides a picture with moderate contours.
- HIGH ..... Provides a picture with sharp contours.

## 4 After setting, press MENU to turn the menu off.



# SOUND ADJUSTMENTS

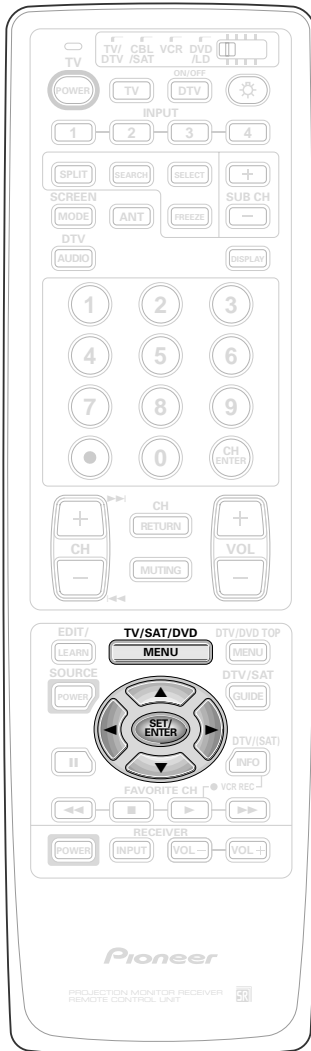

## WATCHING STEREO AND BILINGUAL PROGRAMS

The multichannel TV sound (MTS) decoder enables stereo program and Second Audio Program (SAP) to be received. (SAP is often used for a second language). This MTS decoder can only be used if a broadcast of stereo program or SAP is received.

**1** Press **MENU** and select **SOUND** by using the **▲** or **▼** button and then pressing **SET/ENTER**. (Refer to page 26.)

**2** Select **MTS** in the same way.

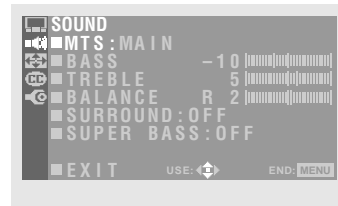
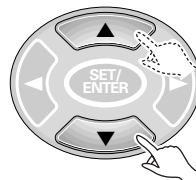

**3** Select the desired audio mode.

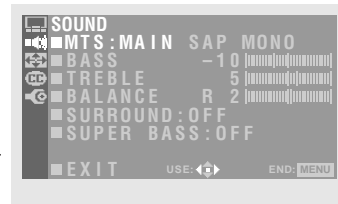
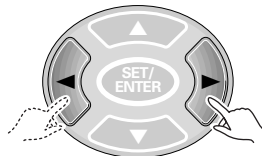

→MAIN←→SAP←→MONO←

**4** After setting, press **MENU** to turn the menu off.



### NOTES:

- This function can only be used for TV input.
- Broadcast stereo and SAP reception operate in accordance with the Broadcast Television System Committee (BTSC) standard only. Stereo audio transmission from CATV system can vary from area and may not be compatible with the BTSC standards. Check with your local cable company for specific compatibility requirements.

## TO ADJUST THE SOUND QUALITY

BASS, TREBLE and BALANCE can be adjusted.

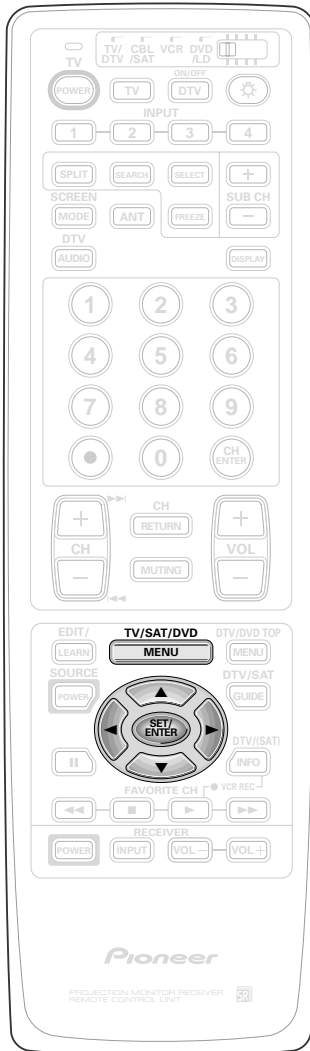

**1 Press MENU and select **SOUND** .**  
(Refer to page 26.)

**2 Select the adjustment item.**

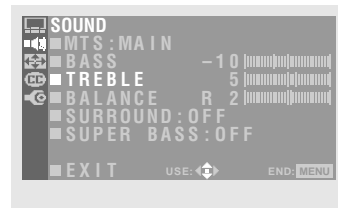
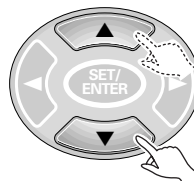

**3 Adjust by pressing ◀ or ▶ .**

- Adjustable range  
 BASS, TREBLE : -30 to 30  
 BALANCE : L (Left) 30 to R (Right) 30

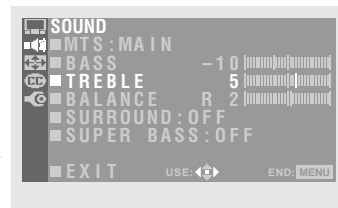

- Repeat steps 2 and 3 for other items.

**4 After adjusting, press MENU to turn the menu off.**



**NOTE:**  
 BASS, TREBLE and BALANCE are SPEAKER mode settings, which can only be adjusted when mode is NORMAL (see page 63).



## TO SELECT THE DESIRED SURROUND MODE

Surround can be selected as desired.

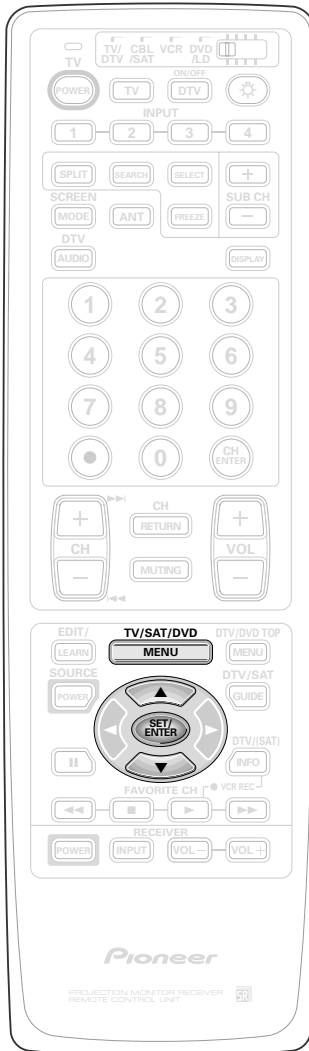

**1 Press MENU and select **SOUND** .**  
(Refer to page 26.)

**2 Select **SURROUND** .**

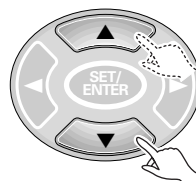

**3 Select the desired SURROUND mode.**

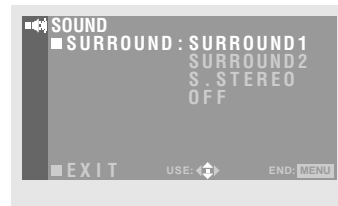
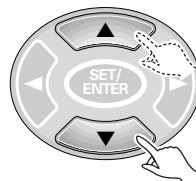

**SURROUND1** ..... This is an easy way to enjoy SURROUND during a musical program.

**SURROUND2** ..... This is a way to enjoy powerful SURROUND during a movie.

**S. STEREO (Simulated STEREO)**

..... This function transforms monaural signals into simulated stereo sound.

Use it when you wish to experience a sense of stereo presence when listening to monaural signal sources.

**OFF** ..... Turns off the surround effect.

**4 After setting, press MENU to turn the menu off.**



### NOTES:

- This function cannot be used when the **SPEAKER** mode is **CENTER IN** or when the **SPEAKER** mode is **OFF** and **AUDIO OUT** mode is **FIXED** (see page 63).
- The surround effect cannot be obtained with mono sound.
- In some cases, the surround effect may be minimal.

## TO ADJUST SUPER BASS

Use this function to enjoy powerful bass sounds.

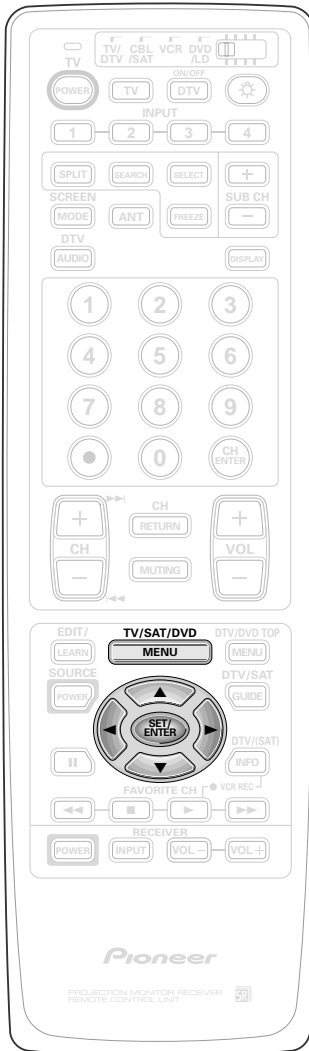

**1 Press MENU and select SOUND .**  
(Refer to page 26.)

**2 Select SUPER BASS .**

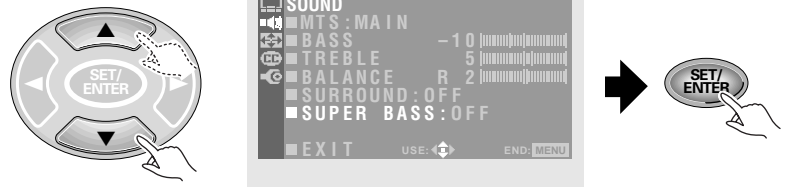

**3 Set SUPER BASS to ON.**

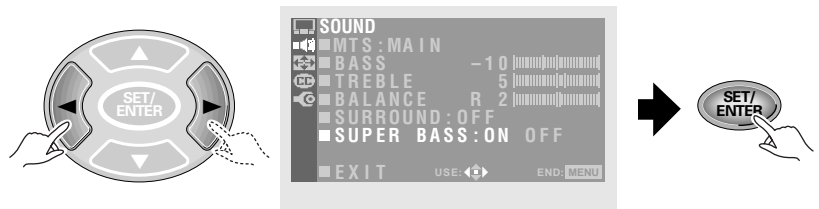

**4 After adjusting, press MENU to turn the menu off.**



# DPO FUNCTION

The sensor of the DPO (Dynamic Picture Optimizer) on the TV front panel determines brightness and adjusts the CONTRAST, BLACK LEVEL (brightness) and COLOR automatically.

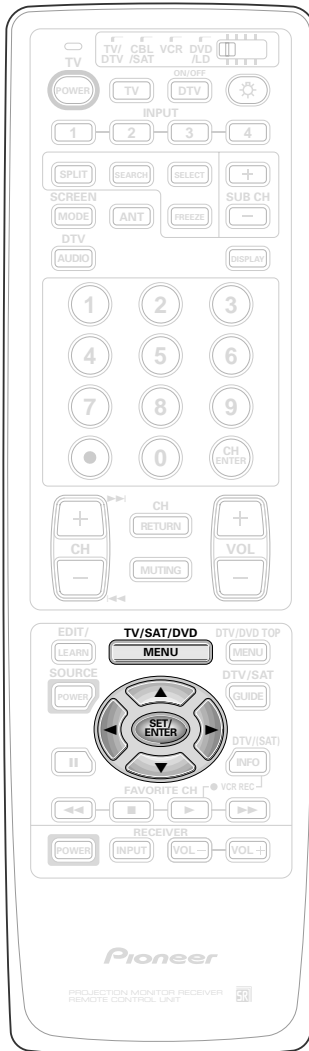

**1** Press **MENU** and select **SET UP** by using the **▲** or **▼** button and then pressing **SET/ENTER**. (Refer to page 26.)

**2** Select **DPO** in the same way.



**3** Set DPO to ON.

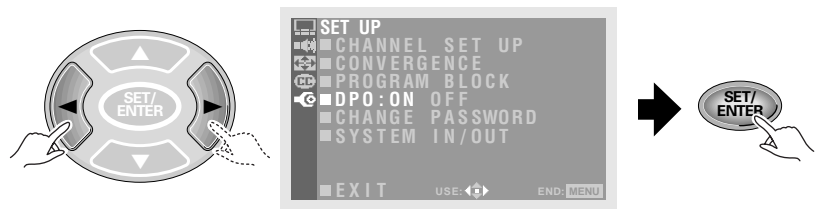

**4** After setting, press **MENU** to turn the menu off.



# MULTI-POINT CONVERGENCE ADJUSTMENT

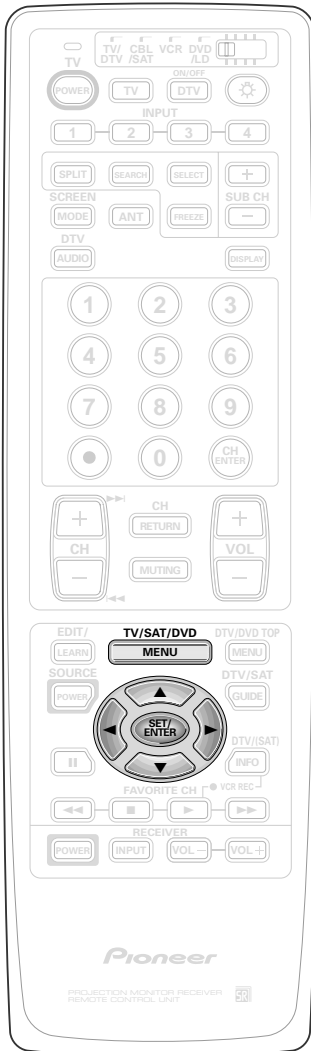

Convergence adjustment may be fined-tuned from here.

**1** Press MENU and select **SET UP** by using the ▲ or ▼ button and then pressing SET/ENTER. (Refer to page 26.)

**2** Adjust the center point convergence. (Refer to steps 2 to 5 on pages 30 to 31.)

**3** Select **ADJ MULTI-POINT**.



**4** Select the adjust point.

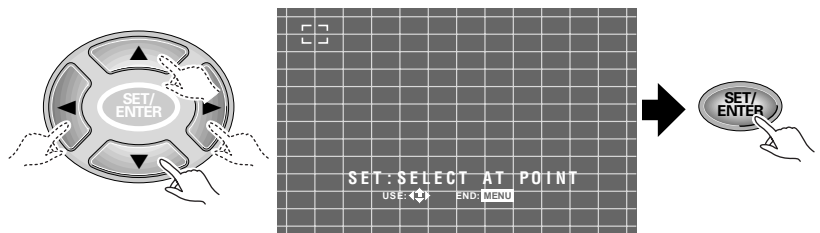

**5** Adjust the red line.

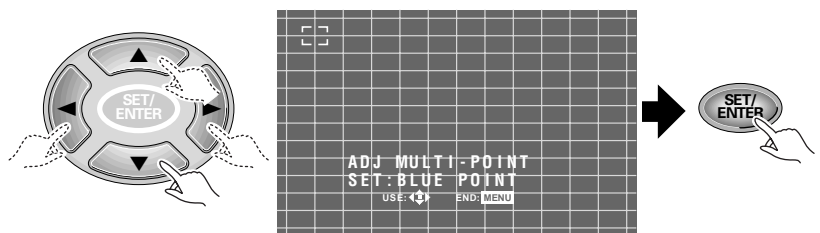

## NOTES:

- The number of adjustment points varies according to the screen mode. The cursor is partially invisible around the edge of the screen according to the screen mode.
- It is not possible to adjust all these points (points of change on the cross-hatch).
- Some of the cross-hatch lines are not straight, but this is not a malfunction. They are not always straight on a normal TV.

## 6 Adjust the blue line.



- The brackets which shows the adjusting point will move in order.  
Move to the next point to be adjusted, and repeat steps 4 to 6.

## 7 After completing the convergence adjustment, press MENU to turn the menu off.

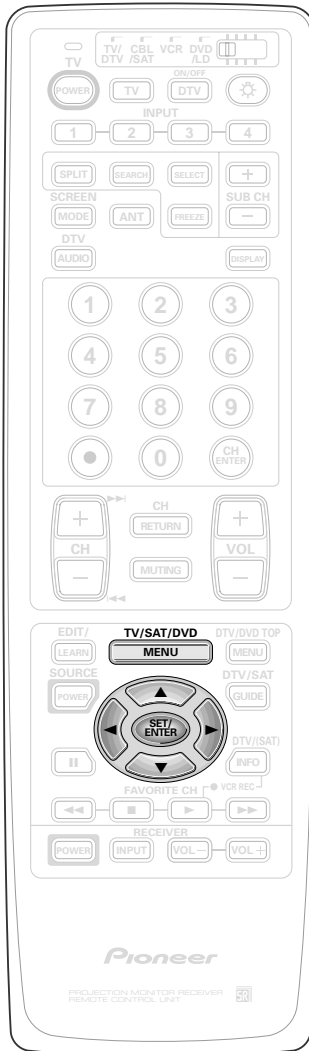

# CONNECTION WITH RECEIVER (1)

The audio signal output from this unit can be reproduced on the receiver when this monitor is connected to the receiver. When this monitor is connected to the CENTER OUT terminal of the receiver, the speaker of this monitor can be used as the center speaker.

- Before making or changing connections, set the power switch to off and unplug the power cord from the AC outlet.
- For details of connecting DVD/LD player, VCR, SAT tuner, etc., refer to page 16.
- After completing connections, perform the "SPEAKER and AUDIO OUT settings" operation.

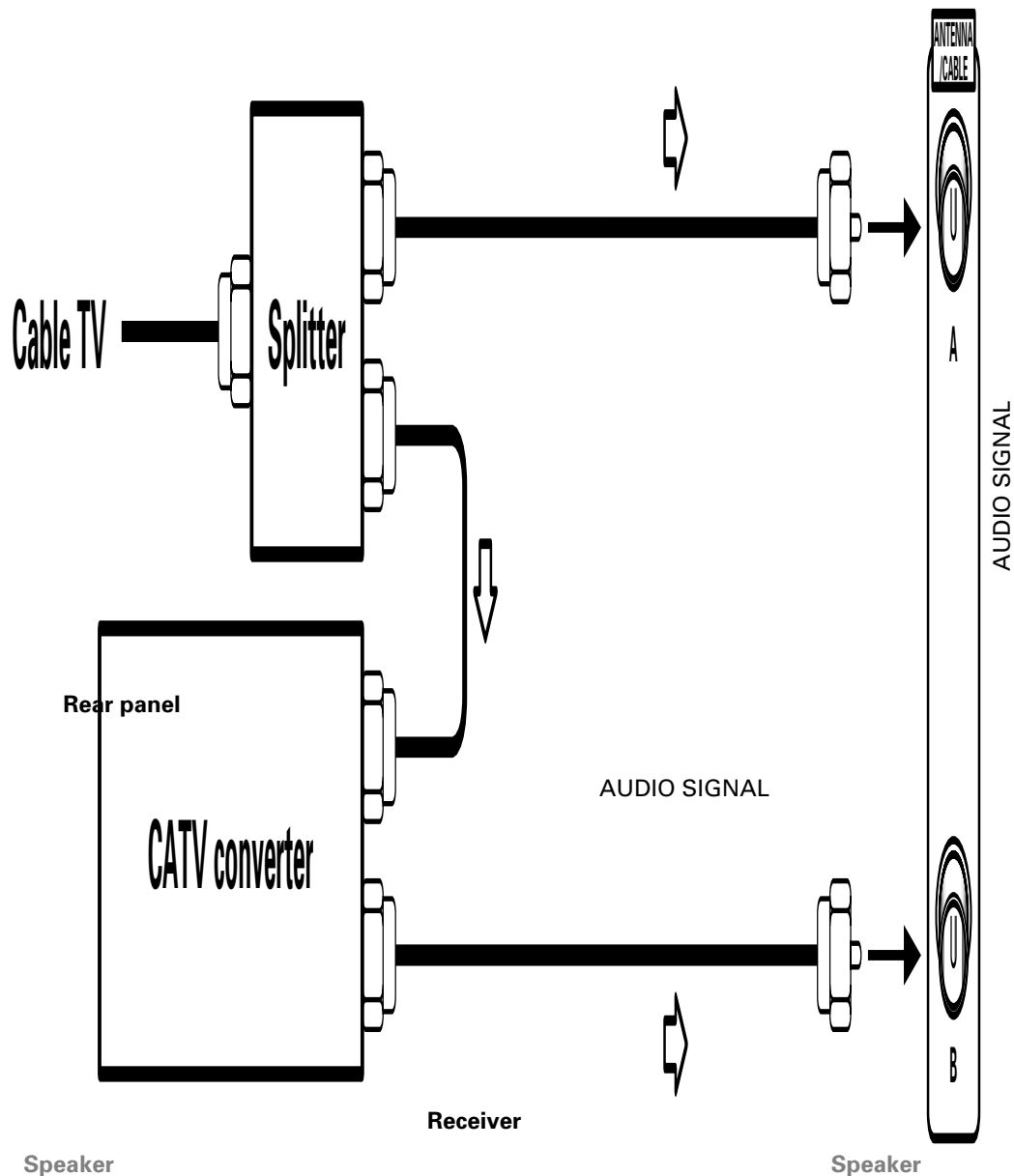

## SPEAKER and AUDIO OUT settings

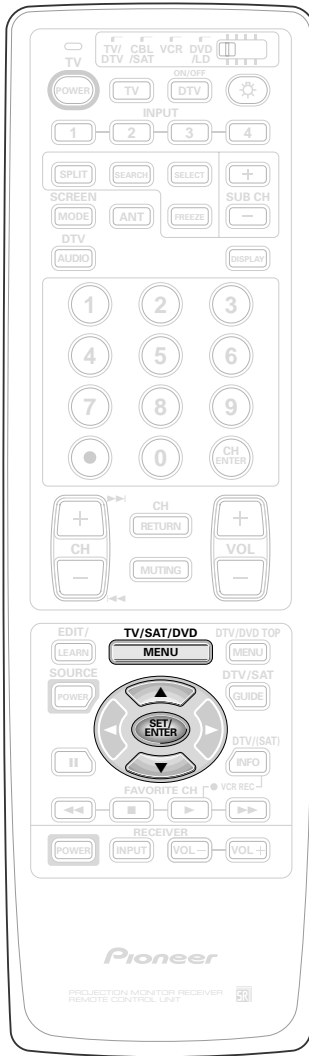

**1** Press **MENU** and select **SET UP** by using the **▲** or **▼** button and then pressing **SET/ENTER**. (Refer to page 26.)

**2** Select **SYSTEM IN/OUT** in the same way.

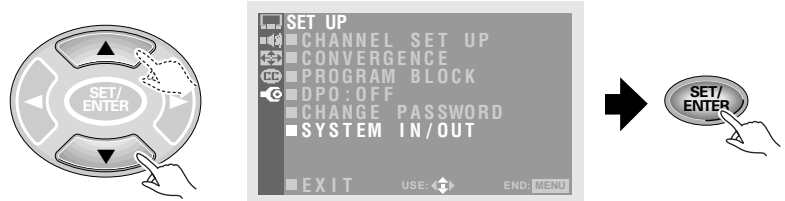

**3** Select **SPEAKER**.

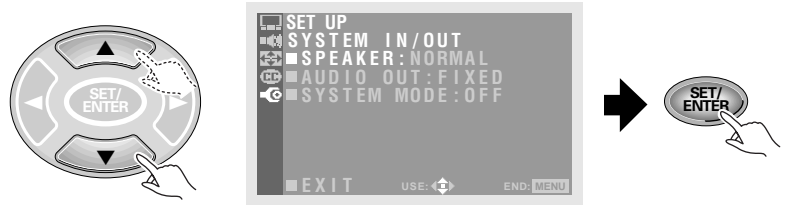

**4** Select the **SPEAKER** mode.



- NORMAL ..... The Monitor sound is output from the speaker.
- CENTER IN ... The sound is output from the speaker connected to the receiver which is connected to the AUDIO OUTPUT terminal.  
The speaker of this Monitor is set as the center speaker.
- OFF ..... No sound will be output from the Monitor's speaker.

**NOTE:**  
After the speaker mode is set to **CENTER IN**, the volume of the center speaker should be controlled from this monitor.

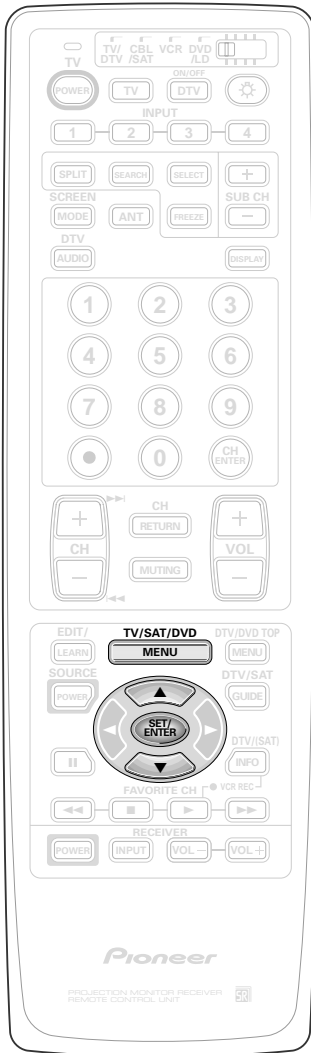

## 5 Select **AUDIO OUT** .

- If the speaker mode was set to CENTER IN in step 4, the AUDIO OUT mode will automatically change to FIXED, and VAR cannot be selected.



## 6 Select the **AUDIO OUT** mode.



**FIXED** ..... Signals output from the AUDIO OUTPUT terminal will not change even if the Monitor's volume is adjusted.

**VAR** (variable) ... Sound signals output will change as Monitor's volume is changed.

- When SYSTEM MODE has been set to ON, the audio out mode will change to MUTING and sound signals will not be output from the AUDIO OUTPUT terminal (see page 66).
- The sound signals output will change in accordance with the SURROUND mode setting (see page 57).

## 7 After setting, press **MENU** to turn the menu off.



**NOTE:**

If **AUDIO OUT** is set to **VAR** and the sound is distorted, lower the Monitor volume.



# CONNECTION WITH RECEIVER (2)

This unit can be used as the monitor for the receiver when this unit is connected to the receiver. When this unit is connected to the CENTER OUT terminal of the receiver, the speaker of this unit can be used as the center speaker.

- Before making or changing connections, set the power switch to off and unplug the power cord from the AC outlet.
- Connect the DVD/LD player, VCR, SAT tuner or similar component to the receiver.
- After completing connections, perform the "SYSTEM MODE setting" operation.

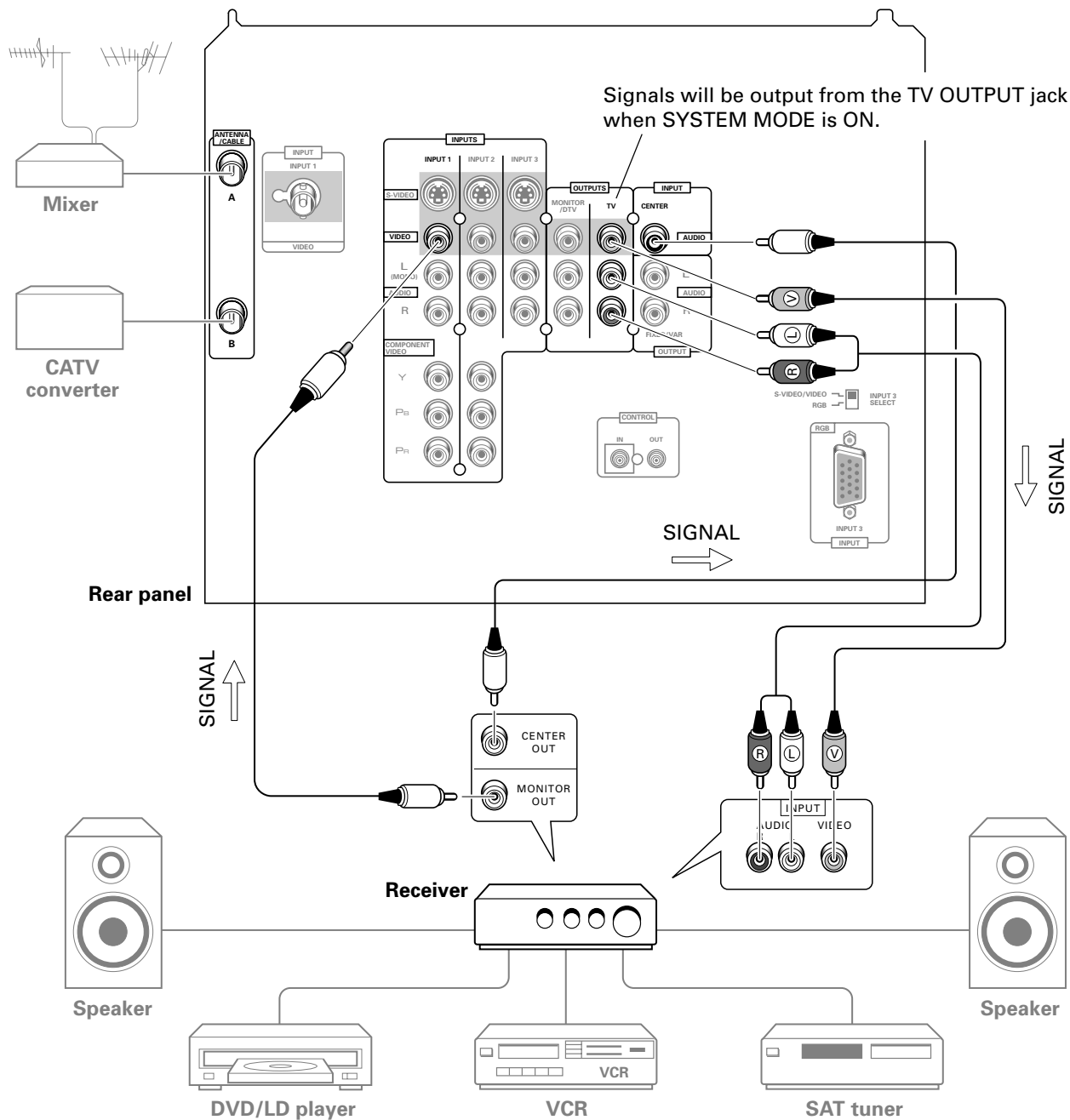

## SYSTEM MODE setting

**1** Press MENU and select **SET UP** .  
(Refer to page 26.)

**2** Select **SYSTEM IN/OUT** .

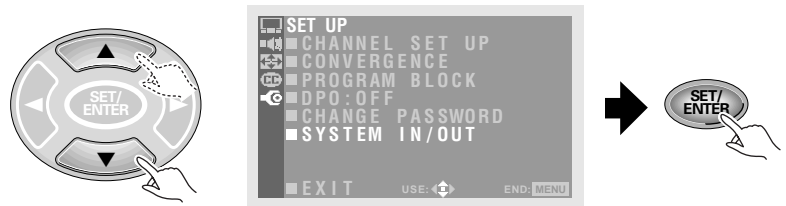

**3** Select **SYSTEM MODE** .

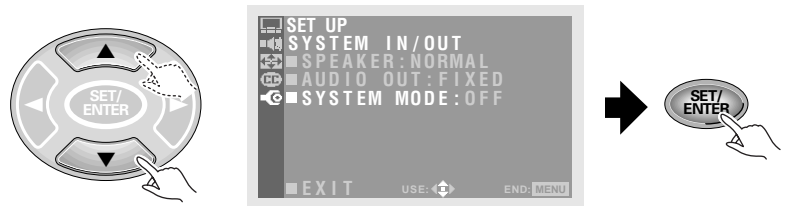

**4** Switch the **SYSTEM MODE**.

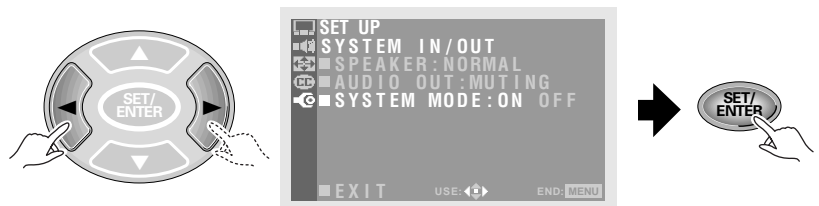

Unless required, set the **SYSTEM MODE** to **OFF**.

### Notes on **SYSTEM MODE ON** :

- The input cannot be switched even if you press the Input selector button of the remote control unit.
- On the sub-picture of a SPLIT screen, only the input signal from the antenna can be displayed.
- The SEARCH screen function will not be operable.
- No signal will be output from the AUDIO OUTPUT terminal.
- Setting **SYSTEM MODE ON** will cause RGB input signals to not be displayed.

ON ..... The Monitor input is fixed to INPUT 1 and the images of the input source selected by the receiver will be displayed.

OFF ..... Normal setting.

**5** After setting, press **MENU** to turn the menu off.



# CONNECTING THE SYSTEM REMOTE CONTROL

(When operating Pioneer units with  mark)

When the control terminals of Pioneer audio/video units with the  mark are connected, these units can be operated using the Monitor's remote control unit (see pages 72 to 77).

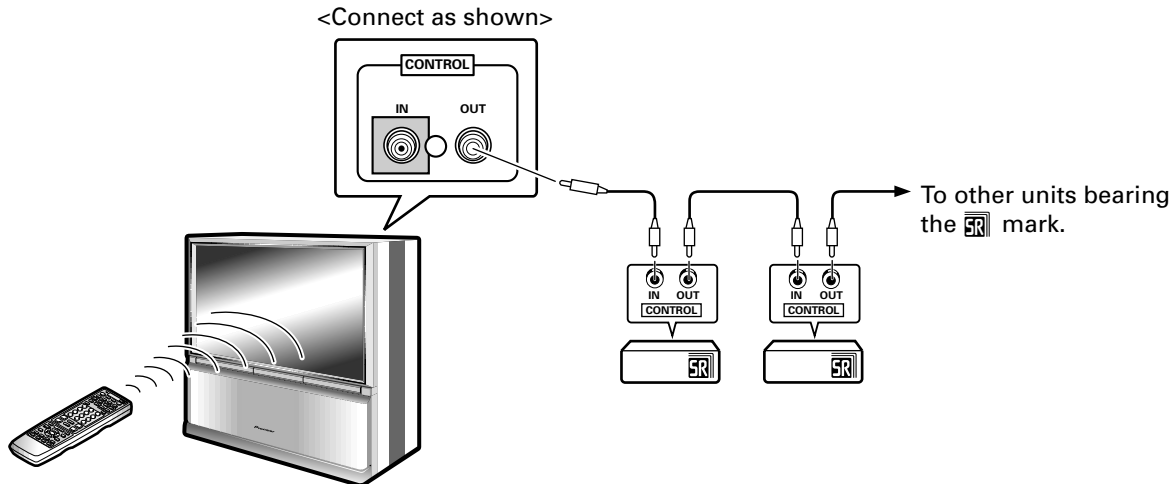

## NOTES:

- When the Pioneer unit with  mark is connected to the CONTROL IN terminal of the projection monitor, the remote sensor of the projection monitor does not accept signals from the remote control unit. In this case, point the remote control at the first device in the chain (the equipment with no CONTROL IN connection).
- To connect the control cord, use the commercially available mini plug cord (monaural).

# REMOTE CODE SET UP

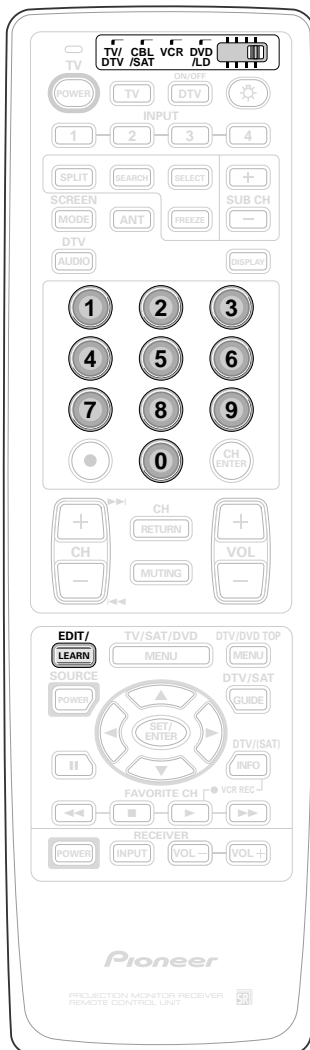

To operate other manufacturers' audio/video units using the TV remote control unit, remote control signals need to be set.

There are two methods of setting remote control signals

- For calling the other manufacturers' remote control signals preset to this remote control unit
- For learning other manufacturers' remote control signals

## CALLING OTHER MANUFACTURERS' REMOTE CONTROL SIGNALS PRESET

### 1 Set the mode switch to match the device to which you want to preset the remote control signal.

- Example: To select DVD/LD.

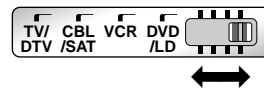

### 2 At the same time, press the EDIT button and number button 1.

LED will begin blinking.

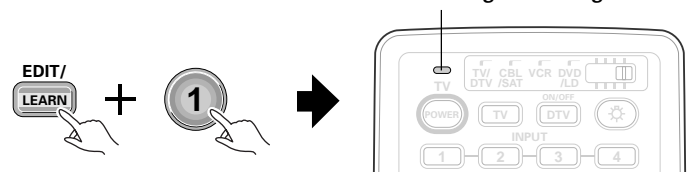

### 3 Select the desired manufacturer.

- Select from the figure on page 69.
- Example: To select 24 (PHILIPS) in the LD mode.

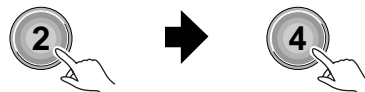

- If the LED blinks rapidly when the number button has been pressed, there has been an error. Input the number again.
- After setting, you can automatically use the remote control in the usual manner.

#### NOTES:

- To stop the EDIT mode in the middle, press the EDIT button once more.
- If mode switch is switched while in EDIT mode, EDIT mode will be canceled.
- After step 1 and step 2, if you do not press the button for one minute (no operation), the EDIT mode will be canceled.
- If the table on page 69 does not include your desired manufacturer or the remote control does not work, you can make the memory learn its signal by the learn mode (see page 70).
- The initial mode is "00" (PIONEER).

**Manufacturer's preset remote control signals**

	CBL/SAT	VCR	DVD/LD
00	PIONEER 1 (CABLE)	PIONEER	PIONEER (DVD)
01	PIONEER 2 (CABLE)	FISHER	PANASONIC (DVD)
02	JERROLD 1 (CABLE)	FISHER	SAMSUNG (DVD)
03	JERROLD 2 (CABLE)	FISHER	SONY (DVD)
04	JERROLD 3 (CABLE)	GOLD STAR	TOSHIBA (DVD)
05	JERROLD 4 (CABLE)	HITACHI	JVC (DVD)
06	JERROLD 5 (CABLE)	HITACHI 2	None
07	JERROLD 6 (CABLE)	HITACHI 3	None
08	JERROLD 7 (CABLE)	MAGNAVOX 2	None
09	JERROLD 8 (CABLE)	MITSUBISHI	None
10	JERROLD 9 (CABLE)	MITSUBISHI 2	None
11	JERROLD 10 (CABLE)	MITSUBISHI 3	None
12	S. A. 1 (CABLE)	MITSUBISHI 4	None
13	S. A. 2 (CABLE)	MITSUBISHI 5	None
14	S. A. 3 (CABLE)	MITSUBISHI 6	None
15	S. A. 4 (CABLE)	PANASONIC	None
16	ZENITH 1 (CABLE)	PANASONIC 2	None
17	ZENITH 2 (CABLE)	PANASONIC 3	None
18	ZENITH 3 (CABLE)	RCA	None
19	None	RCA 2	None
20	PIONEER (SAT)	RCA 3	PIONEER (LD)
21	RCA 1 (SAT)	SANYO	KENWOOD (LD)
22	RCA 2 (SAT)	SANYO 2	PANASONIC 1 (LD)
23	SONY (SAT)	SANYO 3	PANASONIC 2 (LD)
24	None	SHARP	PHILIPS (LD)
25	None	SHARP 2	RCA (LD)
26	None	SHARP 3	SONY (MDP)
27	None	SONY (BETA)	SONY (LD)
28	None	SONY (VHS)	None
29	None	SONY (8mm)	None
30	None	TOSHIBA	None
31	None	JVC	None
32	None	JVC 2	None
33	None	JVC 3	None
34	None	JVC 4	None
35	None	JVC 5	None
36	None	ZENITH	None

Operations can be performed using remote control button with the same markings (See pages 74 to 77).

## TO LEARN REMOTE CONTROL SIGNALS

To operate other manufacturers' remote control signals not preset using the remote control unit, have the remote control unit learn these signals.

Example) To learn the VCR power to turn on.

### Before operation:

To set the mode switch to VCR when a video cassette recorder is connected (see page 16).

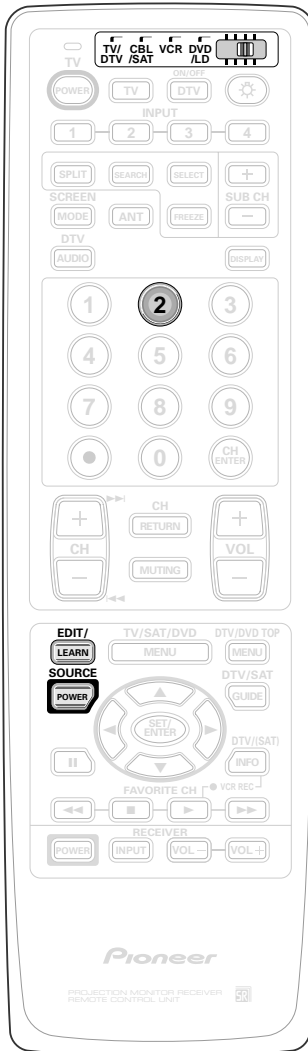

### 1 At the same time, press the LEARN button and number button 2.



LED will begin blinking.

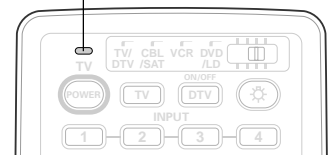

### 2 Press the SOURCE POWER button to memorize the desired operation.



LED will remain lit.

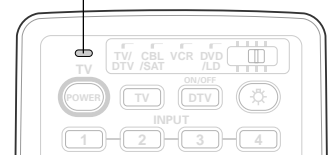

- Buttons which can be learnt are as follows.
  - CABLE** ..... SOURCE POWER, CH (+), CH (-), CH RETURN, CH ENTER, 1 to 9, 0
  - SAT** ..... SOURCE POWER, CH (+), CH (-), ◀, ▶, ▲, ▼, SET/ENTER, TV/SAT/DVD MENU, DTV/SAT GUIDE, DTV/(SAT) INFO, CH ENTER, 1 to 9, 0
  - VCR** ..... SOURCE POWER, CH (+), CH (-), II, ◀◀, ■, ▶▶, ● (VCR REC)
  - DVD** ..... SOURCE POWER, ▶▶▶, |◀◀◀, II, ◀◀, ■, ▶▶▶, ◀▶, ▲, ▼, SET/ENTER, TV/SAT/DVD MENU, DTV/DVD TOP MENU
  - LD** ..... SOURCE POWER, ▶▶▶, |◀◀◀, II, ◀◀, ■, ▶▶▶
- CABLE/SAT and DVD/LD cannot be selected at the same time.

### 3 Face the remote control unit of the other manufacturer's and the remote control unit of the Monitor to each other, and press the POWER button of the remote control unit of the other manufacturer's.

Leave about 0.8 to 2.0 inch (2 to 5 cm) between the two remote control units.  
If you learn how to use the remote control unit you can adjust the distance of the remote control units.

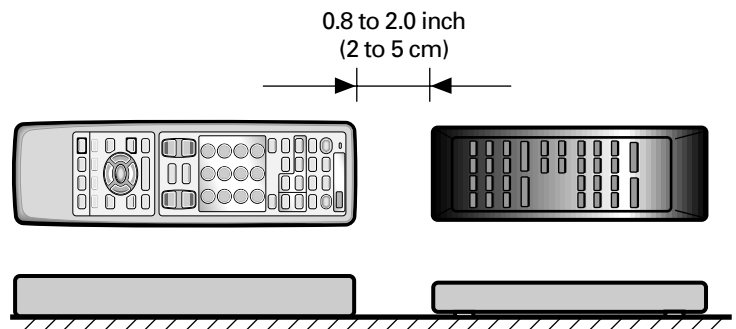

- (VCR) → LED will blink.
- 
- If blinks once, return to step 2 for other buttons.
  - Flashes four times, it indicates an error has occurred.
- This ends learn. Repeat steps 2 and 3 for learning pertaining to other VCR devices.
  - If the remote control unit's LED blink four times, it means that learning capacity has reached its maximum and no more learning will be possible.

### 4 When the LEARN button is pressed, the remote control unit return to normal states.



**NOTES:**

- To stop using the LEARN mode in the middle, press the LEARN button again.
- If mode switch is switched while in LEARN mode, LEARN mode will be canceled.
- After steps 1 and 2, if you do not press the button for one minute (no operation), the LEARN mode will be canceled.
- To reset the learn setting, have the LED blinking as in step 1 and then keep the remote control unit's TV POWER button pressed for at least 2 seconds.
- There are some remote controls which cannot learn.

## USING THE TV REMOTE CONTROL UNIT TO CONTROL OTHER DEVICES

### REMOTE CONTROL UNIT SETTING BUTTONS

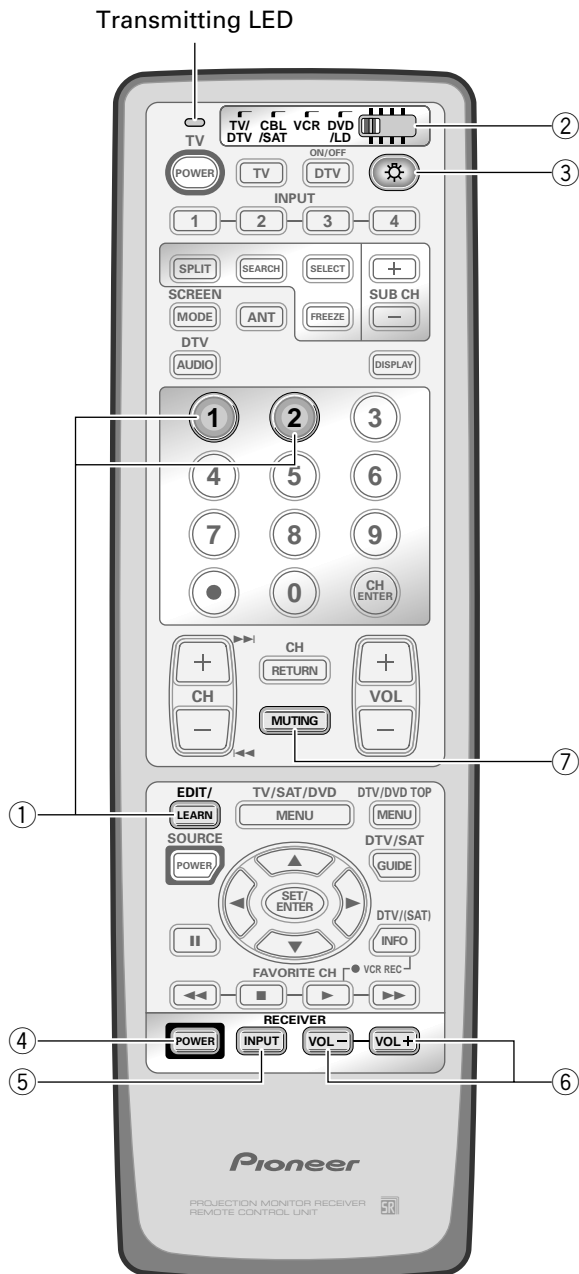

① **EDIT/LEARN button**

**EDIT:** When the EDIT/LEARN button is pressed at the same time as number button 1, the mode will change to preset code edit mode. (See page 68.)

**LEARN:** When the EDIT/LEARN button is pressed at the same time as number button 2, the unit's capability to learn and store command codes from other remote control units will be activated. (See page 70.)

② **Mode switch**

Use to switch the remote control unit modes.

③ **Light button**

When this button is pressed, all the buttons on the remote control unit will light. The lighting will turn off if no operations are performed within five seconds. This button is used for performing operations in dark places.

### RECEIVER CONTROL BUTTONS

When a Pioneer receiver is connected to the Monitor, the receiver can be operated using buttons ④ to ⑥.

When another company's receiver is connected to the Monitor, have the signals for ④ to ⑥ learned (see page 70).

④ **RECEIVER POWER button (STANDBY/ON)**

Turns receiver power on and off.

⑤ **RECEIVER INPUT button**

Selects the input source connected to the receiver.

⑥ **RECEIVER VOL (volume) +, - buttons**

Adjusts receiver volume level. Press the plus button (+) to increase the volume and the minus button (-) to decrease it.

⑦ **(RECEIVER) MUTING button**

Allows the receiver's mute signal to be learned. This button is used when the mode switch has been set to something other than TV/DTV.



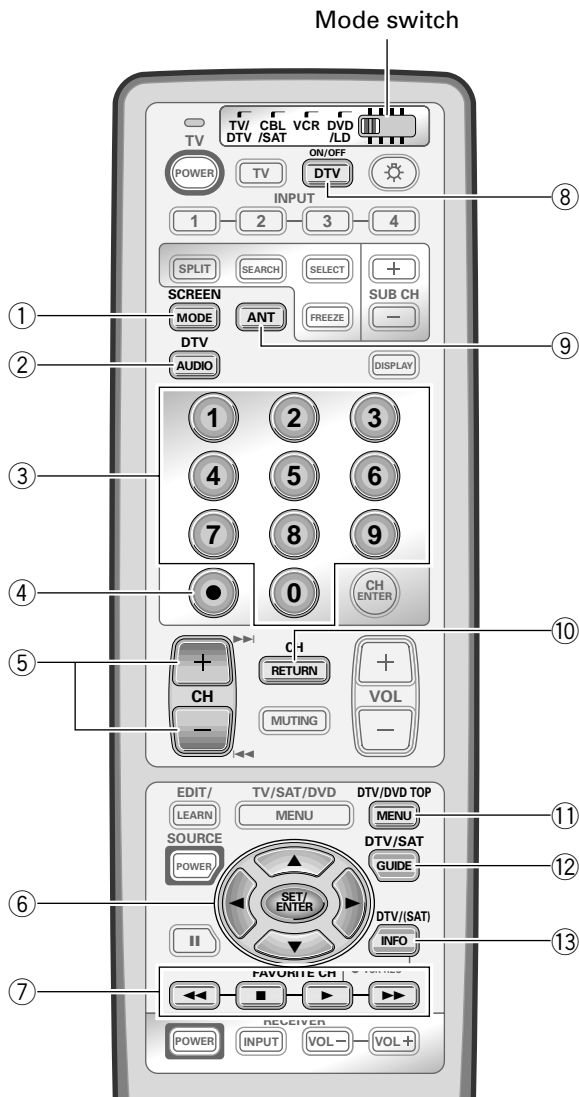

## DTV CONTROL BUTTONS

For viewing DTV broadcasts, the SH-D09 digital tuner (sold separately) is necessary. The following buttons will not work if a digital tuner has not been connected.

When the mode switch is set to TV/DTV, the remote control unit buttons will function as shown below.

- When a digital tuner is installed to the Monitor, press the DTV button on the remote control unit. The tuner can be operated using buttons ① to ⑬.

- ① **SCREEN MODE button**  
Press to select the SCREEN MODE.
- ② **DTV AUDIO button**  
Press to select the audio mode during multiaudio broadcasts.
- ③ **Direct channel selection buttons**  
Press the button (or buttons) that corresponds to the channel that you wish to watch.
- ④ **DTV ON/OFF button**  
Used in channel selection.
- ⑤ **CH (channel) +, - button**  
Press plus (+) or minus (-) to tune in a higher or lower channel.
- ⑥ **Select/Set buttons (SET/ENTER, ◀, ▶, ▲, ▼)**  
◀, ▶, ▲, ▼: Press the button to select items on the DTV MENU screen.  
SET/ENTER: Press to activate the selected function.
- ⑦ **FAVORITE CH/Colored (blue, green, red and yellow) buttons**  
FAVORITE CH: Used for making FAVORITE CH settings with the digital tuner.  
Blue, Green, Red, Yellow: Used to make selections from the digital tuner menu.
- ⑧ **DTV ON/OFF button**  
Turns the digital tuner on and off.
- ⑨ **ANT (antenna selector) button**  
Used to switch to AIR/CABLE as an input source when "Both" is selected in the input source setting mode.
- ⑩ **CH RETURN (channel return) button**  
Press to switch between the current channel and the channel you were watching immediately before.
- ⑪ **DTV MENU button**  
When this button is pressed, the DTV menu screen will be displayed.
- ⑫ **DTV GUIDE button**  
When this button is pressed, the DTV guide screen will be displayed.
- ⑬ **DTV INFO button**  
When this button is pressed, information on DTV will be displayed.

## CABLE CONTROL BUTTONS

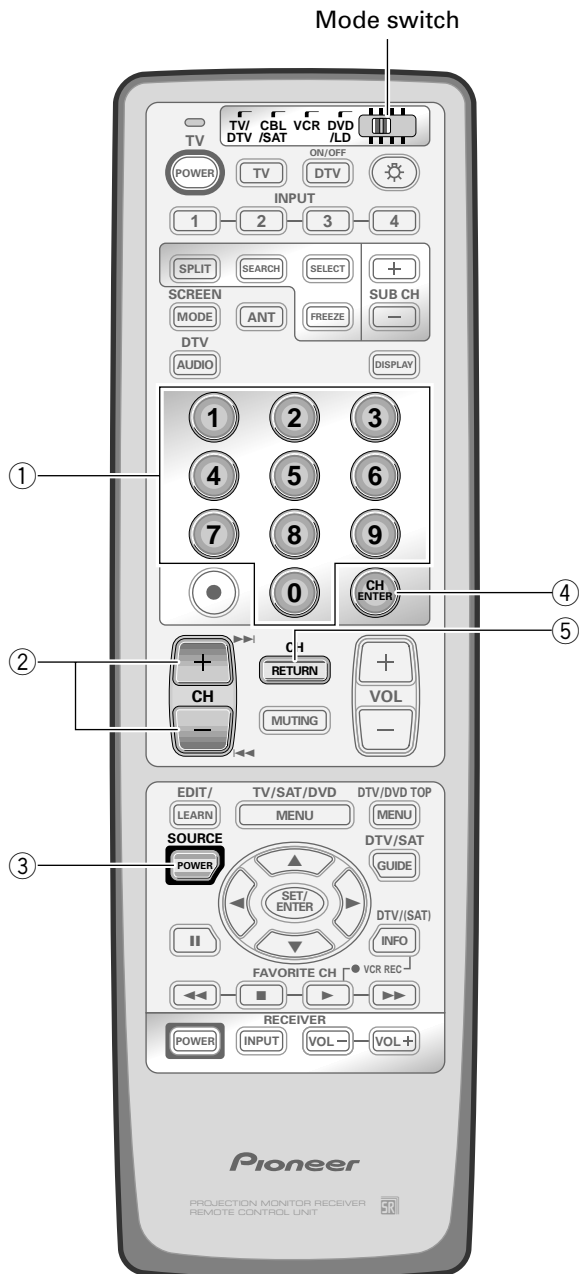

CABLE and SAT cannot be selected at the same time.

When the mode switch is set to CBL/SAT the cable converter connected to the Monitor can be operated using the buttons ① to ⑤.

Cable converters which are made by other makers and are not preset can also be operated using the remote control unit if buttons ① to ⑤ have learnt the functions (see page 70).

- ① **Direct channel selection buttons**  
Press the button (or buttons) that corresponds to the channel that you wish to watch.
- ② **CH (channel) +, - buttons**  
Press plus (+) or minus (-) to tune in a higher or lower channel.
- ③ **SOURCE POWER button**  
Turns the power of the cable converter on and off.
- ④ **CH ENTER button \***  
Fix the selected channel with the direct channel selection buttons.
- ⑤ **CH RETURN (channel return) button \***  
Press to switch between the current channel and the channel you were watching immediately before.

\* Some manufacturers do not preset CH ENTER and CH RETURN. Use these buttons to learn if necessary.

## SAT CONTROL BUTTONS

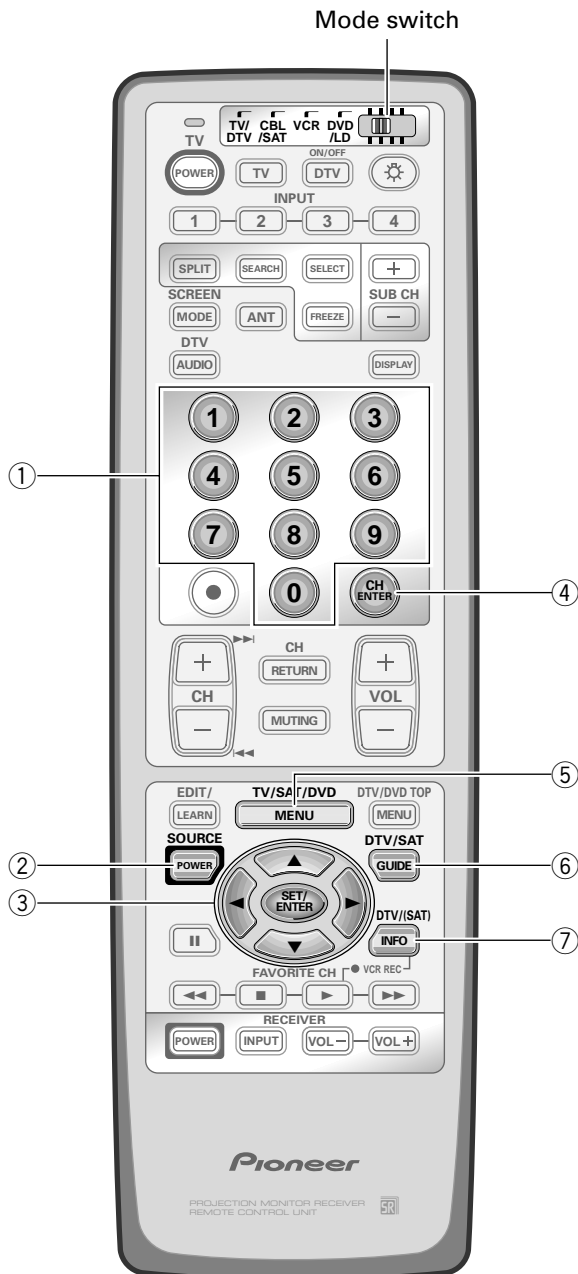

CABLE and SAT cannot be selected at the same time.

When SAT is preset by REMOTE CODE SET UP, the remote control unit buttons will function as shown below.

- When a satellite broadcast tuner is connected to the Monitor, press the input selector button that has the same number as the connected input terminal and set the mode switch to CBL/SAT.

The tuner can be operated using buttons ① to ⑦.

- Satellite broadcast tuners which are made by other makers and are not preset can also be operated with the remote control unit if buttons ① to ⑦ have learnt the functions (see page 70).

### ① Direct channel selection buttons

Press the button (or buttons) that corresponds to the channel that you wish to watch.

### ② SOURCE POWER button

Turns the power of the SAT (digital satellite system tuner) on and off.

### ③ Select/Set buttons (SET/ENTER, ◀, ▶, ▲, ▼)

◀, ▶, ▲, ▼: Press the button to select items on the SAT GUIDE screen or SAT MENU screen.

SET/ENTER: Press to activate the selected function.

### ④ CH ENTER button

Fix the selected channel with the direct channel selection buttons.

- Use this button to learn if necessary.

### ⑤ SAT MENU button

When this button is pressed, the satellite broadcasting menu screen will be displayed.

### ⑥ SAT GUIDE button

When this button is pressed, the satellite broadcasting guide screen will be displayed.

### ⑦ SAT INFO button

When this button is pressed, information on satellite broadcasting will be displayed.

- Use this button to learn if necessary.

## VCR CONTROL BUTTONS

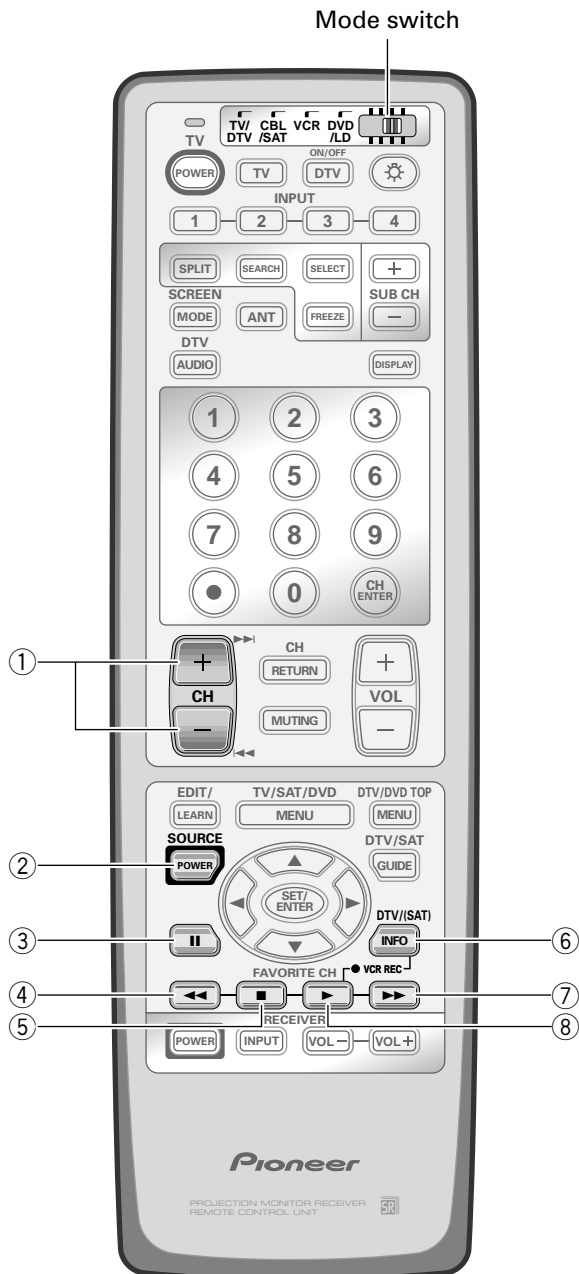

If the VCR is preset by REMOTE CODE SET UP, the remote control unit button will function as follows when the mode switch of the remote control unit is set to VCR.

When the input selector button having the same number as the input terminal connecting the VCR is pressed, the VCR can be operated using buttons ① to ⑧.

VCR which are made by other makers and are not preset can also be operated using the remote control unit if buttons ① to ⑧ have learnt the functions (see page 70).

- ① **CH (channel) +, - buttons**  
Press to select the channel of the TV tuner on the VCR.
- ② **SOURCE POWER button**  
Turns the power of the VCR on and off.
- ③ **|| (PAUSE/STILL) button**  
Set pauses and still pictures.
- ④ **◀◀ (REW) button**  
Rewinds the tape and allows picture search.
- ⑤ **■ (STOP) button**  
Stop the tape transport.
- ⑥, ⑧ **VCR REC (record) button**  
Press both buttons at the same time to start recording.
- ⑦ **▶▶ (FF) button**  
Rapidly advances the tape and allows picture search.
- ⑧ **▶ (PLAY) button**  
Selects playback.

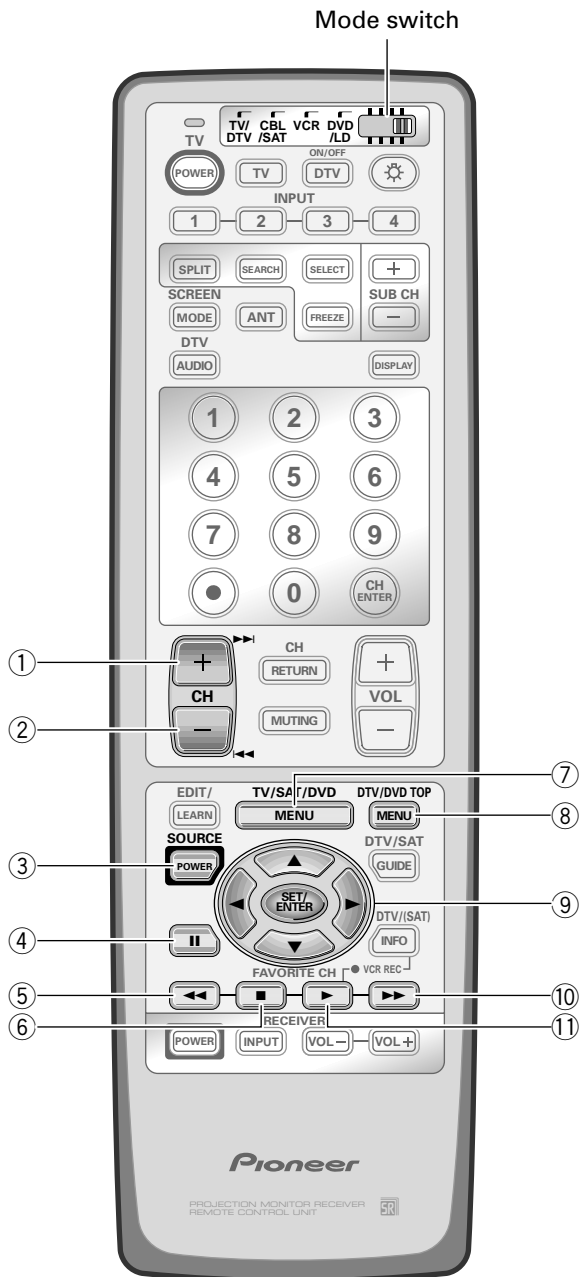

## DVD/LD CONTROL BUTTONS

When the input selector button having the same number as the input terminal connecting a DVD player or LD player is pressed, these players can be operated using buttons ① to ⑪ (buttons ⑦ to ⑨ are for DVD players only).

DVD player/LD player which are made by other makers and are not preset can also be operated using the remote control unit if buttons ① to ⑪ have learnt the functions (see page 70).

- ① **▶▶ (CHAPTER SEARCH) button**  
Pressing quickly once takes you to the start of the next chapter. Each time you press it, you move ahead to the start of the next chapter.
- ② **◀◀ (CHAPTER SEARCH) button**  
Pressing quickly once takes you to the start of the chapter currently playing. Each time you press it, you move back to the start of the previous chapter.
- ③ **SOURCE POWER button**  
Turns the power of the DVD/LD player on and off.
- ④ **|| (PAUSE/STILL) button**  
Set pauses and still pictures.
- ⑤ **◀◀ (SCAN) button**  
Continue pressing to rewind.
- ⑥ **■ (STOP) button**  
Playback is stopped when pressing once. With some DVD/LD players, pressing the button twice may open the disc tray.
- ⑦ **DVD MENU button (DVD only)**  
When this button is pressed, the DVD menu will be displayed.
- ⑧ **DVD TOP MENU button (DVD only)**  
When this button is pressed, the DVD top menu will be displayed.
- ⑨ **Select/Set buttons (SET/ENTER, ◀, ▶, ▲, ▼) (DVD only)**  
◀, ▶, ▲, ▼: Press the button to select items on the DVD MENU screen.  
SET/ENTER: Press to activate the selected function.
- ⑩ **▶▶ (SCAN) button**  
Continue pressing for fast forward.
- ⑪ **▶ (PLAY) button**  
Selects playback.

DVD and LD cannot be selected at the same time.

If the DVD/LD is preset by REMOTE CODE SET UP, the remote control unit button will function as follows when the mode switch of the remote control unit is set to DVD/LD.

# USING THE DIGITAL TUNER (sold separately) TO WATCH DTV

See the digital tuner installation manual for instructions on installing the SH-D09 digital tuner.

## 1 Connect the digital tuner.

- Connect the VHF/UHF and Cable TV signal to the digital tuner.

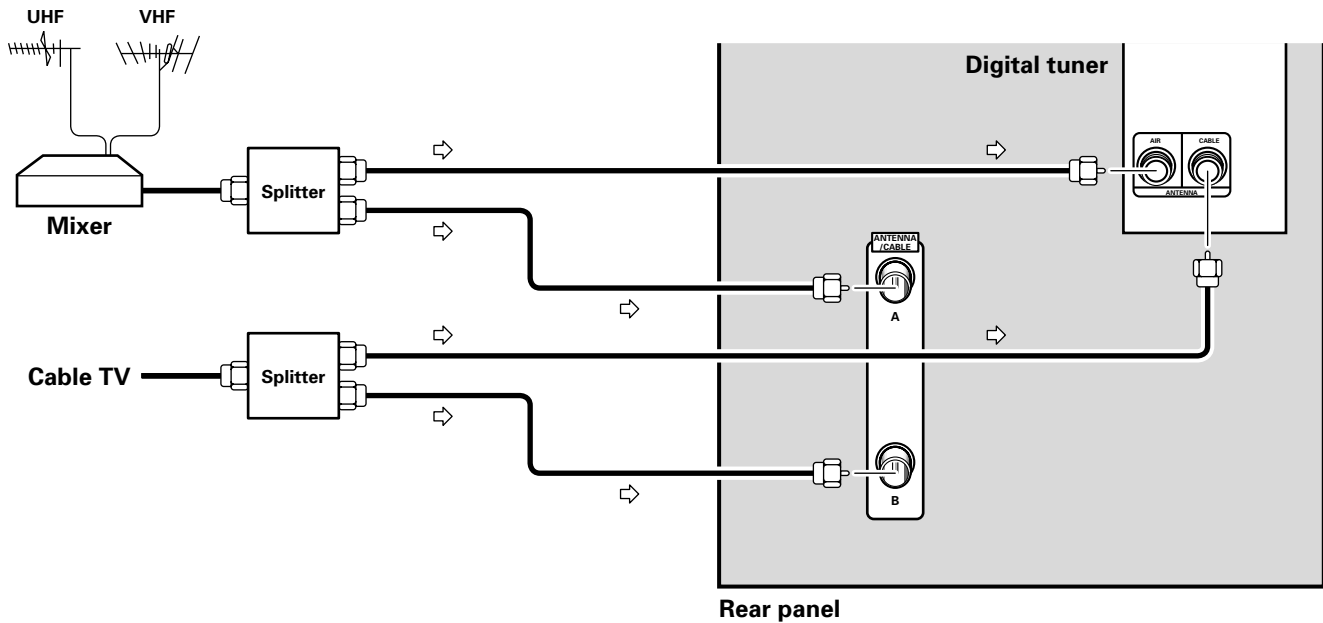

## 2 Set the mode switch to TV/DTV and then press the DTV button.

- Pressing the DTV button once more will turn the digital tuner off and restore the original input source.

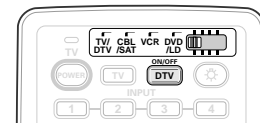

## 3 Initial setting. (Screen indicators may be changed without notice.)

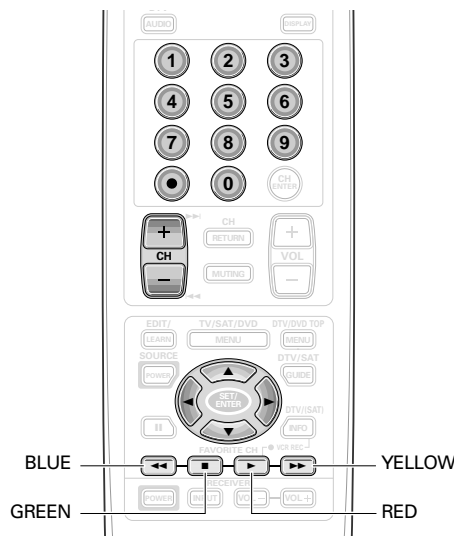

- ① When you use the digital tuner for the first time, the Initial Setup screen will initially appear.



- ② Press the YELLOW button.
  - The screen to the right will appear.



- ③ Press ▲, ▼, ◀, ▶ to select the desired Time Zone and Daylight Saving Observed setting.

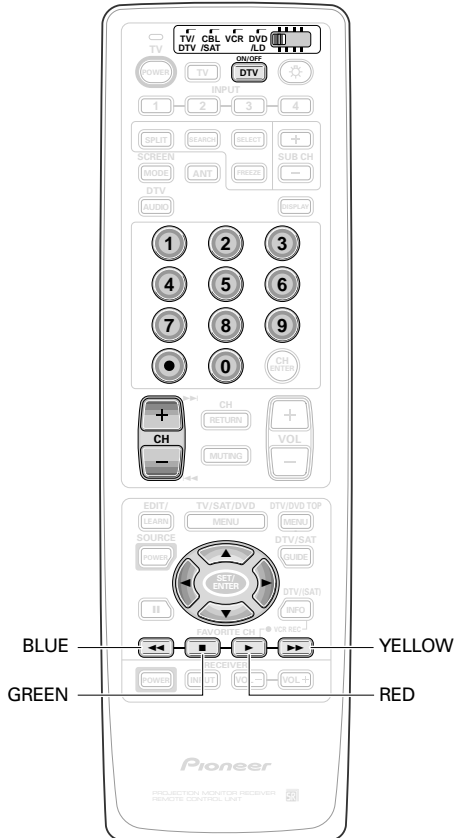

- ④ Press the YELLOW button.
  - The screen to the right will appear.
- ⑤ Press ◀, ▶ to select the Digital Audio Out setting.
- ⑥ Press the YELLOW button.
  - The screen to the right will appear.
- ⑦ Press ▲, ▼, ◀, ▶ to select the Input Source and the CATV Mode.
  - When you select "Air" as the Input Source, it not necessary to set the CATV Mode.
- ⑧ Press the RED button.
  - The screen to the right will appear in a few seconds.

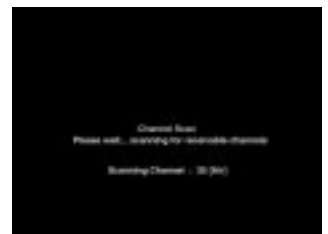

This screen will appear if the digital tuner is unable to set the channels. (See the operating instructions for digital tuner "SH-D09".)

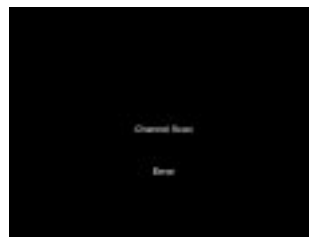

This screen will appear when channel scan has finished.



- ⑨ TV image then appears.

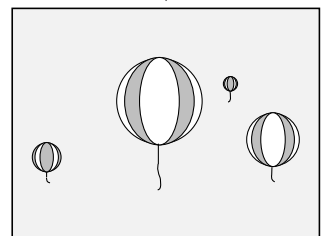

## 4 You have completed the initial settings.

## 5 Select a channel.

### Digital broadcast channels

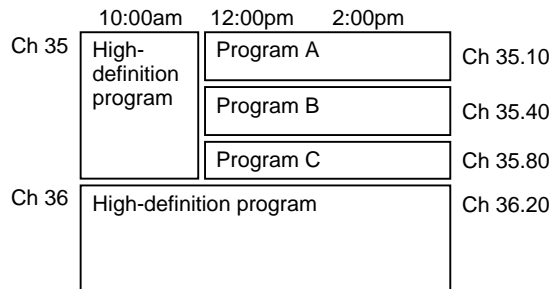

The above guide is for reference only.

High-definition broadcasts are digital and can be easily compressed, thereby creating multiple programs from a single broadcast. As shown in the example above, a high-definition broadcast can be televised as one program (channel 36.20) or it can be split into three different programs (channel 35 → channels 35.10, 35.40 and 35.80).

### Digital broadcast channel numbers

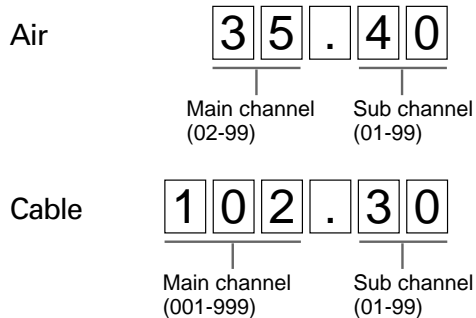

### Digital television

Digital Television (DTV) is an exciting new digital broadcast standard that will provide vastly improved picture and sound quality compared to current NTSC (National Television Standards Committee) analog technology. The DTV standard allows broadcasters the choice of transmitting single program High Definition Television (HDTV) or multiple Standard Definition Television (SDTV) programs.

### DTV signals

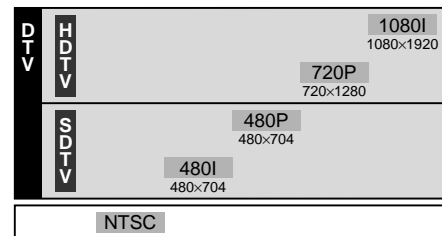

HDTV: 1080I\*<sup>1</sup> or 720P\*<sup>2</sup> signal is transmitted over a single channel at 1 million pixels per 1/60th of a second.

SDTV: 480P or 480I signals can be transmitted over many channels simultaneously. 480P at half a million pixels per 1/60th of a second. 480I at a quarter of a million pixels per 1/60th of a second.

NTSC: Present-day analog format in North America.

\*<sup>1</sup> *Interlaced Scanning: Picture constructed from interlacing two pairs of fields, each containing half the scan lines, as in today's analog TVs.*

\*<sup>2</sup> *Progressive Scanning: Picture constructed from single frames containing all the scan lines, progressing from top to bottom, as in today's PC monitors.*



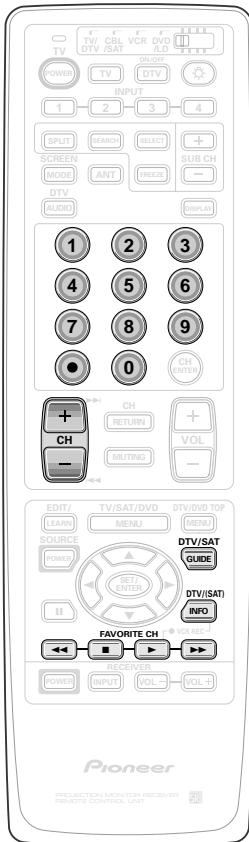











There are four methods for this.

① Select by pressing the number button and  button

(Example)

Channel 12.34 .....  →  →  →  → 

Channel 5.67 .....  →  →  →  → 

- Press the  button between the main and sub channels.

② Select using the CH +/- button

- Use channel filtering to specify any channels you wish to filter out.

③ Select using the FAVORITE CH button

- Select your desired channel from the 4 in the memory of each button: blue, green, red and yellow.
- Each time the button is pressed, the channel will be changed in order of the 4 channels in that button's memory.
- For instruction on how to set FAVORITE CH, see the operating instructions for digital tuner "SH-D09".

④ Select using the on screen display

- It is possible to select a channel using the channel list or banner that are displayed on the screen.  
For details, see the operating instructions for digital tuner "SH-D09".

## RECORDING DTV PROGRAMS

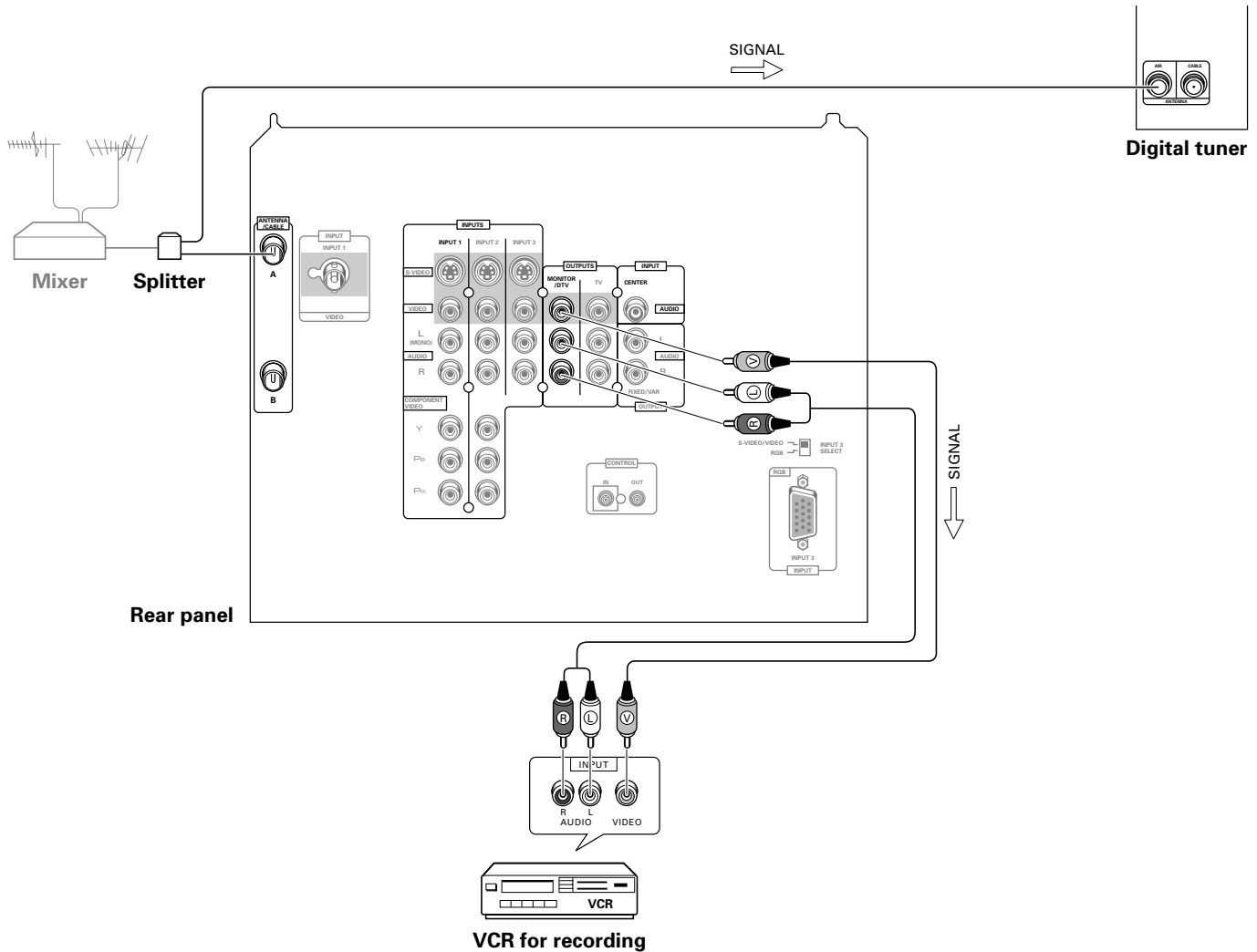

The following is the relationship between the picture size of the DTV broadcast that is received and the signal output from DTV OUTPUTS.

During 16:9 broadcast reception: Letter Box  
 During 4:3 broadcast reception: Normal

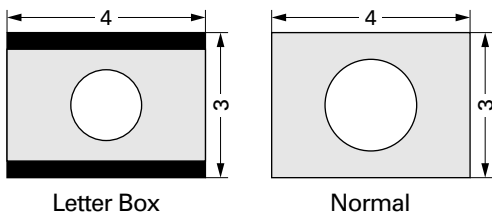

When recording a broadcast with a picture size of 16:9 on a VCR and viewing it with this monitor, it is possible to see its original aspect by setting SCREEN mode to ZOOM.

When DTV OUT is turned ON and a broadcast with picture size of 16:9 is received, the SCREEN mode on the monitor changes to ZOOM. When a broadcast with picture size of 4:3 has been received, it is possible to select ZOOM, FULL or 4:3 NORMAL as the SCREEN mode on the monitor.

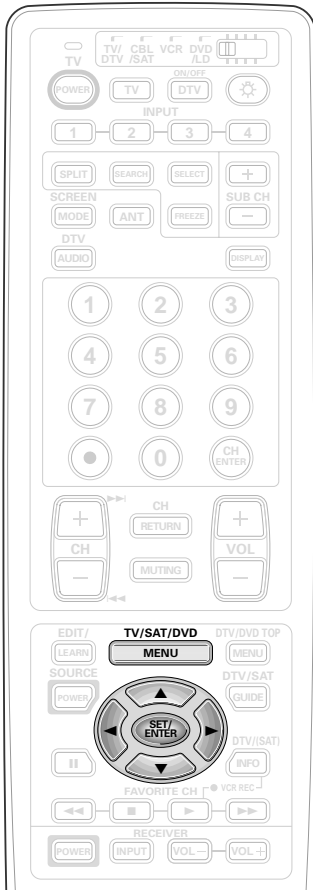

- 1** Connect the rear panel MONITOR/DTV OUTPUT jack and the VCR input jack.
- 2** Select the channel of the DTV program you wish to record. (Refer to steps 2 to 5 on pages 78 to 81.)
- 3** Press MENU and select SET UP by using the ▲ or ▼ button and then pressing SET/ENTER. (Refer to page 26.)
- 4** Select DTV OUT in the same way.

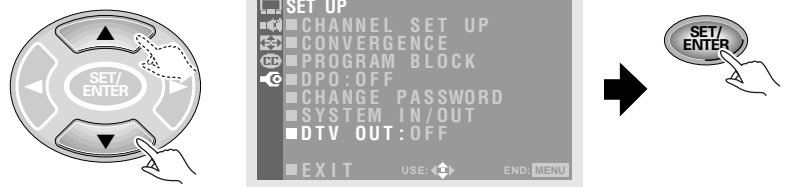

- 5** Set DTV OUT to ON.

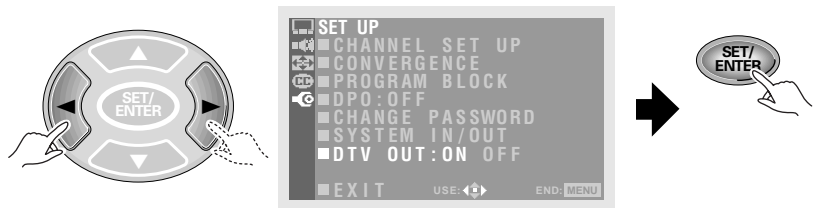

**NOTES:**

- The DTV OUT settings screen is displayed when an SH-D09 digital tuner is connected.
- Turning DTV OUT ON will make it impossible to change DTV channels. DTV OUT must be turned OFF in order to change channels.
- When the DTV OUT is turned to ON, the MONITOR/DTV OUTPUT jack becomes the DTV specialized output jack and an NTSC signal is output. Also note that the monitor picture quality will be equivalent to the picture quality described on NTSC.
- Turning the power to the Projection Monitor off will cause signals to no longer be output from the MONITOR/DTV OUTPUT jack, and you should accordingly be careful not to turn off the power while recording.
- If the power to the Projection Monitor is turned OFF then ON when DTV OUT is ON, DTV OUT turns OFF.
- When DTV OUT is turned to ON, the channel change, multi-screen (SPLIT, FREEZE, SEARCH screen) and screen position (V. POSITION) functions cannot be used.

- 6** After setting, press MENU to turn the menu off.
- 7** Signals will then be output from the MONITOR/DTV OUTPUT jack. Turn on the power to your VCR and then begin recording.

## CONNECTION WITH RECEIVER

- Before making or changing connections, set the power switch to off and unplug the power cord from the AC outlet.
- After completing connections, perform the "SYSTEM MODE setting" operation.

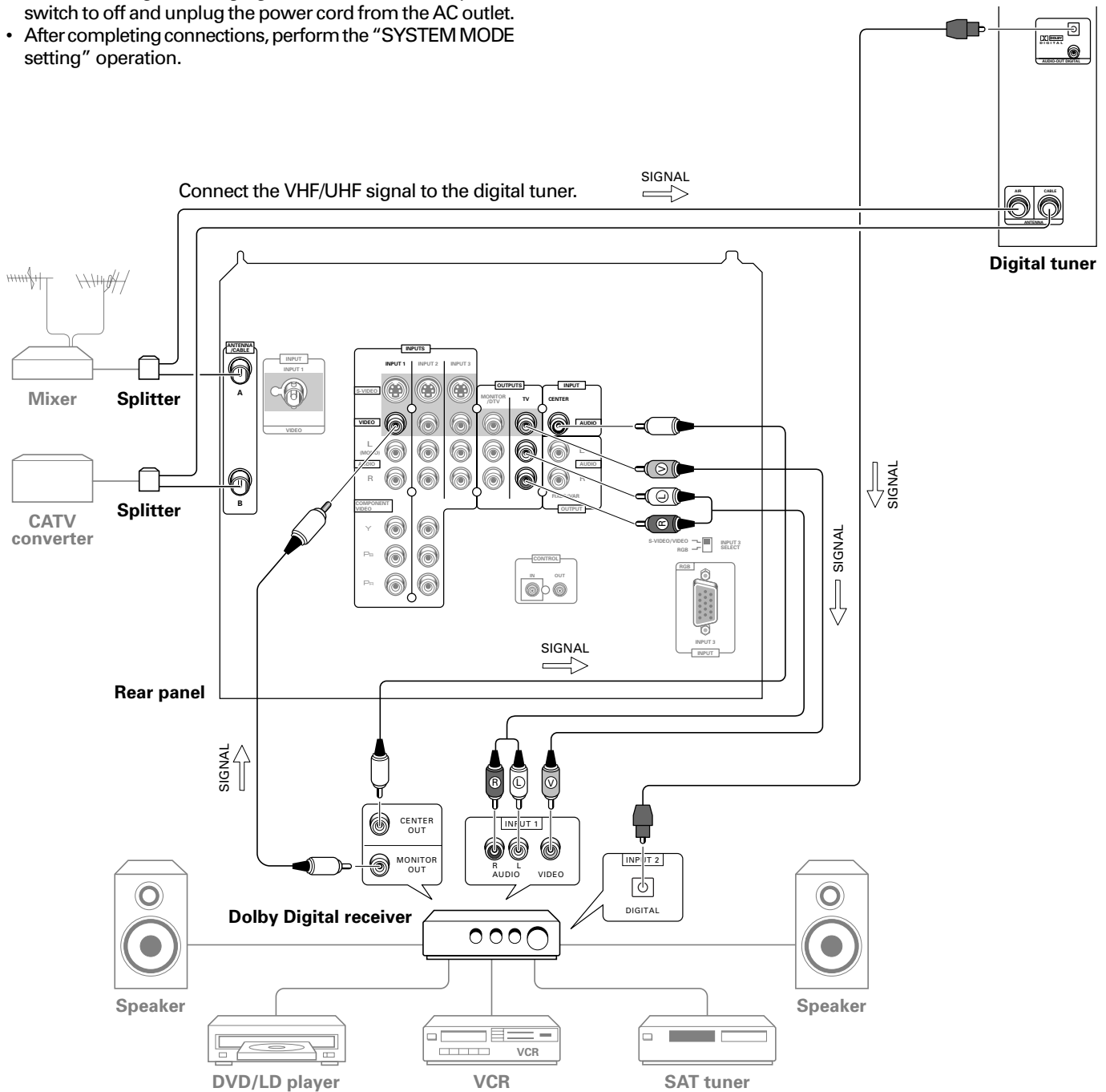

Manufactured under license from Dolby Laboratories Licensing Corporation. "Dolby" and the double-D symbol are trademarks of Dolby Laboratories Licensing Corporation.



## 1 Set the SYSTEM MODE to ON. (Refer to page 66.)

- Monitor input will be fixed to INPUT 1 and the picture from the input source selected by the receiver displayed.
- To watch TV, switch the receiver input to where the monitor's TV OUTPUT signal connects.
- Channels can be selected using the monitor's remote control.

## 2 Watching DTV

- ① Switch the receiver to where the digital tuner's signal connect.
- ② Set the mode switch to TV/DTV on the monitor's remote control.
- ③ Press the DTV button on the monitor's remote control.
  - Switching the monitor to DTV mode makes it possible to view a high-quality 1080i picture.
  - Each time the DTV button is pressed, the operating mode will switch between DTV and TV mode. To change the input source, first switch to TV mode and then use the receiver to switch the input source.
- ④ Use the monitor's remote control to select the channel.
- ⑤ Use the receiver to adjust the volume or select surround settings.

### NOTES:

- When SYSTEM MODE is turned ON and the system is connected to a non-Dolby Digital receiver, no DTV audio output will be produced, and SYSTEM MODE should accordingly be turned OFF at such times.
- Turning SYSTEM MODE ON will cause all monitor input to be input from INPUT 1, and SYSTEM MODE should accordingly be turned OFF when connected to RGB input.

# MENU INDEX

Main menu (See page 26)

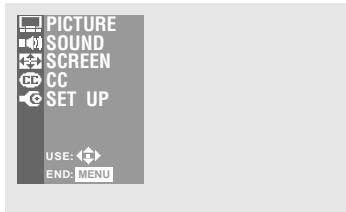

PICTURE adjustment menu (See page 48)

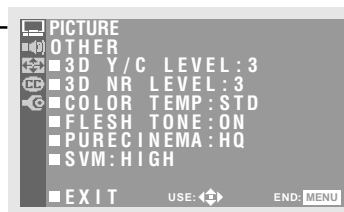
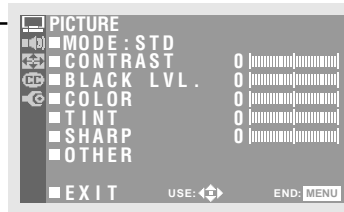

SOUND adjustment menu (See page 55)

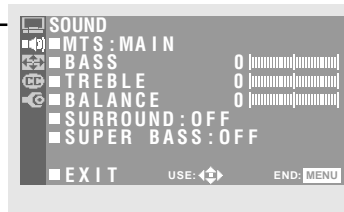

SCREEN setting menu (See page 39)



SET UP menu (See page 28)



Closed Caption menu (See page 42)



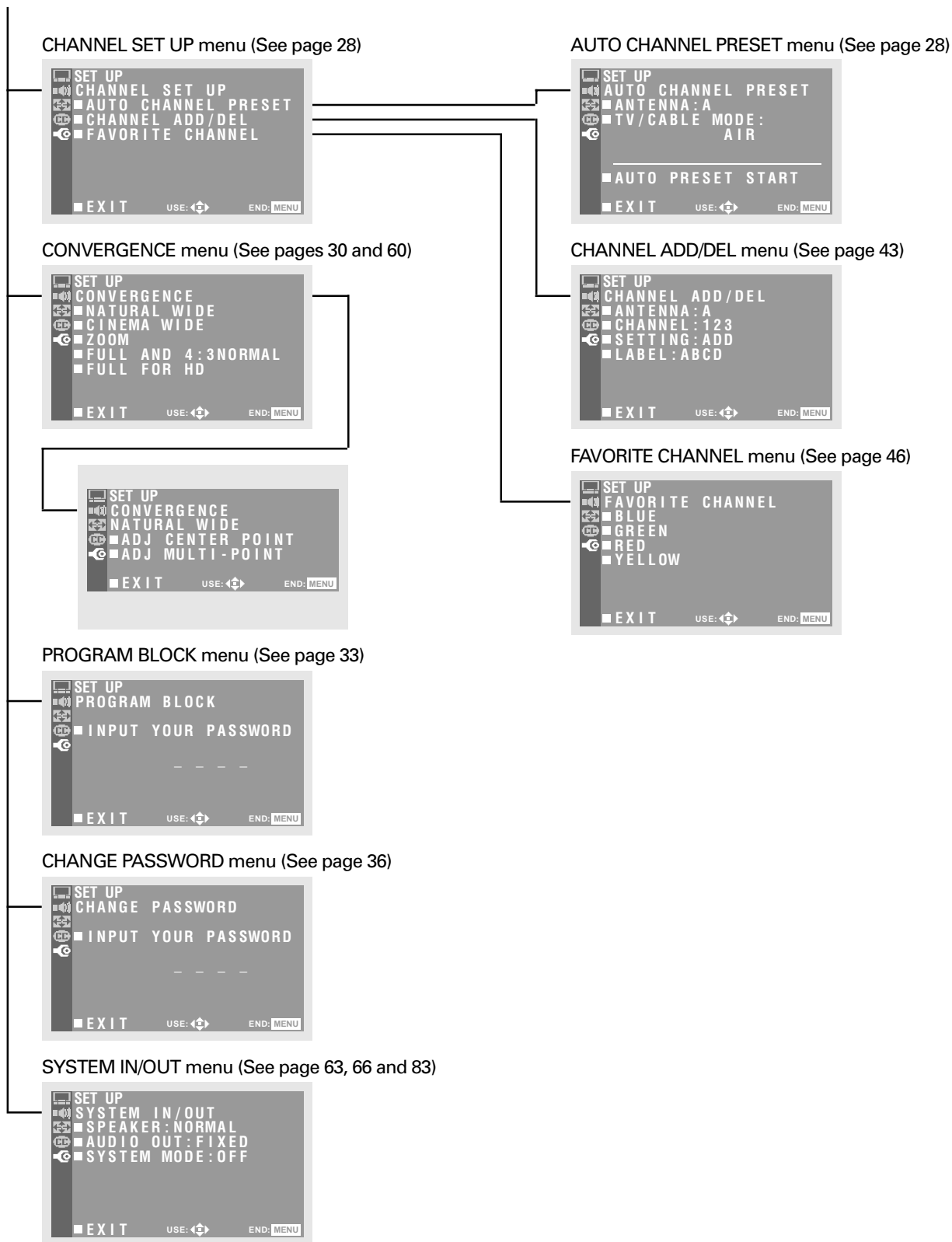

# TROUBLESHOOTING

Incorrect operations are often mistaken for trouble and malfunctions. If you think that there is something wrong with the Monitor, check the points below. Sometimes the trouble may lie in another component. Investigate the other component and electrical appliances being used.

If the trouble cannot be rectified even after exercising the checks listed below, ask your nearest PIONEER authorized service center or your dealer to carry out repair work.

SYMPTOM	CAUSE/REMEDY	PAGES
<b>The power will not turn on</b>	The power plug is disconnected. The MAIN POWER switch is not turned on.	12 12
<b>The Monitor is inoperative</b>	Press the RETURN button. External influences such as lightning and static electricity may prevent the Monitor from operating normally. In such cases, turn on/off the MAIN POWER supply, disconnect the power cord, connect it again a few minutes later, and try operating the Monitor.	20
<b>A TV broadcast station cannot be received</b>	The antenna cable is not connected properly. The antenna cable is broken or shorted. Channels have not been preset correctly.	14 28
<b>No picture appears on the screen</b>	The DVD/LD player or VCR is not connected and operated properly. The input selector has not been set to the desired input source (such as DVD/LD player and VCR).	16
<b>No sound</b>	The MUTING button has been on (volume indicator becomes red).	25
<b>The Monitor cannot be operated using the remote control unit</b>	The batteries in the battery compartment are not correctly matching the (+ and -) polarities. The battery has worn out. Strong lights striking the remote control sensor may cause the internal microcomputer to malfunction.	13 13
<b>The color is not normal</b> <b>The color is too dim or too sharp</b> <b>The color is uneven</b>	Adjust the picture quality. The room is too bright. Adjust the color convergence.	50 30 and 60
<b>Picture does not appear immediately after changing channels</b>	TV-CATV MODE is set incorrectly.	28
<b>Closed caption is not displayed</b>	Check the CC menu settings. (As at October 1, 1999, limited closed caption information is broadcasted in field 1. The closed caption information that will be broadcasted in field 2 in the future may not be decoded with this unit). The character information is not displayed normally during special playback, such as slow and still play, of the VCR or Videodisc player. Closed caption signal may not be output depending on the VCR, Videodisc player or other components (for details, please consult the manufacturer of your unit). Check that the video cassette, Videodisc or broadcasting being played contains closed caption data (The video cassette and Videodisc containing closed caption data carries the  mark etc.).	



The following symptoms may be mistakenly regarded as malfunctioning.  
In many cases, they are not the faults of the Monitor.

<b>SYMPTOM</b>	<b>CAUSE</b>
<b>When there are 2 or 3 layers of images (ghost phenomenon)</b>	Influence of waves from the broadcast stations reflected by nearby mountains and high-rise buildings.
<b>Spots appears on the screen Noises are audible</b>	Influence of harmful waves produced by motor equipments such as hair dryers and vacuum cleaners, ignition devices such as cars and motorbikes, flashing devices such as thermostats and electricity discharge by transmission/distribution lines.
<b>Stripes appears on the screen Noises are audible</b>	Mixing of electric waves from TV stations FM stations, amateur wireless, public wireless (simple wireless), etc., or nearby personal computer, TV, VCR, audio equipment.
<b>When a crack sound is heard some time after the power is turned on</b>	Sometimes, creaking sounds will be produced when cabinets expand or contract due to changes in the surrounding temperature. Do not suspect a fault.
<b>The power goes off momentarily, after a sudden pop sound</b>	The power was turned off momentarily due to the protection circuit to correct the electric discharge phenomenon in the CRT. Do not suspect fault.

# SPECIFICATIONS

## Display and amplifier section

Reception system ..... American TV standard NTSC system  
Screen size ..... 58" (PRO-610HD)  
53" (PRO-510HD)  
CRT ..... 7" High focus CRT x 3  
Brightness (White peak) ..... 420 Foot-Lambert (PRO-610HD)  
500 Foot-Lambert (PRO-510HD)  
[White window signal input contrast Max.]  
without protective screen  
Horizontal resolution ..... More than 1250 lines (PRO-610HD)  
More than 1150 lines (PRO-510HD)  
[Input digital test pattern (1250 lines resolution)]  
Input terminals ..... 4 video inputs  
4 S-VIDEO input jacks (Y/C separate INPUT)  
2 COMPONENT VIDEO INPUT jacks (Y, Pb, Pr)  
4 audio inputs  
CENTER INPUT jack  
Mini D-sub 15 pin INPUT jack (RGB)  
Output terminals ..... MONITOR/DTV, TV, AUDIO  
Input terminal signal ratings  
Input signal  
Video signal:  
Composite and S-VIDEO (Y): 1.0 Vp-p (75 ohms load)  
COMPONENT (Y): 1.0 Vp-p (75 ohms load)  
(Pb, Pr): 0.7 Vp-p (75 ohms load)  
Mini D-sub 15 pin (RGB): 0.7 Vp-p (75 ohms load)  
Audio signal (including CENTER): 400mV rms  
Input impedance ..... Video input: 75 ohms  
Audio input (including CENTER): 22 kilo-ohms  
or more  
Input signal polarity (Video) ..... Synchronized negative  
Output terminal signal ratings  
Output signal ..... Video signal: 1 Vp-p (75 ohms load)  
Audio signal: 500 mV rms (100 % modulation)  
Output impedance ..... Video output: 75 ohms  
Audio output: Less than 1 kilo-ohms  
Effective output  
Front both channels driven ..... 10 W + 10 W  
(THD. 1 % 1 kHz, 8 ohms)  
Built-in speaker system ..... 16 cm (6-5/16 in) full range x 2

## Tuner section

Circuit type ..... Video signal detection:  
PLL full synchronous detection  
PLL digital synthesizer system  
Audio multiplex: BTSC system  
Reception channels ..... VHF; CH2-CH13, UHF; CH14-CH69  
CATV (STANDARD, IRC or HRC)  
CATV 1-125 CH  
Antenna terminals ..... Antenna terminal, 75 ohms UNBAL,  
F-type connector (VHF, UHF MIXED)

## Electrical section, miscellaneous

Power requirements ..... 120 V AC, 60 Hz  
Power consumption  
At time of shipment ..... 325 W, 600 VA (CSA)  
With digital tuner installed ..... 360 W, 660 VA (CSA)  
External dimensions  
PRO-610HD ..... 1378 (W) x 675 (D) x 1351 (H) mm  
54-1/4 (W) x 26-9/16 (D) x 53-3/16 (H) inch  
PRO-510HD ..... 1268 (W) x 640 (D) x 1289 (H) mm  
49-15/16 (W) x 25-3/16 (D) x 50-3/4 (H) inch  
Weight of main unit  
PRO-610HD ..... 141 kg (311 lb 9 oz)  
PRO-510HD ..... 127 kg (280 lb 6 oz)

## Wireless remote control unit

Operation system ..... Infrared remote control system  
Power source ..... Two DURACELL® "AA" MN1500 1.5 V  
ALKALINE dry cell batteries  
Dimensions ..... 66 (W) x 24.6 (H) x 226.5 (D) mm  
2-19/32 (W) x 31/32 (H) x 8-29/32 (D) inch  
Weight ..... 170 g (4 oz) (without batteries)

## Accessories

Operating instructions ..... 1  
Warranty card ..... 1  
Remote control unit ..... 1  
DURACELL® "AA" MN1500 1.5V  
Alkaline dry cell batteries ..... 2  
Protective screen ..... 1  
Panel frame ..... 2  
Side frame cover ..... 2  
Frame cover ..... 2  
Panel frame attaching screw ..... 10 (PRO-610HD)  
6 (PRO-510HD)

### NOTE:

*Specifications and design are subject to possible modifications without notice due to improvements.*



Should this product require service in the U.S.A. and you wish to locate the nearest Pioneer Authorized Independent Service Company, or if you wish to purchase replacement parts, operating instructions, service manuals, or accessories, please call the number shown below.

8 0 0 – 4 2 1 – 1 4 0 4

Please do not ship your product to Pioneer without first calling the Customer Service Department at the above listed number for assistance.

PIONEER ELECTRONICS SERVICE, INC.  
CUSTOMER SERVICE DEPARTMENT  
P.O. BOX 1760, LONG BEACH,  
CA 90801-1760, U.S.A.

For warranty information please see the Limited Warranty sheet included with your product.

Should this product require service in Canada, please contact a Pioneer Canadian Authorized Dealer to locate the nearest Pioneer Authorized Service Company in Canada.

Alternatively, please contact the Customer Service Department at the following address:

Pioneer Electronics of Canada, Inc.  
Customer Service Department  
300 Allstate Parkway, Markham, Ontario  
L3R 0P2  
(905) 479-4411  
1-877-283-5901

For warranty information please see the Limited Warranty sheet included with your product.

Si ce produit doit être réparé au Canada, veuillez vous adresser à un distributeur autorisée Pioneer au Canada pour obtenir le nom de la Société de Service Autorisée Pioneer le plus près de chez vous. Ou encore, veuillez vous communiquer avec le Service de Clientèle de Pioneer:

Pioneer électroniques du Canada, Inc.  
Département de service au consommateurs  
300 Allstate Parkway, Markham, Ontario  
L3R 0P2  
(905) 479-4411  
1-877-283-5901

Pour obtenir des renseignements sur la garantie, veuillez vous reporter au feuillet sur la Garantie Limitée qui accompagne le produit.

Published by Pioneer Corporation.  
Copyright © 1999 Pioneer Corporation.  
All rights reserved.

**PIONEER CORPORATION**

4-1, Meguro 1-Chome, Meguro-ku, Tokyo 153-8654, Japan

**PIONEER ELECTRONICS [USA] INC.** P.O. BOX 1540, Long Beach, California 90801-1540

**PIONEER ELECTRONICS OF CANADA, INC.** 300 Allstate Parkway, Markham, Ontario L3R 0P2, Canada

**PIONEER ELECTRONIC [EUROPE] N.V.** Haven 1087, Keetberglaan 1, 9120 Melsele, Belgium TEL: 03/570.05.11

**PIONEER ELECTRONICS AUSTRALIA PTY. LTD.** 178-184 Boundary Road, Braeside, Victoria 3195, Australia, TEL: [03] 9586-6300

**PIONEER ELECTRONICS DE MEXICO S.A. DE C.V.** San Lorenzo Num 1009 3er piso Desp. 302 Col. Del Valle, Mexico D.F. C.P. 03100 TEL: 5-688-52-90

## Free Manuals Download Website

<http://myh66.com>

<http://usermanuals.us>

<http://www.somanuals.com>

<http://www.4manuals.cc>

<http://www.manual-lib.com>

<http://www.404manual.com>

<http://www.luxmanual.com>

<http://aubethermostatmanual.com>

Golf course search by state

<http://golfingnear.com>

Email search by domain

<http://emailbydomain.com>

Auto manuals search

<http://auto.somanuals.com>

TV manuals search

<http://tv.somanuals.com>