

Pioneer *sound.vision.soul*

**AUDIO/VIDEO MULTI-CHANNEL
AMPLIFIER**

VSA-AX10

Operating Instructions

Thank you for buying this Pioneer product.
Please read through these operating instructions so you will know how to operate your model properly.
After you have finished reading the instructions, put them away in a safe place for future reference.

IMPORTANT



The lightning flash with arrowhead symbol, within an equilateral triangle, is intended to alert the user to the presence of uninsulated 'dangerous voltage' within the product's enclosure that may be of sufficient magnitude to constitute a risk of electric shock to persons.

CAUTION

**RISK OF ELECTRIC SHOCK
DO NOT OPEN**

CAUTION:

TO PREVENT THE RISK OF ELECTRIC SHOCK, DO NOT REMOVE COVER (OR BACK). NO USER-SERVICEABLE PARTS INSIDE. REFER SERVICING TO QUALIFIED SERVICE PERSONNEL.



The exclamation point within an equilateral triangle is intended to alert the user to the presence of important operating and maintenance (servicing) instructions in the literature accompanying the appliance. **H002_En**

Replacement and mounting of an AC plug on the power supply cord of this unit should be performed only by qualified service personnel.

IMPORTANT

FOR USE IN THE UNITED KINGDOM

The wires in this mains lead are coloured in accordance with the following code :

Blue : Neutral
Brown : Live

If the plug provided is unsuitable for your socket outlets, the plug must be cut off and a suitable plug fitted.

The cut-off plug should be disposed of and must not be inserted into any 13 amp socket as this can result in electric shock. The plug or adaptor or the distribution panel should be provided with 10A fuse. As the colours of the wires in the mains lead of this appliance may not correspond with coloured markings identifying the terminals in your plug, proceed as follows :

The wire which is coloured blue must be connected to the terminal which is marked with the letter N or coloured black.

The wire which is coloured brown must be connected to the terminal which is marked with the letter L or coloured red.

Do not connect either wire to the earth terminal of a three pin plug.

NOTE

After replacing or changing a fuse, the fuse cover in the plug must be replaced with a fuse cover which corresponds to the colour of the insert in the base of the plug or the word that is embossed on the base of the plug, and the appliance must not be used without a fuse cover. If lost replacement fuse covers can be obtained from: your dealer.

Only 10 A fuses approved by B.S.I. or A.S.T.A to B.S. 1362 should be used. **H005BEn**

WARNING: BEFORE PLUGGING IN THE UNIT FOR THE FIRST TIME, READ THE FOLLOWING SECTION CAREFULLY. THE VOLTAGE OF THE AVAILABLE POWER SUPPLY DIFFERS ACCORDING TO COUNTRY OR REGION, BE SURE THAT THE POWER SUPPLY VOLTAGE OF THE AREA WHERE THIS UNIT WILL BE USED MEETS THE REQUIRED VOLTAGE (E.G., 230V OR 120V) WRITTEN ON THE REAR PANEL. **H041 En**

WARNING: NO NAKED FLAME SOURCES, SUCH AS LIGHTED CANDLE, SHOULD BE PLACED ON THE APPARATUS. IF NAKED FLAME SOURCES ACCIDENTALLY FALL DOWN, FIRE SPREAD OVER THE APPARATUS THEN MAY CAUSE FIRE. **H044 En**

WARNING: THE APPARATUS IS NOT WATERPROOFS, TO PREVENT FIRE OR SHOCK HAZARD, DO NOT EXPOSE THIS APPLIANCE TO RAIN OR MOISTURE AND DO NOT PUT ANY WATER SOURCE NEAR THIS APPARATUS, SUCH AS VASE, FLOWER POT, COSMETICS CONTAINER AND MEDICINE BOTTLE ETC. **H001AEn**

POWER-CORD CAUTION

S002 En

Handle the power cord by the plug. Do not pull out the plug by tugging the cord and never touch the power cord when your hands are wet as this could cause a short circuit or electric shock. Do not place the unit, a piece of furniture, etc., on the power cord, or pinch the cord. Never make a knot in the cord or tie it with other cords. The power cords should be routed such that they are not likely to be stepped on. A damaged power cord can cause a fire or give you an electrical shock. Check the power cord once in a while. When you find it damaged, ask your nearest PIONEER authorized service center or your dealer for a replacement.

This product is for general household purposes. Any failure due to use for other than household purposes (such as long-term use for business purposes in a restaurant or use in a car or ship) and which requires repair will be charged for even during the warranty period. **K041_En**

Installing the Amplifier

VENTILATION: When installing this unit, make sure to leave space around the unit for ventilation to improve heat radiation (at least 60 cm at top, 10 cm at rear and front, and 30 cm at each side).

WARNING: Slot and openings in the cabinet are provided for ventilation and to ensure reliable operation of the product and to protect it from overheating, to prevent fire hazard, the openings should never be blocked and covered with items, such as newspapers, tablecloths, curtains, etc. Also do not put the apparatus on the thick carpet, bed, sofa, or fabric having a thick pile. **H040 En**

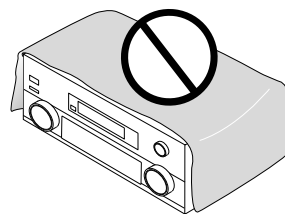

Operating Environment **H045 En**

Operating environment temperature and humidity: +5°C – +35°C (+41°F – +95°F); less than 85%RH (cooling vents not blocked)

Do not install in the following locations

- Location exposed to direct sunlight or strong artificial light
- Location exposed to high humidity, or poorly ventilated location

This product complies with the Low Voltage Directive (73/23/EEC, amended by 93/68/EEC), EMC Directives (89/336/EEC, amended by 92/31/EEC and 93/68/EEC). **H015AEn**

Features

Advanced Multichannel Stereophonic Concept

The VSA-AX10 amplifier is constructed with Pioneer's industry-leading advanced multichannel stereophonic concept. This means it is designed to reproduce music and movie soundtracks as close as possible to the intentions of the producer during mastering. The amplifier uses a revolutionary 3-D Frame Construction technique and a Symmetrical Power Train Design, with high-performance Advanced Direct Energy MOS-FET output devices, generating 170 watts (DIN 6 Ω) of power for 7 independent channels. True 32-bit Tri Digital Signal Processing is used for ultra realistic sound.

Multi-Channel Acoustic Calibration System (MCACC)

In order to make setting up as easy as possible for users we have created the MCACC system. This unique and convenient way of getting good surround sound from the amplifier makes trouble-free setup a snap. With the included microphone plugged into the front panel the MCACC system creates a monitoring environment to establish the parameters of the sound for the specific room you are using. The MCACC system adjusts the parameters to establish excellent surround sound effects and offers you studio quality home theater sound with minimum effort.

Universal Player Compatibility (DVD Audio)

This amplifier features eight discrete channels of analog inputs, each with 96kHz/24bit A/D converters. This makes it ideal for use with all audio formats, including DVD-Audio, and allows very high quality digital processing. Furthermore, using the MCACC system you can setup this amplifier for optimal DVD-Audio playback.

Next Generation THX Standards and New Digital Formats

The VSA-AX10 is the first amplifier in the world to be THX Ultra2 certified. Among the new THX technologies is ASA (Advanced Speaker Array), which can process any 5.1 channel source for 7.1 channel playback (THX Ultra2 Cinema and THX MusicMode), or 6.1 channel playback (THX Surround EX). THX Surround EX technology makes possible true playback of Dolby Digital Surround EX soundtracks. The VSA-AX10 is also among the first generation of products able to play discs that feature high quality DTS 96/24 soundtracks. Naturally, you can also play all existing audio formats, including the recently developed Dolby Pro Logic II and DTS-ES Extended Surround formats. On the video side, the component video output is fully compatible with high definition, progressive-scan digital video (720p).

Lucasfilm and THX are trademarks or registered trademarks of Lucasfilm Ltd. © Lucasfilm Ltd. & TM. Surround EX is a jointly developed technology of THX and Dolby Laboratories and is a trademark of Dolby Laboratories. All rights reserved. Used under authorization.

Manufactured under license from Dolby Laboratories. "Dolby", "Pro Logic", "Surround EX" and double-D symbol  are trademarks of Dolby Laboratories.

"DTS", "DTS-ES Extended Surround" and "Neo:6" are trademarks of Digital Theater Systems, Inc.

Advanced Cinema & Advanced Concert Modes

The Advanced Cinema and Advanced Concert modes applied to movie soundtracks and music deliver a range of digital effects, giving you a wide range of listening possibilities.

New LCD Touch Panel Remote Control

This touch sensitive screen remote control is the latest in convenient technology. It's easily viewed screen can access a huge amount of different buttons and this remote can instantly change screens, allowing one button to have just one, clearly marked purpose. This remote can be used to operate a variety of other components simply by recalling the appropriate setup codes or by using the learning function to teach the remote control new commands. In addition, you can personalize your remote control with the key label and item memo functions so that it reflects your personal home setup. The remote also has a lock feature to make sure none of the settings are changed accidentally.

Pioneer Video Converter

The Pioneer Video Converter allows more flexibility in hooking up video components as you can use a wide range of cords interchangeably.

The Energy-saving Design

This amplifier is designed to use 0.65 W of energy when in standby mode.

Features	3
Before You Start	6
Checking the Supplied Accessories	6
Preparing the Remote Control	6
Loading the batteries	6
Remote Control Battery Alarm	6
The Touch Pen & Lock	7
Remote Control Cushions	7
Operating range of remote control unit	7
Opening the Front Panel	7
Setting Up the Remote Control	8
Remote Control Backlight	9
Quick Start Guide Part 1	10
Home Theater: The Basics	10
1) Your Home System	10
2) The Source Material	10
3) The Listening Modes	10
Conclusion	10
1 Hooking Up Your DVD Player & TV	11
Digital Connections	11
2 Speaker Connections	12
3 Setting up the Main Unit	13
4 Assigning the Digital Inputs	13
Quick Start Guide Part 2	14
1 Auto Surround Sound Setup	14
2 Playing a DVD with Surround Sound	17
3 Personalizing Your Sound	17
Connecting Your Equipment	18
Connecting your TV	18
Video Converter	18
Connecting Video Components	19
Connecting a DVD, DVD/LD or LD player	19
Connecting VCRs or DVRs	20
Connecting a Video Component to the Front Panel	20
Connecting Satellite TV (SAT) Components	21
Connecting Analog Audio Components	22
Cassette deck placement	23
Connecting to the Multi Channel Analog Inputs (DVD-A or Super Audio CD compatible player) ...	23
Connecting Digital Audio Components	24
Digital Input Default Settings	25
Connecting Speakers	26
Placing Your Speakers	27
Speaker placement	27
AC Power Cord	28
AC Outlet [switched 100w max]	28

Displays & Controls	29
Remote Control	29
Basic Amplifier LCD Screens	30
Amplifier MAIN Screen	30
Amplifier SUB Screen	31
Back Panel	32
Front Panel	34
Display	36
Setting Up for Surround Sound	37
SPEAKER SYSTEMS	38
CHANNEL DELAY	41
CHANNEL LEVEL (channel balance)	42
Acoustic Calibration EQ	43
Check the Auto Settings	45
Basic Operation	46
Stereo and Multichannel Playback	46
Switching the channels used for playback (LISTENING CH SELECT)	47
Switching ANALOG/DIGITAL Signal Input	48
Playback of 96kHz 24 bit sound formats	48
Listening Modes	49
STEREO modes	49
STANDARD modes	49
HOME THX modes	50
ADVANCED CINEMA modes	51
ADVANCED CONCERT modes	52
Adjusting the Effect of Advanced Listening Modes	52
Listening with Acoustic Calibration EQ	53
Reducing Noise During Playback (DIGITAL NR Function)	53
Listening in MIDNIGHT Mode	54
Listening in LOUDNESS Mode	54
Adjusting Bass and Treble (Tone Control)	55
DVD Audio/MULTI CHANNEL IN Playback	56
DUAL MONO Setting and Playback	57
Input Attenuator	57
Tape 2 Monitor	57
Using the Headphones	58
Video Select	58
Adjusting the Brightness of the Display	59
Status Display	59

Remote Control of Other Components	60
Setting Up the Remote Control to Control Other Components	60
Recalling Settings Stored in the Remote Control	60
Programming Signals from Other Remote Controls (LEARNING Mode)	62
Locking the Settings	63
Using the Remote Control with Other Components	64
DVD and TV operations	64
Setting up the DIRECT FUNCTION	65
Using Other Functions	66
Recording from Audio/Video Components	66
Speaker System B Setup	67
Stereo playback in another room	67
Bi-amping the front speakers	67
Bi-wiring your speakers	67
Switching A/B Speaker System	68
Connecting Additional Amplifiers	69
Pre Out Power Setup	70
The PIONEER SR System: Operating other PIONEER components	71
Multi Operations	72
Performing multi operations	73
System off	74
Using System off	75
Editing Remote Control Screen Names (ITEM MEMO)	76
Editing Buttons Names (KEY LABEL)	77
Resetting the Main Unit	79
Resetting the Remote Control	79
Advanced Setup	80
Assigning the Digital Input	80
Assigning the Component Video Inputs	81
Expert Setup	82
OSD (On-screen Display) ADJUSTMENT	83
BASS PEAK LEVEL	84
DYNAMIC RANGE CONTROL	85
MULTI CH IN SELECT	86
FUNCTION RENAME	87
THX Audio Setup	88
THX Ultra2 Subwoofer Setup	88
Surround Back Speaker Position	89
Re-Equalization	90

Techno Tidbits & Problem-solving	91
Dolby	91
Dolby Digital	91
Dolby Pro Logic II	92
Dolby Digital Surround EX	92
MPEG Audio	92
DTS	93
DTS	93
DTS-ES	93
DTS Neo:6	93
DTS 96/24	93
THX	93
Speaker Placement Information	95
Audio Block Diagram	97
Troubleshooting	98
Specifications	103

Features	3
Before You Start	6
Checking the Supplied Accessories	6
Preparing the Remote Control	6
Loading the batteries	6
Remote Control Battery Alarm	6
The Touch Pen & Lock	7
Remote Control Cushions	7
Operating range of remote control unit	7
Opening the Front Panel	7
Setting Up the Remote Control	8
Remote Control Backlight	9
Quick Start Guide Part 1	10
Home Theater: The Basics	10
1) Your Home System	10
2) The Source Material	10
3) The Listening Modes	10
Conclusion	10
1 Hooking Up Your DVD Player & TV	11
Digital Connections	11
2 Speaker Connections	12
3 Setting up the Main Unit	13
4 Assigning the Digital Inputs	13
Quick Start Guide Part 2	14
1 Auto Surround Sound Setup	14
2 Playing a DVD with Surround Sound	17
3 Personalizing Your Sound	17
Connecting Your Equipment	18
Connecting your TV	18
Video Converter	18
Connecting Video Components	19
Connecting a DVD, DVD/LD or LD player	19
Connecting VCRs or DVRs	20
Connecting a Video Component to the Front Panel	20
Connecting Satellite TV (SAT) Components	21
Connecting Analog Audio Components	22
Cassette deck placement	23
Connecting to the Multi Channel Analog Inputs (DVD-A or Super Audio CD compatible player) ...	23
Connecting Digital Audio Components	24
Digital Input Default Settings	25
Connecting Speakers	26
Placing Your Speakers	27
Speaker placement	27
AC Power Cord	28
AC Outlet [switched 100w max]	28

Displays & Controls	29
Remote Control	29
Basic Amplifier LCD Screens	30
Amplifier MAIN Screen	30
Amplifier SUB Screen	31
Back Panel	32
Front Panel	34
Display	36
Setting Up for Surround Sound	37
SPEAKER SYSTEMS	38
CHANNEL DELAY	41
CHANNEL LEVEL (channel balance)	42
Acoustic Calibration EQ	43
Check the Auto Settings	45
Basic Operation	46
Stereo and Multichannel Playback	46
Switching the channels used for playback (LISTENING CH SELECT)	47
Switching ANALOG/DIGITAL Signal Input	48
Playback of 96kHz 24 bit sound formats	48
Listening Modes	49
STEREO modes	49
STANDARD modes	49
HOME THX modes	50
ADVANCED CINEMA modes	51
ADVANCED CONCERT modes	52
Adjusting the Effect of Advanced Listening Modes	52
Listening with Acoustic Calibration EQ	53
Reducing Noise During Playback (DIGITAL NR Function)	53
Listening in MIDNIGHT Mode	54
Listening in LOUDNESS Mode	54
Adjusting Bass and Treble (Tone Control)	55
DVD Audio/MULTI CHANNEL IN Playback	56
DUAL MONO Setting and Playback	57
Input Attenuator	57
Tape 2 Monitor	57
Using the Headphones	58
Video Select	58
Adjusting the Brightness of the Display	59
Status Display	59

Remote Control of Other Components	60
Setting Up the Remote Control to Control Other Components	60
Recalling Settings Stored in the Remote Control	60
Programming Signals from Other Remote Controls (LEARNING Mode)	62
Locking the Settings	63
Using the Remote Control with Other Components	64
DVD and TV operations	64
Setting up the DIRECT FUNCTION	65
Using Other Functions	66
Recording from Audio/Video Components	66
Speaker System B Setup	67
Stereo playback in another room	67
Bi-amping the front speakers	67
Bi-wiring your speakers	67
Switching A/B Speaker System	68
Connecting Additional Amplifiers	69
Pre Out Power Setup	70
The PIONEER SR System: Operating other PIONEER components	71
Multi Operations	72
Performing multi operations	73
System off	74
Using System off	75
Editing Remote Control Screen Names (ITEM MEMO)	76
Editing Buttons Names (KEY LABEL)	77
Resetting the Main Unit	79
Resetting the Remote Control	79
Advanced Setup	80
Assigning the Digital Input	80
Assigning the Component Video Inputs	81
Expert Setup	82
OSD (On-screen Display) ADJUSTMENT	83
BASS PEAK LEVEL	84
DYNAMIC RANGE CONTROL	85
MULTI CH IN SELECT	86
FUNCTION RENAME	87
THX Audio Setup	88
THX Ultra2 Subwoofer Setup	88
Surround Back Speaker Position	89
Re-Equalization	90

Techno Tidbits & Problem-solving	91
Dolby	91
Dolby Digital	91
Dolby Pro Logic II	92
Dolby Digital Surround EX	92
MPEG Audio	92
DTS	93
DTS	93
DTS-ES	93
DTS Neo:6	93
DTS 96/24	93
THX	93
Speaker Placement Information	95
Audio Block Diagram	97
Troubleshooting	98
Specifications	103

Before You Start

Checking the Supplied Accessories

Please check that you have received all of the following supplied accessories.

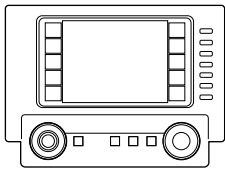

Remote Control Unit



Touch Pen
(attached to the back of the remote control)

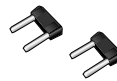

U-shaped connectors x 2
(attached to back of amplifier)

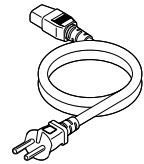

AC power cord

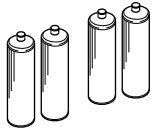

"AA" IEC LR6
batteries x 4

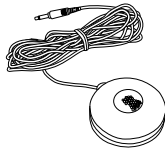

Microphone

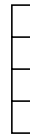

Cushion for
Remote x 4

• Operating Instructions

Preparing the Remote Control

Loading the batteries

Load the batteries into the remote control as shown below. The remote control uses a lot of power due to the LCD display so please use alkaline batteries. Depending on individual use you may have to change the batteries fairly often but most users should be able to get an average of 1-3 months of battery life. When you notice a decrease in the operating range or if the alarm sounds (see below), replace all batteries with new ones.

NOTE: After replacing the batteries, the touch panel will need re-adjusting (see p. 8-9).

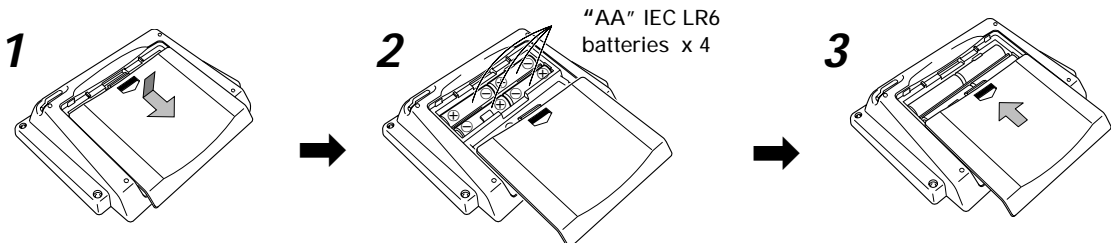

CAUTION!

Incorrect use of batteries may result in such hazards as leakage and bursting. Observe the following precautions.

- Never use new and old batteries together.
- Insert the plus and minus sides of the batteries properly according to the marks in the battery case.
- Batteries with the same shape may have different voltages. Do not use different batteries together.
- When disposing of used batteries, please comply with governmental regulations or environmental public institution's rules that apply in your country or area.

Remote Control Battery Alarm

When the batteries get too weak to operate the remote control properly an alarm will sound and a warning screen will appear on the remote. Change the batteries as shown above. This must be done within five minutes of the alarm sounding or all your remote control settings will be cleared.

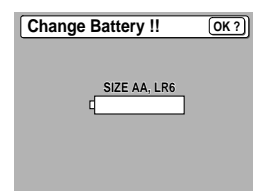

The Touch Pen & Lock

The touch pen is located in the back right-hand corner of the remote control. Take it out by sliding your finger along the bottom right edge of the remote control and then grasping the pen with thumb and forefinger.

The lock switch is located in the top right-hand corner on the back of the remote control. When this switch is set to LOCK you can't use the buttons on the remote control. This is helpful to prevent you from mistakenly pushing a button. For normal use keep the switch set in USE.

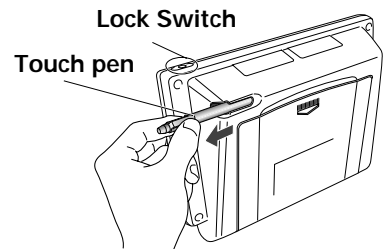

Remote Control Cushions

Apply the cushions to the feet of the remote control as shown in the diagram right.

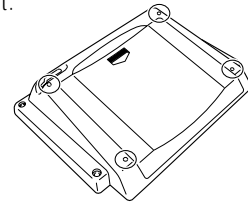

Operating range of remote control unit

The area in which you can use the remote control to operate the VSA-AX10 is fairly large. To use, point the remote control toward the remote sensor on the front panel of this unit while within the range shown below.

Remote control may not function properly if:

- There are obstacles between the remote control and the remote sensor.
- Direct sunlight or fluorescent light is shining onto the remote sensor.
- The amplifier located near a device emitting infrared rays.
- Operated simultaneously with another remote control which uses infrared rays.

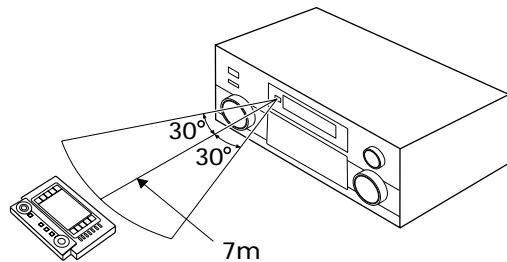

Opening the Front Panel

To open the front panel push gently on the lower third of the panel with your finger.

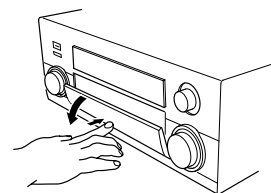

Setting Up the Remote Control

Try and get used to the touch-sensitive nature of the buttons on the remote control as well as the way in which different screens control different operations. You can move between the different screens with the function buttons on the left and right and/or certain buttons within each screen. The BACK button will always return the remote control to the previous screen. In the explanations below complete the TOUCH PANEL ADJUSTMENT setup to use the remote control properly. After that you can adjust various basic settings to suit your personal preferences.

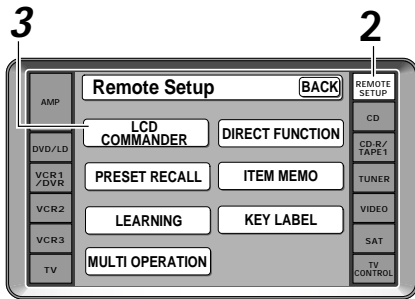

1 Make sure the batteries are in the remote control (see page 6, if necessary).

2 Press REMOTE SETUP on the remote control.

Access to the different setup modes appear on your remote control screen.

3 Press the LCD COMMANDER button.

The different types of possible adjustments will appear on the screen.

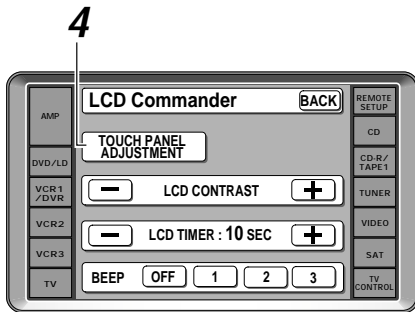

4 Press the TOUCH PANEL ADJUSTMENT button.

You must first align the touch panel to make sure the remote control responds properly when you touch it.

5 Press each cross point in the middle to align the remote control touch panel with the LCD panel underneath.

This adjustment will make sure your remote control is calibrated correctly. When you've touched all four cross points the screen will show the word "COMPLETE" and automatically return to the LCD COMMANDER screen.

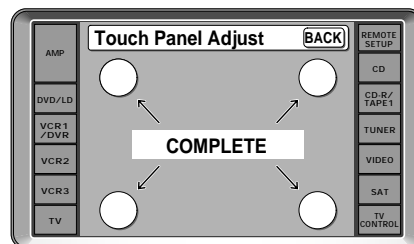
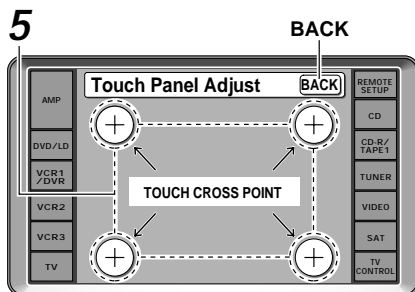

6 Decide which other adjustments you'd like to make and press those buttons. The different possibilities are:

LCD CONTRAST: You can lighten or darken the contrast on the remote control screen. Use the -/+ buttons to change the contrast.

LCD TIMER: In order to save the battery a timer will automatically turn the remote control off after a set amount of time if no commands are entered. You can choose how long the idle remote control will stay on before the timer turns it off. You can set this function in a range of 5-60 seconds. The default setting is 10 seconds. Use the -/+ buttons to adjust the number of seconds for the timer setting.

(The REMOTE SETUP screen and its sub-screens are all fixed to stay on 60 seconds. If no command is entered they will turn off after 60 seconds.)

BEEP: When you have sent a command (pushed a button) the remote control will beep once. You can choose the sound of the beep from three different possibilities here by pushing the appropriate button (1,2,3). You can also turn the beep sound off.

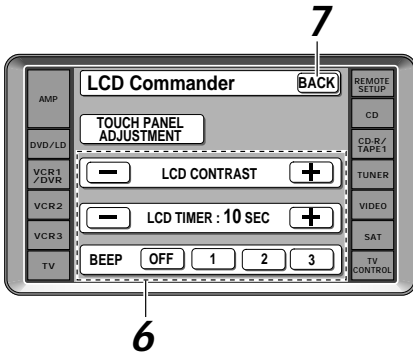

7 When you are finished with the adjustments press the BACK button to go back to the Remote Setup screen.

Remote Control Backlight

1 Decide whether you'd like to have the backlight on or not and use the LIGHT switch to turn it on or off.

This button turns the light on or off. If you leave it on the remote screen is easier to see but uses more energy and thus wears the batteries down quicker.

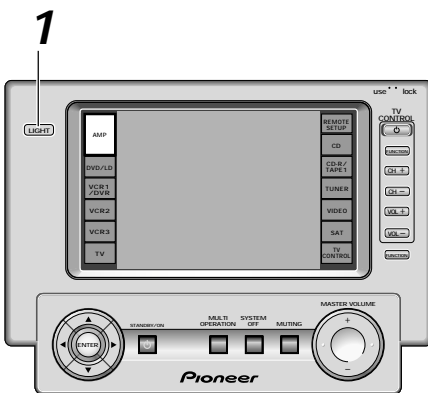

Home Theater: The Basics

Most consumers are used to using stereo equipment to listen to music but many people are not used to home theater systems that give you many more options when listening to soundtracks. In fact, home theater is not really complicated and this little guide should give you an understanding of the basics.

The main reason why it seems so difficult is that there are three different factors involved in home theater and each will contribute to what kind of sound you get.

These factors are:

- 1) The equipment you are using for your home theater setup. Particularly important is the number of speakers you are using. We call this your speaker configuration.
- 2) The 'source' material you are using. This is the actual product (like a DVD) or broadcast (like cable TV) you are listening to/watching. We call this the source.
- 3) The last factor is the listening mode you choose on the VSA-AX10 Amplifier. These are explained below and in subsequent chapters but most likely the STANDARD (default) setting will be fine.

Let's start with the home theater setup you have in your home.

1) Your Home System

The heart of your system is the VSA-AX10 Amplifier and it is very flexible in getting you theater-like surround sound. You can use this Amplifier with anywhere from two to seven speakers (front left, front right, center, surround left and right, and surround back left and right) and a subwoofer to get home theater surround sound. We recommend you use seven speakers and a subwoofer. If this is not possible follow the instructions in "Auto Surround Setup" in the "Quick Start Guide" and you will be able to get good surround sound. Also, a DVD player is essential for home theater and you can also hook up satellite or cable TV tuner to this Amplifier and get a more home theater-like sound from these sources.

2) The Source Material

DVDs have become the basic source material for home theater because they offer excellent sound and picture quality, and allow users to enjoy home theater soundtracks with more than two channels of audio. For example, Dolby Pro Logic plays back four channels (front left, front right, center and a single channel for both surround speakers), Dolby Digital, MPEG and DTS sources usually have six discrete channels (front left, front right, center, surround left and right and a channel that powers the subwoofer) of sound. Since the subwoofer channel is only for bass sounds, this multichannel setup has been named 5.1 channel sound.

It is important you consult the manual that came with your DVD player as well to make sure the player is outputting a surround soundtrack and all the other settings are appropriate for your home theater.

3) The Listening Modes

This Amplifier has many different listening modes and they are designed to cover all the speaker configurations and types of sources you might be using. In general, if you follow the recommended advice and have seven speakers and a subwoofer hooked up, in most cases the STANDARD listening mode is the easiest way to get realistic home theater sound. This is the default setting so you don't have to do anything.

To listen to music in stereo simply choose the STEREO listening mode. Other possibilities (like listening to a stereo CD with all seven speakers or taking a stereo source and getting multichannel home theater-like sound) are explained in listening modes (pages 49-52).

Conclusion

These are the three basic factors that contribute to your home theater sound. The easiest thing is to hook up seven speakers and a subwoofer and simply play your DVDs with STANDARD 7.1 mode. This will give you realistic and enjoyable home theater sound. First hook up your equipment, like your DVD player, TV and speakers. Then follow the instructions to set up your system for surround sound. It is very important you do one of the surround sound setups to get optimal sound from your Amplifier.

For more details on any of the information presented here check the main section of the manual.

Before making or changing the connections, switch off the power and disconnect the power cord from the AC outlet.

1 Hooking Up Your DVD Player & TV

In order to use Dolby Digital, MPEG or DTS soundtracks you need to hook up your DVD player with digital audio connections. You can do this by either a coaxial or an optical connection, **you don't need to do both**. The quality of these two types of connections is the same but since some DVD players only have one type of digital terminal you need to figure out which yours has and hook it up to the appropriate terminal on the Amplifier. In order to do this you will need the proper cable. For coaxial connections you can use a regular Phono video cord or the specially-made coaxial cords, they have the same type of plugs. For optical connections you will need a special optical cable which you can buy at your local stereo store. For more detail on cords/cables see page 25. You should also hook up your DVD player with analog audio connections. Use regular Phono stereo cords for these connections. Also hook up the video connection on your DVD player and your TV to this Amplifier. For your TV it's easiest to use a regular composite Phono video cord, as shown below. It is important that you hook up your TV (or monitor) in order to see a video image as well as the on screen displays (OSDs) shown by this Amplifier (for more see page 18).

Digital Connections

Some DVD players have both coaxial and optical terminals, but there is no need to connect both. If your DVD player has a coaxial terminal (not a PCM-only output) for the audio out hook it up using this terminal. Follow the diagram below using DIGITAL IN 1. This is the best scenario, as you will be able to follow the default settings of this amplifier and won't need to assign the digital inputs.

If your DVD player only has an optical terminal for the audio output you can hook it up using one of the DIGITAL IN terminals between 4-7 (for example, DIGITAL IN 4). In this case, you will need to assign the digital input (which means tell the amplifier which input you used for your DVD digital audio). See page 13 for this.

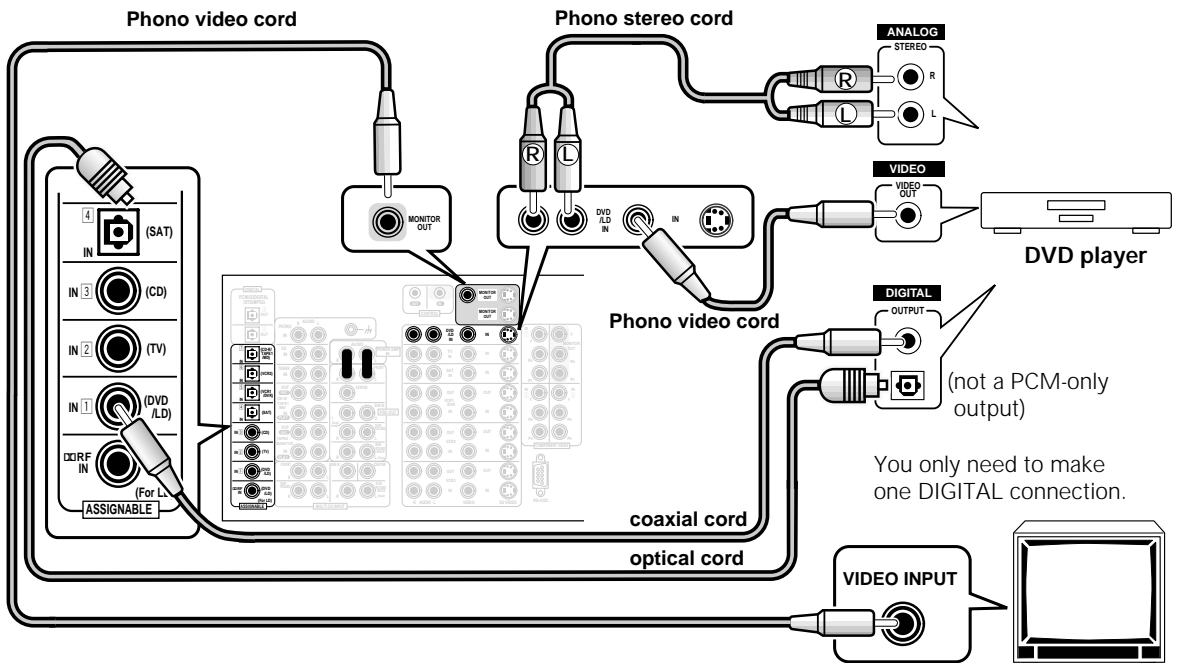

2 Speaker Connections

Home theater is designed to be setup with five, or seven speakers (front left & right; center; surround left & right; and, optimally, surround back left & right) and a subwoofer, but you can use this amplifier with fewer speakers. Hook up the speakers you have to the A speaker terminals on the back of the amplifier. If you only have two speakers hook them up as "FRONT." If you have three hook up the single speaker as "CENTER." Follow the diagram below in order to hook up all your speakers. A center speaker is very important for watching films because in digital soundtracks the dialog comes from the center speaker. If you do not have a center speaker you must tell the amplifier the center channel is off or when you listen to digital soundtracks you won't hear any dialog. This can be done automatically by following the Auto Surround Sound Setup instructions from page 14 in this Quick Start Guide.

If possible, use surround back speakers. These speakers are important to take full advantage of all the sound channels on new, eight channel home theater DVDs. The diagram below also explains how to hook up a subwoofer which provides realistic bass sounds. For the subwoofer use a mono (single plug) Phono cord and for the other speakers use regular speaker cords. **See pages 95-96 for advice on speaker placement.** Make sure you connect the speaker on the right to the R terminal and the speaker on the left to the L terminal. Also make sure the positive and negative (+/-) terminals on the amplifier match those on the speakers.

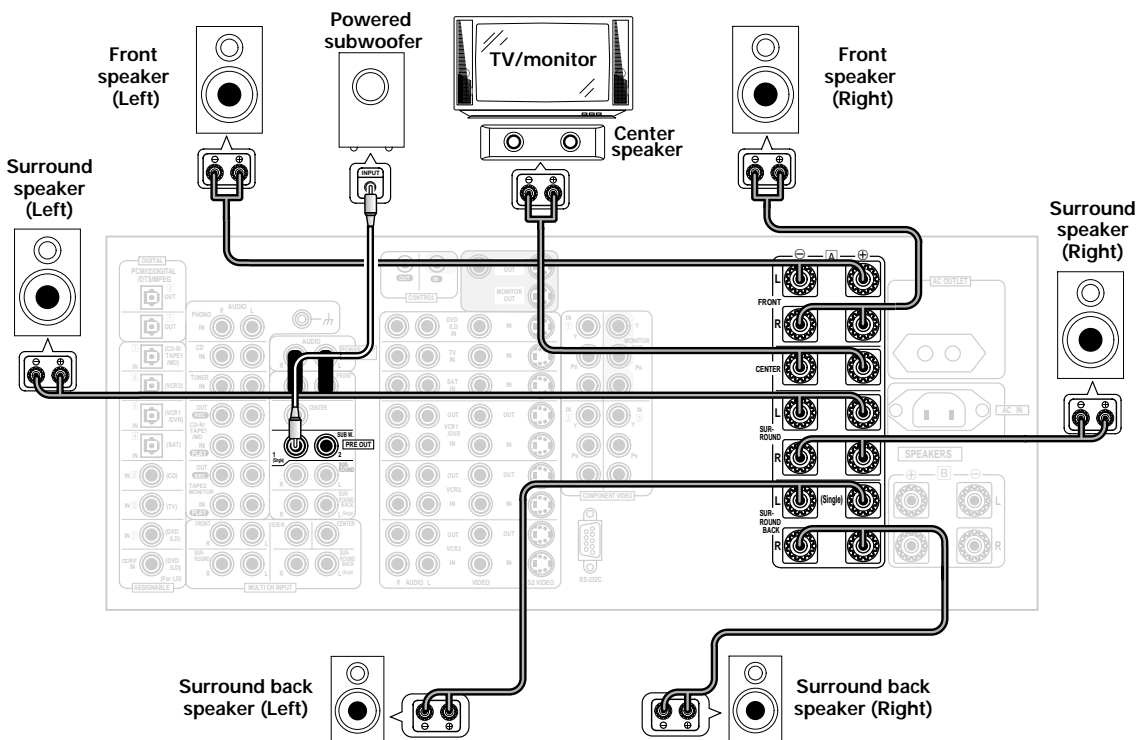

- Please use speakers with a nominal impedance rated **6Ω-16Ω**.
- If you only have one surround back speaker hook it up to the left surround back terminal.
- If you use a THX certified subwoofer use the THX INPUT jack on the subwoofer (if your subwoofer has one) or switch the filter position to THX on your subwoofer.
- When you attached your speaker wire to the speaker terminal make sure that not even one strand of wire touches the back of the amplifier. If this happens it could short out the amplifier.

■ Speaker terminals

- ① Twist exposed wire strands together tightly.
- ② Loosen speaker terminal and insert exposed wire.
- ③ Tighten terminal.

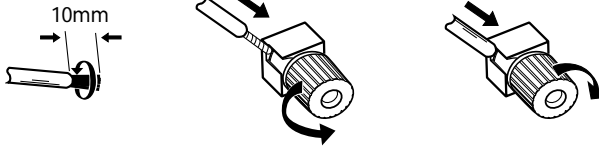

CAUTION: These speaker terminals can be under HAZARDOUS VOLTAGE. When you connect or disconnect the speaker cables, to prevent the risk of electric shock, do not touch uninsulated parts before disconnecting the power cord. H047 En

3 Setting up the Main Unit

- 1 Connect the supplied AC power cord to the back of the main unit and plug the other end into a wall outlet (don't use any other power cord than the one that came with this amplifier).
- 2 Press the POWER ON/OFF button to put the amplifier in ON mode.
- 3 Press the STANDBY/ON button to switch the amplifier ON.

4 Assigning the Digital Inputs

This is only necessary if you did not hook up your DVD player to DIGITAL IN 1 using a coaxial cable, as in the diagram on p.11, but rather connected it to one of the optical digital inputs. The following example shows how to assign the DIGITAL IN 3 jack to DVD.

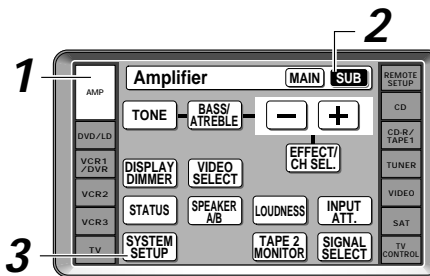

1 Turn on the amplifier and your TV, press AMP on the remote control.

2 Press the SUB button on the AMPLIFIER remote control screen.

3 Press the SYSTEM SETUP button.

The SYSTEM SETUP menu appears on your TV (if it doesn't, refer to page 11 to make sure you have properly connected the amplifier to your TV).

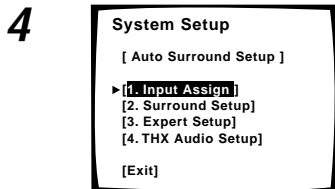

4 Looking at the on-screen display on your TV, use the ▲▼ buttons to select INPUT ASSIGN. Press the ENTER button.

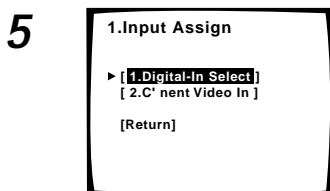

5 DIGITAL IN-SELECT should be selected, if not use the ▲▼ buttons to select it. Press the ENTER button.

6

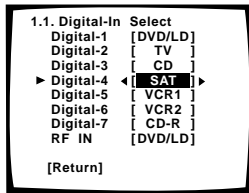

7

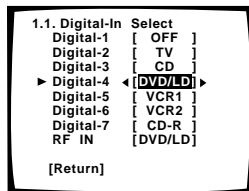

6 The default setting for the DIGITAL-4 jack is SAT.

7 Use the ◀▶ buttons to select DVD/LD.

8 Select RETURN with the ▲▼ buttons and press ENTER.

You will return to the SYSTEM SETUP menu.

9 Choose EXIT with the ▲▼ buttons and press ENTER.

The amplifier exits the setup process.

1 Auto Surround Sound Setup

If setting up your surround sound speakers seems like it's going to be an involved task you only need to use this quick, automatic method to achieve good surround sound. You'll need to hook up the microphone provided so that the amplifier can hear and judge the distance, size, sound character and sound pressure level of the speakers and thus know what settings to make.

Follow the step-by-step guide to setting up your surround sound below. This will customize the surround sound for your listening environment. After you get used to the system it is a good idea to make more advanced settings as explained in "Expert Setup" (page 82). Also, if you want to personalize your surround sound setups by making the settings manually go to "Setting up for Surround Sound" (page 37). Make sure all the components you need, especially speakers, have been properly connected before you do the steps described here. Use the arrow buttons (▲▼) and the ENTER button on the remote control to navigate the on-screen display (OSD) on your TV.

2

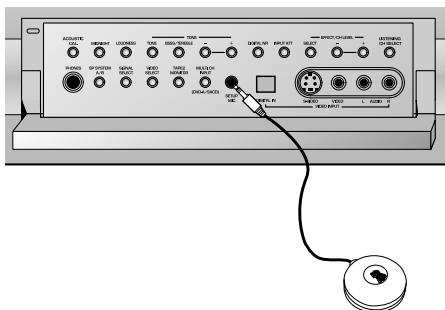

1 Switch on the amplifier and your TV.

Make sure your TV is set to this amplifier as you will use the on-screen displays (OSDs) on your TV to follow these instructions.

2 Hook up the microphone to the Front Panel.

3 Place the microphone at your normal listening position.

If you have a tripod, attach the microphone to it and use that to get the mic to ear level at your normal listening position.

If you don't have a tripod use a table or chair to put the microphone at the same height as you usually listen to your system from.

4 If you have a subwoofer turn it on.

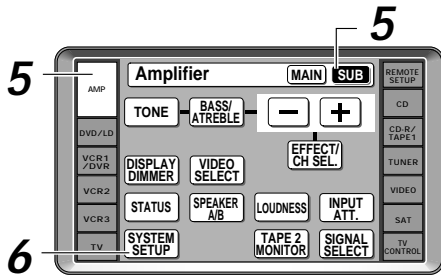

5 Press AMP then press the SUB button on the remote control.

6 Press the SYSTEM SETUP button and use the on-screen display (OSD) that appears on your TV.

7 The arrow should be pointing at AUTO SURROUND SETUP, press ENTER.

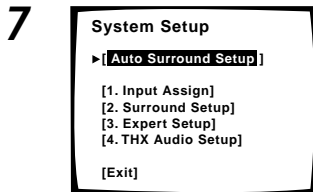

8 NORMAL SURROUND should be selected. (Use the ◀▶ buttons to select it if it isn't.) Use the ▲▼ buttons to select GO NEXT and press ENTER.

For Bi-amp settings choose FRONT BI-AMP 5.1 and follow the directions from step 3 on page 39.

RETURN brings you back to the system setup menu.

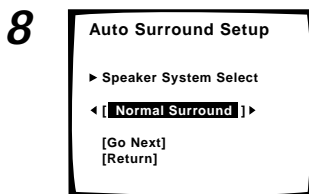

9 Some auto setup instructions will be listed, make sure to follow them.

Make sure you have: hooked up the microphone and moved obstacles to the speakers out of the way. If you have a subwoofer make sure it is turned on and has the volume turned up.

WARNING: The test tones are very loud!! Make sure there are no infants or small children in the room and that no one who will be scared, upset or injured by loud noise is present. You yourself may want to wear ear-plugs. It is possible to lower the volume of test tones, but this could result in incorrect speaker settings.

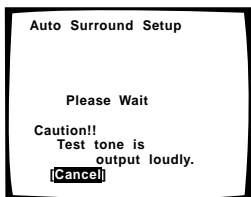
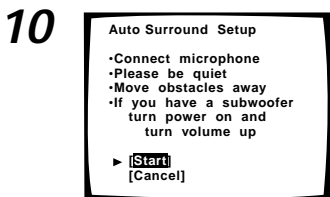

10 If you have followed all setup instructions and warnings above make sure that the arrow is pointed to START and press ENTER. Be prepared for loud test tones.

Try to be as quiet as possible after hitting ENTER. The test tones may take up to 30 seconds.

The volume automatically increases to 0 dB, then the system will output some test tones and establish ambient noise levels, the microphone status, and what speakers you hooked up.

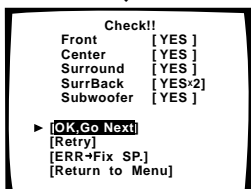
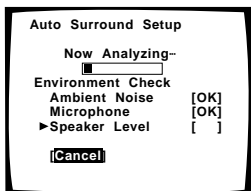

11

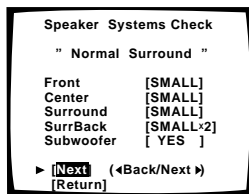
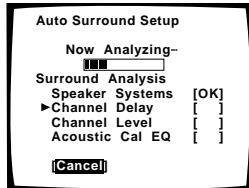
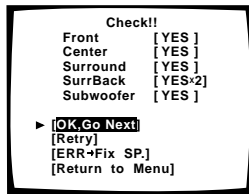

- Make sure the room environment follows the guidelines displayed on the OSD during auto setup. If the room environment is not optimal for auto setup (too much ambient noise, obstacles blocking the speakers from the microphone, etc.) the final settings may be incorrect. Check for household appliances (air conditioner, fridge, fan, etc.) that may be affecting the environment and switch them off if necessary.
- Screens will turn off after three minutes and the amplifier will automatically exit from the setup process.
- If you leave CHECK!! or other error message on the screen for three minutes, or you choose CANCEL at anytime during the setup, the settings made up to that point will be cleared.
- After completing the Auto Surround Sound Setup, ACOUSTIC CAL EQ ON (ALL CH ADJ) is set automatically.

11 Check the speaker settings on the OSD

If they match your speaker configuration make sure **OK,GO NEXT** is selected and press **ENTER**. The test tones will be output loudly again. The test tones may take up to 5 minutes this time. After they have finished, you see the **SPEAKER SYSTEMS CHECK** screen. If you want to view the settings select **NEXT** and press **ENTER** repeatedly. If not, simply go to step 13.

If they do not match the speaker configuration you hooked up and you want to try again select **RETRY** with **▲▼** buttons and press **ENTER**. Follow the instructions above from step 10.

If the speaker settings do not match the speaker configuration you connected and you want to input the settings manually select **ERR→FIX SP** with the **▲▼** buttons, press **ENTER** and go to step 12.

If you see an ERR message in the right side column, there may be a problem with the speaker connection. If selecting **RETRY** doesn't fix the problem, turn off the power and check the speaker connections.

12 Use the ▼▲ buttons to select a speaker then the ◀▶ buttons to select the size of each speaker individually. Use the ▼▲ buttons to select OK, GO NEXT and press ENTER.

The system will output another series of test tones to establish the proper channel level, channel delay and acoustic calibration EQ. Again, be prepared for loud test tones.

After it has finished, you see the **SPEAKER SYSTEMS CHECK** screen. If you want to view the settings select **NEXT** and press **ENTER** repeatedly. If not, simply go to the next step.

13 Select RETURN to go back to the SYSTEM SETUP menu, then choose EXIT to complete the auto surround sound setup and return to normal use.

You should now have settings that will give you good surround sound. The **MCACC** indicator will light and the surround sound settings are complete.

2 Playing a DVD with Surround Sound

- 1 Make sure the amplifier, your TV, and your DVD player are switched ON.**
- 2 Press the DVD/LD button on the remote control.**
You should see "DVD/LD" in the display on the amplifier.
- 3 Press the LISTENING CH SELECT button on the remote control repeatedly until you see "7.1" in the display on the amplifier.**
To locate the LISTENING CH SELECT button, press the AMP button then press MAIN to access the main remote control screen.
- 4 Press the STANDARD button on the remote control for the basic surround sound setting.**
If you don't see the STANDARD button, press the AMP button then press MAIN to access the main remote control screen.
- 5 Play a DVD then adjust the MASTER VOLUME.**

3 Personalizing Your Sound

- 1 Use the Surround Listening Mode buttons to find the listening mode(s) that work best for the source material.**
For more information see pages 49–52.
- 2 To get a more refined sound, make the sound settings in "Expert Setup" (p.82–87).**

Connecting Your Equipment

Connecting your TV

Connect your TV to the jacks as shown below. Hook up with either component video, S video, or composite video cords (the quality descends in this order). If you use component video cables to hook up your DVD player (or other components) then you must hook up your TV with component video cables as well. In general it is easiest to use one kind of video cord for all your video components (DVD player, TV, satellite TV receiver, etc.) but you can use different kinds of cables (see "Video Converter" below).

Before making or changing the connections, switch off the power and disconnect the power cord from the AC outlet.

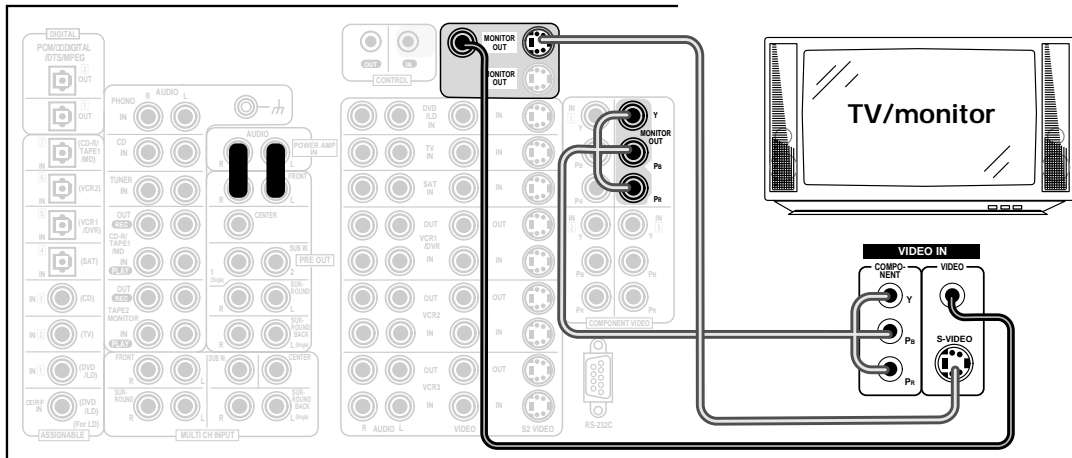

S Video

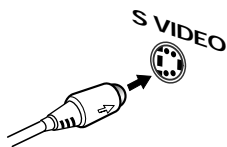

S video cables produce clearer picture reproduction by sending separate signals for the luminance and the color. These jacks are labeled by the Japanese designation "S2" on the VSA-AX10 but they are simply S video jacks.

Component video

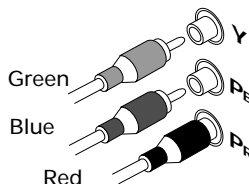

The color signal of the TV is divided into the luminance (Y) signal and the color (Pb and Pr) signals and then output. In this way, interference between the signals is avoided.

Composite Video

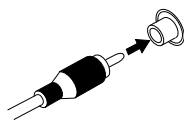

Composite video cords are the most common or standard video cord but also the lowest quality. The color on the connector is yellow to distinguish it from regular RCA audio cords which have white and red connectors (see p.22). It is important to use a true composite video cord and not an audio cord (though they look exactly the same) because the impedance is different and this will affect the picture quality.

Video Converter

This unique feature of the VSA-AX10 allows you to hook up your VCR/DVD or any other video player, and/or your TV tuner with one type of cord to the amplifier while using a different type of cord to hook up the TV to the amplifier. You can hook them up with either component video, S video, or composite video cords (the quality descends in this order). The only restriction here is that if you hook up your DVD player, or other video device, with component video cords (see above), then you must hook up your TV with component video cords as well. The flexibility afforded by the video converter should make connecting all of your equipment easier and perhaps, in some cases, give you higher picture quality. This model is designed for PAL video format. If you use an NTSC source the video converter will not be able to convert from composite video (in the IN jacks) to S video (in the OUT jacks). All other conversions will be ok.



Connecting Video Components

Connect your video components to the jacks as shown on the following page. Regarding a DVD there are two types of connections to make, video and audio.

Hook up your video signal with either component video, S video or composite video cords (the quality descends in this order). See "Video Converter" on previous page.

For the audio signal, in order to use digital soundtracks like Dolby Digital, MPEG or DTS you must hook up a digital input, with either a coaxial or optical cord (see p.25). It is also a good idea to hook up your components with analog audio connections as well, since some DVDs may not output a digital audio track. A DVD/LD player or LD player requires a specialized **RF** connection (shown at the very top of the first diagram below) to cover the all possible soundtracks on laser discs.

If you want to record from your DVD player composite (or S video) cord connections and analog audio connections are necessary.

Before making or changing the connections, switch off the power and disconnect the power cord from the AC outlet.

Connecting a DVD, DVD/LD or LD player

Hook up your audio signal with either a coaxial or optical digital cords (you don't need to do both). For DVD/LD or LD players, if your player has a **RF** output hook up the **RF** connection as well (with a coaxial cord). This will ensure you can use all LDs (see below). If you hook up your DVD/LD player using component video cable connections you might need to setup your DVD player for component video output as well. See your DVD manual for details. If you have a DVD-A or Super Audio CD compatible player, see "Connecting to the Multi Channel Analog Inputs" on page 23.

You need to hook up your audio with analog connections as well.

Before making or changing the connections, switch off the power and disconnect the power cord from the AC outlet.

*The arrows indicate the direction of the signal.

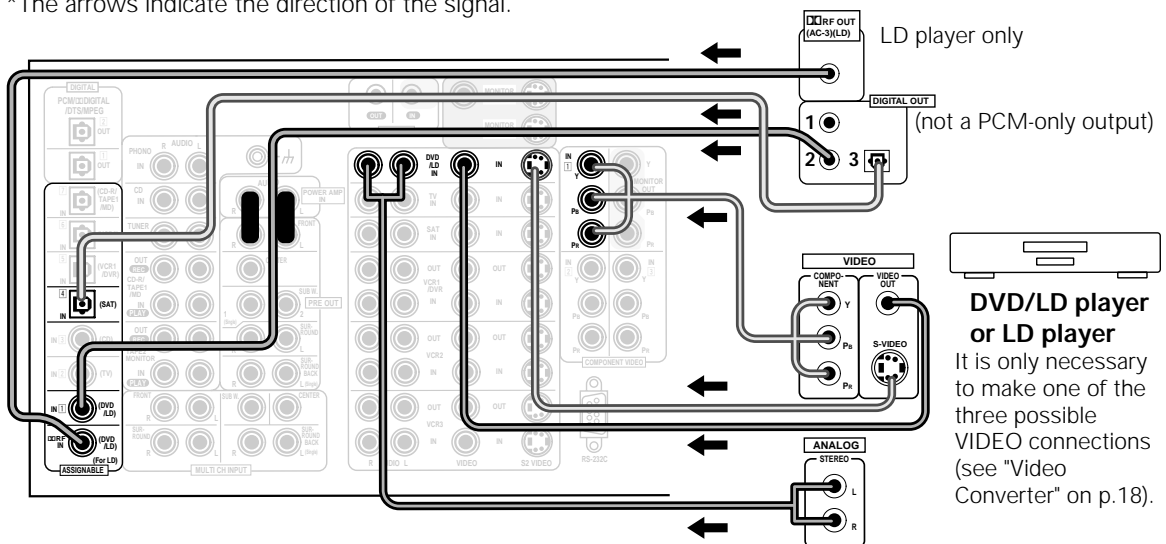

DVD/LD player or LD player
It is only necessary to make one of the three possible VIDEO connections (see "Video Converter" on p.18).



- If your digital connections are different than the default settings you will need to assign the digital jacks to the proper component(s) with the "Assigning the Digital Inputs" procedure. See page 80 to do this.
- If you use component video cords to hook up any of you equipment you must assign those inputs with the "Assigning the Component Video Inputs" procedure. See page 81 to do this.

Connecting Your Equipment

Connecting VCRs or DVRs

Connect the video signal with either S video or composite video cords (see p.18). Use analog audio cords for the audio signal. For components you want to record into be sure to hook up both the inputs and outputs and use composite or S video cords for the source players.

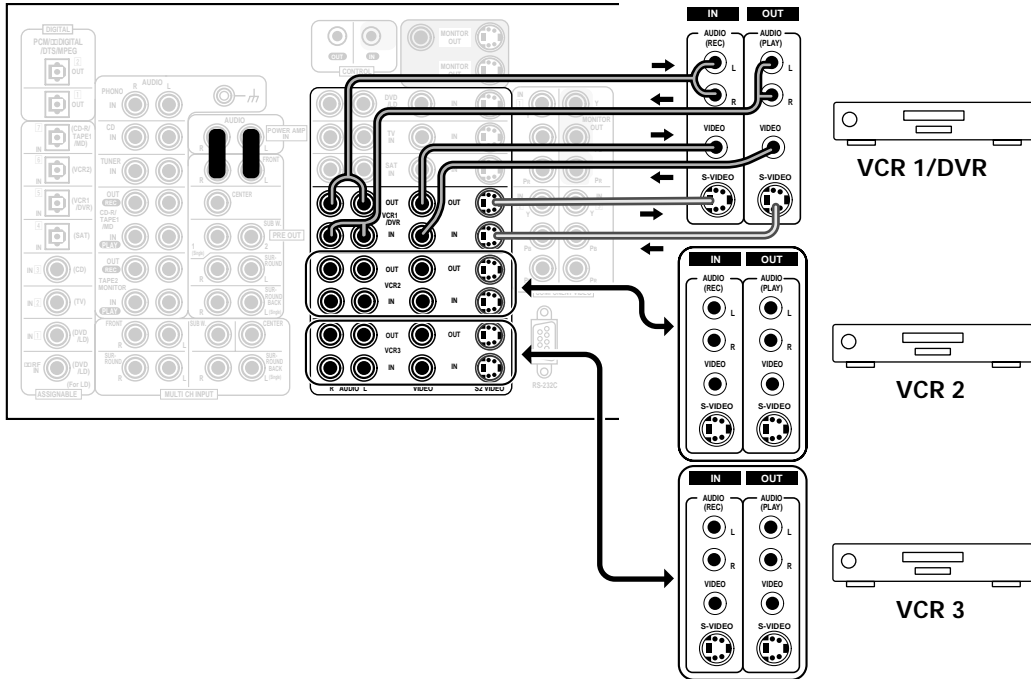

Connecting a Video Component to the Front Panel

Connect a portable DVD player, video game console or any video component to the front panel as show here. Front video connections are accessed via the front panel input selector as "VIDEO."

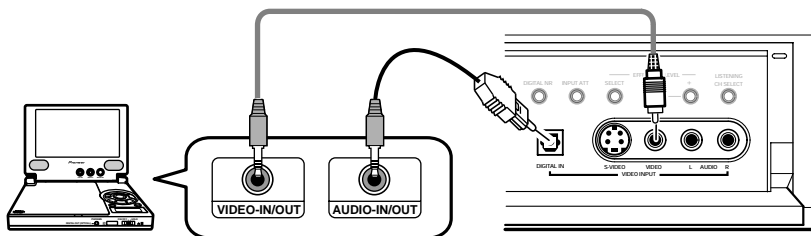

Be careful! For portable DVD players you will need a specialized optical cord (for the audio) that has a mini optical plug on one end and a regular optical plug on the other.



You cannot assign the name of the digital input on the front panel. It will always appear as "VIDEO" in the amplifier's display. See page 80 for more information on "Assigning the Digital Inputs".

Connecting Satellite TV (SAT) Components

Hook up the video signal with either component video, S video, or composite video cords (see p.18).

For the audio signal, in order to use digital soundtracks broadcast you must hook up a digital input. Use either a coaxial or optical cable, it doesn't matter which (see p.24-25). We recommend hooking up your audio with analog cables as well (see below).

Before making or changing the connections, switch off the power and disconnect the power cord from the AC outlet.

*The arrows indicate the direction of the TV signal.

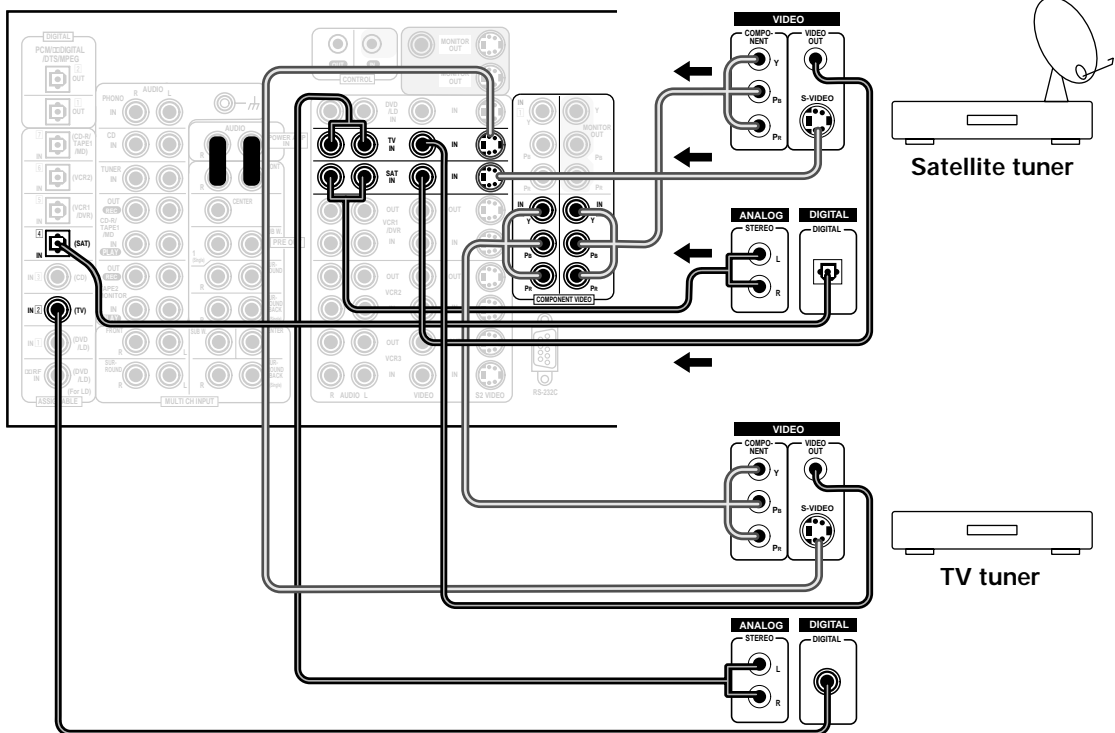

- If you use component video cords to hook up any of your equipment you must assign those inputs with the "Assigning the Component Video Inputs" procedure. See page 81 to do this.
- If your digital connections are different than the default settings you will need to assign the digital jacks to the proper component(s) with the "Assigning the Digital Inputs" procedure. See page 80 to do this.

Connecting Analog Audio Components

Connect your audio components to the jacks as shown below. These are all analog connections and your analog audio components (turntable, cassette deck) use these jacks. Remember that for components you want to record with you need to hook up four plugs (a set of stereo ins and a set of stereo outs), but for components that only play (like a turntable) you only need to hook up one set of stereo plugs (two plugs). If you want to record to/from digital components (like a CD-R) to/from analog components you must hook up your digital equipment with these analog connections.

Before making or changing the connections, switch off the power and disconnect the power cord from the AC outlet.

*The arrows indicate the direction of the audio signal.

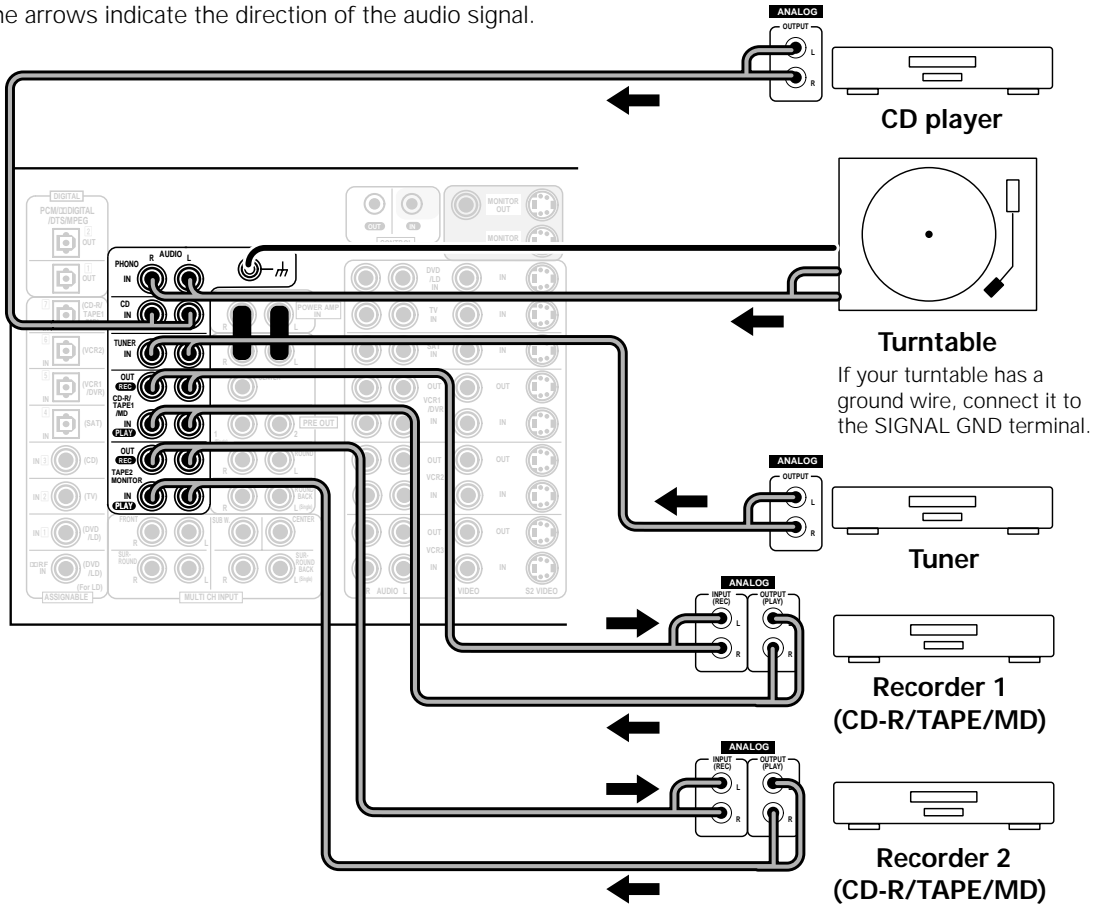

Don't hook up any other component to the PHONO jacks other than a turntable. It could damage the equipment. If your turntable has a phono pre-amplifier (most do not) please hook it up to an input other than PHONO.

■ Audio cords

Use Phono audio cords (not supplied) to connect the audio components.

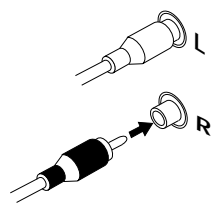

Connect red plugs to R (right) and white plugs to L (left).
Be sure to insert completely.

Cassette deck placement

Depending on where the cassette deck is placed, during playback of your cassette deck noise may occur which is caused by leakage flux from the transformer in the amplifier. If you experience noise, move the cassette deck farther away from the amplifier.

Connecting to the Multi Channel Analog Inputs (DVD-A or Super Audio CD compatible player)

If you have a DVD-A or Super Audio CD compatible player, or are using an external Dolby Digital/DTS decoder, connect it to the multichannel analog inputs as shown below. Note that if your DVD-A, Super Audio CD compatible player or decoder which doesn't have surround back outputs, it is possible to create a 6 or 7 channel environment with the "MULTI CH IN SELECT" feature on page 86.

Before making or changing the connections, switch off the power and disconnect the power cord from the AC outlet.

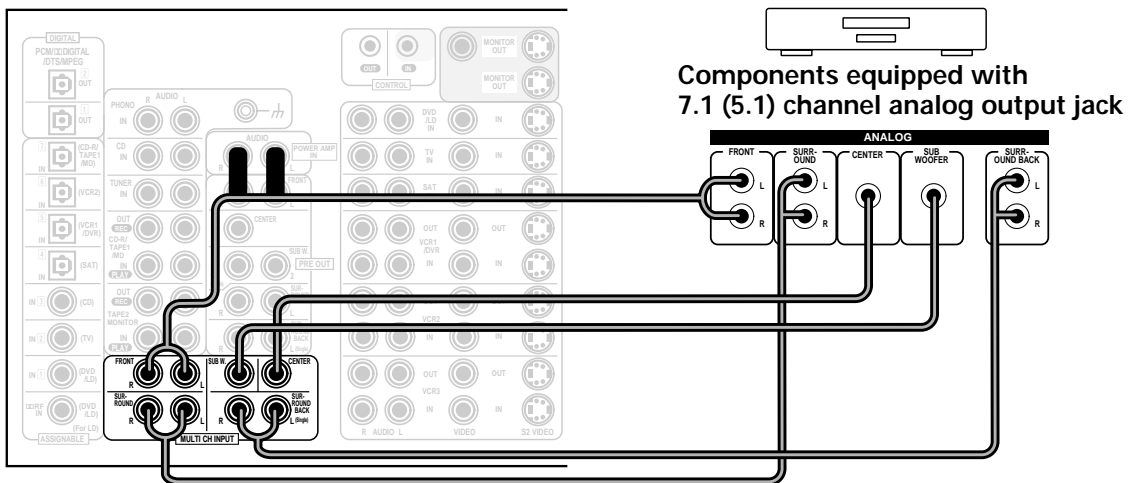

If you use only one surround back input hook up the left one.

Connecting Digital Audio Components

Connect your digital components as shown below. The VSA-AX10 has three coaxial, four optical and one **RF** inputs for a total of eight digital inputs. In order to use digital soundtracks like Dolby Digital, MPEG or DTS (among others) you need to make digital audio connections. You can do this by either a coaxial or an optical connection (you don't need to do both). The quality of these two types of connections is the same but since some digital components only have one type of digital terminal, it is a matter of matching like with like (for example, the coaxial out from the component to coaxial in on the amplifier). A DVD/LD player or LD player should also be connected to the special **RF** jack (if the LD has one).

Hook up your digital equipment in accordance with this amplifier's default settings (see next page) unless you want to, or need to, change them. To do this see "Assigning the Digital Inputs" on p.80.

There are two optical digital out jacks (the CD recorder is connected to one in the diagram below). If you connect this to the optical input on a digital recorder (currently these include MD, DAT and CD-R) you can make direct digital recordings with this unit.

We also recommend hooking up your digital components to analog audio jacks (see p.22) in order to make recordings (some digital sources may be protected against making digital copies).

Before making or changing the connections, switch off the power and disconnect the power cord from the AC outlet.

*The arrows indicate the direction of the audio signal.

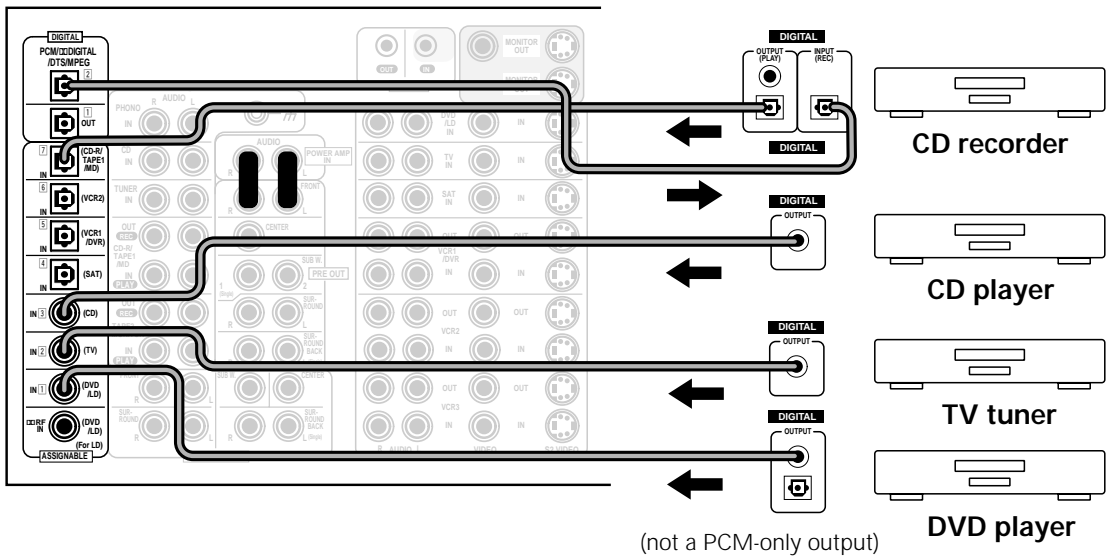

■ Coaxial cords/Optical cables

Commercially available digital audio coaxial cords (standard video cords can also be used) or optical cables (not supplied) are used to connect digital components to this amplifier.

Be sure to insert completely and in the case of the optical cable, right-side up. If it is inserted improperly it can break the shutter on the optical terminal (this won't, however, affect the connection or insertion of an optical cable).

**Coaxial cord
(or standard composite
video cord)**

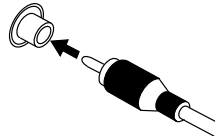

Optical cable

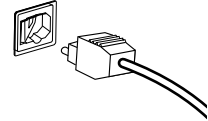

Digital Input Default Settings

Unlike analog connections, the jacks for digital connections are not dedicated to one type of component, they can be used freely. Thus you must tell the amplifier what digital component is connected to which jack so your components will be in sync with the names on the remote control buttons and the like. To avoid having to assign the digital inputs you can hook up your equipment in accordance with the amplifier's default settings.

The default settings are:

DIGITAL IN 1 (coaxial): DVD/LD

DIGITAL IN 2 (coaxial): TV

DIGITAL IN 3 (coaxial): CD

DIGITAL IN 4 (optical): SAT

DIGITAL IN 5 (optical): VCR1/DVR

DIGITAL IN 6 (optical): VCR2

DIGITAL IN 7 (optical): CD-R/TAPE 1/MD

RF IN (coaxial): DVD/LD

See "Assigning the Digital Inputs" on p.80 if the way you hook up your equipment is different from the default settings.

Connecting Speakers

We recommend a full complement of seven speakers and a subwoofer as shown here but, naturally, everyone's home setup will vary. Simply connect the speakers you have in the manner described below. The VSA-AX10 will work with just two stereo speakers (called "front" speakers in the diagram) but it is desirable to have at least three speakers (two "front" speakers and a "center" speaker).

One of the latest features of home theater is the use of surround back speakers. These speakers add even greater realism in movie sound effects and some new discs with soundtracks in Dolby Digital, MPEG or DTS incorporate these channels.

In general, make sure you connect the speaker on the right to the R terminal and the speaker on the left to the L terminal. Also make sure the positive and negative (+/-) terminals on the amplifier match those on the speakers.

Before making or changing the connections, switch off the power and disconnect the power cord from the AC outlet.



- If you only have one surround back speaker hook it up to the left surround back terminal.
- The VSA-AX10 has two speaker systems, A & B. If you are planning on setting up another set of speakers (speaker system B), refer to "Speaker System B Setup" on page 67.
- If you use a THX certified subwoofer use the THX INPUT jack on the subwoofer (if your subwoofer has one) or switch the filter position to THX on your subwoofer.

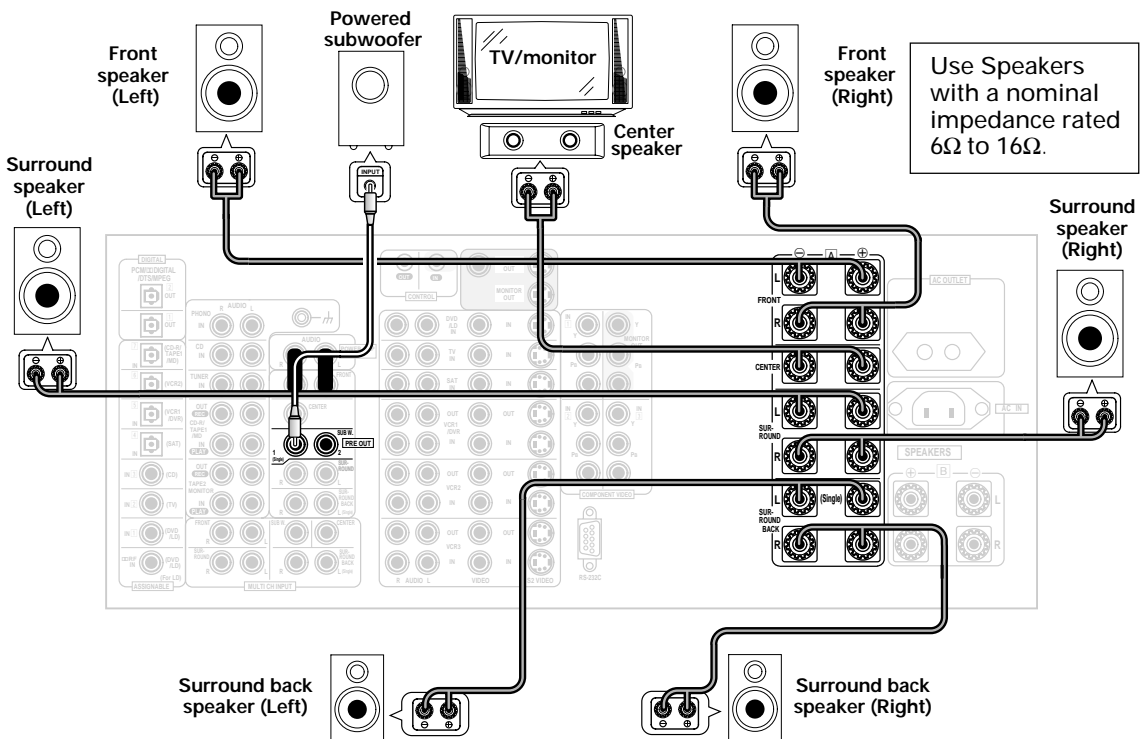

■ Speaker terminals

① Twist exposed wire strands together.

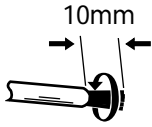

② Loosen speaker terminal and insert exposed wire.

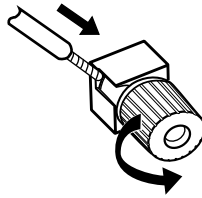

③ Tighten terminal.

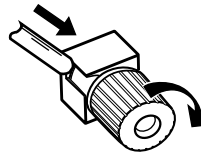

CAUTION: These speaker terminals can be under HAZARDOUS VOLTAGE. When you connect or disconnect the speaker cables, to prevent the risk of electric shock, do not touch uninsulated parts before disconnecting the power cord. H047 En

Placing Your Speakers

Proper speaker placement is essential to realize the best sound from your system. The diagram and tips given here are just a rough guide, for more information see page 95. Also, it is very important for speaker placement to read the instructions that come with your speakers so please be sure to do so.

Speaker placement

If you have a multiple speaker arrangement the placement of the speakers is extremely important. To achieve the best possible surround sound, install your speakers as shown below. Make sure all speakers are installed securely to prevent accidents and improve sound quality. Be sure to consult p.95 and your speaker manuals for the best placement of the speakers. Some speakers are designed to be floor-standing but others benefit greatly from speaker stands which raise them off the floor.

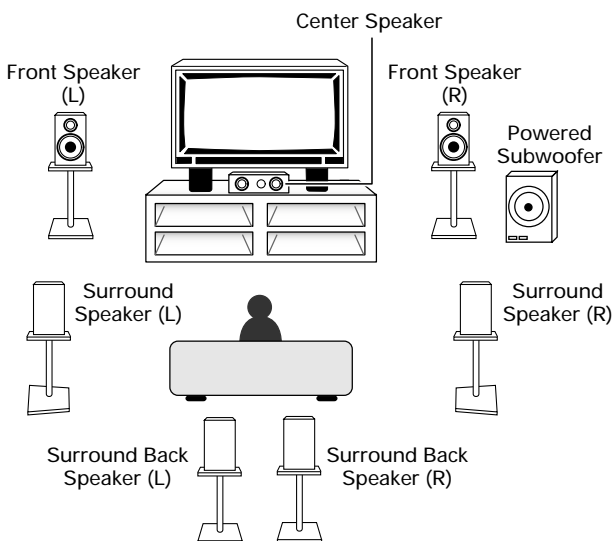

- When installing speakers near the TV, we recommend using magnetically shielded speakers to prevent possible interference such as distortion in the color of the TV screen. If you do not have magnetically shielded speakers and notice discoloration of the TV screen, place the speakers farther away from the TV.
- Install the center speaker above or below the TV so that the sound of the center channel is localized at the TV screen.
- See page 95 for more detailed advice on speaker placement.
- If you have two surround back speakers we recommend placing them together and the same distance from your listening position so you can take advantage of the ASA feature. For more details see pages 94-96.

CAUTION:

When installing the center speaker on top of the TV be sure to secure it with suitable means.

AC Power Cord

Plug in the power cord first to the receiver and then to the wall outlet after you have finished hooking up the rest of your equipment.

CAUTION!

- Do not use any other power cord than the one supplied with this unit.
- The amplifier should be disconnected by removing the mains plug from the wall socket when not in regular use, e.g. when on vacation.

AC Outlet [switched 100 w max]

Power supplied through this outlet is turned on and off by this unit's STANDBY/ON button. Total electrical power consumption of connected equipment should not exceed 100 W.

CAUTION!

- Do not connect appliances with high power consumption such as heaters, irons, or television sets to the AC OUTLET in order to avoid overheating and fire risk. This can cause the amplifier to malfunction.
- **DO NOT CONNECT A MONITOR OR TV SET TO THIS UNIT'S AC OUTLET.**

If the socket outlets on the associated equipment are not suitable for the plug supplied with the product, the plug must be removed and an appropriate one fitted. Replacement and mounting of an AC plug on the power supply cord of this unit should be performed only by qualified service personnel. The cut-off plug must be disposed of as an electrical shock hazard could exist if connected to a socket outlet.

H022AE_n

Remote Control

These pages describe the buttons on the remote control. Since the screen on this LCD remote control changes when you select a different function, explanations of buttons for controlling other components/functions can be found in the sections for those components/functions.

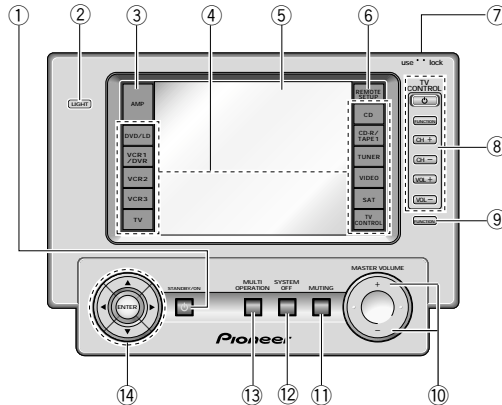

To turn on the remote control touch it anywhere on the screen

① **STANDBY/ON button**

Press to turn power of the amplifier on or to STANDBY (off).

② **LIGHT button**

Use to turn on and off the backlight on the remote control screen.

③ **AMP button**

Press to switch the remote control into amplifier mode or to get amplifier screens.

④ **Function buttons**

These buttons are the basic controls that switch the mode of the amplifier and the remote control, which allows you to control your other components.

⑤ **Remote control screen (see p.30-31)**

⑥ **REMOTE SETUP button**

Use to customize the remote control functions and the remote control itself. (See "Setting Up Remote Control of Other Components" starting on p.60)

⑦ **LOCK switch**

Use to lock the remote control so it doesn't turn on by accident. For normal use keep it set in USE.

⑧ **TV CONTROL buttons**

The following buttons are used to control the TV only and can be used once they are preset to control your TV.

STANDBY/ON : Press to turn the power of the TV on/off.

INPUT : Press to select the input source for the TV.

CH +/- : Use these buttons to change the channel of the TV.

VOL +/- : Press to control the volume of the TV.

⑨ **INPUT button**

Press to select a source. The button will cycle through all the possible sources.

⑩ **MASTER VOLUME button**

Use to raise or lower the volume of the amplifier.

⑪ **MUTING button**

Press to mute or restore the volume.

⑫ **SYSTEM OFF button (see p.75)**

This button turns off components in two ways. First, when pressed it will turn off all PIONEER components. Secondly, any component that has programmed into the SYSTEM OFF settings will be turned off.

For example : If you programmed power off in the SYSTEM OFF settings for your TV and VCR, pressing the SYSTEM OFF button will turn off these components even if they are not PIONEER products.

⑬ **MULTI OPERATION button**

Use this button to start the MULTI OPERATION mode. See p.73 for how to program and use the MULTI OPERATION mode.

⑭ **▲/▼/◀/▶/ENTER buttons**

These buttons can be used for a variety of operations. In the SYSTEM SETUP menu, the ▲/▼ buttons can be used to adjust CHANNEL DELAY or CHANNEL LEVEL.

The ▲/▼ buttons, pressed simultaneously, can be used to lock or unlock a setting (see p.63).

These buttons are also used to control the DVD menu for the DVD remote control screen. Also, in TUNER mode they can select station and frequency.

Basic Amplifier LCD Screens

Amplifier MAIN Screen

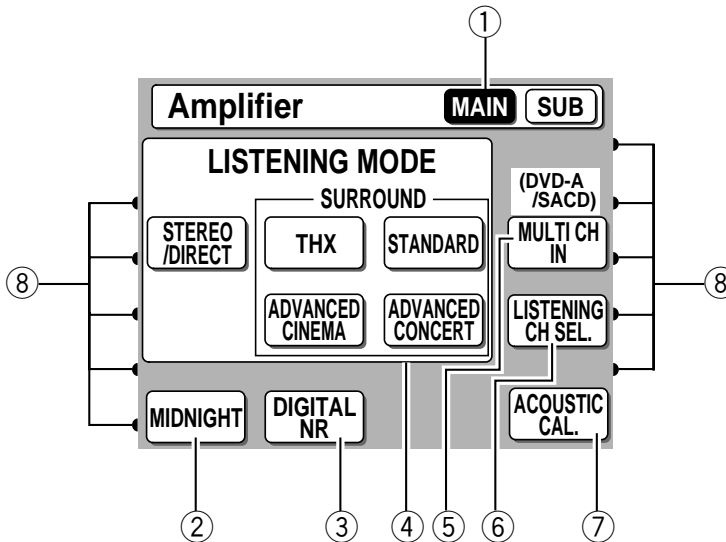

① **Amplifier MAIN button**

Press this button to select the MAIN amplifier screen (above) when the remote control is on the SUB amplifier screen.

② **MIDNIGHT button (See p.54)**

Switches the MIDNIGHT listening mode on or off (for all modes except THX).

③ **DIGITAL NR button (See p.53)**

Switches the DIGITAL NR on or off (for all modes except THX).

④ **LISTENING MODE buttons (See p.49-52)**

STEREO/DIRECT: Switches the amplifier into STEREO mode if it was in a different listening mode or toggles between DIRECT and STEREO mode.

THX: Press to put the amplifier into HOME THX listening mode.

STANDARD: Press to put the amplifier into STANDARD listening mode.

ADVANCED CINEMA: Press to put the amplifier into ADVANCED CINEMA listening mode.

ADVANCED CONCERT: Press to put the amplifier into ADVANCED CONCERT listening mode.

⑤ **MULTI CH IN button (See p.56)**

Use this button to select the component (for example, a DVD-Audio player) you have hooked up to the MULTI CH INPUT terminals.

⑥ **LISTENING CH SEL. button (See p.47)**

Use this button to select a listening channel (5.1, 7.1, or AUTO).

⑦ **ACOUSTIC CAL. button (see p.53)**

Press to switch on/off the acoustic calibration EQ.

⑧ **DIRECT FUNCTION on/off indicator (See p.65)**

These dots indicate whether the DIRECT FUNCTION is on or off for the function (DVD/LD, CD, etc.) they point to.

Amplifier SUB Screen

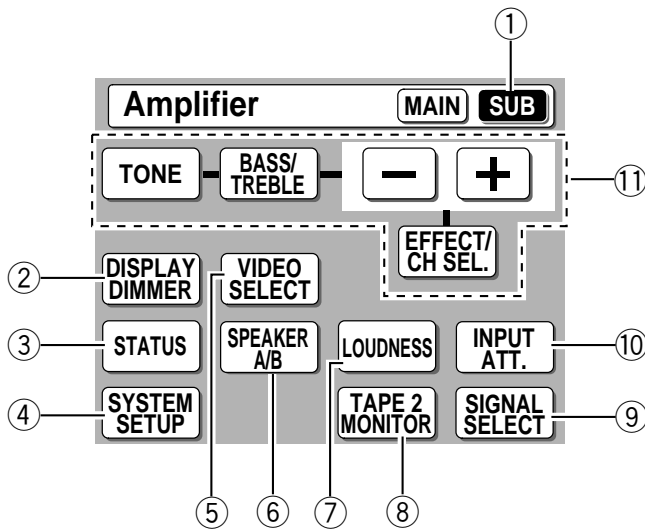

① **Amplifier SUB button**

Press this button to select the SUB amplifier screen (above) when the remote control is on the main amplifier screen.

② **DISPLAY DIMMER button (See p.59)**

Use to adjust the brightness of the amplifier's display.

③ **STATUS button (See p.59)**

Use to display the present mode of the amplifier and other selected settings.

④ **SYSTEM SETUP button**

Use for all system setups, including the speaker and sound systems. For more information see "Setting up for Surround Sound" starting on p.37.

⑤ **VIDEO SELECT button**

Use to toggle between the different video input possibilities.

⑥ **SPEAKER A/B button (See p.68)**

Use to select the speaker system. A is the primary setting. The button cycles through the speaker systems as follows: A⇒B⇒A&B⇒off. Different conditions apply when bi-amping the speakers. For this case refer to page 67.

⑦ **LOUDNESS button (See p.54)**

Switches the LOUDNESS mode on or off (for all modes except THX).

⑧ **TAPE 2 MONITOR button**

Selects the tape deck (or MD recorder, etc.) connected to the TAPE 2 MONITOR inputs/ outputs. Allows monitoring of a recording as it's being made.

⑨ **SIGNAL SELECT button (See p.48)**

Press SIGNAL SELECT repeatedly to select one of the following:

ANALOG : To select an analog signal.

DIGITAL : To select a digital signal

RF : To select an RF signal

AUTO : This is the default. If there are analog, digital and RF signals input, the amplifier automatically selects the RF signal. If there are analog and digital signals input the digital will be selected.

⑩ **INPUT ATT. button**

Use to lower the input level of an analog signal that is too powerful, thus causing the amplifier to distort. In this case the overload (OVER) indicator will be flashing furiously.

⑪ **TONE control/EFFECT CH SEL. buttons**

TONE button

This button has two functions. Firstly, it switches between TONE on and TONE BY-PASS, which bypasses the tone circuitry. Secondly, you need to press the button before using the BASS & TREBLE (+/-) buttons (see p.55).

EFFECT/CH SEL. button

Switches the tone adjust controls between the front, center, surround and surround back speakers. You can then use the + and - buttons to adjust the sound (see p.52).

While in Advanced mode, you can also adjust the effect level.

Back Panel

All the terminals on the back panel are explained and/or referenced here.

6: U-shaped connectors

Don't remove the U-shaped connectors unless you plan to connect an external power amp to this amplifier.

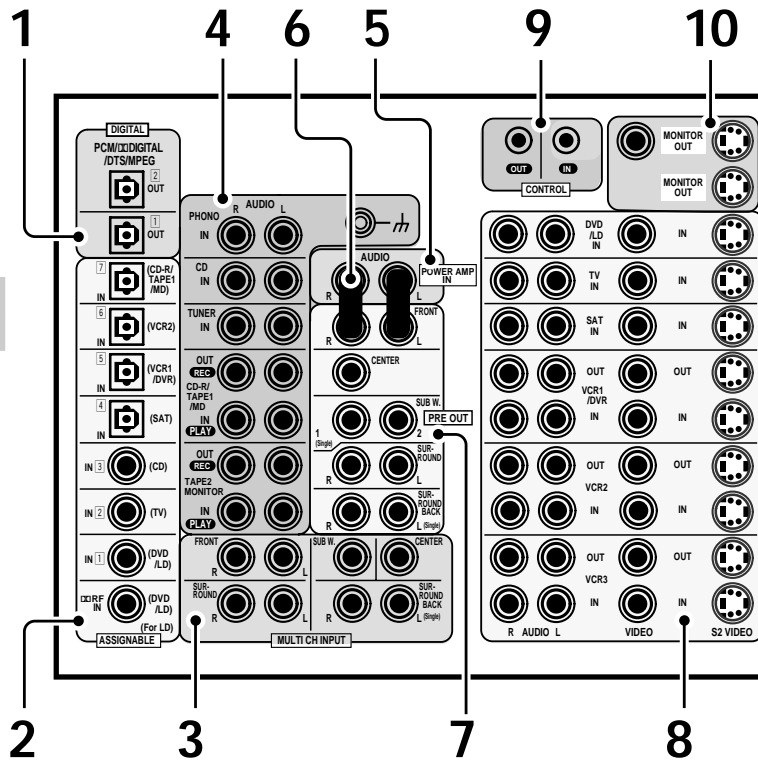

1 DIGITAL OUT terminals (See p.24)

Use these terminals to output the signal from a DVD, CD player or any other kind of digital player.

2 DIGITAL IN terminals (See p.24)

Use these terminals to input the signal from a DVD, CD player or any other kind of digital player. To be able to play Dolby Digital and other surround soundtracks you need to make digital connections. To do this use the digital terminals here. If you don't connect as per the default settings (see p.26) you need to complete "Assigning the Digital Inputs" (see p.81).

3 MULTI CH INPUT terminals (see page 23)

Use these terminals to input a multichannel surround signal (for example, a DVD-Audio signal) in an analog fashion. These are analog jacks.

4 Analog input/output terminals (connect analog components here, see page 22)

Use these terminals to input/output the audio signal from analog components (like a cassette deck or turntable). These are analog jacks.

5 POWER AMP IN terminals

Use this terminal to connect an external control amp to this amplifier (see page 69 & 70). Remove the U-shaped connectors only if you plan to do so.

6 U-shaped connectors

7 PRE OUT analog terminals

Use these terminals to output the (analog) audio signal from this amplifier to a different power amplifier (see page 70). Remove the U-shaped connectors only if you plan to do so.

8 Video components in/out terminals

Input/output signals from you video components (DVD, VCR, TV tuners, SAT tuners, etc.) here.

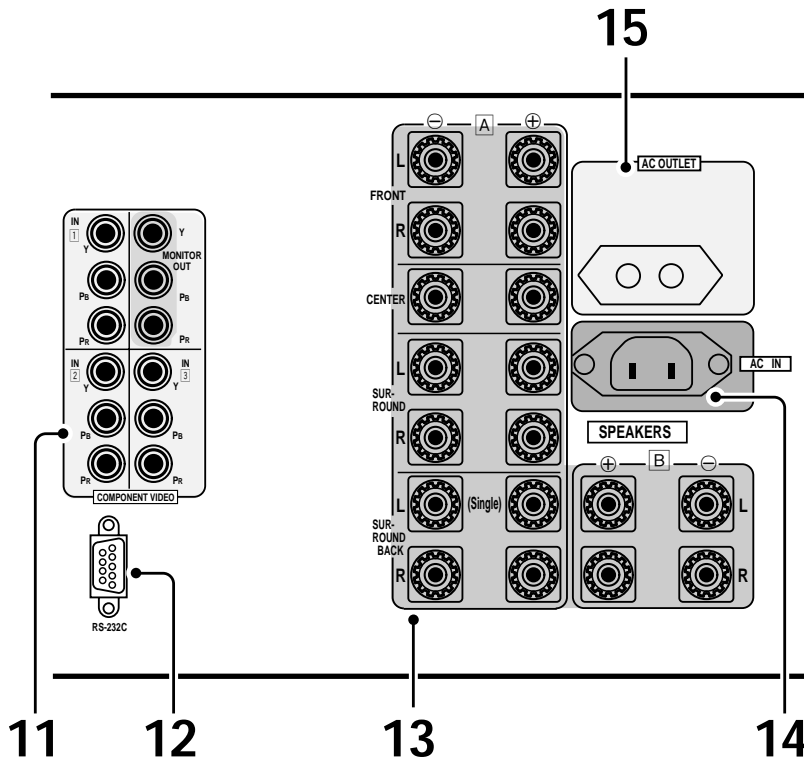

9 CONTROL IN/OUT terminal

You can use this jack to hook up other PIONEER equipment, that bears the SR mark, so that you can control them all pointing the remote control(s) at one remote sensor.

10 MONITOR OUT terminals (connect a TV or monitor here, see page 11 & 18)

Use these terminals to output a video signal to a TV or monitor.

11 Component video in terminals

Use these terminals to hook up the video connections of your video components with this high quality method. Your components will have to have the terminals as well to take advantage of this kind of connection. See p.19 for more on setting up your amplifier for component video. If you use these terminals you need to complete "Assigning the Component Video Inputs" (see p.81).

12 RS-232C Connection

This is a future-oriented port that has the possibility on inputting and/or outputting information to/from the amplifier.

13 SPEAKER terminals

Use these terminals to connect speakers to the amplifier (see pages 12, 26, 67 & 68). There are two speaker systems on this amplifier A & B. The A system is the one that handles surround sound and is fed by the surround and surround back speakers. If you want to use alternative speaker connections like bi-amping or bi-wiring see page 67.

14 AC IN (Power In)

Hook up the power cord to this terminal.

15 AC outlet

Hook up an external component to the power supply of this amplifier. Only do this with audio or video components being used in this system and never hook up heavy equipment (like TVs, heaters, air conditioners, refrigerators, etc.) to this amplifier.

Front Panel

All the controls on the front panel are explained and/or referenced here. To open the front panel push gently on the lower third of the panel.

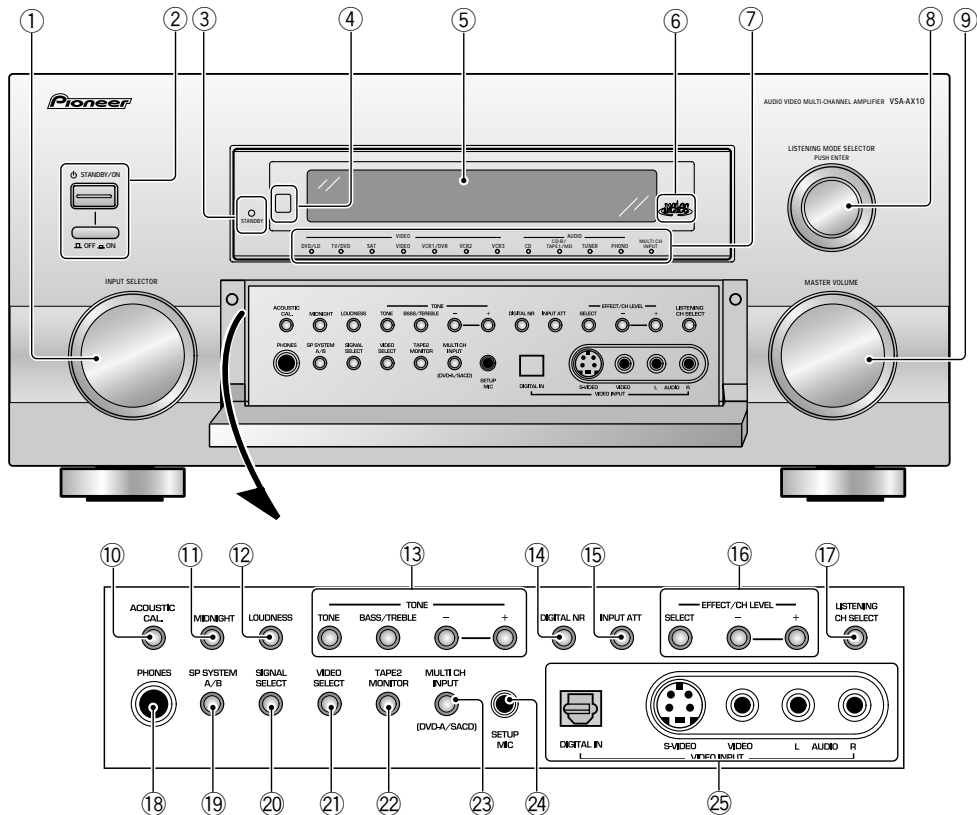

1 INPUT SELECTOR dial

Turn to select a source component. The input indicators show the current component.

2 **STANDBY/ON** button—**power ON/OFF** button

Press to switch the amplifier ON or into STANDBY mode or to switch OFF.

3 **STANDBY** indicator

Lights when the amplifier is in STANDBY mode. (Please note that this amplifier consumes a small amount of power [0.65 W] in the standby mode.)

4 **Remote sensor**

Receives the signals from the remote control.

5 **Display** (See p.36)

6 **MCACC indicator** (see p.16, step 13)

Lights when the ACOUSTIC CAL EQ is on. (After the Auto Surround Sound Setup has been completed the ACOUSTIC CAL EQ is set on and this display will light.)

7 **INPUT** indicators

Shows which source component is selected. The MULTI CH INPUT indicator lights when a component connected to MULTI CH INPUT is selected.

8 **LISTENING MODE SELECTOR** dial

Turn and push to select a listening mode.

9 **MASTER VOLUME** dial

Adjusts the overall amplifier volume.

10 **ACOUSTIC CAL.** button (see p.53)

Use to switch on and off the Acoustic Calibration EQ.

11 **MIDNIGHT** button (see p.54)

Use to switch the amplifier into MIDNIGHT mode.

12 **LOUDNESS** button (See p.54)

Switches the LOUDNESS mode on or off (for all modes except THX).

13 TONE control buttons

TONE button

This button switches between TONE ON and TONE BYPASS, which bypasses the tone circuitry.

BASS/TREBLE button (See p.55)

Use to select whether the bass or treble will be adjusted.

(-/+) buttons (See p.55)

Use to adjust the frequencies.

14 DIGITAL NR button (see p.53)

Switches the DIGITAL NR on or off (cannot be used in THX).

15 INPUT ATT. button

Use to lower the input level of an analog signal that is too powerful, thus causing the amplifier to distort. In this case the overload (OVER) indicator will be flashing furiously.

16 EFFECT/CH LEVEL buttons

Switches the tone adjust controls between the front, center, surround and surround back speakers. You can then use the + and - buttons to adjust the sound (see p.52).

While in Advanced mode, you can also adjust the effect level.

17 LISTENING CH SELECT button (See p.47, 56 & 57)

Use this button to select the number of channels used for playback (5.1, 7.1, or AUTO).

18 PHONES jack

Connect headphones for private listening (no sound will be heard through the speakers).

19 SP SYSTEM A/B button (See p.68)

Use to select the speaker system. A is the primary setting. The button cycles through the speaker systems as follows: A⇒B⇒A&B⇒off. Different conditions apply when bi-amping the speakers. For this case refer to page 67.

20 SIGNAL SELECT button (see p.48)

Use to select the type of signal being input into the amplifier. Press SIGNAL SELECT repeatedly to select one of the following:

ANALOG – To select an analog signal.

DIGITAL – To select an optical or coaxial digital signal.

RF – To select an RF signal.

AUTO – This is the default setting. If there are analog, digital and RF signals input, the amplifier automatically selects the RF signal. If there are analog and digital signals input the digital will be selected.

21 VIDEO SELECT button (See p.58)

Switches the amplifier between the various types of video input.

22 TAPE 2 MONITOR button

Selects the tape deck (MD recorder, etc.) connected to the TAPE 2 MONITOR inputs/ outputs. Allows monitoring of a recording as it's being made.

23 MULTI CH INPUT button

Selects the component (for example, a DVD-Audio player) you have hooked up to the MULTI CH INPUT terminals.

24 SETUP MIC jack

Plug in the setup mic here. This is very important for setting up your system to get proper surround sound.

25 Front VIDEO INPUT jacks (See p.20)

DIGITAL IN : digital input for connecting a game console, portable DVD player, video camera (etc.), that has an optical digital connection.

S VIDEO : Video input for connecting a video camera (etc.), that has an S video out.

RCA VIDEO / AUDIO (L/R) : Video input for connecting a video camera, etc. that has standard RCA video/audio outputs.

CAUTION:

THE OFF/ON BUTTON IS SECONDARY CONNECTED AND THEREFORE DOES NOT SEPARATE THE UNIT FROM MAINS POWER IN OFF POSITION. THEREFORE INSTALL THE UNIT SUITABLE PLACES EASY TO DISCONNECT THE MAINS PLUG IN CASE OF THE ACCIDENT. THE MAINS PLUG OF UNIT SHOULD BE UNPLUGGED FROM THE WALL SOCKET WHEN LEFT UNUSED FOR A LONG PERIOD OF TIME. H017BEh

Display

All the display information is explained and/or referenced here.

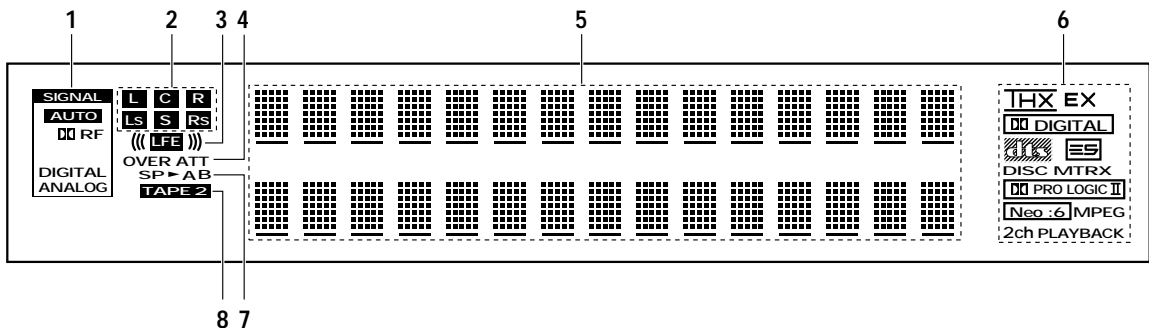

1 SIGNAL SELECT indicators

Light to indicate the input signal you selected.

ANALOG: Lights when an analog signal is selected.

DIGITAL: Lights when a digital signal is selected.

DIGITAL RF: Lights when an  RF signal is selected.

AUTO: Lights when the amplifier is set to select the input signal automatically.

2 Program Format indicators

For Dolby Digital, MPEG or DTS sources :

These indicators change according to which channels are active in the source. When all three **LS** (left surround), **S** (surround) and **RS** (right surround) light at the same time it means a source with a 6.1ch playback flag is being used.

L – Left front channel

C – Center channel

R – Right front channel

LS – Left surround channel

S – Surround channel (mono)

RS – Right surround channel

LFE – Low frequency effects channel

3 ((())) – Lights when LFE signal is input

4 Analog level indicators

OVER – This lights if the signal is in danger of distorting for analog source signals. Press **INPUT ATT** on the front panel to lower the signal level.

ATT – Lights when **INPUT ATT** is used to reduce the level of the analog source signal.

5 Character display

Shows current mode, status, etc.

6 Digital format indicators

DIGITAL: Lights when a Dolby Digital signal is detected.

DTS: Lights when a DTS signal is detected.

MPEG: Lights when an MPEG signal is detected.

THX: Lights when the HOME THX mode is selected.

EX: Lights during Surround EX matrix processing.

ES: Lights when a decoding DTS ES audio.

DISC: Lights during DTS ES discrete processing.

MTRX: Lights during DTS ES matrix processing.

PRO LOGIC II: Lights during Dolby Pro Logic II processing.

NEO:6: Lights during NEO:6 processing.

2CH PLAYBACK Lights during two-channel playback.

7 Speaker indicators

Light to indicate the current speaker system, A and/or B.

8 TAPE 2 indicator

Lights when the TAPE 2 monitor is on.

Setting Up for Surround Sound

To ensure the best possible surround sound, complete the following setup operations. Some of these may be the same (and take precedence over) the settings you made in the Quick Start Guide. If you think the ones you made at that time were adequate move on to the next setting here. You only need to make these settings once (unless you change the placement of your current speaker system or add new speakers, etc.). These setup operations use on-screen displays (OSDs) on your TV to display the settings and choices so be sure your TV and amplifier are properly hooked up and that your TV is set to this amplifier. Also, make sure the microphone that hooks up to the front panel of the amplifier is connected as in some cases you may need to use it. For more information on the microphone hookup see pages 14-16.

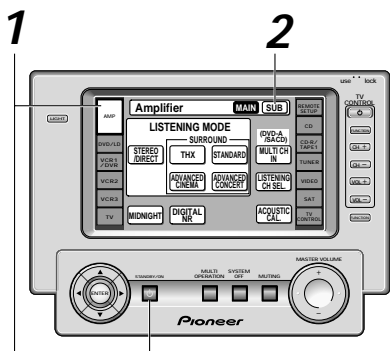

1 Turn on the amplifier and your TV, press the AMP on the remote control.
Make sure your TV is connected and set to the amplifier.

2 Press the SUB button on the amplifier screen.

3 Press the SYSTEM SETUP button.
The menu possibilities appear on your TV.

4 Use the ▲▼ and buttons to select SURROUND SETUP. Press ENTER.

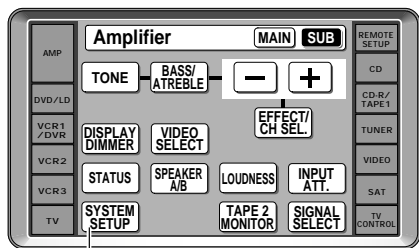

3

4

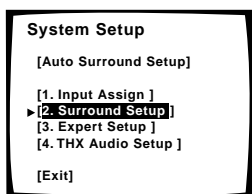

5 Follow the order below to set up your speakers for better sound. Use the ▲▼ and ◀▶ buttons to navigate through the menus. When you have the setting you want in a particular menu, press ENTER.

In each mode, the current settings are displayed. We suggest you adjust all these settings when you first hook up the amplifier. That gets them out of the way and you won't need to return to this setting mode unless you change your home setup by adding new speakers (etc.).

SPEAKER SYSTEMS (See p.38-40)

Use to specify the type and number of speakers you connected.

CHANNEL DELAY (See p.41)

You must add distance settings to all your speakers for the most realistic surround sound. Adding a slight delay to some speakers enhances sound separation and is particularly important for achieving a surround sound effect. You need to figure out the distance from your listening position to your speakers to add the proper delay.

CHANNEL LEVEL (See p.42-43)

Use to balance the volumes of your different speakers.

ACOUSTIC CALIBRATION (See p.43-44)

This setting is a kind of room equalizer for your speakers.

SPEAKER SYSTEMS

The following steps show you how to select the correct setup for the type and number of speakers you connected. Most importantly, you need to decide how to route the sound for all the speakers you connected. To do this select the size of the front, center, surround and surround back speakers (if you hooked them up). It is important to make these settings as accurately as possible or, in some cases, you may not get the full soundtrack from a disc. The auto setup from the microphone may not properly assess the size of your speakers if there is background noise, from an air conditioner or refrigerator, for example. If necessary try different possible settings manually.

Use the information below to complete the steps that follow and set up the amplifier to match the speakers you have hooked up. Make sure the microphone is hooked up to the front panel and in the appropriate position before starting. See page 14 for more information on setting up the microphone.

FRONT (default setting is SMALL)

Select SMALL to send bass frequencies to the subwoofer. Select LARGE if your speakers will reproduce bass frequencies effectively or if you did not connect a subwoofer. (If you select SMALL for the front speakers the subwoofer will automatically be switched YES. Also, the center and surround speakers cannot be set to LARGE if the front speakers are set to SMALL. In this case, all bass frequencies are sent to the subwoofer.)

CENTER (default setting is SMALL)

- Select LARGE if your speaker will reproduce bass frequencies effectively.
- Select SMALL to send bass frequencies to the other speakers or subwoofer.
- If you did not connect a center speaker, choose NO. In this case, the center channel is output from the front speakers.

SURROUND (default setting is SMALL)

- Select LARGE if your speakers will reproduce bass frequencies effectively.
- Select SMALL to send bass frequencies to the other speakers or subwoofer.
- If you did not connect surround speakers choose NO. In this case, the sound of the surround channels is output from the front and center speakers.
- Remember, if you select SMALL for the front speakers, the surround and surround back speakers can only be set to SMALL.

SURROUND BACK (default setting is SMALL X2)

- Select the number of surround back speakers you have. You can choose one speaker, two, or none.
- If you select one, make sure that speaker is hooked up to the left surround back terminal.
- Select LARGE if your speakers will reproduce bass frequencies effectively.
- Select SMALL to send bass frequencies to the other speakers or subwoofer.
- If you did not connect surround back speakers choose NO.
- If the front speakers or the surround speakers are set to SMALL, the surround back speakers will automatically be set to SMALL.
- If you choose THX in step 2 then the surround back speakers can only be set to SMALL X1 or X2 (or NO).

SUBWOOFER (default setting is YES)

- Leave it selected if you connected a subwoofer.
- If you selected SMALL for the front speakers the subwoofer will automatically be set to on (you won't be able to choose NO or PLUS).
- If you did not connect a subwoofer choose NO. In this case, the bass frequencies are output from the front or surround speakers.
- Choose the PLUS setting if you want stronger reproduction of deep bass sounds.
- If you select PLUS the bass frequencies that would normally come out the front and center speakers are all routed to the subwoofer.

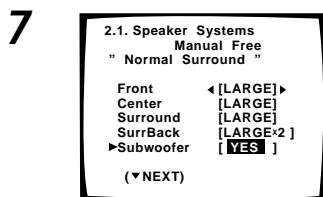
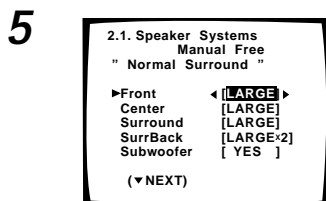
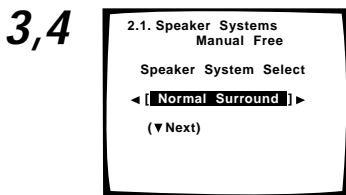
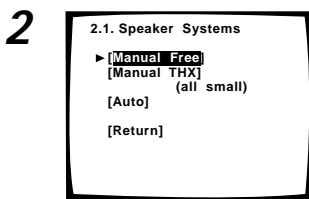
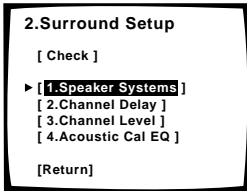
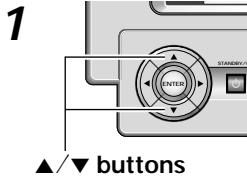

1 SPEAKER SYSTEMS should be selected. If it isn't use the ▲▼ buttons to select it. Press the ENTER button.

The setup possibilities appear on your TV.

2 Use the ▲▼ buttons to select the speaker system setting.

Choose from:

MANUAL FREE: Sets all the speakers

MANUAL THX: All speakers are set to SMALL. You can select the number of surround back speakers.

AUTO: All speakers are set automatically. (The microphone must be hooked up to the front panel in order to use this setting.)

For **MANUAL FREE**, select it and press **ENTER**. Then go to step 3.

For **MANUAL THX**, select it and press **ENTER**. Then go to step 3.

For **AUTO**, select it and press **ENTER**. Be prepared for loud test tones and make sure the room is free of ambient noise (see memo page 16). When you see **OK** on the OSD the setup is finished. Go to step 9.

3 Use the ◀▶ buttons to select either NORMAL SURROUND or FRONT BI-AMP (5.1).

NORMAL SURROUND: For normal home theater use
FRONT BI-AMP (5.1): Settings for bi-amp (see p.67).

4 Use the ▼ button to go to the next screen.

5 With the ▲▼ buttons choose the set of speakers that you want to set.

If you selected **MANUAL THX** in step 2 set all speakers, except for surround back, to **SMALL**.

6 Use the ◀▶ buttons to choose the size and number for each set of speakers as well as LARGE, SMALL, YES, NO or PLUS.

7 Repeat steps 5 & 6 for all speakers channels.

Setting Up for Surround Sound

9

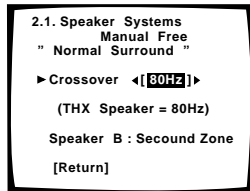

10

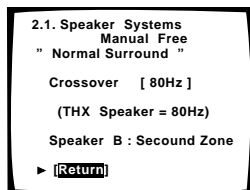

8 Use the ▼ button to go to the next screen.

9 Use the ◀ ▶ buttons to choose a Crossover Frequency of 50 Hz, 80 Hz, 100 Hz, 150 Hz or 200 Hz.

Certain bass sounds will play back from the subwoofer if you selected it as YES (or PLUS) or from the front speakers if you selected them as LARGE.

This setting decides where the cutoff will be between those bass sounds playing back from the speaker selected as above and the bass sounds for the entire soundtrack, which play back from all speakers used.

If you selected **MANUAL THX** in step 2 the Crossover Frequency is set to 80Hz and this screen doesn't appear.

10 Use the ▲ ▼ buttons to select RETURN and press ENTER.

Next, proceed to CHANNEL DELAY below.

If you want to change a setting before proceeding start over from step 1.



If you have a subwoofer and like lots of bass, it may seem logical to select LARGE for your front speakers and leave the subwoofer selected. This may not, however, yield the best bass results. Depending on the size and shape of your room you may actually experience a decrease in the amount of bass due to what is called "low frequency cancellations." If you have a subwoofer, listen to the bass response with the front speakers set to LARGE and SMALL alternatively and let your ears judge which sounds best.

If you have a subwoofer, the safest option is to route all the bass sounds to it by selecting SMALL for the front speakers.

CHANNEL DELAY

Adding a slight delay to some speakers is necessary to achieve proper sound depth, separation as well as an effective surround sound effect. You need to figure out the distance from your listening position to your speakers to add the proper delay. The following steps show you how to set the delay time for each channel by specifying the distances from your listening position to each speaker. Once you specify the speaker distances (or it is done automatically through the AUTO selection, or in the Quick Start Guide), the amplifier calculates the correct delay times automatically. If continuing from SPEAKER SYSTEMS go to step 1. If starting fresh, complete steps 1-4 in "Setting Up for Surround Sound" (p.37) first.

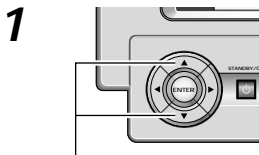

▲/▼ buttons

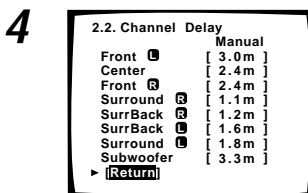
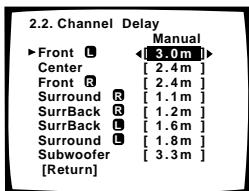
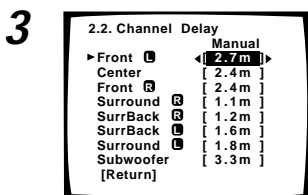
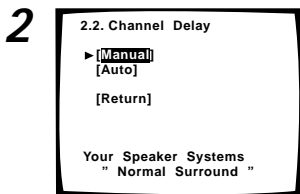
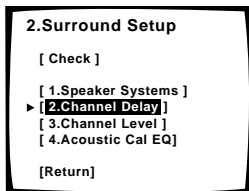

1 The CHANNEL DELAY should be selected. If it isn't use the ▲▼ buttons to select it. Press the ENTER button.

The setup possibilities appear on your TV

2 There are two ways to set the CHANNEL DELAY, MANUAL and AUTO. Select the method you'd like to use with the ▲▼ buttons and press ENTER.

MANUAL: In this way of setting the distance you choose the speaker and adjust the distance yourself.

AUTO: This way of setting the delay time is like that described in the Quick Start Guide (p.14-17). The levels are set automatically by the amplifier as it outputs the test tones. For this setup you must have the setup mic connected (see page 14).

WARNING : Be prepared! The test tones are output at a high volume level.

MASTER VOLUME rotates to the reference position (0 dB) and the display on the amplifier flashes TEST TONE. After a few seconds the test tone is output.

3 For MANUAL, Select each speaker with the ▲▼ buttons. Use the ◀▶ buttons to add or subtract the distance in meters that the speaker is from your normal listening position. For AUTO you don't need to do anything

Adjust the speaker distance in 0.1 increments from 0.1 to 15 meters.

The default setting is 2 m.

4 When done select RETURN with the ▲▼ buttons and press ENTER.

Next, proceed to CHANNEL LEVEL below.

If you want to change a setting before proceeding Start over from step 1.



If you have surround back speakers we recommend putting them at the same distance so you can use the ASA feature (see p.94 & 96).

CHANNEL LEVEL (channel balance)

The following steps show you how to balance the sound output level of your speakers. Proper speaker balance is essential for obtaining high quality surround sound. If continuing from CHANNEL DELAY go to step 1. If starting fresh, complete steps 1-4 in "Setting Up for Surround Sound" (p.37) first. If you're not sure of the best setting for your system, we recommend setting the CHANNEL LEVEL to AUTO.

1

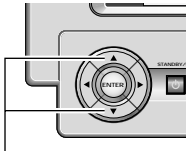

▲/▼ buttons

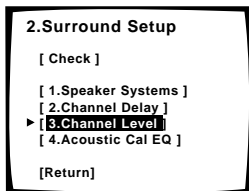

2

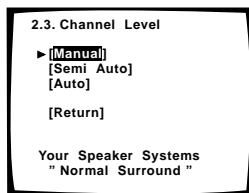

3

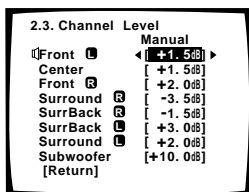

- If your subwoofer has a volume control, set it to the middle position before doing these operations.

1 CHANNEL LEVEL should be selected. If it isn't use the ▲▼ buttons to select and press ENTER.

2 There are three ways to set the CHANNEL LEVEL: MANUAL; SEMI AUTO; AUTO. Select a setting mode with the ▲▼ buttons and pressing ENTER. Test tones will be output.

MANUAL: For this setting method you move the test tone manually and adjust the channel level.

SEMI AUTO: in this setting the test tone moves by itself and you set the levels.

AUTO: This way of setting the levels is like that described in the Quick Start Guide (p.14-17). The levels are set automatically by the amplifier as it outputs the test tones. For this setup you must have the setup mic connected (see page 14).

WARNING : Be prepared! The test tones are output at a high volume level.

MASTER VOLUME rotates to the reference position (0 dB) and the display on the amplifier flashes TEST TONE. After a few seconds the test tone is output.

3 Adjust the level of each channel using the ◀▶ buttons (except for the AUTO setting where the adjustment is done automatically).

NOTE : The volume of the subwoofer test tone tends to sound lower than it actually is. You may need to adjust the level after testing with an actual soundtrack.

In MANUAL (manual test tone) mode

This mode lets you switch the test tone between each speaker the ▲▼ buttons manually.

In SEMI AUTO (automatic test tone) mode

This mode switches the test tone between each speaker automatically. The automatic test tone is output in the following order:

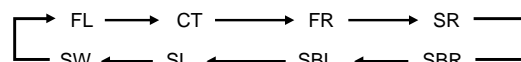

Adjust the level of each speaker as the test tone is emitted.

If you are using a Sound Pressure Level (SPL) meter

Take the readings from your main listening position and adjust the level of each speaker to 75 dB SPL (C-weighting/slow reading).

4

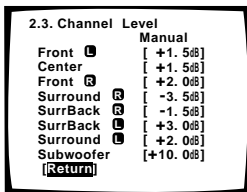
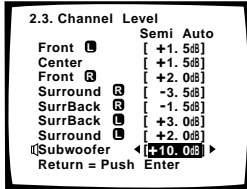
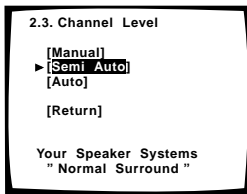

4 In **MANUAL** mode, when done select **RETURN** with the **▲▼** buttons and press **ENTER**.
In **SEMI AUTO** mode, anytime you want to exit the process press **ENTER**.

The display on the amplifier will say **RESUME** and the **MASTER VOLUME** will return to its original position.

Next, proceed to Acoustic Calibration EQ.



You can change the channel level of each speaker at any time by using the **EFFECT CH/SEL.** and **+/-** buttons on the **AMP SUB** screen on the remote control. You can set the levels for each three groups of the listening modes (**STANDARD/HOME THX**, **ADVANCED CINEMA/ADVANCED CONCERT**, **STEREO**) and **MULTI CH IN** mode but keep in mind that all your settings will be cleared if you use the **Surround Setup** or **Auto Surround Sound Setup** to set the channel levels at a later date.

Acoustic Calibration EQ

This setting is a kind of room equalizer for your speakers, excluding the subwoofer. You can select the frequency balance between your speakers that suits your personal tastes. This feature also allows you to increase the amount of a certain frequency in the soundtrack, which will have the effect of hearing more (or less) bass, mid-range or treble. Use this feature by following the on-screen displays (OSD) on your TV and using the arrow and **ENTER** buttons. If starting fresh, complete steps 1-4 in "Setting Up for Surround Sound" (p.37) first.

1

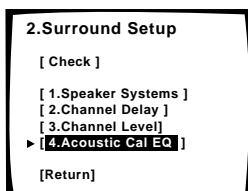

1 **ACOUSTIC CAL EQ** should be selected. If it isn't use the **▲▼** buttons to select and press **ENTER**.

You should get the first Acoustic Calibration screen on your TV.

Setting Up for Surround Sound

2

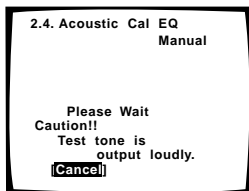
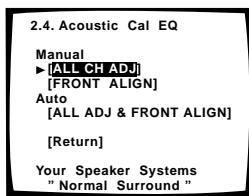

3

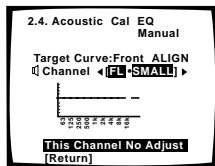
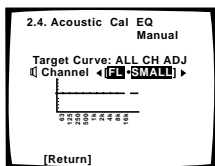

4

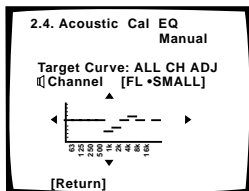

6

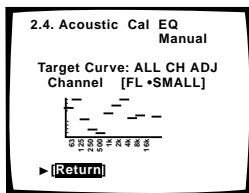

2 There are two ways to adjust the Acoustic Calibration EQ, **MANUAL** and **AUTO**. Use the **▲▼** buttons to select the type of setting you want to use and press **ENTER**.

MANUAL: Of these manual settings you can choose ALL CH ADJ mode or FRONT ALIGN mode.

ALL CH ADJ mode (flat curve): All the speakers are set individually (except for the subwoofer). No special weighting is given to any channel over any other channel so this setting is the most direct representation of the source being played.

FRONT ALIGN mode (front speaker curve): All speakers (except for the subwoofer) are set in accordance with the settings of the FRONT speakers. This setting allows the listener to enjoy a sound balance defined by the front speakers (the main speakers for home theater).

AUTO: The frequency balance is set automatically by the amplifier (see page 14) and both types of manual calibration are adjusted this way.

WARNING : Be prepared! The test tones are output at a high volume level.

3 If you're using a **MANUAL** setting, use the **◀▶** buttons to select the speaker and press **ENTER**.

If you have selected the FRONT ALIGN mode, you can't set the frequency for the front left and right speakers.

4 Use the **◀▶** buttons to select the frequency and **▲▼** buttons to add or subtract decibels from that frequency.

Changing the frequency balance of one channel too drastically will result in a poor overall level balance. You can adjust the speaker levels using the WIDE feature, which allows you to align the speaker level while listening to the test tone.

To use the WIDE feature, use **▶** to move to the far right side of the OSD then use **▼** and **▲** to raise or lower the level of that channel.

5 When you have the frequency balance you want for that speaker press **ENTER** to move to the next speaker and repeat step 3.

6 Select **RETURN** with the **▲▼** buttons when done and press **ENTER**.

You will return to the SURROUND SETUP menu. If you want to proceed to CHECK THE AUTO SETTINGS select return and press ENTER. If you want exit the setup process select EXIT and press ENTER.



The message EQ GAIN OVER indicates there is a possibility the sound will distort due to an extreme frequency balance. If this message appears, adjust the frequency balance accordingly.

Check the Auto Settings

If you want to check what settings have been input for your surround sound parameters you can do it following the steps below.

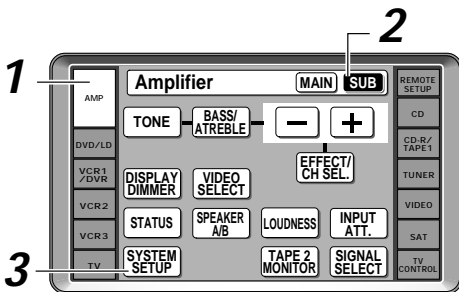

1 Switch on the amplifier and your TV.

Make sure your TV is set to this amplifier as you will use the on-screen displays on your TV to follow these instructions.

2 Press the SUB button on the remote control's AMPLIFIER screen.

3 Press the SYSTEM SETUP button and use the on-screen display (OSD) that appears on your TV.

The SYSTEM SETUP menu appears on the OSD.

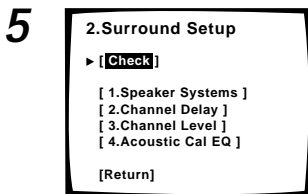

4 Use the ▲▼ buttons to select SURROUND SETUP and press ENTER.

5 CHECK should be selected, press ENTER.

6 The first menu in which you can check your settings will appear. This is the speaker settings.

Navigate this menu with the ◀▶ buttons.

7 When you want to check the next settings select NEXT with the ▲▼ buttons and press ENTER.

The order of the settings menus is: Speaker Systems; Channel Delay; Channel Level; Acoustic Calibration EQ.

If you want to leave the settings check select RETURN with the ▲▼ buttons and press ENTER.

8 Continue to move through the menus using the ▲▼ buttons and pressing ENTER until you are done checking the settings.

9 To exit the this mode select RETURN with the ▲▼ buttons and press ENTER.

You will return to the SURROUND SETUP menu. Then select EXIT and press ENTER to exit the setup process.

Basic Operation

Stereo and Multichannel Playback

The following instructions show you how to play Dolby Digital, MPEG or DTS sound sources with the VSA-AX10. Before doing so be sure to complete the setup procedures described in the Quick Start Guide (starting on page 14) or Setting Up for Surround Sound (starting on page 37). This is particularly important to achieve a surround sound effect with Dolby Digital, MPEG or DTS sources.

Listening Modes available to you are contingent on what kind of source you are using and what LISTENING CH SELECT (7.1/5.1/AUTO) option you choose. For background information on these ideas see page 10 (Home Theater: The Basics) and for more information of the listening modes and their uses see pages 49-52. Be sure to select speaker A or if you are bi-amping the front speakers select A&B (see p.67).

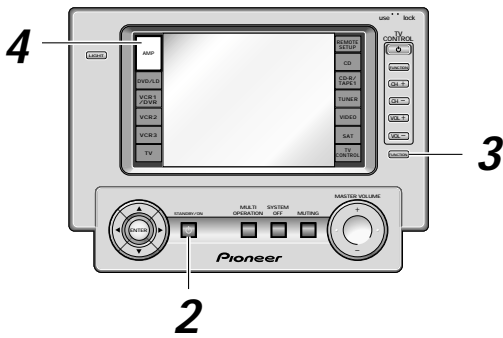

1 Turn on the power of the playback component.

2 Press the  STANDBY/ON button to turn on the amplifier.

Be sure that the standby indicator turns off on the front panel.

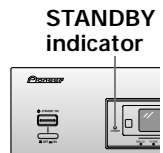

3 Press the INPUT on the remote control to select the source you want to playback.

On the front panel, use the INPUT SELECTOR dial to select the source. The default setting for the input signal is AUTO, if you need to select ANALOG, DIGITAL or  RF see p.48.

4 Press AMP.

5 Press the LISTENING CH SEL. button on the remote control's AMP MAIN screen.

Each press switches LISTENING CH SELECT between 5, 1, 7.1 and AUTO (see page 47 for more on this). On the front panel, use the LISTENING CH SELECT button to select the channel.

6 Choose a listening mode by pressing STEREO/DIRECT, THX, ADVANCED CINEMA, ADVANCED CONCERT, or STANDARD.

On the front panel, use the LISTENING MODE SELECTOR dial. Depending on whether your source is 2 channel, 5.1 channel or 7.1 channel and your speaker configuration you will get different options for each of these modes. Press the button (or dial) repeatedly to cycle through these options. See "Listening Modes," on p.49-52 for details on which modes are available and in which situations they are designed to be used.

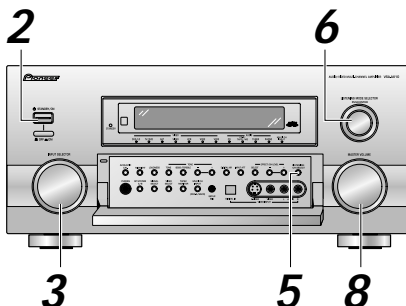
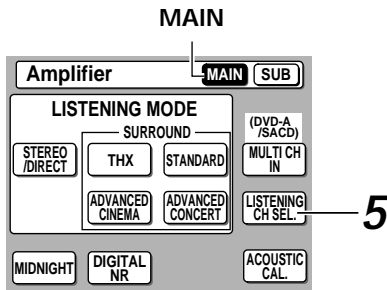

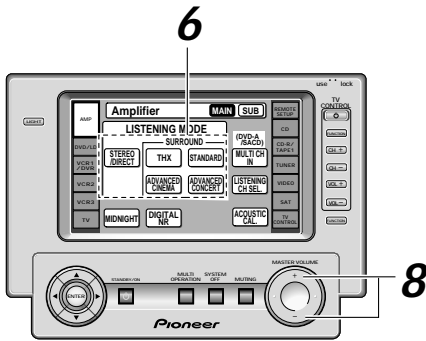

7 Start playback of the component you selected in step 3.

8 Adjust the volume by using the MASTER VOLUME buttons on the remote control. On the front panel use the MASTER VOLUME dial.



If the TAPE 2 indicator is visible in the display, it means the TAPE 2 MONITOR is on. Press TAPE 2 MONITOR on the AMP SUB screen or the front to turn it off unless you want to listen to the component hooked up to TAPE 2.

Switching the channels used for playback (LISTENING CH SELECT)

This button selects the number of channels used for playback, either 5.1 or 7.1 (includes 6.1). The default setting is AUTO, which will choose the appropriate playback channels for the source, speaker configuration and listening mode you are using. For more details see pages 49-52.

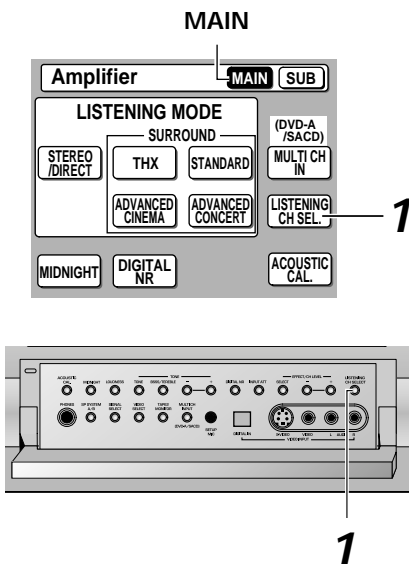

1 Press the LISTENING CH SEL. button on the remote control's AMP MAIN screen.

Each press switches LISTENING CH SELECT between 5.1, 7.1 and AUTO.



- If you haven't set your system up with surround back speakers you won't be able to choose 7.1 channel or AUTO with this button.
- LISTENING CH SELECT options may change if the SPEAKER SYSTEM settings are changed. (p.38).
- LISTENING CH SELECT affects which listening modes will be available.
- You can't select LISTENING CH SELECT in stereo mode.

Basic Operation

Switching ANALOG/DIGITAL Signal Input



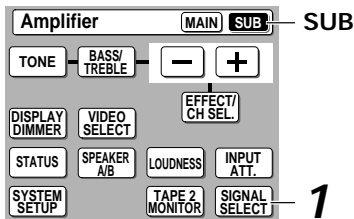

This button selects the type of input signal, ANALOG, DIGITAL or  RF, sent to the amplifier. You need to take special care to switch to the appropriate input when necessary. For example, the switch would have to be on DIGITAL to hear DOLBY DIGITAL, MPEG or DTS surround sound material but it would have to be on analog to record from the ANALOG out jacks on the amplifier. The default setting is AUTO which chooses digital over analog when both are available but goes with whatever is available if it is the only choice.

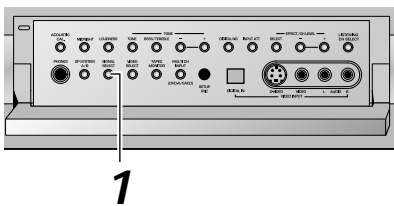
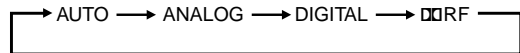

1 Press the SIGNAL SELECT button on the SUB screen.

Each press switches the signal in the order below:



- In the AUTO setting, amplifier chooses the signal, based on availability, in the following order of priority:  RF, DIGITAL, ANALOG.
- When DIGITAL signal is selected,  DIGITAL lights when a Dolby Digital signal is input; DTS lights when a DTS signal is input.
- If no digital inputs (see p.80) are assigned, the SIGNAL SELECT will default to ANALOG.
- Because the audio signal from a karaoke microphone and LDs are recorded with analog audio only, they are not output from the digital outputs. Set SIGNAL SELECT to ANALOG to listen to these formats.
- When an LD with DTS is played back with the SIGNAL SELECT set in ANALOG, digital noise caused by playing back the DTS signal directly (with no decoding) is output. To prevent noise, you need to make digital connections (See p.24 & 25) and set SIGNAL SELECT to AUTO or DIGITAL.
- Some DVD players don't output DTS signals. For more details, refer to the instruction manual supplied with your DVD player.
- This amplifier can only play back Dolby Digital, MPEG, PCM (32kHz, 44kHz, 48kHz, 88kHz and 96kHz sampling frequency), and DTS digital signal formats. If your source is not one of these select ANALOG for playback.
- Make sure you connect your DVD/LD or LD players using the  RF jack. If your player has a  RF output this will ensure you can use all LDs. Refer to p.19.

Playback of 96kHz 24 bit sound formats

This amplifier is capable of playing back 96kHz/24bit sound formats (such as DTS 96/24 and PCM 96kHz (up to 24bit)).

To Playback with the Best Sound Quality (all processing is done at 96 kHz).

For DTS 96/24 5.1 format, connect both center and surround left/right speakers, set LISTENING CH SELECT to AUTO or 5.1, choose STANDARD mode and turn off all sound functions. For 96kHz 2ch format (either DTS or PCM) choose STEREO mode and turn off sound functions. For both these playbacks, "96kHz" will appear in the amplifier's display. If it doesn't the processing is being done at 48kHz.

You can listen to DTS 96/24 soundtracks through this amplifier if your DVD player has a DTS output feature, even if it can't output 96kHz digital signals. For PCM 96kHz soundtracks, however, you won't be able to listen to them with digital connections if your DVD player can't output 96kHz digital signals. Also, if you set RE-EQ on you won't be able to get 96kHz processing.

Check the manual that came with your DVD player to confirm what it can output and for more information on these formats.

Listening Modes

The five listening mode types on the amplifier are explained here. These can be turned on from the front panel or from the AMPLIFIER MAIN screen on the remote control. To select listening modes see page 46.

The kind of playback you can get in the listening modes depends on what kind of source (DVD, etc.) you are using. The basic distinction is between 2 channel sources and multichannel sources. The playback available to you with these modes will differ depending on the source, speaker configuration the LISTENING CH SELECT setting. This is explained below.

Basically the ADVANCED CINEMA mode is for movie sources and the ADVANCED CONCERT mode is for music sources. The STANDARD, HOME THX and STEREO modes can be used with any source though the latter won't offer surround sound. Try different settings with various soundtracks to see which you like. You must choose one of the surround modes in order to get surround sound. Depending on your setup, in STEREO mode only the front two speakers, and sometimes the subwoofer (if you have one), are used.

STEREO modes

When a source is played in this mode, it plays through just the front left and right speakers (and possibly your subwoofer depending on your speaker settings). Dolby Digital, MPEG and DTS multichannel sources are downmixed to stereo.

STEREO

In STEREO mode the audio plays according to the surround setup settings and you can still use Acoustic Calibration EQ, Digital NR, Midnight mode, Loudness mode and Tone Control functions.

DIRECT

In DIRECT mode, the audio passes through the shortest signal path possible to remain as close to the source audio quality as possible.

Note: If you switch on Acoustic Calibration EQ, Digital NR, Midnight mode, Loudness mode or Tone Control when DIRECT is selected, the amplifier automatically switches to STEREO.

STANDARD modes

This mode is for pure decoding of Dolby Digital, MPEG, Dolby Surround and DTS sources as well as surround matrix decoding of 2 channel sources. It is good for enjoying regular movies/videos that have been recorded in Dolby Digital, Dolby Surround. DTS, STANDARD TX/SX is also the basic mode for enjoying sources with surround and surround back channels. For more detailed information see p.12, 26, 38-40. The display will show you what kind of source (Dolby Digital, DTS, etc.) is being played.

For 2 Channel Sources:

DOLBY PRO LOGIC II MOVIE

This mode gives 5.1 channel surround sound. It is suitable for movies, especially those recorded in Dolby Surround. The channel separation and movement of surround effects is comparable to Dolby Digital 5.1.

DOLBY PRO LOGIC II MUSIC

This mode gives 5.1 channel surround sound and is suitable for music. Compared to the Movie Mode, the surround effect is more enveloping.

DOLBY PRO LOGIC

This mode gives 4.1 channel surround sound. It is less sensitive to the quality of the source material, so may be useful when PRO LOGIC II MOVIE/ MUSIC modes do not give good results.

NEO:6 CINEMA

This mode gives 6.1 channel surround sound and is suitable for movies. The NEO:6 Cinema mode delivers good channel separation for movie soundtracks.

NEO:6 MUSIC

This mode gives 6.1 channel surround sound and is suitable for music. The NEO:6 Music mode plays the stereo source as is through the front left/right speakers, and generates a natural, ambient surround and center sound.

Basic Operation

For 6.1 or 7.1 channel playback of 5.1 Channel Sources:

SX (Studio extension)

You can only use this mode if you have setup this amplifier for use with surround back speaker(s) (see pages 12, 26 & 38-40) and select 7.1 in LISTENING CH SELECT (see p.47).

This mode adds surround back channel(s) to 5.1 channel sources to give 7.1 channel surround sound. The sound you hear from the surround back speaker(s) is the same as the surround speakers. This recreates a 5.1 channel surround sound mixing studio or theater, which would usually have more than 6 speakers. The display shows the format of the source played.

TX (Technical extension)

You can only use this mode if you have setup this amplifier for use with surround back speaker(s) (see pages 12, 26 & 38-40) and select 7.1 in LISTENING CH SELECT (see p.47).

This mode generates surround back channel(s) for conventional 5.1 channel sources to give 7.1 channel surround sound. Any 5.1 channel source can be used, but some movies have soundtracks that sound especially good with TX mode on.

With 6.1 channel playback compatible sources, the TX mode is automatically selected when the LISTENING CH SELECT is set to AUTO (default).

HOME THX modes

THX and HOME THX are technical standards created by Lucasfilm, Ltd. for cinema and home theater sound. The aim of HOME THX is to improve the sound of straight decoding to make home theater audio more like the sound you hear in a cinema. See also page 93-94 for more information.

For all speaker playback of any source:

THX CINEMA

This mode will play any source through all the speakers in your system.

For 2 channel sources only:

After selecting one of the following modes the display shows the mode you selected, then, after a few seconds, shows THX CINEMA.

DOLBY PRO LOGIC II MOVIE

See page 49 for more on this mode.

DOLBY PRO LOGIC

See page 49 for more on this mode.

NEO:6 CINEMA

See page 49 for more on this mode.

For 6.1 or 7.1 channel playback of 5.1 channel sources:

THX SURROUND EX

You can only choose this mode if you have set up this amplifier for use with surround back speaker(s) (see pages 12, 26 & 38-40) and select 7.1 in LISTENING CH SELECT (see p.47).

For true 6.1 channel cinema sound, Dolby Digital Surround EX encoded discs should be played with THX Surround EX processing. However, it will also generate surround back channel(s) from any Dolby Digital 5.1 or DTS 5.1 channel disc (when playing a DTS disc, the display shows DTS-ES +THX).

With 6.1 channel playback compatible sources, the THX SURROUND EX mode is automatically selected when the LISTENING CH SELECT is set to AUTO (default).

For 7.1 channel playback of 5.1 channel sources:

THX ULTRA2 CINEMA

You can only choose this mode if you have set up this amplifier for use with two surround back speakers (see pages 12, 26 & 38-40) and select 7.1 in LISTENING CH SELECT (see p.47).

When played using THX SURROUND EX, the surround sound field may actually sound narrower on some earlier Dolby Digital 5.1 and DTS 5.1 channel sources than with THX CINEMA processing. THX ULTRA2 CINEMA creates two extra channels from these sources and plays them through the surround back speakers.

With 5.1 channel sources, the THX ULTRA2 CINEMA mode is automatically selected when the LISTENING CH SELECT is set to AUTO (default).

THX MUSICMODE

You can only choose this mode if you have set up this amplifier for use with two surround back speakers (see pages 12, 26 & 38-40) and select 7.1 in LISTENING CH SELECT (see p.47).

THX MUSICMODE is for Dolby Digital 5.1 and DTS 5.1 channel sources that were not produced for a theatrical release—typically music. This mode creates two extra channels of natural, ambient sound and plays them through the surround back speakers.

ADVANCED CINEMA modes

The ADVANCED CINEMA mode is a newly designed system for enhancing movie soundtracks and other audio-visual sources that optimizes its effects in accordance with your source, LISTENING CH SELECT and speaker configuration. There are six ADVANCED CINEMA settings that use DSP (Digital Signal Processing) to create different types of sound environments.

ACTION

This mode is designed for action movies, which generally use lots of sound effects. The mode enriches the sound to make it more realistic and extends the parameters to pick up high and low sound effects.

SCI-FI

This mode is designed for science fiction movies. It creates a broad sound space, separating dialog from sound effects to heighten the overall impact of the soundtrack.

DRAMA

This mode is designed for movies with a lot of dialog. The elements of dialog are enhanced, making the characters seem more real. The mode also compresses the dynamic range somewhat so loud sounds do not overpower softer ones (compare this with the MIDNIGHT listening mode explained on p.54).

MUSICAL

This mode is primarily for music and adds a spacious feeling to the sound. A long delay time of reflected sounds provides resonant tones which emulate a concert hall.

MONOFILM

This mode is designed for older movies which are recorded with mono soundtracks. The special sound processing of this mode will allow you to experience these movies in surround sound even though they were not recorded that way originally.

X-D THEATER

This mode is especially designed to give sound depth to stereo sources. The overall effect builds a dynamic and broad sound space, allowing two-channel (stereo) signals to faithfully imitate a five speaker sound. The mode should be used in conjunction with Dolby Pro Logic for sources bearing the

 **DOLBY SURROUND** mark.

Basic Operation

ADVANCED CONCERT modes

The ADVANCED CONCERT (Digital Signal Processing) modes allow you to transform your living room into a variety of different sonic environments when playing either two-channel or multichannel sources. It optimizes its effects in accordance with your speaker configuration, source and LISTENING CH SELECT choices.

CLASSICAL

Simulates the acoustic effects of a large concert hall. Suitable for classical music. A long delay time of reflected sounds, coupled with reverb effects, let the listener experience the dynamic and rich sounds characteristic of concert halls and powerful orchestral performances.

CHAMBER

Simulates the acoustic environment of a very resonant concert hall. Rich reverberation and a full sound create the impression of a lively performance space.

JAZZ

Simulates the acoustic effects of a jazz club. Reflected sound is virtually below 100 msec so that the listener can experience a live band effect.

ROCK

Simulates the acoustic effects of a mid-sized concert hall. The listener can experience a live band effect with good separation of the instruments, a strong bass and the vivid feeling of a live performance.

DANCE

Simulates the acoustic effects of a dance club. Features a strong bass sound. Reflected sound delay time is virtually below 50 msec, for the listener to experience the visceral power of dance music.

X-CH STEREO

Simulates the acoustic environment of a regular stereo while using all the speakers in the system to induce a rich, all-around sound. The display will change to 5CH STEREO or 7CH STEREO according to the sources, LISTENING CH SELECT and speaker configuration.

Adjusting the Effect of Advanced Listening Modes

The ADVANCED listening modes have sound processing added to accentuate a certain kind of atmosphere or effect (see the preceding pages for explanation). You can choose if you want to strengthen or weaken this effect in the given mode.

The following instructions show you how to adjust the amount of effect.

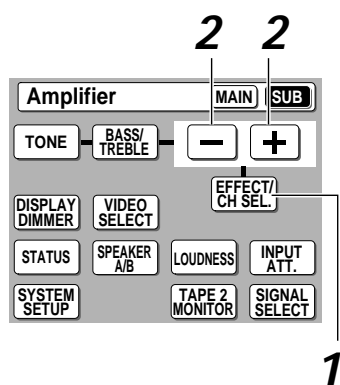

1 Press the EFFECT/CH SEL. button repeatedly until you see "EFFECT" in the amplifier's display.

2 Use the +/- buttons to add or subtract the amount of effect.



- The amount of effect can be adjusted ranging from 10 to 90 (the default setting value is 70) by pressing +/-.
- 5/7CH STEREO modes cannot be adjusted.

Listening with Acoustic Calibration EQ

You can listen to the soundtrack with the Acoustic Calibration EQ you set in AUTO SURROUND SETUP or on page 43. To do so follow the instructions below. For information about each Acoustic Calibration EQ mode, see page 43-44.

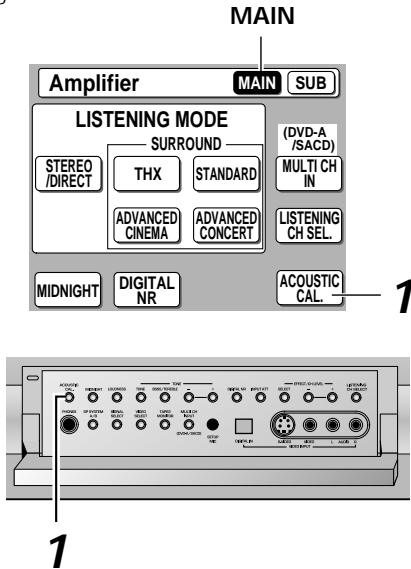

1 Press the ACOUSTIC CAL. button on the remote control's AMP MAIN screen or on the front panel.

Each press switches acoustic calibration EQ between ALL CH ADJ, FCH ALIGN and OFF.



- After completing the AUTO SURROUND SETUP (p.14-16), or setup using AUTO (p.43), ACOUSTIC CAL ON (ALL CH ADJ) is set automatically.
- If you turn ACOUSTIC CAL. on in MULTI CH IN DIRECT mode, the amplifier automatically switches to MULTI CH IN ADJUST mode.
- If you turn ACOUSTIC CAL. on in DIRECT mode, the amplifier automatically switches to STEREO mode.

Reducing Noise During Playback (DIGITAL NR Function)

To reduce extraneous noise switch on DIGITAL NR. This feature is effective with sources containing a lot of background noise like cassette and video tape.

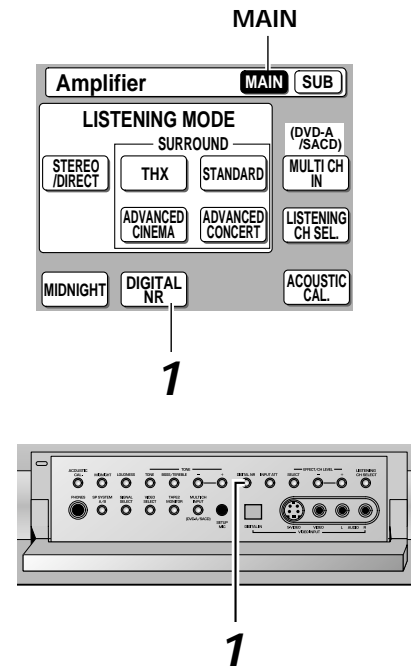

1 Press the DIGITAL NR button on the remote control's AMP MAIN screen or on the front panel.

Each press switches DIGITAL NR on or off.



- In cases described below, noises may not be reduced even if DIGITAL NR is on.
 - Sudden noise
 - Extremely loud noise
 - Signals that contain too many high frequencies.
 - Signals recorded with little background noise.
- DIGITAL NR is effective at levels shown below for each source.

STEREO (excluding 96 kHz)	
Analog input	10-18 dB
Digital input	10-15 dB
AM/FM tuner	10-15 dB
ADVANCED/STANDARD/96 kHz stereo	6-10 dB
- Depending on the condition of the source, there may not be a noticeable improvement in the quality of the sound.
- You can't use the DIGITAL NR mode with the HOME THX modes.
- If you set the DIGITAL NR on in DIRECT mode the amplifier will switch to STEREO mode.
- If you set the DIGITAL NR on in MULTI CH IN DIRECT mode, the amplifier automatically switches to MULTI CH IN ADJUST mode.

Listening in MIDNIGHT Mode

This useful feature makes it possible to get excellent surround sound effects even when listening at low volumes. It can be used with any surround sound source and play soundtracks so that the quieter sounds are audible even while playing a soundtrack at low volumes. This feature is applicable only when the master volume is under -20 dB.

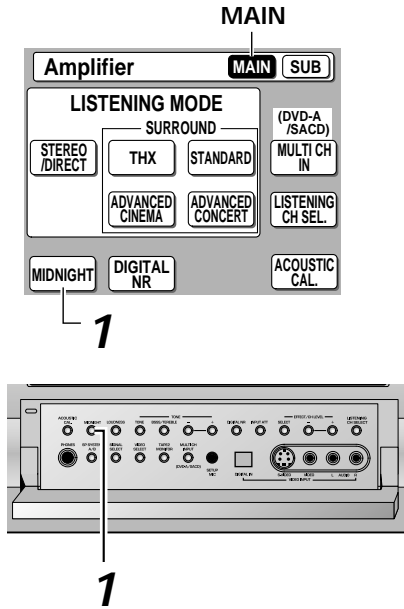

1 Press the MIDNIGHT button on the remote control's AMP MAIN screen.

Each press switches MIDNIGHT mode on or off.



- The surround effect adjusts itself automatically in accordance with the volume level.
- You can't use the MIDNIGHT mode with the HOME THX, LOUDNESS or TONE CONTROL modes.
- If you set MIDNIGHT on when in DIRECT mode the amplifier switches to STEREO mode.
- If you set MIDNIGHT on when in MULTI CH IN DIRECT mode, the amplifier automatically switches to MULTI CH IN ADJUST mode.

Listening in LOUDNESS Mode

The LOUDNESS mode boosts the bass and treble in a signal. It is useful for listening to music at low volumes.

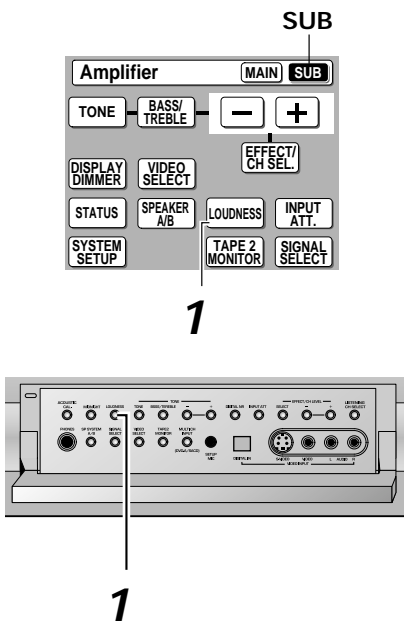

1 Press the LOUDNESS button on the remote control's AMP SUB screen.

Each press switches LOUDNESS mode on or off.



- You can't use the LOUDNESS mode with the HOME THX, MIDNIGHT, or TONE CONTROL modes.
- If you set LOUDNESS on in DIRECT mode the amplifier will switch to STEREO mode.
- If you set LOUDNESS on in MULTI CH IN DIRECT mode, the amplifier automatically switches to MULTI CH IN ADJUST mode.

Adjusting Bass and Treble (TONE CONTROL)

You can adjust the low (bass) and high (treble) frequencies. The TONE button can also be used to bypass the tone circuitry.

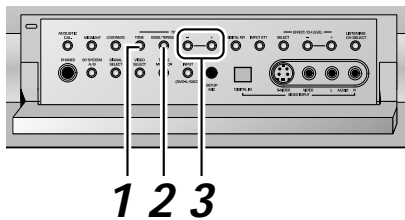
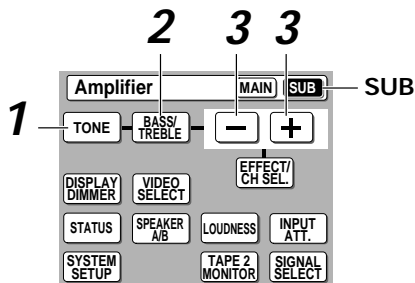

- 1 Press the TONE button on the remote control's AMP SUB screen or front panel to put the amplifier in tone adjust mode.**

There are two tone modes: TONE: ON and TONE: BYPASS. The first means the tone functions are active and also lets you adjust these functions. The second means the tone controls are being bypassed, and thus have no effect on the sound.

If TONE: BYPASS appears, press the button again to get TONE: ON, which is the tone adjust mode.

- 2 Press the BASS/TREBLE button repeatedly to select BASS or TREBLE.**

- 3 Use the +/- buttons to adjust the low or high frequency levels.**

A few seconds after you finish adjusting the tone the amplifier will revert to the sound mode it was in at the beginning of the process.



- The tone control can be adjusted in a range of ± 6 dB.
- The tone control cannot be set on in HOME THX, MIDNIGHT or LOUDNESS modes.
- If the amplifier is in DIRECT mode and you press the TONE button, TONE: BYPASS appears in the display. You will need to press TONE once more to switch the tone control on, canceling the (MULTI CH IN or STEREO) DIRECT mode.

DVD Audio/MULTI CHANNEL IN Playback

There are two types of MULTI CH IN modes: DIRECT and ADJUST. In the latter you can add sound features and in the former these are fixed. To select these two settings (as well as OFF) follow the procedure below.

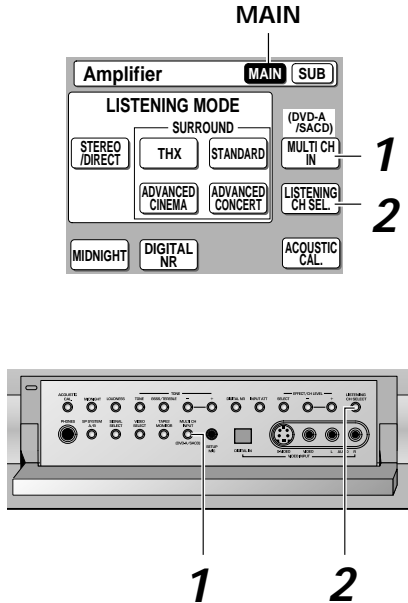

1 Press MULTI CH IN button on the remote control's AMP MAIN screen. Use the button to cycle through the different multi channel in modes.

DIRECT: This is a true playback of the signal from the MULTI CH INPUT terminals, output without digital processing. You can only control each channel level.

ADJUST: This setting allows three types of control over the sound output: You can: 1) control each channel level individually; 2) apply the settings in SURROUND SOUND SETUP (p.38-44) and 3) apply different sound features (p.53-55).

OFF: Cancels the MULTI CH IN modes.

2 Use the LISTENING CH SEL button to select the number of input channels.

You can select 2 or 8 channels. For best sound quality use 2 channels when you listen to stereo sources.



- The default setting is DIRECT.
- You can't select listening modes for MULTI CH IN. Selecting a listening mode cancels the MULTI CH IN.
- In DIRECT mode, if the center speaker is set to "NO" the signal for that channel is divided between the front speakers. If any other speakers are set to "NO" the signal for that (those) channel(s) won't get output at all.
- If the amplifier is in DIRECT mode, and you set sound features (p.53-55) on, the mode will change to ADJUST automatically.

See MULTI CH IN SELECT (p.86) for more on MULTI CH IN playback.

DUAL MONO Setting and playback

The dual mono setting can only be used when listening to Dolby Digital or homemade discs that have dual mono software encoded in them. Dual mono software usually is used to put two different mono recordings with one soundtrack on one DVD. With this setting you can choose which channel in the dual mono setting you want to listen to. Remember this setting is only applicable if you are using Dolby Digital software with dual mono and want to isolate one of the channels therein. Otherwise, just ignore this function.

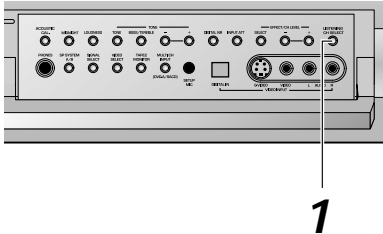

1

1 Press the LISTENING CH SELECT button for more than five seconds to put the amplifier in DUAL MONO mode.

Hold down the LISTENING CH SELECT button to cycle through the different DUAL MONO settings. When you find the one you want release the button.

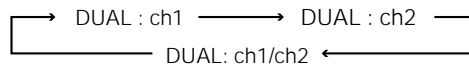

The different settings are: DUAL ch1, where you only hear channel 1; DUAL ch2, where you only hear channel 2; and DUAL ch1/ch2, where you hear both channels, but independently from different speakers.



- The default setting is DUAL ch1.
- You can only use this function with Dolby Digital sources that have this function
- When a DUAL MONO source is being used the [L] & [R] indicators flash. Then, if you select DUAL ch1, for example, the [L] indicator will light.

Input Attenuator

The input attenuator lowers the input level of an analog signal when it is too strong, causing distortion in the sound.

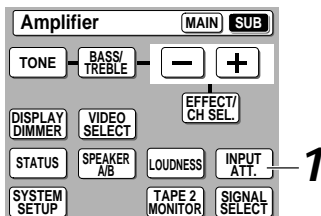

1

1 Use the INPUT ATT button on the AMP SUB screen to lower the analog input level.

Tape 2 Monitor

If you connect a cassette deck with a record monitor function (a three-head tape deck) to the TAPE 2 MONITOR jacks, you can listen to the sound of an analog recording as it's being recorded.

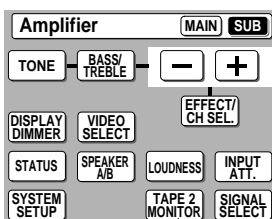

1

1 Use the TAPE 2 MONITOR button on the AMP SUB screen to listen to the component hooked up to the TAPE 2 MONITOR jacks.

Using the Headphones

The headphone feature is explained here.

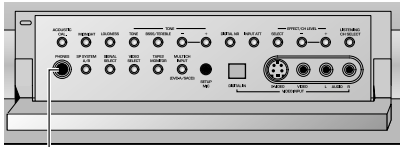

1 headphone jack

1 Plug headphones into the headphone jack on the front of the amplifier.

No sound will be audible from the speakers when headphones are plugged in.



- All listening modes will be downmixed to 2 channels.
- If you're listening to a 2 channel source there will be no matrix decoding (i.e. you will not be able to get surround sound decoding).
- If your U-shaped connectors (see p.32) aren't in place you won't be able to use headphones.

Video Select

This function allows you to listen to one sound source while you watch a different video source on your TV. The sound source is set in the normal fashion as is explained on p.46-47. You then alter the video input with the VIDEO SELECT button.

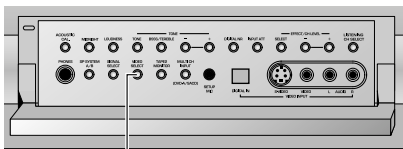

1 VIDEO SELECT

1 Use the VIDEO SELECT button on the AMPLIFIER'S SUB screen or the front panel to cycle through the different possible video inputs.

The first press shows the video input you are currently using. After that pressing VIDEO SELECT cycles through the possibilities in the following order:

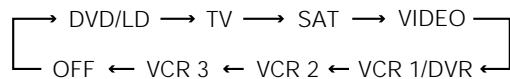

The OFF setting means you are listening without a video signal. (Also, when you select CD-R/TAPE1/MD, CD, TUNER, or PHONO functions the VIDEO SELECT will be set to off.)

After choosing a video input the display on the amplifier will show that input for about 5 seconds and then revert to showing the listening mode the amplifier is in.



- The VIDEO SELECT remains set to the input you chose until you change the audio input.
- If you change audio functions the amplifier will reset itself to make the video and audio inputs correspond. Also, if you switch the power of the amplifier off when you turn it back on the video and audio inputs will reset so that they correspond. The same thing will happen if you select CD-R/TAPE1/MD, CD, TUNER, or PHONO functions.

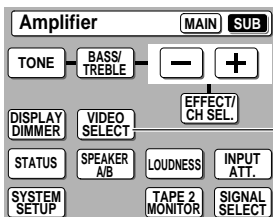

1

Adjusting the Brightness of the Display

Use the DISPLAY DIMMER button to adjust the brightness of the fluorescent display.

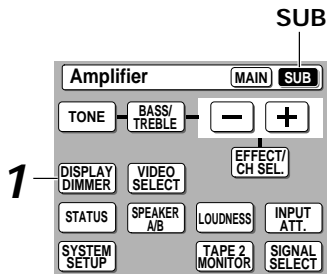

1 Use the DISPLAY DIMMER button on the SUB screen of the remote control to alternate between the different levels of brightness for the display.

Four levels of brightness ranging from very dim to very bright can be selected. Each press changes the brightness of the display. When cycling through the options the default brightness can also be selected.



- Please note: It is a feature of this unit that the fluorescent display will be brighter for a few seconds after you choose a function (like DVD/LD, CD, etc.) and then get softer. This will still happen when you adjust the brightness but the new setting will be the one the display softens to.

Status Display

The Status display lets you see what the status is for most of the settings in this section.

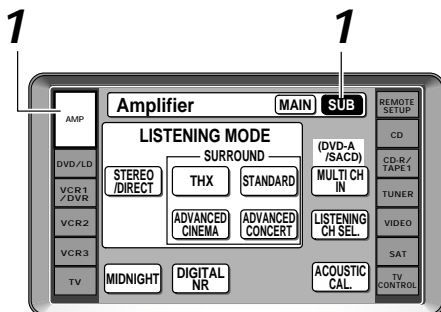

1 Press AMP. Choose the SUB screen.

2 Press the STATUS button.

The status of the settings will appear on both the OSD and the display on the amplifier. For the latter the settings will appear in the following order for two seconds each.

- Listening Channel Select
LISTEN'CH: 7.1
- Acoustic Calibration
A-EQ: ALL CH ADJ
- Digital Noise Reduction
DIGITAL NR: OFF
- Midnight Mode/ Loudness/ Tone Control
MID LOUD TN: OFF
- Input Attenuator
INPUT ATT: OFF
- Tape 2 Monitor
TAPE2: OFF
- Video Select
VSEL: DVD/LD

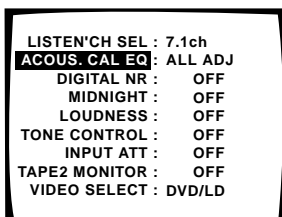
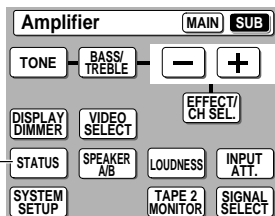

Remote Control of Other Components

Setting Up the Remote Control to Control Other Components

In addition to controlling the amplifier, the supplied remote control can operate your other components (VCR, TV, DVD, CD, etc.) after you program it to do so. In this way, instead of fumbling with many different controls and buttons, you only need to use one remote control. If your component(s) are listed in the remote control's memory, simply follow the steps below. If your component(s) are not listed, or if you want the remote to learn additional operations, you can use the learning mode to input the information from the remote controls supplied with your other components.

Recalling Settings Stored in the Remote Control

The following steps show you how to recall the setting stored in the remote control. Once a setting is recalled and the component assigned, you can use this remote to easily operate the component.



- You can press the BACK button at any time to go back a screen.
- See "Using the Remote Control with Other Components" on page 64 to operate your other components.

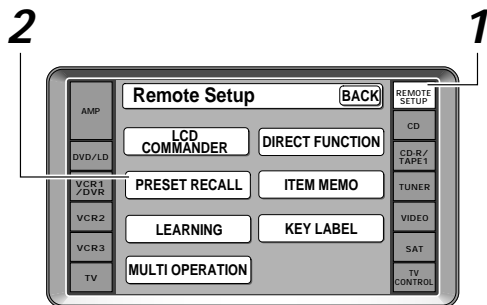

1 Press the REMOTE SETUP.

The REMOTE SETUP menu appears on the remote control's screen.

2 Press the PRESET RECALL button on the remote control.

The step by step process will appear on the remote control. First, SELECT FUNCTION will appear.

3 Choose the button (for example, DVD/LD) you want to assign to control the component you want to operate.

SELECT ITEM will appear in the remote control screen.

4 Choose the component you want to set up.

In the example in the diagram on the left, DVD/LD was selected in step 3. Thus, [DVD/LD] appears in the top bar after Preset Recall.

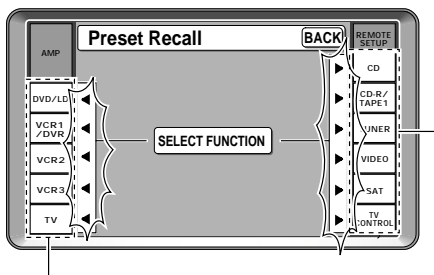

3

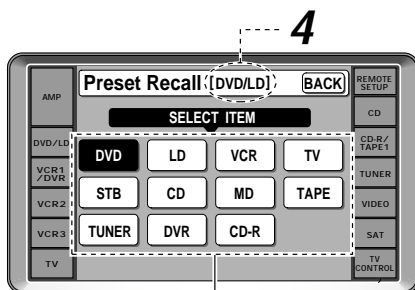

4

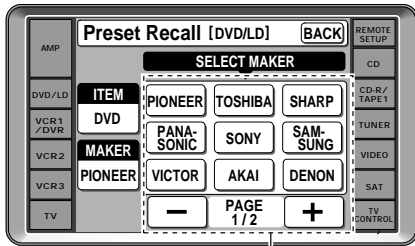

5

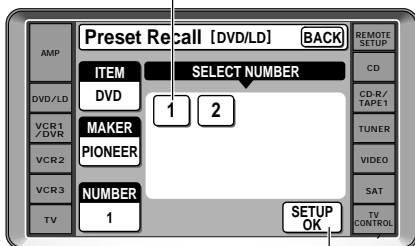

6

7

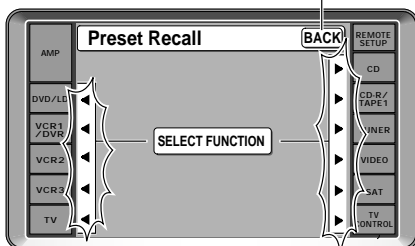

9

5 Select the name of the company that makes your component.

If there are two pages of company names, use the page +/- buttons to go back and forth between the two sets of makers' names. For explanation purposes, we'll use PIONEER as an example.

6 Press the number 1 button.

If the component you are trying to control turns on/off, the setup for this component is complete, but components that don't have a standby mode can't respond in this way. To test if you've set it up properly work through step 8. Then try using selecting the function you just setup (for example a CD player) and using the controls on this remote control. If the component does not respond, try working through the procedure again and pressing number 2 instead this time. Continue this procedure until one of the commands works.

If none of the commands seem to work, try the learning mode to program the component into the remote control. This is explained on the following page.

To go back a screen

press the BACK button.

To exit the process without inputting the commands press the BACK button repeatedly.

7 Press the SETUP OK button and the screen returns to SELECT FUNCTION so you can program another component into the remote control.

Naturally it's easiest and most logical to assign the button that has the same name as the component you are setting up (for example, choose the DVD/LD button for your DVD player).

You may find you have components which do not correspond to the name on any MULTI CONTROL button (for example a cable TV tuner) or you have two components where only one button is provided (for example, CD-R/TAPE 1). In this case, use step 3 to assign any available MULTI CONTROL button to the component you want to remote control.

For example, you may have both a CD-R and a tape deck in your system but only one video deck. It would make sense to assign the CD-R/TAPE 1 MULTI CONTROL button to the CD-R and the VCR 2 MULTI CONTROL button to your tape deck. To do this choose VCR 2 in step 3 when you want to set up the tape deck. Then choose TAPE in step 4 and proceed as above. The only practical difference in this method is that you have to remember the VCR 2 MULTI CONTROL button is actually your tape deck.

In this case, you would need to hook up your tape deck to the input jacks marked VCR 2 on the back of the amplifier.

This method should help you customize the remote control for your system and let you control all of your components with the remote control for the VSA-AX10.

8 Repeat the process from step 2 for all of your components.

9 Press the BACK button repeatedly to leave the REMOTE SETUP mode.

Remote Control of Other Components

Programming Signals from Other Remote Controls (LEARNING Mode)

If preset codes are not available for your component(s), or the available preset codes do not operate correctly, you can use this procedure to program in signals from the remote control(s) of your other component(s). These steps can also be used to add further operations to the remote control screens that were successfully set with the stored settings (see p.60–61).



You can press the BACK button at any time to go back a screen.

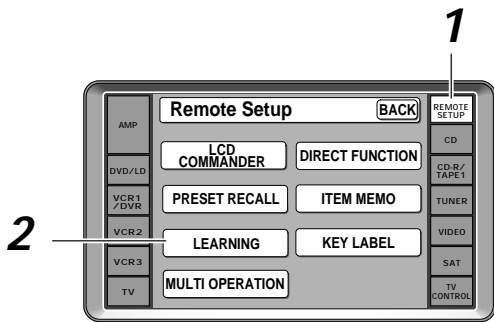

1 Press the REMOTE SETUP.

2 Press the LEARNING button.

If you want to cancel the REMOTE SETUP mode SELECT FUNCTION arrows blink on the remote control display.

3 Press the function button for the component you want to control.

For example purposes we will use the DVD/LD function.

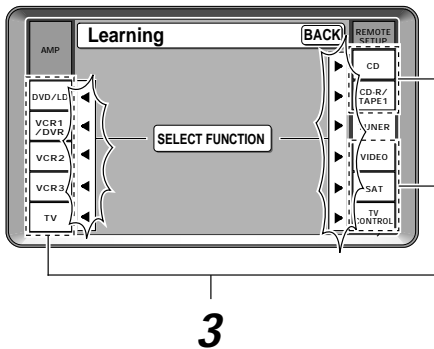

4 Choose the command you want to teach the remote control and press the corresponding button on the LCD screen.

For example, choose the ► (play) button to program this remote control to play your DVD player.

- The TV POWER, TV INPUT, TV CH +/- and VOL +/- buttons are only available for learning when programming TV CONTROL operations.
- Pressing BACK cancels the process.

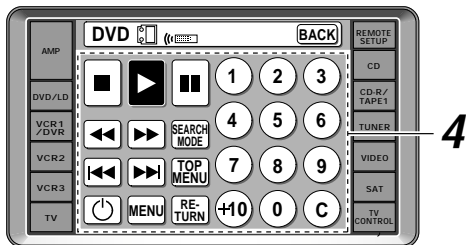

5 After you press the command LEARNING will blink. Point the two remote controls toward each other. Press the button on the other remote control corresponding to the operation you want to program while LEARNING continues to blink.

After the process is complete and the command has been learned, OK will appear at the top of the remote control LCD display.

Repeat steps 4 and 5 to teach the remote control of the VSA-AX10 all the commands from the other remote control.



- You can also program the ▲/▼/◀/▶ and ENTER cursor buttons with the LEARNING mode.
- The TUNER button cannot be assigned.

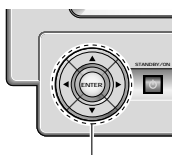

▲/▼/◀/▶ and ENTER cursor buttons

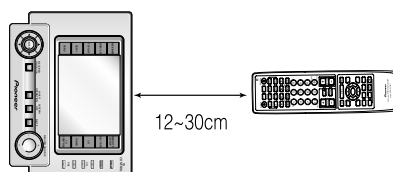

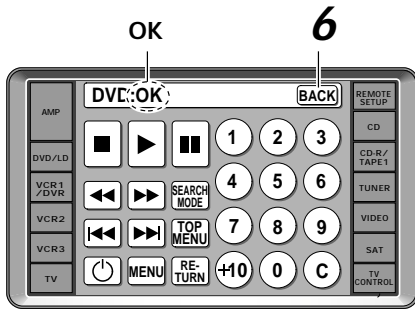

6 Press the **BACK** button to return to the **SELECT FUNCTION** screen.

Start again from step 3 to program all your components in this manner.

7 When you're done press the **BACK** button repeatedly to return to the **REMOTE SETUP**.

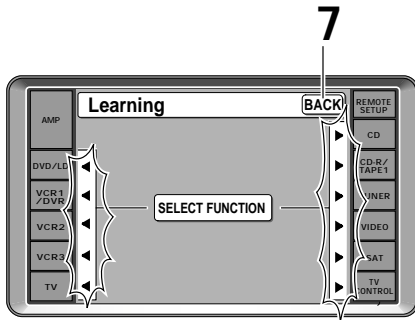

- If there isn't enough capacity in the remote control the signal cannot be learned
- If there is a problem NG (no good) will appear in step 5. Sometimes moving remotes closer together or farther apart will remedy the situation.

Locking the Settings

This feature allows you to lock the REMOTE SETUP settings so that they cannot be changed without unlocking them first. When they are locked you cannot enter the setting screen in these modes. The locking and unlocking procedures are done by the same process.

Unlocked symbol

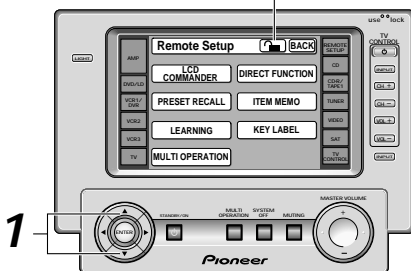

2 Locked symbol

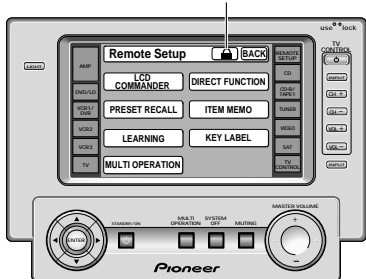

1 In the **REMOTE SETUP** screens hold down the **▲▼** buttons at the same time. While you're holding down the buttons a lock symbol will appear, in an unlocked fashion, in the top bar of the remote control.

2 Press the lock symbol while holding down the above two keys. The setting will either lock or unlock depending on the state it was previously in.

From that time, if the screen is locked the lock symbol will appear when that screen is accessed.



- The only exception to locking the settings is the LCD COMMANDER settings in the REMOTE SETUP screen. They can still be accessed even when the REMOTE SETUP screen is locked.

Using the Remote Control with Other Components

DVD and TV operations



- The following operations are available from the amplifier's remote control after you program your DVD or TV into it, but some operations may need to be learned separately by the amplifier (see "Setting Up the Remote Control to Control Other Components," p.60-63).
- Press the **DVD** or **TV CONTROL** button to set the remote to the DVD or Digital TV mode.
- For more information on individual commands consult the manual that came with the component.
- The "Standard" screen will appear when presetting the TV/SAT (or any other) function button. Other standard controls for the TV can be accessed down the right side of the remote control (see "Remote Control," p.29, #8). When presetting the TV CONTROL function button the "Digital" TV screen will appear.

DVD

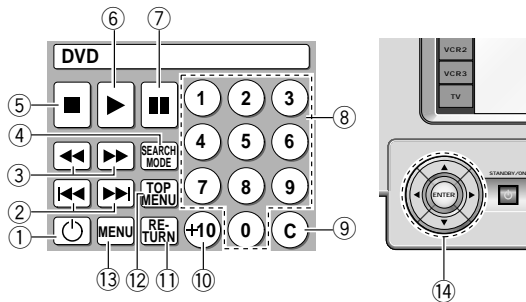

DVD

- ① **Power**
Press to switch the DVD player on or off (not possible with all models, especially those without a standby mode).
- ② **Fast Reverse/Play**
 - ◀◀◀ : Press to return to the beginning of the current chapter (track). Press repeatedly to return to the beginning of previous chapters (tracks).
 - ▶▶▶ : Press to advance to the beginning of the next chapter (track). Press repeatedly to advance to the beginning of following chapters (tracks).
- ③ **Fast Reverse/Play**
 - ◀◀◀ : Hold down for fast reverse playback.
 - ▶▶▶ : Hold down for fast forward playback.
- ④ **SEARCH MODE**
Press to perform a title, chapter/track or elapsed time search.
- ⑤ **Stop**
Press to stop playback.
- ⑥ **Play**
Press to start playback.
- ⑦ **Pause**
Press to pause playback.
- ⑧ **Number buttons**
Use to select chapters (tracks).
- ⑨ **C**
Use to clear chapters (tracks) or programmed selections.
- ⑩ **+10**
Use when selecting chapter (track) numbers higher than 10. Press +10 for every set of ten and then the ending digit. For example: +10,+10, 1=21.
- ⑪ **RETURN**
Use to go back a screen or menu.
- ⑫ **TOP MENU**
Press to call up the menu programed on the DVD.

Digital TV screen

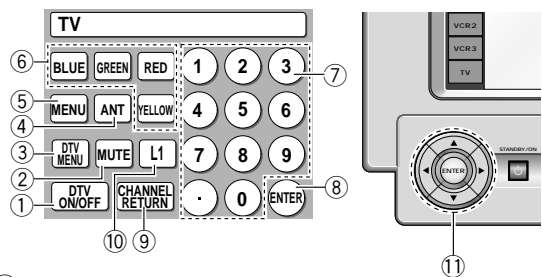

Digital TV screen

- ⑬ **MENU**
Use to display or close the title menu screen.
- ⑭ **Navigation/ENTER**
 - ▲/▼/◀/▶ : Use to navigate through options on menu screens and to change settings.
 - ENTER** : Use to implement settings selected with the cursor buttons or to set items highlighted in a menu.
- ① **DTV ON/OFF**
Press to switch the DTV mode on or off.
- ② **MUTE**
Press to mute or restore the volume.
- ③ **DTV MENU**
Press to select the DTV menu.
- ④ **ANT**
Use to select the type of antenna you have hooked up to your TV.
- ⑤ **MENU**
Use to select different menus on a DTV screen.
- ⑥ **BLUE/GREEN/RED/YELLOW**
Use to make selections from the DTV menu.
- ⑦ **Number buttons**
Use to select a specific TV channel.
- ⑧ **ENTER**
Use to select the channel specified with the number buttons (not all models require this step).
- ⑨ **CHANNEL RETURN**
Use to return to the previous channel.
- ⑩ **L1**
Freely assignable key where you can enter any command you like.
- ⑪ **Navigation/ENTER**
 - ▲/▼/◀/▶ : Use to select or adjust items on the menu screen.
 - ENTER** : Use to activate the selected function.

Setting up the DIRECT FUNCTION

The direct function will not be necessary for most users. It is designed in case you have an external video source connected to your TV (a video source that is not going through the VSA-AX10). For this explanation we'll call this the "external video deck." You'd like to control external video deck with this unit's remote control so you've assigned it a function button (for example purposes, the VCR 2 button). Yet, if you put the amplifier in VCR 2 mode you'll get no picture on your TV because the external video deck signal is not going through the VSA-AX10. To get around this problem you set the DIRECT FUNCTION for VCR 2 to OFF. Now when you press VCR 2 function button you can control the external video deck with the remote but the amplifier does not go into VCR 2 mode.

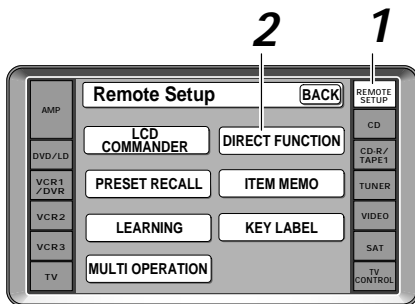

1 Press the REMOTE SETUP.

2 Press the DIRECT FUNCTION button.

3 Choose the DIRECT FUNCTION setting of each MULTI CONTROL button by pressing on the ON/OFF button.

A triangular arrow points from the ON/OFF button towards a small nub next to the function names (DVD/LD, CD, etc.) that can be turned ON/OFF. This nub will disappear if that DIRECT FUNCTION is turned OFF.

Subsequently the nub will not appear on any remote control screen if the DIRECT FUNCTION is OFF.

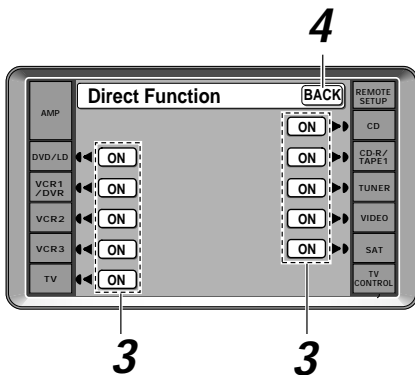

4 To leave the Direct Function mode press the BACK button.



The default setting for all DIRECT FUNCTIONS is ON.

Using Other Functions

Recording from Audio/Video Components

The following explanations show you how to make a recording from one component to another connected to this amplifier. Note that an analog recorder (such as a VCR) cannot record from a source that is connected using only a digital connection. Likewise, a digital recorder (such as a CD-R) cannot record digitally from a component that is connected using only analog connections. In both of these cases, make sure that the digital component also has analog connections to the amplifier, and that the SIGNAL SELECT is set to ANALOG.

When recording from one digital component to another, bear in mind that the digital signal output from this amplifier mirrors the input from the source. So if the input is, say, Dolby Digital, the output will also be Dolby Digital. Before recording, make sure that the recorder is compatible with the source digital audio format.

See p.22 for more on analog audio connections and p.24-25 for digital audio connections.



- The amplifier's volume, channel level, balance, TONE, Digital NR, MIDNIGHT, LOUDNESS, ACOUSTIC CAL EQ and surround effects have no effect on the recorded signal.
- In some cases, digital recordings have copy guard protections and making a digital copy is not possible. In this case you can only copy them in an analog manner.
- When the source is connected to the MULTI CH IN jacks, only the front left/right channels can be recorded.
- Some video recordings are copy-protected: these sources cannot be recorded.
- When recording video, the source must be connected to the amplifier using the same type of video cord (composite, or S video) as you used to connect the recorder to the amplifier.

Functions that can be recorded

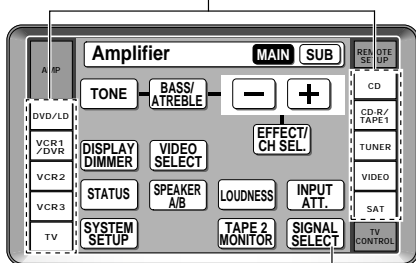

1 (if necessary)

1 Select the source component. Set SIGNAL SELECT according to the source component's signal (ANALOG or DIGITAL).

2 Start recording (tape deck, CD recorder, VCR, etc.)

3 Playback the source to be recorded.

Record monitor (TAPE 2 MONITOR)

If you connect a cassette deck with a record monitor function to the TAPE 2 MONITOR jacks, you can listen to the sound of an analog recording as it is being recorded. Press TAPE 2 MONITOR to switch between the sound of the recording (TAPE 2 indicator on) and the sound of the source component (TAPE 2 indicator off).



- To record the TAPE 2 MONITOR signal to a recorder connected to the CD-R/TAPE 1 inputs, select any input except CD-R/TAPE 1 and switch the TAPE 2 MONITOR on.

Speaker System B Setup

Stereo playback in another room

Connect a pair of speakers to the B speaker terminals to listen to stereo playback in another room (kitchen, bedroom, etc.). Select NORMAL SURROUND and choose the speaker system setup that you want. See the next page for more details on these speaker system settings. Please use speakers with a nominal impedance rated 6Ω - 16Ω .

Bi-amping the front speakers

For bi-amp playback you can connect both the A and B speaker terminals to your front speakers. To do this your speakers must be bi-wireable (that is they must have separate terminals for the high and low frequencies).

Bi-amping delivers more power to the front speakers, but disables the surround back speakers, so you will be limited to 5.1 channel playback.

Caution!

Do not allow any speaker wire from any terminal to touch a wire from a different terminal.

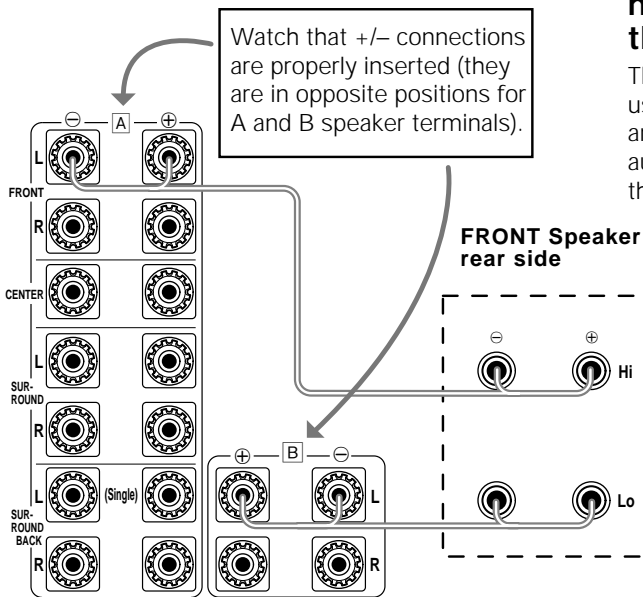

1 Connect your speakers as shown.

Since both Front A and B speaker terminals output the same audio, it doesn't matter which set (A or B) is powering which part (HI or LOW) of the speaker.

2 Select BI-AMP(5.1). If you need more information on how to do this see page 39, step 3.

The surround back channel amplifier is now used to power the B set of speaker terminals and the A+B (SP►AB) speaker setting is automatically selected. The speaker setting in this case can only be A+B or OFF.

Caution!

Most speakers with both Hi and Low terminals have two metal plates that connect the Hi to the Low terminals. These must be removed when you are bi-amping the speakers or you could severely damage the amplifier. See your speaker manual for more information.

Bi-wiring your speakers

To bi-wire a speaker, connect two speaker cords to each speaker terminal on the amplifier. To do this your speakers must be bi-wireable (that is they must have separate terminals for the high and low frequencies). The way to do this is to connect both wires to one speaker terminal as in the illustration. Make sure you use a parallel (not series) connection when doing so. Don't connect different speakers from the same terminal in this way. For this type of connection select NORMAL SURROUND when setting up.

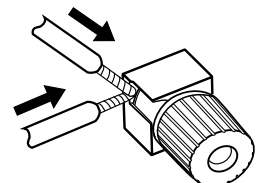

Switching A/B Speaker System

This unit has three types of speaker systems A, B, A&B. This switch allows you to select the speaker system you will use.

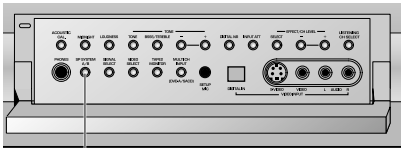
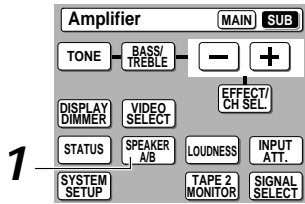

1 Use the SPEAKER A/B button on the remote control's SUB screen (or SP SYSTEM A/B on the front panel) to cycle through the different speaker systems.

The button cycles through the speaker systems as follows: A⇒B⇒A&B⇒off.

In what way the sound will be output depends on the selections you made in "SPEAKER SYSTEMS" (p.38) and you choices here. See the explanations for a guide to how the sound will be output when you have chosen NORMAL SURROUND (see p.38-39).

A(SP▶A):

Sound is output from speaker system A and the same signal is output from the pre out terminals. (Subwoofer output depends on the settings in SPEAKER SYSTEMS and the source type.)

B(SP▶B):

Sound is output from the two speakers in speaker system B. Multichannel sources will be downmixed to these two speakers and the same signal is output from the FRONT pre outs.

A&B(SP▶AB):

Sound is output from speaker system A's FRONT speakers and the B speakers. The main channels will be downmixed to the FRONT speakers. (Subwoofer output depends on the settings in SPEAKER SYSTEMS and the source type.) If you have set the FRONT speakers to "SMALL" the low frequencies of all the channels are output from the subwoofer. The same sound is output from the B speakers and the FRONT pre out terminals.

OFF(SP▶):

No sound is output from the speakers. Depending on the input signal and settings in "SPEAKER SYSTEMS" sound may be output from the subwoofer. The same sound is output from the pre out terminals as when selecting speaker system A (above).



- Depending on the settings in "SPEAKER SYSTEMS" and the MULTI CH IN SELECT, output from the surround back pre out terminals may change.
- When using headphones the speakers are switched off.
- Please use speakers with a nominal impedance rated 6Ω-16Ω.

Connecting Additional Amplifiers

This amplifier has more than sufficient power for any home use, but it is possible to add additional amplifiers to every channel of your system. If you use additional amps for the front channels take out the U-shaped connectors (see p.32). Make the connections shown below to add amplifiers to power your speakers. Before making or changing the connections, switch off the power and disconnect the power cord from the AC outlet.

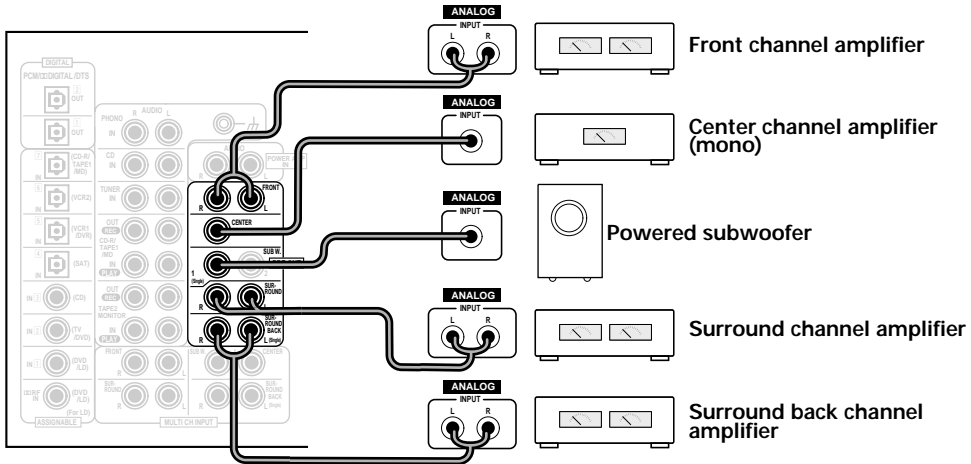

You can use the additional amplifier on the surround back channels for a single speaker as well. In this case plug the amplifier into the L (SINGLE) terminal only.

Pre Out Power Setup

It is possible to use a separate stereo pre-amp in conjunction with this amplifier. You might want to do this if you need to connect more sources than this amplifier can accommodate, or if you prefer to use a specific pre-amp for sound quality reasons.

You can connect sources to either this amplifier or to the external pre-amp (giving you a greater number of input possibilities). For stereo sources connected directly to the external pre-amp, this amplifier acts as a standard power amplifier. For digital sources connected to this amplifier, the amplifier acts as a digital decoder/digital-to-analog converter and as a power amplifier.

- 1 Remove the U-shaped connectors that connect the PRE OUT jacks to the POWER IN jacks.
- 2 Use a stereo RCA audio cable to connect the PRE OUT jacks of this amplifier to a stereo input on the pre-amp.
Use any input except phono.
- 3 Use a stereo RCA audio cable to connect the stereo pre out jacks of the pre-amp to the FRONT POWER AMP IN jack of this amplifier.

The PIONEER SR System: Operating other PIONEER components

Connecting an optional control cord allows you to operate other PIONEER components simply by pointing the amplifier's remote control at the remote sensor on the front panel of the amplifier. The amplifier then sends the remote control signals to the other devices via the CONTROL OUT terminal.

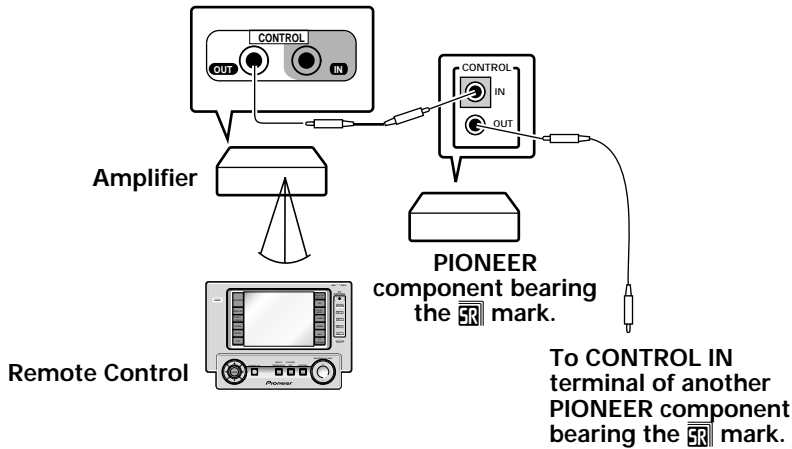

- You can also control PIONEER components (and those made by other manufacturers) by pointing the amplifier's remote control directly at the respective component. This type of operation does not require control cords. All you have to do is recall the appropriate stored settings (see p.60-61).
- If you use a remote control hooked up via the CONTROL IN jack with a control cord, you won't be able to use this unit's remote control.
- If you use this feature make sure an analog (audio and/or video) connection has been made between the amplifier and the component(s).

Multi Operations

Multi operations allow you to tell the amplifier and your other components to do a number of things with the push of only two buttons on the LCD commander. For example, you can program the unit to turn on your TV, turn on your DVD player and start playing the loaded DVD. This allows you to freely decide which operations you want performed as well as the order in which you want them performed (see "Performing Multi Operations" on the next page). The steps below show you how to program a string of up to 5 different operations for each function button. You don't need to program the power of this amplifier (or any Pioneer component) to go on, it will do so automatically when multi operations are recalled.



- Be sure to recall or learn the remote commands for each component before attempting multi operations (see "Setting Up the Remote Control to Control Other Components", p.60-63).
- Press the BACK button any time to go back a screen.
- Press the REMOTE SETUP button any time to cancel the process.

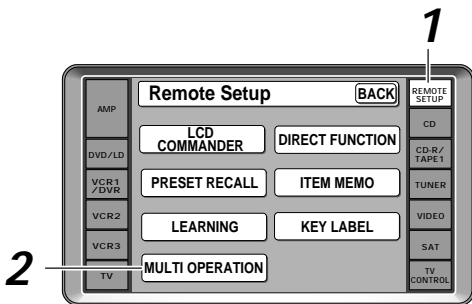

1 Press the REMOTE SETUP button.

2 Press the MULTI OPERATION button.]

The next screen will instruct you to SELECT FUNCTION.

3 Choose the component you want to start the MULTI OPERATION with and press it's function button.

For example purposes we'll use a DVD player as the first component to be set in this multi operation process.

4 Next you should select the command number you want the process to start with. Of course it's logical to start with 1 so press command 1 (the box the 1 with inside it).

This tells the amplifier this will be the first command. **To erase a command** Press the command button you want to erase and press the CLEAR button.

5 Select the component whose command you want to input (for example, a DVD player), and press the function button for it.

The screen for that component will appear in the LCD display.

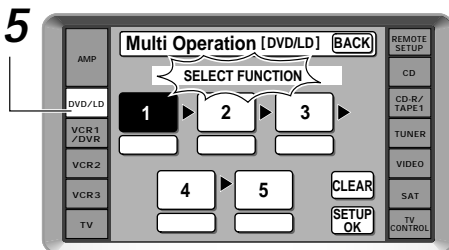
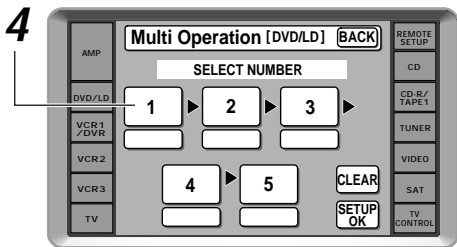
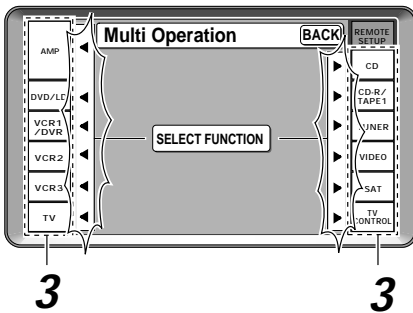



6 Select a command from the screen of the component (for example ► [play]).

The command and component chosen will appear in the window of command 1.

To erase a command

Press the command button you want to erase and press the CLEAR button.

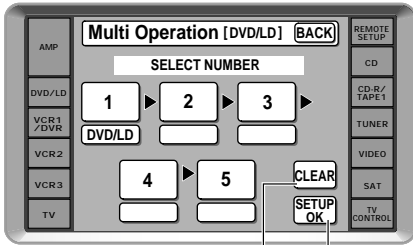

7 Repeat steps 4-6 to program a sequence of up to five commands.

You can assign five MULTI OPERATIONS commands for each function button.

To erase a command

Press the command button you want to erase and press the CLEAR button.

CLEAR 8

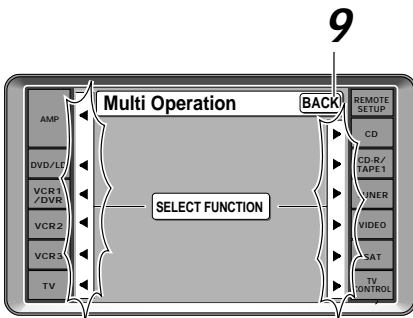

8 When done press SETUP OK to input the information.

After you press SETUP OK the LCD screen on the remote will flash COMPLETE to let you know the process has been stored.

The remote then returns to step three allowing you to input multi operations for another function button. Input multi operations for as many function buttons as you like.

9 Press the BACK button repeatedly to leave the REMOTE SETUP mode.

Performing multi operations

Do the following to use the MULTI OPERATIONS.

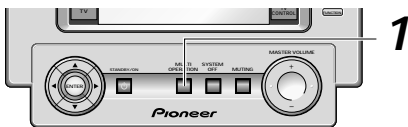

1 Press the MULTI OPERATION button.

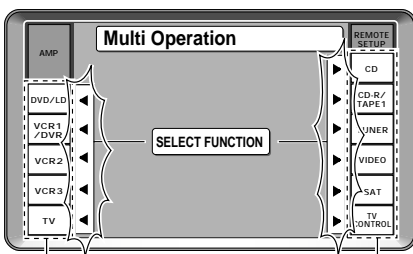

2 Press the function button that has been set up with multi operations.

The power of the amplifier goes on and the programmed multi operations are performed automatically.

2

2

System off

The SYSTEM OFF feature allows you to tell the amplifier and your other components to stop and turn off with the push of only one button on the LCD commander (**this feature will only work with components that have a standby mode**). For example, you can program the unit to stop your DVD, turn off your TV, turn off your DVD player and turn off the amplifier itself. You don't need to program in other the power for PIONEER components, they will go off automatically in this mode. The amplifier itself will go off automatically as well.

The steps below show you how to program a string of up to 5 different SYSTEM OFF operations based on eight possible components.



- Be sure to recall or learn the remote commands for each component before attempting multi operations (see "Setting Up the Remote Control to Control Other Components", p.60-63).
- Press the BACK button any time to go back a screen.
- Press the REMOTE SETUP button any time to cancel the process.

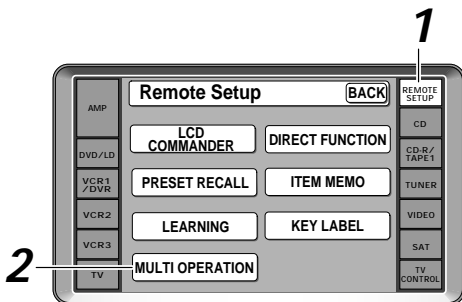

1 Press the REMOTE SETUP button.

2 Press the MULTI OPERATION button.

The next screen will instruct you to SELECT FUNCTION.

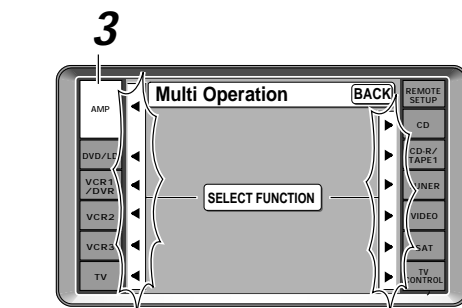

3 Press the AMP button.

The SYSTEM OFF screen appears.

4 Select the command number you want the process to start with. Of course it's logical to start with 1 so press command 1 button (the box the 1 with inside it).

This tells the amplifier this will be the first command. The number will become shaded.

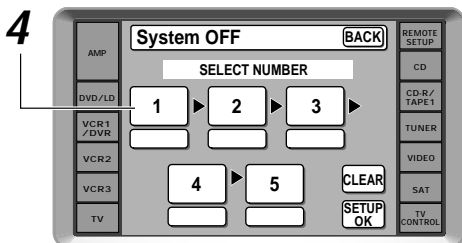

5 Select the FUNCTION button of the component which you want to stop or turn off (for example, your DVD player) and press the function button for it.

The screen for that component will appear in the LCD display.

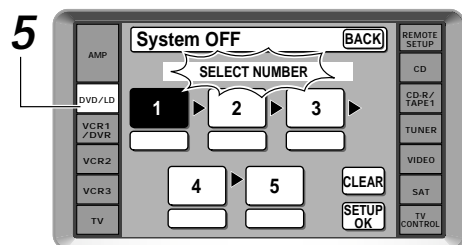

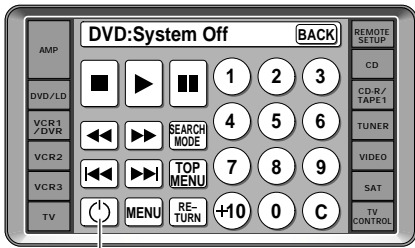

6

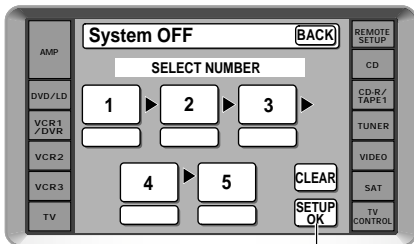

8

9

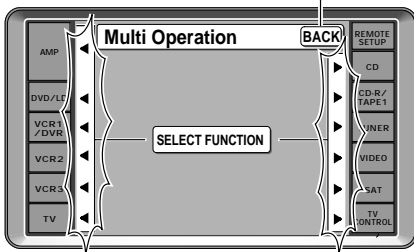

- 6 Select the button for the command you want to input (for example, ■ [stop]).

The command and component chosen will appear in the window of command 1.

To erase a command

Press the command button you want to erase and press the CLEAR button.

- 7 Repeat steps 4-6 to program a sequence of up to five (stop or power off) commands you want to input.

To erase a command

Press the command button you want to erase and press the CLEAR button.

- 8 When done press SETUP OK to input the information.

- 9 Press the BACK button repeatedly to leave the REMOTE SETUP mode.

Using System off

Do the following to use the SYSTEM OFF function.



1

- 1 Press the **SYSTEM OFF** button.

The remote control must be on to be able to use this command but it can be in any mode.

All the components programmed into the SYSTEM OFF mode will stop and/or go off. The amplifier (and other Pioneer components) will go off as well.

Editing Remote Control Screen Names (ITEM MEMO)

Use the ITEM MEMO capability to add more information to the remote control display screens for different functions, like your DVD or CD player. For example, you could add the name of the company that makes your component, then the top line of the screen for the respective component would read something like "DVD PIONEER".

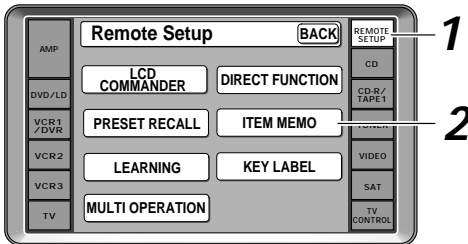

1 Press the REMOTE SETUP.

The REMOTE SETUP menu appears on the remote control.

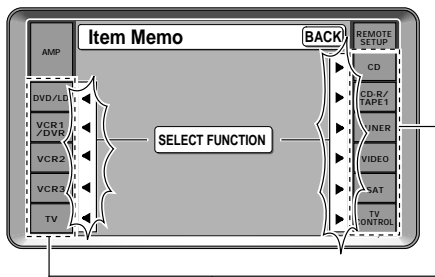

2 Press the ITEM MEMO button.

SELECT FUNCTION menu appears on the remote control.

3 Press the FUNCTION button of the function/component you want to add additional information to, for example, DVD.

4 Use the LETTER and the number buttons to spell out the name you want to add.

The keyboard works the same as a conventional keyboard. You can include spaces and hyphens in the name.

You can input up to ten letter/numbers.

DELETE: key clears the letters/numbers from the right backwards.

ALL CLEAR: key erases everything that has been typed.

SPACE: Puts a space the name.

PAGE +/-: For lower case letters, symbols or numbers use this button.

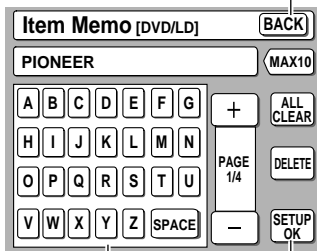

5 Press the SETUP OK button when the name appears in the bar as you want it on the function screen.

The COMPLETE screen will show for half a second to let you know the name was successfully input.

The screen will then return to step three to allow you to input names for other functions/components.

6 Use the BACK button to return to the REMOTE SETUP menu.

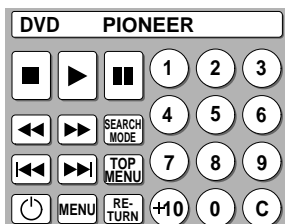

- You input up to ten letters or numbers. If you try to input more than ten the remote control will beep twice to let you know this can't be done.
- You can input this kind of information for up to eleven functions/components.
- If you start this process but want to stop it without inputting the information entered press the BACK button. This will return you to the previous screen without entering any of the information. You can use this button to return to screen where you started.

Editing Buttons Names (KEY LABEL)

Use the KEY LABEL capability to rename the buttons (keys) on the remote control screens for different functions (DVD, etc.). You would want to do this if you taught a specific button a new operation on the previous two pages. For example, you could teach the SEARCH MODE button to be an audio key and the rename it "AUD".

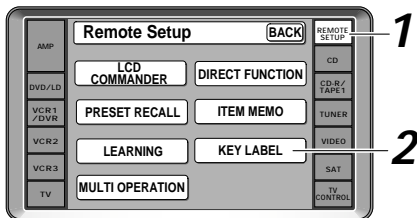

1 Press the REMOTE SETUP.

The REMOTE SETUP menu appears on the remote control.

2 Press the KEY LABEL button.

SELECT FUNCTION appears on the remote control.

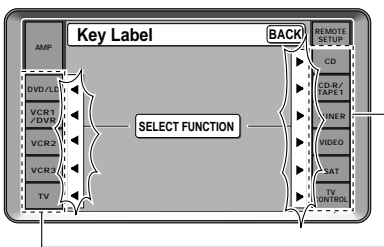

3 Press the function button (for example, "DVD/LD") that contains the command or title that you want to rename.

4 Press the buttons whose name you want to change.

5 To change the name to new text press the TEXT button.

Use the letter and number buttons to spell out the name you want to add.

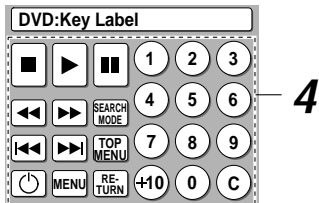

You can include spaces and hyphens in the name. The maximum number of letters and symbols is indicated on the screen.

+/-: Use these buttons to alternate between the different pages of letters and symbols. What page you are on is indicated by "PAGE 1/3" (for example).

DELETE: clears the letters/numbers from the right backwards.

ALL CLEAR: erases everything that has been typed.

SPACE: Puts a space in the name.

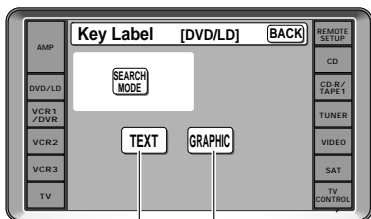

To change the name to a new graphic press the GRAPHIC button.

Choose the new image you want to put on the button. For example you can put the ⏻ mark on to a button by choosing it.

+/-: Use these buttons to alternate between the two pages of different graphics. What page you are on is indicated by "PAGE 1/2" (for example).

CLEAR: This will return you to the original image on the button.

Using Other Functions

~For TEXT~

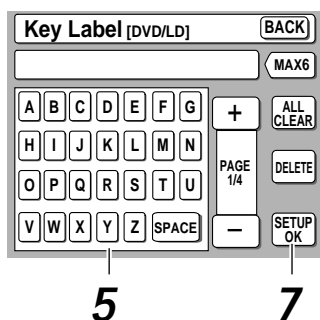



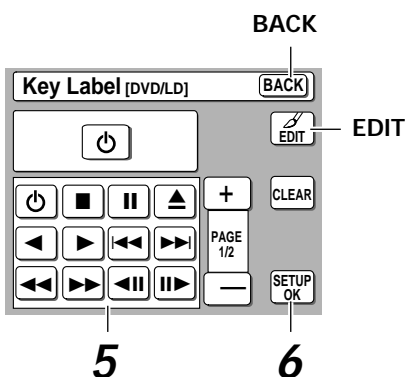

~For GRAPHICS~

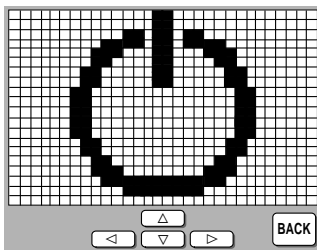

EDIT mode



If you want to re-draw the image, choose a new image (for example ) and then press the EDIT button.

Use the     buttons to move the image around. You can also add or subtract from the drawing by touching the screen with your pen.

When you're done press the BACK button.

The new image appears in the selection box and you can continue to the next step if this is the image you want.

If you don't want to put this image on the button press CLEAR. You can start over from step 5, if you want.

6 Press the SETUP OK button when the name appears in the bar as you want it on the function screen.

The COMPLETE screen will show for half a second to let you know the name was successfully input.

The screen will then return to step four to allow you to input names for other functions/components.



- If you try to input more letters/numbers than possible the remote control will beep twice to let you know this can't be done.
- You can include spaces and hyphens if you want.
- If you start this process but want to stop it without inputting the information entered use the BACK button.

Resetting the Main Unit

The following operations allow you to erase the settings stored in the main unit.

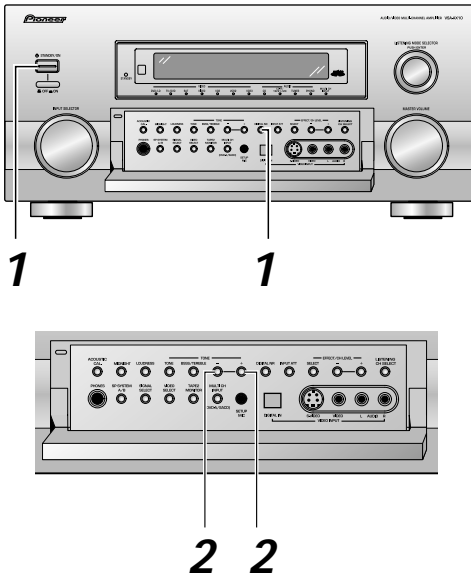

- 1 While holding down the **DIGITAL NR** button press the **STANDBY/ON** button for about three seconds.
- 2 When you see **RESET?** appear in the display, press the **TONE -** button. **OK?** appears in the display, press **TONE +**.

All the settings, including the speaker, surround sound settings and tuner settings will be reset the unit to the default settings.

Resetting the Remote Control

The following operations allow you to erase the settings stored in the remote control.

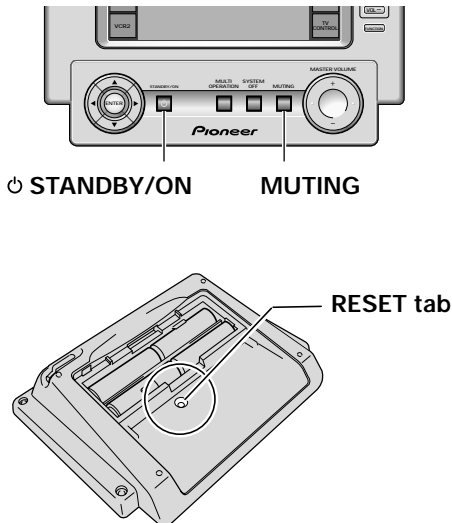

- 1 Hold down both the **STANDBY/ON** button and **MUTING** button and then push the **RESET** tab under the battery cover on the back of the remote control.
- 2 Release the reset tab and then release the two buttons.

If you don't release them in this order the settings won't be cleared.

Advanced Setup

Assigning the Digital Input

If you did not hook up your digital equipment in accordance with the default settings for the digital inputs (see p.25) you need to complete the procedure below. You have to do this in order to tell the amplifier what digital equipment is hooked up to which terminal so the buttons on the remote correspond to what you have hooked up.

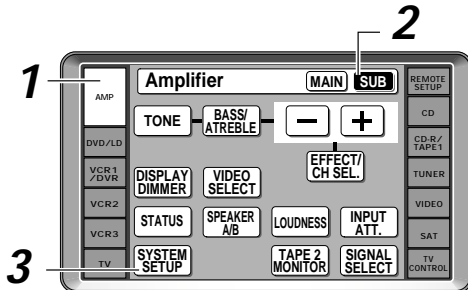

1 Turn on the amplifier and your TV, press the AMP on the remote control.

2 Press the SUB button on the remote control.

3 Press the SYSTEM SETUP button.

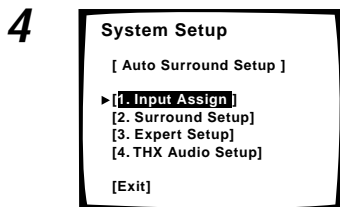

4 Looking at the on-screen display on your TV, use the ▲▼ buttons to select INPUT ASSIGN. Press the ENTER button.

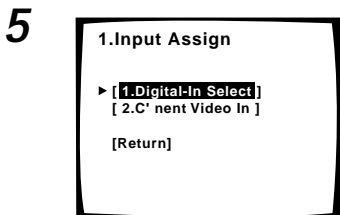

5 DIGITAL-IN SELECT should be selected, if not use the ▲▼ buttons to select it. Press the ENTER button.

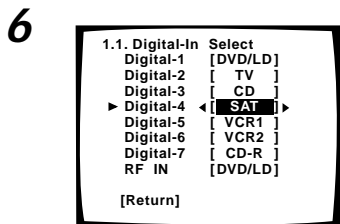

6 Use the ▲▼ buttons to move through the different digital input settings and use the ◀▶ buttons to select the component that you hooked up to that digital in.

7 If you're not sure which component is connected to which digital in, look on the back of the amplifier and check the cables you connected.

8 When you're finished use the ▲▼ buttons to select RETURN and press ENTER.

You will leave the "Assigning the Digital Inputs" mode.

9 Use the ▲▼ buttons to select RETURN and press ENTER, again. Then, use the ▲▼ buttons to select EXIT and press ENTER.



- The possible digital inputs that can be assigned are: DVD/LD, TV, SAT, VCR 1/DVR, VCR 2, VCR 3, CD, CD-R/TAPE 1 (except for a  RF input which doesn't include CD, CD-R/TAPE 1).
- If you assign a digital input to a certain function (for example DVD/LD) then any digital inputs previously assigned to that function will automatically be set to OFF. This is because one function cannot be assigned to two different places (except for the RF IN).

Assigning the Component Video Inputs

If you used component video cords (and only if you did so) to connect any equipment you must tell the amplifier which device is hooked up with this special kind of cable. If you did not use component video cord (which is a specialized cord that separates the video signal into two color spectrums and a light spectrum for transmission) then you don't need to worry about the procedure below. The default settings for the component video inputs are as follows: 1= off; 2= off; 3= off.

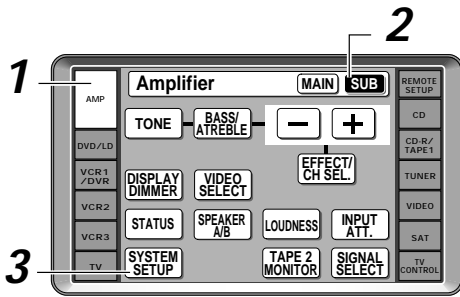

1 Turn on the amplifier and your TV, press the AMP on the remote control.

2 Press the SUB button on the remote control.

3 Press the SYSTEM SETUP button.

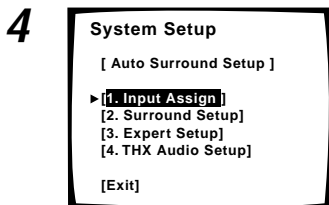

4 Looking at the on-screen display on your TV, use the ▲▼ buttons to select INPUT ASSIGN. Press the ENTER button.

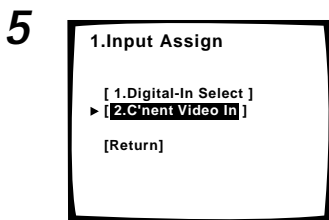

5 Use the ▲▼ buttons to select C'NENT VIDEO IN. Press the ENTER button.

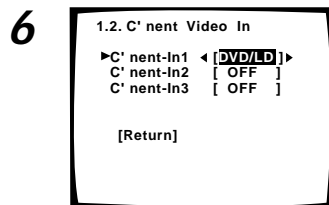

6 Use the ▲▼ buttons to move through the different component video input settings and use the ◀▶ buttons to select the component that you hooked up to that component video in.

If you're not sure which component is connected to which component video in, look on the back of the amplifier and check the cables you connected.

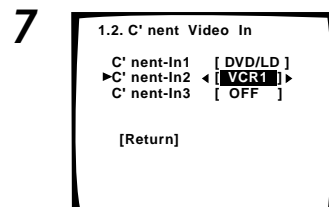

7 When you're finished use the ▲▼ buttons to select RETURN and press ENTER.

You will leave the "Assigning the Component Video Inputs" mode.

8 Use the ▲▼ buttons to select RETURN and press ENTER, again. Then, use the ▲▼ buttons to select EXIT and press ENTER.



If you connect the TV monitor with component video cord, and the DVD player with composite or S video cord then you should set that terminal to off.

Expert Setup

These settings are more advanced. Some could add depth or listenability to your sound (like the Dynamic Range Control) and others are for your convenience (like the Function Rename). You can decide if you want to make these settings or not. They are not crucial to good surround sound. You only need to make these settings once (unless you change the placement of your current speaker system, add new speakers or components to your system, etc.). These setup operations use your TV to display the settings and choices so be sure your TV and amplifier are properly hooked up.

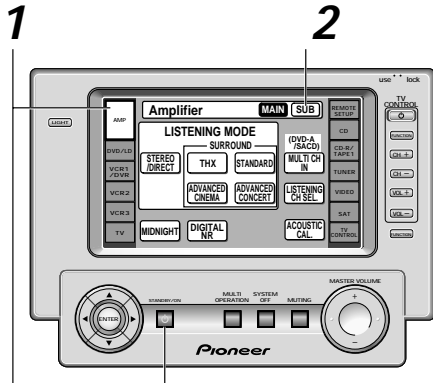

1 Turn on the amplifier and your TV, press the AMP on the remote control.

Make sure your TV is set to the amplifier.

2 Press the SUB button on the amplifier screen.

3 Press the SYSTEM SETUP button.

The menu possibilities appear on your TV.

4 Select EXPERT SETUP with the ▲▼ buttons. Press the ENTER button.

5 Follow the order below to make advance settings. Use the ▲▼ buttons to navigate through the menus. When you have the setting you want in particular menu, press ENTER.

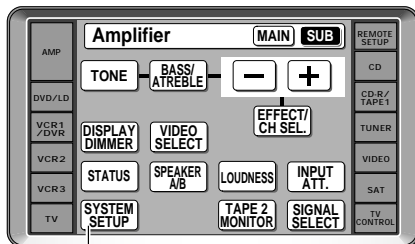

3

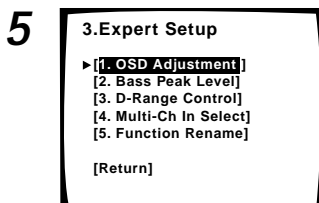
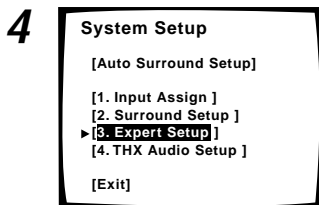

In each mode, the current settings are displayed automatically.

OSD (SCREEN DISPLAY) ADJUSTMENT (p.83)

This feature allows you to adjust positioning of the display to fit your TV better.

BASS PEAK LEVEL (p.84)

Dolby Digital, MPEG and DTS audio sources include ultra-low bass tones. Set the bass peak level as needed to prevent the ultra-low bass tones from distorting the sound from the speakers.

DYNAMIC RANGE CONTROL (p.85)

This feature makes possible excellent surround sound effects when listening to Dolby Digital sources at low volumes.

MULTI CH IN SELECT (p.86)

This feature is for choosing an output method for people who have connected their DVD player up with multi channel analog inputs.

FUNCTION RENAME (p.87)

This feature allows you to change the names that appear on your amplifier's display to suit your home system in a customized way.

OSD (On-screen Display) ADJUSTMENT

Use this feature to adjust your TV display if it seems difficult to see all the instructions on the screen. This adjustment basically lets you move the screen displays up or down and left or right to get a better match between the displays for this amplifier and your TV.

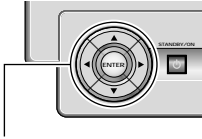

▲/▼/◀/▶/ENTER buttons

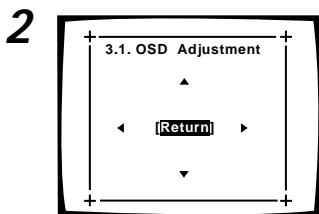
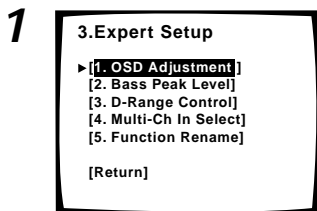

Follow steps 1-4 on page 82, if necessary, to get to the starting point mentioned here.

1 OSD ADJUSTMENT should be selected if it isn't use the ▲▼ buttons to select it. Press ENTER.

2 Use the ◀▶ ▲▼ buttons to move the display field around until you get one that you feel best suits your TV.

3 Press ENTER button.

Your new screen display will be set. Next, move on to BASS PEAK LEVEL, if necessary.

If you want to change a setting before proceeding Start over from step one.

4 If you want to continue EXPERT SETUP use the ▲▼ buttons to select the next setup and press ENTER.

Go on to the next page.

5 If you want to finish EXPERT SETUP use the ▲▼ buttons to select RETURN and press ENTER. Then use the ▲▼ buttons to select EXIT and press ENTER.

BASS PEAK LEVEL

The LFE (Low Frequency Effect) channel in Dolby Digital, MPEG or DTS program sources can produce heavily concentrated ultra-low bass tones that may exceed the capabilities of your speaker system. The following steps show you how to set the peak level for the ultra-low bass (or low frequency effect (LFE) channel). If continuing from the preceding page the BASS PEAK LEVEL should be selected.

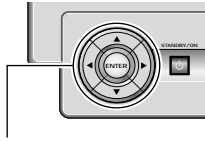

▲/▼/◀/▶/ENTER buttons

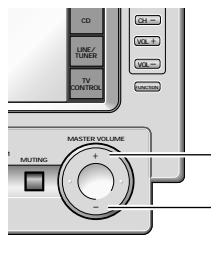
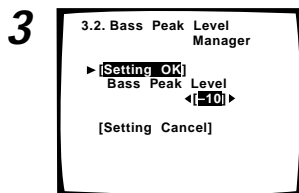
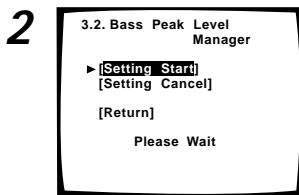
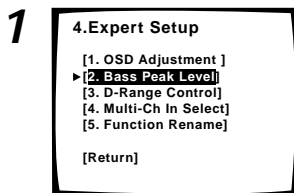

MASTER VOLUME +/-



- If you set the THX Ultra2 feature on p.88 the BASS PEAK LEVEL feature will be cancelled.

Follow steps 1-4 on page 82, if necessary, to get to the starting point mentioned here.

1 BASS PEAK LEVEL should be selected if it isn't use the ▲▼ buttons to select it. Press ENTER.

2 Use the ▲▼ buttons to select SETTING START or SETTING CANCEL.

SETTING START: The MASTER VOLUME is set to MIN (---dB), a test tone plays back and you make the setting (in step 3).

SETTING CANCEL: This setting won't limit the peak level of the LFE channel.

For **SETTING START**, select it and press **ENTER**. Then go on to step 3.

For **SETTING CANCEL**, select it and press **ENTER**. The bass peak level setting is finished. Go on to the next setup.

3 Use the ◀▶ buttons to adjust the test tones and specify the bass peak level.

① Raise the level gradually.

② Set the bass peak level at the point just before the tone starts to distort.

Be careful! Test tones play back at loud volumes . Make sure there are no infants or small children in the room at distortion level.

If the YES or PLUS setting on the subwoofer is selected the test tone will only play back from the subwoofer. If not, the test tone will play back from all speakers set to LARGE except for the subwoofer.

4 Press ENTER.

The display on the amplifier will show RESUME and the MASTER VOLUME will return to its original position.

5 If you want to continue EXPERT SETUP use the ▲▼ buttons to select the next setup and press ENTER.

Go on to the next page.

6 If you want to finish EXPERT SETUP use the ▲▼ buttons to select RETURN and press ENTER. Then use the ▲▼ buttons to select EXIT and press ENTER.

DYNAMIC RANGE CONTROL

This feature makes it possible to enjoy full surround sound effects on Dolby Digital sources even at low volumes. It does this by compressing the dynamic range. Dynamic range is the difference between the loudest and the softest sounds in any given signal. Compressing the range plays sounds so the quieter ones are audible and the louder ones don't get distorted or become overpowering. This feature only applies to Dolby Digital sources but the MIDNIGHT LISTENING mode (explained on p.54) accomplishes the same end for a variety of sources. If continuing from BASS PEAK LEVEL, DYNAMIC RANGE CONTROL should be selected.

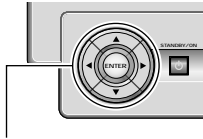

▲/▼/◀/▶/ENTER buttons

1

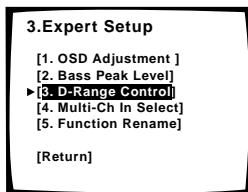

2,3

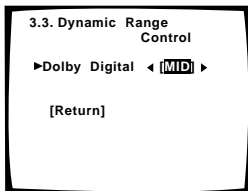

Follow steps 1-4 on page 82, if necessary, to get to the starting point mentioned here.

1 D-RANGE CONTROL should be selected if it isn't use the ▲▼ buttons to select it. Press ENTER.

2 Use the ◀▶ buttons to choose either OFF, MID or MAX.

OFF: No Dynamic Range Control.

MID: A moderate amount of Dynamic Range Control.

MAX: The most Dynamic Range Control available is applied.

3 Use the ▲▼ buttons to select RETURN. Press ENTER button.

Dynamic Range Control is set. Go on to the next setting.

If you want to change a setting before proceeding Start over from step one.

You may need to experiment with different Dolby Digital sources before you can use the DYNAMIC RANGE CONTROL setting to suit your low volume listening needs.

4 If you want to continue EXPERT SETUP use the ▲▼ buttons to select the next setup and press ENTER.

5 If you want to finish EXPERT SETUP use the ▲▼ buttons to select RETURN and press ENTER. Then use the ▲▼ buttons to select EXIT and press ENTER.



If you are listening at loud volumes we recommend turning the DYNAMIC RANGE CONTROL OFF.

MULTI CH IN SELECT

Use this feature to adjust the type of output for audio signals which were input from multichannel inputs. You can set the output of the audio signal in regards to the surround speakers and the surround back speakers, which were input from 5.1 channel surround sound soundtrack.

There are three OUTPUT MODE settings:

THROUGH: The sound is output directly how it was input.

S → SB: The audio signal which was input into the surround channels will be output from the surround back speakers only.

S → S & SB: The audio signal which was input into the surround channel is output from the surround speakers and from the surround back speakers. This setting will give the most realistic home theater experience in the MULTI CH IN SELECT setting.

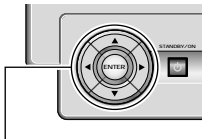

▲/▼/◀/▶/ENTER buttons

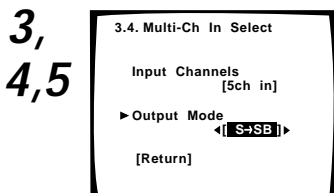
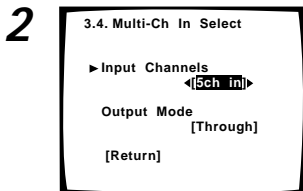
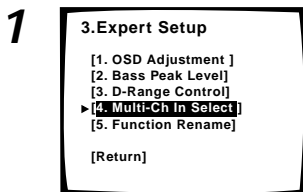

- If you want to setup either S→SB, S→S & SB, you need to connect all 7.1 CH speakers, including the surround back left and right speakers.
- If you use only one surround back speaker hook it up to the left surround back speaker terminal.

Follow steps 1-4 on page 82, if necessary, to get to the starting point mentioned here.

- 1 MULTI-CH IN SELECT should be selected if it isn't use the ▲▼ buttons to select it. Press ENTER.**
- 2 Use the ◀▶ buttons to select the input channel: 7 CH IN, 6 CH IN or 5 CH IN**
You do this to establish the proper downmixing of surround back channels. If you connected two surround back inputs choose 7 CH IN. If you connected one surround back input choose 6 CH IN. And if you connected no surround back inputs choose 5 CH IN.
- 3 Use the ▲▼ buttons to select the OUTPUT MODE you want.**
See the OUTPUT MODE explanations above. For details on speaker placement in this mode see page 95.
- 4 Use the ◀▶ buttons to choose a type of output mode: THROUGH, S → SB, S→S & SB.**
- 5 Use the ▲▼ buttons to select RETURN. Press ENTER button.**
Your MULTI CH IN SELECT output set. Next, move on to FUNCTION RENAME, if necessary.
If you want to change a setting before proceeding Start over from step one.
- 6 If you want to continue EXPERT SETUP use the ▲▼ buttons to select the next setup and press ENTER.**
- 7 If you want to finish EXPERT SETUP use the ▲▼ buttons to select RETURN and press ENTER. Then use the ▲▼ buttons to select EXIT and press ENTER.**

FUNCTION RENAME

Use the FUNCTION RENAME capability to rename the display on the amplifier and your OSD for different functions (DVD, etc.). For example, you could rename VCR1/DVR as "DVR-7000".

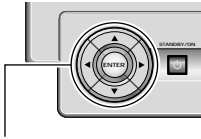

▲/▼/◀/▶/ENTER buttons

1

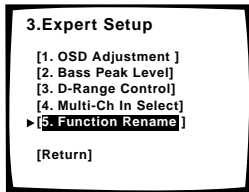

2

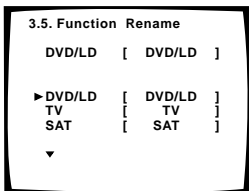

3

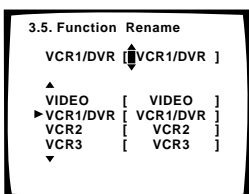

4

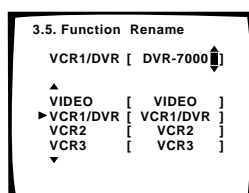

6

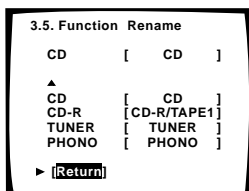

Follow steps 1-4 on page 82, if necessary, to get to the starting point mentioned here.

1 FUNCTION RENAME should be selected if it isn't use the ▲▼ buttons to select it. Press ENTER.

2 Use the ▲▼ buttons to select the name of the function (for example, "VCR1/DVR") you want to change. Press ENTER.

The functions are divided into three different on-screen displays so you may have to move through them to find the function you want to rename.

3 Use the ◀▶ buttons to move the cursor around and use the ▲▼ buttons to enter a letter, number or symbol.

The possible selections are shown below.

```

ABCDEFGHIJKLMNOPQRSTUVWXYZ
abcdefghijklmnopqrstuvwxyz
0123456789
!"#$%&'()*+,-./:;<=>@[ \ ]_{} (space)
  
```

4 Repeat step 3 until you get the name as you want it.

You can input up to ten characters.

5 Press ENTER. The new function name is set.

6 Repeat steps 2-5 to change other function names. Use the ▲▼ buttons to select RETURN and press ENTER.

7 To finish EXPERT SETUP use the ▲▼ buttons to select RETURN and press ENTER. Then use the ▲▼ buttons to select EXIT and press ENTER.

THX Audio Setup

THX Ultra2 Subwoofer Setup

If you have a high-precision speaker that outputs very low frequencies, the sound may have too much boom because of the resonant frequencies in the room where your subwoofer is setup. If you have this problem use the THX Ultra2 Subwoofer Setup to adjust the low end sounds.

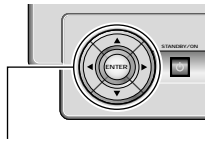
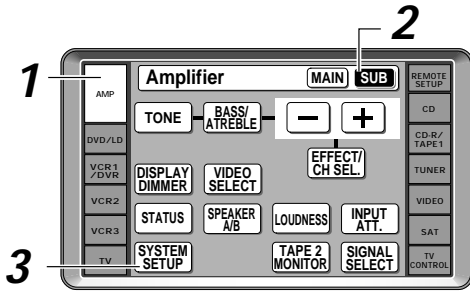

▲/▼/◀/▶/ENTER buttons

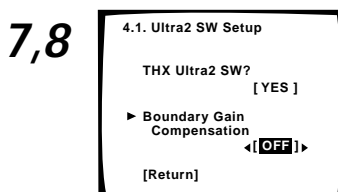
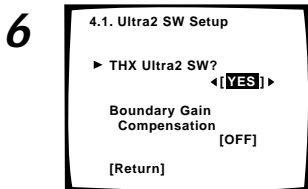
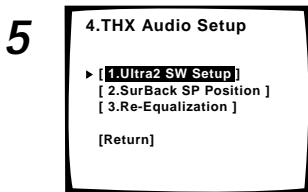
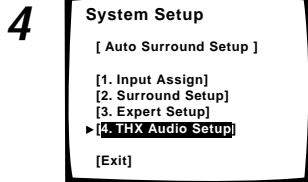

1 Turn on the amplifier and your TV, press the AMP on the remote control.

Make sure your TV is set to the amplifier.

2 Press the SUB button on the amplifier screen.

3 Press the SYSTEM SETUP button.

The menu possibilities appear on your TV.

4 Use the ▲▼ buttons to select THX AUDIO SETUP. Press ENTER.

5 Use the ▲▼ buttons to select ULTRA2 SW SETUP. Press ENTER.

6 If your subwoofer is THX Ultra2 certified, select YES. Use the ◀▶ buttons and then press ▼.

If your subwoofer isn't THX Ultra2 certified, but you still want to switch the boundary gain compensation to ON, select YES but the results may not be satisfactory.

7 Use the ◀▶ buttons to select ON or OFF.

8 Use ▼ to select RETURN then press ENTER.

9 If you want to continue THX AUDIO SETUP use the ▲▼ buttons to select the next setup and press ENTER.

Go on to the next page.

10 If you want to finish THX AUDIO SETUP use the ▲▼ buttons to select RETURN and press ENTER. Then use the ▲▼ buttons to select EXIT and press ENTER.



- If you select YES the BASS PEAL LEVEL (see p.84) will be cancelled.
- See the THX section in Techno Tidbits (p.93-94) for more information on the THX Ultra2 Subwoofer feature.

Surround Back Speaker Position

This setting has been specifically designed to set the distance between your surround back speakers, If you don't have surround back speakers, or just have one, you won't be able to select this setting. The Advanced Speaker Array (ASA) system was developed with the principles of THX Ultra2 technology in order to get optimum sound from your surround back speakers. You choose whether your speakers are closer or further apart than 4 feet (setting them together is best for ASA). For more information about ASA see page 94 and for more information on speaker placement using the ASA system see p.96.

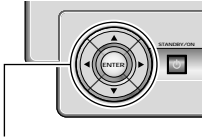

▲/▼/◀/▶/ENTER buttons

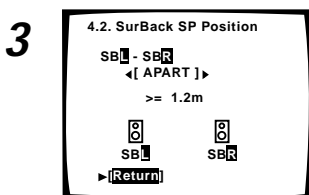
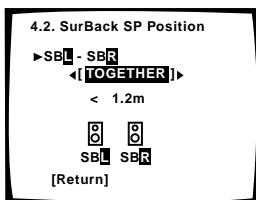
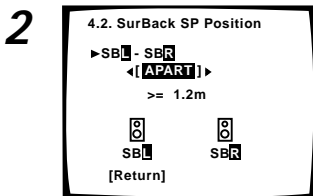
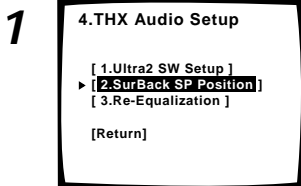

Follow steps 1-4 on page 88, if necessary, to get to the starting point mentioned here.

1 SURBACK SP POSITION should be selected if it isn't use the ▲▼ buttons to select it. Press ENTER.

2 Use the ◀▶ buttons to select either APART or TOGETHER.

3 Use the ▲▼ buttons to select RETURN and press ENTER.

4 If you want to continue THX AUDIO SETUP use the ▲▼ buttons to select the next setup and press ENTER.

Go on to the next page.

5 If you want to finish THX AUDIO SETUP use the ▲▼ buttons to select RETURN and press ENTER. Then use the ▲▼ buttons to select EXIT and press ENTER.

Re-Equalization

Re-Equalization is a built-in feature of THX technology (see p.93) and is thus always in use for HOME THX modes. If you want to apply this feature to other listening modes complete the steps below. Whether this setting will benefit you or not depends on the type of room you have and your individual listening tastes.

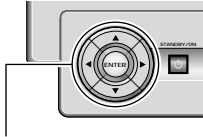

▲/▼/◀/▶/ENTER buttons

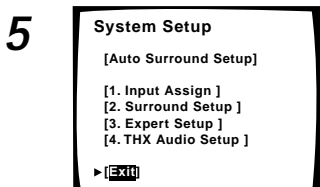
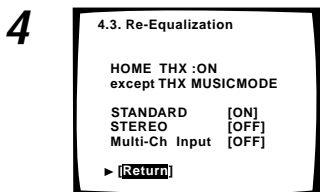
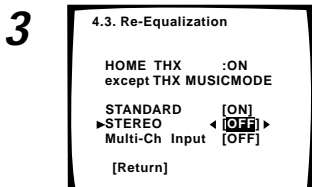
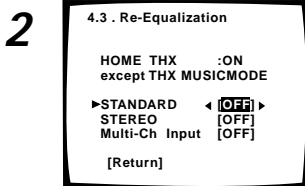
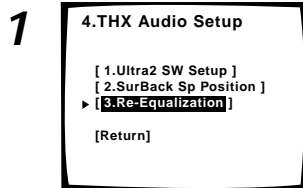

Follow steps 1-4 on page 88, if necessary, to get to the starting point mentioned here.

1 RE-EQUALIZATION should be selected if it isn't use the ▲▼ buttons to select it.

2 Use the ▼▲ buttons to select the STANDARD, STEREO, or MULTI-CH INPUT settings.

You should choose the listening mode that you would use for listening to movies or other sources that would generally be played in a large theater.

3 Use the ◀▶ buttons to select ON for the mode(s) you specified above.

Selecting STANDARD ON will also apply Re-Equalization to the ADVANCED CINEMA listening modes.

4 Select RETURN (use ▼▲) to go back to the THX AUDIO SETUP menu and press ENTER.

5 If you want to finish THX AUDIO SETUP use the ▲▼ buttons to select RETURN and press ENTER. Then use the ▲▼ buttons to select EXIT and press ENTER.



If you set this function on the amplifier cannot do 96kHz processing.

Dolby Digital

Dolby Digital is a discrete digital surround format used for multichannel surround sound. It was developed after the Dolby Surround System and Dolby Pro Logic Surround System. Dolby Digital is a high quality digital sound format that is used by many theatrical film releases.

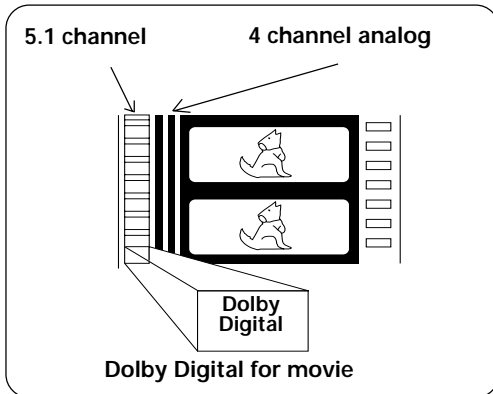

Soundtracks using linear PCM audio generate too much data for multichannel use. Dolby Digital technology was developed in response to the need for efficient multichannel digital sound. It uses masking technology and Adaptive Transform Coding, resulting in no audible loss of sound quality. In the present age of digital sound Dolby Digital is a standard audio format for DVD and has been adopted by HDTV broadcasts throughout the USA.

Other features include:

- 1) Downmixing on playback for compatibility with mono, stereo, Dolby Pro Logic and 5.1 channel audio.
- 2) A wide range of bitrates and channels.
- 3) Decoding dynamic range information and adjusting the dialog level in the soundtrack (called Dialog Normalization, see below for more information).

The advantages of the Dolby Digital system of encoding allow it to maintain its high quality sound while at the same time being very flexible, with the ability to handle many different types of soundtracks.

Dialog Normalization

When a Dolby Digital soundtrack is played back the Dialog Normalization function of the amplifier activates automatically. Dialog Normalization is a Dolby Digital function that establishes the average dialog level for the program source being played. If the amplifier's level does not match the average dialog level, first you see "DIAL NORM" and "OFFSET +4 dB" (as an example) appear in the amplifier's display. In this example, the number +4 dB is the difference between the amplifier's gain structure and the Dolby Digital average dialog level. To match the average dialog level, subtract or add the OFFSET level. For example, if the OFFSET level is +4 dB, the amplifier's output is 4 dB over the average recorded level.

Dolby Pro Logic II

Dolby Pro Logic II is an improved version of Dolby Pro Logic technology with extended matrix decoding technology that can create 5.1 channel sound from two channel sources. Dolby Pro Logic II creates basic 5 channel sound by using the innovative "steering logic" circuit. Therefore when listening to typical two-channel sources like CD, the listener can enjoy a richer spatial effect. When using software encoded with Dolby Surround, this decoding system affords the listener an improved surround experience with greater sound detail.

Chart Comparing Dolby Pro Logic and Dolby Pro Logic II

	Pro Logic	Pro Logic II
Effective sound source	Dolby Surround encoded sources	All two channel stereo sources
Surround Sound	Mono	Stereo
Frequency Range	Surround within 7 kHz	All Channels/Full Range

This unit has a three Dolby Pro Logic II functions. The first is "Movie Mode" (suitable for film soundtracks); "Music Mode" (suitable for music); "Pro Logic Mode" (this mode is less sensitive to the quality of the source material, so may be useful when Movie Mode or Music Mode do not give good results). One can select one of them depending on your soundtrack of choice.



- For amplifiers and components other than the VSA-AX10 Dolby Pro Logic II may not have the above mentioned functions.

Dolby Digital Surround EX

This new recording technology is able to play 6.1 channel sound and was developed in a collaboration between Dolby Laboratories and Lucasfilm, Ltd. for the film "Stars Wars: The First Episode", the first movie ever to be made with Dolby Digital Surround EX technology. In a movie theater this format affords the listener vivid surround sound experience replete with the effect of sounds flying overhead, even for those seated towards the sides of the theater.

Dolby Digital Surround EX contains surround back channels which are dubbed into the soundtrack in studio. The channels are encoded into the left and right channels of the soundtrack so this format can be compatible with Dolby Digital 5.1 channel decoding. For a list of movies that contain Dolby Digital Surround EX soundtracks see Dolby website at: <http://www.dolby.com>

THX Surround EX technology was developed for movie theater use originally but has been extended for home theater use and consumers can no benefit from this excellent, realistic sound format. (For more details see "THX Surround EX" on the next page.) This unit is equipped with a THX Surround EX decoder.

MPEG Audio Multichannel

MPEG is an audio encoding system which delivers high quality audio for music and movies. By removing frequencies which are out of the human hearing range, the sound is then compressed to enable the transmission of mono, stereo, or multichannel (5.1 and 7.1) audio in a single bitstream which is why it has become a standard audio format for DVD and personal computers. The composition and versatility of MPEG audio also ensures that the presentation of a multichannel soundtrack will sound appropriate on everything from a 7.1 channel surround sound home theater setup to a mono television set. Above all, MPEG audio is designed to be compatible with past and future MPEG audio versions, which means that future versions of MPEG audio will be compatible with decoders currently being produced (the signal is merely reconfigured to fit the number of channels available in a system).

DTS



DTS

DTS has been adopted as a sound recording format in the movie theaters since the release of "JURASSIC PARK" in 1993, and has a good reputation for high quality sound and dynamic surround effects. In this system, 6 channels of digital sound are recorded on CD-ROM. DTS adopts a simultaneous playback format. With a low rate of compression of sound signals and a high rate of transmittance, a higher sound quality format is produced. For this reason, the format is being introduced in more and more movie theaters, and is being adopted for home use as DTS Digital Surround. When used with movies it's called DTS-LD DVD and for music software (5.1 channel CD) as DTS-CD .

DTS-ES

DTS launched a new surround format in November 2000. This has come to be known as DTS Extended Surround or simply DTS-ES. The technology has been advanced to include two new home formats DTS-ES Discrete 6.1 format, and DTS-ES Matrix 6.1 ch format, both are able to playback discrete, 6.1 channel content from DVDs and CDs. Both of these formats are compatible with a conventional DTS 5.1 ch decoder. In this system each channel is encoded and decoded individually, adding to the separation of the channels. Since DTS adds a third surround channel, the surround back channel, the realism and all-encompassing nature of the sound reaches levels not seen before in home theater. This unit is equipped with a DTS-ES decoder.

DTS Neo:6

This is a matrix decoding technology that transforms two-channel sources into 6.0 channel surround sound. There are two modes, "Cinema Mode" and "Music Mode".

DTS 96/24

This high-quality format will be used for software which will be available from November, 2001. For compatibility with equipment that was produced before this format was made, DVD players can play this software using a conventional DTS 5.1ch decoder. This unit is equipped with a DTS 96 kHz/24 bit decoder to take advantage of the higher sound quality available.

THX®



THX Cinema™ processing : THX is an exclusive set of standards and technologies established by the world-renowned film production company, Lucasfilm Ltd. THX grew from George Lucas' personal desire to make your experience of the film soundtrack, in both movie theaters and in your home theater, as faithful as possible to what the director intended.

Movie soundtracks are mixed in special movie theaters called dubbing stages and are designed to be played back in movie theaters with similar equipment and conditions. This same soundtrack is then transferred directly onto Laserdisc, VHS tape, DVD, etc., and is not changed for playback in a small home theater environment.

THX engineers developed patented technologies to accurately translate the sound from the movie theater environment into the home, correcting the tonal and spatial errors that occur. On this product, when the THX indicator is on, THX features are automatically added in Cinema modes (e.g. THX Cinema, THX Surround EX).

Re-Equalization™ : The tonal balance of a film soundtrack will be excessively bright and harsh when played back over audio equipment in the home because film soundtracks were designed to be played back in large movie theaters using very different professional equipment. Re-Equalization restores the correct tonal balance for watching a movie soundtrack in a small home environment.

Timbre Matching™ : The human ear changes our perception of a sound depending on the direction from which the sound is coming. In a movie theater, there is an array of surround speakers so that the surround information is all around you. In a home theater, you use only two speakers located to the side of your head. The Timbre Matching feature filters the information going to the surround speakers so that they more closely match the tonal characteristics of the sound coming from the front speakers. This ensures seamless panning between the front and surround speakers.

Adaptive Decorrelation™ : In a movie theater, a large number of surround speakers help create an enveloping surround sound experience, but in a home theater there are usually only two speakers. This can make the surround speakers sound like headphones that lack spaciousness and envelopment. The surround sounds will also collapse into the closest speaker as you move away from the middle seating position. Adaptive Decorrelation slightly changes one surround channel's time and phase relationship with respect to the other surround channel. This expands the listening position and creates--with only two speakers--the same spacious surround experience as in a movie theater.

THX Ultra™ : Before any home theater component can be THX Ultra certified, it must incorporate all the features above and also pass a rigorous series of quality and performance tests. Only then can a product feature the THX Ultra logo, which is your guarantee that the Home Theater products you purchase will give you superb performance for many years to come. THX Ultra requirements cover every aspect of the product including pre-amplifier performance and operation, and hundreds of other parameters in both the digital and analog domain.

THX Surround EX™ : THX Surround EX-Dolby Digital Surround EX is a joint development of Dolby Laboratories and the THX division of Lucasfilm Ltd.

In a movie theater, film soundtracks that have been encoded with Dolby Digital Surround EX technology are able to reproduce an extra channel which has been added during the mixing of the program. This channel, called Surround Back, places sounds behind the listener in addition to the currently available front left, front center, front right, surround right, surround left and subwoofer channels. This additional channel provides the opportunity for more detailed imaging behind the listener and brings more depth, spacious ambience and sound localization than ever before.

Movies that were created using the Dolby Digital Surround EX technology, when released into the home consumer market may exhibit wording to that effect on the packaging. A list of movies created using this technology can be found on the Dolby web site at www.dolby.com. A list of available DVD software titles encoded with this technology can be found at www.thx.com. Only amplifier and controller products bearing the THX Surround EX logo, when in the THX Surround EX mode, faithfully reproduce this new technology in the home.

This product may also engage the THX Surround EX mode during the playback of 5.1 channel material that is not Dolby Digital Surround EX encoded. In such case the information delivered to the Surround Back channel will be program dependent and may or may not be very pleasing depending on the particular soundtrack and the tastes of the individual listener.

Advanced Speaker Array™ (ASA): When you set up your home theater system using all eight speaker outputs (Left, Center, Right, Surround Right, Surround Back Right, Surround Back Left, Surround Left and Subwoofer) and the two Surround Back speakers are placed close together as shown in the diagram on p.96, you can take advantage of THX's Advanced Speaker Array (ASA) technology.

ASA optimizes the surround sound experience using two new modes: THX Ultra2 Cinema and THX MusicMode.

THX Ultra2™ Cinema mode: When presented with a multichannel digital signal (Dolby Digital, DTS, etc.) the VSA-AX10 automatically selects THX Ultra2 Cinema mode. This mode plays 5.1 movies using all 8 speakers giving you the best possible movie watching experience. In this mode ASA processing blends the side surround speakers and back surround speakers providing the optimal mix of ambient and directional surround sounds.

THX's ASA circuitry will automatically detect DTS-ES (Matrix and 6.1Discrete) and Dolby Digital Surround EX encoded soundtracks for correct playback using all 8 speakers.

Please note that some Dolby Digital Surround EX soundtracks are missing the digital flag that allows ASA to switch automatically. Therefore, if you know that the movie that you are watching is encoded in Surround EX, you may manually select the THX Surround EX playback mode.

THX MusicMode™: On some music DVDs the surround sounds are mixed quite differently than surround sounds mixed for movie soundtracks. ASA technology optimizes the play back of 5.1 encoded music sources such as DTS and Dolby Digital. Using all 8 speakers the THX MusicMode provides a wide stable rear soundstage, placing surround sounds best suited for music playback.

Boundary Gain Compensation™: Room boundaries (walls) or other characteristics (such as wall construction) may increase the perceived acoustics levels at low frequencies. Depending on the listener's and the subwoofer's position, the listener may experience an excessive bass effect. The purpose of this feature is to compensate for excessive bass resulting from a boundary gain effect. This feature is designed to operate when used with a subwoofer certified to THX Ultra2 specifications. If not used with a THX certified Ultra2 subwoofer then this feature will not operate correctly and its operation will be unpredictable. In the THX Audio setup menu choose "Ultra2 SW Setup". Then choose "THX Ultra2 Subwoofer-Yes". This now allows you to operate the Boundary Gain Compensation feature. Once you have set up the speaker system, play some program material with familiar bass content. If you are close to a boundary you may decide to switch the Boundary Gain Compensation feature ON if you feel that the bass sound excessive. Please also note that when a THX certified Ultra2 subwoofer is used, the Bass Limiting protection feature is disabled in this product as protection is provided by the subwoofer.

Speaker Placement Information

Placement of your speakers is a crucial aspect of attaining accurate and realistic surround sound. Certain pointers concerning speakers stands, direction, angle and distance of speakers will be useful in this regard.

Firstly, it is best not to put your speakers directly on the floor. If you do this some of the sound vibration (especially bass) will go directly into the flooring and be lost. Instead we recommend using extremely hard objects (like cinder blocks) or designated speaker stands to support your speakers. Avoid placing the speakers on soft (like cushions or sofas) as these will also lead to sound loss and unstable surfaces (like flimsy shelving) as they may cause speaker accidents. In order to achieve a surround sound effect, make sure the speakers are a reasonable distance from your main listening position. Follow the diagrams and instructions below for optimum placement of each set of speakers.

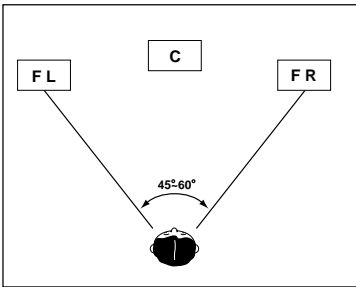

If you're using a CENTER speaker set the FRONT speakers to a wider angle. If not, set them to a narrower angle.

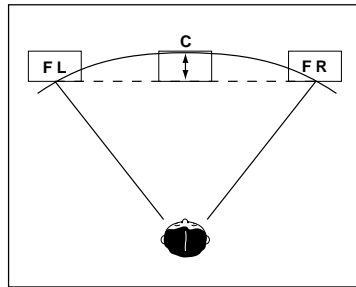

Make sure the CENTER speaker does not cross the forward plane of the FRONT speakers. Install above or below the TV so that the sound of the CENTER channel is localized at the TV screen.

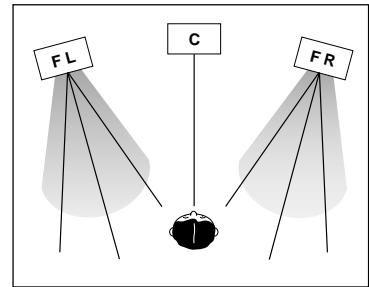

It is best to angle the speakers towards the listening position. The angle depends on the size of the room. Use less angle for bigger rooms.

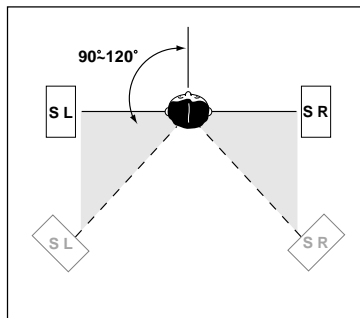

Surround speakers should be positioned 60 cm to 90 cm higher than your ears and tilted slight downward.

Make sure the speakers don't face each other. For DVD Audio the speakers should be more directly behind the listener than for home theater playback.

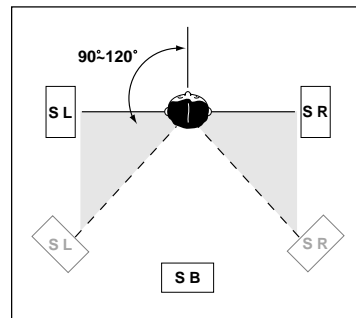

Surround back speakers should also be positioned 60 cm to 90 cm higher than your ears and tilted slight downward. Make sure the speakers don't face each other. For DVD Audio the speakers should be more directly behind the listener than for home theater playback.

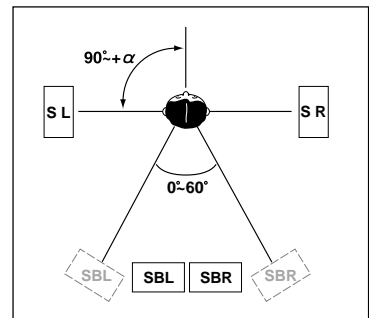

Speaker Placement for a Complete THX Speaker System

If you have a complete THX Speaker System set (LucasFilm authorized), follow the diagram below to place your speakers. Notice the surround speakers should output at an angle parallel to the listener. Also, notice the angle of the front speakers.

If you have two surround back speakers we recommend placing them together and the same distance from your listening position so you can take advantage of the ASA feature. For more details see pages 89 & 94.

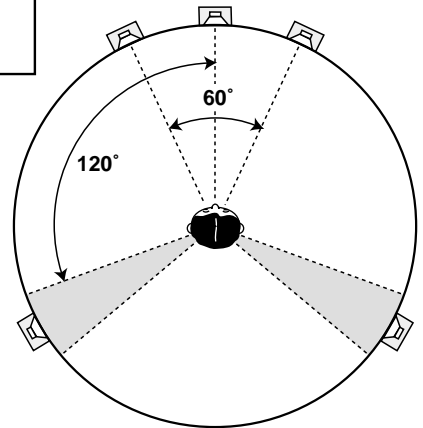
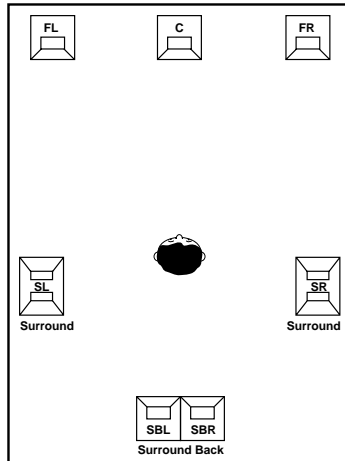

Speaker Placement for DVD-Audio (etc.) Sources

The best speaker placement for DVD-Audio (and other multichannel music sources) may be different than for regular DVD discs. For these formats follow the diagram at right as opposed to the home theater setups of the preceding pages. If you want to use both home theater and DVD-Audio discs follow the diagrams below and set up your MULTI CH IN SELECT output mode accordingly.

In order to choose the best MULTI CH IN SELECT output mode (see p.87) use the diagrams here. Find the diagram that most closely resembles your surround and surround back speaker setup and then chose that output mode.

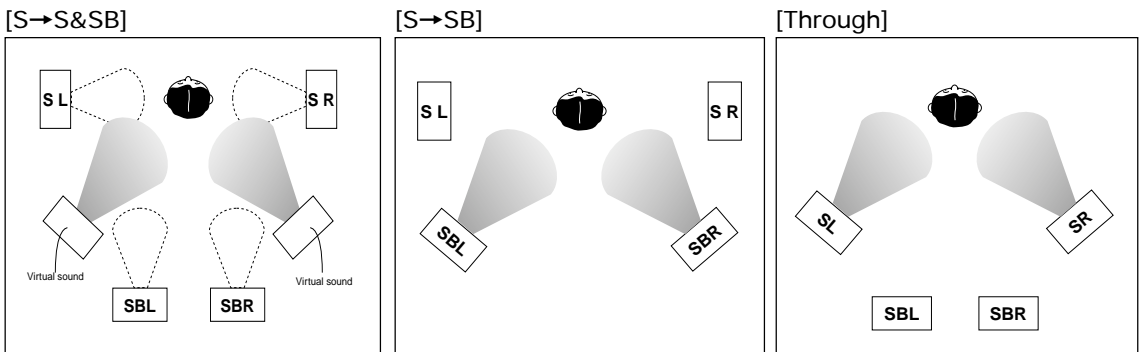

In this diagram the white sound waves represent the actual transmitted sound and the shaded sound waves represent the how the sound will seem to the listener (the virtual sound).

Audio Block Diagram

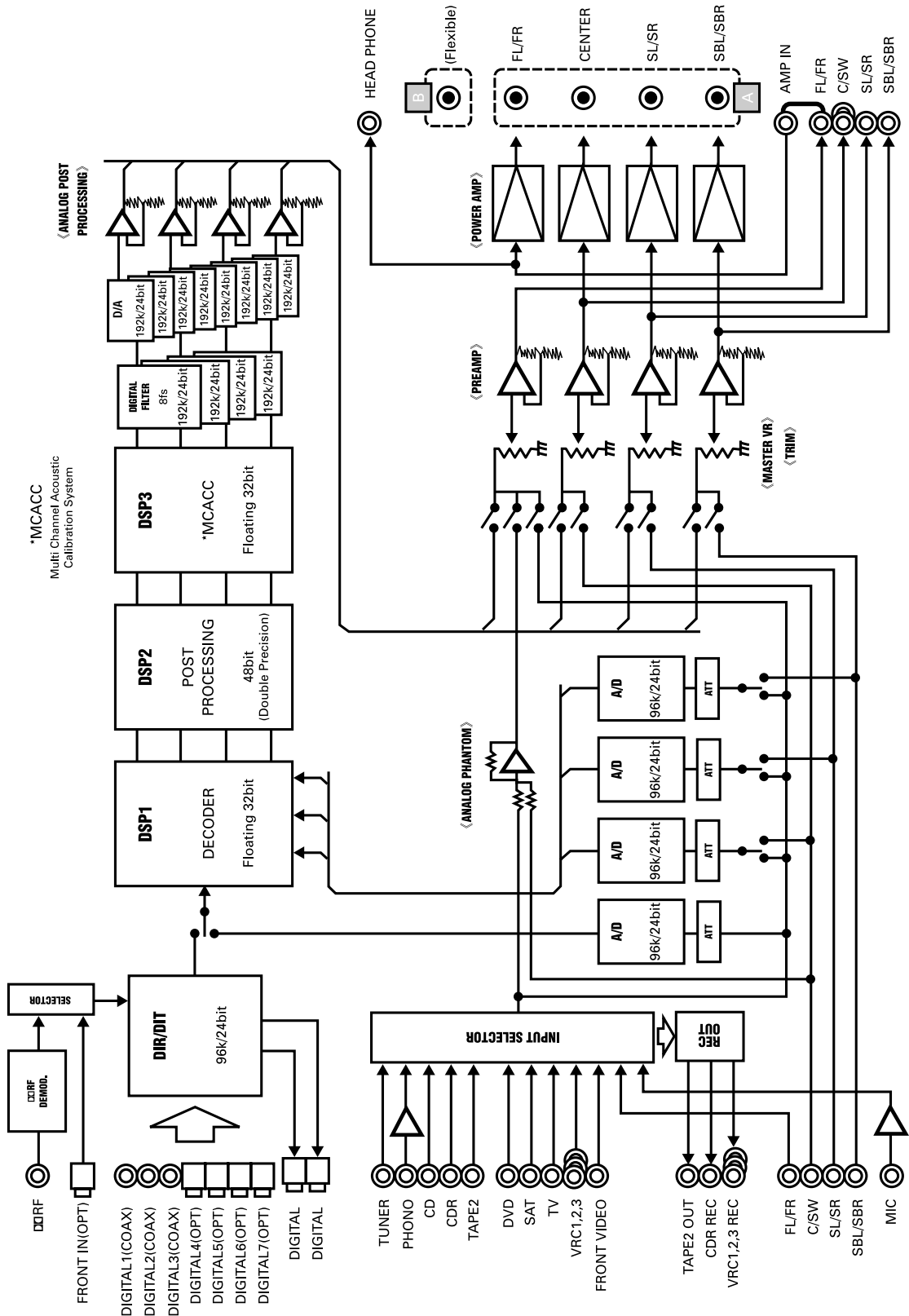

EXPERT

Troubleshooting

Incorrect operations are often mistaken for trouble and malfunctions. If you think that there is something wrong with this component, check the points below. Sometimes the trouble may lie in another component. Investigate the other components and electrical appliances being used. If the trouble cannot be rectified even after exercising the checks listed below, ask your nearest PIONEER authorized service center or your dealer to carry out repair work.

Symptom	Cause	Remedy
Power		
The power does not turn on.	<ul style="list-style-type: none"> The power plug is disconnected. The protection circuit may have been activated. 	<ul style="list-style-type: none"> Connect the power plug to the wall outlet. Disconnect the power plug from the outlet, and insert again.
The unit does not respond when the buttons are pressed.	<ul style="list-style-type: none"> Static electricity caused by dry air. 	<ul style="list-style-type: none"> Switch the unit off, then on again. Disconnect the power plug from the outlet, and insert again.
During operation, the unit suddenly switches off.	<ul style="list-style-type: none"> The speaker wires are frayed or sticking out of the jack, and are touching the back of the amplifier or another set of wires. 	<ul style="list-style-type: none"> Reinsert the speaker wires, making sure there are no stray strands of wire and that they are inserted fully.
AMP ERR blinks in the display and the unit turns off.	<ul style="list-style-type: none"> The amplifier probably has a serious problem. 	<ul style="list-style-type: none"> You can't operate the amplifier for a minute. After that turn the amplifier back on. If you have the same problem again call a Pioneer-accredited repair center.
OVERHEAT blinks in the display and no sound is output.	<ul style="list-style-type: none"> The amplifier has gotten too hot. 	<ul style="list-style-type: none"> Turn the amplifier off and allow it to cool down with good ventilation. It is very likely that you have a heat dispersal and ventilation problem so please follow the instructions on p.7 ("Installing the Amplifier ") carefully.
Setup		
The setup screen doesn't appear.	<ul style="list-style-type: none"> The output jacks haven't been connected properly. The MONITOR OUT jack haven't been connected. 	<ul style="list-style-type: none"> Check all connections. Connect the MONITOR OUT jacks to the TV monitor.
Every time Auto Surround Sound Setup is attempted, there is some kind of error, or the settings seem incorrect.	<ul style="list-style-type: none"> The room environment is not optimal for auto setup (too much ambient noise, obstacles blocking the speakers from the microphone, etc.) 	<ul style="list-style-type: none"> Make sure the room environment follows 38-39) the guidelines displayed on the OSD during auto setup.
The LARGE and SMALL settings for speakers after the Auto Surround Sound Setup are incorrect.	<ul style="list-style-type: none"> There are other frequencies in the room that are affecting the auto setup. 	<ul style="list-style-type: none"> Check for household appliances (air conditioner, fridge, fan, etc.) that may be affecting the environment and switch them off if necessary.
After the proper settings have been made, there still seems to be something wrong with the sound.	<ul style="list-style-type: none"> The speakers have been incorrectly connected (+/- connections are reversed). 	<ul style="list-style-type: none"> Check all connections.
No audio		
No sound is output when a function is selected.	<ul style="list-style-type: none"> Improper connections. Sound is muted. The volume is turned down. The TAPE 2 MONITOR is on. Speakers are turned off or selected improperly with the A/B switch. DIGITAL/ANALOG setting is incorrect. MULTI CH IN mode is on. 	<ul style="list-style-type: none"> Make sure the component is connected correctly (see p.18-28). Press MUTING on the remote control. Adjust MASTER VOLUME. Turn the TAPE 2 MONITOR off. Press SPEAKERS (A/B) to select the speakers you connected. Select the proper signal with the SIGNAL SELECT button (see p.48). Turn MULTI CH IN mode off.
No sound output from the front speakers.	<ul style="list-style-type: none"> The U-shaped connectors that connect the POWER AMP IN terminals to the front channel pre outs are not connected. The front speakers are connected to the B speaker system jack. 	<ul style="list-style-type: none"> Connect the POWER AMP IN terminals to the front channel pre outs using the supplied U-shaped connectors. Connect the front speakers to the A speaker system jacks.

Symptom	Cause	Remedy
No sound from surround or center speakers.	<ul style="list-style-type: none"> • Speaker settings are incorrect. • The surround and/or center levels are turned down. • The surround and/or center speakers are disconnected. • The listening mode is STEREO. 	<ul style="list-style-type: none"> • See "SPEAKER SYSTEMS" on p.38-40 to check the speaker settings. • See "CHANNEL LEVEL" p.42 to check the speaker levels. • Connect the speakers (see p.26). • Choose a surround listening mode.
No sound output from the subwoofer.	<ul style="list-style-type: none"> • The subwoofer setting is NO. • The subwoofer output setting is too small. • The bass peak level setting is too low. • There is very little low frequency information in your source. • The crossover frequency is set too low. • There is a problem with the subwoofer. • The subwoofer isn't connected properly. 	<ul style="list-style-type: none"> • Change the setting to YES or PLUS. • Adjust the output setting to the level you want • Adjust the peak level setting to the level you want. • Change your subwoofer setting to one of the following: Front: SMALL Subwoofer: YES Front: LARGE Subwoofer: PLUS • Raise the frequency level to match your speakers' playback characteristics. • Check the three following points: <ul style="list-style-type: none"> • Check the power. • Check the subwoofer volume control . • Check the subwoofer hasn't automatically switched to standby mode (check the subwoofer manual) • Check all connections.
No sound output from the surround back speakers.	<ul style="list-style-type: none"> • The LISTENING CH SELECT is set to 5.1 channel playback. • The source is not a 6.1 channel playback source. • The speaker system setting is on FRONT BI-AMP 5.1 or the surround back speaker setting is NO. • The surround back speakers aren't connected properly. • The surround back channel is set to 1 speaker setting only, and the speaker is connected to the right channel output. 	<ul style="list-style-type: none"> • Choose 7.1 channel playback. • Choose 7.1 channel playback or choose one of the ADVANCED listening modes. • Choose NORMAL SURROUND, adjust the surround back channel setting according to the number of speakers you're using, and then set LISTENING CH SELECT to 7.1. • Check all connections. • Connect the speaker to the surround back left channel output.
No sound output from one speaker.	<ul style="list-style-type: none"> • The speaker system setting is NO. • The speaker isn't connected properly. • The source has no sound output for that channel. • The speaker output level is set too small. 	<ul style="list-style-type: none"> • Change the speaker setting to YES. • Check all connections. • If you choose one of the ADVANCED listening modes, an extra channel may be created for the speaker. • Increase the speaker output level.
Sound is produced from some components, but not from digital components.	<ul style="list-style-type: none"> • SIGNAL SELECT is set incorrectly. • The digital inputs are assigned incorrectly, or not at all. • The digital components aren't connected properly. • The player is not compatible with the source you're using, or the player settings are incorrect. • The TAPE 2 MONITOR is on, or MULTI CH IN mode has been selected. • The digital output level has been turned down on a CD player or other component equipped with digital output level adjustment capability. 	<ul style="list-style-type: none"> • Set SIGNAL SELECT to "AUTO" or according to the type of connections made (see p.48). • Set the digital input settings correctly (see p.13, 25, 80). • Check all connections. • Choose a compatible source, or check the player's manual for the correct settings. • Switch the TAPE 2 MONITOR off, or choose one of the listening modes (MULTI CH IN switches off automatically). • Set the digital volume level of the player to full, or to the neutral position.

Techno Tidbits & Problem-solving

Symptom	Cause	Remedy
When playing an LD the SIGNAL SELECT is on RF but there is still no sound.	<ul style="list-style-type: none"> The LD is not a Dolby Digital compatible disc. 	<ul style="list-style-type: none"> Set the SIGNAL SELECT to AUTO (make sure your LD player is hooked up with analog connections in addition to digital and RF connections, see p.18).
Other audio problems		
Subwoofer output is very low.	<ul style="list-style-type: none"> Settings route signal away from subwoofer. 	<ul style="list-style-type: none"> To get more signal to the subwoofer set it to PLUS or choose SMALL for the front speakers (see p.38-40).
During multi channel playback, there is no sound output from one speaker.	<ul style="list-style-type: none"> The MULTI CH IN SELECT is not set correctly. DIRECT mode is selected and one pair of speakers is set to NO. 	<ul style="list-style-type: none"> Select the correct number of input channels. Switch the setting to ADJUST mode.
During multi channel playback, the only sound output is from the front speakers.	<ul style="list-style-type: none"> 2 channel input is selected. 	<ul style="list-style-type: none"> Set the MULTI CH INPUT to 8 channel.
A multi channel DVD source appears to be downmixed from 2 channels during playback.	<ul style="list-style-type: none"> The source is coming from something other than the MULTI CH IN jacks (for example, digital PCM output, etc.) 	<ul style="list-style-type: none"> Check the MULTI CH IN connection and select the type of playback with the MULTI CH IN button.
The OVER indicator is constantly lit.	<ul style="list-style-type: none"> If you are using an analog source, the signal is too strong. 	<ul style="list-style-type: none"> Press the INPUT ATT button (see p.57). If the player has an analog output setting, lower it as necessary.
Noise or hum can be heard even when there is no sound being input.	<ul style="list-style-type: none"> There is electrical interference from another component or appliance. 	<ul style="list-style-type: none"> Check that personal computers or other digital components connected to the same power source are not causing interference.
When a search is performed by a DTS compatible CD player during playback, noise is output.	<ul style="list-style-type: none"> The search function performed by the player interferes with the reading of digital information. 	<ul style="list-style-type: none"> This is not a malfunction, but be sure to turn the volume down to prevent the output of loud noise from your speakers.
When playing a DTS format LD there is noise audible on the soundtrack.	<ul style="list-style-type: none"> The SIGNAL SELECT is on ANALOG. 	<ul style="list-style-type: none"> Set the SIGNAL SELECT to DIGITAL.
Can't record audio.	<ul style="list-style-type: none"> You are trying to make an analog recording from a digital signal, or a digital recording of an analog source. The digital source is copy protected. The REC jacks have not been connected properly. 	<ul style="list-style-type: none"> You can only record analog to analog, or digital to digital. You can't record digital sources that have been copy protected. Check all connections.

If the unit does not operate normally due to external effects such as static electricity

Disconnect the power plug from the outlet and insert again to return to normal operating conditions.

Techno Tidbits & Problem-solving

Symptom	Cause	Remedy
Video		
No image is output when an input is selected.	<ul style="list-style-type: none"> Improper connections. The input source is not properly selected. The component video setting is incorrect. 	<ul style="list-style-type: none"> Make sure the component is connected correctly (see p.18-21). Press the correct function button. Select the correct C'NENT VIDEO IN setting.
After connecting the TV and selecting the proper video input, there is still no image.	<ul style="list-style-type: none"> The video input selected on the TV monitor is incorrect. 	<ul style="list-style-type: none"> Please read the TV monitor manual and change the settings accordingly.
There is no image coming from the selected component video jacks.	<ul style="list-style-type: none"> The type of cord connected to the TV doesn't match your video input settings. 	<ul style="list-style-type: none"> Change the settings to match the cord connected.
Can't record video.	<ul style="list-style-type: none"> You are trying to record a source connected to the component video jacks. The source is copy protected. 	<ul style="list-style-type: none"> Connect the source component to either the composite video, or the S video jacks. You can't record sources that have been copy protected.
Input/display		
The display is dark.	<ul style="list-style-type: none"> The DISPLAY DIMMER button is pushed. 	<ul style="list-style-type: none"> Press DISPLAY DIMMER on the remote control repeatedly to return to the default setting (see p.59).
You can't get DIGITAL to come up when using the SIGNAL SELECT button.	<ul style="list-style-type: none"> Either the digital connections or the DIGITAL IN SELECT is incorrect. TAPE 2 MONITOR is on. MULTI CH IN mode is on. 	<ul style="list-style-type: none"> Make sure the digital connections and the DIGITAL IN SELECT is done correctly. Press the TAPE 2 MONITOR button so it goes into the off setting. Turn MULTI CH IN mode off.
The digital format indicator doesn't light up even when playing a non-PCM digital source.	<ul style="list-style-type: none"> The player is paused or stopped. There is a mistake in the player settings for audio output. 	<ul style="list-style-type: none"> Play the source. Fix the audio settings (check the manual that came with your DVD player).
A compressed digital source is being played, but the digital format indicators don't light up.	<ul style="list-style-type: none"> Although it's a non-PCM digital source there is a possibility the present track is not the proper format (5.1, 6.1, or 7.1 channel). 	<ul style="list-style-type: none"> There is no problem. The indicator won't light when the track is not a compressed digital source.
During playback of a compressed digital source, the PRO LOGIC or NEO:6 indicators show in the display.	<ul style="list-style-type: none"> The digital signal is not being sent with the source. The audio is in two channel format. It has already been Dolby surround encoded. 	<ul style="list-style-type: none"> Choose DIGITAL or AUTO with the signal select button. This is not a malfunction. Check the manufacturer information for the source.
During playback of a Surround EX or DTS ES source on the AUTO setting, the EX and ES indicators won't light.	<ul style="list-style-type: none"> The source may be 6.1 playback compatible, but there is no signal from the source to indicate this. 	<ul style="list-style-type: none"> Switch the LISTENING CH SELECT to 7.1 and switch to the THX Surround EX or Standard TX listening mode.

Techno Tidbits & Problem-solving

Symptom	Cause	Remedy
During playback of a Surround EX or DTS ES source on the AUTO setting, the EX and ES indicators light, but the signal is not properly processed.	<ul style="list-style-type: none"> The listening mode is set incorrectly for the source. 	<ul style="list-style-type: none"> Switch the LISTENING CH SELECT to AUTO and switch to the HOME THX or STANDARD listening mode. Switch the LISTENING CH SELECT to 7.1 and switch to the THX Surround EX or Standard TX listening mode.
During playback of a DVD audio source, the player shows a transfer rate of 96kHz, but the amplifier does not.	<ul style="list-style-type: none"> The multi channel connections are analog, so there is no digital transfer. 	<ul style="list-style-type: none"> This is not a malfunction. See the player's manual for more details.
During playback of a DTS 96/24 source, the display doesn't show 96kHz	<ul style="list-style-type: none"> The amplifier may be on a different mode than STANDARD. One of the DIGITAL NR, MIDNIGHT, LOUDNESS, and TONE features are switched on. The setting for speakers other than the surround back is set to NO. Re-EQ is on. 	<ul style="list-style-type: none"> Switch to STANDARD mode. Turn it/them off. The source has been downmixed to 48 kHz. Turn it off (see p.90).
During playback of a 96kHz source, the display doesn't show 96kHz	<ul style="list-style-type: none"> The amplifier may be on a different mode than STEREO. One of the DIGITAL NR, MIDNIGHT, LOUDNESS, and TONE features are switched on. Re-EQ is on. 	<ul style="list-style-type: none"> Switch to STEREO mode. Turn it/them off. Turn it off (see p.90).
Remote control		
Cannot be remote controlled.	<ul style="list-style-type: none"> The remote control batteries have worn out. Too far away or bad angle of operation. There is an obstacle between the amplifier and the remote control. Strong light such as fluorescent light is shining onto the unit's remote control signal light-receiving window. A cord is connected to the CONTROL IN terminal on this unit. Locking the settings on the remote control is turned on. The lock switch on the remote control is set to LOCK. 	<ul style="list-style-type: none"> Replace the batteries. Operate within 7 m, 30° of the remote sensor on the front panel. Remove the obstacle or operate from another position. Avoid exposing the remote sensor on the front panel to direct light. Connect cord to the correct jack. Turn Locking the settings off (see p.63). Set the lock switch to USE (see p.7).
Other components can't be operated with the system remote.	<ul style="list-style-type: none"> The preset code settings are wrong. The battery wore out and the system settings were cleared. 	<ul style="list-style-type: none"> Input the correct preset code. Reset the proper system settings.
The SR cable is connected, but the connected components can't be operated with the remote.	<ul style="list-style-type: none"> The SR cable hasn't been connected properly. The rest of the component connection have not been made. The component you have hooked up is not SR compatible. 	<ul style="list-style-type: none"> Reinsert the SR cable, making sure it is the right jack. Make sure an analog connection has been made between the units. This is not a malfunction.
Miscellaneous		
HOME THX 7.1 channel mode is selected, but there are certain options that can't be chosen.	<ul style="list-style-type: none"> The current setting is for only one surround back speaker. 	<ul style="list-style-type: none"> Connect two surround back speakers and make the settings accordingly.
There seems to be a time lag between the speakers and the output of the subwoofer.	<ul style="list-style-type: none"> The subwoofer channel can be delayed slightly if run through a low-pass filter. 	<ul style="list-style-type: none"> The MCACC system will automatically compensate for a delay in the subwoofer output during the Auto Surround Sound Setup.

Specifications

Amplifier Section

Continuous Power Output (Stereo Mode)
 Front 170 W + 170 W (DIN 1 kHz, THD 1 %, 6 Ω)

Continuous Power Output (Surround Mode)
 Front 170 W + 170 W (DIN 1 kHz, THD 1 %, 6 Ω)
 Center 170 W (DIN 1 kHz, THD 1 %, 6 Ω)
 Surround 170 W + 170 W (DIN 1 kHz, THD 1 %, 6 Ω)
 Surr. back 170 W + 170 W (DIN 1 kHz, THD 1 %, 6 Ω)

Rated Power Output 150 W + 150 W
 (20 Hz-20 kHz, THD 0.09 %, 6 Ω)

- Above specifications are applicable when the power supply is 230V.

Audio Section

Input (Sensitivity/Impedance)
 PHONO MM 4.7 mV/47 k Ω
 LINE 382 mV/47 k Ω

Phono Overload level (T.H.D.0.1 %, 1kHz)
 PHONO MM 120 mV

Frequency Response
 PHONO MM 20 Hz to 20,000 Hz \pm 0.3 dB
 LINE 5 Hz to 100,000 Hz $^{+0}_{-3}$ dB

Output (Level/Impedance)
 LINE 382 mV/2.2 k Ω

Tone Control
 BASS \pm 6 dB (100 Hz)
 TREBLE \pm 6 dB (10 kHz)
 LOUDNESS +4/+2 dB (100Hz/10 kHz)
 (at volume position -40dB)

Signal-to-Noise Ratio (IHF, short circuited, A network)
 PHONO MM 86 dB
 LINE 105 dB

Signal-to-Noise Ratio
 [DIN (continuous rated power output/50 mW)]
 PHONO MM 70/68 dB
 LINE 93/73 dB

Video Section

Input (Sensitivity) 1 Vp-p/75 Ω
 Output (Level/Impedance) 1 Vp-p/75 Ω
 Signal-to-Noise Ratio 70 dB
 Frequency Response 5 Hz to 10 MHz $^{+0}_{-3}$ dB

Component Video Section

Input (Sensitivity) 1 Vp-p/75 Ω
 Output (Level/Impedance) 1 Vp-p/75 Ω
 Signal-to-Noise Ratio 70 dB
 Frequency Response 5 Hz to 40 MHz $^{+0}_{-3}$ dB

Miscellaneous

Power Requirements AC 220 - 230 V, 50/60 Hz
 Power Consumption 710 W
 Power Consumption in Standby mode 0.65 W
 AC Outlet
 SWITCHED 100 W (0.4 A) MAX
 Dimensions 440 (W) \times 203 (H) \times 472 (D) mm
 Weight (without package) 29.3 kg

Furnished Parts

"AA" IEC LR6 batteries 4
 Remote Control Unit 1
 Touch Pen 1
 Cushion for Remote 4
 Microphone 1
 AC power cord 1
 U-shaped connectors 2
 Operating Instructions 1

NOTE:

Specifications and the design are subject to possible modifications without notice, due to improvements.

Maintenance of External Surfaces

- Use a polishing cloth or dry cloth to wipe off dust and dirt.
- When the surfaces are dirty, wipe with a soft cloth dipped in some neutral cleanser diluted five or six times with water, and wrung out well, and then wipe again with a dry cloth. Do not use furniture wax or cleaners.
- Never use thinners, benzine, insecticide sprays or other chemicals on or near this unit, since these will corrode the surfaces.



Published by Pioneer Corporation.
Copyright © 2001 Pioneer Corporation.
All rights reserved.

PIONEER CORPORATION 4-1, Meguro 1-Chome, Meguro-ku, Tokyo 153-8654, Japan
PIONEER ELECTRONICS [USA] INC. P.O. BOX 1540, Long Beach, California 90801-1540, U.S.A.
PIONEER ELECTRONICS OF CANADA, INC. 300 Allstate Parkway, Markham, Ontario L3R OP2, Canada
PIONEER EUROPE NV Haven 1087, Keetberglaan 1, B-9120 Melsele, Belgium TEL: 03/570.05.11
PIONEER ELECTRONICS AUSTRALIA PTY. LTD. 178-184 Boundary Road, Braeside, Victoria 3195, Australia, TEL: [03] 9586-6300
PIONEER ELECTRONICS DE MEXICO S.A. DE C.V. San Lorenzo 1009 3er Piso Desp. 302 Col. Del Valle Mexico D.F. C.P. 03100
TEL: 55-5688-5290

<TNGZF/01L00001>

Printed in Japan

<ARB7252-A>

Free Manuals Download Website

<http://myh66.com>

<http://usermanuals.us>

<http://www.somanuals.com>

<http://www.4manuals.cc>

<http://www.manual-lib.com>

<http://www.404manual.com>

<http://www.luxmanual.com>

<http://aubethermostatmanual.com>

Golf course search by state

<http://golfingnear.com>

Email search by domain

<http://emailbydomain.com>

Auto manuals search

<http://auto.somanuals.com>

TV manuals search

<http://tv.somanuals.com>