

Operation Manual

사용 설명서

Multi-CD control DSP High power CD/MP3/WMA/MD
player with FM/AM tuner

FM/AM 튜너 겸용 멀티 CD 컨트롤 DSP 고출력 CD/
MP3/WMA/MD 플레이어

FH-P9200MP



MDLP

SUPER TUNER III  **D**

Thank you for buying this Pioneer product.

Please read through these operating instructions so you will know how to operate your model properly. *After you have finished reading the instructions, put them away in a safe place for future reference.*

01 Before You Start

- About this manual 5
- Precautions 5
- Features 5
- About WMA 6
- Switching the DSP setting mode 6
- Resetting the microprocessor 6
- About the demo mode 7
 - Reverse mode 7
 - Feature demo 7
- About basic displays 7
- SOFT KEY operation 8
 - Switching the function of the multi-function buttons 8
 - Example of multi-function button operation 8
 - The difference between the BAND button and the BACK button 9
- Key guidance indicator 10
- Setting the display angle 10
- Use and care of the remote control 11
 - Installing the battery 11
 - Replacing the battery 11
 - Using the remote control 11
 - FUNCTION button and AUDIO button 12

02 What's What

- Head unit 13
- Remote control 14

03 Power ON/OFF

- Turning the unit on 15
- Selecting a source 15
- Turning the unit off 15

04 Tuner

- Listening to the radio 16
- Introduction of advanced tuner operation 16

- Storing and recalling broadcast frequencies 17
- Tuning in strong signals 17
- Storing the strongest broadcast frequencies 17
- Selecting stations from the preset channel list 18

05 Built-in CD Player

- Playing a CD 19
- Introduction of advanced built-in CD player operation 20
- Repeating play 20
- Playing tracks in a random order 20
- Scanning tracks of a CD 20
- Selecting tracks from the track title list 21
- Pausing CD playback 21
- Selecting the search method 21
- Searching every 10 track in the current disc 21
- Entering disc titles 22
- Using disc title functions 22

06 MP3/WMA Player

- Playing a MP3/WMA 23
- Introduction of advanced built-in CD player (MP3/WMA) operation 24
- Repeating play 24
- Playing tracks in a random order 25
- Scanning folders and tracks 25
- Pausing MP3/WMA playback 25
- Selecting folders from the folder title list 26
- Selecting the search method 26
- Searching every 10 track in the current folder 26
- Switching the tag display 27
- Using disc title functions 27

07 Built-in MD Player

- Playing an MD 28

Introduction of advanced built-in MD player operation **29**

Repeating play **29**

- Non group-recorded MD **29**
- Group-recorded MD **29**

Playing tracks in a random order **29**

Scanning tracks of a MD **30**

Selecting tracks from the track title list **30**

Selecting groups from the group title list **30**

Pausing MD playback **31**

Using disc title functions **31**

08 Multi-CD Player

Playing a CD **32**

50-disc multi-CD player **32**

Selecting a disc directly **32**

Introduction of advanced multi-CD player operation **33**

Repeating play **33**

Playing tracks in a random order **33**

Scanning CDs and tracks **34**

Selecting tracks from the track title list **34**

Selecting discs from the disc title list **34**

Pausing CD playback **35**

Using ITS playlists **35**

- Creating a playlist with ITS programming **35**
- Playback from your ITS playlist **36**
- Erasing a track from your ITS playlist **36**
- Erasing a CD from your ITS playlist **36**

Entering disc titles **36**

Using disc title functions **37**

Using compression and bass emphasis **38**

09 TV tuner

Using the TV tuner **39**

Introduction of advanced TV tuner operation **39**

Storing and recalling broadcast stations **39**

Selecting channels from the preset channel list **40**

10 DVD Player

Playing a disc **41**

Introduction of advanced DVD player operation **41**

Repeating play **42**

Playing tracks in a random order **42**

Scanning tracks of a CD **42**

Pausing disc playback **42**

Using ITS playlist, disc title input and disc title list functions **42**

11 Audio Adjustments

Operation modes **43**

- Operation mode marks **43**

3-way network mode **NW** **43**

Standard mode **STD** **43**

- Adjusting the audio easily **43**
- Adjusting the audio finely **43**

Extra functions **44**

Introduction of audio adjustments **44**

Using the position selector **44**

Using balance adjustment **NW** **45**

Using balance adjustment **STD** **45**

Using the time alignment **45**

- Adjusting the time alignment **46**

About the network function **NW** **47**

- Adjustable parameters **47**
- Points concerning network adjustments **47**
- Muting the speaker unit (filter) **48**
- Adjusting network **48**

Using subwoofer output **STD** **49**

- Adjusting subwoofer settings **49**

Using the high pass filter **STD** **50**

- Setting the high pass filter for front speakers **50**
- Setting the high pass filter for rear speakers **50**

- Using the auto-equalizer **STD** 50
- Recalling equalizer curves 50
- Adjusting equalizer curves 51
- Adjusting 13-band graphic equalizer 51
- Using BBE sound **NW** 52
 - Adjusting BBE sound level 52
- Adjusting loudness 52
- Using sound field control and BBE sound **STD** 52
 - Recalling sound field programs 53
 - Adjusting BBE sound level 53
- Using automatic sound levelizer 53
- Adjusting source levels 53
- Auto TA and EQ (auto-time alignment and auto-equalizing) **STD** 54
 - Before operating the auto TA and EQ function 54
 - Carrying out auto TA and EQ 55

12 Initial Settings

- Adjusting initial settings 57
- Using reverse mode 57
- Using the feature demo 57
- Switching the auxiliary setting 57
- Selecting the digital attenuator 58
- Switching the telephone muting/attenuation 58
- Setting the FM tuning step 58
- Setting the AM tuning step 58

13 Other Functions

- Attenuating volume 60
- Displaying and setting the clock 60
 - Turning the off clock display on or off 60
 - Setting the date 60
 - Setting the clock 60
 - Matching the time to a time signal 60
 - Setting the time signal display 61
- Changing the display form 61

- Adjusting the brightness 61
- Switching the dimmer setting 61
- Setting the flash light screen 61
- Selecting the wall paper pattern 62
- Switching the font 62
- Using different entertainment displays 62
 - Setting the movie screen 62
 - Setting the level indicator display 62
 - Setting the ASL display 63
 - Setting the background visual 63
 - Setting the background still picture 63
 - Canceling the entertainment display 63
- Using the AUX source 63
 - Selecting AUX as the source 63
 - Setting the AUX title 64

Additional Information

- Understanding built-in CD player error messages 65
- Understanding built-in MD player error messages 65
- Understanding auto TA and EQ error messages 65
- CD player and care 66
- CD-R/CD-RW discs 67
- MP3 and WMA files 67
 - MP3 additional information 68
 - WMA additional information 68
- About folders and MP3/WMA files 68
- MD player and care 69
- DSP adjustment value record sheet 70
 - 3-way network mode **NW** 70
 - Standard mode **STD** 70
 - Equalizer curves 70
- Terms 71
- Specifications 72

Before You Start

About this manual

This unit features a number of sophisticated functions ensuring superior reception and operation. All the functions have been designed for the easiest possible use, but many are not self-explanatory. This operation manual will help you benefit fully from this product's potential and to maximize your listening enjoyment.

We recommend that you familiarize yourself with the functions and their operation by reading through the manual before you begin using this unit. It is especially important that you read and observe precautions on this page and in other sections. 

Precautions

CAUTION:
USE OF CONTROL OR ADJUSTMENT OR PERFORMANCE OF PROCEDURES OTHER THAN THOSE SPECIFIED HEREIN MAY RESULT IN HAZARDOUS RADIATION EXPOSURE.

CAUTION:
THE USE OF OPTICAL INSTRUMENTS WITH THIS PRODUCT WILL INCREASE EYE HAZARD.

- Keep this manual handy as a reference for operating procedures and precautions.
- Always keep the volume low enough so you can hear sounds outside of the car.
- Protect this product from moisture.
- If the battery is disconnected or discharged, the preset memory will be erased and must be reprogrammed.
- If this unit does not operate properly, contact your dealer or nearest authorized Pioneer Service Station. 

Features

CD playback

Music CD/CD-R/CD-RW playback is possible.

MP3 file playback

It is possible to play back MP3 files recorded on CD-ROM/CD-R/CD-RW (ISO9660 Level 1/ Level 2 standard recordings).

- Supply of this product only conveys a license for private, non-commercial use and does not convey a license nor imply any right to use this product in any commercial (i.e. revenue-generating) real time broadcasting (terrestrial, satellite, cable and/or any other media), broadcasting/streaming via internet, intranets and/or other networks or in other electronic content distribution systems, such as pay-audio or audio-on-demand applications. An independent license for such use is required. For details, please visit <http://www.mp3licensing.com>.

WMA file playback

It is possible to play back WMA files recorded on CD-ROM/CD-R/CD-RW (ISO9660 Level 1/ Level 2 standard recordings).

Playback of MDs featuring long recordings

This unit is MDLP compatible, so you can playback MDs featuring long recordings.

- MDLP is a data compression system that lets you record on regular MDs for 2 or 4 times the length of time previously possible.

Group-recorded MD playback

Using a group-recorded MD, it is possible to playback tracks by the desired group (albums, artists, favorites, etc.). 

About WMA



The Windows Media™ logo printed on the box indicates that this unit can playback the WMA data.

WMA is short for Windows Media Audio and refers to an audio compression technology that is developed by Microsoft Corporation. WMA data can be encoded by using Windows Media Player version 7, 7.1 or Windows Media Player for Windows XP.

Microsoft, Windows Media, and the Windows logo are trademarks, or registered trademarks of Microsoft Corporation in the United States and/or other countries.



Notes

- With some applications used to encode WMA files, this unit may not operate correctly.
- With some applications used to encode WMA files, album names and other text information may not be correctly displayed. 

Switching the DSP setting mode

This unit features two operation modes: the 3-way network mode (NW) and the standard mode (STD). You can switch between modes as desired. Initially, the DSP setting is set to the standard mode (STD).

- After switching, reset the microprocessor.

WARNING

Do not use the unit in standard mode when a speaker system for 3-way network mode is connected to this unit. This may cause damage to the speakers.

- Use a thin standard tip screwdriver to switch the DSP switch on the side of this unit.

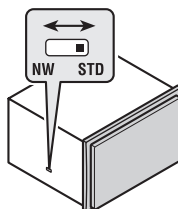

Resetting the microprocessor

The microprocessor must be reset under the following conditions:

- Prior to using this unit for the first time after installation
 - If the unit fails to operate properly
 - When strange or incorrect messages appear on the display
- Press **RESET** on the head unit with a pen tip or other pointed instrument.

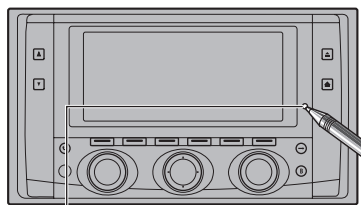

RESET button



Before You Start

About the demo mode

This unit features two demonstration modes. One is the reverse mode, the other is the feature demo mode.

- When the source is off, you can check the location of **5** and **6** by turning on the feature demo.



Important

The red lead (ACC) of this unit should be connected to a terminal coupled with ignition switch on/off operations. If this is not done, the vehicle battery may be drained.

Reverse mode

If you do not perform an operation within about 30 seconds, screen indications start to reverse, and then continue reversing every 10 seconds. Pressing **5** numbered button when power to this unit is turned off while the ignition switch is set to ACC or ON cancels the reverse mode. Pressing **5** numbered button again to start the reverse mode.

Feature demo

The feature demo automatically starts when power to this unit is turned off while the ignition switch is set to ACC or ON. Pressing **6** numbered button during feature demo operation cancels the feature demo mode. Pressing **6** numbered button again to start the feature mode. Remember that if the feature demo continues operating when the car engine is turned off, it may drain battery power. ▣

About basic displays

This unit is equipped with three forms of basic display. You can select the desired display.



FORM1



FORM2



FORM3

Note

For details, refer to *Changing the display form* on page 61. ▣

SOFT KEY operation

SOFT KEY operation means that the function of a button changes as indicated on the display. The multi-function buttons provide SOFT KEY operation; the functions performed by the buttons change according to the function or setting that has been selected.

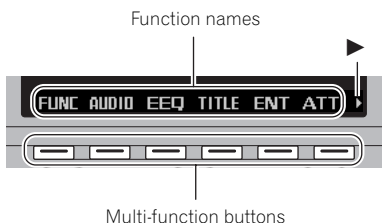

The explanations given in this manual are based on **FORM1** display. If you have selected **FORM2** or **FORM3**, the functions of some of the multi-function buttons may be different from those indicated in the manual.



Important

In this manual, for operations using the multi-function buttons the function displayed is used as the name of the function button.

Switching the function of the multi-function buttons

The ► indicator shows that the multi-function buttons have functions other than those currently displayed. When this indicator is visible, press **NEXT** to switch through the functions of the multi-function buttons.

● Press **NEXT** to display the desired functions (e.g., built-in CD player).

Press **NEXT** repeatedly to switch between the following functions:

FUNC AUDIO EEQ TITLE ENT ATT ►

PAUSE CLK C.MENU ►



Notes

- The number of functions or displays switched through will differ according to the source or menu selected.
- When no function is indicated for a button, that button is not currently active.

Example of multi-function button operation

Here the random play function of the built-in CD player is used as an example to illustrate operation of the multi-function buttons.

1 Press **NEXT** to display **FUNC**

Press **NEXT** until **FUNC** appears.

FUNC AUDIO EEQ TITLE ENT ATT ►

2 Press **FUNC** to enter the function menu.

With the switch to the function menu, the functions of the multi-function buttons also change simultaneously.

RPT RDM SCAN T.LIST PAUSE ►

3 Press **RDM** to select the random mode.



4 Press **RDM** to turn random play on.



The light illuminates.

- Press **RDM** again to turn random play off. The light goes off.

Before You Start

5 Press **BACK** to exit the function menu.

When the function menu is exited, the functions of the multi-function buttons also change simultaneously.



Notes

- You can also turn random play on or off by pressing **▲** or **▼** in the random mode.
- If you do not operate the function within about 30 seconds, the display is automatically returned.

The difference between the **BAND** button and the **BACK** button

BAND button

Pressing the **BAND** button immediately cancels the current menu or mode, and returns to the basic displays.

- When the source is the tuner or television and no menu or mode is selected, pressing the **BAND** button has the effect of switching bands.

BACK button

Pressing the **BACK** button cancels the current menu or mode and returns to the previously selected menu or mode.

Display example (e.g., built-in CD player)

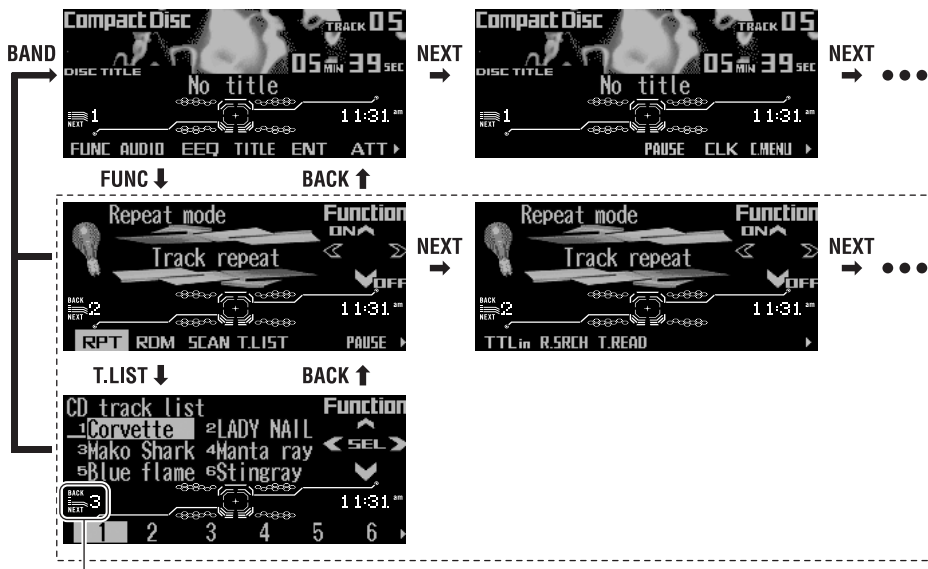

The number shows the current menu level.

Key guidance indicator

This unit's display features key guidance indicators. These light to indicate which of the ▲/▼/◀/▶ buttons you can use. When you're in the function menu, audio menu or the other menus, they also make it easy to see which ▲/▼/◀/▶ buttons you can use to switch functions on or off, switch repeat selections and perform other operations.



Key guidance indicators

Note

In this manual, operation for each mode is given mainly in terms of the multi-function buttons. However, in each mode, when the key guidance indicators are lit it is also possible to use ▲/▼/◀/▶ to operate the mode. □

Setting the display angle

You can adjust front panel angle for easier operation.

WARNING

- Do not use with the front panel left open. If you do leave it open, it may result in injury in the event of an accident.

Before You Start

- Be careful not to catch your finger in the front panel when it is opening or closing.
- **Press ANGLE to change the angle.**
Each press of **ANGLE** changes the angle.

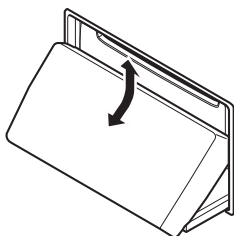

Notes

- While a disc is left partially inserted, you cannot operate the angle.
- By pressing **ANGLE** and hold, you can open or close the front panel. 

Use and care of the remote control

Installing the battery

Remove the cover on the back of the steering remote control and insert the battery with the plus (+) and minus (-) poles pointing in the proper direction.

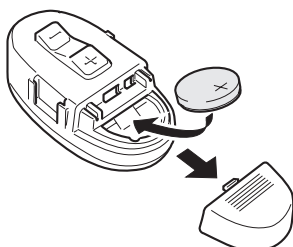

Replacing the battery

Remove the battery.

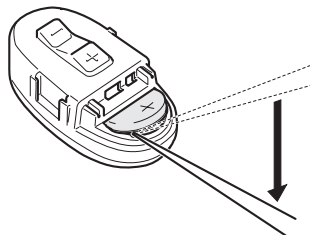

WARNING

Keep the battery out of the reach of children. Should the battery be swallowed, immediately consult a doctor.

CAUTION

- Use only one **CR2032 (3 V)** lithium battery.
- Remove the battery if the remote control is not used for a month or longer.
- Do not recharge, disassemble, heat or dispose of the battery in fire.
- Do not handle the battery with metallic tools.
- Do not store the battery with metallic materials.
- In the event of battery leakage, wipe the remote control completely clean and install a new battery.
- When disposing of used batteries, please comply with governmental regulations or environmental public institution's rules that apply in your country/area.

Using the remote control

Important

- Do not operate this unit while manipulating the steering wheel as it might result in a traffic accident.

- If you have to operate this unit unavoidably when driving, look ahead carefully to avoid the risk of being involved in a traffic accident.
- If any of the following troubles occur, immediately stop using this unit and consult with the dealer from whom you purchased it:
 - the unit is smoking.
 - the unit is emitting abnormal odor.
 - a foreign object has entered the unit.
 - liquid has been spilled on or into the unit.
 If you continue to use this unit without finding a remedy, the unit may be damaged badly, resulting in a serious accident or fire.
- Do not leave this unit free (unattached) inside the car. When the car stops or turns a curve, the unit might drop on the floor. If the unit rolls under the brake pedal, it might prevent the driver from braking well, causing serious trouble. Be sure to fix this unit to the steering wheel.
- Do not disassemble or modify this unit. To do so may cause a fault.

FUNCTION button and AUDIO button

Operation of the **FUNCTION** button and the **AUDIO** button on the remote control differs from the operation of the **FUNC** button and the **AUDIO** button on the head unit. When operating the head unit, use the **FUNC** button and the **AUDIO** button to select the appropriate menu, then use the multi-function buttons to select the mode. When operating the remote control, however, switch through the modes as described below to select the mode.

FUNCTION button operation

- Press **FUNCTION** to select the desired mode (e.g., built-in CD player).

Press **FUNCTION** repeatedly to switch between the following modes:

RPT—RDM—SCAN—T.LIST—PAUSE—TTLin—R.SRCH—T.READ



Note

Refer to *Introduction of advanced built-in CD player operation* on page 20.

AUDIO button operation

- Press **AUDIO** to select the desired mode.

Press **AUDIO** repeatedly to switch between the following modes:

NW

BAL—NW—POSI—T.AL—EQ 1—EQ 2—BBE—LOUD—ASL—SLA

STD

F/B—LOUD—SFC—EQ 1—EQ 2—ASL—POSI—T.AL—A.EQ—SW1—SW2—HPF F—HPF R—SLA



Note

Refer to *Introduction of audio adjustments* on page 44. □

What's What

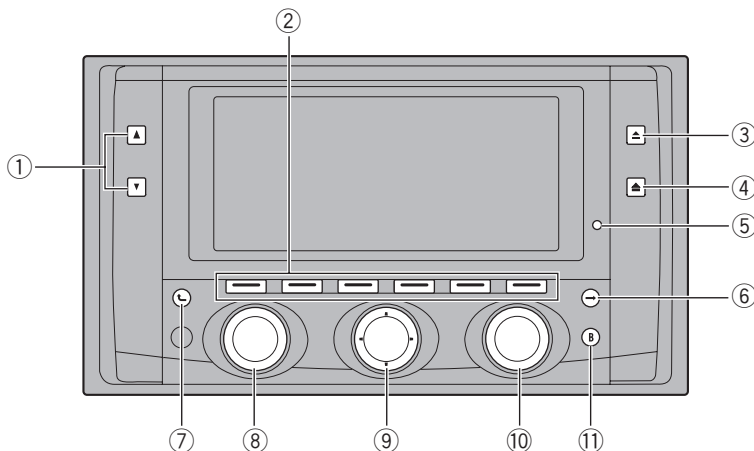

Head unit

① ANGLE button

Press to change the display angle.

② Multi-function buttons

Change according to the function or setting that has been selected.

③ CD EJECT button

Press to eject a CD from your built-in CD player.

④ MD EJECT button

Press to eject a MD from your built-in MD player.

⑤ RESET button

Press to reset the microprocessor.

⑥ NEXT button

Press to switch through the functions of multi-function buttons.

⑦ BACK button

Press to return to the previously mode.

⑧ SOURCE selector

This unit is turned on by selecting a source. When you press **SOURCE**, it extends outward so that it becomes easier to turn. To retract **SOURCE**, press it again. Rotate to cycle through all of the available sources.

⑨ ▲/▼/◀/▶ buttons

Press to do manual seek tuning, fast forward, reverse and track search controls. Also used for controlling functions.

⑩ VOLUME

When you press **VOLUME**, it extends outward so that it becomes easier to turn. To retract **VOLUME**, press it again. Rotate to increase or decrease the volume.

⑪ BAND button

Press to select among three FM and one AM bands and cancel the control mode of functions.

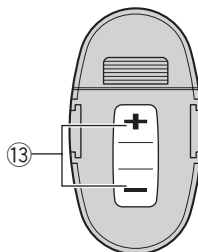
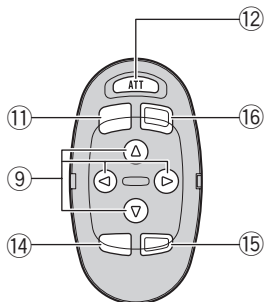

Remote control

Operation is the same as when using the button on the head unit.

⑫ **ATT button**

Press to quickly lower the volume level, by about 90%. Press once more to return to the original volume level.

⑬ **VOLUME button**

Press to increase or decrease the volume.

⑭ **FUNCTION button**

Press to select functions.

⑮ **AUDIO button**

Press to select various sound quality controls.

⑯ **SOURCE button**

This unit is turned on by selecting a source. Press to cycle through all of the available sources.



Note

If you press **FUNCTION** on the remote control while pressing **BAND** on it, the remote control will not function properly. To cancel this setting, press **AUDIO** on the remote control while press-

ing **BAND** on it to return to the previous setting. ■

Power ON/OFF

Turning the unit on

- **Rotate SOURCE on the head unit to turn the unit on.**

When you select a source the unit is turned on.

- When using the remote control, press **SOURCE** to turn the unit on. 

Selecting a source

You can select a source you want to listen to. To switch to the built-in CD player, load a CD in this unit (refer to page 19). To switch to the built-in MD player, load an MD in this unit (refer to page 28).

- **Rotate SOURCE on the head unit to select a source.**

Rotate **SOURCE** repeatedly to switch between the following sources:

Tuner—Television—DVD player/Multi-DVD player—Built-in CD player—Multi-CD player—Built-in MD player—External unit 1—External unit 2—AUX—Sources off

- When using the remote control, press **SOURCE** repeatedly.



Notes

- In the following cases, the sound source will not change:
 - When a unit corresponding to each source is not connected to this unit.
 - When no disc is set in this unit.
 - When no disc is set in the DVD player.
 - When no magazine is set in the multi-CD player.
 - When no magazine is set in the multi-DVD player.
 - When the AUX (auxiliary input) is set to off (refer to page 57).
- External unit refers to a Pioneer product (such as one available in the future) that, although

incompatible as a source, enables control of basic functions by this unit. Two external units can be controlled by this unit. When two external units are connected, the allocation of them to external unit 1 or external unit 2 is automatically set by this unit.

- When this unit's blue lead is connected to the car's auto-antenna relay control terminal, the car's antenna extends when this unit's selected source is the tuner. To retract the antenna, switch to a source other than tuner. 

Turning the unit off

- **Rotate SOURCE on the head unit until the unit turns off.**

When using the remote control, press **SOURCE** and hold until the unit turns off. 

Listening to the radio

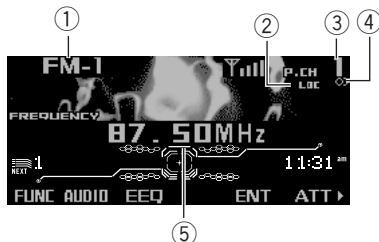

FORM1

These are the basic steps necessary to operate the radio. More advanced tuner operation is explained starting on this page.

Important

If you are using this unit in North, Central or South America, reset the AM tuning step (see *Setting the AM tuning step* on page 58).

- ① **Band indicator**
Shows which band the radio is tuned to, AM or FM.
- ② **LOC indicator**
Shows when local seek tuning is on.
- ③ **Preset number indicator**
Shows what preset has been selected.
- ④ **Stereo (CD) indicator**
Shows that the frequency selected is being broadcast in stereo.
- ⑤ **Frequency indicator**
Shows to which frequency the tuner is tuned.

1 Rotate SOURCE to select the tuner.
Rotate **SOURCE** until you see **Tuner** displayed.

2 Use VOLUME to adjust the sound level.
Rotate to increase or decrease the volume.

3 Press BAND to select a band.
Press **BAND** until the desired band is displayed, **FM-1**, **FM-2**, **FM-3** for FM or **AM**.

4 To perform manual tuning, press ◀ or ▶ with quick presses.
The frequencies move up or down step by step.

5 To perform seek tuning, press and hold ◀ or ▶ for about one second and release.
The tuner will scan the frequencies until a broadcast strong enough for good reception is found.

- You can cancel seek tuning by pressing either ◀ or ▶ with a quick press.
- If you press and hold ◀ or ▶ you can skip broadcasting stations. Seek tuning starts as soon as you release the buttons. 

Introduction of advanced tuner operation

The tuner function menu has the following functions:

BSM (best stations memory)—**chLIST** (channel list)—**LOC** (local seek tuning)

BSM chLIST LOC



Note

If you do not operate the function within about 30 seconds, the display is automatically returned. 

Storing and recalling broadcast frequencies

If you press any of the preset tuning buttons **1–6** you can easily store up to six broadcast frequencies for later recall with the touch of a button.

1 Press NEXT to display 1–6.

Press **NEXT** until **1–6** appears in the display.

2 When you find a frequency that you want to store in memory press a preset tuning button 1–6 and hold until the preset number stops flashing.

The number you have pressed will flash in the preset number indicator and then remain lit. The selected radio station frequency has been stored in memory.

The next time you press the same preset tuning button **1–6** the radio station frequency is recalled from memory.



Notes

- Up to 18 FM stations, 6 for each of the three FM bands, and 6 AM stations can be stored in memory.
- You can also use ▲ and ▼ to recall radio station frequencies assigned to preset tuning buttons **1–6**. □

Tuning in strong signals

Local seek tuning lets you tune in only those radio stations with sufficiently strong signals for good reception.

1 Press FUNC and then press LOC to select the local mode.

2 Press LOC to set the local seek sensitivity.

Press **LOC** repeatedly to switch between the following settings:

FM: **Local OFF—Level 1—Level 2—Level 3—Level 4**

AM: **Local OFF—Level 1—Level 2**

The **Level 4** setting allows reception of only the strongest stations, while lower settings let you receive progressively weaker stations. □

Storing the strongest broadcast frequencies

BSM (best stations memory) lets you automatically store the six strongest broadcast frequencies under preset tuning buttons **1–6** and once stored there you can tune in to those frequencies with the touch of a button.

1 Press FUNC to select BSM mode.

2 Press BSM to turn BSM on.

Searching appears. The six strongest broadcast frequencies will be stored under preset tuning buttons **1–6** in order of their signal strength.

When finished, **Searching** disappears and the display switches to the preset channel list mode.

- To cancel the storage process, press **BSM** again.



Note

Storing broadcast frequencies with BSM may replace broadcast frequencies you have saved using **1–6**. □

Selecting stations from the preset channel list

The preset channel list lets you see the list of preset stations and select one of them to receive.

- 1 Press **FUNC** and then press **chLIST** to select the preset channel list mode.
- 2 Press any of the buttons **1–6** to recall the desired station frequency.



Note

You can also use **◀**, **▶** and **▲** to select and recall the desired station. **◻**

Built-in CD Player

Playing a CD



FORM1

These are the basic steps necessary to play a CD with your built-in CD player. More advanced CD operation is explained starting on the next page.

! WARNING

Do not use with the front panel left open, after ejecting a CD. If you do leave it open, it may result in injury in the event of an accident.

① Play time indicator

Shows the elapsed playing time of the current track.

② Track number indicator

Shows the track currently playing.

1 Press **CD EJECT**.

CD loading slot appears.

- After a CD has been inserted, rotate **SOURCE** to select the built-in CD player.

2 Insert a CD into the CD loading slot.

Front panel is closed automatically, and playback will start.

CD loading slot

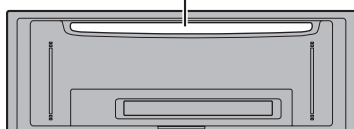

- You can eject a CD by pressing **CD EJECT**.

3 Use **VOLUME** to adjust the sound level.

Rotate to increase or decrease the volume.

4 To perform fast forward or reverse, press and hold **◀** or **▶**.

- If you select the search method to **Rough search**, pressing and holding **◀** or **▶** enables you to search every ten track in the current disc. (Refer to *Selecting the search method* on page 21.)

5 To skip back or forward to another track, press **◀** or **▶**.

Pressing **▶** skips to the start of the next track. Pressing **◀** once skips to the start of the current track. Pressing again will skip to the previous track.



Notes

- The built-in CD player plays one, standard, 12-cm or 8-cm (single) CD at a time. Do not use an adapter when playing 8-cm CDs.
- Do not insert anything other than a CD into the CD loading slot.
- A CD left partially inserted after ejection may incur damage or fall out.
- If you cannot insert a disc completely or if after you insert a disc the disc does not play, check that the label side of the disc is up. Press **CD EJECT** to eject the disc, and check the disc for damage before inserting the disc again.
- If the built-in CD player does not operate properly, an error message such as **ERROR-11** may be displayed. Refer to *Understanding built-in CD player error messages* on page 65.
- When a CD TEXT disc is inserted, the disc and track titles begin to scroll to the left automatically. 

Introduction of advanced built-in CD player operation

The built-in CD player function menu has the following functions:

RPT (repeat play)—**RDM** (random play)
 —**SCAN** (scan play)—**T.LIST** (track title list)
 —**PAUSE** (pause)—**TTLin** (disc title input)
 —**R.SRCH** (search method)—**T.READ** (tag display)



Notes

- If you do not operate the function within about 30 seconds, the display is automatically returned.
 (When you select the disc title input mode (**TTLin**), the display is not returned automatically.)
- **T.LIST** is displayed only when playing a CD TEXT disc.

Repeating play

Repeat play lets you hear the same track over again.

1 Press FUNC to select the repeat mode.

2 Press RPT to turn the repeat play on.

The light illuminates. The track currently playing will play and then repeat.

- To turn repeat play off, press **RPT** again.



Notes

- If you perform track search or fast forward/reverse, repeat play is automatically cancelled.
- When the repeat mode is exited while repeat play is on, **T.RPT** appears on the basic display.

Playing tracks in a random order

Random play lets you play back tracks on the CD in a random order.

1 Press FUNC and then press RDM to select the random mode.

2 Press RDM to turn random play on.

The light illuminates. Tracks will play in a random order.

- To turn random play off, press **RDM** again.



Note

When the random mode is exited while random play is on, **RDM** appears on the basic display.

Scanning tracks of a CD

Scan play lets you hear the first 10 seconds of each track on the CD.

1 Press FUNC and then press SCAN to select the scan mode.

2 Press SCAN to turn scan play on.

The light illuminates. The first 10 seconds of each track is played.

3 When you find the desired track press SCAN to turn scan play off.

The light goes off. The track will continue to play.

- If the scan mode is automatically canceled, select the scan mode again.



Notes

- After scanning of a CD is finished, normal playback of the tracks will begin again.
- When the scan mode is exited while scan play is on, **SCAN** appears on the basic display.

Built-in CD Player

Selecting tracks from the track title list

The track title list lets you see the list of track titles on a CD TEXT disc and select one of them for playback.

1 Press FUNC and then press T.LIST to select the track title list mode.

2 Press NEXT to display the desired track title.

Press **NEXT** until the desired track title appears.



3 Press the corresponding number button to select the desired track title.

That selection will begin to play.



Notes

- You can also use **◀**, **▶** and **▲** to select and play the desired track title.
- Only when playing a CD TEXT disc, you can switch to this mode.

Pausing CD playback

Pause lets you temporarily stop playback of the CD.

1 Press FUNC and then press PAUSE to select the pause mode.

2 Press PAUSE to turn pause on.

The light illuminates. Play of the current track pauses.

- To turn the pause off, press **PAUSE** again.



Note

You can also turn pause on or off by pressing **PAUSE** in the following display.

PAUSE CLK C.MENU

Selecting the search method

You can switch the search method between fast forward/reverse and searching every 10 track.

1 Press FUNC and NEXT and then press R.SRCH to select the search method mode.

2 Press R.SRCH to select the search method.

Press **R.SRCH** until the desired search method appears in the display.

- FF/REV** – Fast forward and reverse
- Rough search** – Searching every 10 track

Searching every 10 track in the current disc

If a disc contains over 10 tracks, you can search every 10 track. When a disc contains a lot of tracks, you can roughly search the track you want to play.

1 Select the search method Rough search.

Refer to *Selecting the search method* on this page.

2 Press and hold ◀ or ▶ to search every 10 track in a disc.

- If a disc contains less than 10 tracks, pressing and holding ▶ recalls the last track of a disc. Also, if the remaining number of tracks after searching every 10 tracks are less than 10, pressing and holding ▶ recalls the last track of a disc.
- If a disc contains less than 10 tracks, pressing and holding ◀ recalls the first track of a disc. Also, if the remaining number of tracks after searching every 10 tracks are less than 10, pressing and holding ◀ recalls the first track of a disc. ▣

Entering disc titles

Disc title input lets you input CD titles up to 10 letters long and up to 48 disc titles into this unit.

If you input a CD title, the entered title is displayed. For details of operation, refer to *Entering disc titles* on page 36 under Multi-CD Player.



Notes

- When playing a CD TEXT disc, if you switch to this mode, **Can't input** is displayed and you cannot input the title.
- Titles remain in memory, even after the disc has been removed from this unit, and are recalled when the disc is reinserted.
- After data for 48 discs has been stored in memory, data for a new disc will overwrite the oldest one.
- If you connect a multi-CD player, you can input disc titles for up to 100 discs. ▣

Using disc title functions

When playing a CD TEXT disc, you can switch text display such as artist name and track title. When the text is longer than 32 letters, you

can scroll the text to the left so that the rest of the title can be seen.

1 Press TITLE to switch the title mode.

2 Press the corresponding button to display the desired title.

FORM1 and FORM3

Button	Operation
D.TTL	Displays disc title.
D.ART	Displays disc artist name.
T.TTL	Displays track title.
T.ART	Displays track artist name.
SCROLL	Scrolls the displayed title.

FORM2

Button	Operation
TTL1	Displays disc title and track title.
TTL2	Displays disc title and disc artist name.
TTL3	Displays track title and track artist name.
SCROLL	Scrolls the displayed title.



Notes

- If you do not operate the function within about eight seconds, the display is automatically returned.
- You cannot use ◀ or ▶ to select a track in title mode.
- When you select the display **FORM2**, the titles are displayed up to 24 letters long.
- A CD TEXT disc is a CD featuring recorded text information such as disc title, artist name and track title.
- If specific information has not been recorded on a CD TEXT disc, **No xxxx** will be displayed (e.g., **No artist name**).
- If no title has been entered for the currently playing disc, **No title** is displayed. ▣

MP3/WMA Player

Playing a MP3/WMA

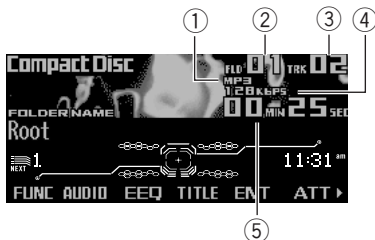

FORM1

These are the basic steps necessary to play an MP3/WMA with your built-in CD player. More advanced MP3/WMA operation is explained starting on the next page.

! WARNING

Do not use with the front panel left open, after ejecting a CD-ROM. If you do leave it open, it may result in injury in the event of an accident.

- ① **MP3/WMA indicator**
Shows when the MP3/WMA file is playing.
- ② **Folder number indicator**
Shows the folder number currently playing.
- ③ **Track number indicator**
Shows the track (file) currently playing.
- ④ **Bit rate indicator**
- ⑤ **Play time indicator**
Shows the elapsed playing time of the current track (file).

1 Press CD EJECT.

CD loading slot appears.

- After a CD-ROM has been inserted, rotate **SOURCE** to select the built-in CD player.

2 Insert a CD-ROM into the CD loading slot.

Front panel is closed automatically, and playback will start.

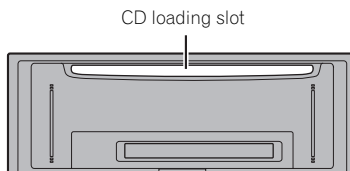

- You can eject a CD-ROM by pressing **CD EJECT**.

3 Use VOLUME to adjust the sound level.

Rotate to increase or decrease the volume.

4 Press ▲ or ▼ to select a folder.

- You cannot select a folder that does not have an MP3/WMA file recorded in it.
- To return to folder 01 (ROOT), press and hold **BAND**. However, if folder 01 (ROOT) contains no files, playback commences with folder 02.

5 To perform fast forward or reverse, press and hold ◀ or ▶.

- This is fast forward and reverse operation only for the file being played. This operation is canceled when the previous or next file is reached.
- If you select the search method to **Rough search**, pressing and holding ◀ or ▶ enables you to search every ten track in the current folder. (Refer to *Selecting the search method* on page 26.)

6 To skip back or forward to another track, press ◀ or ▶.

Pressing ▶ skips to the start of the next track. Pressing ◀ once skips to the start of the current track. Pressing again will skip to the previous track.

**Notes**

- When playing discs with MP3/WMA files and audio data (CD-DA) such as CD-EXTRA and MIXED-MODE CDs, both types can be played only by switching mode between MP3/WMA and CD-DA with **BAND**.
- If you have switched between playback of MP3/WMA files and audio data (CD-DA), playback starts at the first track on the disc.
- The built-in CD player can play back an MP3/WMA file recorded on CD-ROM. (Refer to page 67 for files that can be played back.)
- Do not insert anything other than a CD into the CD loading slot.
- A CD left partially inserted after ejection may incur damage or fall out.
- There is sometimes a delay between starting up playback and the sound being issued. This is particularly the case when playing back multi-session and many folders. When being read in, **Format read** is displayed.
- If you cannot insert a disc completely or if after you insert a disc the disc does not play, check that the label side of the disc is up. Press **CD EJECT** to eject the disc, and check the disc for damage before inserting the disc again.
- Playback is carried out in order of file number. Folders are skipped if they contain no files. (If folder 01 (ROOT) contains no files, playback commences with folder 02.)
- When playing back files recorded as VBR (variable bit rate) files, the play time will not be correctly displayed if fast forward or reverse operations are used.
- If inserted disc contains no files that can be played back, **No Audio** is displayed.
- There is no sound on fast forward or reverse.
- If the built-in CD player does not operate properly, an error message such as **ERROR-11** may be displayed. Refer to *Understanding built-in CD player error messages* on page 65.

- When an MP3/WMA disc is inserted, folder name and file name begin to scroll to the left automatically.

Introduction of advanced built-in CD player (MP3/WMA) operation

The MP3/WMA function menu has the following functions:

- RPT** (repeat play)—**RDM** (random play)
- SCAN** (scan play)—**F.LIST** (folder title list)
- PAUSE** (pause)—**TTLin** (disc title input)
- R.SRCH** (search method)—**T.READ** (tag display)

RPT RDM SCAN F.LIST PAUSE ▾

TTLin R.SRCH T.READ ▾

**Notes**

- If you do not operate the function within about 30 seconds, the display is automatically returned.
(When you select the disc title input mode (**TTLin**), the display is not returned automatically.)
- When playing a CD-ROM disc, if you switch to the disc title input mode (**TTLin**), **Can't input** is displayed and you cannot input the title.

Repeating play

For MP3/WMA playback, there are three repeat play ranges: **Folder repeat** (folder repeat), **Track repeat** (one-track repeat) and **Disc repeat** (repeat all tracks).

- 1 Press **FUNC** to select the repeat mode.

MP3/WMA Player

2 Press RPT to select the repeat range.

Press **RPT** until the desired repeat range appears in the display.

- **Folder repeat** – Repeat the current folder
- **Track repeat** – Repeat just the current track
- **Disc repeat** – Repeat all tracks



Notes

- If you select other folder during repeat play, the repeat play range changes to **Disc repeat**.
- If you perform track search or fast forward/reverse during **Track repeat**, the repeat play range changes to **Folder repeat**.
- When **Folder repeat** is selected, it is not possible to play back a subfolder of that folder.
- When the repeat mode is exited, either **T.RPT** (one-track repeat) or **FOLDER PRT** (folder repeat) may appear on the basic display.

Playing tracks in a random order

Random play lets you play back tracks in a random order within the repeat range, **Folder repeat** and **Disc repeat**.

1 Select the repeat range.

Refer to *Repeating play* on the previous page.

2 Press FUNC and then press RDM to select the random mode.

3 Press RDM to turn random play on.

The light illuminates. Tracks will play in a random order within the previously selected **Folder repeat** or **Disc repeat** ranges.

- To turn random play off, press **RDM** again.



Note

When the random mode is exited while random play is on, **RDM** appears on the basic display.

Scanning folders and tracks

While you are using **Folder repeat**, the beginning of each track in the selected folder plays for about 10 seconds. When you are using **Disc repeat**, the beginning of the first track of each folder is played for about 10 seconds.

1 Select the repeat range.

Refer to *Repeating play* on the previous page.

2 Press FUNC and then press SCAN to select the scan mode.

3 Press SCAN to turn scan play on.

The light illuminates. The first 10 seconds of each track of the current folder (or the first track of each folder) is played.

4 When you find the desired track (or folder) press SCAN to turn scan play off.

The light goes off. The track (or folder) will continue to play.

- If the scan mode is automatically canceled, select the scan mode again.



Notes

- After track or folder scanning is finished, normal playback of the tracks will begin again.
- When the scan mode is exited while scan play is on, **SCAN** appears on the basic display.

Pausing MP3/WMA playback

Pause lets you temporarily stop playback of the MP3/WMA.

1 Press FUNC and then press PAUSE to select the pause mode.

2 Press PAUSE to turn pause on.

The light illuminates. Play of the current track pauses.

- To turn the pause off, press **PAUSE** again.

Note

You can also turn pause on or off by pressing **PAUSE** in the following display.



Selecting folders from the folder title list

Folder title list lets you see the list of folder titles and select one of them to playback.

1 Press FUNC and then press F.LIST to select folder title list mode.

2 Press NEXT to display the desired folder title.

Press **NEXT** until the desired folder title appears.



This indication shows the number of files in the selected folder. If selected folder contains no files, nothing will be displayed.

3 Press the corresponding number button to select the desired folder title.

That selection will begin to play.

Note

You can also use **◀**, **▶** and **▲** to select and play the desired folder title. 

Selecting the search method

You can switch the search method between fast forward/reverse and searching every 10 track.

1 Press FUNC and NEXT and then press R.SRCH to select the search method mode.

2 Press R.SRCH to select the search method.

Press **R.SRCH** until the desired search method appears in the display.

- **FF/REV** – Fast forward and reverse
- **Rough search** – Searching every 10 track 

Searching every 10 track in the current folder

If the current folder contains over 10 tracks, you can search every 10 track. When the one folder contains a lot of tracks, you can roughly search the track you want to play.

1 Select the search method Rough search.

Refer to *Selecting the search method* on this page.

2 Press and hold ◀ or ▶ to search every 10 track in the current folder.

- If the current folder contains less than 10 tracks, pressing and holding **▶** recalls the last track of the folder. Also, if the remaining number of tracks after searching every 10 tracks are less

MP3/WMA Player

than 10, pressing and holding ► recalls the last track of the folder.

- If the current folder contains less than 10 tracks, pressing and holding ◀ recalls the first track of the folder. Also, if the remaining number of tracks after searching every 10 tracks are less than 10, pressing and holding ◀ recalls the first track of the folder. ◻

Switching the tag display

It is possible to turn the tag display on or off, if MP3/WMA disc contains the text information such as track title and artist name.

- If you turn the tag display off, time to playback will be shorter than when this function is turned on.

1 Press FUNC and NEXT and then press T.READ to select the tag display mode.

2 Press T.READ to turn tag display on.

- To turn the tag display off, press T.READ again.



Note

When you turn the tag display on, this unit returns to the beginning of the current track in order to read the text information. ◻

Using disc title functions

You can switch text display such as artist name and track title. When the text is longer than 32 letters, you can scroll the text to the left so that the rest of the title can be seen.

1 Press TITLE to switch the title mode.

2 Press the corresponding button to display the desired title.

FORM1 and FORM3

Button	Operation
FOLDER	Displays folder name.
FILE	Displays file name.
ALBUM	Displays album title.
T.TTL	Displays track title.
ARTIST	Displays track artist name.
SCROLL	Scrolls the displayed title.

FORM2

Button	Operation
F+FIL	Displays folder name and file name
FIL+T	Displays file name and track title.
ALB+T	Displays album title and track title.
TR+ART	Displays track title and track artist name.
SCROLL	Scrolls the displayed title.



Notes

- If you do not operate the function within about eight seconds, the display is automatically returned.
- You cannot use ▲/▼/◀/▶ to select a folder or track in title mode.
- When you select the display **FORM2**, the titles are displayed up to 24 letters long.
- If specific information has not been recorded on a MP3/WMA disc, **No xxxx** will be displayed (e.g., **No album title**).
- With some applications used to encode WMA files, album names and other text information may not be correctly displayed. ◻

Playing an MD

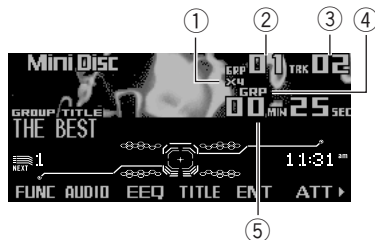

FORM1

These are the basic steps necessary to play an MD with your built-in MD player. More advanced MD operation is explained starting on the next page.

! WARNING

Do not use with the front panel left open, after ejecting an MD. If you do leave it open, it may result in injury in the event of an accident.

- ① **MDLP indicator (x2 or x4)**
Shows when an MD featuring long recording is playing.
- ② **Group number indicator**
Shows the group currently playing.
- ③ **Track number indicator**
Shows the track currently playing.
- ④ **GRP indicator**
Shows when a group-recorded MD is playing.
- ⑤ **Play time indicator**
Shows the elapsed playing time of the current track.

1 Press MD EJECT.

MD loading slot appears.

- After an MD has been inserted, rotate

SOURCE to select the built-in MD player.

2 Insert an MD into the MD loading slot.

Front panel is closed automatically, and playback will start.

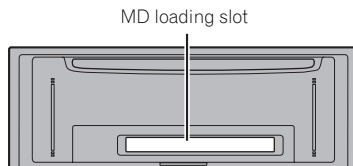

- You can eject an MD by pressing **MD EJECT**.

3 Use VOLUME to adjust the sound level.

Rotate to increase or decrease the volume.

4 When playing a group-recorded MD, press ▲ or ▼ to select a group.

5 To perform fast forward or reverse, press and hold ◀ or ▶.

6 To skip back or forward to another track, press ◀ or ▶.

Pressing ▶ skips to the start of the next track. Pressing ◀ once skips to the start of the current track. Pressing again will skip to the previous track.

✎ Notes

- Do not insert anything other than an MD into the MD loading slot.
- An MD left partially inserted after ejection may incur damage or fall out.
- Load an MD after confirming the MD shutter (refer to *MD player and care* on page 69) is closed.
- When you load a disc, this unit reads information recorded on the disc such as the number of tracks. While the disc is being read, **TOC read** is indicated in the display.
- If the built-in MD player does not operate properly, an error message such as **ERROR-11** may be displayed. Refer to *Understanding built-in MD player error messages* on page 65.

Built-in MD Player

- When you play MDs featuring long recordings, **x2** or **x4** indicator is displayed.
- When an MD is inserted, the disc (or group) and track titles begin to scroll to the left automatically. 

Introduction of advanced built-in MD player operation

The built-in MD player function menu has the following functions:

RPT (repeat play)—**RDM** (random play)
—**SCAN** (scan play)—**T.LIST** (track title list)
—**G.LIST** (group title list)—**PAUSE** (pause)

RPT RDM SCAN T.LIST G.LIST PAUSE

Notes

- If you do not operate the function within about 30 seconds, the display is automatically returned.
- **G.LIST** is displayed only when playing a group-recorded MD. 

Repeating play

Non group-recorded MD

Repeat play lets you hear the same track over again.

1 Press FUNC to select the repeat mode.

2 Press RPT to turn the repeat play on.

The light illuminates. The track currently playing will play and then repeat.

- To turn repeat play off, press **RPT** again.

Notes

- If you perform track search or fast forward/reverse, repeat play is automatically cancelled.
- When the repeat mode is exited while repeat play is on, **T.RPT** appears on the basic display.

Group-recorded MD

For group-recorded MD playback, there are three repeat play ranges: **Group repeat** (group repeat), **Track repeat** (one-track repeat) and **Disc repeat** (repeat all tracks).

1 Press FUNC to select the repeat mode.

2 Press RPT to select the repeat range.

Press **RPT** until the desired repeat range appears in the display.

- **Group repeat** – Repeat the current group
- **Track repeat** – Repeat just the current track
- **Disc repeat** – Repeat all tracks



Notes

- If you select other group during repeat play, the repeat play range changes to **Disc repeat**.
- If you perform track search or fast forward/reverse during **Track repeat**, the repeat play range changes to **Group repeat**.
- When the repeat mode is exited, either **T.RPT** (one-track repeat) or **GRP RPT** (group repeat) may appear on the basic display. 

Playing tracks in a random order

Random play lets you play back tracks on the MD in a random order.

- When playing a group-recorded MD, random play lets you play back tracks in a random order within the repeat range, **Group repeat** and **Disc repeat**.

1 Press FUNC and then press RDM to select the random mode.

2 Press RDM to turn random play on.

The light illuminates. Tracks will play in a random order.

- To turn random play off, press **RDM** again.

Note

When the random mode is exited while random play is on, **RDM** appears on the basic display. 

Scanning tracks of a MD

Scan play lets you hear the first 10 seconds of each track on the MD.

- When playing a group-recorded MD, while you are using **Group repeat**, the beginning of each track in the selected group plays for about 10 seconds. When you are using **Disc repeat**, the beginning of the first track of each group is played for about 10 seconds.

1 Press FUNC and then press SCAN to select the scan mode.

2 Press SCAN to turn scan play on.

The light illuminates. The first 10 seconds of each track is played.

- When playing a group-recorded MD, the first 10 seconds of each track of the current group (or the first track of each group) is played.

3 When you find the desired track (or group) press SCAN to turn scan play off.

The light goes off. The track (or group) will continue to play.

- If the scan mode is automatically canceled, select the scan mode again.

Notes

- After scanning of an MD is finished, normal playback of the tracks will begin again.
- When the scan mode is exited while scan play is on, **SCAN** appears on the basic display. 

Selecting tracks from the track title list

The track title list lets you see the list of track titles on an MD and select one of them for playback.

1 Press FUNC and then press T.LIST to select the track title list mode.

2 Press NEXT to display the desired track title.

Press **NEXT** until the desired track title appears.



3 Press the corresponding number button to select the desired track title.

That selection will begin to play.

Note

You can also use **◀**, **▶** and **▲** to select and play the desired track title. 

Selecting groups from the group title list

Group title list lets you see the list of group titles and select one of them to playback.

1 Press FUNC and then press G.LIST to select group title list mode.

2 Press NEXT to display the desired group title.

Press **NEXT** until the desired group title appears.

Built-in MD Player



This indication shows the number of tracks in the selected group.

3 Press the corresponding number button to select the desired group title.

That selection will begin to play.



Note

You can also use ◀, ▶ and ▲ to select and play the desired group title. ◻

Pausing MD playback

Pause lets you temporarily stop playback of the MD.

1 Press FUNC and then press PAUSE to select the pause mode.

2 Press PAUSE to turn pause on.

The light illuminates. Play of the current track pauses.

- To turn the pause off, press **PAUSE** again.



Note

You can also turn pause on or off by pressing **PAUSE** in the following display. ◻



Using disc title functions

When playing an MD, you can switch text display such as disc title and track title. When the text is longer than 32 letters, you can scroll the text to the left so that the rest of the title can be seen.

1 Press TITLE to switch the title mode.

2 Press the corresponding button to display the desired title.

FORM1 and FORM3

Button	Operation
D.TTL	Displays disc title.
G.TTL	Displays group title.
T.TTL	Displays track title.
SCROLL	Scrolls the displayed title.

FORM2

Button	Operation
TTL1	Displays group title and track title.
TTL2	Displays disc title and track title.
SCROLL	Scrolls the displayed title.



Notes

- If you do not operate the function within about eight seconds, the display is automatically returned.
- You cannot use ▲/▼/◀/▶ to select a group or track in title mode.
- When you select the display **FORM2**, the titles are displayed up to 24 letters long.
- If no title has been entered for the currently playing disc, **No title** is displayed.
- **G.TTL**, **TTL1** and **TTL2** are displayed only when playing a group-recorded MD. ◻

Playing a CD



FORM1

You can use this unit to control a multi-CD player, which is sold separately.

These are the basic steps necessary to play a CD with your multi-CD player. More advanced CD operation is explained starting on the next page.

① Disc number indicator

Shows the disc currently playing.

② Track number indicator

Shows the track currently playing.

③ Play time indicator

Shows the elapsed playing time of the current track.

1 Rotate SOURCE to select the multi-CD player.

Rotate **SOURCE** until you see **Multi-CD** displayed.

2 Use VOLUME to adjust the sound level.

Rotate to increase or decrease the volume.

3 Press ▲ or ▼ to select a disc.

A disc number for which there is no disc will be skipped.

- You can use the buttons **1-6** (or **7-12**) to select a disc directly.

4 To perform fast forward or reverse, press and hold ◀ or ▶.

5 To skip back or forward to another track, press ◀ or ▶.

Pressing **▶** skips to the start of the next track. Pressing **◀** once skips to the start of the current track. Pressing again will skip to the previous track.



Notes

- When the multi-CD player performs the preparatory operations, **Ready** is displayed.
- If the multi-CD player does not operate properly, an error message such as **ERROR-11** may be displayed. Refer to the multi-CD player owner's manual.
- If there are no discs in the multi-CD player magazine, **No disc** is displayed.
- When you select a CD TEXT disc on a CD TEXT compatible multi-CD player, the disc and track titles begin to scroll to the left automatically.

50-disc multi-CD player

Only those functions described in this manual are supported for 50-disc multi-CD players.

Selecting a disc directly

You can use the buttons **1-6** (or **7-12**) to select a disc directly.

1 Press NEXT to display 1-6 (or 7-12).

Press **NEXT** until **1-6** (or **7-12**) appears.

2 Press any of the buttons 1-6 (or 7-12) to select a disc located at 1 to 6 (or 7 to 12).

Multi-CD Player

Note

You cannot display **7–12** when a 6-disc multi-CD player is connected. 

Introduction of advanced multi-CD player operation

The multi-CD player function menu has the following functions:

RPT (repeat play)—**RDM** (random play)
—**SCAN** (scan play)—**T.LIST** (track title list)
—**D.LIST** (disc title list)—**PAUSE** (pause)
—**TTLin** (disc title input)—**COMP** (compression and DBE)—**ITS.P** (ITS play)—**ITS.M** (ITS programming)

RPT RDM SCAN T.LIST D.LIST PAUSE 

TTLin COMP ITS.P ITS.M 

Notes

- If you do not operate the function within about 30 seconds, the display is automatically returned.
(When you select the disc title input mode (**TTLin**) or ITS programming mode (**ITS.M**), the display is not returned automatically.)
- T.LIST** is displayed only when playing a CD TEXT disc on a CD TEXT compatible multi-CD player. 

Repeating play

There are three repeat play ranges for the multi-CD player: **Magazine repeat** (multi-CD player repeat), **Track repeat** (one-track repeat) and **Disc repeat** (disc repeat).

1 Press FUNC to select the repeat mode.

2 Press RPT to select the repeat range.

Press **RPT** until the desired repeat range appears in the display.

- Magazine repeat** – Repeat all discs in the multi-CD player
- Track repeat** – Repeat just the current track
- Disc repeat** – Repeat the current disc

Notes

- If you select other discs during repeat play, the repeat play range changes to **Magazine repeat**.
- If you perform track search or fast forward/reverse during **Track repeat**, the repeat play range changes to **Disc repeat**.
- When the repeat mode is exited, either **T.RPT** (one-track repeat) or **D.RPT** (disc repeat) may appear on the basic display. 

Playing tracks in a random order

Random play lets you play back tracks in a random order within the repeat range, **Magazine repeat** and **Disc repeat**.

1 Select the repeat range.

Refer to *Repeating play* on this page.

2 Press FUNC and then press RDM to select the random mode.

3 Press RDM to turn random play on.

The light illuminates. Tracks will play in a random order within the previously selected **Magazine repeat** or **Disc repeat** ranges.

- To turn random play off, press **RDM** again.

**Note**

When the random mode is exited while random play is on, **RDM** appears on the basic display.

Scanning CDs and tracks

While you are using **Disc repeat**, the beginning of each track on the selected disc plays for about 10 seconds. When you are using **Magazine repeat**, the beginning of the first track of each disc is played for about 10 seconds.

1 Select the repeat range.

Refer to *Repeating play* on the previous page.

2 Press FUNC and then press SCAN to select the scan mode.**3 Press SCAN to turn scan play on.**

The light illuminates. The first 10 seconds of each track of the current disc (or the first track of each disc) is played.

4 When you find the desired track (or disc) press SCAN to turn scan play off.

The light goes off. The track (or disc) will continue to play.

- If the scan mode is automatically canceled, select the scan mode again.

**Notes**

- After track or disc scanning is finished, normal playback of the tracks will begin again.
- When the scan mode is exited while scan play is on, **SCAN** appears on the basic display.



Selecting tracks from the track title list

The track title list lets you see the list of track titles on a CD TEXT disc and select one of them for playback.

1 Press FUNC and then press T.LIST to select the track title list mode.**2 Press NEXT to display the desired track title.**

Press **NEXT** until the desired track title appears.

**3 Press the corresponding number button to select the desired track title.**

That selection will begin to play.

**Notes**

- You can also use ◀, ▶ and ▲ to select and play the desired track title.
- Only when playing a CD TEXT disc on a CD TEXT compatible multi-CD player, you can switch to this mode.

Selecting discs from the disc title list

Disc title list lets you see the list of disc titles that have been entered into the multi-CD player and select one of them to playback.

1 Press FUNC and then press D.LIST to select the disc title list mode.

Multi-CD Player

- 2 Press **NEXT** to switch between 1–6 and 7–12.



- 3 Press any of the buttons 1–6 (or 7–12) to select the desired disc title.

That selection will begin to play.



Notes

- You can also use ◀, ▶ and ▲ to select and play the desired disc title.
- If no title has been entered for a disc, **No D.Title** will be displayed.
- No disc** is displayed next to the disc number when no disc is set in the magazine.
- You cannot display 7–12 when a 6-disc multi-CD player is connected. □

Pausing CD playback

Pause lets you temporarily stop playback of the CD.

- 1 Press **FUNC** and then press **PAUSE** to select the pause mode.

- 2 Press **PAUSE** to turn pause on.

The light illuminates. Play of the current track pauses.

- To turn the pause off, press **PAUSE** again.



Note

You can also turn pause on or off by pressing **PAUSE** in the following display.



Using ITS playlists

ITS (instant track selection) lets you make a playlist of favorite tracks from those in the multi-CD player magazine. After you have added your favorite tracks to the playlist you can turn on ITS play and play just those selections.

Creating a playlist with ITS programming

You can use ITS to enter and playback up to 99 tracks per disc, up to 100 discs (with the disc title). (With multi-CD players sold before the CDX-P1250 and CDX-P650, up to 24 tracks can be stored in the playlist.)

- 1 **Play a CD that you want to program.**

Press ▲ or ▼ to select a CD.

- 2 **Press FUNC and NEXT and then press ITS.M to select the ITS programming mode.**

- 3 **Select a desired track by pressing ◀ or ▶.**

- 4 **Press MEMO to store the currently playing track in the playlist.**

Memory complete is displayed briefly and the currently playing selection is added to your playlist.

- You can also use ▲ to store the currently playing track in the playlist.

- 5 **Press BAND to return to the playback display.**



Note

After data for 100 discs has been stored in memory, data for a new disc will overwrite the oldest one.

Playback from your ITS playlist

ITS play lets you listen to the tracks that you have entered into your ITS playlist. When you turn on ITS play, tracks from your ITS playlist in the multi-CD player will begin to play.

1 Select the repeat range.

Refer to *Repeating play* on page 33.

2 Press FUNC and NEXT and then press ITS.P to select the ITS play mode.

3 Press ITS.P to turn ITS play on.

The light illuminates. Playback begins of those tracks from your playlist within the previously selected **Magazine repeat** or **Disc repeat** ranges.

- To turn ITS play off, press **ITS.P** again.
- If no tracks in the current range are programmed for ITS play then **ITS empty** is displayed.

Erasing a track from your ITS playlist

When you want to delete a track from your ITS playlist, you can if ITS play is on. If ITS play is already on, skip to step 2. If ITS play is not already on, press **FUNC**.

1 Play a CD you want to delete a track from your ITS playlist, and turn ITS play on.

Refer to *Playback from your ITS playlist* on this page.

2 Press FUNC and NEXT and then press ITS.M to select the ITS programming mode.

3 Select a desired track by pressing ◀ or ▶.

4 Press CLEAR to erase a track from your ITS playlist.

The currently playing selection is erased from your ITS playlist and playback of the next track from your ITS playlist begins.

- If there are no tracks from your playlist in the current range, **ITS empty** is displayed and normal play resumes.
- You can also use ▼ to erase the currently playing track from ITS playlist.

5 Press BAND to return to the playback display.

Erasing a CD from your ITS playlist

When you want to delete all tracks of a CD from your ITS playlist, you can if ITS play is off.

1 Play a CD that you want to delete.

Press ▲ or ▼ to select a CD.

2 Press FUNC and NEXT and then press ITS.M to select the ITS programming mode.

3 Press CLEAR to erase all tracks on the currently playing CD from your ITS playlist.

All tracks on the currently playing CD are erased from your playlist and **Memory deleted** is displayed.

- You can also use ▼ to erase all tracks on the currently playing CD from ITS playlist.

4 Press BAND to return to the playback display. □

Entering disc titles

Disc title input lets you input CD titles up to 10 letters long and up to 100 disc titles (with ITS playlist) into the multi-CD player. If you input a CD title, the entered title is displayed.

Multi-CD Player

1 Play a CD that you want to enter the title.

Press ▲ or ▼ to select a CD.

2 Press FUNC and NEXT and then press TTLin to select the disc title input mode.

3 Press ABC to select the desired character type.

Press **ABC** repeatedly to switch between the following character type:
Alphabet (upper case), numbers and symbols
—Alphabet (lower case)

- You can select to input numbers and symbols by pressing **012**.

4 Press ▲ or ▼ to select a letter of the alphabet.

Each press of ▲ will display a letter of the alphabet in **A B C ... X Y Z**, numbers and symbols in **1 2 3 ... @ # <** order. Each press of ▼ will display a letter in the reverse order, such as **Z Y X ... C B A** order.

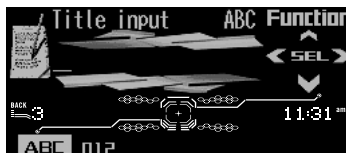

5 Press ► to move the cursor to the next character position.

When the letter you want is displayed, press ► to move the cursor to the next position and then select the next letter. Press ◀ to move backwards in the display.

6 Move the cursor to the last position by pressing ► after entering the title.

When you press ► one more time, the entered title is stored in memory.

7 Press BAND to return to the playback display.

Notes

- When playing a CD TEXT disc on a CD TEXT compatible multi-CD player, if you switch to this mode, **Can't input** is displayed and you cannot input the title.
- Titles remain in memory, even after the disc has been removed from the magazine, and are recalled when the disc is reinserted.
- After data for 100 discs has been stored in memory, data for a new disc will overwrite the oldest one. □

Using disc title functions

When playing a CD TEXT disc on a CD TEXT compatible multi-CD player, you can switch text display such as artist name and track title. When the text is longer than 32 letters, you can scroll the text to the left so that the rest of the title can be seen.

1 Press TITLE to switch the title mode.

2 Press the corresponding button to display the desired title.

FORM1 and FORM3

Button	Operation
D.TTL	Displays disc title.
D.ART	Displays disc artist name.
T.TTL	Displays track title.
T.ART	Displays track artist name.
SCROLL	Scrolls the displayed title.

FORM2

Button	Operation
TTL1	Displays disc title and track title.
TTL2	Displays disc title and disc artist name.

Button	Operation
TTL3	Displays track title and track artist name.
SCROLL	Scrolls the displayed title.



Notes

- If you do not operate the function within about eight seconds, the display is automatically returned.
- You cannot use ▲/▼/◀/▶ to select a disc or track in title mode.
- When you select the display **FORM2**, the titles are displayed up to 24 letters long.
- A CD TEXT disc is a CD featuring recorded text information such as disc title, artist name and track title.
- If specific information has not been recorded on a CD TEXT disc, **No xxxx** will be displayed (e.g., **No artist name**).
- If no title has been entered for the currently playing disc, **No title** is displayed.

Using compression and bass emphasis

You can use these functions only with a multi-CD player that supports them.

Using COMP (compression) and DBE (dynamic bass emphasis) functions let you adjust the sound playback quality of the multi-CD player. Each of the functions have a two-step adjustment. The COMP function balances the output of louder and softer sounds at higher volumes. DBE boosts bass levels to give playback a fuller sound. Listen to each of the effects as you select through them and use the one that best enhances the playback of the track or CD that you are listening to.

1 Press FUNC and NEXT and then press COMP to select the COMP/DBE mode.

- If the multi-CD player does not support COMP/DBE, **No COMP** is displayed when you attempt to select it.

2 Press COMP to select your favorite setting.

Press **COMP** repeatedly to switch between the following settings:

**COMP OFF—COMP 1—COMP 2—
COMP OFF—DBE 1—DBE 2**

TV tuner

Using the TV tuner

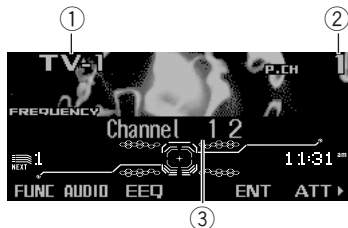

FORM1

You can use this unit to control a TV tuner, which is sold separately.

For details concerning operation, refer to the TV tuner's operation manuals. This section provides information on TV operations with this unit which differs from that described in the TV tuner's operation manual.

① Band indicator

Shows which band the TV tuner is tuned to.

② Preset number indicator

Shows what preset has been selected.

③ Channel indicator

Shows which channel the TV tuner is tuned.

1 Rotate SOURCE to select the television.

Rotate **SOURCE** until you see **Television** displayed.

2 Use VOLUME to adjust the sound level.

Rotate to increase or decrease the volume.

3 Press BAND to select a band.

Press **BAND** until the desired band is displayed, **TV-1** or **TV-2**.

4 To perform manual tuning, press ◀ or ▶ with quick presses.

The channels move up or down step by step.

5 To perform seek tuning, press and hold ◀ or ▶ for about one second and release.

- You can cancel seek tuning by pressing either ◀ or ▶ with a quick press. ◻

Introduction of advanced TV tuner operation

The tuner function menu has the following functions:

- BSSM** (best stations sequential memory)
- chLIST** (preset channel list)

BSSM chLIST

① BSSM (best stations sequential memory)

Press **BSSM** repeatedly to turn **BSSM** on or off.

When finished, the display switches to the preset channel list mode.

② chLIST (preset channel list)

For operation of the preset channel list, refer to *Selecting channels from the preset channel list* on the next page.

Note

If you do not operate the function within about 30 seconds, the display is automatically returned. ◻

Storing and recalling broadcast stations

If you press any of the preset tuning buttons **1-6** (or **7-12**) you can easily store up to 12 broadcast stations for later recall with the touch of a button.

1 Press NEXT to display 1–6 (or 7–12).

Press **NEXT** until **1–6** (or **7–12**) appears.

2 When you find a station that you want to store in memory press a preset tuning button 1–6 (or 7–12) and hold until the preset number stops flashing.

The number you have pressed will flash in the preset number indicator and then remain lit.

The selected station has been stored in memory.

The next time you press the same preset tuning button **1–6** (or **7–12**) the station is recalled from memory.

**Notes**

- Up to 12 stations, 6 for each of two TV bands can be stored in memory.
- You can also use ▲ and ▼ to recall broadcast stations assigned to preset tuning buttons **1–6** and **7–12**. □

Selecting channels from the preset channel list

The preset channel list lets you see the list of preset channels and select one of them to receive.

1 Press FUNC and then press chLIST to select the preset channel list mode.**2 Press NEXT to switch between 1–6 and 7–12.****3 Press any of the buttons 1–6 (or 7–12) to recall the desired channel.****Note**

You can also use ◀, ▶ and ▲ to select and recall the desired channel. □

DVD Player

Playing a disc



FORM1

You can use this unit to control a DVD player or multi-DVD player, which is sold separately.

For details concerning operation, refer to the DVD player's or multi-DVD player's operation manuals. This section provides information on DVD operations with this unit which differs from that described in the DVD player's or multi-DVD player's operation manual.

- ① **Disc number indicator**
Shows the disc currently playing when using a multi-DVD player.
- ② **Title number indicator**
Shows the title currently playing during DVD video playback.
- ③ **Chapter/track number indicator**
Shows the chapter/track currently playing.
- ④ **Play time indicator**
Shows the elapsed playing time of the current chapter/track.

1 Rotate SOURCE to select the DVD player.

Rotate **SOURCE** until you see **DVD** displayed.

2 Use VOLUME to adjust the sound level.

Rotate to increase or decrease the volume.

3 Press ▲ or ▼ to select a disc.

A disc number for which there is no disc will be skipped.

- You can use the buttons 1–6 to select a disc directly.

4 To perform fast forward or reverse, press and hold ◀ or ▶.

5 To skip back or forward to another chapter (or track), press ◀ or ▶.

Pressing ▶ skips to the start of the next chapter (or track). Pressing ◀ once skips to the start of the current chapter (or track). Pressing again will skip to the previous chapter (or track). □

Introduction of advanced DVD player operation

The DVD player function menu has the following functions:

During DVD video or Video CD playback

- RPT (repeat play)—D.LIST (disc title list)
- PAUSE (pause)—TTLin (disc title input)



During CD playback

- RPT (repeat play)—RDM (random play)
- SCAN (scan play)—D.LIST (disc title list)
- PAUSE (pause)—TTLin (disc title input)
- ITS.P (ITS play)—ITS.M (ITS programming)



Notes

- If you do not operate the function within about 30 seconds, the display is automatically returned.

(When you select the disc title input mode (**TTLin**) or ITS programming mode (**ITS.M**), the display is not returned automatically.)

- **D.LIST**, **TTLin**, **ITS.P** and **ITS.M** are displayed only when using a multi-DVD player. 

Repeating play

1 Press **FUNC** to select the repeat mode.

2 Press **RPT** to select the repeat range.
During DVD video playback

- **Title repeat** – Repeat just the current title
- **Chapter repeat** – Repeat just the current chapter
- **Disc repeat** – Repeat the current disc

During Video CD or CD playback

Each press of **RPT** turns the repeat play on or off. 

Playing tracks in a random order

1 Press **FUNC** and then press **RDM** to select the random mode.

2 Press **RDM** to turn random play on.

The light illuminates. Tracks will play in a random order.

- To turn random play off, press **RDM** again.



Note

When the random mode is exited while random play is on, **RDM** appears on the basic display. 

Scanning tracks of a CD

1 Press **FUNC** and then press **SCAN** to select the scan mode.

2 Press **SCAN** to turn scan play on.

The light illuminates. The first 10 seconds of each track is played.

3 When you find the desired track press **SCAN** to turn scan play off.

The light goes off. The track will continue to play.

- If the scan mode is automatically canceled, select the scan mode again.



Notes

- After scanning of a CD is finished, normal playback of the tracks will begin again.
- When the scan mode is exited while scan play is on, **SCAN** appears on the basic display. 

Pausing disc playback

1 Press **FUNC** and then press **PAUSE** to select the pause mode.

2 Press **PAUSE** to turn pause on.

The light illuminates. Play of the current track pauses.

- To turn the pause off, press **PAUSE** again.



Note

You can also turn pause on or off by pressing **PAUSE** in the following display.

PAUSE CLK C.MENU 

Using ITS playlist, disc title input and disc title list functions

During CD playback when using this unit with multi-DVD player, you can use these functions. Operation is same as multi-CD player. Please refer to multi-CD player section. 

Audio Adjustments

Operation modes

This unit features two operation modes: the 3-way network mode (NW) and the standard mode (STD). You can switch between modes as desired. Initially, the DSP setting is set to the standard mode (STD). (Refer to *Switching the DSP setting mode* on page 6.)

- The 3-way network mode (NW) lets you create a 3-way multi-amp, multi-speaker system with separate speakers for reproduction of high, middle and low frequencies (bands), each driven by a dedicated power amp. The 3-way network mode provides network and time alignment functions, two functions essential for a multi-amp, multi-speaker system, to enable precise control over settings for each frequency range.
- The standard mode (STD) lets you create a 4-speaker system with front and rear speakers, or a 6-speaker system with front and rear speakers and subwoofers. The standard mode provides a sound field control function offering an easy way to recreate realistic sound fields in your car.



Important

- When no power is supplied to this unit because of an exchange of the car battery or similar, the microcomputer of this unit is returned to its initial condition. If this happens, all memorized adjusted audio settings are erased. When you have completed audio setting adjustment, be sure to record the settings on page 70.

Operation mode marks

This manual uses the following marks to make the description clear.

NW: This mark indicates a function only in NW mode or an operation in NW mode.

STD: This mark indicates a function available only in STD mode or an operation in STD mode.

- The functions and operations which do not carry either mark are commonly used in the NW and STD modes. ▣

3-way network mode **NW**

By carrying out the following settings/adjustments in order, you can create a finely-tuned sound field effortlessly.

- *Using the position selector* (**POSI**)
- *Using balance adjustment* **NW** (**BAL**)
- *Using the time alignment* (**T.AL**)
- *Adjusting network* (**NW**)
- *Recalling equalizer curves* (**EEQ**)
- *Adjusting equalizer curves* (**EQ 1**)
- *Adjusting 13-band graphic equalizer* (**EQ 2**) ▣

Standard mode **STD**

Adjusting the audio easily

The following functions let you easily adjust your audio system to match the car interior acoustic characteristics which vary depending on the type of car.

- *Recalling equalizer curves* (**EEQ**)
- *Using the position selector* (**POSI**)
- *Adjusting equalizer curves* (**EQ 1**)

Adjusting the audio finely

By carrying out the following settings/adjustments in order, you can create a finely-tuned sound field effortlessly.

- *Using the position selector* (**POSI**)
- *Using balance adjustment* **STD** (**F/B**)
- *Using subwoofer output* **STD** (**SW1**)

- Adjusting subwoofer settings (**SW2**)
- Setting the high pass filter for front speakers (**HPF F**)
- Setting the high pass filter for rear speakers (**HPF R**)
- Auto TA and EQ (auto-time alignment and auto-equalizing) **STD**
- Recalling equalizer curves (**EEQ**)
- Adjusting equalizer curves (**EQ 1**)
- Adjusting 13-band graphic equalizer (**EQ 2**) 

Extra functions

These functions are helpful in adjusting the sound to suit your system or your personal preferences.

- Using BBE sound **NW** (**BBE**)
- Adjusting loudness (**LOUD**)
- Using sound field control and BBE sound **STD** (**SFC**)
- Using automatic sound levelizer (**ASL**)
- Adjusting source levels (**SLA**) 

Introduction of audio adjustments

The audio menu has the following functions:

NW

BAL—NW—POSI—T.AL—EQ 1—EQ 2—BBE—LOUD—ASL—SLA

BAL NW POSI T.AL EQ 1 EQ 2 

BBE LOUD ASL SLA 

STD

F/B—LOUD—SFC—EQ 1—EQ 2—ASL—POSI—T.AL—A.EQ—SW1—SW2—HPF F—HPF R—SLA

F/B LOUD SFC EQ 1 EQ 2 ASL 

POSI T.AL A.EQ SW 1 SW 2 HPFF 

HPFR SLA 



Notes

- If you do not operate the function within about 30 seconds, the display is automatically returned.
(When you select the 13-band graphic equalizer mode (**EQ 2**), the time alignment adjustment mode (**T.AL**) or the network adjustment mode (**NW**), the display is not returned automatically.)
- **SW2** is displayed only when the subwoofer output is on in the subwoofer output mode (**SW1**).
- **SLA** is not displayed when you select FM tuner as the source. 

Using the position selector

One way to assure a more natural sound is to clearly position the stereo image, putting you right in the center of the sound field. The position selector function lets you automatically adjust the speakers' output levels and inserts a delay time to match the number and position of occupied seats.





1 Press **AUDIO** and then press **NEXT** to display **POSI**.

Press **NEXT** until **POSI** appears in the display.

2 Press **POSI** to select the position selector mode.

Audio Adjustments





3 Press the corresponding button to select a listening position.

Button	Indicator	Position
FL		Front seat left
FR		Front seat right
FRONT		Front seats
ALL		All seats STD

- To cancel the selected listening position, press the same button again.
- You cannot select **ALL** when NW mode has been selected.

Note

You can also use ▲, ▼, ◀ or ▶ to select the listening position.

Button	Indicator	Position
◀		Front seat left
▶		Front seat right
▲		Front seats
▼		All seats STD



Using balance adjustment **NW**

You can select a balance setting that provides an ideal listening environment in all occupied seats.

1 Press AUDIO to select the balance mode.

2 Press ◀ or ▶ to adjust left/right speaker balance.

Each press of ◀ or ▶ moves the left/right speaker balance towards the left or the right. **Balance L25 – Balance R25** is displayed as the left/right speaker balance moves from left to right. 

Using balance adjustment **STD**

You can select a fader/balance setting that provides an ideal listening environment in all occupied seats.

1 Press AUDIO to select the fader/balance mode.

2 Press ▲ or ▼ to adjust front/rear speaker balance.

Each press of ▲ or ▼ moves the front/rear speaker balance towards the front or the rear. **Fader F25 – Fader R25** is displayed as the front/rear speaker balance moves from front to rear.

- **Fader FR 00** is the proper setting when only two speakers are used.

3 Press ◀ or ▶ to adjust left/right speaker balance.

Each press of ◀ or ▶ moves the left/right speaker balance towards the left or the right. **Balance L25 – Balance R25** is displayed as the left/right speaker balance moves from left to right. 

Using the time alignment

The time alignment lets you adjust the distance between each speaker and the listening position.

Audio Adjustments

1 Press **AUDIO** and then press **NEXT** to display **T.AL**.

Press **NEXT** until **T.AL** appears in the display.

2 Press **T.AL** to select the time alignment mode.

- **T.AL** is inactive when neither **FL** nor **FR** is selected in the position selector mode (**POSI**).

3 Press the corresponding button to select the time alignment.

Button	Time alignment
INTL	Initial
A.TA	Auto-time alignment STD
CUSTM	Custom

- To turn time alignment off, press the same button again.
- You cannot select **A.TA** when **NW** mode has been selected.
- **A.TA** is inactive if auto TA and EQ has not been carried out.

4 Press **BAND** to cancel the time alignment mode.



Notes

- **INTL** is the factory supplied time alignment.
- **A.TA** is the time alignment created by auto TA and EQ. (Refer to *Auto TA and EQ (auto-time alignment and auto-equalizing)* **STD** on page 54.)
- **CUSTM** is an adjusted time alignment that you can create for yourself.

Adjusting the time alignment

You can adjust the distance between each speaker and the selected position.

- An adjusted time alignment is memorized in **CUSTM**.

1 Press **AUDIO** and then press **NEXT** to display **T.AL**.

Press **NEXT** until **T.AL** appears in the display.

2 Press **T.AL** to select the time alignment mode.

- **T.AL** is inactive when neither **FL** nor **FR** is selected in the position selector mode (**POSI**).

3 Press **◀** or **▶** to select the speaker to be adjusted.

Each press of **◀** or **▶** selects the speaker in the following order:

NW

High Left (high-range left)—**High Right** (high-range right)—**Mid Right** (middle-range right)—**Mid Left** (middle-range left)—**Low Left** (low-range left)—**Low Right** (low-range right)

STD

Front Left (front left)—**Front Right** (front right)—**Rear Right** (rear right)—**Rear Left** (rear left)—**Sub. W** (subwoofer)

- You cannot select **Sub. W** when the subwoofer output is off.

4 Press **▲** or **▼** to adjust the distance between the selected speaker and the listening position.

Each press of **▲** or **▼** increases or decreases the distance.

400.0cm – 0.0cm is displayed as the distance is increased or decreased.

- You can adjust the distance for the other speakers in the same way.

5 Press **BAND** to cancel the time alignment mode. **▣**

Audio Adjustments

About the network function **NW**

The network function lets you divide the audio signal into different frequency bands, and then reproduce each of them through separate speaker units.

You can then make precise adjustments to the reproduced frequency band (with a low-pass filter or high-pass filter), level, phase and other parameters to match the characteristics of each speaker unit.

Adjustable parameters

The network function enables adjustment of the following parameters. Make adjustments in line with the reproduced frequency band and characteristics of each connected speaker unit.

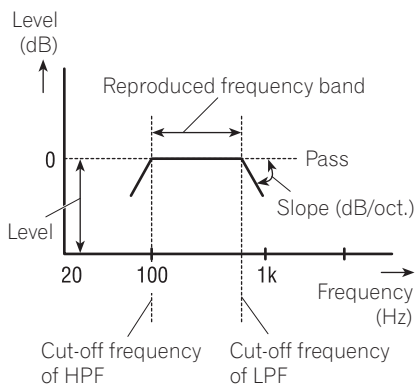

Reproduced frequency band

Adjusting the HPF (high-pass filter) or LPF (low-pass filter) cut-off frequency lets you set the reproduced frequency band for each speaker unit.

- The HPF cuts frequencies (low) below the set frequency, letting high frequencies through.

- The LPF cuts frequencies (high) above the set frequency, letting low frequencies through.

Level

The difference in reproduced levels between speaker units can be corrected.

Slope

Adjusting the HPF/LPF slope (filter attenuation slope) lets you adjust the continuity of sound between speaker units.

- The slope indicates the number of decibels (dB) the signal is attenuated when the frequency is one octave higher (lower) (Unit: dB/oct.). The steeper the slope, the more the signal is attenuated.

Phase

You can switch phase (normal, reverse) for each speaker unit's input signal. When the continuity of sound between speakers is imprecise, try switching phase. This may improve the continuity of sound between speakers.

Points concerning network adjustments

Cut-off frequency adjustment

- With the low-range speaker installed in the rear tray, if you set the **L LPF** cut-off frequency high, bass sound is separated so that it appears to come from the rear. You are recommended to set the **L LPF** cut-off frequency to 100 Hz or lower.
- The maximum input power setting for middle- and high-range speakers is usually lower than that for low-range speakers. Remember that if the **M HPF** or **H HPF** cut-off frequency is set lower than required, strong bass signal input may damage the speaker.

Level adjustment

The basic frequencies of many musical instruments are in the middle range. First perform middle-range level adjustment, followed by high-range and then low-range level adjustment in that order.

Slope adjustment

- If you set a small absolute value for the slope (for a gentle slope), interference between adjacent speaker units can easily result in degraded frequency response.
- If you set a large absolute value for the slope (for a steep slope), continuity of sound between speaker units is degraded, and sounds appear to be separated.
- If you set the slope to 0 dB/oct. (**Pass**), the audio signal bypasses the filter, so the filter does not have an effect.

Phase adjustment

When the cross-over point value for filters on both sides is set to -12 dB/oct., the phase is reversed 180 degrees at the filter cut-off frequency. In this case, reversing the phase assures improved sound continuity.

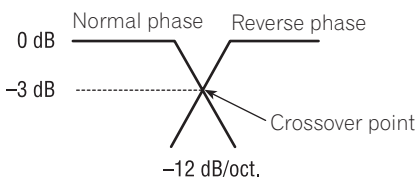

Muting the speaker unit (filter)

You can mute each speaker unit (filter). When a speaker unit (filter) is muted, no sound is output from that speaker.

- If you mute the selected speaker unit (filter), **MUTE** blinks and no adjustments are possible.

- Even if any speaker unit (filter) is muted, you can adjust the parameters for other speaker units (filters).

1 Press AUDIO and then press NW to select the network adjustment mode.

2 Press the corresponding button to select the speaker unit (filter) to be adjusted.

Button	Speaker unit (filter)
L LPF	Low-range speaker LPF
M HPF	Middle-range speaker HPF
M LPF	Middle-range speaker LPF
H HPF	High-range speaker HPF

3 Press MUTE to mute the selected speaker unit (filter).

MUTE blinks in the display.

- To cancel the muting, press **MUTE** again.

Adjusting network

1 Press AUDIO and then press NW to select the network adjustment mode.

2 Press the corresponding button to select the speaker unit (filter) to be adjusted.

Button	Speaker unit (filter)
L LPF	Low-range speaker LPF
M HPF	Middle-range speaker HPF
M LPF	Middle-range speaker LPF
H HPF	High-range speaker HPF

3 Press ◀ or ▶ to select the cut-off frequency (crossover frequency) of the selected speaker unit (filter).

L LPF: 31.5—40—50—63—80—100—125—160—200 (Hz)

Audio Adjustments

M HPF: 31.5—40—50—63—80—100—125—160—200 (Hz)

M LPF: 1.6—2—2.5—3.15—4—5—6.3—8—10—12.5—16 (kHz)

H HPF: 1.6—2—2.5—3.15—4—5—6.3—8—10—12.5—16 (kHz)

4 Press ▲ or ▼ to adjust the level of the selected speaker unit (filter).

Each press of ▲ or ▼ increases or decreases the level of the selected speaker unit (filter).

0dB — -24dB is displayed as the level is increased or decreased.

+6dB — -24dB is displayed as the level is increased or decreased, only if you have selected **L LPF**.

5 Press SLOPE to select the slope of the selected speaker unit (filter).



L LPF: -12—-18—-6 (dB/oct.)

M HPF: -12—-18—Pass (0)—-6 (dB/oct.)

M LPF: -12—Pass (0)—-6 (dB/oct.)

H HPF: -12—-6 (dB/oct.)

6 Press PHASE to switch the phase of the selected speaker unit (filter).

Each press of **PHASE** switches the phase between normal  and reverse .

▪ You can adjust the parameters for other speaker units (filters) in the same way.

7 Press BAND to cancel the network adjustment mode.

Using subwoofer output

This unit is equipped with a subwoofer output which can be switched on or off. When a subwoofer is connected to this unit, turn the subwoofer output on.

The subwoofer output phase can be switched between normal and reverse.

1 Press AUDIO and NEXT and then press SW1 to select the subwoofer output mode.

▪ **SW2** is displayed only when the subwoofer output is on in the subwoofer output mode (**SW1**).

2 Press SW1 to turn subwoofer output on.

SUB.W ON appears in the display. Subwoofer output is now on.

▪ To turn subwoofer output off, press **SW1** again.

3 Press ◀ or ▶ to select the phase of subwoofer output.

Press ◀ to select reverse phase. Press ▶ to select normal phase.

Adjusting subwoofer settings

When the subwoofer output is on, you can adjust the cut-off frequency and the output level of the subwoofer.

1 Press AUDIO and NEXT and then press SW2 to select the subwoofer setting mode.

2 Press ◀ or ▶ to select cut-off frequency.

Each press of ◀ or ▶ selects cut-off frequencies in the following order:

50—63—80—100—125 (Hz)

Only frequencies lower than those in the selected range are output from the subwoofer.

3 Press ▲ or ▼ to adjust the output level of the subwoofer.

Each press of ▲ or ▼ increases or decreases the level of the subwoofer. **+6 — -24** is displayed as the level is increased or decreased. 

Using the high pass filter **STD**

When you do not want low sounds from the subwoofer output frequency range to play from the front or rear speakers, turn the HPF (high pass filter) on. Only frequencies higher than those in the selected range are output from the front or rear speakers.

Setting the high pass filter for front speakers

1 Press AUDIO and NEXT and then press HPF F to select the high pass filter mode.

2 Press HPF F to turn high pass filter on. HPF ON appears in the display. High pass filter is now on.

- To turn high pass filter off, press **HPF F** again.

3 Press ◀ or ▶ to select cut-off frequency.

Each press of ◀ or ▶ selects cut-off frequencies in the following order:

50—63—80—100—125 (Hz)

Only frequencies higher than those in the selected range are output from the front or rear speakers.

Setting the high pass filter for rear speakers

1 Press AUDIO and then press NEXT twice.

2 Press HPF R to select the high pass filter mode.

3 Press HPF R to turn high pass filter on. HPF ON appears in the display. High pass filter is now on.

- To turn high pass filter off, press **HPF R** again.

4 Press ◀ or ▶ to select cut-off frequency.

Each press of ◀ or ▶ selects cut-off frequencies in the following order:

50—63—80—100—125 (Hz)

Only frequencies higher than those in the selected range are output from the front or rear speakers. **▣**

Using the auto-equalizer **STD**

The auto-equalizer is the equalizer curve created by auto TA and EQ (Refer to *Auto TA and EQ (auto-time alignment and auto-equalizing)* **STD** on page 54).

You can turn the auto-equalizer on or off.

1 Press AUDIO and NEXT and then press A.EQ to select the auto-equalizer on/off mode.

- **A.EQ** is inactive if auto TA and EQ has not been carried out.

2 Press A.EQ to turn the auto-equalizer on.

Auto EQ ON appears in the display.

- To turn auto-equalizer off, press **A.EQ** again. **▣**

Recalling equalizer curves

The equalizer lets you adjust the equalization to match car interior acoustic characteristics as desired.

There are seven stored equalizer curves which you can easily recall at any time.

1 Press EEQ to switch to the easy equalizer mode.

2 Press NEXT to switch between CSTM2 and the other selections (curves).

Audio Adjustments

3 Press the corresponding button to select the desired equalizer curve.

Button	Equalizer curve
CLRTY	Clarity
RHYTHM	Rhythm
SENS	Sensitive
NRRW	Narrow
FLAT	Flat
CSTM1	Custom 1
CSTM2	Custom 2

- **CUSTOM1** and **CUSTOM2** are adjusted equalizer curves that you create. Adjustments can be made with a 13-band graphic equalizer.
- When **FLAT** is selected no supplement or correction is made to the sound. This is useful to check the effect of the equalizer curves by switching alternatively between **FLAT** and a set equalizer curve.

Notes

- You can also sequentially select an equalizer curve by pressing ◀ or ▶.
- If you do not operate the function within about eight seconds, the display is automatically returned. 

Adjusting equalizer curves

The factory supplied equalizer curves, with the exception of **FLAT**, can be adjusted to a fine degree (nuance control).

1 Press AUDIO and then press EQ 1 to select the graphic equalizer mode.

2 Press ◀ or ▶ to select an equalizer curve.

3 Press ▲ or ▼ to adjust the equalizer curve.

Each press of ▲ or ▼ increases or decreases the equalizer curve respectively. **+6 – –5** (or **–6**) is displayed as the equalizer curve is increased or decreased.

- The actual range of the adjustments are different depending on which equalizer curve is selected.
- The equalizer curve with all frequencies set to **0** cannot be adjusted. 

Adjusting 13-band graphic equalizer

For **CUSTOM1** and **CUSTOM2** equalizer curves, you can adjust the level of each band.

- A separate **CUSTOM1** curve can be created for each source. (The built-in CD player and the multi-CD player are set to the same equalizer adjustment setting automatically.) If you make adjustments when a curve other than **CUSTOM2** is selected, the equalizer curve settings will be memorized in **CUSTOM1**.
- A **CUSTOM2** curve can be created common to all sources. If you make adjustments when the **CUSTOM2** curve is selected, the **CUSTOM2** curve will be updated.

1 Recall the equalizer curve you want to adjust.

See *Recalling equalizer curves* on the previous page.

2 Press AUDIO and then press EQ 2 to select the 13-band graphic equalizer mode.

3 Press ◀ or ▶ to select the equalizer band to adjust.

Each press of ◀ or ▶ selects equalizer bands in the following order:

Audio Adjustments

50—80—125—200—315—500—800—1.25k—2k—3.15k—5k—8k—12.5k (Hz)

4 Press ▲ or ▼ to adjust the level of the equalizer band.

Each press of ▲ or ▼ increases or decreases the level of the equalization band.

+6 – –6 is displayed as the level is increased or decreased.

- You can then select another band and adjust the level.

5 Press BAND to cancel the 13-band graphic equalizer mode.

Using BBE sound

With BBE, playback very close to the original sound can be obtained by correction with a combination of phase compensation and high-range boost for the delay of the high-frequency components and the amplitude deviation occurring during playback. This function makes it possible to reproduce the dynamic sound field as if you are listening to a live performance.



Note

Manufactured under license from BBE Sound, Inc. The mark BBE is a trademark of BBE Sound, Inc.

Adjusting BBE sound level

With BBE sound processing technology, you can adjust the level of BBE.

1 Press AUDIO and NEXT and then press BBE to select BBE.

2 Press BBE to turn BBE on.

- To cancel the BBE, press BBE again.



3 Press ▲ or ▼ to adjust the level of BBE.

Each press of ▲ or ▼ increases or decreases the level of BBE.

+4 – –4 is displayed as the level is increased or decreased. 

Adjusting loudness

Loudness compensates for deficiencies in the low- and high-sound ranges at low volume.

1 Press AUDIO and then press NEXT to display LOUD.

Press NEXT until LOUD appears.

2 Press LOUD to select the loudness mode.

3 Press LOUD to turn loudness on.

Loudness ON appears in the display.

- To turn loudness off, press LOUD again. 

Using sound field control and BBE sound

SFC (sound field control) incorporate four programs for reproducing typical sound fields of a studio, club, concert hall or dome. This function makes it possible to reproduce the realistic sound fields of the four programs in your car.

With BBE, playback very close to the original sound can be obtained by correction with a combination of phase compensation and high-range boost for the delay of the high-frequency components and the amplitude deviation occurring during playback. This function makes it possible to reproduce the dynamic sound field as if you are listening to a live performance.

Audio Adjustments

Note

Manufactured under license from BBE Sound, Inc. The mark BBE is a trademark of BBE Sound, Inc.

Recalling sound field programs

1 Press AUDIO and then press SFC to select the sound field control mode.

2 Press the corresponding button to select the desired sound field program.

Button	Effect
STUDIO	Studio
CLUB	Club
HALL	Concert hall
DOME	Dome
BBE	BBE

- To cancel the selected sound field program, press the same button again.
- You can also sequentially select a sound field program by pressing ◀ or ▶.

Adjusting BBE sound level

With BBE sound processing technology, you can adjust the level of BBE.

1 Press AUDIO and SFC and then press BBE to select BBE.

2 Press BBE to turn BBE on.

- To cancel the BBE, press **BBE** again.

3 Press ▲ or ▼ to adjust the level of BBE.

Each press of ▲ or ▼ increases or decreases the level of BBE.

+4 – -4 is displayed as the level is increased or decreased. 

Using automatic sound levelizer

During driving, noise in the car changes according to the driving speed and road conditions. The automatic sound levelizer (ASL) monitors such varying noise and automatically increases the volume level, if this noise becomes greater. The sensitivity (variation of volume level to noise level) of ASL can be set to one of five levels.

1 Press AUDIO and then press NEXT to display ASL

Press **NEXT** until **ASL** appears.

2 Press ASL to select the automatic sound levelizer mode.

3 Press ASL to select the desired ASL level.

Each press of **ASL** selects ASL level in the following order:

OFF (off)—**Low** (low)—**Mid-Low** (mid-low)—**Mid** (mid)—**Mid-High** (mid-high)—**High** (high)

Note

When the ASL mode is exited except for **OFF** is selected, **ASL** appears on the basic display. 

Adjusting source levels

SLA (source level adjustment) lets you adjust the volume level of each source to prevent radical changes in volume when switching between sources.

- Settings are based on the volume level of the FM tuner, which remains unchanged.

1 Compare the FM tuner volume level with the level of the source you wish to adjust.

2 Press AUDIO and then press NEXT to display SLA.

Press **NEXT** until **SLA** appears.

- **SLA** is not displayed when you select FM tuner as the source.

3 Press SLA to select the SLA mode.

4 Press ▲ or ▼ to adjust the source volume.

Each press of ▲ or ▼ increases or decreases the source volume.

+4 – –4 is displayed as the source volume is increased or decreased.



Notes

- Since the FM tuner volume is the control, it is not possible to apply source level adjustments to the FM tuner.
- The AM tuner volume level can also be adjusted with source level adjustments.
- The built-in CD player and the multi-CD player are set to the same source level adjustment volume automatically.
- External unit 1 and external unit 2 are set to the same source level adjustment volume automatically. 

Auto TA and EQ (auto-time alignment and auto-equalizing)

The auto-time alignment automatically adjusted the distance between each speaker and the listening position.

The auto-equalizer automatically measures the car interior acoustic characteristics, and

then creates the auto-equalizer curve based on that information.



WARNING

To prevent accidents, never carry out auto TA and EQ while driving. When this function measures the car interior acoustic characteristics to create an auto-equalizer curve, a loud measurement tone (noise) may be output from the speakers.



CAUTION

- Carrying out auto TA and EQ under the following conditions may damage the speakers. Be sure to check the conditions thoroughly before carrying out auto TA and EQ.
 - When speakers are incorrectly connected. (e.g., When a rear speaker is connected to a subwoofer output.)
 - When a speaker is connected to a power amp delivering output higher than the speaker's maximum input power capability.
- If the microphone is placed in an unsuitable position the measurement tone may become loud and measurement may take a long time, resulting in a drain on battery power. Be sure to place the microphone in the specified location.

Before operating the auto TA and EQ function

- Carry out auto TA and EQ in as quiet a place as possible, with the car engine and air conditioning switched off. Also cut power to car phones or portable telephones in the car, or remove them from the car before carrying out auto TA and EQ. Sounds other than the measurement tone (surrounding sounds, engine sound, telephones ringing etc.) may prevent correct

Audio Adjustments

measurement of the car interior acoustic characteristics.

- Be sure to carry out auto TA and EQ using the supplied microphone. Using another microphone may prevent measurement, or result in incorrect measurement of the car interior acoustic characteristics.
- When front speaker is not connected, auto TA and EQ cannot be carried out.
- When this unit is connected to a power amp with input level control, auto TA and EQ may not be possible if you lower power amp input level. Set the power amp's input level to the standard position.
- When this unit is connected to a power amp with LPF, be sure to turn LPF off and then carry out auto TA and EQ. LPF may prevent correct measurement.
- Auto TA and EQ changes the audio settings as below:
 - The fader/balance settings return to the center position. (Refer to page 45.)
 - The graphic equalizer curve switches to **FLAT**. (Refer to page 50.)
 - When a subwoofer is connected to this unit, it will be adjusted automatically to either subwoofer output and high pass filter setting for rear speaker.
- If you carry out auto TA and EQ when a previous setting of this already exists, the setting will be replaced.

Carrying out auto TA and EQ

1 Stop the car in a place that is as quiet as possible, close all doors, windows and the sun roof, and then turn the engine off.

If the engine is left running, engine noise may prevent correct auto TA and EQ.

2 Fix the supplied microphone in the center of the headrest of the driver's seat, facing forward, using the belt (sold separately).

The auto TA and EQ may differ depending on where you place the microphone. If desired, place the microphone on the front passenger seat to carry out auto TA and EQ.

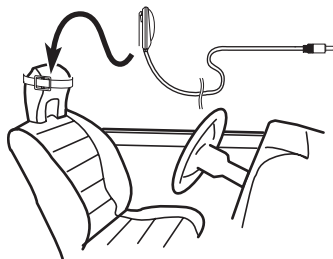

3 Turn the ignition switch to ON or ACC.

If the car's air conditioner or heater is turned on, turn it off. Noise from the fan in the air conditioner or heater may prevent correct auto TA and EQ.

- Rotate **SOURCE** to turn the source on if this unit is turned off.

4 Select the position for the seat on which the microphone is placed.

Refer to *Using the position selector* on page 44.

- If no position is selected before you start auto TA and EQ, **FR** is selected automatically.

5 Rotate SOURCE until the unit turns off.

6 Press and hold \Rightarrow 2 to enter the auto TA and EQ measurement mode.

The front panel opens automatically.

- When the source is off, you can check the location of \Rightarrow 2 by turning on the feature demo.



7 Plug the microphone into the microphone input jack on this unit.

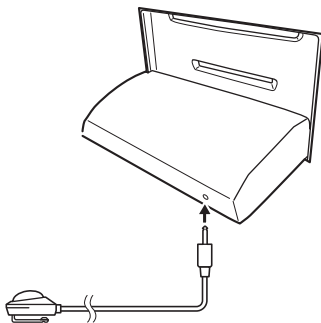

8 Press START to start the auto TA and EQ.

9 Get out of the car and close the door within 10 seconds when the 10-second count-down starts.

The measurement tone (noise) is output from the speakers, and auto TA and EQ begins.

- When all speakers are connected, auto TA and EQ is completed in about six minutes.
- To stop auto TA and EQ, press **STOP**.
- To cancel auto TA and EQ part way through, press **EXIT** or **BAND**.

10 When auto TA and EQ is completed, Complete is displayed.

When correct measurement of car interior acoustic characteristics is not possible, an error message is displayed. (Refer to *Understanding auto TA and EQ error messages* on page 65.)

11 Press EXIT or BAND to cancel the auto TA and EQ mode.

12 Store the microphone carefully in the glove compartment.

Store the microphone carefully in the glove compartment or any other safe place. If the microphone is subjected to direct sunlight for an extended period, high temperatures may cause distortion, color change or malfunction. 

Initial Settings

Adjusting initial settings

Initial settings lets you perform initial set up of different settings for this unit.

The initial settings menu has the following functions:

REV (reverse mode)—**F.DEMO** (feature demo)—**AUX** (auxiliary input)—**D.ATT** (digital attenuator)—**MUTE.S** (telephone muting/attenuation)—**FMstep** (FM tuning step)—**AMstep** (AM tuning step)



1 Rotate SOURCE until the unit turns off.

2 Press \rightarrow 1 and hold to enter the initial-settings menu.

When the source is off, you can check the location of \rightarrow 1 by turning on the feature demo.



- To cancel initial settings, press **BAND**.

Using reverse mode

If you do not perform an operation within about 30 seconds, screen indications start to reverse, and then continue reversing every 10 seconds.

You can turn the reverse mode on or off.

1 With the source turned off, press \rightarrow 1 and hold to select the reverse mode.

2 Press REV to turn the reverse mode on.

ON appears in the display.

- To turn the reverse mode off, press **REV** again.

Using the feature demo

The feature demo automatically starts when power to this unit is turned off while the ignition switch is set to ACC or ON.

You can turn the feature demo on or off.

Important

The red lead (ACC) of this unit should be connected to a terminal coupled with ignition switch on/off operations. If this is not done, the vehicle battery may be drained.

1 With the source turned off, press \rightarrow 1 and hold.

2 Press F.DEMO to select the feature demo mode.

3 Press F.DEMO to turn the feature demo on.

ON appears in the display.

- To turn the feature demo off, press **F.DEMO** again.

Switching the auxiliary setting

It is possible to use auxiliary equipment with this unit. Activate the auxiliary setting when using auxiliary equipment connected to this unit.

1 With the source turned off, press \rightarrow 1 and hold.

2 Press AUX to select the AUX mode.

3 Press AUX to turn AUX on.

ON appears in the display.

- To turn AUX off, press **AUX** again.

Selecting the digital attenuator

When listening to a CD or other source on which the recording level is high, setting the equalizer curve level to high may result in distortion. You can switch the digital attenuator to low to reduce distortion.

- Sound quality is better at the high setting so this setting is usually used.

1 With the source turned off, press \blacksquare 1 and hold.

2 Press D.ATT to select the digital attenuator mode.

3 Press the corresponding button to select the digital attenuator level.

Button	Level
LOW	Low
HIGH	High



Switching the telephone muting/attenuation

Sound from this system is muted or attenuated automatically when a call is made or received using a cellular telephone connected to this unit.

- The sound turns off, **MUTE** or **ATT** is displayed and no audio adjustments, except volume control, are possible.
- Operation returns to normal when the phone call is ended.

1 With the source turned off, press \blacksquare 1 and hold.

2 Press MUTE.S to select the telephone muting/attenuation mode.

3 Press MUTE.S to select the desired setting.

Each press of **MUTE.S** selects settings in the following order:

TEL mute (muting)— **10dB ATT** (attenuation)
— **20dB ATT** (attenuation)

20dB ATT has a stronger effect than **10dB ATT**.

Setting the FM tuning step

The FM tuning step employed by seek tuning can be switched between 100 kHz, the preset step, and 50 kHz.

1 With the source turned off, press \blacksquare 1 and hold.

2 Press NEXT and then press FMstep to select the FM tuning step mode.

3 Press the corresponding button to select the desired tuning step.

Button	Tuning step
50K	50 kHz
100K	100 kHz



Note

If seek tuning is performed in 50 kHz steps, stations may be tuned in imprecisely. Tune in the stations with manual tuning or use seek tuning again.

Setting the AM tuning step

The AM tuning step can be switched between 9 kHz, the preset step, and 10 kHz. When using the tuner in North, Central or South America, reset the tuning step from 9 kHz (531

Initial Settings

– 1,602 kHz allowable) to 10 kHz (530 – 1,640 kHz allowable).

1 With the source turned off, press **↔** 1 and hold.

2 Press **NEXT** and then press **AMstep** to select the AM tuning step mode.

3 Press the corresponding button to select the desired tuning step.

Button	Tuning step
9K	9 kHz
10K	10 kHz



Attenuating volume

The attenuator lets you lower the volume level quickly (by about 90%).

- **Press ATT to turn the attenuator on.**

ATT appears in the display.

- Press **ATT** again to turn the attenuator off and return to the original volume level. 

Displaying and setting the clock

You can turn the clock display on or off and set the clock.

Turning the off clock display on or off

If the off clock display is turned on, when the sources and the feature demo are off, the clock display appears on the display.

- 1 Press NEXT to display CLK.**

Press **NEXT** until **CLK** appears.

- 2 Press CLK and then press OFF CLK to select the off clock display mode.**

- 3 Press OFF CLK to turn the off clock display on.**

ON appears in the display.

- To turn the off clock display off, press **OFF CLK** again.

Setting the date

The calendar display adjusted in this mode appears only when sources and the feature demo are off.

- 1 Press NEXT to display CLK.**

Press **NEXT** until **CLK** appears.

- 2 Press CLK and then press DATE to set the date.**

- 3 Press ◀ or ▶ to select the segment of the calendar display you wish to set.**

Pressing ◀ or ▶ will select one segment of the calendar display:

Day—Month—Year

- 4 Press ▲ or ▼ to set the date.**

Pressing ▲ will increase the selected day, month or year. Pressing ▼ will decrease the selected day, month or year.

Setting the clock

- 1 Press NEXT to display CLK.**

Press **NEXT** until **CLK** appears.

- 2 Press CLK and then press TIME to set the clock.**

- 3 Press ◀ or ▶ to select the segment of the clock display you wish to set.**

Pressing ◀ or ▶ will select one segment of the clock display:

Hour—Minute

- 4 Press ▲ or ▼ to set the clock.**

Pressing ▲ will increase the selected hour or minute. Pressing ▼ will decrease the selected hour or minute.

Matching the time to a time signal

- 1 Press NEXT to display CLK.**

Press **NEXT** until **CLK** appears.

- 2 Press CLK and then press TIME to set the clock.**

Other Functions

3 Press **JUST** to match the time to a time signal.

If the minute is **00 – 29**, the minutes are rounded down. (e.g., 10:18 becomes 10:00.)
If the minute is **30 – 59**, the minutes are rounded up. (e.g., 10:36 becomes 11:00.)



Note

During date adjustment, **JUST** is not displayed.

Setting the time signal display

You can display the time signal display, which announces every full hour with a sound and an animation.

1 Press **NEXT** to display **CLK**.

Press **NEXT** until **CLK** appears.

2 Press **CLK** and then press **T.SGNL** to select the time signal display.

Changing the display form

This unit is equipped with two basic displays. You can select the desired display.

1 Press **NEXT** to display **C.MENU**.

Press **NEXT** until **C.MENU** appears.

2 Press **C.MENU** and then press **D.FORM** to select the display form mode.

3 Press **FORM1**, **FORM2** or **FORM3** to select the desired display form.

Adjusting the brightness

Display brightness adjustment lets you adjust the display for easier viewing when lighting conditions change.

1 Press **NEXT** to display **C.MENU**.

Press **NEXT** until **C.MENU** appears.

2 Press **C.MENU** and then press **BRGHT** to select the brightness mode.

3 Press **◀** or **▶** to adjust the brightness level.

Each press of **◀** or **▶** increases or decreases the brightness level. **00 – 28** is displayed as the level is increased or decreased. 

Switching the dimmer setting

To prevent the display from being too bright at night, the display is automatically dimmed when the car's headlights are turned on. You can switch dimmer on or off.

1 Press **NEXT** to display **C.MENU**.

Press **NEXT** until **C.MENU** appears.

2 Press **C.MENU** and then press **DMMER** to select the dimmer mode.

3 Press **DMMER** to turn the dimmer on. **ON** appears in the display.

▪ To turn the dimmer off, press **DMMER** again. 

Setting the flash light screen

There are four stored flash light screen to select from.

1 Press NEXT to display C.MENU.

Press **NEXT** until **C.MENU** appears.

2 Press C.MENU and then press FLASH to select the flash light select mode.**3 Press any of the buttons TYPE1 – TYPE4 or ALL to select the desired type.**

When you press **ALL**, you can display all types sequentially.

- To turn the flash light off, press **OFF**. 

Selecting the wall paper pattern

When you select display form 2 (**FORM2**), there are three patterns to select from.

1 Press NEXT to display C.MENU.

Press **NEXT** until **C.MENU** appears.

2 Press C.MENU and then press PTRN to select the wall paper pattern mode.**3 Press A, B or C to select the desired pattern.** 

Switching the font

When you select display form 3 (**FORM3**), there are three kinds of fonts to select from.

1 Press NEXT to display C.MENU.

Press **NEXT** until **C.MENU** appears.

2 Press C.MENU and then press FONT to select the font select mode.**3 Press A, B or C to select the desired font.** 

Using different entertainment displays

You can enjoy entertainment displays while listening to each sound source.

Setting the movie screen

There are three stored movie screens to select from.

1 Press ENT and then press MOVIE to select the movie mode.**2 Press any of the buttons MOVIE1 – MOVIE3 or ALL to select the desired movie.**

When you press **ALL**, you can display movies 1 to 3 sequentially.

**Note**

The movie screen will disappear temporarily when you perform other operations, but will be displayed again after three seconds.

Setting the level indicator display

There are three stored level indicator displays to select from.

1 Press ENT and then press S/A to select the level indicator mode.**2 Press any of the buttons S/A1 – S/A3 to select the desired level indicator.****Note**

The level indicator display will disappear temporarily when you perform other operations, but will be displayed again after three seconds.

Other Functions

Setting the ASL display

You can display the ASL effect level. (Refer to page 53.)

- Press **ENT** and then press **ASL** to select the ASL display.



Note

The ASL display will disappear temporarily when you perform other operations, but will be displayed again after three seconds

Setting the background visual

When you select display form 1 (**FORM1**), there are five stored background visuals to select from.

- When you select **FORM2**, **BG** is not displayed and this mode is inactive.
- When you select **FORM3**, the background visual cannot be changed.

FORM1

- 1 Press **ENT** and **BG** and then press **BGV** to select the background visual mode.
- 2 Press any of the buttons **BGV1 – BGV5** to select the desired visual.

FORM3

- Press **ENT** and **BGV** to select the background visual.

Setting the background still picture

The background still pictures are only for the display form 1 (**FORM1**). There are 12 stored background still pictures to select from.

- When you select **FORM2** or **FORM3**, **BG** is not displayed and this mode is inactive.

- 1 Press **ENT** and **BG** and then press **BGP** to select the background still picture mode.

- 2 Press **NEXT** to switch between **BGP1 – BGP6** and **BGP7 – BGP12**.

- 3 Press any of the buttons **BGP1 – BGP6** (or **BGP7 – BGP12**) to select the desired picture.

Canceling the entertainment display

You can cancel the entertainment display (the movie screens, the level indicator displays, etc.).

- Press **ENT** and then press **OFF** to cancel the entertainment display. 

Using the AUX source

An IP-BUS-RCA Interconnector such as the CD-RB20/CD-RB10 (sold separately) lets you connect this unit to auxiliary equipment featuring RCA output. For more details, refer to the IP-BUS-RCA Interconnector owner's manual.

Selecting AUX as the source

- Rotate **SOURCE** to select **AUX** as the source.

Rotate **SOURCE** until **AUX** appears in the display.

- If the auxiliary setting is not turned on, **AUX** cannot be selected. For more details, see *Switching the auxiliary setting* on page 57.

Setting the AUX title

The title displayed for the **AUX** source can be changed.

1 Rotate SOURCE to select AUX as the source.

Rotate **SOURCE** until **AUX** appears in the display.

2 Press FUNC and then press TTLin to select the AUX title input mode.

Refer to *Entering disc titles* on page 36, and perform procedures 3 to 7 in the same way.



Note

Even if you do not press **TTLin** you can enter the title, but you will not be able to change the character types.

Additional Information

Understanding built-in CD player error messages

When problems occur during CD play an error message may appear on the display. If an error message appears on the display refer to the table below to see what the problem is and the suggested method of correcting the problem. If the error cannot be corrected, contact your dealer or your nearest Pioneer Service Center.

Message	Cause	Action
ERROR-11, 12, 17, 30	Dirty disc	Clean disc.
ERROR-11, 12, 17, 30	Scratched disc	Replace disc.
ERROR-10, 11, 12, 17, 30, A0	Electrical or mechanical	Turn the ignition ON and OFF, or switch to a different source, then back to the CD player.
ERROR-22, 23	The CD format cannot be played back	Replace disc.
ERROR-44	All tracks are skip tracks	Replace disc.



Understanding built-in MD player error messages

When problems occur during MD play an error message may appear on the display. If an error message appears on the display refer to the table below to see what the problem is and the suggested method of correcting the problem. If the error cannot be corrected, contact your dealer or your nearest Pioneer Service Center.

Message	Cause	Action
Blank MD	Blank disc is inserted.	Replace disc.
TEMP	The temperature of this unit is outside of the normal operating range	Wait until the unit's temperature returns to within normal operating limits.
ERROR-11, 12, 17, 30	Dirty disc	Clean disc.
ERROR-11, 12, 17, 30	Scratched disc	Replace disc.
ERROR-01, 11, 12, 17, 30, A0, A1	Electrical or mechanical	Turn the ignition ON and OFF, or switch to a different source, then back to the MD player.
ERROR-20, 21	Track information cannot be read.	Reload the MD.
ERROR-20, 21, 24	There is something wrong with the MD.	Replace disc.
ERROR-23	The MD contains recorded information other than music.	Replace disc.
ERROR-A1	Electrical or mechanical	Press RESET .
ERROR-	MD play not possible.	Replace disc, or press RESET .



Understanding auto TA and EQ error messages

When correct measurement of car interior acoustic characteristics is not possible using the auto TA and EQ, an error message may appear on the display. If an error message appears on the display refer to the table below to see what the problem is and the suggested method of correcting the problem. After checking, try again.

Additional Information

Message	Cause	Action
Error check MIC	Microphone is not connected.	Plug the supplied microphone securely into the jack.
Error check front SP. Error check FL SP. Error check FR SP. Error check RL SP. Error check RR SP. Error check SW	The microphone cannot pick up the measuring tone of any speaker.	<ul style="list-style-type: none"> • Confirm that the speakers are connected correctly. • Correct the input level setting of the power amp connected to the speakers. • Set the microphone correctly.
Error check noise	The surrounding noise level is too high.	<ul style="list-style-type: none"> • Stop your car in a place that is as quiet as possible, and switch off the engine, air conditioner or heater. • Set the microphone correctly.
A.TA&EQ unavailable	The operation mode set to NW mode.	The auto TA and EQ function does not work in NW mode.



CD player and care

- Use only CDs that have either of the two Compact Disc Digital Audio marks as shown below.



- Use only normal, round CDs. If you insert irregular, non-round, shaped CDs they may jam in the CD player or not play properly.



- Check all CDs for cracks, scratches or warped discs before playing. CDs that have cracks, scratches or are warped may not play properly. Do not use such discs.
- Avoid touching the recorded (non-printed side) surface when handling the disc.
- Store discs in their cases when not in use.
- Keep discs out of direct sunlight and do not expose the discs to high temperatures.
- Do not attach labels, write on or apply chemicals to the surface of the discs.
- To clean dirt from a CD, wipe the disc with a soft cloth outward from the center of the disc.



- If the heater is used in cold weather, moisture may form on components inside the CD player. Condensation may cause the CD player to not operate properly. If you think that condensation is a problem turn off the CD player for an hour or so to allow the CD player to dry out and wipe any damp discs with a soft cloth to remove the moisture.
- Road shocks may interrupt CD playback. 

Additional Information

CD-R/CD-RW discs

- When CD-R/CD-RW discs are used, playback is possible only for discs which have been finalized.
- It may not be possible to play back CD-R/CD-RW discs recorded on a music CD recorder or a personal computer because of disc characteristics, scratches or dirt on the disc, or dirt, condensation, etc. on the lens of this unit.
- Playback of discs recorded on a personal computer may not be possible depending on the application settings and the environment. Please record with the correct format. (For details, contact the manufacturer of the application.)
- Playback of CD-R/CD-RW discs may become impossible in case of direct exposure to sunlight, high temperatures, or the storage conditions in the car.
- Titles and other text information recorded on a CD-R/CD-RW disc may not be displayed by this unit (in the case of audio data (CD-DA)).
- This unit conforms to the track skip function of the CD-R/CD-RW disc. The tracks containing the track skip information are skipped automatically (in case of audio data (CD-DA)).
- If you insert a CD-RW disc into this unit, time to playback will be longer than when you insert a conventional CD or CD-R disc.
- Read the precautions with CD-R/CD-RW discs before using them. 

MP3 and WMA files

- MP3 is short for MPEG Audio Layer 3 and refers to an audio compression technology standard.
- WMA is short for Windows Media™ Audio and refers to an audio compression tech-

- nology that is developed by Microsoft Corporation. WMA data can be encoded by using Windows Media Player version 7, 7.1 or Windows Media Player for Windows XP.
- With some applications used to encode WMA files, this unit may not operate correctly.
- With some applications used to encode WMA files, album names and other text information may not be correctly displayed.
- This unit allows playback of MP3/WMA files on CD-ROM, CD-R and CD-RW discs. Disc recordings compatible with level 1 and level 2 of ISO9660 and with the Romeo and Joliet file system can be played back.
- It is possible to play back multi-session compatible recorded discs.
- MP3/WMA files are not compatible with packet write data transfer.
- The max. number of characters which can be displayed for a file name, including the extension (.mp3 or .wma), is 32 characters from the first character.
- The max. number of characters which can be displayed for a folder name is 32 characters.
- In case of files recorded according to the Romeo and Joliet file system, only the first 32 characters can be displayed.
- When playing discs with MP3/WMA files and audio data (CD-DA) such as CD-EXTRA and MIXED-MODE CDs, both types can be played only by switching mode between MP3/WMA and CD-DA.
- The folder selection sequence for playback and other operations becomes the writing sequence used by the writing software. For this reason, the expected sequence at the time of playback may not coincide with the actual playback sequence. However, there also is some writing software which permits setting of the playback order.

Additional Information

Important

- When naming an MP3 or a WMA file, add the corresponding filename extension (.mp3 or .wma).
- This unit plays back files with the filename extension (.mp3 or .wma) as an MP3 or a WMA file. To prevent noise and malfunctions, do not use these extensions for files other than MP3 or WMA files.

MP3 additional information

- Files are compatible with the ID3 Tag Ver. 1.0 and Ver. 1.1 formats for display of album (disc title), track (track title) and artist (track artist).
- Only when MP3 files of 32, 44.1 and 48 kHz frequencies are played back, the emphasis function is valid. (16, 22.05, 24, 32, 44.1, 48 kHz sampling frequencies can be played back.)
- There is no m3u playlist compatibility.
- There is no compatibility with the MP3i (MP3 interactive) or mp3 PRO format.
- The sound quality of MP3 files generally becomes better with increasing bit rate. This unit can play recordings with bit rates from 8 kbps to 320 kbps, but in order to be able to enjoy a certain sound quality, it is recommended to use only discs recorded with a bit rate of at least 128 kbps.

WMA additional information

- Only when WMA files of 32, 44.1 and 48 kHz frequencies are played back.
- The sound quality of WMA files generally becomes better with increasing bit rate. This unit can play recordings with bit rates from 48 kbps to 192 kbps, but in order to be able to enjoy a certain sound quality, it is recommended to use discs recorded with a higher bit rate. 

About folders and MP3/WMA files

- An outline of a CD-ROM with MP3/WMA files on it is shown below. Subfolders are shown as folders in the folder currently selected.

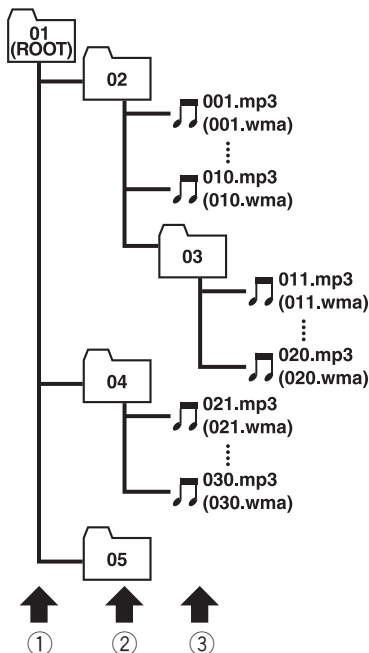

- ① First level
- ② Second level
- ③ Third level

Notes

- This unit assigns folder numbers. The user can not assign folder numbers.
- It is not possible to check folders that do not include MP3/WMA files. (These folders will be skipped without displaying the folder number.)

Additional Information

- MP3/WMA files in up to 8 tiers of folders can be played back. However, there is a delay in the start of playback on discs with numerous tiers. For this reason we recommend creating discs with no more than 2 tiers.
- It is possible to play back up to 253 items from folder on one disc. 

MD player and care

- Use MDs bearing this mark. Using a disc other than a music MD may result in damage to this unit.



- Do not open the MD shutter by hand. Forcing it open may result in damage.

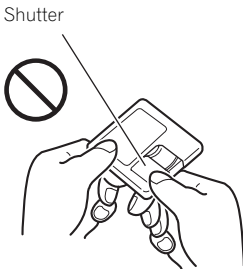

- Be sure to stick labels supplied with MDs in the specified location. Failing to do this, or sticking one label on top of another may make it impossible for the MD to be removed.

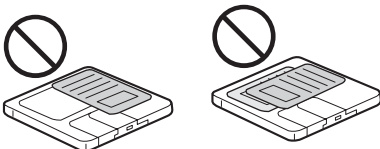

- Do not use MDs with labels that are not affixed correctly. Labels like this may catch on something, preventing removal of the MD. Before using an MD, remove the label if it is not correctly affixed, and replace it with a new label.

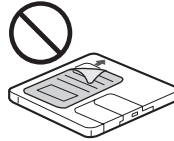

- Keep MDs out of direct sunlight and high temperatures.
- If the surface of an MD cartridge is dirty, wipe it gently with a clean, soft cloth.
- Do not apply benzene, thinner or other volatile liquids to MDs.
- When using an MD cleaning disc, be sure to read the disc's instructions carefully. Cleaning discs may result in damage to this unit.
- When it's cold, if you start playing an MD immediately after switching the heater in a room on, condensation on the optical lens inside the player or on the MD may prevent normal play. If this happens, turn off the player for about an hour to allow the condensation to evaporate, and wipe damp MD cartridge surfaces with a soft cloth. 

Additional Information

DSP adjustment value record sheet

3-way network mode **NW**

Network setting

Filter	L LPF	M HPF	M LPF	H HPF
Cutoff frequency				
Level				
Slope				
Phase				

Time alignment setting

Speaker unit	High Left	High Right	Mid Left	Mid Right	Low Left	Low Right
Distance						

Standard mode **STD**

Network setting

Filter	SW1 (SW2)	HPF F	HPF R
Cutoff frequency			
Level		—	—
Phase		—	—

Time alignment setting

Speaker unit	Front Left	Front Right	Rear Left	Rear Right	Sub. W
Distance					

Equalizer curves

CUSTOM2 curve

Frequency	50	80	125	200	315	500	800	1.25k	2k	3.15k	5k	8k	12.5k
Level													



Additional Information

Terms

Bit rate

This expresses data volume per second, or bps units (bits per second). The higher the rate, the more information is available to reproduce the sound. Using the same encoding method (such as MP3), the higher the rate, the better the sound.

ID3 tag

This is a method of embedding track-related information in a MP3 file. This embedded information can include the track title, the artist's name, the album title, the music genre, the year of production, comments and other data. The contents can be freely edited using software with ID3 Tag editing functions. Although the tags are restricted to the number of characters, the information can be viewed when the track is played back.

ISO9660 format

This is the international standard for the format logic of CD-ROM folders and files. For the ISO9660 format, there are regulations for the following two levels.

Level 1:

The file name is in 8.3 format (the name consists of up to 8 characters, half-byte English capital letters and half-byte numerals and the “_” sign, with a file-extension of three characters.)

Level 2:

The file name can have up to 31 characters (including the separation mark “.” and a file extension). Each folder contains less than 8 hierarchies.

Extended formats

Joliet:

File names can have up to 64 characters.

Romeo:

File names can have up to 128 characters.

m3u

Playlists created using the “WINAMP” software have a playlist file extension (.m3u).

MP3

MP3 is short for MPEG Audio Layer 3. It is an audio compression standard set by a working group (MPEG) of the ISO (International Standards Organization). MP3 is able to compress audio data to about 1/10th the level of a conventional disc.

Multi-session

Multi-session is a recording method that allows additional data to be recorded later. When recording data on a CD-ROM, CD-R or CD-RW, etc., all data from beginning to end is treated as a single unit or session. Multi-session is a method of recording more than 2 sessions in one disc.

Packet write

This is a general term for a method of writing on CD-R, etc. at the time required for a file, just as is done with files on floppy or hard discs.

VBR

VBR is short for variable bit rate. Generally speaking CBR (constant bit rate) is more widely used. But to flexibly adjust the bit rate according to the needs of audio compression, it is possible to achieve compression priorities sound quality.

WMA

WMA is short for Windows Media™ Audio and refers to an audio compression technology that is developed by Microsoft Corporation. WMA data can be encoded by using Windows Media Player version 7, 7.1 or Windows Media Player for Windows XP.

Microsoft, Windows Media, and the Windows logo are trademarks, or registered trademarks of Microsoft Corporation in the United States and/or other countries. ▣

Additional Information

Specifications

General

Rated power source	14.4 V DC
	(allowable voltage range: 12.0 – 14.4 V DC)
Grounding system	Negative type
Max. current consumption	10.0 A
Dimensions (W × H × D):	
Chassis	178 × 100 × 160 mm
Nose	169 × 94 × 17 mm
Weight	2.5 kg

Audio/DSP

Continuous power output is 22 W per channel minimum into 4 ohms, both channels driven 50 to 15,000 Hz with no more than 5% THD.

Maximum power output	50 W × 4
Load impedance	4 Ω (4 – 8 Ω allowable)
Preatt max output level/output impedance	1.8 V/1 kΩ
Loudness contour	+10 dB (100 Hz), +6.5 dB (10 kHz) (volume: –30 dB)
Equalizer (13-Band Graphic Equalizer):	
Frequency	50/80/125/200/315/500/800 Hz
	1.25/2/3.15/5/8/12.5 kHz
Equalization range	±12 dB
Auto equalizer (just for standard mode):	
Frequency	50/80/125/200/315/500/800 Hz
	1.25/2/3.15/5/8/12.5 kHz
Equalization range	+6 – –12 dB
Network (standard mode):	
HPF (Front/rear):	
Frequency	50/63/80/100/125 Hz
Slope	–12 dB/oct
Subwoofer:	
Frequency	50/63/80/100/125 Hz
Slope	–18 dB/oct
Gain	+6 – –24 dB
Phase	Normal/Reverse
Network (3-way network mode):	
High HPF:	
Frequency	1.6/2/2.5/3.15/4/5/6.3/8/10/12.5/16 kHz
Slope	–6/–12 dB/oct
Gain	0 – –24 dB/Mute
Phase	Normal/Reverse

Mid HPF/LPF:

Frequency (LPF) ...	1.6/2/2.5/3.15/4/5/6.3/8/10/12.5/16 kHz
---------------------	---

Frequency (HPF)

.....	31.5/40/50/63/80/100/125/160/200 Hz
-------	-------------------------------------

Slope (LPF)	0 (Pass)/–6/–12 dB/oct
Slope (HPF)	0 (Pass)/–6/–12/–18 dB/oct
Gain	0 – –24 dB/Mute
Phase	Normal/Reverse

Low LPF:

Frequency	31.5/40/50/63/80/100/125/160/200 Hz
-----------------	-------------------------------------

Slope	–6/–12/–18 dB/oct
Gain	+6 – –24 dB/Mute
Phase	Normal/Reverse

CD player

System	Compact disc audio system
Usable discs	Compact disc
Signal format:	
Sampling frequency	44.1 kHz
Number of quantization bits	16; linear
Frequency characteristics ...	5 – 20,000 Hz (±1 dB)
Signal-to-noise ratio	94 dB (1 kHz) (IEC-A network)
Dynamic range	92 dB (1 kHz)
Number of channels	2 (stereo)
MP3 decoding format	MPEG-1 & 2 Audio Layer 3
WMA decoding format	Ver. 7 & 8

MD player

System	Mini disc digital audio system
Usable discs	Mini disc
Signal format:	
Sampling frequency	44.1 kHz
Number of quantization bits	16; linear
Frequency characteristics ...	20 – 20,000 Hz (±1 dB)
Signal-to-noise ratio	90 dB (1 kHz) (IEC-A network)
Dynamic range	90 dB (1 kHz)
Number of channels	2 (stereo)

FM tuner

Frequency range	87.5 – 108.0 MHz
Usable sensitivity	8 dBf (0.7 μV/75 Ω mono, S/N: 30 dB)
50 dB quieting sensitivity	10 dBf (0.9 μV/75 Ω mono)

Additional Information

Signal-to-noise ratio	75 dB (IEC-A network)
Distortion	0.3 % (at 65 dBf, 1 kHz, stereo)
	0.1 % (at 65 dBf, 1 kHz, mono)
Frequency response	30 – 15,000 Hz (± 3 dB)
Stereo separation	45 dB (at 65 dBf, 1 kHz)

AM tuner

Frequency range	531 – 1,602 kHz (9 kHz)
	530 – 1,640 kHz (10 kHz)
Usable sensitivity	18 μ V (S/N: 20 dB)
Signal-to-noise ratio	65 dB (IEC-A network)

Infrared remote control

Wavelength	940 nm ± 50 nm
Output	typ; 12 mw/sr per Infrared LED



Notes

- US and foreign patents licensed from Dolby Laboratories.
- Specifications and the design are subject to possible modifications without notice due to improvements.



PIONEER CORPORATION

4-1, MEGURO 1-CHOME, MEGURO-KU, TOKYO 153-8654, JAPAN

PIONEER ELECTRONICS (USA) INC.

P.O. Box 1540, Long Beach, California 90801-1540, U.S.A.

TEL: (800) 421-1404

PIONEER EUROPE NV

Haven 1087, Keetberglaan 1, B-9120 Melsele, Belgium

TEL: (0) 3/570.05.11

PIONEER ELECTRONICS ASIACENTRE PTE. LTD.

253 Alexandra Road, #04-01, Singapore 159936

TEL: 65-6472-1111

PIONEER ELECTRONICS AUSTRALIA PTY. LTD.

178-184 Boundary Road, Braeside, Victoria 3195, Australia

TEL: (03) 9586-6300

PIONEER ELECTRONICS OF CANADA, INC.

300 Allstate Parkway, Markham, Ontario L3R OP2, Canada

TEL: (905) 479-4411

PIONEER ELECTRONICS DE MEXICO, S.A. de C.V.

Bldv.Manuel Avila Camacho 138 10 piso

Col.Lomas de Chapultepec, Mexico, D.F. 11000

TEL: 55-9178-4270

先鋒股份有限公司

總公司：台北市中山北路二段44號13樓

電話：(02) 2521-3588

先鋒電子（中國）有限公司

香港辦事處：香港銅鑼灣告士打道280號世界貿易中心

17樓 1704-06室

電話：(0852) 2848-6488

Published by Pioneer Corporation.

Copyright © 2003 by Pioneer Corporation.

All rights reserved.

파이오니아 코퍼레이션 출판 저작권 ©
2003 파이오니아 코퍼레이션. 모든 권리
보유함.

Printed in Japan

일본 인쇄

Free Manuals Download Website

<http://myh66.com>

<http://usermanuals.us>

<http://www.somanuals.com>

<http://www.4manuals.cc>

<http://www.manual-lib.com>

<http://www.404manual.com>

<http://www.luxmanual.com>

<http://aubethermostatmanual.com>

Golf course search by state

<http://golfingnear.com>

Email search by domain

<http://emailbydomain.com>

Auto manuals search

<http://auto.somanuals.com>

TV manuals search

<http://tv.somanuals.com>