

Pioneer

DVD PLAYER

DV-K102
DVD-V550

Operating Instructions



Please read through these operating instructions so you will know how to operate your model properly. After you have finished reading the instructions, put them away in a safe place for future reference.

- This player is not suitable for commercial use.

IMPORTANT



The lightning flash with arrowhead symbol, within an equilateral triangle, is intended to alert the user to the presence of uninsulated "dangerous voltage" within the product's enclosure that may be of sufficient magnitude to constitute a risk of electric shock to persons.



CAUTION:
TO PREVENT THE RISK OF ELECTRIC SHOCK, DO NOT REMOVE COVER (OR BACK). NO USER-SERVICEABLE PARTS INSIDE. REFER SERVICING TO QUALIFIED SERVICE PERSONNEL.



The exclamation point within an equilateral triangle is intended to alert the user to the presence of important operating and maintenance (servicing) instructions in the literature accompanying the appliance.

IMPORTANT SAFETY INSTRUCTIONS

READ INSTRUCTIONS — All the safety and operating instructions should be read before the product is operated.

RETAIN INSTRUCTIONS — The safety and operating instructions should be retained for future reference.

HEED WARNINGS — All warnings on the product and in the operating instructions should be adhered to.

FOLLOW INSTRUCTIONS — All operating and use instructions should be followed.

CLEANING — Unplug this product from the wall outlet before cleaning. The product should be cleaned only with a polishing cloth or a soft dry cloth. Never clean with furniture wax, benzine, insecticides or other volatile liquids since they may corrode the cabinet.

ATTACHMENTS — Do not use attachments not recommended by the product manufacturer as they may cause hazards.

WATER AND MOISTURE — Do not use this product near water — for example, near a bathtub, wash bowl, kitchen sink, or laundry tub; in a wet basement; or near a swimming pool; and the like.

ACCESSORIES — Do not place this product on an unstable cart, stand, tripod, bracket, or table. The product may fall, causing serious injury to a child or adult, and serious damage to the product. Use only with a cart, stand, tripod, bracket, or table recommended by the manufacturer, or sold with the product. Any mounting of the product should follow the manufacturer's instructions, and should use a mounting accessory recommended by the manufacturer.

CART — A product and cart combination should be moved with care. Quick stops, excessive force, and uneven surfaces may cause the product and cart combination to overturn.



VENTILATION — Slots and openings in the cabinet are provided for ventilation and to ensure reliable operation of the product and to protect it from overheating, and these openings must not be blocked or covered. The openings should never be blocked by placing the product on a bed, sofa, rug, or other similar surface. This product should not be placed in a built-in installation such as a bookcase or rack unless proper ventilation is provided or the manufacturer's instructions have been adhered to.

POWER SOURCES — This product should be operated only from the type of power source indicated on the marking label. If you are not sure of the type of power supply to your home, consult your product dealer or local power company.

LOCATION — The appliance should be installed in a stable location.

NONUSE PERIODS — The power cord of the appliance should be unplugged from the outlet when left unused for a long period of time.

GROUNDING OR POLARIZATION

- If this product is equipped with a polarized alternating current line plug (a plug having one blade wider than the other), it will fit into the outlet only one way. This is a safety feature. If you are unable to insert the plug fully into the outlet, try reversing the plug. If the plug should still fail to fit, contact your electrician to replace your obsolete outlet. Do not defeat the safety purpose of the polarized plug.
- If this product is equipped with a three-wire grounding type plug, a plug having a third (grounding) pin, it will only fit into a grounding type power outlet. This is a safety feature. If you are unable to insert the plug into the outlet, contact your electrician to replace your obsolete outlet. Do not defeat the safety purpose of the grounding type plug.

POWER-CORD PROTECTION — Power-supply cords should be routed so that they are not likely to be walked on or pinched by items placed upon or against them, paying particular attention to cords at plugs, convenience receptacles, and the point where they exit from the product.

OUTDOOR ANTENNA GROUNDING — If an outside antenna or cable system is connected to the product, be sure the antenna or cable system is grounded so as to provide some protection against voltage surges and built-up static charges. Article 810 of the National Electrical Code, ANSI/NFPA 70, provides information with regard to proper grounding of the mast and supporting structure, grounding of the lead-in wire to an antenna discharge unit, size of grounding conductors, location of antenna-discharge unit, connection to grounding electrodes, and requirements for the grounding electrode. See Figure A.

LIGHTNING — For added protection for this product during a lightning storm, or when it is left unattended and unused for long periods of time, unplug it from the wall outlet and disconnect the antenna or cable system. This will prevent damage to the product due to lightning and power-line surges.

POWER LINES — An outside antenna system should not be located in the vicinity of overhead power lines or other electric light or power circuits, or where it can fall into such power lines or circuits. When installing an outside antenna system, extreme care should be taken to keep from touching such power lines or circuits as contact with them might be fatal.

OVERLOADING — Do not overload wall outlets, extension cords, or integral convenience receptacles as this can result in a risk of fire or electric shock.

OBJECT AND LIQUID ENTRY — Never push objects of any kind into this product through openings as they may touch dangerous voltage points or short-out parts that could result in a fire or electric shock. Never spill liquid of any kind on the product.

SERVICING — Do not attempt to service this product yourself as opening or removing covers may expose you to dangerous voltage or other hazards. Refer all servicing to qualified service personnel.

DAMAGE REQUIRING SERVICE — Unplug this product from the wall outlet and refer servicing to qualified service personnel under the following conditions:

- When the power-supply cord or plug is damaged.
- If liquid has been spilled, or objects have fallen into the product.
- If the product has been exposed to rain or water.
- If the product does not operate normally by following the operating instructions. Adjust only those controls that are covered by the operating instructions as an improper adjustment of other controls may result in damage and will often require extensive work by a qualified technician to restore the product to its normal operation.
- If the product has been dropped or damaged in any way.
- When the product exhibits a distinct change in performance — this indicates a need for service.

REPLACEMENT PARTS — When replacement parts are required, be sure the service technician has used replacement parts specified by the manufacturer or have the same characteristics as the original part. Unauthorized substitutions may result in fire, electric shock, or other hazards.

SAFETY CHECK — Upon completion of any service or repairs to this product, ask the service technician to perform safety checks to determine that the product is in proper operating condition.

WALL OR CEILING MOUNTING — The product should not be mounted to a wall or ceiling.

HEAT — The product should be situated away from heat sources such as radiators, heat registers, stoves, or other products (including amplifiers) that produce heat.

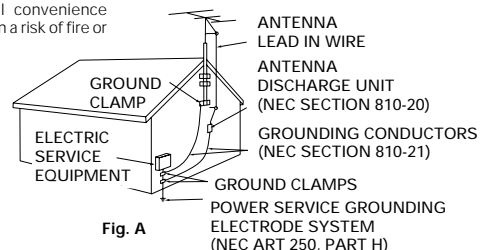

Fig. A

CONGRATULATIONS ON YOUR PURCHASE OF THIS FINE PIONEER PRODUCT.

Pioneer is on the leading edge of DVD research for consumer products and this unit incorporates the latest technological developments.

We are sure you will be fully satisfied with the DVD player.

Thank you for your support.

WARNING: TO PREVENT FIRE OR SHOCK HAZARD, DO NOT EXPOSE THIS APPLIANCE TO RAIN OR MOISTURE.

IMPORTANT NOTICE

[For U.S. model]

The serial number for this equipment is located on the rear panel. Please write this serial number on your enclosed warranty card and keep it in a secure area. This is for your security.

CAUTION: This product satisfies FCC regulations when shielded cables and connectors are used to connect the unit to other equipment. To prevent electromagnetic interference with electric appliances such as radios and televisions, use shielded cables and connectors for connections.

This equipment has been tested and found to comply with the limits for a Class B digital device, pursuant to Part 15 of the FCC Rules. These limits are designed to provide reasonable protection against harmful interference in a residential installation. This equipment generates, uses, and can radiate radio frequency energy and, if not installed and used in accordance with the instructions, may cause harmful interference to radio communications. However, there is no guarantee that interference will not occur in a particular installation. If this equipment does cause harmful interference to radio or television reception, which can be determined by turning the equipment off and on, the user is encouraged to try to correct the interference by one or more of the following measures:

- Reorient or relocate the receiving antenna.
- Increase the separation between the equipment and receiver.
- Connect the equipment into an outlet on a circuit different from that to which the receiver is connected.
- Consult the dealer or an experienced radio/TV technician for help.

Information to User

Alteration or modifications carried out without appropriate authorization may invalidate the user's right to operate the equipment.

CAUTION

- Use of controls or adjustments or performance of procedures other than those specified herein may result in hazardous radiation exposure.
- The use of optical instruments with this product will increase eye hazard.

[For Canadian model]

This Class B digital apparatus complies with Canadian ICES-003.

[Pour le modèle Canadien]

Cet appareil numérique de la classe B est conforme à la norme NMB-003 du Canada.

[For Canadian model]







CAUTION: TO PREVENT ELECTRIC SHOCK, DO NOT USE THIS (POLARIZED) PLUG WITH AN EXTENSION CORD, RECEPTACLE OR OTHER OUTLET UNLESS THE BLADES CAN BE FULLY INSERTED TO PREVENT BLADE EXPOSURE.

ATTENTION: POUR PREVENIR LES CHOCS ELECTRIQUES NE PAS UTILISER CETTE FICHE POLARISEE AVEC UN PROLONGATEUR, UNE PRISE DE COURANT OU UNE AUTRE SORTIE DE COURANT, SAUF SI LES LAMES PEUVENT ETRE INSEREES A FOND SANS EN LAISSER AUCUNE PARTIE A DECOUVERT.

Features of This Player

Compatible with DVD, Super VCD, Video CD and CD formats

DVD, Super VCD (IEC standard), Video CD and CD discs that display the logos shown below can be played back on this DVD player. For more information on discs compatible with this player, refer to the table below.

Types of playable discs and their marks	Diameter/ Playable sides	Playback time	
	DVD VIDEO	Digital audio Digital video (MPEG 2)	
	12 cm (5 in.)/ single-sided	1 layer 2 layer	133 min. 242 min.
	12 cm (5 in.)/ double-sided	1 layer 2 layer	266 min. 484 min.
	DVD VIDEO	Digital audio Digital video (MPEG 2)	
	8 cm (3 in.)/ single-sided	1 layer 2 layer	41 min. 75 min.
	8 cm (3 in.)/ double-sided	1 layer 2 layer	82 min. 150 min.
	SUPER VCD	Digital audio (MPEG 1) Digital video (MPEG 2)	40 min.
	12 cm (5 in.)/ single-sided		
	SUPER VCD single	Digital audio (MPEG 1) Digital video (MPEG 2)	10 min.
	8 cm (3 in.)/ single-sided		
	VIDEO CD	Digital audio Digital video (MPEG 1)	Max. 74 min.
	12 cm (5 in.)/ single-sided		
	VIDEO CD single	Digital audio Digital video (MPEG 1)	Max. 20 min.
	8 cm (3 in.)/ single-sided		
	CD	Digital audio	Max. 74 min.
	12 cm (5 in.)/ single-sided		
	CD single	Digital audio	Max. 20 min.
	8 cm (3 in.)/ single-sided		

The disc format logos shown above are found on disc labels or on disc jackets.

- To prevent malfunction, do not use an 8 cm (3 in.) adaptor (for CDs).
- Discs other than the ones indicated above cannot be played on this unit.
- DVDs that have incompatible region numbers, DVD-Audio, DVD-ROM, and CD-ROM cannot be played on this unit. The region number of the player can be found on the rear panel.

What is Super VCD ?

This player supports the IEC's Super VCD standard. Compared to the Video CD standard, Super VCD offers superior picture quality, and allows two stereo soundtracks to be recorded. Super VCD also supports the widescreen size.



Compatible with a wide range of DVD digital audio output formats



DVDs are recorded in one of four types of digital audio formats (as of October 1998). The digital audio output jacks of this player output Dolby Digital*, DTS**, MPEG, and linear PCM digital bitstreams.

This player has a function that converts Dolby Digital and MPEG audio formats into the linear PCM format. This allows playback of DVDs recorded in Dolby Digital and MPEG without the need for a decoder.

- * Manufactured under license from Dolby Laboratories. "Dolby", "AC-3" and the double-D symbol are trademarks of Dolby Laboratories. Confidential unpublished works, © 1992-1997 Dolby Laboratories. All rights reserved.
- ** "DTS" is a trademark of Digital Theater Systems, Inc.

Easy setup and adjustment using on-screen menus

Press **SETUP** on the remote control to open the Setup screen and you'll find setting up the system easy to do with on-screen menus conveniently organized and arranged. Additionally, on-screen information ⓘ appears to clarify the functions and explain the options available. Below are just a few examples.

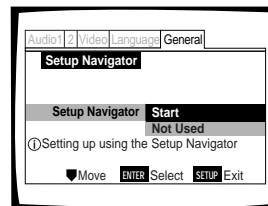

Answer a few questions and have all the necessary audio, video, and on-screen language adjustments set automatically by the player using the Setup Navigator (page 19).

Select the type of TV screen you are using and the preferred screen format you'd like to use when watching DVDs in the **Video** menu (page 29).

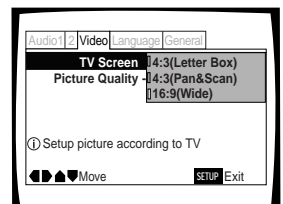

Wide range of DVD viewing options

Multi-Language Subtitles (page 37) ☆

You can select a subtitle language or turn subtitles off when watching movies or other media with subtitles available.

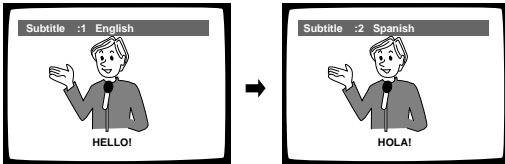

Multiple Languages (page 38) ☆

You can select the language on when watching movies or other media that have multiple language and/or audio soundtracks recorded on them.

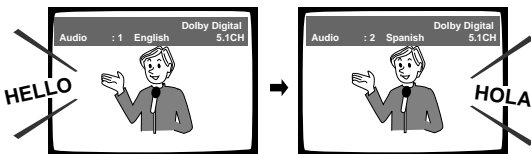

Multi-Angle (page 45) ☆

You can view scenes from different camera angles when watching movies or other media with multiple angle playback available.

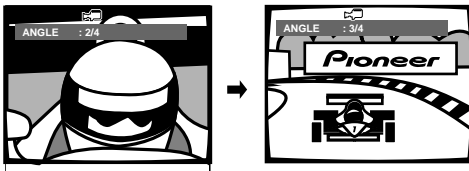

☆This mark indicates this may not be possible with certain discs.

Energy-saving design

This unit is designed to use minimal electricity when this player is in standby mode. Regarding the amount of power consumed in standby mode, refer to "Specifications" on page 60 (backcover).

This product incorporates copyright protection technology that is protected by method claims of certain U.S. patents and other intellectual property rights owned by Macrovision Corporation and other rights owners. Use of this copyright protection technology must be Authorized by Macrovision Corporation, and is intended for home and other limited viewing uses only unless otherwise authorized by Macrovision corporation. Reverse engineering or disassembly is prohibited.

Differences in Disc Composition

DVD

DVDs are divided into units referred to as titles, and titles are divided into chapters. A DVD which contains a movie may have only one title with many or no chapter divisions. Karaoke DVDs may have many titles, assigning a title to each song on the disc. Menu screens do not belong to any title.

DVD player functions generally apply to titles on a disc or chapters within a selected title. The player functions available may also vary from title to title, depending on the disc. When discs have a unique title division, it should be noted that search and program functions may be affected.

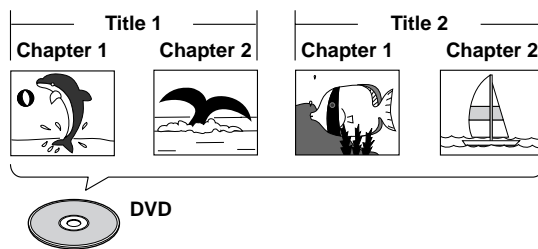

Super VCD/Video CD/CD

Super VCDs, Video CDs and CDs are divided into units referred to as tracks (Super VCDs and Video CD tracks may also be referred to as scenes). One song generally corresponds to one track. Some tracks are further divided into units referred to as indexes. Super VCDs/Video CDs with PBC (Playback Control) also contain menus recorded on the disc which enable easy access to the contents of the disc.

When played back on a DVD player, Super VCDs, Video CDs and CDs are considered to be a single title, regardless of the number of tracks.

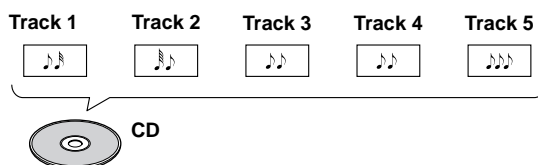
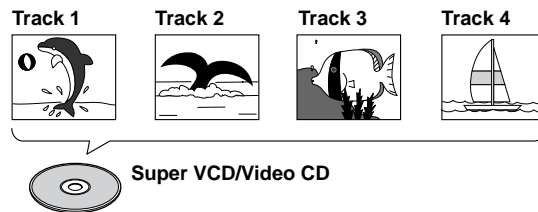

How to Proceed in This Manual

DVD is an incredible format that presents the highest quality digital audio and video available today.

Because using the DVD player and DVDs may be confusing at first, following the order below should help you get through the important stages of getting set up so you can start using your player as soon as possible.

Get familiar with the player.

Refer to the section "Before Using" on page 8 to confirm that all the accessories were included with the player. If you are new to DVD, it might be beneficial for you to go through the "Names and Functions" section starting on page 10 to get familiar with the parts and buttons on the main unit and remote control as they will be referred to throughout this manual.

There is also a list of terms that can be found on page 58 if you are having trouble understanding some of the terminology associated with DVD.

Make the necessary connections.

No entertainment system seems to be set up exactly the same way. The "Making Connections" section starting on page 16 shows how video and audio connections may be made to suit your home entertainment system.

Set up the player.

Before you can begin to enjoy the benefits of the DVD format, you should set up the player to output the video and audio information that corresponds to your system. The section "Setting Up the Player" starting on page 19 explains how to use the Setup Navigator, a function that automatically sets up the player corresponding to the answers given in a multiple-choice on-screen procedure. The Setup screen menus, described in the section starting on page 26, are also used in a number of other functions. Learning the procedure for operating the menus will make using this player much easier and more enjoyable.

Play a disc.

When all the connections and setups have been made, you are ready to play a DVD, Super VCD/Video CD, or CD with the player. The section "Getting Started Using Your DVD Player" starting on page 22 outlines the basic player operations.

Enjoy the many features available.

Once you are comfortable using the basic player functions, you are ready to take advantage of the various options DVD and this player have to offer. The section "Advanced Functions" starting on page 42 describes how to use the features available on many DVDs.

Table of Contents

Before Using 8

- Checking Accessories 8
- Preparing the Remote Control 8

Names and Functions 10

- Front Panel 10
- Display Window 12
- Rear Panel 13
- Remote Control 14

Making Connections 16

- Connecting Your DVD Player 16
- Audio Connections 17
- Video Connections 18
- System Control Connections 18

Setting Up the Player 19

- Using the Setup Navigator 19

Getting Started Using Your DVD Player 22

- Playing DVDs, Super VCDs, Video CDs and CDs 22
- Improving Picture Quality 23
- Chapter (Track) Skip Forward/Skip Back 24
- Forward and Reverse Scanning 24
- Stopping Playback and Switching Power Off 25

Adjusting Audio and Video Settings 26

- Using the Setup Screen Menus 26
- Changing the Setup Screen to "Expert" Menu Mode 27
- Setting the Digital Audio Output To Be Compatible with Your AV Components 28
- Setting the TV Screen Size 29
- Adjusting the OSD (On-Screen Display) 30

Karaoke Operation 31

- Karaoke Entertainment 31
- Adjusting to Create the Desired Sound 32
- One-Touch Karaoke 33
- Reserving a Desired Song 33
- Making Settings on the Karaoke Setup Menu 34

Setting the Language Options 37

- Selecting a Subtitle Language (Multi-Language Subtitles) 37
- Changing the Audio Language (Multi-Language Function) 38
- Setting Language and Subtitle Preferences in the Setup Screen Menus 39

Advanced Functions 42

- Adjusting the Dynamic Range of the Audio Soundtrack 42
- Selecting Picture Quality Appropriate for Program Content 42
- Still Frame/Slow Play/Frame Advance Playback 43
- Searching for a Title, Chapter, Track, or Location on a Disc 44
- Viewing from a Desired Camera Angle (Multi-Angle) 45
- Changing to Surround 45
- Repeat Play 46
- Setting the Parental Lock Level 47
- Continuing Playback from a Specified Location (Last Memory) 49
- Memorizing Settings for Often Viewed DVDs (Condition Memory) 50
- Viewing Disc Information 51
- Changing the Background Color of the Screen 52
- Resetting the Player to System Settings 52

Additional Information 53

- Disc Care 53
- For Proper and Long Use of This Unit 54
- Language Code List 55
- Troubleshooting 56
- Terms 58
- Specifications Backcover

Before Using

Checking Accessories

Please confirm that the following were received with the player.

Audio cord

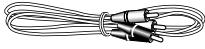

Video cord

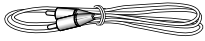

Remote control unit

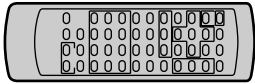

AA/R6P batteries

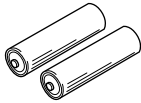

Power cord

Operating instructions (this manual)

Preparing the Remote Control

Inserting batteries into the remote control

- 1 While pushing the tab on the battery compartment cover toward the center of the remote, pull out in the direction indicated by the arrow.

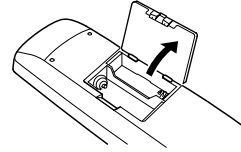

- 2 Insert batteries. Make sure to match the plus (+) and minus (-) polarity guides on the batteries with the marks inside the battery compartment.

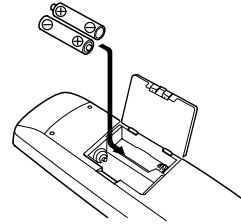

- 3 Close the cover.

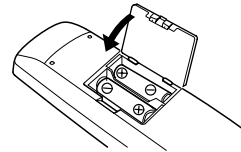

Notes

- Do not mix old and new batteries.
- When replacing batteries, use all new batteries.
- When not using the remote control for a long period of time (over 1 month), remove the batteries to avoid possible damage from battery corrosion. If battery leakage occurs, wipe the battery liquid from the battery component, then insert new batteries.

Remote control operation

When operating the remote control, point it at the remote sensor (FR) located on the player's front panel. The remote control can be used up to 7 m from the player and within a 30° angle on each side of the sensor.

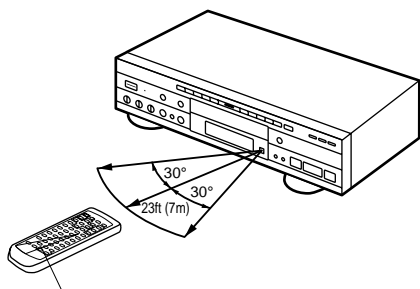

Notes

- Exposing the remote sensor to direct sunlight or strong light may cause faulty operation.
- If the CONTROL IN jack on the player's rear panel is connected to the CONTROL OUT jack of another component, point the remote control at the other component to operate the player. Operation will not be possible when pointed at this player (page 18).

Names and Functions

Front Panel

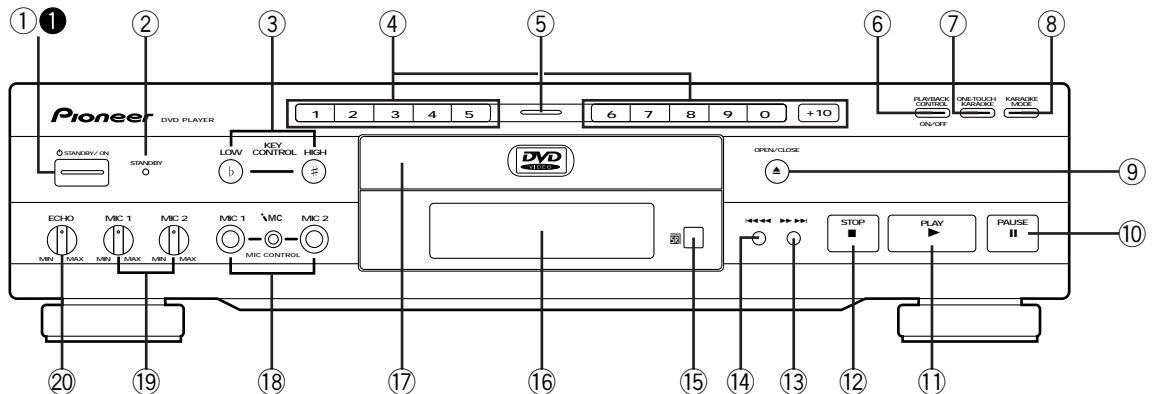

- ① [Models having a STANDBY/ON button on the main unit]
⏻ STANDBY/ON button
 Press to switch the player on or to put in standby (page 22).
- ❶ [Models having a POWER switch on the main unit]
POWER switch
 Press to switch the player on or off (pages 22 and 25).
 When this switch is "ON", the remote control can be used to switch the player between the "ON" state and standby.
- ② **STANDBY indicator**
 Indicates that the player is in standby, using a minimum amount of power to maintain system settings.
 Turns off when the player is on.
- ③ **KEY CONTROL buttons**
 Use to adjust the levels of the key in 11 steps. (pages 32 and 36)
- ④ **Number buttons (1-9, 0, +10)**
 Use to perform direct title and chapter/track searches, and to input numerical values (pages 23 and 44).
- ⑤ **Disc illumination**
 Lights when a DVD is loaded and when no disc is loaded. Turns off when a disc format other than DVD is loaded in the player.
- ⑥ **PLAYBACK CONTROL button and indicator**
 Use to switch the playback control for the Super VCD/Video CD on or off. (page 23)
- ⑦ **ONE-TOUCH KARAOKE button and indicator**
 Use to switch One-Touch Karaoke mode on or off. (page 33)
- ⑧ **KARAOKE MODE button and indicator**
 Use to switch between Karaoke mode and Normal mode. (pages 22 and 31)
- ⑨ **OPEN/CLOSE ▲ button**
 Press to open and close the disc tray (pages 22 and 25).
- ⑩ **PAUSE II button**
 Press during playback to pause. Press again to resume playback (page 43).
- ⑪ **PLAY ► button**
 Press to start or resume playback (pages 22 and 25).

- ⑫ **STOP ■ button**
Press to stop playback. Pressing once enables playback to resume from a point shortly before the location where it stopped. Pressing twice causes the disc to return to the beginning of the disc if playback starts again. Resume play is possible only in Normal mode (page 25).
- ⑬ **▶▶▶▶ (forward) button**
Press to advance to chapters/tracks. Press and hold to perform fast-forward scanning (page 24).
- ⑭ **◀◀◀◀ (reverse) button**
Press to go back to previous chapters/tracks. Press and hold to perform reverse playback scanning (page 24).
- ⑮ **Remote sensor**
Point the remote control toward the remote sensor to operate the player (page 9).
- ⑯ **Display window**
Displays system information (page 12).
- ⑰ **Disc tray**
When loading a disc, place a disc in the disc tray with the label side facing up (pages 22 and 25).
- ⑱ **MIC1, MIC2 and MIC CONTROL jacks**
Use to connect a microphone. (page 31)
- ⑲ **MIC1 and MIC2 volume level knobs**
Use to adjust the volume level of the microphone. (page 31)
- ⑳ **Digital Echo level knob**
Use to adjust the echo level. (page 32)

Display Window

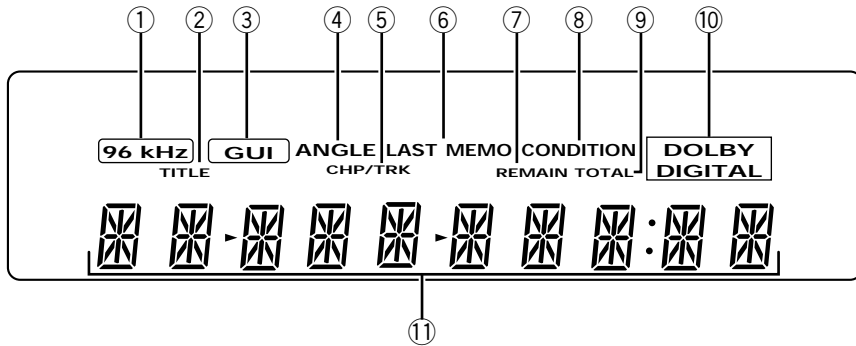

- ① **96 kHz indicator**
Indicates play of a disc outputting an audio signal with a sampling frequency of 96 kHz.
- ② **TITLE indicator**
Indicates a title number is being displayed.
- ③ **GUI indicator**
Lights when the Karaoke or Setup on-screen menus are being displayed (pages 19 and 26).
- ④ **ANGLE indicator**
Indicates Multi-Angle playback is in progress (page 45).
- ⑤ **CHP/TRK indicator**
Indicates a chapter or track number is being displayed.
- ⑥ **LAST MEMO indicator**
Indicates the Last Memory location is recorded in memory for the currently loaded DVD or Video CD (page 49).
- ⑦ **REMAIN indicator**
Indicates that the remaining playback time of a title or chapter/track is being displayed.
- ⑧ **CONDITION indicator**
Indicates that Condition Memory settings are memorized for the currently loaded DVD (page 50).
- ⑨ **TOTAL indicator**
Indicates that the disc in the player is stopped and **DISPLAY** has been pressed (page 51).
- ⑩ **DOLBY DIGITAL indicator**
Indicates Dolby Digital audio playback on DVDs.
- ⑪ **Counter display**
Displays the playback mode, type of disc, title and chapter/track numbers, playback time, etc.

Rear Panel

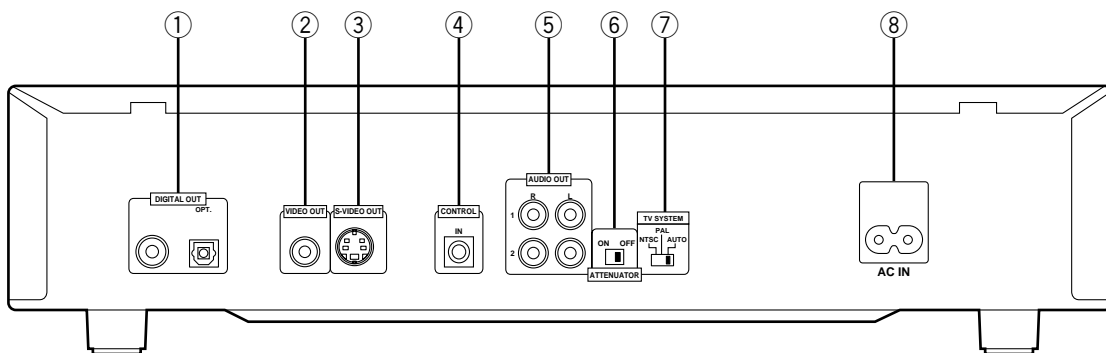

① DIGITAL OUT jacks (coaxial, optical (OPT.))

Use to output the digital audio signal recorded on discs. You can output the digital signal via either coaxial or optical output jack to an AV amplifier or receiver (page 17).

② VIDEO OUT jack

Connect to the video input on a TV or monitor or AV amplifier or receiver with video input capability (page 18).

③ S-VIDEO OUT jack

If your TV or monitor has an S-video input, clear picture reproduction is possible by connecting the player to your TV or monitor via the S-video jack (page 18).

④ CONTROL IN jack

Use to connect this player to another component bearing the Pioneer  mark. This lets you control this unit as though it were a component in a system. Player operations are then performed by pointing the remote control at the component that the player is connected to (page 18).

⑤ AUDIO OUT jacks

Use to output two-channel audio (analog) to the audio stereo inputs on a TV or stereo amplifier. If you are connecting to a receiver that has both digital and analog input jacks for DVD player connection, it may be beneficial to make both connections (page 17).

⑥ ATTENUATOR switch

Usually set to OFF. Switch it ON if the sound is distorted when enjoying Karaoke (page 32).

⑦ TV SYSTEM switch

Use to change the TV signal mode to either PAL or NTSC according to the type of TV and disc to be used. When the switch is in the AUTO position, the player outputs the format on the disc as is (page 18). (The TV SYSTEM switch is not present on DVD-V550.)

⑧ AC IN power cord connection terminal

Use to connect the power cord to the wall outlet (page 16).

Remote Control

(Buttons indicated with * are used for menu operation.)

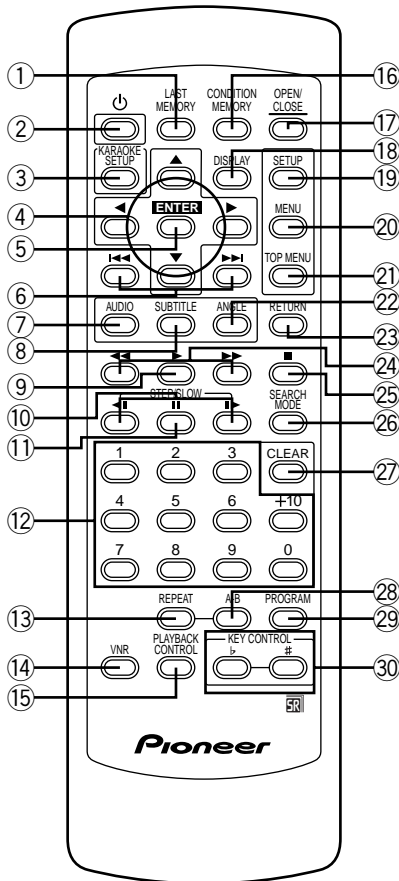

① LAST MEMORY button

You can resume DVD or Video CD playback from the point you last watched even if the disc is removed from the player. Press **LAST MEMORY** during playback to set a Last Memory point. When you want to resume playback of that disc, press **LAST MEMORY** in the stop mode and playback starts from the memorized point. Last Memory locations can be stored for up to 5 DVDs and 1 Video CD (page 49).

② (standby/on) button

Press to switch the player on or to put in standby (pages 22 and 25).

③ KARAOKE SETUP button*

Press to open or close the Karaoke Setup screen (page 34).

④ Cursor buttons (◀/▶/▲/▼)*

Use to move through the options on menu screens and to change settings (pages 19, 23, 26, 27, 47 and 48).

⑤ ENTER button*

Use to implement settings selected with the cursor buttons or to set items highlighted in a menu (pages 19, 23 and 27).

⑥ ◀◀ (previous)/▶▶ (next) buttons

During playback, press ◀◀ to go back to a previous chapter/track and ▶▶ to advance to the next chapter/track (page 24).

⑦ AUDIO button

Press repeatedly to select one of the audio languages and/or audio formats programmed on a DVD (page 38).

For Video CD and CD in Normal mode, each press changes the audio output as follows.

→ Stereo → 1/L (Left) → 2/R (Right) →

For Super VCD, each press changes the audio output as follows.

• Normal mode

→ 1 Stereo → 1L → 1R
→ 2R ← 2L ← 2 Stereo ←

• Karaoke mode

1 ↔ 2

- ⑧ **SUBTITLE button**
Press repeatedly to select one of the subtitle languages programmed on a DVD or to turn the subtitles off (page 37).
- ⑨ **▶ (play) button**
Press to start disc playback (pages 22 and 25).
- ⑩ **STEP/SLOW ◀II/II▶ buttons**
Press **STEP/SLOW II▶** during playback to view slow playback. In pause mode, press **STEP/SLOW II▶** to advance DVDs and Super VCDs/Video CDs frame by frame and **STEP/SLOW ◀II** to back up a few frames at a time. Reverse STEP/SLOW is not possible with a Super VCD/Video CD (page 43).
- ⑪ **II (pause) button**
Press to pause playback of a disc. Press again to resume playback (page 43).
- ⑫ **Number buttons (1-9, 0, +10)***
Use to perform direct title and chapter/track searches, and to input numerical values (pages 23 and 44).
- ⑬ **REPEAT button**
Press to repeat playback (page 46).
- ⑭ **VNR button**
Press to turn on the video noise reduction function (page 23).
- ⑮ **PLAYBACK CONTROL button**
Use to switch the playback control for the Super VCD/Video CD on or off. (page 23)
- ⑯ **CONDITION MEMORY button**
You can store in memory the settings for up to 15 DVDs. Press **CONDITION MEMORY** during DVD playback to memorize the settings (page 50).
- ⑰ **OPEN/CLOSE button**
Press to open or close the disc tray (pages 22 and 25).
- ⑱ **DISPLAY button**
Press during playback to display statistical disc information. Press repeatedly to display different information (page 51).
- ⑲ **SETUP button***
Press when the player is in either play or stop mode to open and close the Setup screen (page 26).
- ⑳ **MENU button***
Use to display or close the DVD menu screen (page 23).
- ㉑ **TOP MENU button***
Press to call up the top menu programmed on the DVD. Depending on the DVD, the top menu may be identical to the DVD menu (page 23).
- ㉒ **ANGLE button**
Some DVDs are recorded with various camera angle playback options. Press **ANGLE** repeatedly to display different camera angles (page 45).
- ㉓ **RETURN button***
Use to go one menu back (current settings are maintained). Use **RETURN** when you do not want to change the option setting in a menu (pages 23, 27, and 48).
- ㉔ **◀◀ (fast reverse)/▶▶ (fast forward) buttons**
During playback of DVD, Super VCD and Video CD, press **▶▶** to perform fast forward scanning. Press **◀◀** to perform fast reverse scanning of DVD, Super VCD and Video CD. When a CD is loaded, audio scanning is performed (page 24).
- ㉕ **■ (stop) button**
Press to stop playback. In Normal mode, pressing once enables playback to resume from a point shortly before the location where it was stopped. Pressing twice causes the disc to return to the beginning of the disc when playback starts again. Resume play is possible only in Normal mode (page 25).
- ㉖ **SEARCH MODE button**
Press to perform a title, chapter/track or time search (page 44).
- ㉗ **CLEAR button**
Works in conjunction with a number of player functions. Use to cancel repeat (page 46).
- ㉘ **A-B button**
Press at the beginning and end of the section you want to repeat or to mark a location you want to return to (page 46).
- ㉙ **PROGRAM button**
You can use this button to program up to 24 subsequent tracks while you are singing. (page 33)
- ㉚ **KEY CONTROL buttons**
Use to adjust the levels of the key in 11 steps. (pages 32 and 36)

Making Connections

Connecting Your DVD Player

Unlike any other audiovisual media format, DVD offers a wide array of audio and video output options which allows playback to be enjoyed in any number of system configurations from a standard TV with stereo audio input to a home theater system with a projection monitor and full surround sound capabilities.

Connection Guide

The illustration on this page shows the basic setup using the audio and video cords included with this player. Use this illustration as a guide to setting up your home system.

An explanation of each type of audio and video connection available can be found on the following pages. To determine the best audio and video connection setup for your system, refer to the manuals supplied with the components you are making connections to.

In addition to making physical connections to your TV or monitor, it is also necessary to assign the TV screen size. You can use the [Setup Navigator] in the Setup screen **General** menu to set whether you are using a wide screen or standard size TV or monitor (page 20). Additionally, you can use the [TV Screen] setting in the Setup screen **Video** menu (page 29).

Notes

- When making connections to this unit or when changing connections, check that the unit is in standby (off) by pressing **STANDBY/ON (POWER)**, and unplug the power cord from the power outlet.
- The analog video output on this player uses copy protect circuitry to prevent the video playback on DVDs from being copied. If you connect the player to a TV via a VCR, or record and play back the contents of a disc with a VCR, the playback picture may not be normal.

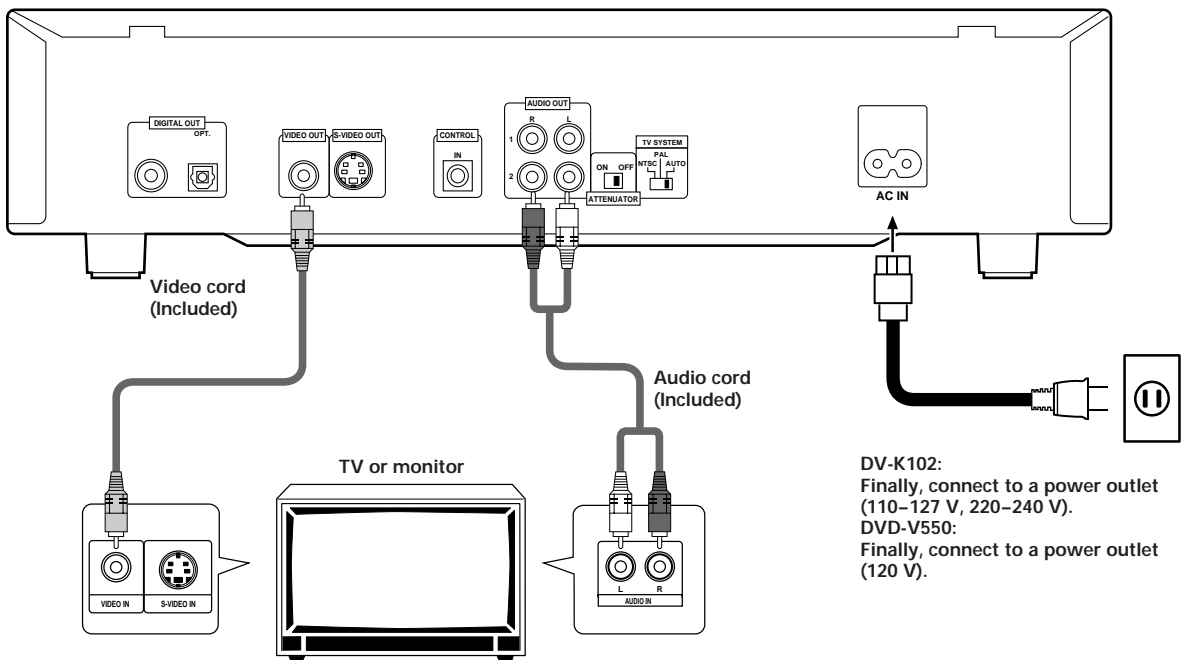

Make video connections from the VIDEO OUT jack on the player to the VIDEO IN jack on the TV or monitor using the video cord included with the player.

Make audio connections from one of the AUDIO OUT jacks on the player to the AUDIO IN jacks on the TV or monitor using the stereo audio cord included with the player. Be sure to match the color of the plugs with the color of the jacks (red and white).

When music sounds distorted during Karaoke, set the attenuator switch to the ON position.

DV-K102:
Finally, connect to a power outlet (110–127 V, 220–240 V).
DVD-V550:
Finally, connect to a power outlet (120 V).

Audio Connections

This player features two digital (optical and coaxial) and also analog 2 channel audio output connection possibilities.

Digital Audio Connections:

You can enjoy the digital audio recorded on DVD discs from both optical digital and coaxial digital output jacks.

When making digital audio connections, do not make connections from both the coaxial and optical digital outputs to the same component.

When a DVD recorded in Dolby Digital, DTS, or MPEG is loaded, noise will be output if you have made connections via the digital audio jacks to a receiver or amplifier that cannot decode a Dolby Digital, DTS, or MPEG digital bitstream. In this case, be sure to set the [Digital jack] setting in the Setup Navigator audio settings to best reflect the type of system you are using (page 21). Additionally, the digital audio settings can be adjusted manually in the Setup screen **Audio 1** menu (page 26).

Note

There is no digital output when the player is set to Karaoke mode.

DIGITAL OUT (Optical)

The digital signal is transmitted as light pulses through a fiber-optic cable.

- Use to connect to an AV amplifier or receiver with built-in Dolby Digital, DTS, or MPEG decoder.
- Use a fiber-optic cable (not supplied) to connect the digital optical output on the player to the digital optical input on an AV amplifier or receiver.

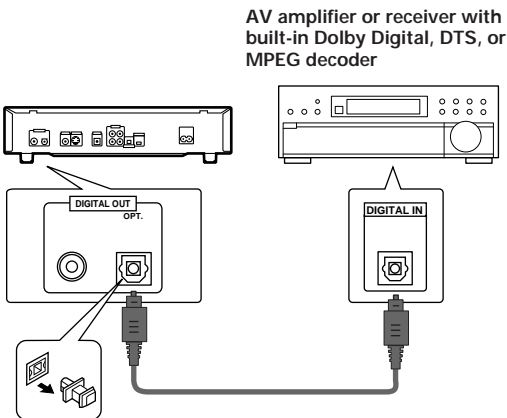

DIGITAL OUT (Coaxial)

The digital signal is transmitted electronically through a coaxial cable.

- Use to connect to an AV amplifier or receiver with built-in Dolby Digital, DTS, or MPEG decoder.
- Use a coaxial cable (not supplied) to connect the coaxial digital output on the player to the coaxial digital input on an AV amplifier or receiver.

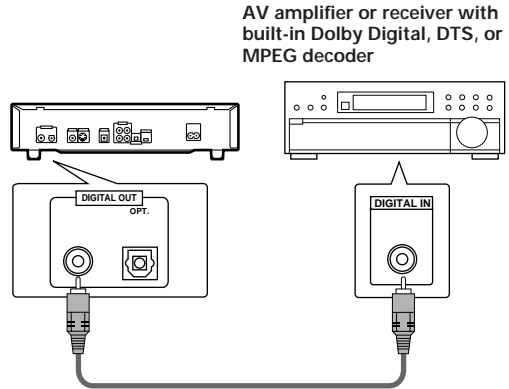

Analog Audio Connection:

AUDIO OUT

- Make analog audio connections to a stereo amplifier or receiver.
- Analog audio connections can also be made to a TV or monitor with stereo input jacks.
- Use the supplied audio cable to connect one of the AUDIO OUT analog jacks on the player to the audio input on the stereo amplifier or receiver.
- When making analog audio connections, be sure to match the color of the plugs with the color of the jacks (red and white).

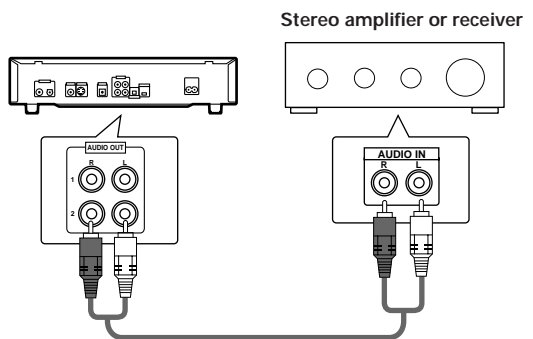

Video Connections

This player features S-video and composite video output possibilities. Check the manual supplied with your TV or monitor to determine the best possible connection for your system.

In addition to making physical connections to your TV or monitor, it is also necessary to assign the TV screen size. You can use the [Setup Navigator] in the Setup screen **General** to set whether you are using a wide screen or standard size TV or monitor (page 20). Additionally, you can use the [TV Screen] setting in the Setup screen **Video** menu (page 29).

S-VIDEO OUT

- Make S-video connections to a TV or monitor with S-video input to produce a high quality video image.
- Use an S-video cable (not supplied) to connect the output on the player to S-video input on the TV or monitor.

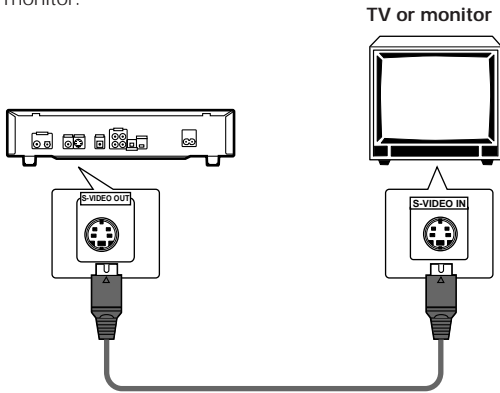

VIDEO OUT

- Make composite video connections to a standard TV or monitor with a video input jack.
- Use the supplied video cable to connect the video output jack on the player to the video input on the TV or monitor.
- Be sure to match the color of the plug with the color of the jack (yellow).

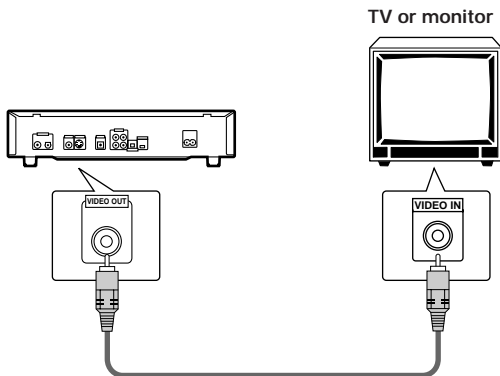

TV SYSTEM switch (except for DVD-V550)

Video output changes as follows according to the playback disc's recorded format.

NTSC → PAL, PAL → NTSC conversion is possible on Super VCDs/Video CDs. PAL → NTSC conversion is not possible on DVDs. When the TV SYSTEM switch is set to the AUTO position, the disc's format will be output as is. When a CD or disc is not loaded, the previous video output format will be selected.

Disc		Output format		
Type	Format	Position of TV SYSTEM switch		
		NTSC	PAL	AUTO
DVD	NTSC	NTSC	MOD. PAL	NTSC
	PAL	—	PAL	PAL
Super VCD/ Video CD	NTSC	NTSC	MOD. PAL	NTSC
	PAL	NTSC	PAL	PAL
CD, No disc		NTSC	PAL	NTSC or PAL

About MOD. (Modulation) PAL

- SHRINK
Most models of the newly developed countdown PAL TV system detect 50 Hz (PAL)/60 Hz (NTSC) and automatically switch vertical amplitude, resulting in a display without shrinkage.
- If your PAL TV does not have a V-Hold control, you may not be able to view NTSC disc because the picture may roll. If the TV has a V-Hold control, adjust it until the picture stops rolling. On some TVs, the picture may shrink vertically, leaving black bands at the top and bottom of the screen. This is not a malfunction; it is caused by the NTSC → PAL conversion.

System Control Connections

Using a commercially available cord with a mini plug (3.5 mm dia. with no resistance) to connect this player's CONTROL IN jack to the CONTROL OUT jack of another PIONEER component bearing the mark, you can control the player as though it were a component in a system (system control).

- If you connect for system control, you cannot operate the player directly. Point the remote control unit at the component (AV amplifier, etc.) connected to the CONTROL OUT jack to operate.
- When controlling as a system, be sure to make a connection to the amplifier **using an audio or video cord**, even when using only digital components.
- For details, refer to the operation manuals of the connected components.

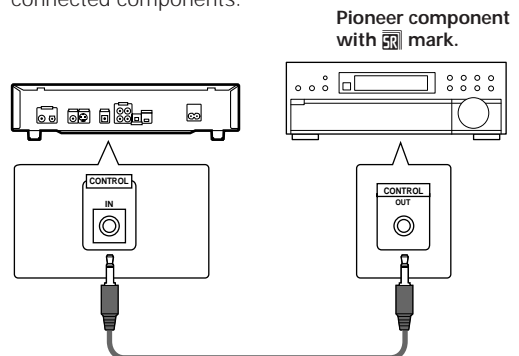

Setting Up the Player

Using the Setup Navigator

The Setup Navigator has been designed to simplify the process of getting the DVD player ready to perform. Designed as a series of on-screen multiple-choice questions, the Setup Navigator automatically sets the audio, video and language settings according to how the questions are answered. Once this procedure is complete, it will be possible to begin using the DVD player to enjoy DVDs.

The procedure on this page describes the operations necessary to function within the Setup Navigator screens. A detailed description of the contents of each question that appears on the screen can be found on the following page.

When setting up for the first time

Some DVDs start playing automatically when loaded in the player. Because the Setup Navigator cannot be used if a disc is playing, it is recommended to set up the player using the Setup Navigator before loading a DVD for the first time. If a DVD has been loaded, be sure to press **STOP** ■ before proceeding.

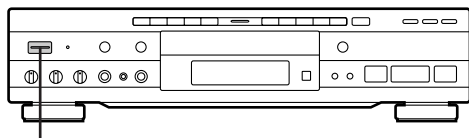

1

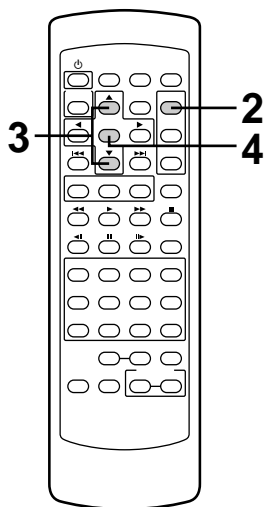

- 1 [Models having a STANDBY/ON button on the main unit]

Press **STANDBY/ON** on the front panel to turn the player on.

[Models having a POWER switch on the main unit]

Press **POWER** on the front panel to turn the player on.

- 2 Press **SETUP**.

When **SETUP** is pressed for the first time, the following screen appears. Though the Setup Navigator may be used more than once, this screen only appears the first time **SETUP** is pressed.

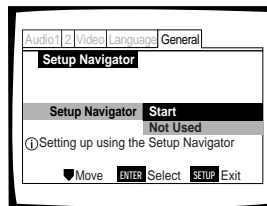

- 3 Use the cursor buttons (▲/▼) to make a selection.

- If you are going to use the Setup Navigator, it is not necessary to change the setting on the first screen. Please proceed to the next step.
- If you want to set up the player without using the Setup Navigator, use the cursor button (▼) to select "Not Used" at this time. The Setup Navigator function may still be used at a later time in manual Setup screen menu operation (page 26).

- 4 Press **ENTER**.

The selection is entered and the next Setup Navigator screen appears.

Use steps 3 and 4 as a basis for entering selections on all of the Setup Navigator screens described on the following pages.

To change the answer to a prior question

Use the cursor button (◀) to return to previous screens. Please note, however, that you cannot go forward using the cursor button (▶), so it will be necessary to answer all the questions that occur after the screen that was returned to.

To exit the Setup Navigator

Press **SETUP** while on any of the screens to exit the Setup Navigator. Please note that if the Setup Navigator is exited before all the questions are answered, no settings are changed.

To return to the Setup screen

Press **RETURN**. The Setup Navigator is exited and the Setup screen **General** menu screen appears. Please note that no settings are changed if **RETURN** is pressed before the Setup Navigator is finished.

Setting the OSD Language (On-Screen Display Language) (Chinese model only)

The [OSD Language] screen establishes the OSD language, or on-screen display language, which refers to the language that is used by the player in menus and on-screen messages. Additionally, the language that is established at this setting will also be used for the default audio and subtitle language.

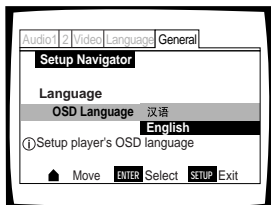

Settings: 汉语*
English

* Factory setting

Note

In addition to setting the OSD language, the audio and subtitle language are also set at this time. If you wish to change the audio or subtitle language to a different language, make changes in the Setup screen **Language** menu [Audio Language] and [Subtitle Language] as needed (page 39).

Setting the TV screen size

The [TV Connection] screen establishes the size, or more appropriately the width to height ratio of your television or monitor. The width-to-height ratio of conventional TVs is 4:3, while the width-to-height ratio of wide screen and high-definition TVs is 16:9. This width-to-height ratio is called the aspect ratio.

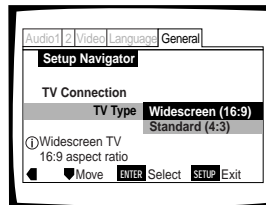

Settings: **Widescreen (16:9)***
Standard (4:3)

* Factory setting

Note

There are two screen formats that can be used to display wide-screen format DVDs: letter box and pan&scan. When "Standard (4:3)" is selected in the Setup Navigator, the letter box screen format is automatically selected. To switch the preference to the pan&scan format, make changes in the Setup screen **Video** menu [TV screen setting] (page 29).

Setting digital audio connections to an AV amplifier or decoder

The [Digital Jack] screen establishes whether digital connections have been made to an AV amplifier, receiver, or external decoder. As there are numerous options available, please refer to the instructions supplied with the component the player is connected to to determine what digital audio formats can be decoded. If you have made no digital connections, select "Not Connected".

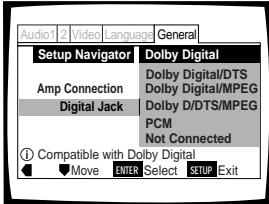

Settings: **Dolby Digital***

- Dolby Digital/DTS
- Dolby Digital/MPEG
- Dolby D/DTS/MPEG
- PCM
- Not Connected

* Factory setting

Note

The Karaoke function cannot be used with the DIGITAL OUT jack.

Setting compatibility with 96 kHz output

The [96 kHz PCM Audio] screen establishes whether or not the AV component the player is connected to is capable of processing an audio signal with a sampling rate of 96 kHz. This screen only appears if connections have been made to an external AV component as determined in previous screens.

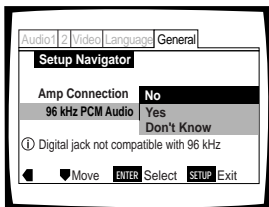

Settings: **No***

Select if the connected AV component cannot process an audio signal with a sampling rate of 96 kHz.

Yes

Select if the connected AV component can process an audio signal with a sampling rate of 96 kHz.

Don't Know

Select if you are uncertain whether the connected AV component can process an audio signal with a sampling rate of 96 kHz.

* Factory setting

Confirming the settings

The [Exit Setup Navigator] is the final screen in the Setup Navigator.

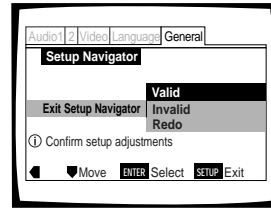

Settings: **Valid***

Select to have the player make all of the necessary audio, video and language settings according to your responses in the Setup Navigator.

Invalid

Select to exit the Setup Navigator without changing any of the system settings.

Redo

Select to return to the [OSD Language] (Chinese model only) or the [TV Type] screen of the Setup Navigator and do the settings again.

* Factory setting

To exit the Setup screen

When you have completed setting up the player using the Setup Navigator or if you exit the Setup Navigator, the Setup screen **General** menu appears. Press **Setup** to close the Setup screen.

To change other player settings in the Setup screen menus

The procedure for changing the settings in the Setup screen menus is described on page 26.

Getting Started Using Your DVD Player

Playing DVDs, Super VCDs, Video CDs and CDs

– DVD/Super VCD/Video CD/CD

Before you can start to enjoy the digital audio and video on DVDs, be sure that you have either performed the Setup Navigator procedure described in the previous section or made the necessary settings in the Setup screen menus as outlined in the next section to set up the player to correspond to your home system. Having made these settings, you are now ready to start using the player to enjoy DVDs, Super VCDs, Video CDs, and CDs.

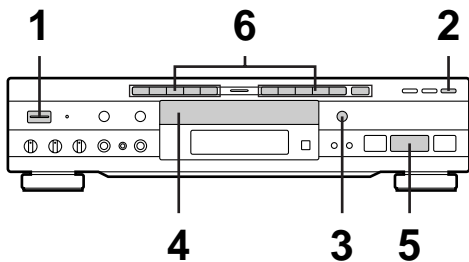
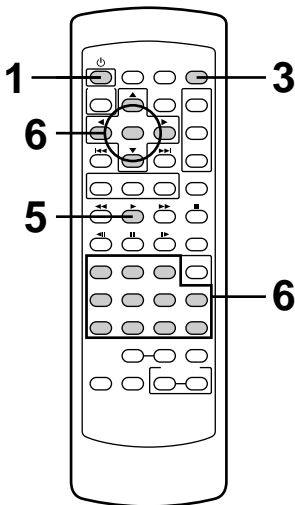

When an operation is prohibited

There are times when you are using the player and attempt to perform an operation, but for some reason it cannot be performed. When this occurs, one of the two following icons appears on the screen.



The operation is prohibited by the player.



The operation is prohibited by the programming on the disc.

- 1 [Models having a STANDBY/ON button on the main unit]
Press **⏻** (⏻ **STANDBY/ON** on the front panel).
[Models having a POWER switch on the main unit]

Press **POWER** on the front panel.

- When the STANDBY indicator lights, you can power on with the remote control.

- 2 Press **KARAOKE MODE** to select Normal mode.

Karaoke mode: When using the Karaoke function

Normal mode: When enjoying movies or music

- Each time you press this button, the setting changes as follows:



- 3 Press **OPEN/CLOSE ▲**.

The disc tray comes out.

- 4 Load a disc.

Load a disc with the label side facing up, using the disc tray guide to align the disc.

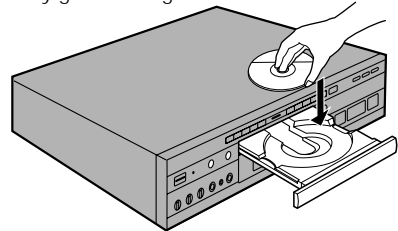

- 5 Press **PLAY ►**.

- Depending on the disc, a menu may be displayed. If a menu is displayed, proceed to step 6.

- 6 Select the item you want to view.

- When a DVD is loaded:
Use the cursor buttons (◀/▶/▲/▼) to select the item, then press **ENTER**. You may also be able to use the number buttons for direct selection (Depending on the disc, you may not be able to use the number buttons).
- When a Super VCD/Video CD is loaded:
Use the number buttons to select the item.

Notes

- Noise is output if you make digital audio connections to a receiver or amplifier that does not have a built-in decoder. Check that the digital audio output format selected in the **Audio 1** menu corresponds to the audio components you have made connections to (page 28).
- The TV screen size is factory set to present the wide screen format (16:9 aspect ratio). If you have a standard TV screen (4:3 aspect ratio), this setting can be changed to match your TV screen size in the **Video** menu (page 29).

When a menu screen is displayed

Menu screens are displayed for DVDs that have menu screens or Super VCDs/Video CDs that include Playback Control (PBC). DVDs often contain extra information that can be accessed in the DVD menu and sometimes makes navigating DVD menu screens as enjoyable as watching the feature presentation.

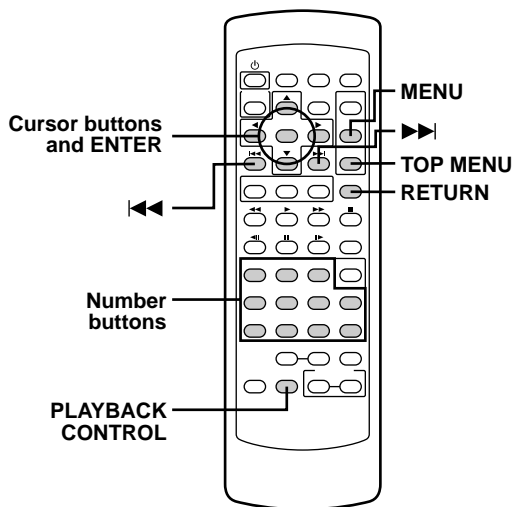

Example: When a DVD that has menu screens is loaded

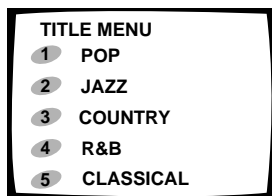

Example: When a Super VCD/Video CD that has Playback Control is loaded

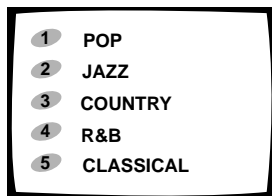

To open or return to the DVD or Super VCD/Video CD menu screen

Although this differs depending on the disc, pressing **MENU**, **TOP MENU**, or **RETURN** during DVD playback or **RETURN** during Super VCD/Video CD playback displays the menu screen. Refer to the DVD or Super VCD/Video CD disc jacket and accompanying documentation for more information.

To navigate a menu screen

- Although individual DVD titles may differ, when a menu screen is displayed, use the cursor buttons (◀/▶/▲/▼) and **ENTER** on the remote control. The cursor buttons are used to move around the options on the screen and **ENTER** is used for selection.
- Occasionally, the number buttons may also be used to make selections. If this is possible, using number buttons serves to directly select an option on a menu screen. Only number buttons are used to make selections on Super VCD/Video CD menu screens.
- When the Super VCD/Video CD has more than one menu, pages can be advanced to or returned to with ◀◀ or ▶▶.

Note

If a Super VCD does not comply with the IEC standards, the player may stop unexpectedly when the menu screen is displayed. If this happens, set the **PLAYBACK CONTROL** function to "OFF" and then use the Super VCD.

To play Super VCDs/Video CDs without displaying menu screens

Super VCDs/Video CDs with Playback Control (PBC) display a menu screen when play is started. It is possible, however, to playback Super VCDs/Video CDs without displaying menu screens.

When a Super VCD/Video CD with PBC is loaded, press **PLAYBACK CONTROL**, and then the number button of the track you want to play.

Improving Picture Quality

If the video picture of a DVD or Super VCD/Video CD displays a lot of video noise (tiny flecks or spots on that appear randomly and briefly on the screen), using this player's video noise reduction feature may be able to reduce the amount of video noise and improve the overall quality of the video image.

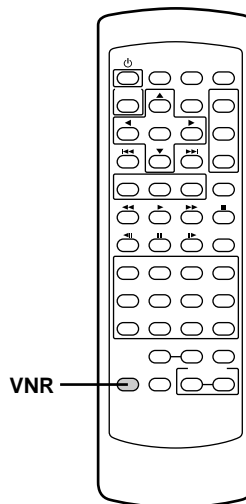

Press **VNR** to turn video noise reduction on.

- Press VNR again to turn video noise reduction off.

Chapter (Track) Skip Forward/ Skip Back – DVD/Super VCD/Video CD/CD

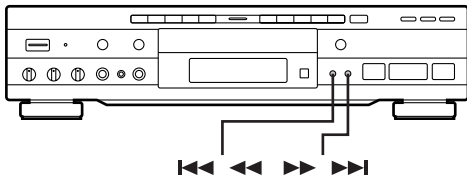
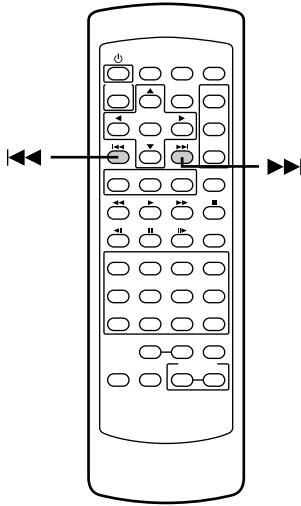

Advancing to the next chapter (track)

Press **▶▶** (▶▶▶▶ on the front panel).

- Press to skip forward to the next chapter (track).
- When a CD is loaded, you can advance more than one track forward by pressing and holding **▶▶** and releasing when the desired track number appears in the display.

Skipping back to the previous chapter (track)

Press **◀◀** (◀◀◀◀ on the front panel).

- Press once to skip back to the start of the chapter (track) currently playing.
- Press twice to skip back to the start of the previous chapter (track).
- When a CD is loaded, you can skip back to the track you want to hear by pressing and holding **◀◀** and releasing when the desired track number appears in the display.

Forward and Reverse Scanning – DVD/Super VCD/Video CD/CD

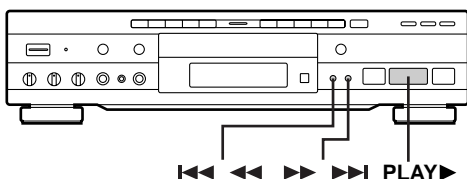
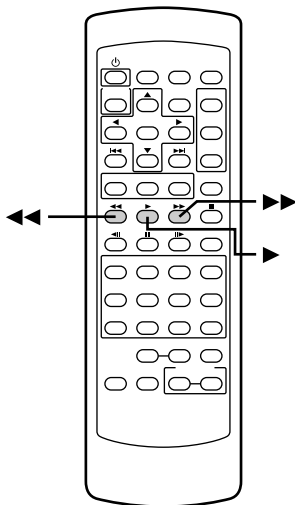

Fast forward scanning

Press and hold **▶▶** (▶▶▶▶ on the front panel) during playback.

- Release **▶▶** when you reach the desired location. Normal playback resumes.
- When the "Scan" indicator on the screen changes from flashing to lit, fast forward scanning will continue even if the button is released. When the desired location has been reached, press **▶ (play)**.

Fast reverse scanning

Press and hold **◀◀** (◀◀◀◀ on the front panel) during playback.

- Release **◀◀** when you reach the desired location. Normal playback resumes.
- When the "Scan" indicator on the screen changes from flashing to lit, fast reverse scanning will continue even if the button is released. When the desired location has been reached, press **▶ (play)**.

Stopping Playback and Switching Power Off

– DVD/Super VCD/Video CD/CD

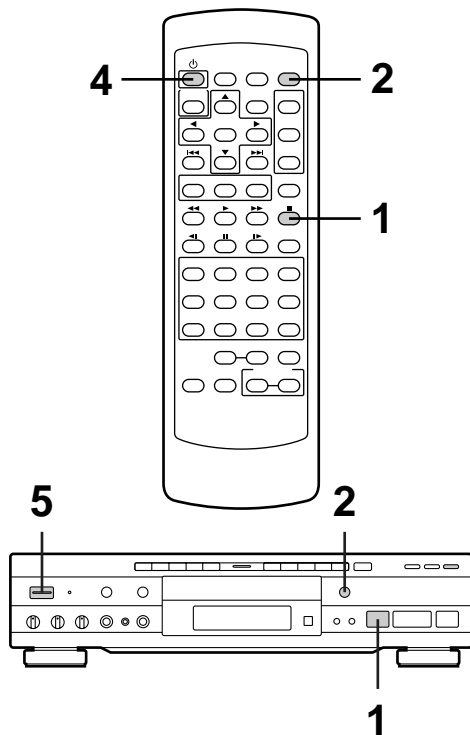

1 Press **STOP ■**.
Playback stops.

2 Press **OPEN/CLOSE ▲**.
The disc tray comes out.

3 Remove the disc.

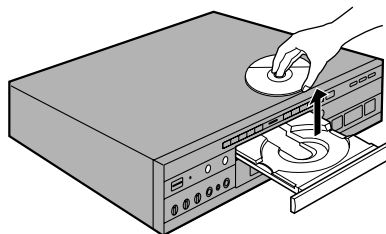

4 Press **⏻** on the remote control.
The disc tray goes back in.

5 [Models having a POWER switch on the main unit]
Check that the " - - OFF - -" indication on the display goes off, then press **POWER** on the front panel.

Resuming playback from where you stopped -- DVD/Video CD

Resume play is possible only in Normal mode.

With this player, it is possible to resume play of a DVD or Video CD even when play has been stopped.

Press **STOP ■** once to enable play to resume from a point shortly before the DVD/Video CD was stopped when **PLAY ►** is pressed again.

- To begin disc playback from the beginning, press **STOP ■** twice to turn off resume playback, and then start playback again.
- When **STOP ■** is pressed, "RESUME" appears in the display for as long as resume playback is possible. If the function is canceled, "RESUME" disappears and the disc format appears in the display.

Notes

- Resume play is only possible when the disc is loaded and **STOP ■** has not been pressed twice in succession ("RESUME" appears in the display). If you want to continue viewing a DVD at a later time or date, it is recommended to use the Last Memory function described on page 49.
- Resume play is not possible in Karaoke mode.
- If the player is switched to Karaoke mode after resume play is set in Normal mode, resume play is canceled.
- Resume play is cancelled if the PLAYBACK CONTROL is turned ON/OFF while resume play is set.
- Resume play is not possible with Super VCDs and CDs.
- For some discs, playback may not start from the position at which it was stopped.

Adjusting Audio and Video Settings

Using the Setup Screen Menus

The procedure on this page describes how to operate the menus on the Setup screen. These menus are used to set and adjust a number of system settings. The various functions that can be adjusted are covered throughout this manual. The procedure on this page provides a basic outline for using the Setup screen menus.

When setting up for the first time

It is recommended to set up player using the Setup Navigator (page 19). If you selected "Not Used" when the Setup Navigator appears, you may still set up the player using the Setup Navigator in the **General** menu screen.

If you choose not to use the Setup Navigator, be sure to make the necessary settings in the Setup screen **Audio 1**, **Audio 2**, **Video**, and **Language** menus as described on the following pages.

Some DVDs start playing automatically when loaded in the player. If a DVD has been loaded, be sure to press **STOP** ■ before proceeding.

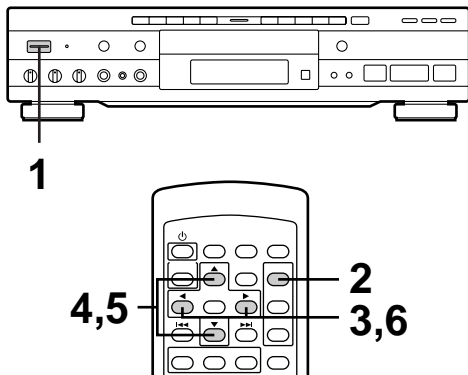

- 1 [Models having a STANDBY/ON button on the main unit]

Press **STANDBY/ON** on the front panel to turn the player on.

[Models having a POWER switch on the main unit]

Press **POWER** on the front panel to turn the player on.

- 2 Press **SETUP**.
The Setup screen appears.

(Example)

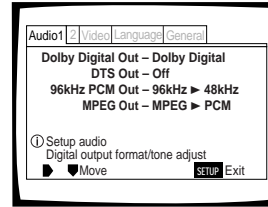

- 3 Use the cursor buttons (◀/▶) to select the menu you want.

As each menu is selected with the cursor, the settings appear below the menu heading.

- 4 Press the cursor button (▼) to enter the menu.

The top item within the menu becomes highlighted.

(Example)

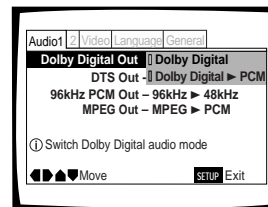

- 5 Use the cursor buttons (▲/▼) to select the setting you want to change.

The options available for each setting appear to the right when the setting is selected. The current setting appears with the setting indicator lit.

- 6 Press the cursor button (▶) to enter the setting options.

(Example)

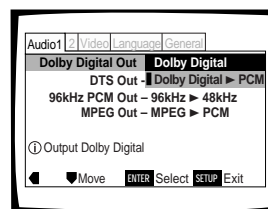

- Not all menu options can be changed while a disc is playing. In these cases, the options appear grayed out on the screen and cannot be adjusted. To change these settings, press **STOP** ■ first before pressing **SETUP**.
- Operating the menu after pressing **STOP** ■ may cancel the resume function.
- Some menu options are not immediately effective if set while a disc is playing. To make these settings effective, stop playback and then start again, or change the settings while the disc is stopped.

IMPORTANT

Changing the Setup Screen to "Expert" Menu Mode

The Setup screen menus are divided into two levels, "Basic" and "Expert", to make this unit more convenient to operate for different levels of users. The "Basic" menu mode contains functions that may be considered necessary for the basic operations of this player and helpful on-screen information identified by the  mark. The "Expert" menu mode adds to the "Basic" menu mode additional functions of the player that can be adjusted to further personalize performance of the player.

In this manual, functions that are contained in the "Expert" menu mode are identified by the  icon.

Make changes to the [Setup Menu Mode] setting in the Setup screen **General** menu.

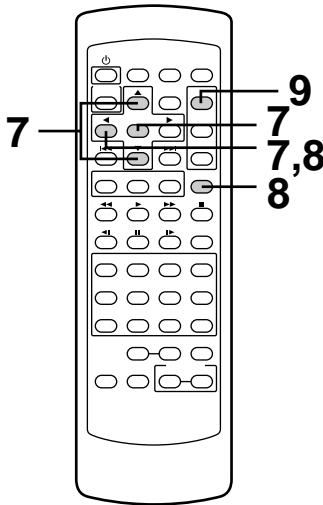

7 Use the cursor buttons (▲/▼) to select a new setting and press **ENTER** to set the new setting in memory. Press **RETURN** or the cursor button (◀) to exit the options without making any changes.

8 Press **RETURN** or the cursor button (◀) to go back to the main menu bar to select another menu.

9 Press **SETUP** to close the Setup screen. The Setup screen closes.

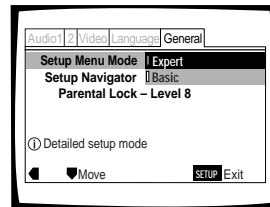

Settings: **Expert**
Basic*

* Factory setting

Note

On-screen information only appears in the "Basic" menu mode.

How to interpret the setting indicator colors in the Setup screen menus

When setting up the system, or when making adjustments, it is convenient to know what settings are applicable to the different disc formats. When the settings appear for each menu option, the currently selected setting appears with the setting indicator highlighted in one of three colors: blue, green or yellow. These colors correspond to what formats the menu option effects as shown in the table below.

Color of indicator	Disc format(s)
Blue	DVD only
Yellow	DVD/Super VCD/Video CD
Green	All compatible formats

Notes

- If a setting applicable only to DVDs is changed while a Super VCD/Video CD or CD is loaded, a blue DVD icon appears in the upper right hand corner of the screen to indicate that the setting is not applicable to the currently loaded disc. The setting will be effective the next time a DVD is loaded.
- The blue indicator is shown for the [TV Screen], but the aspect can be switched for Super VCD.

Setting the Digital Audio Output To Be Compatible with Your AV Components – DVD

This player is capable of digital audio output for Dolby Digital, DTS, MPEG, and signals with a sampling rate of 96 kHz. Make settings in the Setup screen **Audio 1** menu to reflect the capabilities of the components that you have made digital connections to.

Notes

- If you have already completed the Setup Navigator screen operations, the settings on this page have already been set by the player.
- If you have made only stereo line connections (analog) using the supplied audio cord, it is not necessary to make any changes in this menu.
- There is no digital output when the player is set to Karaoke mode.

Dolby Digital Out

This player is capable of outputting the Dolby Digital surround sound audio signal. When the player is connected to an AV component that has a built-in Dolby Digital decoder, select "Dolby Digital". This player can also convert the Dolby Digital signal to a digital Linear PCM signal, the same digital signal output from a CD. Select "Dolby Digital ► PCM" when you have made connections to an amplifier or receiver with a Dolby Pro Logic decoder or a Digital Analog Converter (DAC).

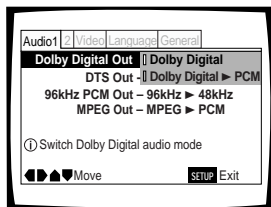

Settings: **Dolby Digital***
Dolby Digital ► PCM

*Factory setting

DTS Out

This player is capable of outputting DTS digital audio for DVDs recorded in DTS. When this player is connected to an AV component that has a built-in DTS decoder, select "DTS". If your system is not equipped to decode DTS, select "Off". Refer to the operating instructions supplied with your audio components if you are unsure about compatibility with DTS.

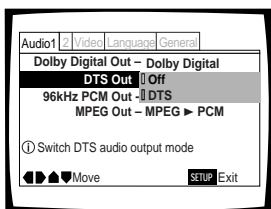

Settings: **Off***
DTS

* Factory Setting

Note

If you have made digital audio connections to component(s) not equipped to decode the DTS digital bitstream, be sure to select "Off". If a DTS signal is output to an AV component without decoding capabilities, the output is digital noise that could potentially cause damage to your speakers.

96 kHz PCM Out

This player is capable of outputting digital signals with a sampling frequency of 96 kHz. If you have made connections to a component capable of processing this signal rate, select "96 kHz" for the signal to be output as is. As some components are incapable of processing digital signal input with sampling rates of 96 kHz, selecting "96 kHz ► 48 kHz" compresses the signal to a standard signal with a sampling rate of 48 kHz.

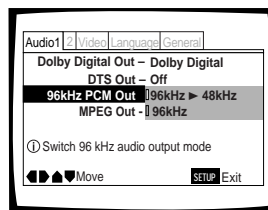

Settings: **96 kHz ► 48 kHz***
96 kHz

* Factory Setting

Note

On DVDs that contain copy protection, it may not be possible to playback the audio at 96 kHz. When this type of disc is encountered, even if "96 kHz" is selected, the player automatically outputs the audio at a compressed rate of 48 kHz.

MPEG Out

This player is capable of outputting the MPEG digital bitstream. When the player is connected to an AV component that has a built-in MPEG decoder, select the "MPEG" setting. Otherwise, select "MPEG ► PCM" to convert the digital signal to the PCM signal, the digital signal output from a CD.

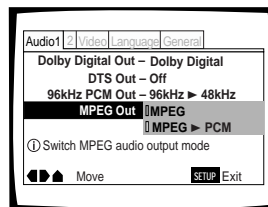

Settings: **MPEG**
MPEG ► PCM*

* Factory Setting

Setting the TV Screen Size

The width-to-height ratio of conventional TVs is 4:3, while the width-to-height ratio of wide screen and high-definition TVs is 16:9. This width-to-height ratio is called the aspect ratio.

When viewing software recorded in different aspect ratios, the image's height to width ratio can be switched to match the TV or monitor being used.

Make changes to the TV screen size in the [TV Screen] setting in the Setup screen **Video** menu. Please note that changes to the [TV Screen] setting cannot be made when a disc is playing. Stop playback of the disc before attempting to make any changes.

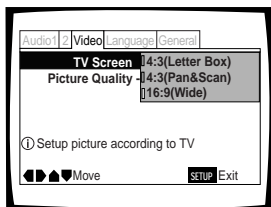

- Settings: **4:3 (Letter Box)**
4:3 (Pan & Scan)
16:9 (Wide)*

* Factory Setting

Notes

- If "Standard (4:3)" is selected in the Setup Navigator screen, "4:3 (Letter Box)" is selected on this screen. If you prefer the pan&scan format, change the settings on this screen.
- Whether the aspect can be switched or not depends on the disc. Please refer to the information written on the disc jacket, etc.
- Some discs may not include the screen format selected in the [TV screen] setting. When this occurs, the standard TV screen format available on the disc is automatically selected.

Differences in screen sizes and DVD/Super VCD formats

The number of screen size formats currently available can be somewhat confusing. If set incorrectly, the video presentation may not appear as it should. The following diagrams and descriptions are intended to help you set your TV screen size in a way that will allow you to fully enjoy the digital video of DVD or Super VCD.

The settings in the [TV Screen] setting are perhaps most applicable when the DVD or Super VCD you are watching is programmed in the wide screen format. If you have a standard TV, select either "4:3 (Letter Box)" or "4:3 (Pan & Scan)" based on your personal preference. If you have a wide screen TV, select "16:9 (Wide)".

Note

When playing Super VCDs, even if 4:3 (Letter Box) is selected in the [TV Screen] setting, the disc will be shown in Pan & Scan format.

When viewing a wide screen TV or monitor	
DVD/Super VCD screen size format	Setting and Appearance
Wide screen format DVD/ Super VCD Please note that there are some wide screen letter box formats that place black bars at the top and bottom of the screen. This is not a malfunction.	<p>"Wide" setting</p>
Standard screen format DVD/ Super VCD When viewing a standard screen format DVD or Super VCD on a wide screen TV, black bars may be automatically placed at the side of the screen to adjust to the DVD or Super VCD format.	<p>"Wide" setting</p>
Standard screen format DVD/ Super VCD (unnatural stretched effect) If you are viewing a standard screen format DVD or Super VCD on a wide screen TV, the picture may appear 'stretched' on the screen. To remedy this condition, change your wide screen TV to display a standard (4:3) screen. Refer to the instructions supplied with your wide screen TV or monitor for more information.	<p>"Wide" setting</p>

When viewing a standard size TV or monitor	
DVD/Super VCD screen size format	Setting and Appearance
Wide screen format DVD The Letter box presentation places black bars at the top and bottom portions of the screen to provide the full wide screen presentation of a movie on a standard TV (4:3 aspect ratio).	<p>"Letter Box" setting</p>
Wide screen format DVD/ Super VCD The Pan & Scan presentation crops both sides of the wide screen presentation to use the full standard TV screen.	<p>"Pan & Scan" setting</p>
Standard screen format DVD/ Super VCD If you have a standard TV, the standard screen format will be presented regardless of the setting.	<p>Any setting</p>
Wide screen format DVD/ Super VCD (unnatural squeezed effect) If you are viewing a wide screen format DVD or Super VCD on a standard TV and the [TV Screen] setting is set to "Wide", the picture may appear 'squeezed' on the screen. To remedy this condition, select either "Letter Box" or "Pan & Scan".	<p>"Wide" setting</p>

Adjusting the OSD (On-Screen Display)

Setting the on-screen display (OSD) language (Chinese model only)

This setting is used to establish the language that operation indicators and on-screen messages and operations display. Change this setting in the Setup screen **Language** menu [OSD Language] setting.



Settings: 汉语*
English

* Factory Setting

Notes

- The [OSD Language] setting is factory set to “汉语”. If you want English to be displayed, change this setting to English.
- If you have already completed the Setup Navigator screen operations, the settings on this page have already been set by the player.

Turning the on-screen display on or off Expert

If you would rather not have the operation indicators (Play, Stop, Resume, etc.) and other messages displayed on the screen, it is possible to turn them off in the [On Screen Display] setting in the Setup screen **Video** menu in the “Expert” menu mode (page 27).

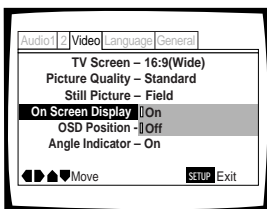

Settings: On*
Off

* Factory Setting

Setting the position of the on-screen display Expert

When watching conventional software on a wide screen TV, the operation display is at the very top of the screen, and may be difficult to see. When this occurs, selecting “Wide” changes the position of the display and lets you see operation indicators clearly even on a wide screen TV. Otherwise, select “Normal”.

Make changes in the [OSD Position] in the Setup screen **Video** menu in the “Expert” menu mode (page 27).

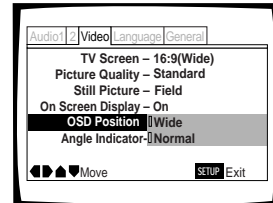

Settings: **Wide**
Normal*

* Factory Setting

Karaoke Operation

Karaoke Entertainment

- DVD/Super VCD/Video CD/CD

This DVD player goes beyond being a simple karaoke machine for sing-alongs, and includes many functions that are designed to enhance your enjoyment of karaoke. Before we explain those functions, however, let's first learn how to perform the basic operations.

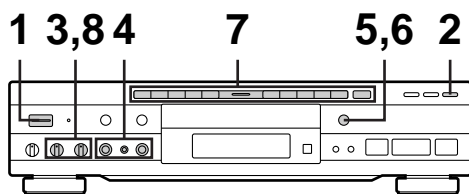
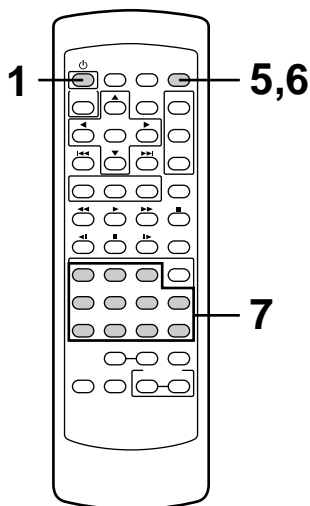

- Press **KARAOKE MODE** to switch the karaoke mode on.
 - Each time you press the button, the setting changes as follows:



When the KARAOKE MODE indicator lights, skip this step.

- Set **MIC 1** and **MIC 2** volume level knobs to "MIN".

- Connect the mics, and switch on.

- Press **OPEN/CLOSE** ▲.

The disc tray comes out. Load a disc with the label side facing up, using the disc tray guide to align the disc.

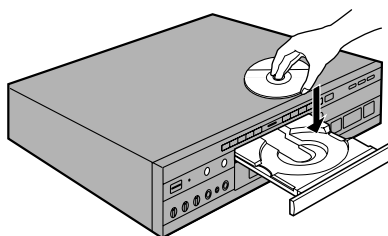

- Press **OPEN/CLOSE** ▲.

The disc tray goes back in.

- Press the number button(s) to select desired song(s).

- To select number 3, press 3.
- To select number 21, press +10 twice then 1. Playback begins.

- Turn the mic volume level knobs to adjust volume level.

Adjust overall volume level with the TV or amp.

Howling

If sound from the speakers is picked up by a mic and output again through the speakers, the result is a screeching sound known as "howling". Perform the following steps to eliminate howling.

- Move the mic away from speakers.
- Turn the mic volume knob counterclockwise to lower the volume level.
- Turn the Digital Echo level knob (page 32) counterclockwise to lower the echo level.

Single Play Function

When the KARAOKE MODE is selected (the KARAOKE MODE indicator lights), play pauses after a selected song finishes. This is single play.

The single play function cannot be used when in the Normal mode.

- [Models having a STANDBY/ON button on the main unit]
Press **⏻** (**STANDBY/ON** on the front panel).

[Models having a POWER switch on the main unit]

Press **POWER** on the front panel.

- When the STANDBY indicator lights, you can power on with the remote control.

Display between songs

When in the KARAOKE MODE (when the KARAOKE MODE indicator on the front panel is lit), during pause or when a disc has stopped playing, karaoke bird characters are displayed.

When no disc is loaded

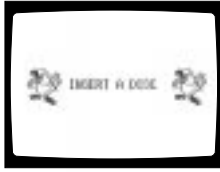

Notes

- With DVDs, some discs may have a Menu function. With this kind of disc, since operations are in line with menu selections, there is no SINGLE PLAY mode. In addition, there is no karaoke bird.
- When playing a Super VCD/Video CD that has Playback Control with Playback Control on (page 23), there is no the SINGLE PLAY mode. In addition, there is no karaoke bird between songs.
- With the KARAOKE MODE (when the KARAOKE MODE indicator on the front panel is lit), depending on the TV you're using and mic volume level, there may be distortion when playing DVDs, CDs or Super VCDs/Video CDs. In this case, set the ATTENUATOR switch on the rear panel to on.

Adjusting to Create the Desired Sound – DVD/Super VCD/Video CD/CD

CD

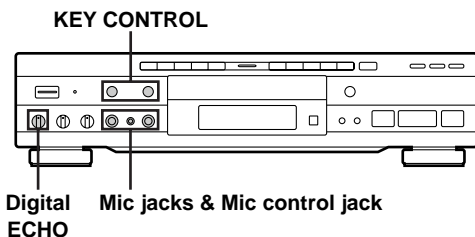
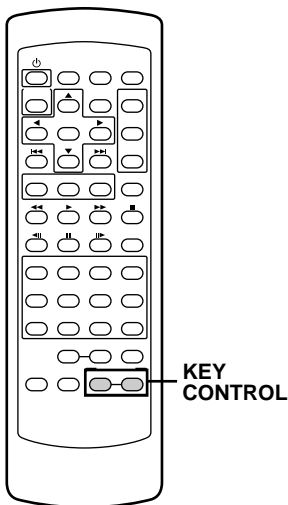

Echo adjustment

Adjust with the digital echo level knob.

Note

Depending on the room, there may be howling if the echo level is too high (page 31).

Changing performance key

Press **KEY CONTROL**.

Each button can be used to raise or lower the key in 5 steps.

High: The key is raised

Low: The key is lowered

Note

Adjustments can also be made at "Key Control" in the Karaoke Setup menu.

Operation is possible with the mic

You can operate Key control and Once more.

Once more

- Each time you press this during play, you move back a little from the point you are in the song and the video.
- You can use this to repeat difficult sections in songs you are singing for the first time.
- Once more operation may not be possible with some discs.

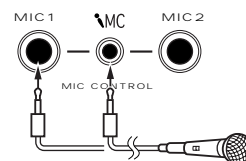
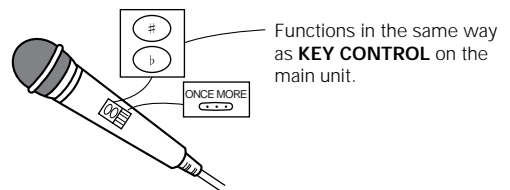

- Any Pioneer microphone with key control function can be used. Refer to the mic's User's Manual for details concerning Key control operation.
- The mic operation buttons will not function unless the jack is connected to the mic control jack and the mic switch is turned on.

One-Touch Karaoke

- DVD/Super VCD/Video CD/CD

When you are playing a normal music disc, you can press this button and remove the singer's voice so that it sounds just like a karaoke disc, allowing you to enjoy karaoke easily with your favorite music.

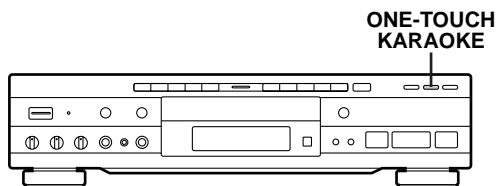

Press **ONE-TOUCH KARAOKE**.

The **ONE-TOUCH KARAOKE** indicator lights on the player.

Press **ONE-TOUCH KARAOKE** once more to cancel this mode.

Note

If you are playing a karaoke disc with vocals on it, pressing **ONE-TOUCH KARAOKE** will not necessarily remove the vocals. In this case, refer to page 35, "Changing the setting of vocals".

Reserving a Desired Song

- DVD/Super VCD/Video CD/CD

You can previously reserve the next song to be played while enjoying karaoke.

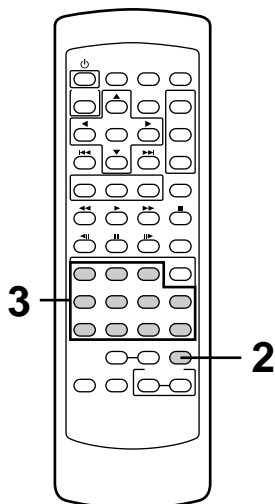

1 Perform steps 1 through 8 on page 31.

2 Press **PROGRAM**.

3 Press the number button(s) to select a song. Input the track number with CDs and Super VCDs/Video CDs.

Input the title or chapter number with DVDs.

- To reserve number 16, press +10 and 6.



- In the case of DVD discs, the player automatically determines whether the disc should be played by titles or by chapters (the user is unable to select whether playback is performed according to titles or chapters).

4 Repeat steps 2 through 3 to reserve other songs.

After the currently playing song is finished, playback of the selected title, chapter or track starts.

Notes

- Up to 24 songs can be reserved.
- Reserved songs play one after the other, without SINGLE PLAY (page 31) pauses between them.
- When reserved songs are finished playing, they are sequentially erased from the program.
- When the last reserved song starts playing, the program is canceled.
- Press ►►, and the next reserved song starts playing. Even if you press ◀◀, you do not return to the previous reserved song. Instead, you return to the start of the currently playing song.

To stop playback

Press **STOP**.

The programming operation is canceled. (The programming details are stored.)

To continue program playback

1 Press **PROGRAM**.

2 Press ► (**play**).
The reserved song will then begin to be played.

To confirm reservation details

Press **DISPLAY** if program playback is in progress.

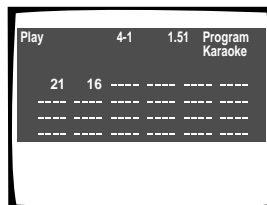

Press **DISPLAY** once more, and the display is switched off.

To erase program contents

Press **CLEAR** in the stop mode.
During playback, press **CLEAR** if program input is not in progress.

Notes

- Program playback cannot be used with some DVD discs.
- If you press **PROGRAM** when playing a Super VCD/video CD with PBC with Playback Control on, the disc stops playing and PBC operation switches off. To cancel a program, set playback Control to on during program execution.
- The **PROGRAM** button does not work while a disc is being read.

Making Settings on the Karaoke Setup Menu

– DVD/Super VCD/Video CD/CD

When you press **KARAOKE SETUP**, a menu of the karaoke functions that you can set for the disc that is being played back appears on the screen. You can then set these functions as desired.

Displaying the Karaoke Setup menu

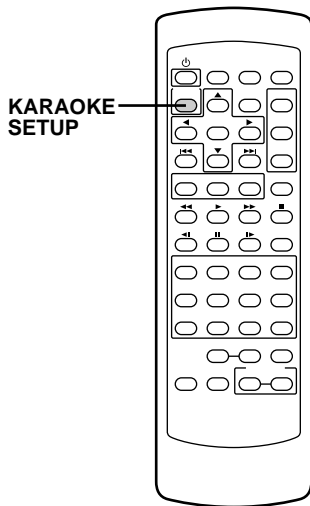

Press **KARAOKE SETUP**.
The karaoke setup menu appears.

Depending on the type of disc that is being played back, the Karaoke Setup menus that might be displayed are listed below.

<Dolby Digital multiplex compatible DVD karaoke Disc>

Guide Melody	Key Control	Vocal	Vocal Partner	Vocal Select	Vocal Volume
ON	±0	OFF	OFF	V1&2	MAX

The menu display varies, depending on whether a guide melody is available and on the vocal select (1 or 2).

<Other DVD Disc>

Audio	Key Control	Vocal	Vocal Partner
1	±0	ON	OFF

"Audio" is displayed for discs having two or more audio.

<Super VCD/Video CD Audio Multiplexed Disc>

Disc	Key Control	Vocal	Vocal Partner	Vocal Volume
MPX	±0	OFF	OFF	MAX

<CD/Super VCD/Video CD Stereo Disc>

Disc	Key Control	Vocal	Vocal Partner
STEREO	±0	ON	OFF

When you are done, press **KARAOKE SETUP** to exit the Karaoke Setup menu.

Note

Pressing the RETURN and AUDIO buttons will also cancel the menu.

Changing the setting of vocals

You can eliminate the vocals on the disc by setting "Vocal" to "OFF". Vocals are output when turned on.

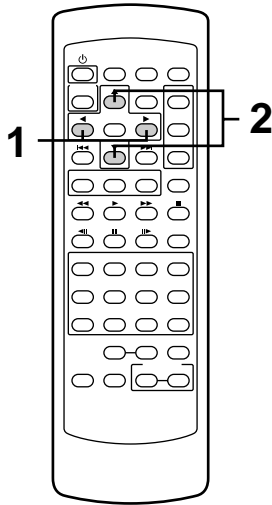

- 1 Use the cursor button (◀▶) to select "Vocal" in the Karaoke Setup menu.
- 2 Use the cursor button (▲▼) to change the settings as desired.
The vocals will no longer be audible; only the music can be heard if set to OFF.

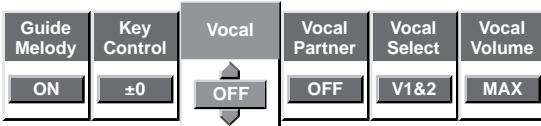

Settings: **ON**
OFF

Note

When turning off the vocals, make sure to turn off the Vocal Partner function.

Setting the "Vocal Partner" feature

With this feature, the vocal of the singer on the disc is silenced while you sing with the microphone; when you stop singing, the singer's voice becomes audible again. This function is useful for learning new songs, and for practicing a duet when you are by yourself.

- 1 Use the cursor button (◀▶) to select "Vocal Partner" in the Karaoke Setup menu.
- 2 Use the cursor button (▲▼) to select "ON".

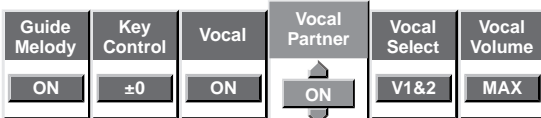

Settings: **ON**
OFF

To cancel the Vocal Partner setting

Simply change the setting to "OFF".

Download from www.Somanuals.com. All Manuals Search And Download.

Notes

- To adjust the Vocal Partner volume, make the adjustment under "Vocal Volume". (Refer to "Adjusting the volume of the vocal".)
- On some discs, the volume of the singer may not be reduced by much even when you sing.
- In the case of software that contains two vocals on a Dolby Digital multiplex compatible DVD karaoke disc, the Vocal Partner feature works on the vocal that is selected through the "Vocal Select" menu item. (Refer to "Selecting the vocal".)

Selecting the vocal

- Dolby Digital multiplex compatible DVD karaoke Discs

If a track has two vocals, this item appears in the Karaoke Setup menu, allowing you to select the desired vocal.

- 1 Use the cursor button (◀▶) to select "Vocal Select" in the Karaoke Setup menu.
- 2 Use the cursor button (▲▼) to select the desired vocal.



Settings: **V1 & 2** (Vocal 1 and 2)
V1 (Vocal 1)
V2 (Vocal 2)
MIX (Vocal 1 & 2 mixed)

Notes

- If "V1 & 2" is set, vocal 1 plays on the left channel, and vocal 2 plays on the right channel. If "MIX" is selected, both vocals play in monaural on channels 1 and 2.
- The "Vocal" or "Vocal Partner" setting must be "ON".
- When the Vocal Partner function is on, the vocals are played back in mono even if V1 & 2 are set.

Adjusting the volume of the vocal

You can adjust the volume of the vocal in order to optimize its usefulness for karaoke practice. Turn on the Vocal or Vocal Partner function.

- 1 Use the cursor button (◀▶) to select "Vocal Volume" in the Karaoke Setup menu.
- 2 Use the cursor button (▲▼) to set the volume as desired.

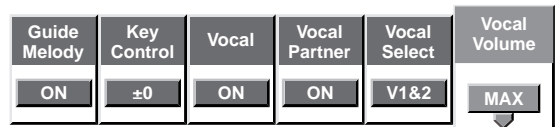

Settings: **MAX** (Maximum)
7/8
⋮
1/8
MIN (Minimum)

Changing the key of the music

You can change the key of the music through the Karaoke Setup menu without using the KEY CONTROL button on the main unit or the remote control.

- 1 Use the cursor button (◀▶) to select "Key Control" in the Karaoke Setup menu.
- 2 Use the cursor button (▲▼) to select the desired key.

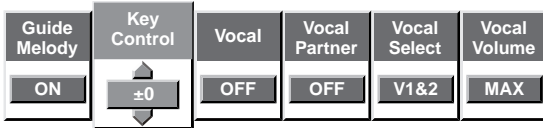

Settings: +5 (The key is raised)

- +4
+3
+2
+1
±0 (Original key)
-1
-2
-3
-4
-5 (The key is lowered)

Note

The key that is set through the "Key Control" menu item can be changed by using the KEY CONTROL button on the main unit or the remote control. (page 32)

Singing without the guide melody

- Dolby Digital multiplex compatible DVD karaoke Discs

On a disc that includes a separately recorded guide melody, you can choose to sing without the guide melody, just like a professional singer.

- 1 Use the cursor button (◀▶) to select "Guide Melody" in the Karaoke Setup menu.
- 2 Use the cursor button (▲▼) to select "OFF".

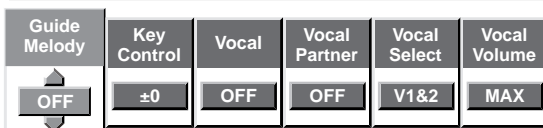

Settings: ON
OFF

To turn the guide melody back on

Simply set the "Guide Melody" menu item to "ON".

Selecting the desired vocals or language - DVD

On DVDs, some types of discs include up to eight vocals, different languages, or offer a choice of vocal or no vocal.

If such a disc is in the DVD player, when playing the "Audio" item appears in the Karaoke Setup menu, allowing you to select the desired settings.

- 1 Use the cursor button (◀▶) to select "Audio" in the Karaoke Setup menu.
- 2 Use the cursor button (▲▼) to set the desired settings.

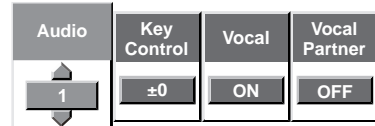

Settings: 1
:
8 (Maximum)

The values that are actually displayed depend on the disc in question.

You can also be switched by the AUDIO button on the remote control. The above display will then disappear.

Setting multiplexed or stereo

- Super VCD/Video CD/CD

Some types of discs are recorded in a multiplexed system. Sometimes the DVD player is not able to correctly identify the format, so it incorrectly selects the stereo setting. In this case, you can use this item to correct the setting. On an audio multiplexed disc, the left channel carries the instrumental and the R channel carries the instrumental and the vocals. On a stereo disc, the left and right channels both carry the instrumental and the vocals.

- 1 Use the cursor button (◀▶) to select "Disc" in the Karaoke Setup menu.
- 2 Use the cursor button (▲▼) to select the audio recording format: "STEREO" or "MPX", whichever applies to the disc in question.

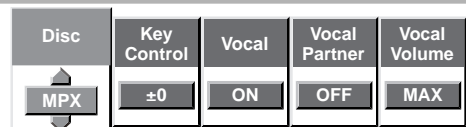

Settings: STEREO
MPX

Changing the settings

- 1 Press **KARAOKE SETUP** in order to display the Karaoke Setup menu.
- 2 Use the cursor button (◀▶ ▲▼) to change the settings as desired.

Setting the Language Options

Selecting a Subtitle Language (Multi-Language Subtitles)

– DVD

You can select a desired subtitle language with DVDs that have subtitle data in multiple languages recorded on them.

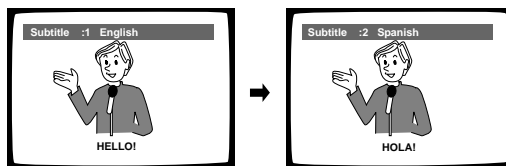

DVDs have the capacity to contain a great deal of audio information, which includes the ability to hold up to 8 different language tracks and subtitle information in as many as 32 different languages. This section outlines the variety of audio language and subtitle options available with this player.

(Chinese model only) Please note that if you have completed the Setup Navigator, the audio and subtitle language options have automatically been set in accordance with the OSD language (the language that appears on the screen).

In this section, you'll be able to:

- Select one of the subtitle languages programmed on a DVD or turn the subtitles off using the remote control (this page).
- Select one of the audio languages programmed on a DVD using the remote control (page 38).
- Change the audio output type when using Super VCDs, Video CDs and CDs (page 38).
- Set preferences for audio and subtitle language (page 39).
- Set preferences for the language to be displayed by the DVD menu (page 40).
- Set Auto Language to display subtitles only for foreign films (page 41).
- Select whether to have the subtitles turned on or off, and even opt to select assist subtitles for viewers who are hard of hearing (page 41).
- Select the language of subtitles that appear even when the subtitles are turned off (page 41).

Note

DVDs differ in content and do not all contain multiple language or subtitle information. Therefore making settings in this section may have no effect on some DVDs.

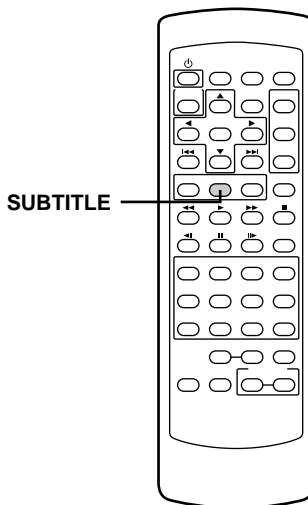

Press **SUBTITLE** repeatedly during playback.

Pressing **SUBTITLE** once displays the currently selected subtitle language. Subsequent presses rotates through the subtitle languages available on the DVD.

Notes

- The subtitle language cannot be switched if the subtitle language is not recorded, or if only one language is recorded.
- Switching the subtitle language may not be possible with some discs. In this case, the  mark will be displayed.
- To clear subtitles during playback, press **SUBTITLE** and then press **CLEAR**, or press **SUBTITLE** until "Off" appears.
- For some discs, subtitle language selection can be made using the menu on the DVD. In this case, press **MENU** to display the DVD menu screen and then make your selection.

Changing the Audio Language (Multi-Language Function) – DVD

Dolby Digital, PCM, and other audio data can be recorded on DVDs in a number of languages or audio tracks, letting you choose the desired language or audio.

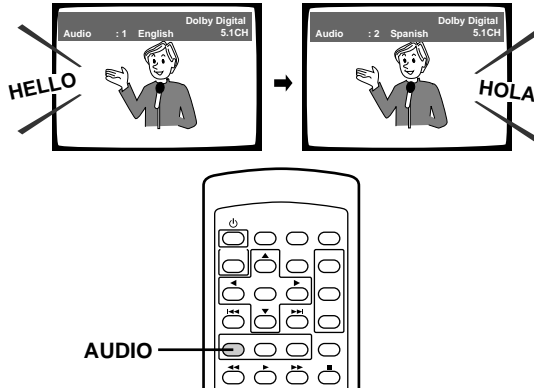

Press **AUDIO** repeatedly to select the desired language. Pressing **AUDIO** once displays the currently selected language. Subsequent presses rotate through the audio languages available on the DVD.

Notes

- You cannot switch languages if there is only one language recorded on the disc.
- Switching the audio language may not be possible with some titles. In this case, the  mark is displayed.
- For some titles, selection can be made using the DVD menu. In these cases, press **MENU** to display the DVD menu screen and then make your selection.

Changing Audio Type

– Super VCD/Video CD/CD

For enjoyment of karaoke or similar format Video CDs and CDs, it is possible to select stereo audio, or either right or left channel mono depending on the requirements of the source.

Video CD/CD

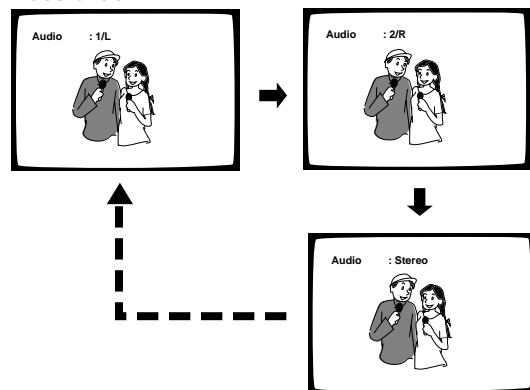

Press **AUDIO** repeatedly during playback to switch the audio type. Audio output changes from "1/L" (Left channel) to "2/R" (Right channel) to "Stereo". This function is possible only in Normal mode.

Super VCD (Normal mode)

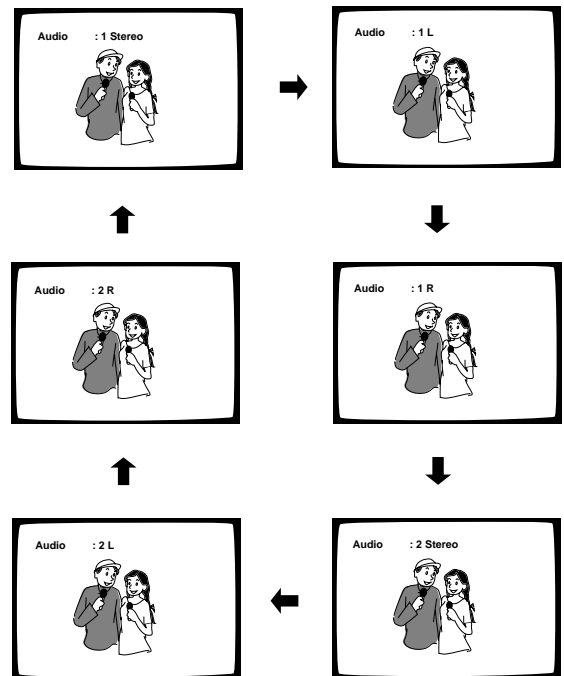

Press **AUDIO** repeatedly during playback to switch the audio type. Choose the audio type that lets you hear the soundtrack (the sound may not be audible with some audio types).

In Normal mode, the audio changes according to the diagram above.

Super VCD (Karaoke mode)

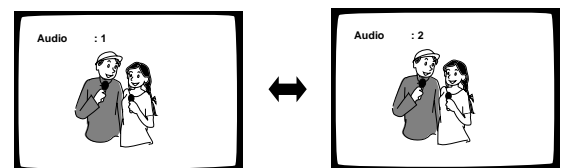

Press **AUDIO** repeatedly during playback to switch the audio type. Choose the audio type that lets you hear the soundtrack (the sound may not be audible with some audio types).

In Karaoke mode, the audio changes according to the diagram above.

Setting Language and Subtitle Preferences in the Setup Screen Menus

The Setup screen **Language** menu contains a number of settings related to the audio and subtitle language preferences.

Please note that changes to the settings in the **Language** menu in this section cannot be made when a disc is playing. Stop playback of the disc before attempting to make any changes.

Selecting an audio language preference

The audio language that you normally listen to can be selected from the various audio languages on a DVD. Even when the audio language is changed during playback by pressing **AUDIO**, the language selected at this setting will be selected as the default when the DVD is changed.

Make changes to the [Audio Language] setting in the Setup screen **Language** menu.

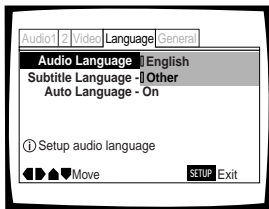

Settings: **English***

Other (For details on how to select other languages, see 'When "Other" is selected' on the following page.)

* Factory setting

Note

The menu settings may be different from those shown above.

Selecting a subtitle language preference

The subtitle language that you will normally display can be selected from the subtitles programmed on a disc. Even when the subtitle language is changed during playback by pressing **SUBTITLE**, the language selected at this setting will be selected when the disc is changed.

Make changes to the [Subtitle Language] setting in the Setup screen **Language** menu.

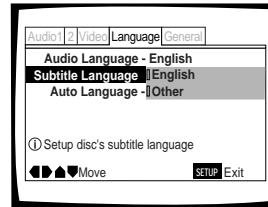

Settings: **English***

Other (For details on how to select other languages, see 'When "Other" is selected' on the following page.)

* Factory setting

Note

The menu settings may be different from those shown above.

When "Other" is selected

When you want to select one of the 136 languages as the main audio language, follow the steps below when the following screen appears.

A language code list can be found on page 55.

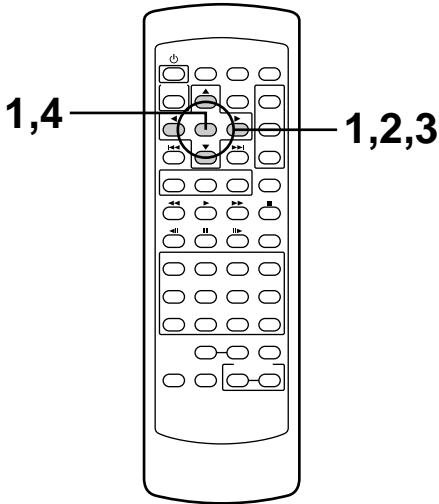
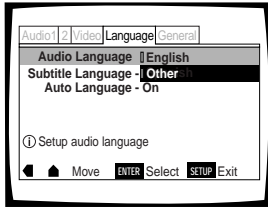

- 1 Use the cursor buttons to select "Other" and press **ENTER**.
The language selection screen appears.

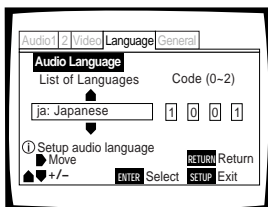

- 2 Use the cursor buttons (◀/▶) to select either "List of Languages" or "Code".
- 3 If you select "List of Languages", use the cursor buttons (▲/▼) to select the language.

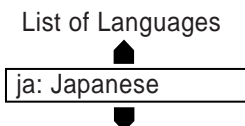

If you select "Code", use the cursor buttons (▲/▼) to input the numbers of the input code. Use the cursor buttons (◀/▶) to change the position of the cursor. You can also use the number buttons to enter the code.

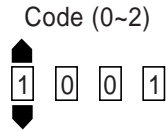

- 4 Press **ENTER** to set the new language. To exit the screen without making any changes, press **RETURN**.

Selecting a DVD menu language preference Expert

In addition to containing different audio languages, DVD may also contain menu screens in different languages as well. Setting a DVD menu language preference, sets the selected language as a default when DVDs with menu information in that language are encountered.

Selecting "w/ Subtitle Language" automatically assigns the language selected in the [Subtitle Language] setting.

Make changes to the [DVD Language] setting in the Setup screen **Language** menu in the "Expert" menu mode (page 27).



Settings: w/ Subtitle Language*

English
Other

* Factory setting

Notes

- The menu settings may look different from the one shown above.
- If this function is not effective, the languages that can be selected may also be selected in the DVD menu. Press **MENU** to open the DVD menu and make your selection accordingly.

Setting Auto Language to control subtitle and audio language based on program content

When the Auto Language function is used, foreign movies are shown with the original audio soundtrack and subtitles in the language selected in the [Subtitle Language] menu option. Domestic films are shown with the original audio soundtrack and no subtitles.

Make changes to the [Auto Language] setting in the Setup screen **Language** menu.

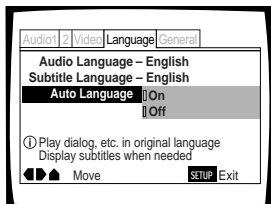

Settings: **On***
Off

* Factory setting

Notes

- The Auto Language function operates only when this function is set to "On", and the languages set for the [Audio Language] and [Subtitle Language] settings are the same.
- The menu settings may look different from the one shown above.

Selecting subtitles, assist subtitles or no subtitles Expert

Use this function to turn the subtitles on or off. Additionally, some DVDs provide assist subtitles that provide additional explanations of scenes in addition to the standard subtitles for viewers who are hard of hearing. Select "Assist Subtitle" to display these subtitles on DVDs where this function is offered.

Make changes to the [Subtitle Display] setting in the Setup screen **Language** menu in the "Expert" menu mode (page 27).

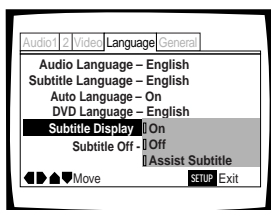

Settings: **On***
Off
Assist Subtitle

* Factory setting

Notes

- If there is no subtitle information recorded on the DVD, no subtitles are displayed even if this function is set to "On".
- This setting serves as a default as whether or not to display subtitles. Even if this option is set to "Off", subtitles can be displayed by pressing **SUBTITLE**. Similarly, if this option is set to "On", the subtitles can be turned off by pressing **SUBTITLE** and then **CLEAR**.
- The menu settings may look different from the one shown above.

Selecting the language of forced subtitles Expert

Even when the subtitles are turned off, some DVDs will nevertheless display them on the screen. This setting allows you to select the language of the subtitles to be displayed with this type of DVD.

Select "With Audio" to display the subtitles in the same language as the currently selected audio language. Select "Selected Subtitle" to display the subtitles in the language set in the [Subtitle Language] setting.

Make changes to the [Subtitles Off] setting in the Setup screen **Language** menu in the "Expert" menu mode (page 27).

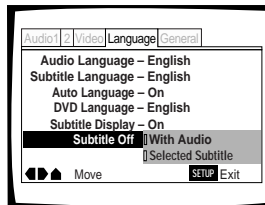

Settings: **With Audio**
Selected Subtitle*

* Factory setting

Note

- The menu settings may look different from the one shown above.

Advanced Functions

This player is compatible with DVD, Super VCD, Video CD, and CD disc formats. Users already familiar with Super VCD, Video CD or CD will already be familiar with some of the functions the player is capable of performing. With DVD, an even greater number of possibilities and functions are available.

In this section, you'll be able to:

- **Adjust the dynamic range of the audio soundtrack so that quiet sounds can be heard better (this page).**
- **Adjust the picture quality to better match program content (this page).**
- **Pause DVD, Super VCD, Video CD playback, play at extremely slow speeds or view frame by frame (page 43).**
- **Search for titles, chapters, tracks or locations on a disc (page 44).**
- **Change the angle of playback when viewing DVDs with multi-angle programming (page 45).**
- **Switches the surround effects on/off. (page 45)**
- **Repeat an entire title, chapter, or track, or just a specified part (page 46).**
- **Set the parental lock level to prevent children from having access to inappropriate material (page 47).**
- **Continue watching a DVD from where you left off using the Last Memory function (page 49).**
- **Save the system settings for up to 15 DVDs with the Condition Memory function (page 50).**
- **View playing time and other disc information (page 51).**
- **Change the background color (page 52).**
- **Reset the system (page 52).**

Note

DVDs differ in content and do not all contain the same information. Therefore some functions in this section may not work or have no effect on some DVDs.

Adjusting the Dynamic Range of the Audio Soundtrack – DVD

Audio DRC stands for Audio Dynamic Range Compression. When Audio DRC is on, soft sounds such as dialog can be heard more clearly without making loud sounds even louder. Select from three levels of compression depending on how much effect you want. When Audio DRC is set to "Off", there is no effect on the audio source.

Make changes to the [Audio DRC] setting in the Setup screen **Audio 2** menu.

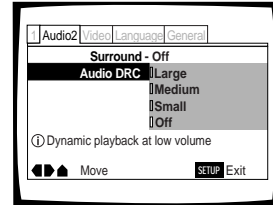

- Settings: **Large**
(maximum compression of audio source)
- Medium**
(moderate compression of audio source)
- Small**
(very little compression of audio source)
- Off***

* Factory setting

Note

Audio DRC is only effective with Dolby Digital audio sources.

Selecting Picture Quality Appropriate for Program Content – DVD/Super VCD/Video CD

This lets you select the ideal picture quality for watching movies, animation and other video media.

Make changes to the [Picture Quality] setting in the Setup screen **Video** menu.

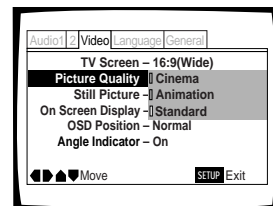

- Settings: **Cinema**
Provides a sharp, clear black picture for images with high contrast.
- Animation**
Provides images with bright clear colors.
- Standard***
Presents the video with no effect added.

* Factory setting

Still Frame/Slow Play/Frame Advance Playback

– DVD/Super VCD/Video CD

The video images on DVD and Super VCD/Video CD can be viewed as a still frame, played back at slow speeds and even advanced frame by frame.

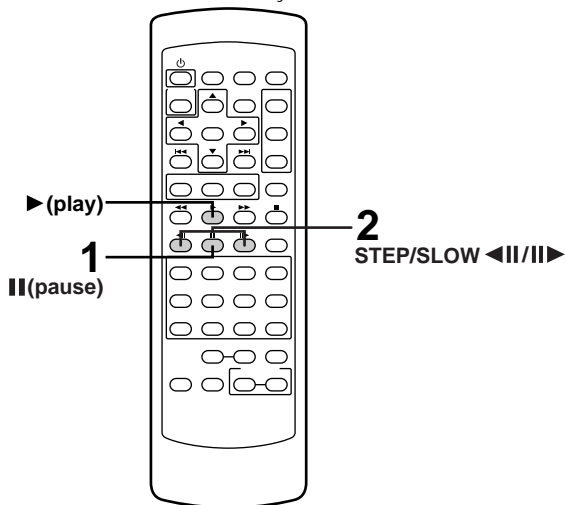

Viewing a still frame

Press **II (pause)**.

When viewing a DVD, if the paused picture shakes, select the "Field" setting in the Setup screen **Video** menu [Still Picture] setting as described in the section below.

To return to normal playback

When viewing a still frame playback, pressing **II (pause)** or **▶ (play)** restores normal playback operation.

Selecting the type of paused image to display Expert

This function lets you view a clear still-image when DVD playback is paused.

Make changes in the [Still Picture] setting in the Setup screen **Video** menu in the "Expert" menu mode (page 27).

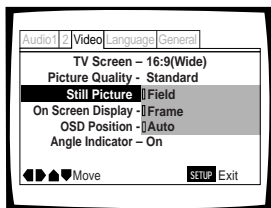

Settings: **Field**

Picture shake will be eliminated during a paused picture.

Frame

Select to obtain higher picture quality.

Auto*

Selects field or frame automatically according to the disc.

* Factory setting

Viewing slow playback

Press and hold **STEP II▶** for about 2 seconds during playback.

- Slow playback is engaged.
- During slow playback, the speed of playback can be adjusted from 1/2 normal playback speed to 1/16 normal playback speed in four steps using **STEP <II and II▶**.

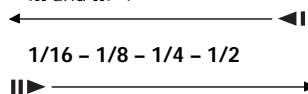

Press and hold **STEP <II** during DVD playback.

- Slow playback in the reverse direction is engaged.
- In the reverse direction, the playback speed cannot be adjusted.
- This function is not possible with Super VCD and Video CD.

To return to normal playback

When viewing still frames or slow playback, pressing **▶ (play)** restores normal playback operation.

Frame by frame advance playback: Viewing one frame at a time

1 Press **II (pause)**.

2 Press **STEP/SLOW <II or II▶**.

STEP/SLOW II▶: The picture advances one frame each time the button is pressed.

STEP/SLOW <II: For DVDs only, the picture backs up a DVD a few frames each time the button is pressed.

To return to normal playback

When viewing frame by frame playback, pressing **▶ (play)** restores normal playback operation.

Notes

- There is no sound when viewing still frames or slow playback, or when advancing one frame at a time.
- Still frame, slow play, or frame advance playback may not be possible with certain titles. In this case, the  mark is displayed.

Searching for a Title, Chapter, Track, or Location on a Disc

– DVD/Super VCD/Video CD/CD

This player offers different ways of accessing the information on a DVD, Super VCD, Video CD, or CD. Using **SEARCH MODE**, you can search for titles or chapters on a DVD, tracks on a Super VCD, Video CD and CD, and even select the point in time to start playback.

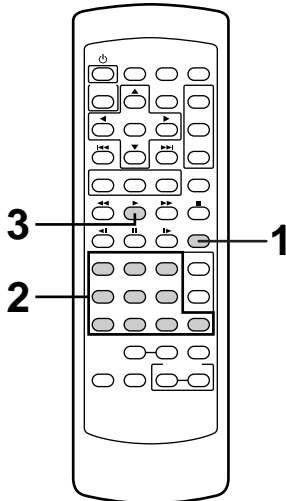

1 Press **SEARCH MODE** repeatedly to select the type of search.

The type of search changes with each press as follows.

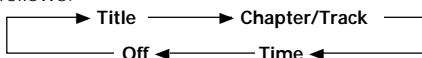

2 Press the number button(s) of the desired title, chapter or track or of the specific time where you would like to begin playback.

- To select number 3, press 3.
- To select number 10, press 1 then 0.
- To select number 87, press 8 then 7.

When performing a time search:

- To select 21 minutes, 43 seconds, press 2, 1, 4, then 3.
- To select 1 hour, 14 minutes, press 7, 4, 0, then 0.

3 Press **▶ (play)**.

Playback of the selected title, chapter or track starts. When a time search is performed, playback begins at the appointed time.

Notes

- For some discs, selection can be made using the top menu on the DVD. In this case, press **TOP MENU** to display the menu screen and then make your selection.
- With some DVDs, the search operation may not be possible and may stop shortly after being performed. In this case, the  mark is displayed.
- Time search is not possible with Super VCDs/CDs.
- When performing DVD time search, playback may start from a slightly different time than that specified.
- Time search is not possible during when the disc is stopped on DVDs.
- Search using SEARCH MODE does not work during PBC playback of Super VCDs/Video CDs.

Changing the type of direct search

– DVD

You can select the type of search (direct search) by pressing the Number buttons directly.

Make changes in the [Direct Search] setting in the Setup screen **General** manu in the "Expert" menu mode (page 27).

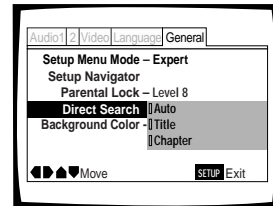

Settings: **Auto***

The player evaluates the disc's composition and selects the appropriate type of search according to the number of titles and maximum number of chapters on the disc.

Title

Title search is performed when direct search is selected.

Chapter

Chapter search is performed when direct search is selected.

* Factory setting

Note

The "Title" and "Chapter" settings are only temporary: When you press OPEN/CLOSE , the [Direct Search] mode reverts to "Auto".

Viewing from a Desired Camera Angle (Multi-Angle)

- DVD

You can select a camera angle when viewing DVDs with the multi-angle option.

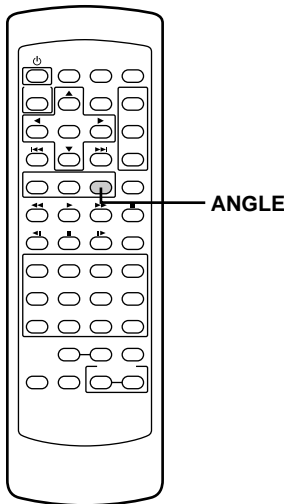
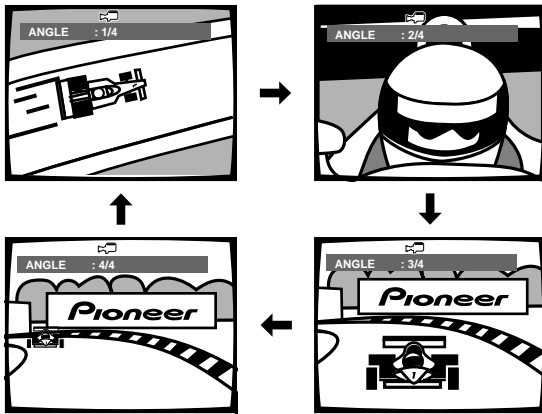

Press **ANGLE** during playback.

The camera angle changes each time you press the button.

Notes

- You can use the Multi-Angle function only with discs featuring recordings of images shot from different camera angles.
- During Multi-Angle playback, the ANGLE indicator in the display lights.
- For some discs, selection can be made using the DVD menu. In this case, press **MENU** to display the DVD menu screen and then make your selection.

To check whether or not a disc is recorded with angles:

The jacket of discs that are recorded with angles will be marked with . When locations on discs that are recorded with angles are played back, the indicator can be displayed. To cancel the indicator, set [Angle Indicator] to "Off" in the Setup screen **Video** menu described in the next section.

Turning the angle indicator on and off Expert

When a picture recorded in different angles is played back the indicator is displayed on the screen. This setting lets you see clearly whether the playback picture is recorded in multiple angles or not.

Turn the indicator on or off in the [Angle Indicator] setting in the Setup screen **Video** menu in the "Expert" menu mode (page 27).

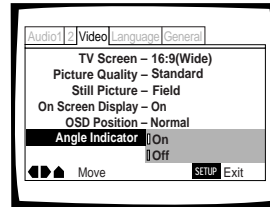

Settings: **On*** (is displayed)

Off (Not Displayed)

* Factory setting

Note

Even when the [Angle Indicator] setting is set to "Off", the ANGLE indicator in the display panel of the player lights during multi-angle playback. Therefore, it is possible to know when the multi-angle function can be used without having to display the icon on the screen.

Changing to Surround

- DVD/Super VCD/Video CD/CD

This function can only be used when in the Normal mode.

Make changes to the [Surround] setting in the Setup screen **Audio 2** menu.

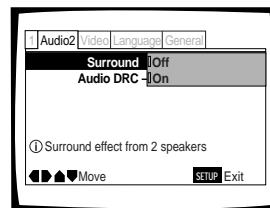

Settings: **Off***

On

* Factory setting

Note

This functions only for audio signals output from the audio output jack. This function is not available for the digital output jack.

Repeat Play – DVD/Super VCD/Video CD/CD

You can repeat an entire title, chapter or track, or just a part.

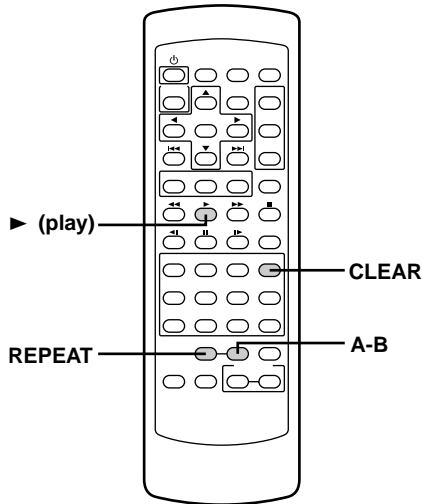

Repeat play of a chapter/track

Press **REPEAT** once during playback of the chapter or track you want to repeat.

- In some DVDs, the descriptions here apply to titles, not chapters.

Repeat play of a title

Press **REPEAT** twice during playback of the title or disc you want to repeat.

- With DVDs, the title continues playing until the end, and then playback starts once more from the beginning of that title.
- With Super VCDs/Video CDs and CDs, a disc is considered a single title, so the entire disc is repeated.

To cancel repeat play

Press **CLEAR**. Playback continues, but the repeat function is canceled.

Repeat play of a specified section

Press **A-B** at the beginning and end of the section you want to repeat.

- When **A-B** is pressed a second time, the disc returns to the location where **A-B** was pressed first and plays the selected section repeatedly.
- You can only perform A-B repeat within the same title, chapter, or track.
- This function is not possible with Super VCD.

To cancel A-B repeat play

Press **CLEAR**. Playback continues, but the repeat function is canceled.

Note

A-B repeat play is not possible with Super VCDs.

Return to a specified location on a disc

- 1 Press **A-B** at the desired location.
- 2 When you want to return to the specified location, press **▶ (play)**.

- This function is not possible with Super VCD.

To clear the specified location

Press **CLEAR** to cancel repeat play or to clear the specified location that was set using **A-B**.

Notes

- With some DVD discs, there may be times when repeat playback is not possible. In these cases, the  mark will appear on the screen.
- With Super VCDs/Video CDs, repeat play is not possible when the menu is displayed (PBC playback). To perform repeat play, start playback without displaying a menu by pressing **PLAYBACK CONTROL**, and then press **REPEAT**.
- Playing back a DVD with menu during A-B repeat play will cancel the repeat function.

Setting the Parental Lock Level

This player lets you set the Parental Lock if the DVD has a parental lock level recorded on it. With Parental Lock capable discs, you can block access to material you feel is inappropriate for your children. Refer to the DVD disc jacket and the accompanying documentation to see if a particular disc contains a parental lock level.

Make changes to the [Parental Lock] setting in the Setup screen **General** menu. Please note that changes to the Parental Lock level cannot be made when a disc is playing. Stop playback of the disc before attempting to make any changes.

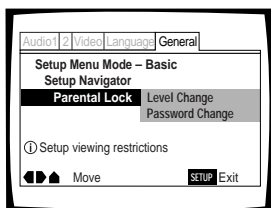

Settings: **Level Change** (For information, refer to "Setting the Parental Lock level" on the following page.)

Password Change (For information, refer to "Changing the password" on the following page.)

When a DVD with a set Parental Lock level is loaded

Playback cannot be started until the password has been correctly input by using the cursor buttons (◀/▶/▲/▼) or the number buttons on the remote control, and **ENTER** has been pressed.

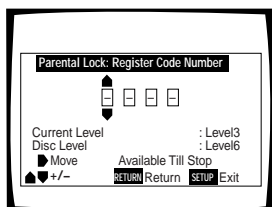

Entering the password

When you select either "Level Change" or "Password Change", it is necessary to enter the password (4-digit code number). Use the following steps at any time you are asked to enter or confirm your password.

- 1 Use the cursor buttons (▲/▼) or the number buttons on the remote control to select a number between 0 and 9.

You can also use the number buttons to enter the numbers directly. When entering your password for the first time, or changing it, you will be asked to reenter your password. When using the number buttons to confirm the password, the numbers appear as asterisks, and the cursor advances automatically to the next position.

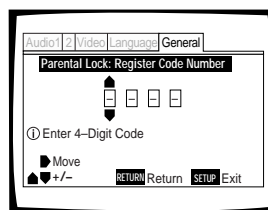

- 2 Use the cursor buttons (◀/▶) to move the cursor to a different position in the password. When all four numbers of the password have been entered, **ENTER** appears on the screen.

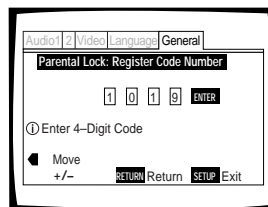

- 3 Press **ENTER** to set the new password. The password is entered.

Note

Be sure not to forget your password. If you should forget it, reset the system, and enter a new password. To reset the system, see 'Resetting the Player to System Settings' (page 52). Please note that this procedure resets the system, and clears all saved settings, not just the password.

Setting the Parental Lock level

Change the Parental Lock level to a higher or lower level according to the settings printed on the DVD disc jacket or accompanying documentation. If you use the Condition Memory function to save the settings for a particular disc, the Parental Lock level is saved as well. Because it is saved in memory, Parental Lock levels can be set for individual discs according to their content rather than a set level for all DVDs.

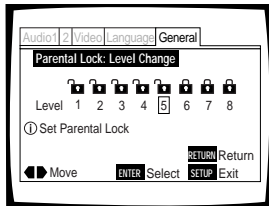

- 1 Select "Level Change" in the [Parental Lock] setting and press **ENTER**.
The screen changes to the password input screen. If you have not yet set a password, you will be asked to do so at this time. To enter the password, refer to "Entering the password" on the previous page.
- 2 Use the cursor buttons (◀/▶) to adjust the Parental Lock level.
The lock icons appear "unlocked" up to the selected level to indicate that access is available.
- 3 Press **ENTER** to set the new level.
The new Parental Lock level is set and the screen returns to the **General** menu screen. To go back to the **General** menu screen without making any changes, press **RETURN**.

Changing the password

Change your password whenever you feel it is necessary. However, if you forget your existing password, you cannot enter this screen to change it.

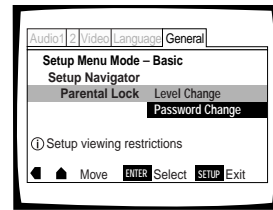

- 1 Select "Password Change" in the [Parental Lock] setting and press **ENTER**.
The screen changes to the password input screen as shown in the section "Entering the password" on the previous page.
- 2 Enter your current password.
To enter the password, refer to "Entering the password" on the previous page.
If you have not yet set a password, you cannot select this setting. Establish a password by selecting "Level Change" first.
- 3 Use the cursor buttons (◀/▶/▲/▼) or the number buttons to enter the new password.
- 4 When the new password has been entered, press **ENTER**.
The new password is set and the screen returns to the **General** menu screen. To go back to the **General** menu screen without making any changes, press **RETURN**.

Continuing Playback from a Specified Location (Last Memory) – DVD/Video CD

The Last Memory function is convenient when you want to continue viewing a disc from the point where you were watching before. Unlike the resume function, the Last Memory function is effective even if the DVD is removed from the player (With Video CDs, the LAST MEMORY location is erased from memory when the disc is ejected.).

Memorizing a Last Memory location to return to later

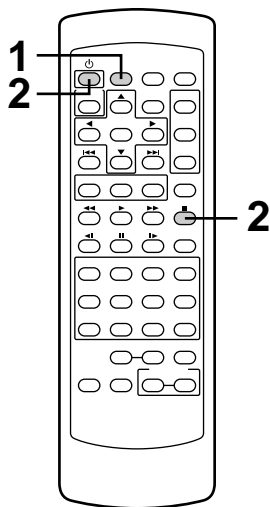

1 Press **LAST MEMORY** during play.
The LAST MEMO indicator lights on the player.

2 Press **⏻** to turn the power to standby, or stop playback with **■ (stop)**.

Once memorized, the memorized point on a DVD will be recalled even if the power is turned off, or if the disc is ejected. Points on up to 5 DVDs can be memorized, and those points are recalled the next time they are played back.

- With Video CDs, the location in playback where LAST MEMORY was pressed is cleared when the disc is ejected.

Resuming playback from where LAST MEMORY was pressed

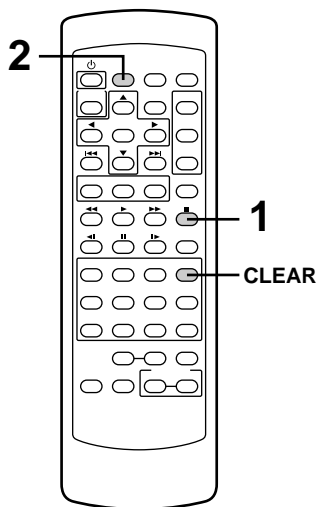

1 Load the DVD that has a Last Memory point memorized.
Some DVDs will start playback automatically when loaded. In this case, press **■ (stop)** to stop playback.

2 Press **LAST MEMORY** while in the stop mode.
The disc begins playback at the memorized point.

- Last Memory mode may not function for some DVDs.
- If you register more than five DVDs, details of the latest disc are memorized, while details of the least recent disc (the disc you registered first) is erased.
- Even with a disc you have memorized with Last Memory, playback begins at the start of the disc if you press **▶ (play)**.
- This function is possible for DVDs and Video CDs only, and cannot be used with Super VCDs and CDs.

To clear the Last Memory location

Press **LAST MEMORY**, then **CLEAR** while "Last Memory" is still being displayed on the screen.

The LAST MEMO indicator disappears from the display window.

Memorizing Settings for Often Viewed DVDs (Condition Memory) – DVD

You can store in memory settings for DVDs you often watch. Settings remain in memory even if you remove the disc from the player, or switch power to the player to standby. If you load a disc that has its settings memorized, "COND_MEM" appears in the display. When you start playing the disc, the memorized settings are automatically recalled.

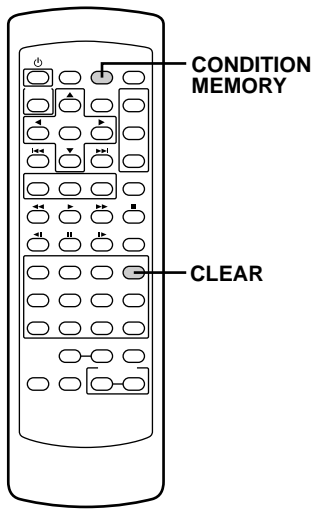

When a disc that has memorized settings is loaded

"Condition Memory" will appear on the screen, and the previously memorized settings will be selected.

Erasing the memorized settings

Press **CONDITION MEMORY**, then **CLEAR** while "Condition Memory" is still being displayed on the screen. The **CONDITION** indicator disappears from the display window.

Notes

- Settings are stored in memory for use any time.
- You can store settings for up to 15 DVDs in memory. If you memorize settings for more than 15 DVDs, previously memorized settings are erased in chronological order from the least recently memorized. Subsequently, if you load a disc with erased settings, the settings of the most recently played disc are used.
- If you make changes to any of the settings memorized in Condition Memory, press **CONDITION MEMORY** during playback to memorize new settings.
- Switching of the multi-language mode etc., is automatic on some discs.

Press **CONDITION MEMORY** during playback.

Settings are memorized for the disc currently playing.

The following 9 settings are memorized:

Function mode (Normal or Karaoke) (page 22)

Video Noise Reduction (page 23)

OSD Position (page 30)

Multi-Language subtitles (page 37)

Multi-Language (page 38)

Picture Quality (page 42)

Direct Search (page 44)

Multi-Angle (page 45)

Parental Lock Level (page 47)

Viewing Disc Information

- DVD/Super VCD/Video CD/CD

Use **DISPLAY** to get current information about the disc currently loaded. You can get information about the titles and chapters on a DVD or tracks on a Super VCD/Video CD or CD. When viewing DVDs, you can also check the digital bitstream transmission rate.

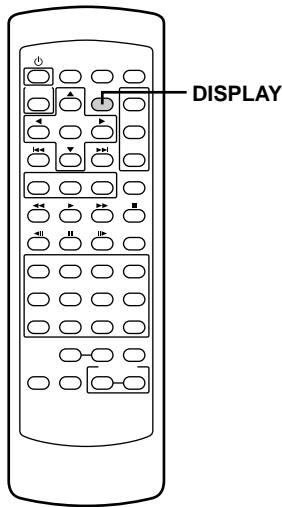

Press **DISPLAY** while a disc is playing. Press **DISPLAY** repeatedly to change the information being displayed.

The disc information is displayed superimposed over the video image on the screen.

The display changes for each type of disc as follows each time the button is pressed.

DVD

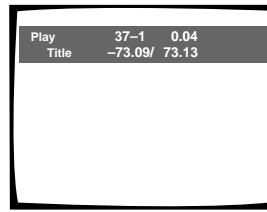

TITLE information:

Top Row: title and chapter number, elapsed time of current title

Bottom Row: remaining time in current title, total time of current title



CHAPTER information:

Top Row: title and chapter number, elapsed time of current title

Bottom Row: time in current chapter, total time of current chapter



CHAPTER information:

Top Row: title and chapter number, elapsed time of current title

Bottom Row: remaining time in current chapter, total time of current chapter

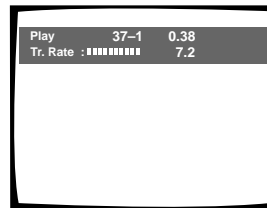

Data transmission rate information:

Top Row: title and chapter number, elapsed time of current title

Bottom Row: bitstream transmission rate level



Display off

Super VCD



Disc information:

Top Row: track number, elapsed time of current track

CD



Track Information:

Top Row: current track number, track time

Bottom Row: remaining time of current track, and total time of current track



Disc information:

Top Row: current track number, total number of tracks on CD, total elapsed time of CD

Bottom Row: remaining time of CD, total time of CD



Display off

Video CD (with PBC disabled)

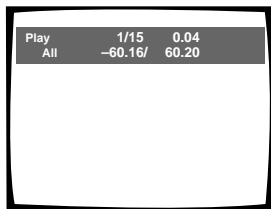

Disc information:

Top Row: current track number, total number of tracks, total elapsed time of Video CD

Bottom Row: remaining time of Video CD, total time of Video CD



Track information:

Top Row: current track number, total elapsed time of Video CD

Bottom Row: track time, total time of current track

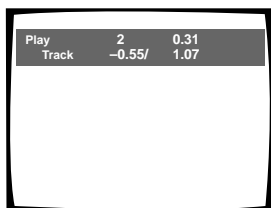

Track information:

Top Row: current track number, total elapsed time of Video CD

Bottom Row: remaining time of track, total time of current track



Display off

Press **DISPLAY** while a disc is stopped to display DVD title and chapter information or Video CD and CD track information. Press **DISPLAY** again to turn the display off.

Information about the titles and chapters or tracks on a disc is displayed. When the information exceeds the space on the screen, use the cursor buttons (◀/▶) to move to other screens.

DVD

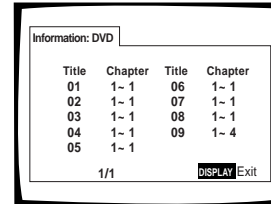

DVD information

When a DVD is loaded, each title and the number of chapters within each title is displayed.

CD/Video CD

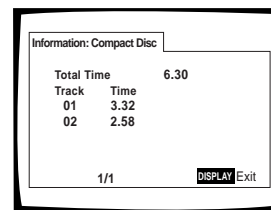

CD and Video CD information

When a CD or Video CD is loaded, the total time of the disc and the time of each track on the disc is displayed.

Note

Information for Super VCD is not displayed.

Changing the Background Color of the Screen Expert

You can select a blue or black background to appear when the player is in the stop mode.

Make changes to the [Background Color] setting in the Setup screen **General** menu in the "Expert" menu mode (page 27).

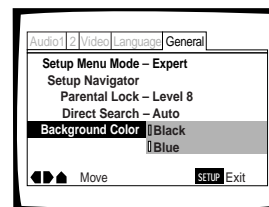

Settings: **Black**

Blue*

* Factory setting

Resetting the Player to System Settings

To reset the player, press and hold **STOP** ■ on the front panel when pressing **STANDBY/ON (POWER)** to turn the unit from standby (off) to on.

All saved settings from functions such as Last Memory and Condition Memory are cleared, and all Setup screen menus are returned to factory settings.

Additional Information

Disc Care

HOW TO HOLD DISCS

When loading or removing discs, try not to touch their playing surfaces.



CLEANING

Fingerprints or other dirt on the disc may affect sound and picture quality.

To clean your discs, use a soft clean cloth to wipe them. If necessary, moisten a soft cloth with diluted neutral detergent to remove heavy dirt or fingerprints.



Do not wipe in a circular direction (Concentric scratches in the disc groove tend to cause noise.)

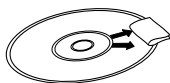

Gently wipe from the inside toward the outer edge.

Discs must not be cleaned with record cleaning sprays, or static prevention sprays, etc. Also do not use volatile liquids such as benzine, or thinner, etc.

LENS CLEANER

The player's pickup lens should not become dirty in normal use, but if for some reason it should malfunction due to soiling, contact your nearest PIONEER authorized service center. Lens cleaners are commercially available, but special care should be exercised in their use since some may cause damage to the lens.

NEVER PLAY CRACKED OR WARPED DISCS

The disc revolves in the player at high speed when it is played. Never play a cracked, scratched or warped disc. This may damage the player or cause it to malfunction.

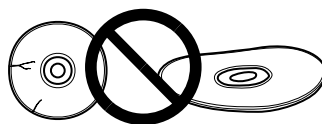

NEVER USE DISCS WITH SPECIAL SHAPES

CD's with special shapes (heart-shaped CDs, octagonal CDs, etc.) cannot be played on this set.

Attempting to do so may damage the set. Do not use such CDs.



AFTER USING DISCS, STORE THEM UPRIGHT

After playing a disc, always remove it from the player and return it to its jacket. Then store it standing upright away from heat and humidity.

- Store discs carefully. If you store discs at an angle, or stacked on top of each other, discs may become warped even when in their jackets.
- Do not leave discs in locations such as the seat of a car, which may become excessively hot.

CAUTION WHEN USING THE DISC

All rights reserved.

Unauthorized public performance, broadcasting or copying is a violation of applicable laws.

Notes on using optical cables

- Do not route cords around sharp angles. When storing, wind the cords so that they have a diameter of at least 15 cm (6 in.).
- When connecting, push all the way into the terminal.
- Do not use cords with a length of over 3 m.
- If moisture or dust has collected on the plug, wipe it with a soft cloth before connecting.

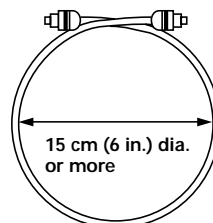

For Proper and Long Use of This Unit

DO NOT MOVE THE UNIT DURING PLAYBACK

During playback, the disc rotates at high speed. Do NOT lift or move the unit during playback. Doing so may damage the disc.

WHEN MOVING THE UNIT

WHEN MOVING THE UNIT

When changing places of installation or packing the unit for moving, be sure to remove the discs and return the disc table to its original position in the player. Then, press  on the remote control to switch the power to standby. **Check that the "--OFF--" indication on the display goes off**, then press **POWER** (for models with a POWER switch) to switch the power off, and disconnect the power cord. Moving this unit with the disc loaded may result in damage to this unit.

INSTALLATION

- Select a stable place to the side of a TV set or stereo system to be connected to the unit.
- When using the unit with a stereo system, install the speakers a little bit away from the TV.
- Do NOT install the unit on top of a TV or color monitor. Install the unit away from equipment that may be affected by magnetism, such as a cassette deck.
- Do NOT place objects on top of the unit.

AVOID INSTALLING IN A PLACE THAT IS:

- Exposed to direct sunlight
- Exposed to humidity or where ventilation is poor
- Extremely hot or cold
- Exposed to vibration
- Exposed to dust
- Exposed to oily smoke, steam or heat (for example, a kitchen)

DO NOT BLOCK VENTS

Do NOT use the player on top of a long-fibered carpet, bed or sofa, and do not cover it with a cloth, etc. This will prevent heat radiation and could result in damage.

AVOID HEAT

Do NOT place the unit on equipment which generates heat, such as an amplifier.

When installing the unit in a rack, place it on the lowest shelf possible (however, not where it is exposed to dust) and separated from the amplifier to avoid the heat generated by the amplifier or other audio equipment.

CAUTION: WHEN PLACING THE UNIT IN A STEREO RACK WITH GLASS DOORS

Be sure there is ample space between the unit and the glass doors when opening the disc table using the remote control. If the disc table opens against strong resistance, such as a closed glass door, damage to the unit may result.

CONDENSATION

Moisture may form in the operating section of the player if the player is brought from cool surroundings into a warm room or if the temperature of the room rises suddenly. When this happens, the player's performance will be impaired.

To prevent this, let the player stand in its new surroundings for about an hour before switching it on, or make sure that the room temperature rises gradually.

Condensation may also form during the summer if the player is exposed to the breeze from an air conditioner. In such cases, change the location of the player.



SWITCH POWER TO STANDBY WHEN NOT USING THE UNIT

Depending on the strength of the TV or radio broadcast signal, having the TV or radio on while power to the unit is on may result in stripes on the TV screen or noise. However, this is not a malfunction of this unit or the TV or radio. In such a case, switch the power of the unit to standby (off).

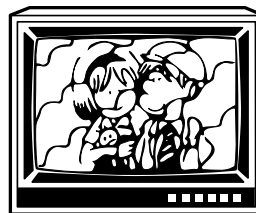

POWER-CORD CAUTION

Handle the power cord by the plug. Do not pull out the plug by tugging the cord and never touch the power cord when your hands are wet as this could cause a short circuit or electric shock. Do not place the unit, a piece of furniture, etc., on the power cord, or pinch the cord. Never make a knot in the cord or tie it with other cords. The power cords should be routed in such a way that they are not likely to be stepped on. A damaged power cord can cause a fire or give you an electrical shock. Check the power cord once in a while. When you find it damaged, ask your nearest PIONEER authorized service center or your dealer for a replacement.

Language Code List

Language codes are used when setting the audio and subtitle language preferences. (See page 39)

Language	Input-code
Japanese (ja)	1001
English (en)	0514
French (fr)	0618
German (de)	0405
Italian (it)	0920
Spanish (es)	0519
Dutch (nl)	1412
Russian (ru)	1821
Chinese (zh)	2608
Korean (ko)	1115
Greek (el)	0512
Afar (aa)	0101
Abkhazian (ab)	0102
Afrikaans (af)	0106
Amharic (am)	0113
Arabic (ar)	0118
Assamese (as)	0119
Aymara (ay)	0125
Azerbaijani (az)	0126
Bashkir (ba)	0201
Byelorussian (be)	0205
Bulgarian (bg)	0207
Bihari (bh)	0208
Bislama (bi)	0209
Bengali (bn)	0214
Tibetan (bo)	0215
Breton (br)	0218
Catalan (ca)	0301
Corsican (co)	0315
Czech (cs)	0319
Welsh (cy)	0325
Danish (da)	0401
Bhutani (dz)	0426
Esperanto (eo)	0515
Estonian (et)	0520
Basque (eu)	0521
Persian (fa)	0601
Finnish (fi)	0609
Fiji (fj)	0610
Faroese (fo)	0615
Frisian (fy)	0625
Irish (ga)	0701
Scots-Gaelic (gd)	0704
Galician (gl)	0712
Guarani (gn)	0714
Gujarati (gu)	0721
Hausa (ha)	0801

Language	Input-code
Hindi (hi)	0809
Croatian (hr)	0818
Hungarian (hu)	0821
Armenian (hy)	0825
Interlingua (ia)	0901
Interlingue (ie)	0905
Inupiak (ik)	0911
Indonesian (in)	0914
Icelandic (is)	0919
Hebrew (iw)	0923
Yiddish (ji)	1009
Javanese (jw)	1023
Georgian (ka)	1101
Kazakh (kk)	1111
Greenlandic (kl)	1112
Cambodian (km)	1113
Kannada (kn)	1114
Kashmiri (ks)	1119
Kurdish (ku)	1121
Kirghiz (ky)	1125
Latin (la)	1201
Lingala (ln)	1214
Laothian (lo)	1215
Lithuanian (lt)	1220
Latvian (lv)	1222
Malagasy (mg)	1307
Maori (mi)	1309
Macedonian (mk)	1311
Malayalam (ml)	1312
Mongolian (mn)	1314
Moldavian (mo)	1315
Marathi (mr)	1318
Malay (ms)	1319
Maltese (mt)	1320
Burmese (my)	1325
Nauru (na)	1401
Nepali (ne)	1405
Norwegian (no)	1415
Occitan (oc)	1503
Oromo (om)	1513
Oriya (or)	1518
Panjabi (pa)	1601
Polish (pl)	1612
Pashto, Pushto (ps)	1619
Portuguese (pt)	1620
Quechua (qu)	1721
Rhaeto-Romance (rm)	1813

Language	Input-code
Kirundi (rn)	1814
Romanian (ro)	1815
Kinyarwanda (rw)	1823
Sanskrit (sa)	1901
Sindhi (sd)	1904
Sangho (sg)	1907
Serbo-Croatian (sh)	1908
Sinhalese (si)	1909
Slovak (sk)	1911
Slovenian (sl)	1912
Samoan (sm)	1913
Shona (sn)	1914
Somali (so)	1915
Albanian (sq)	1917
Serbian (sr)	1918
Siswati (ss)	1919
Sesotho (st)	1920
Sundanese (su)	1921
Swedish (sv)	1922
Swahili (sw)	1923
Tamil (ta)	2001
Telugu (te)	2005
Tajik (tg)	2007
Thai (th)	2008
Tigrinya (ti)	2009
Turkmen (tk)	2011
Tagalog (tl)	2012
Setswana (tn)	2014
Tonga (to)	2015
Turkish (tr)	2018
Tsonga (ts)	2019
Tatar (tt)	2020
Twi (tw)	2023
Ukrainian (uk)	2111
Urdu (ur)	2118
Uzbek (uz)	2126
Vietnamese (vi)	2209
Volapük (vo)	2215
Wolof (wo)	2315
Xhosa (xh)	2408
Yoruba (yo)	2515
Zulu (zu)	2621

Troubleshooting

Incorrect operations are often mistaken for trouble and malfunctions. If you think that there is something wrong with this component, check the points below. Sometimes the trouble may lie in another component. Inspect the other components and electrical appliances being used. If the trouble cannot be rectified even after exercising the checks listed below, ask your nearest PIONEER authorized service center or your dealer to carry out repair work.

The disc table comes back out automatically, shortly after the disc table is closed.

The disc is dirty or warped.

- ➔ Refer to "Disc Care" (page 53).
- The disc is not placed properly on the disc table.
- ➔ Use the disc table guide to align the disc (page 22). Region number does not conform with this unit.
- ➔ If the region number on the disc does not match the number on the player, the disc cannot be used (page 59).

There is condensation on the operating section of the player.

- ➔ Allow time for condensation to evaporate. If player is near an air conditioning unit, you should move the player (page 54).

Playback is not possible.

The disc has been loaded upside down.

- ➔ Check that the disc has been loaded with the label side facing up.
- ➔ A Super VCD that does not conform with the IEC standards might not play normally.



mark appears on screen.

The selected function does not operate for that disc.



mark appears on screen.

The operation is prohibited by the player.

Picture playback stops and the operation buttons cannot be used.

- ➔ Stop disc playback (press **STOP** ■), then start playback again.

New settings made in the Setup screen menus while a disc is playing are ineffective.

Some settings can be changed while a disc is playing, but are not effective. This is not a malfunction.

- ➔ Make the same setting when the player is stopped.
- ➔ Stop disc playback (press **STOP** ■), then start playback again. When playback is resumed, the new settings should be in effect. Please note that making settings in the Setup screen menus may cancel the resume function.



When making changes in the Setup screen menus, is displayed.

There is a Super VCD/Video CD or CD loaded in the player and the setting that was changed only applies to DVD performance.

- ➔ The setting will be effective the next time a DVD is loaded.

Settings are canceled.

When the power is turned off by power failure, by switching the power off, or by unplugging the power cord, settings will be canceled.

- ➔ Before unplugging the power cord, press  on the remote control and check that "--OFF--" disappears in the display.

No picture/No color.

The audio recorded on the disc is not output properly.

- ➔ Adjust the Audio Out settings according to the connection used.

Connection is incorrect.

- ➔ Check that cord connections are correct and that plugs are firmly connected.

Operation (settings) of TV or AV amplifier is not appropriate.

- ➔ Be sure that your TV, receiver, or amplifier is set up to view DVD playback.

The screen is stretched or aspect does not change.

The multi aspect setting is not appropriate.

- ➔ Change the aspect setting in the [TV Screen] setting in the Setup screen **Video** menu to the screen type most appropriate to the TV or monitor you are using (page 29).

Picture disturbance during playback or dark.

This is not a malfunction.

- ➔ This player is compatible with Macro-Vision System copy guard. Some discs include a copy prevention signal, and when this type of disc is played back, stripes etc., may appear on some sections of the picture depending on the TV.

When recorded on a VCR or passed through an AV selector, there is disturbance in the playback picture.

This is not a malfunction.

- ➔ Due to the player's copy protection circuits, connection of this device through a VCR or an AV selector may prevent recording or cause picture problems.

Remote control operation is not possible.

The rear panel control input jack on the player is being used.

- ➔ Point the remote control at the component that the player is connected to (page 18).

The remote control is too far from the player, or the angle with the remote sensor is too wide.

- ➔ Be sure to operate the remote from a location within its operating range (page 9).

The batteries are exhausted.

- ➔ Replace the exhausted batteries with all new batteries (page 8).

Audio is not output or is distorted.

The Setup screen **Audio 1** menu [96 kHz PCM Out] setting is set to "96 kHz". Digital output is prohibited on some discs.

- ➔ Change the setting from 96 kHz to 48 kHz (page 28).

The disc is dirty.

- ➔ Refer to "Disc Care" (page 53).

The connection plugs are not inserted fully into the terminals or are not connected.

- ➔ Check that all connection plugs are firmly inserted.

The connection plug or terminal is dirty.

- ➔ Check that the plugs and terminals are wiped clean of dirt, etc.

Audio cable connection is wrong.

- ➔ Check to make sure that the audio cables are connected correctly (page 17).

Connection is made to the stereo amplifier's PHONO input terminal.

- ➔ Change connection to any input terminal except PHONO.

The pause mode is engaged.

- ➔ Press **PLAY ►** or **PAUSE II** to exit the pause mode.

Stereo amplifier operation is incorrect.

- ➔ Check input (CD, AUX, etc.) selector to determine if it is selected for DVD playback.

The DVD is recorded in DTS audio.

- ➔ DTS audio is only output from the digital output jacks. Connect the digital output on the player to the digital input on a receiver or amplifier with a built in DTS decoder to hear DTS audio.

Noticeable difference in DVD and CD volume.

DVDs and CDs use different recording methods.

- ➔ This is not a malfunction.

The audio recorded on the disc is not output properly.

- ➔ Adjust the Audio Out settings according to the connection used.
- ➔ If the audio is switched to "2" when playing a Super VCD that contains only one stereo soundtrack, there may be no sound at all. To restore the sound, return the AUDIO switch back to its original position (page 38).

Digital output is not possible for audio.

- ➔ There is no digital output during Karaoke mode. Set to Normal mode.

The menu screen is not displayed during Video CD playback.

- ➔ Turn on the Playback Control function.
-

For Karaoke mode only

Key control and Once more are not possible with a mic featuring controls.

- ➔ Connect the microphone to the MIC jack.

The singer's voice is not heard or always heard.

- ➔ Confirm that the KARAOKE SETUP (page 34) and the ONE-TOUCH KARAOKE (page 33) operations have been performed correctly.

There's howling.

- ➔ Do not hold the microphone near the speakers (page 31).

Karaoke operations are not possible or there is no sound from the mic.

- ➔ The selected mode is Normal. Press the KARAOKE MODE button to select the Karaoke mode.

DVD, Super VCD, Video CD, CD volume is low.

- ➔ In Karaoke mode, the volume is low by design. This is not a problem with the system (page 35).
-

Caution

Static electricity or other external influence may cause malfunctioning of this unit. In this case, unplugging the power cord and then re-plugging it in will usually reset the unit for proper operation. If this does not correct the problem, please consult your nearest PIONEER service center.

Terms

Aspect ratio

Aspect ratio refers to the length to height ratio of TV screens. The ratio of a standard TV is 4:3, while the ratio of a high-definition or wide TV is 16:9. The latter allows you to enjoy a picture with a wider perspective.

Chapter number

Chapter numbers are the numbers assigned to sections of a title on the disc, similar to chapters in a book. If the disc includes chapter numbers, you can locate the section you want very quickly using search and other functions.

Digital bitstream

The bitstream does not refer to the audio signal, but rather to the digital data that, once converted, becomes the audio signal. The player outputs digital bitstreams via the digital optical or digital coaxial output. If the bitstream cannot be decoded by the connected AV amplifier etc., digital noise is produced. Digital bitstream formats compatible with different entertainment systems can be selected in the Setup screen **Audio 1** menu.

Digital output (Coaxial)

Output of the digital audio signal is transmitted electronically using a coaxial cable. Because the signal being transmitted is digital, connection must be made to the coaxial digital input of another component. Noise will be output if connected to the analog audio inputs as the digital signal cannot be decoded.

Digital output (Optical)

Normally, audio is converted to an electric signal and transmitted through an electric wire from the player to the amplifier, etc. Changing this signal to a digital signal and transmitting it through an fiber-optic cable is called optical digital output. Similarly, optical digital input receives digital signals from external units such as an AV amplifier or receiver.

Dolby Digital

The maximum 5.1 channels of audio used in the surround system (Surround Digital) for movie theaters is digital data compressed by the third generation algorithm encoder, AC-3.



In order to enjoy Dolby Digital discs, this unit's digital output jack (either coaxial or optical) must be connected to the digital input jack of an AV amplifier with Dolby Digital decoding capability or to a Dolby Digital decoder.

DTS

DTS stands for Digital Theater System. DTS is a surround system different from Dolby Digital that has become a popular surround sound format for movies, as well as CDs. In order to enjoy the benefits of DTS encoded discs, the digital output jack (either coaxial or optical) of this player needs to be connected to an AV amplifier or receiver or to a DTS decoder to be able to enjoy the surround sound of DTS audio. DTS audio is not output from the analog audio outputs.



Dynamic range

Dynamic range refers to the difference between the maximum and minimum levels of the audio soundtrack as measured in decibels (dB).

Compressing the dynamic range raises the minimum signal level and lowers the maximum signal level. This allows you to hear voices and other low level audio signals clearly while lowering strong audio signals like the sound of explosions.

Karaoke mode

This mode is used when you desire to enjoy Karaoke. There is no digital output when using in the Karaoke mode. Set to the Normal mode when desiring to enjoy movies or music.

MPEG

Short for Moving Picture Experts Group. This is an international standard for compression of moving images. On some DVDs, digital audio has been compressed and recorded in this format.

Multi-angle

When you watch a TV program, you are watching the image filmed through the TV camera. Because of this, the picture is displayed on your TV from the viewpoint of the TV camera's position. In a TV studio, the image is filmed by many cameras at the same time, and one of those images is selected by the program director and transmitted to your TV. If all the filmed images were transmitted to your TV you would be able to select the camera image you want. Some DVD discs are recorded with the angles of more than one camera used for filming, and these can be selected using this player. These types of discs are called multi-angle discs.

Multi-Language Subtitles

Subtitles are language titles superimposed on movies, or other media. Up to 32 different subtitle languages can be recorded on a DVD disc. The subtitle function can be used to select the language of your choice.

Multiple Languages

On DVDs, you can select the language on when watching movies or other media that have multiple language and/or audio soundtracks recorded on them. Up to 8 different language and/or audio soundtracks can be recorded on a DVD disc.

Parental lock level

This function was suggested by parents concerned about what type of media their children were able to watch. Parental lock restrictions are restrictions incorporated into titles which include scenes that parents may not wish their children to view.

PCM

PCM stands for Pulse Code Modulation and is digital audio. The digital audio of CDs is PCM. This player also has a function that converts Dolby Digital and MPEG digital bitstreams into PCM to enable you to listen to quality digital sound even without a special decoder.

Playback Control (PBC)

This refers to signals recorded on a Super VCD or a Video CD (Version 2.0) enabling playback control.

You can use menus recorded on discs with PBC for easy, interactive search for desired scenes, and playback.

You can also enjoy viewing high-resolution/standard resolution still images.

Regional restriction codes (region number)

Regional restriction codes are built in to DVD players and DVD discs for each sales region. If the regional code of the DVD player does not match one of the regional codes of the DVD disc, playback is not possible.

The region number can be found on the rear panel of the DVD player. The illustration below shows the regions and corresponding region numbers.

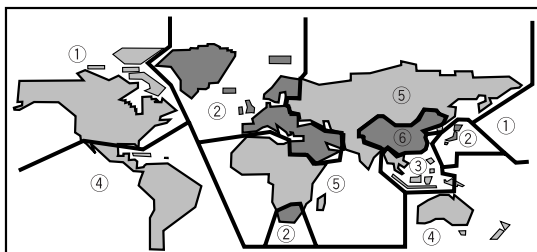

Sampling Frequency

When a sound wave is converted to a digital signal, the sound is sampled and converted to data at a specific frequency rate. For example, a signal with a 96 kHz sampling rate indicates that in one second, the analog signal was sampled 96000 times to produce the digital signal.

S-video

Connecting the S-video output on the player to a TV or monitor with S-video input via an S-video cable produces clearer picture reproduction by sending separate signals for the luminance and the color. These signals are then combined by the television to produce a better quality picture.

System control

When you connect this player via a cord with a mini plug to another Pioneer component such as a receiver or an amplifier bearing the  mark, you can control the player as though it were a component in a system. To control the player, point the player's remote control at the component that the player is connected to, and not the player itself.

Title number

DVD discs are divided into units referred to as titles, and titles are divided into chapters. Menu screens do not belong to any title. A disc which contains a movie may have only one title with many or no chapter divisions. Karaoke discs may have many titles, assigning a title to each song on the disc.

Specifications

General

System DVD system, Video CD system
and Compact Disc digital audio system

Power requirements
DV-K102 AC 110-127, 220-240 V, 50/60 Hz
DVD-V550 AC 120 V, 60 Hz

Power consumption 14 W

Power consumption in standby mode
DV-K102 0.9 W
DVD-V550 0.7 W

Weight 3.0 kg (6 lb 6 oz)

Dimensions 420 (W) x 288 (D) x 104 (H) mm
(16 ⁹/₁₆ (W) x 11 ¹/₃ (D) x 4 ¹/₁₆ (H) in.)
(Not including protruding cables, etc.)

Operating temperature +5°C to +35°C (+36°F to +96°F)

Operating humidity 5% to 85% (no condensation)

S-Video output

Y (luminance) - Output level 1 Vp-p (75 Ω)
C (color) - Output level 286 mVp-p (75 Ω)
Jack S-VIDEO jack

Video output

Output level 1 Vp-p (75 Ω)
Jack RCA jack

Audio output

Output level 200 mVrms (1 kHz, -20 dB)
Number of channels 2
Jacks RCA jacks

Digital audio characteristics

Frequency response 4 Hz to 44 kHz (DVD fs: 96 kHz)
S/N ratio 115 dB
Dynamic range 102 dB
Total harmonic distortion 0.002%
Wow and flutter Limit of measurement
(±0.001% W. PEAK) or lower

Digital output

Optical digital output Optical digital jack
Coaxial digital output RCA jack

Other terminals

CONTROL IN Minijack (3.5 ø)

Accessories

Remote control unit 1
AA (R6P) dry cell batteries 2
Audio cord 1
Video cord 1
Power cord 1
Operating Instructions 1

Note

The specifications and design of this product are subject to change without notice, due to improvement.

Published by Pioneer Corporation.
Copyright © 1999 Pioneer Corporation.
All rights reserved.

PIONEER CORPORATION

4-1, Meguro 1-Chome, Meguro-ku, Tokyo 153-8654, Japan

PIONEER ELECTRONICS [USA] INC.

P.O. BOX 1540, Long Beach, California 90801-1540, U.S.A.

PIONEER NEW MEDIA TECHNOLOGIES, INC.

Headquarters: 2265 East 220th Street, Long Beach, California 90810, U.S.A. TEL: (310)952-2111

PIONEER ELECTRONICS OF CANADA, INC. 300 Allstate Parkway, Markham, Ontario L3R 0P2, Canada

PIONEER ELECTRONIC [EUROPE] N.V. Haven 1087, Keetberglaan 1, 9120 Melsele, Belgium TEL: 03/570.05.11

PIONEER ELECTRONICS AUSTRALIA PTY. LTD. 178-184 Boundary Road, Braeside, Victoria 3195, Australia, TEL: [03] 9586-6300

PIONEER ELECTRONICS DE MEXICO, S.A. DE C.V. San Lorenzo Num 1009 3er Piso Desp. 302 Col. Del Valle, Mexico D.F. C.P. 03100
TEL: 5-688-52-90

Free Manuals Download Website

<http://myh66.com>

<http://usermanuals.us>

<http://www.somanuals.com>

<http://www.4manuals.cc>

<http://www.manual-lib.com>

<http://www.404manual.com>

<http://www.luxmanual.com>

<http://aubethermostatmanual.com>

Golf course search by state

<http://golfingnear.com>

Email search by domain

<http://emailbydomain.com>

Auto manuals search

<http://auto.somanuals.com>

TV manuals search

<http://tv.somanuals.com>