

Pitco Frialator[®]

There's Always Something Cooking!

Installation, Operation, and Maintenance Manual
For Electric Fryers With Options

Counter Top Models:
E12 & E12SS

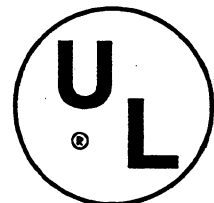
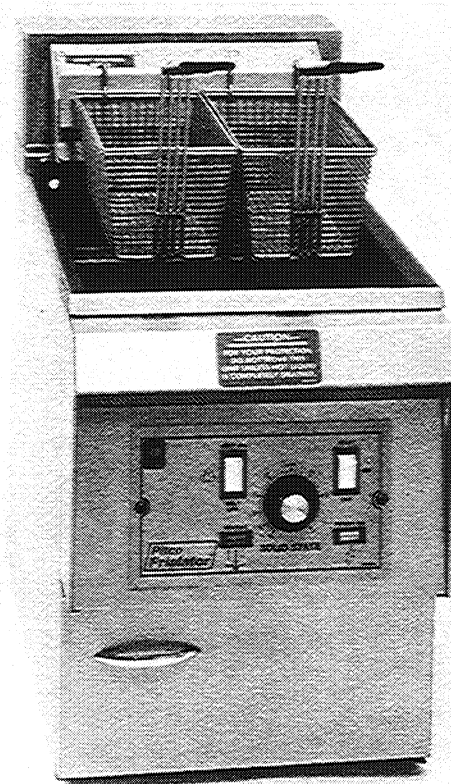

MTS # PF09-01

Pitco Frialator #20-052

Revision 3

Rev. Date 04/09/93

NOTICES

There are three different types of notices that you should be familiar with, a NOTICE, CAUTION, and WARNING. A NOTICE is a special note used to call attention to a particularly important point. CAUTION is used to point out a procedure or operation which may cause equipment damage. The WARNING notice is the most important of the three because it warns of an operation that may cause personal injury. Please familiarize yourself with your new cooker before operating it and heed the notices throughout this manual. The WARNINGS are listed below and on the following page for your review prior to operating the unit.

FOR YOUR SAFETY

DO NOT store or use gasoline or other flammable vapors or liquids in the vicinity of this or any other appliance.

WARNING: Improper installation, adjustment, alteration, service or maintenance can cause property damage, injury or death. Read the installation, operating and maintenance thoroughly before installing or servicing this equipment.

THIS MANUAL MUST BE RETAINED FOR FUTURE REFERENCE

SAFETY

SAFETY

SAFETY

SAFETY

SAFETY

WARNING

The fryer must be electrically grounded in accordance with local codes. If local codes do not apply follow the requirements of National Code ANSI/NFPA 70-1990

WARNING

Before proceeding with installation, ensure that the switch marked OFF-ON-START are in the OFF position. Also ensure that all the circuit breakers for the appliance are OPEN or OFF. NEVER connect the fryer with power applied to the power lines.

WARNING

The heating elements MUST be covered with water or oil before they are turned on. NEVER turn on the fryer unless the elements are covered by at least one inch of liquid.

WARNING

Never melt blocks of shortening on top of the heating elements. This will cause a fire, and void your warranty.

WARNING

Water and shortening DO NOT mix. Keep liquids away from hot shortening. Dropping liquid frozen food into the hot shortening will cause violent boiling.

WARNING

To prevent burns, always ensure the fryer is completely COOLED down before working on the fryer.

WARNING

It will be easier and safer if the filter assembly has cooled to room temperature before handling any filter parts.

WARNING

All power supplies must be disconnected before servicing or cleaning the appliance. Some appliances have more than one power supply. Make sure they are ALL disconnected.

SAFETY

SAFETY

SAFETY

SAFETY

SAFETY

SAFETY

SAFETY

SAFETY

SAFETY

SAFETY

WARNING

DANGER - HIGH VOLTAGE PRESENT

The fuses for the fryer's heating elements and controls are located inside the back enclosure of the fryer. Extreme care must be taken when opening the back cover of the fryer. **NEVER** remove the back cover of the fryer unless all power to the appliance has been disconnected.

SAFETY

SAFETY

SAFETY

SAFETY

SAFETY

Table of Contents

Section	Title	Page
	Safety Notice	
	Table of Contents	i-ii
	List of Tables and Figures	iii
Chapter 1: General Information and Installation		1-1
1.1	INTRODUCTION	1-1
1.2	CHECKING YOUR NEW FRYER	1-2
1.2.1	Check Your Order	1-2
1.3	ASSEMBLY AND LEVELING	1-2
1.4	INSTALLATION	1-2
1.4.1	Installation Clearances	1-3
1.4.2	CO ₂ Fire System	1-3
1.4.3	Electrical Connection	1-3
1.4.4	Ventilation and Fire Safety Systems	1-5
1.5	INITIAL ADJUSTMENTS	1-6
1.5.1	Visual Checks	1-6
1.5.2	Initial Cleaning	1-7
1.5.3	Solid State Thermostat Calibration Check	1-8
Chapter 2: Operating Instructions		2-1
2.1	FILLING THE FRYER	2-1
2.1.1	Filling the Fryer With Liquid Shortening	2-1
2.1.2	Filling the Fryer With Solid Shortening	2-1
2.2	OPERATING INSTRUCTIONS	2-2
2.2.1	Fryer Start-Up	2-2
2.2.2	Fryer Shutdown	2-2
2.2.3	Power Failure	2-3
2.3	DAILY CLEANING	2-3
CHAPTER 3: Maintenance, Adjustments, and Service		3-1
3.1	WEEKLY FRYER CLEANING (BOIL OUT)	3-1
3.2	CHECKING AND REPLACING FUSES	3-2
3.3	TESTING CONTACTORS AND RELAYS	3-3
3.4	TESTING HEATING ELEMENTS	3-3
3.5	TESTING THE TEMPERATURE SETTING POTENTIOMETERS	3-4
3.6	TESTING THE TEMPERATURE CONTROL MODULE	3-4
3.7	TESTING THE TEMPERATURE PROBE	3-5

Table of Contents (Continued)

Section	Title	Page
3.8	TESTING THE HEATING ELEMENT INTERLOCK SWITCH	3-5
3.9	SERVICE	3-6
3.9.1	Replacement Procedures	3-6
3.9.1.1	Heating Element Removal and Replacement	3-6
3.10	TROUBLESHOOTING	3-8
3.10.1	Fryer Troubleshooting	3-8
CHAPTER 4: Parts		4-1
	ALPHABETICAL PART LIST	4-4
	NUMERICAL PART LIST.....	4-6
CHAPTER 5: Schematic		5-1

List of Tables and Figures

Table	Title	Page
1-1	Fryer Specifications	1-1
1-2	Electrical Requirements for Various Fryer Models	1-4
1-3	Ventilation and Fire Safety References	1-5

Figure	Title	Page
1-1	Inside Fryer Tank	1-6
4-1	Outside View	4-2
4-2	Fryer Electrical Components (Back of Fryer)	4-3

Chapter 1: General Information and Installation

Congratulations on the purchase of your new Pitco Frialator counter top electric fryer. This unit will give you many years of reliable service if you follow the simple operation and maintenance procedures in this manual. Contained in this manual are the general installation, operation, and maintenance procedures for the counter top electric fryer models E12 and E12SS

1.1 INTRODUCTION

All models come standard with solid state temperatures controls, automatic melt cycle controller, and built in safety devices. To find out which model you have look at the identification plate inside the door. This plate has a lot of useful information, but to identify which fryer you have, look at the model number block. The model number identifies which fryer and what features you have. Models E12 and E12SS both have the same features. The difference between these two models is that model E12SS has a stainless steel fry tank. Table 1-1 has a list of fryer specifications.

Table 1-1 Fryer Specifications

Specification Description	Domestic Units (USA)	Foreign Units (Metric)
Hourly Electric Input	10.5 KW	10.5 KW
Hourly French Fry Production	45 Lbs.	20.4 Kgs.
Minimum Fat Capacity	28 Lbs.	13.6 L
Frying Area	12" x 12"	30.5 x 30.5 cm
Frying Depth	3-3/4"	9.5 cm
Drain Valve Size	1" NPT	2.54 cm
Shipping Weight	80 Lbs.	36.3 Kgs.
Voltage(s)	208 VAC, 240 VAC, or 480 VAC	208 VAC, 240 VAC, or 480 VAC

1.2 CHECKING YOUR NEW FRYER

Your new fryer has been carefully packed. Every effort has been made to ensure that your fryer will be delivered to you in perfect condition. As you unpack the fryer, inspect each of the pieces for damage. If something is damaged, **DO NOT** sign the bill of lading. Contact the shipper immediately, because the shipper is only responsible for damages for 15 days after delivery. Check the packing list enclosed with your fryer to ensure that you have received all of the parts to the fryer. If you are missing any parts, contact the dealer from whom the fryer was purchased.

Locate your Pitco Frialator warranty and fill in the serial number of the fryer and the date received. You will find the serial number on the plate inside the door. Put your warranty card in a safe place for future reference. **DO NOT** return the card to Pitco Frialator.

1.2.1 Check Your Order

The crate containing the fryer unit will also contain the following:

- (2) Fry baskets per fryer
- (1) Fry Basket Hanger per fryer
- (2) Pitco Cleaner Sample
- (1) Drain Clean Out Rod
- (1) Drain Line Extension

1.3 ASSEMBLY AND LEVELING

When you receive your fryer it is completely assembled. In some cases if you have purchased a multi-fryer unit some simple assembly may be required.

1.4 INSTALLATION

Although it is possible for you to install and set up your new fryer, it is **STRONGLY** recommended that you have it done by qualified professionals. The professionals that install your new fryer will know the local building codes and ensure that your installation is safe.

WARNING

The Fryer **MUST** be secured to the counter top. This prevents the moving and accidental splashing of hot oil on personnel.

1.4.1 Installation Clearances

The fryer needs clearance around it for proper and safe operation. These clearances provide adequate distance to prevent combustible materials from coming in contact with hot fryer surfaces. The clearances shown are for cooker installation in combustible and non-combustible construction.

	Combustible Construction	Non-Combustible Construction
Back	6"	0"
Sides	6"	0"

1.4.2 CO₂ Fire System

Your new fryer has a CO₂ tie in that is designed to be electrically connected to the building fire protection system. The CO₂ tie in is an electrical connector built into the 24 VAC fryer control system. To connect the fryer to the building fire system, remove the connector jumper.

CAUTION

Do not apply power to this connector. This connection must be used with a normally closed relay type system.

Cut the jumper wire and splice the ends of the wire to the building fire protection system. When this point is broken by the building fire protection system, the fryer will completely shut down. Once shutdown a fire can be quickly extinguished.

1.4.3 Electrical Connection

WARNING

The fryer must be electrically grounded in accordance with local codes. If local codes do not apply follow the requirements of National Electrical Code ANSI/NFPA 70-1990.

The electrical service used by the fryer must comply with local codes. If there are no local codes that apply, refer to the National Electrical Code (NEC) to install the service. In Canada refer to CSA Standard C22.1 Canadian Electrical Code Part 1 & 2, and local codes. The type of power supplied to the fryer is dependent on the model of the fryer. While the fryers can be configured to accept a variety of electrical power, the heating elements are designed for a particular voltage range.

WARNING

Before proceeding with installation, ensure that the switch marked OFF-ON-START is in the OFF position. Also ensure that all the circuit breakers for the appliance are OPEN or OFF. NEVER connect the fryer with power applied to the power lines. Some appliances have more than one power supply. Make sure they are ALL disconnected.

You fryer is shipped with the internal wiring connected to support the voltage and phase requirements ordered. You can verify the wiring configuration by comparing the schematic supplied with the fryer to the wiring arrangement of your fryer. Table 1-2 provides a list of models and voltage ranges along with the heating element part number for that voltage range. Check the fryer data plate to ensure that the fryer you are installing matches the power to be supplied to it.

CAUTION

Connecting the fryer to the wrong power supply may cause damage to the fryer and will void the warranty.

Table 1-2 Electrical Requirements for Various Fryer Models

Model Number	Voltage & Phase Arrangement	Line Current & Total Power	Heater Element Part Number
E12	208 VAC Single Phase (2 wires and a ground)	50.5 AMPS/Line 10.5 KW	P5046923
E12	208 VAC Three Phase (3 wires and a ground)	29.2 AMPS/Line 10.5 KW	P5046923
E12	240 VAC Single Phase (2 wires and a ground)	43.8 AMPS/Line 10.5 KW	P5046924
E12	240 VAC Three Phase (3 wires and a ground)	25.3 AMPS/Line 10.5 KW	P5046924
E12	480 VAC Three Phase (3 wires and a ground)	12.6 AMPS/Line 10.5 KW	P5046951

1.4.4 Ventilation and Fire Safety Systems

Your new fryer must have proper ventilation to function safely and properly. It is very important to install a fire safety system. Your ventilation system should be designed to allow for easy cleaning. Frequent cleaning of the ventilation system and the fryer will reduce the chances of fire. Table 1-3 provides a list of reference documents that give additional guidance on ventilation and fire safety systems. This table is not necessarily complete.

Table 1-3 Ventilation and Fire Safety References

Topic	Underwriters Laboratory Document	National Fuel Gas Code Document
Grease Extractor	ANSI/UL 710-1981	ANSI/NFPA 96-1987
Ventilation Hood	ANSI/UL 705-1984	ANSI/NFPA 96-1987
Filter Unit	ANSI/UL 586-1985 ANSI/UL 900-1987	ANSI/NFPA 96-1987
Types of Fire Extinguishers and Detection Equipment		
CO ₂	ANSI/UL 154-1983	ANSI/NFPA 12-1989
Dry Chemical	ANSI/UL 299-1984	ANSI/NFPA 17-1985
Water	ANSI/UL 626-1984	ANSI/NFPA 13-1989
Foam		ANSI/NFPA 11-1988
Sprinklers	ANSI/UL 199-1982	ANSI/NFPA 13-1989 ANSI/NFPA 13-1989
Smoke Detectors	ANSI/UL 268-1981	ANSI/FPA 72B-1986
Fire Detection Thermostats	ANSI/UL 521-1987	ANSI/FPA 72B-1986

INITIAL ADJUSTMENTS

If your fryer has been installed as described in section 1.4, it needs to be checked and adjusted to ensure that it will perform as designed.

1 Visual Checks

Before you begin filling and adjusting the fryer, perform the following visual checks:

- a. After the fryer is in its permanent location check its levelness. For proper and safe operation the fryer must be level.

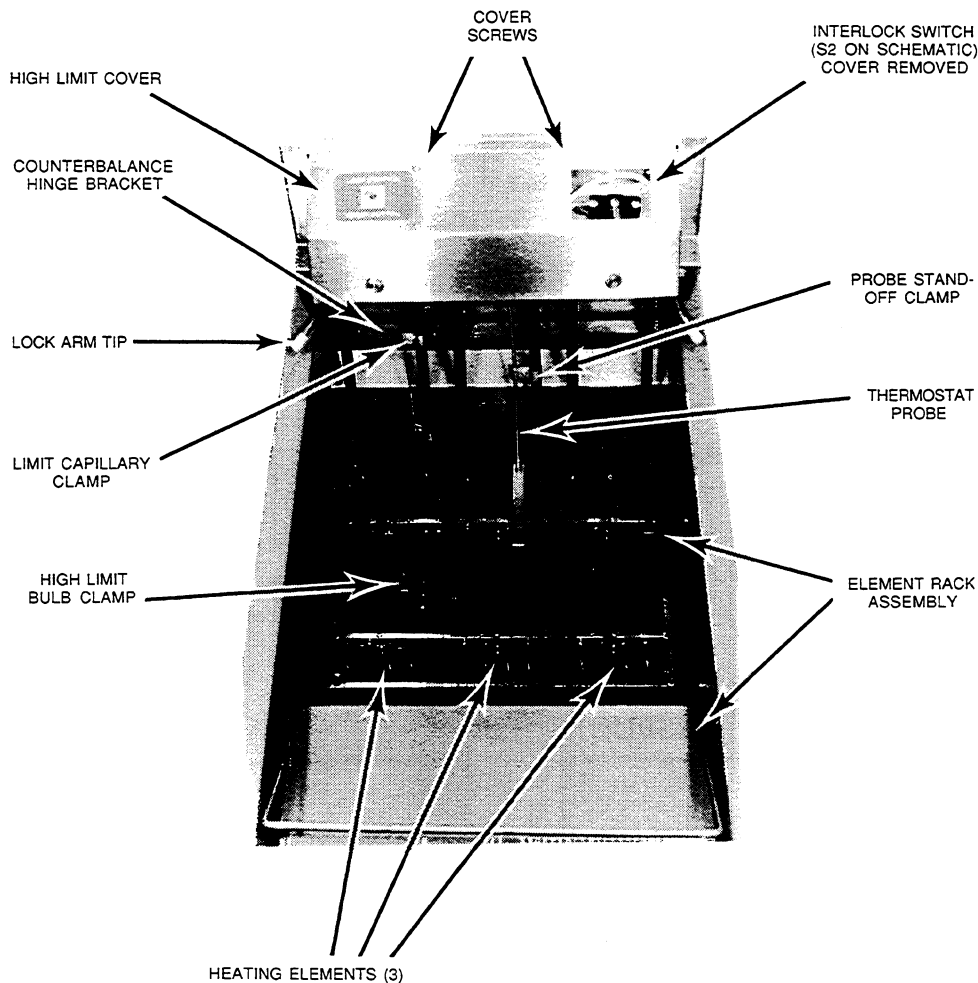

Figure 1-1 Inside Fryer Tank

- b. Check the temperature bulbs (thermostat/high-limit) and other fryer tank components to ensure that the mounting screws are tight and all components are secure. Ensure that the heating elements are down and in place. Figure 1-1 shows fryer tank components.

1.5.2 Initial Cleaning

When the fryer is shipped, many of its parts are covered with a thin coat of high quality shortening for protection. Before the fryer is ready for cooking it must be cleaned. This will remove the oil coating and any foreign matter that may have accumulated during storage and shipment. After the fryer has been installed and checked by a qualified professional clean the fryer as described below.

NOTICE

Since this will be the first time the fryer is turned on since leaving the factory, be observant for any unusual signs of trouble. Any time a new piece of equipment is energized there will be some odors as new components heat up. This is normal. If odors persist or excessive smoke is seen **TURN OFF** the power to the appliance at the service panel. Have a qualified technician check out the unit for the cause.

WARNING

The heating elements **MUST** be covered with water or oil before they are turned on. **NEVER** turn on the fryer unless the main elements are covered by at least one inch of liquid.

WARNING

All power supplies must be disconnected before servicing or cleaning the appliance. Some appliances have more than one power supply. Make sure they are **ALL** disconnected.

- a. Check the drain valve to ensure that it is closed. Fill the fryer with water to the fill line marked on the back of the tank.
- b. Press the **START** side of the **OFF-ON-START** switch and release. The switch will snap back to the **ON** position. Switch the Melt Switch to **MELT OFF**. Set the thermostat to **220°F**. The **HEATING ON** light will be on while the elements are on. Bring the water to a gentle boil.
- c. Allow the fryer to heat for **15 minutes**. Add Pitco cleaner, stirring to ensure cleaner has dissolved thoroughly.

NOTE

Do not leave the fryer unattended during cleaning. Never let the water level go below the "Min Level" mark on the back of the tank.

- d. Using the fryer cleaning brush, and insulated rubber gloves, scrub the inside of the fryer to remove protective coating.

- e. When cleaning is complete, Press the OFF side of the OFF-ON-START switch to turn the fryer off. Drain the water into a container suitable for hot water and dispose of it.
- f. When the tank has cooled, rinse it thoroughly with cool water. Continue to rinse the tank until the cleaner has been rinsed thoroughly from the tank.
- g. Using a clean dry cloth, wipe out all of the water. Be very thorough removing the water, because any residual water will cause hot oil to splatter out of the fryer.

CAUTION

Fryers with mild steel tanks must be wiped down and coated with oil to keep the tank from rusting. This must be done if the fryer is not going to be used immediately.

- h. Now that the tank is clean, you are ready to fill and operate the fryer. Refer to 2.1 for instructions on adding shortening to the fryer.

1.5.3 Solid State Thermostat Calibration

The solid state temperature sensing and control module (G0) is located behind the fryer's front bezel (control panel). To set how the control module maintains the fryer's temperature you need only change the thermostat's knob setting.

- a. Place the tip of an accurate thermometer in the shortening approximately 1" above the temperature sensor.
- b. Set the thermostat knob to 325°F and wait for the temperature reading on the thermostat to rise.
- c. Let the fryer cycle 4 to 6 times before checking the temperature. Compare the thermometer temperature against the thermostat knob setting. If the values are more than 5°F apart go to step d to calibrate the knob setting.
- d. Loosen the set screw that holds the thermostat knob to its shaft.
- e. Rotate the thermostat dial without moving the shaft to the temperature indicated on the thermometer. Tighten the set screw on the thermostat dial to lock the dial in place.
- f. Adjust the thermostat to a new setting and allow the fryer to cycle 4 to 6 times at the new setting. Check the thermometer temperature against the thermostat knob setting. If the temperature is $\pm 5^\circ\text{F}$ of the thermostat knob setting the thermostat knob is calibrated. If the temperature is greater than 5°F away from the dial setting, repeat the calibration procedure again.

Chapter 2: Operating Instructions

This chapter describes how to operate your fryer to obtain the best performance. Included in this chapter are filling, operating, and cleaning instructions for electric fryers.

2.1 FILLING THE FRYER

Both liquid and solid shortening can be used in the fryer, but liquid is preferred. If solid shortening is used, it is recommended that you melt the shortening and then pour the melted shortening into the fryer. If you must melt the shortening in the fryer follow step 2.1.2 for filling the fryer with solid shortening.

2.1.1 Filling the Fryer With Liquid Shortening

- Make sure the drain valve is completely closed.
- Fill the fryer with oil to the "Oil Level" line marked on the back of the tank.

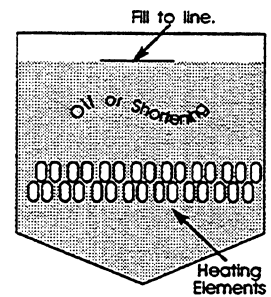

2.1.2 Filling the Fryer With Solid Shortening

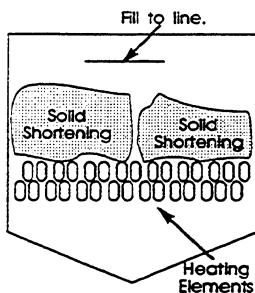

WARNING

Never melt blocks of solid shortening on top of the heating elements. This will cause a fire, scorch the shortening, and void your warranty.

- Make sure the drain valve is completely closed.
- Pivot the heating elements up out of the way. Cut the shortening into cubes no larger than 1". ALWAYS pack the shortening below, between, and on top of the heating elements. DO NOT leave any large air gaps. Use care when packing the solid shortening in the tank. DO NOT bend or break the temperature sensor probes. If these are damaged the fryer will not function properly.
- Lower the heating elements back into the fryer and continue packing the shortening around and on top of the heating elements.
- Once the fryer is packed with shortening, the shortening must be melted. To melt the shortening refer to the Fryer Start Up section for your fryer.

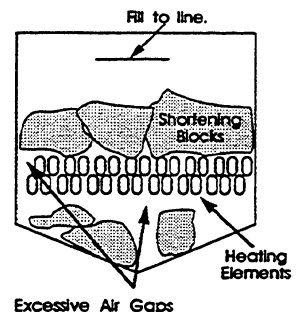

2.2 OPERATING INSTRUCTIONS

To ensure the food always comes out the very best, follow the preparation instructions for the food you are cooking. Using the best shortening makes the best fried foods. The best shortening will last longer than lower grade shortening and save you money. When not in use the shortening should be cooled and covered to prevent contamination.

WARNING

Water and shortening **DO NOT** mix. Keep liquids away from hot shortening. Dropping liquid frozen food into hot shortening will cause violent boiling and may cause hot oil to boil out of the fryer.

2.2.1 Fryer Start-Up

DO NOT START FRYER WITHOUT FILLING WITH OIL!

- a. Apply power to the fryer by closing the appropriate circuit breaker(s).
- b. Turn the temperature control knob (thermostat) to the desired temperature setting. This knob is located on the front panel of the fryer. If a melt cycle is desired, press the MELT ON side of the melt switch.
- c. Turn the fryer on by pressing the START side of the OFF-ON-START switch and release. The switch will snap back to the ON position. The HEATING ON light will be on while the elements are on.
- d. MELTING SOLID SHORTENING - The melt cycle is designed to melt solid shortening without scorching it. During melt the heating elements will cycle on for 4 seconds and remain off for 26 seconds. This will heat the shortening slowly to 150°F (65°C). At 150°F the heating elements will remain on constantly until the shortening reaches the thermostat setting. Anytime the shortening temperature is below 150°F the melt cycle will automatically be working. To turn the melt cycle off press the MELT OFF side of the Melt switch.
- d. The temperature control system will maintain the shortening temperature at the desired level by cycling the heating elements as necessary. The fryer is now ready for cooking.

2.2.2 Fryer Shut-Down

Shutdown the fryer by pressing the OFF side of the OFF-ON-START switch. The fryer is now shutdown and can be cleaned or serviced.

2.2.3 Power Failure

If power is removed from the unit for any reason, it will shut down. To restart the fryer, follow the Fryer Start-Up procedures as you normally would.

2.3 DAILY CLEANING

Your fryer should be cleaned every day to maintain peak performance and appearance. Perform the procedures below every day.

- a. Wipe up any shortening that spills onto the exterior of the fryer. This should be done with a clean soft cloth while the oil is still warm.
- b. Use warm water with a mild detergent to clean surfaces. Be careful not to get water in the shortening and to remove any detergent from the fry tank.
- c. Use a non-abrasive scouring powder or pad to clean stains if necessary.
- d. Perform the weekly boil out cleaning of your fryer described in section 3.1.

Chapter 3: Maintenance, Adjustments, and Service

This chapter provides you with the information and procedures necessary to perform basic fryer maintenance and adjustments. If after performing maintenance on your fryer it does not perform properly, contact your authorized service center.

WARNING

All power supplies must be disconnected before servicing or cleaning the appliance. Some appliances have more than one power supply. Make sure they are ALL disconnected.

3.1 WEEKLY FRYER CLEANING (BOIL OUT)

The fryer should be thoroughly cleaned once a week. This cleaning should include a complete draining of the fryer and a boil out.

- a. You will need a container large enough to hold 1 1/2 times the oil in one tank. This container should also be able to withstand boiling water temperatures.

CAUTION

Always shut down the fryer before draining the tank. This will prevent the heating elements from coming on during the oil draining and water filling procedure.

- b. Drain the oil from the fryer and discard or save for reuse. Pivot the heating elements up out of the way and remove any large debris from the bottom of the fry tank. Once clean lower the elements back into the fry tank. Close the drain valve and fill the fry tank with water and noncaustic detergent. For best results use Pitco Fryer Cleaner part number P6071397 (sample packet included with new fryer).

NOTE

The heating elements have a safety feature built into them that prevents them from energizing when they are up. This interlock switch is located under the element pivot box. If the elements fail to work after they have been raised ensure that they have been fully inserted back into place.

- c. Restart your fryer as described in 2.2 and set the thermostat to approximately 200°F and bring the water to a slow boil. DO NOT allow water to boil because excessive foaming will occur

- d. Allow the fryer to soak for 20 minutes to soften shortening deposits and carbon. Use fryer brush to remove any residue from tank, heating elements, and side walls. The heating elements can be pivoted up again to clean the under side of the elements. **DO NOT** pivot the elements up when the fryer is on. Perform the daily cleaning procedure described in section 2.3.
- e. After cleaning is complete, shut machine down and drain the water into a suitable container. Rinse the tank with clean warm water, add 1/2 cup white vinegar to the rinse water.
- f. Drain the rinse water and refer the fryer with oil as described in section 2.1.

3.2 CHECKING AND REPLACING FUSES

To check the heating element fuses you will need a general purpose OHM meter or continuity tester. The control fuses are typically glass and can be checked visually. While checking the fuses can be performed by the user it is recommended that a qualified technician check the fuses for you. Perform the following to check the fuses.

WARNING

DANGER - HIGH VOLTAGE PRESENT

The fuses for the fryer's heating elements and controls are located inside the back enclosure of the fryer. Extreme care must be taken when opening the back cover of the fryer. **NEVER** remove the back cover of the fryer unless all power to the appliance has been disconnected.

WARNING

All power supplies must be disconnected before servicing the appliance. Some appliances have more than one power supply. Make sure they are **ALL** disconnected.

- a. To gain access to the main fuses either open the access cover on the back of the fryer or remove the fryer's back cover

NOTE

Only use new fuses that are the same as the fuse being replaced. To ensure that you are using the correct fuses, obtain the fuses from an authorized Pitco Frialator dealer.

- b. The six heating element fuses are mounted in a fuse holder. If necessary remove each of the fuses by gently pulling straight out on the fuse using your fingers or a fuse puller.

- c. Use the OHM Meter on a low resistance setting and check the fuses for continuity. The reading should be zero ohms (approximately) for a good fuse. If the reading is significantly above zero replace the fuse.
- d. The control fuses are also mounted in a screw type fuse holder. Remove the fuses from the holder and check them using an OHM meter. If the fuse is bad it will indicate an open. If the fuse is good it will have a very low resistance.
- e. After you have checked the fuses, replace any fuses that were bad. Ensure that all fuses have been installed and replace the cover on the back of the fryer.
- f. If you still have problems with your fryer call a qualified service technician.

3.3 TESTING CONTACTORS AND RELAYS

Contactors and relays use a control voltage to energize an electromagnet and close a set of contacts. The control voltage is applied to a solenoid-type coil. When measuring a coil's resistance ensure that you have disconnected it from the fryer's electrical system. This will ensure that you are measuring the coil's resistance and not a portion of the fryer's wiring. When measured with an OHM meter these coils should have low resistance, less than 100 ohms. Measure each of the contactors that are suspect. If any relay or contactor coil indicates an open circuit or high amount of resistance replace the relay or contactor.

3.4 TESTING HEATING ELEMENTS

To check a heating elements first place the OFF-ON-START switch in OFF. Check the elements by performing the following:

- a. The terminal block that connects the heating elements to the fryer is located behind the large rear access panel. Move the fryer out and remove the access panel.
- b. Using an OHM meter check continuity from one end of the element to the other. The reading should be very low (a few ohms) as shown below.

208V Elements = 12.4 ohms

240V Elements = 16.5 ohms

- c. If the element indicates an open circuit, replace the element.
- d. Next check from the hot side of the element to ground. It should be infinite, if it is not replace the element.

.5 TESTING THE TEMPERATURE SETTING POTENTIOMETERS

The temperature setting potentiometer is a variable resistor. To test the potentiometer ensure that the OFF-ON-START switch is OFF and perform the following:

- a. For thermostat knobs mounted on the front of the fryer, remove the front bezel to gain access to the back of the potentiometer.
- b. Disconnect P10 from J10.
- c. Connect an ohm-meter to pin 3 (yellow wire) and pin 1 (violet wire) of plug P10. Rotate the temperature control knob. The resistance should vary from 0 to 900 ohms.
- d. Connect the ohm-meter between pin 3 (yellow wire) and pin 5 (orange wire) of plug P10. Rotate the temperature control knob. The resistance should again vary from 0 to 900 ohms. If the resistance is not within the ranges specified replace the temperature setting potentiometer.

.6 TESTING THE TEMPERATURE CONTROL MODULE

The temperature control module receives 24 VAC when the OFF-ON-START switch is ON. To test the temperature control module perform the following:

- a. The temperature control module is located behind the front bezel. Remove the two screws that hold the bezel in place and move out of the way.
- b. Place the OFF-ON-START switch in START and release. The switch will spring return to ON. Place the Melt switch in OFF. This will apply 24 VAC to pin 1 (black wire) with pin 3 as the common (white wire) of the temperature control module.
- c. Set the temperature setting potentiometer to a temperature above the shortening's current temperature. This will cause the temperature control module to close and pass 24V to pin 12 (gray wire) of the control module.
- d. Check the temperature probe as described in section 3.7.
- e. If the temperature probe test passes and there is not 24V present on pin 12 of the control module, and the potentiometer test in section 3.5 passes, replace the temperature control module.

3.7 TESTING THE TEMPERATURE PROBE

WARNING

All power supplies must be disconnected before servicing the appliance. Some appliances have more than one power supply. Make sure they are ALL disconnected.

The temperature probe is a special type of resistor called a thermistor. Check the temperature probe by performing the following:

- a. Gain access to the temperature probe connection by removing the front panel. Disconnect P10 and check the resistance of the probe at pins 2 & 4 of P10.
- b. Place the OFF-ON-START switch in OFF. Use an ohm-meter to measure the resistance across the probe. It should be about 100K ohms at room temperature (72°F, 22°C). If the probe indicates an open or more than 200 ohms difference from 100K ohms, replace the probe.
- c. Re-install the probe wires and turn on the fryer. Start the fryer and raise the shortening temperature to normal cooking temperature, approximately 350°F.
- d. Unplug P10, the temperature probe, and repeat the test. It should read about 923.8 ohms \pm 10 ohms. If the resistance is different by more than 10 ohms replace the temperature probe.

3.8 TESTING THE HEATING ELEMENT INTERLOCK SWITCH

The heating elements are protected from accidental over heating by an interlock switch. The interlock switch is mounted inside the heating element pivot box. The switch is located on the right side (opposite the High Limit switch) of the heating element pivot box.

- a. This test requires that you gain access to the back of the interlock switch. Remove the four screws from the small access plate on the top, right of the pivot box. Gently move the wiring harness to the side to expose the wiring terminal of the interlock switch.
- b. Connect an ohm-meter across the switch terminals to measure the resistance across the limit switch connections.
- c. When the elements are down in the tank the interlock switch is closed and the resistance across the switch will be zero.
- d. Lift the element rack up while continuing to measure the resistance across the switch. The rack only needs to be lifted a short distance to open the switch. A click should be heard when the switch opens. The resistance will go up significantly when the switch opens. The resistance will not be infinite unless the switch wires are disconnected. If there is any doubt about the resistance, remove the wires and check the resistance. With the wires removed the resistance will be infinite.

3.9 SERVICE

This chapter provides the qualified technician with the replacement and troubleshooting procedures necessary to service the Pitco fryer.

3.9.1 Replacement Procedures

These procedures are provided to the qualified technician as a guide to removal and replacement of various fryer components. If a test is required to verify component operation after installation, it will be referenced.

WARNING

To prevent burns, always ensure the fryer is completely COOLED down before working on the fryer.

WARNING

All power supplies must be disconnected before servicing or cleaning the appliance. Some appliances have more than one power supply. Make sure they are ALL disconnected.

3.9.1.1 Heating Element Removal and Replacement

Replacing a heating element is a complex and time consuming procedure. Ensure that you have tested the heating elements to determine that the heating element is bad.

- a. Move the fryer out to gain access to the rear panel. Remove the rear access panel.
- b. The terminal block for the heating elements is located behind the access plate. Tag the connections with wire marker for easy reinstallation and remove the wires. The temperature probe wires are not connected through the terminal board. To disconnect the temperature probe, remove the small access plate on top of the pivot box (plate opposite High Limit switch). The connector for the probe is inside the pivot box. Disconnect the probe at this connector and gently pull the wire out of the pivot box.
- c. Disconnect the spring assembly from the pivot box by raising the elements and holding them in place with a board across the tank. Do not use the element bracket to hold the elements up.
- d. Next remove the pivot box assembly by removing the screws that attach the pivot box hinges to the fryer. The heating elements will need to be raised to gain access to the screw heads. Support the heating element assembly before removing the screws. Removing the hinge screws frees the heating elements assembly from the fryer.

- e. Once free of the fryer, set the heating element assembly aside. Remove the access plate on the back of the pivot box to gain access to the heating element connectors. Disconnect the wire for the defective heating element.
- f. Loosen the nuts that attach the heating element to the pivot box. Slide the heating element out of the pivot box.
- g. Install the new heating element by reversing this procedure.

3.10 TROUBLESHOOTING

This section is provided to aid you in the event of fryer or filter troubles. If these troubleshooting procedures do not correct your problem contact a qualified technician or the factory. The troubleshooting procedures are in a flowchart format.

3.10.1 Fryer Troubleshooting

Refer to this section to correct common problems that may be encountered in equipment operation.

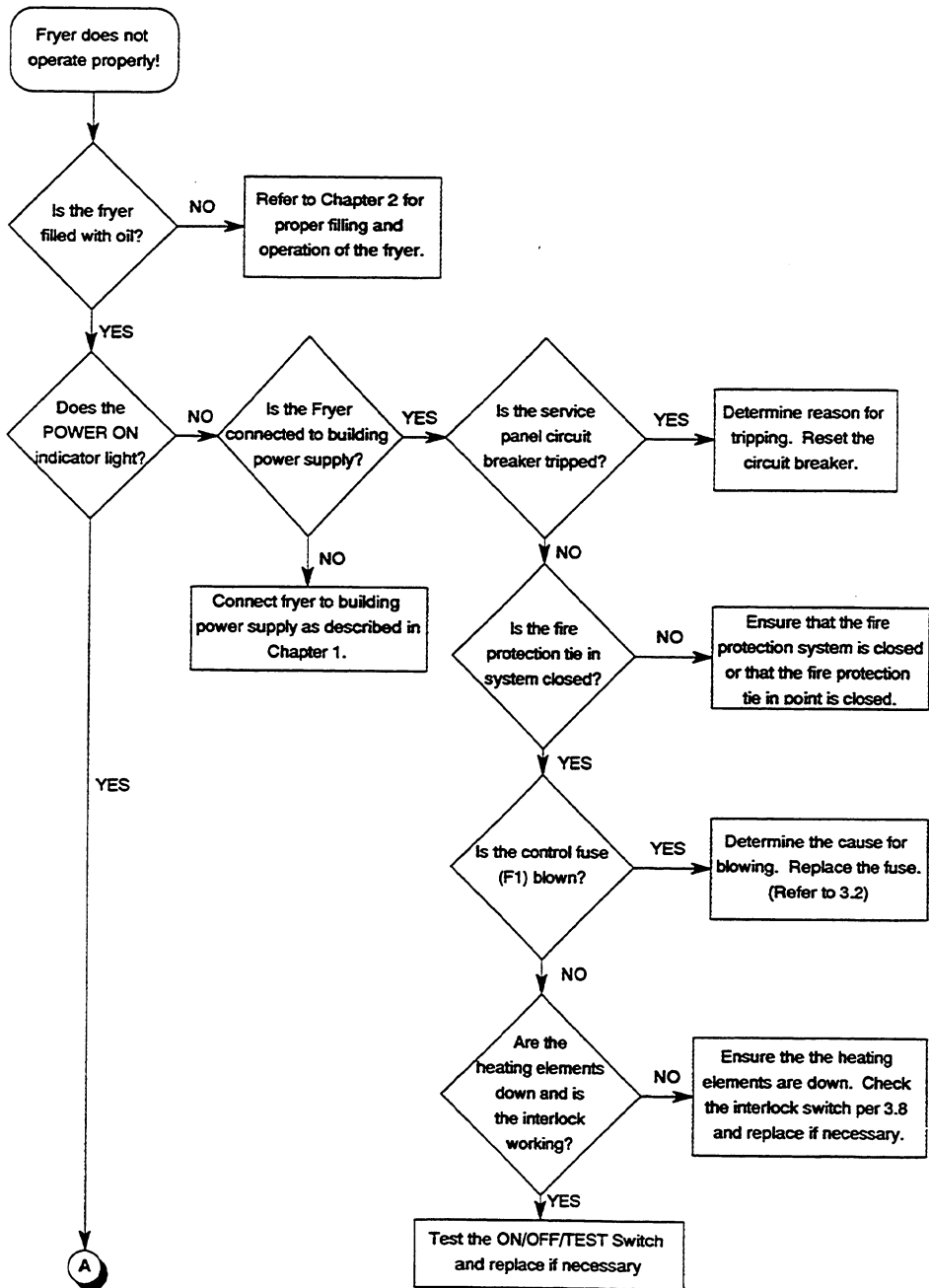

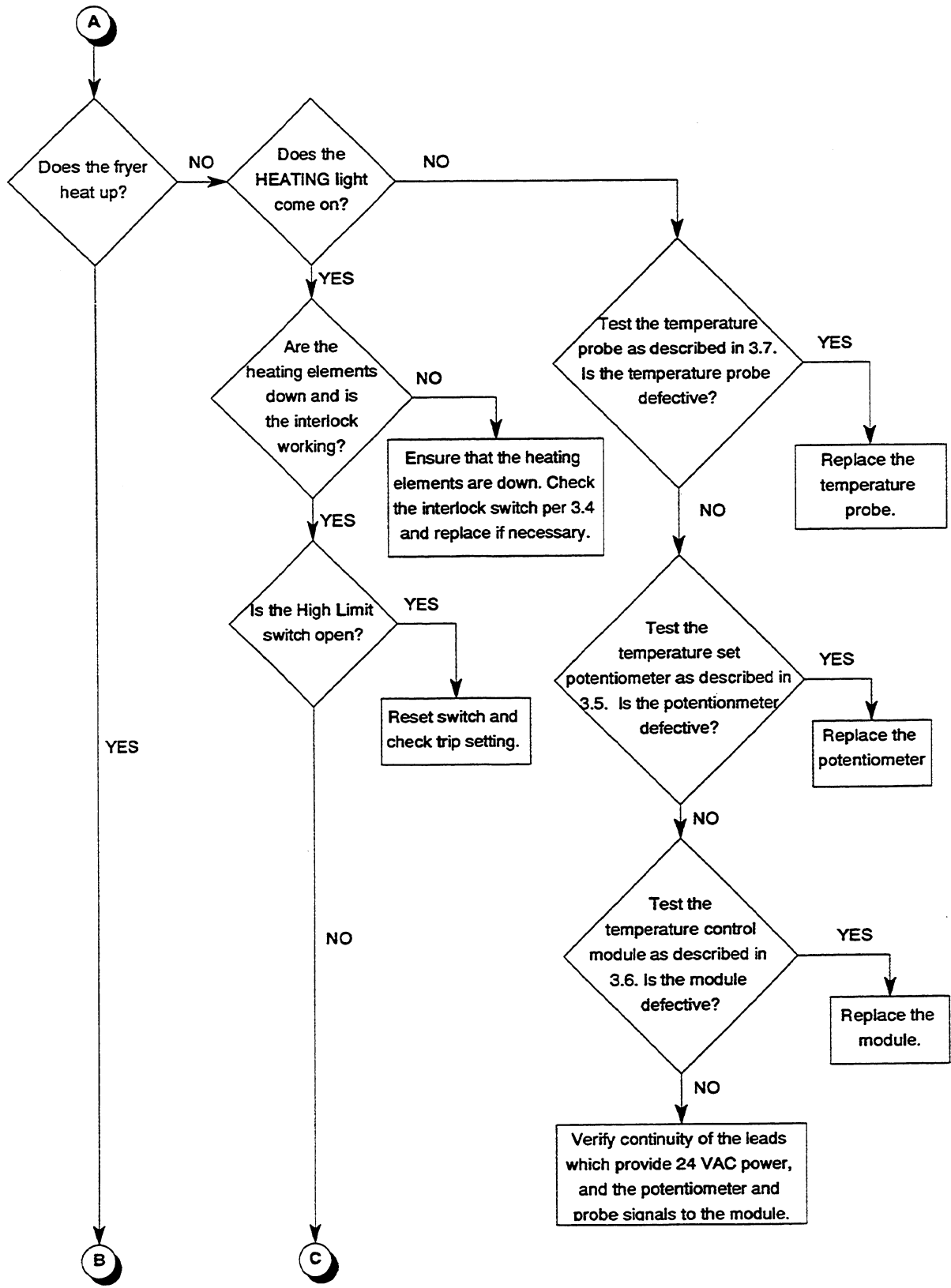

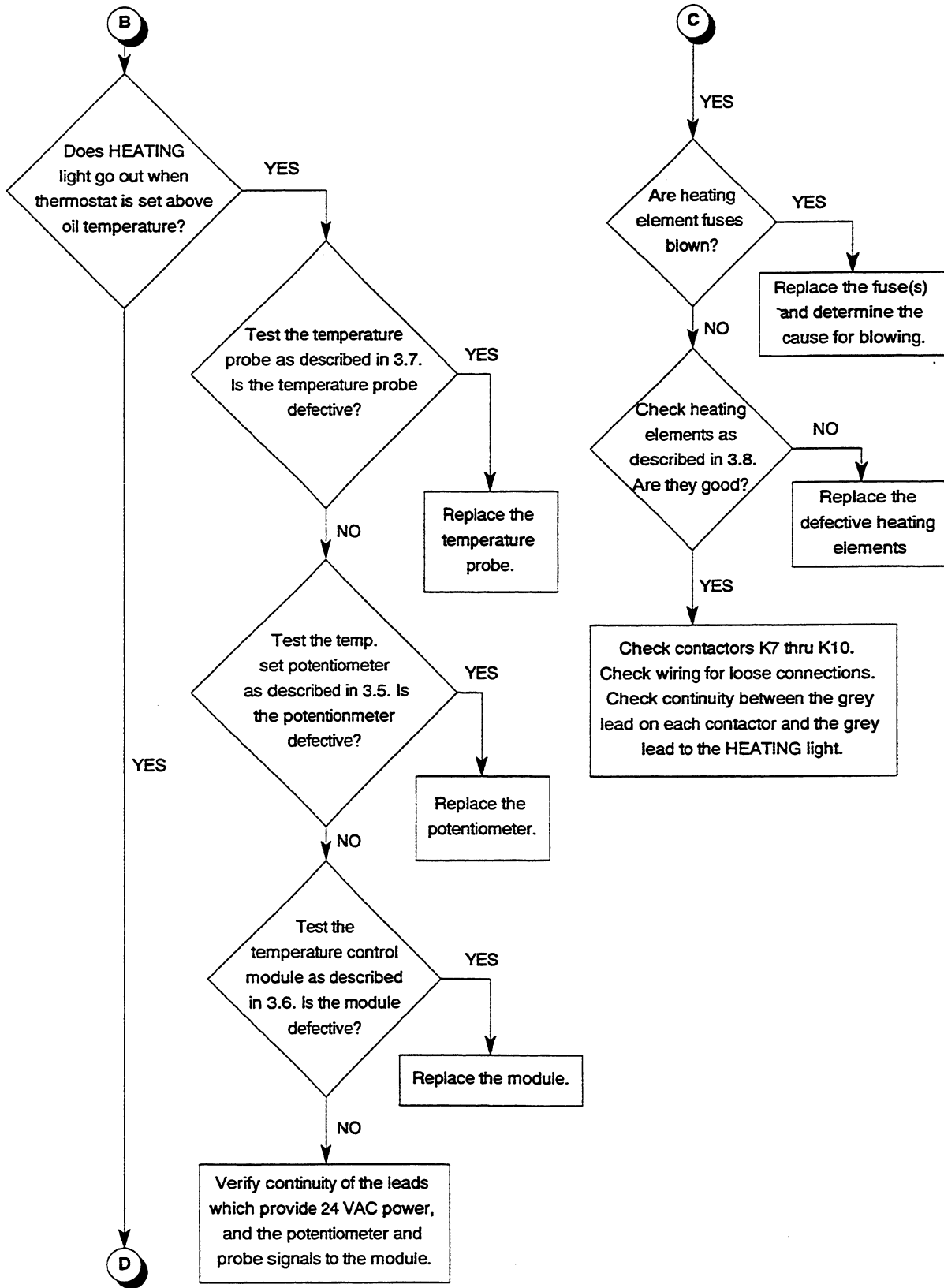

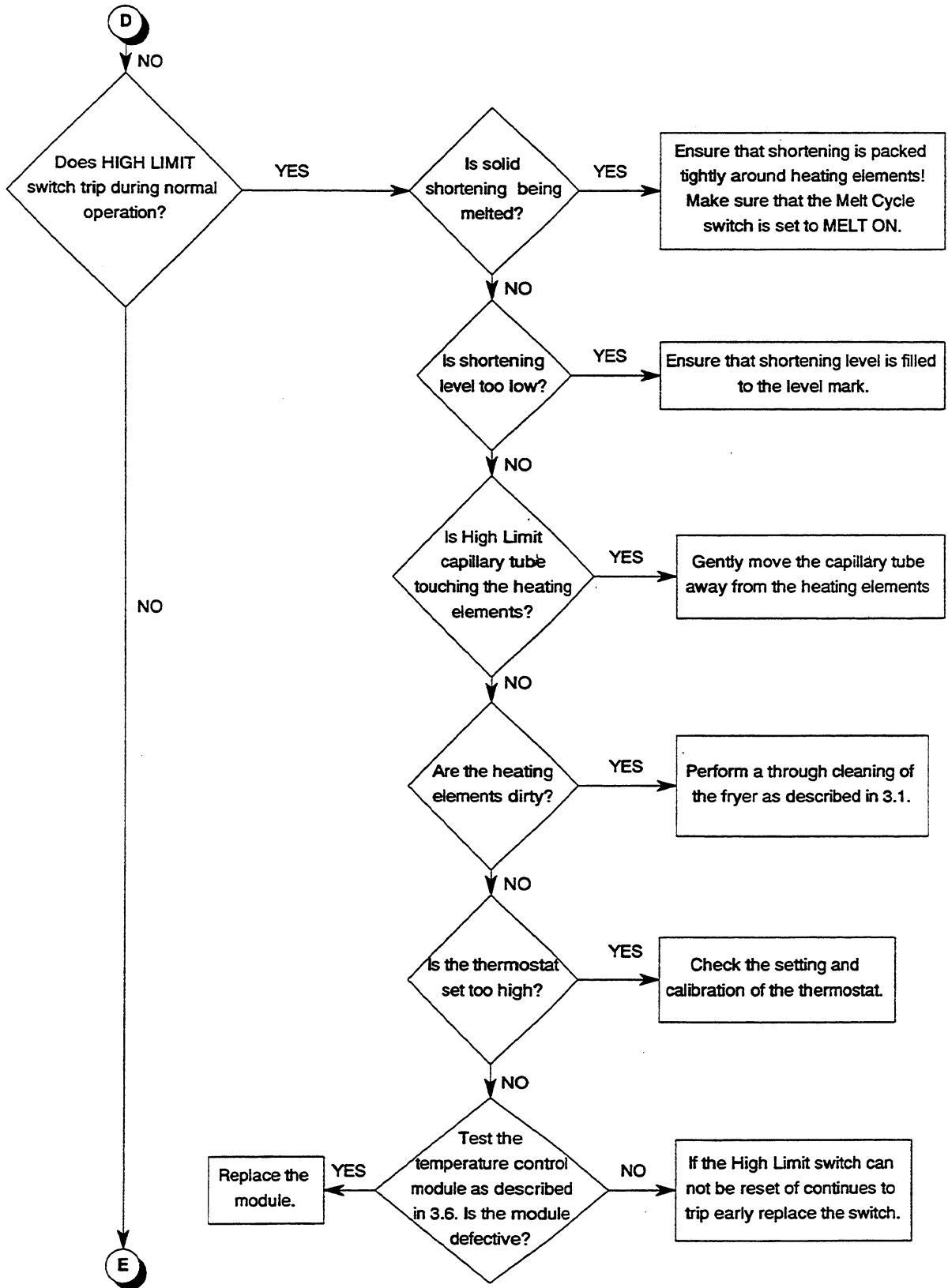

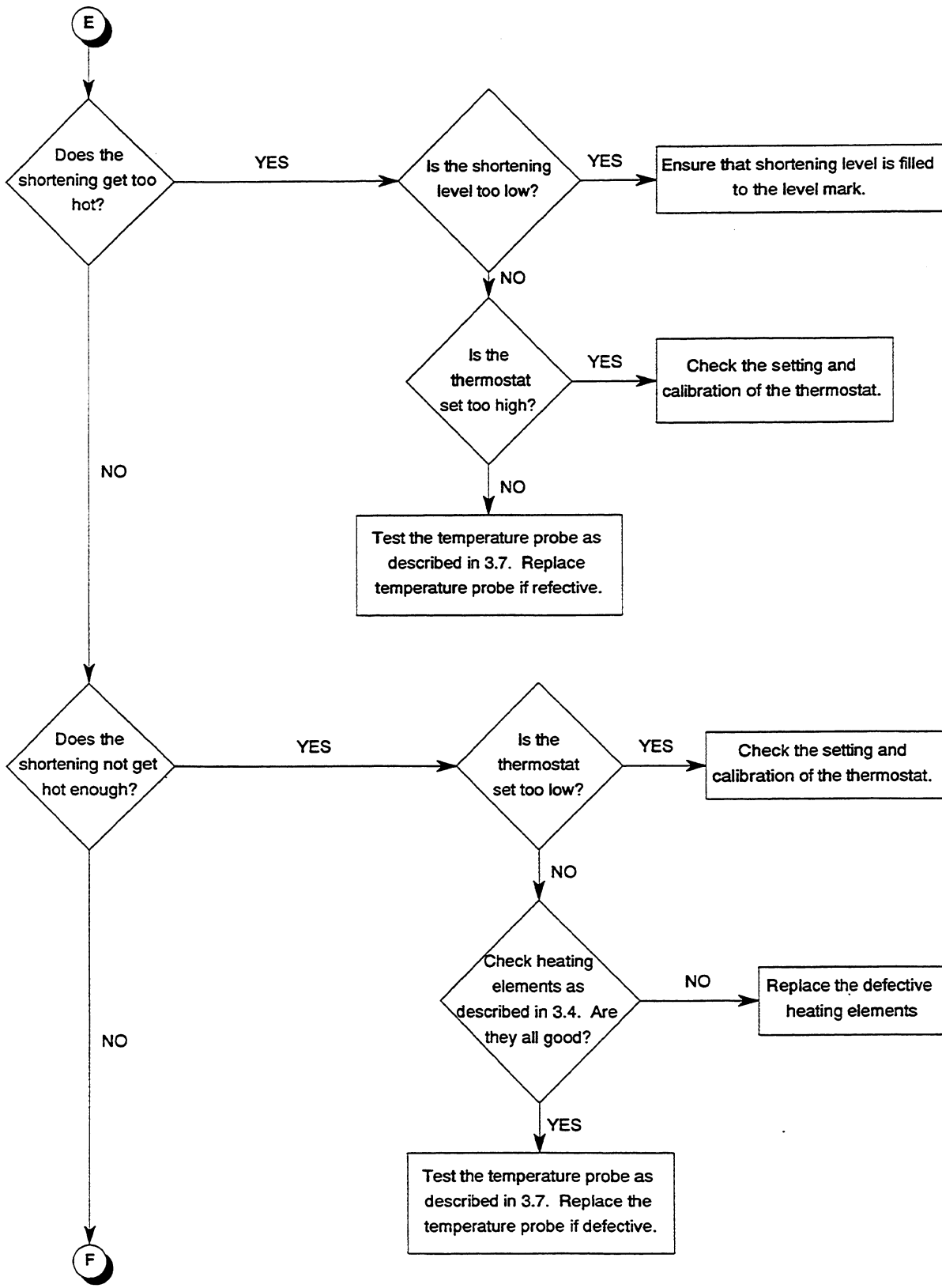

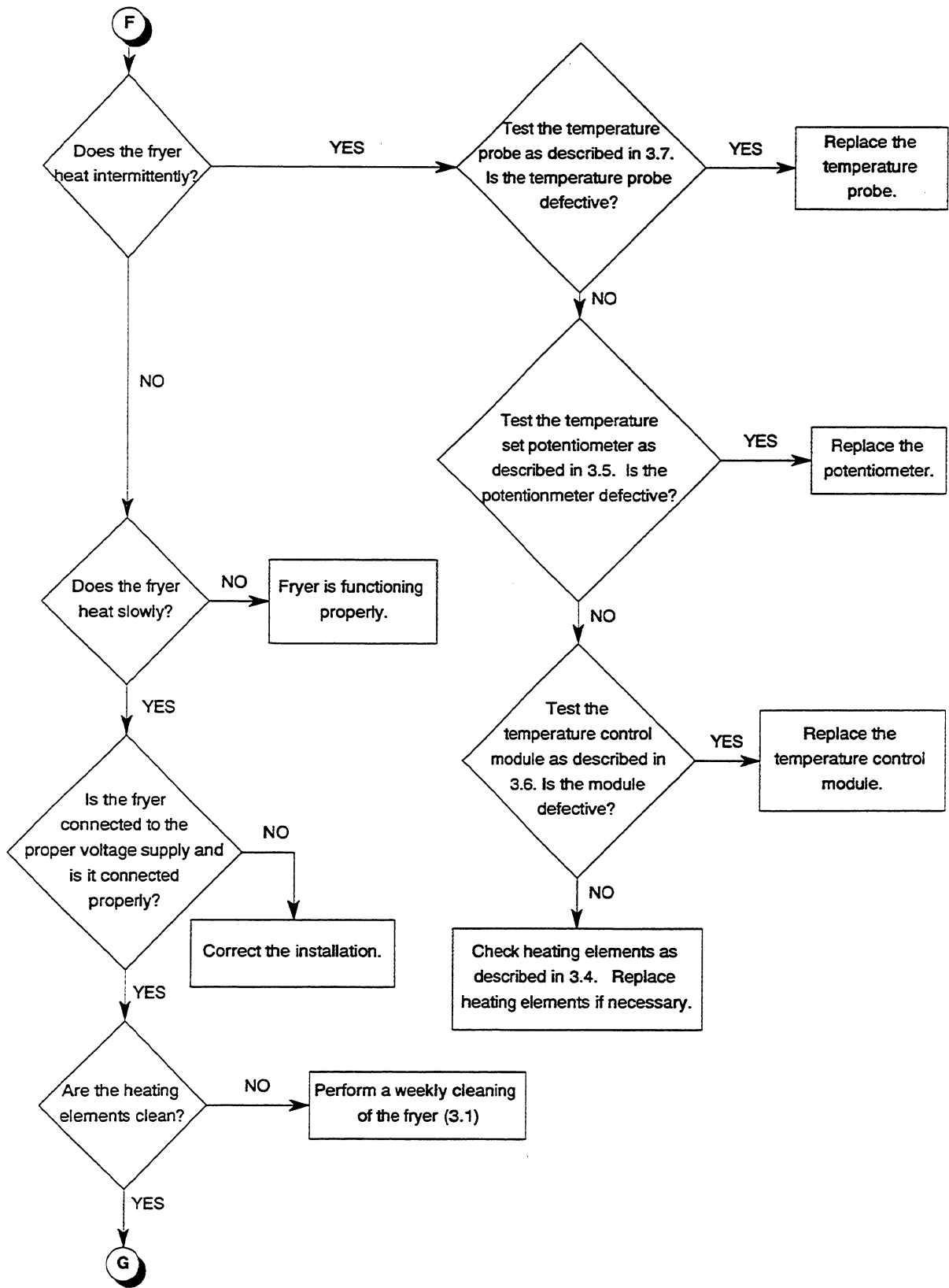

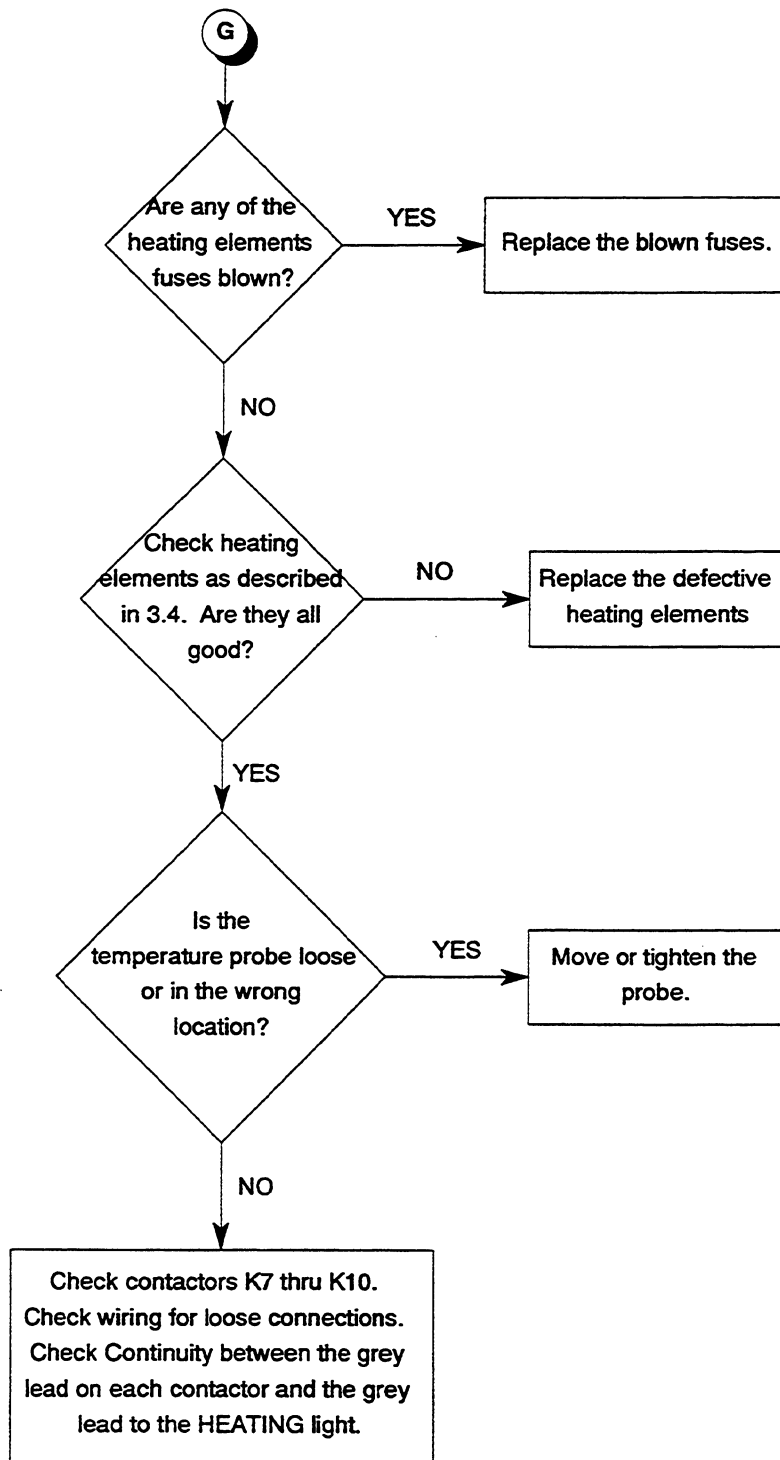

Chapter 4: Parts

This chapter contains listings of the components used in the different models of universal fryer. These components are listed in two places, with the illustration and in ordered listings. The illustrations in this chapter are provided to show relative location of component of the fryer. With each illustration there is a table of components in numerical order. The illustration has numbered lines pointing to components which are listed in the table.

At the end of this chapter there are alphabetical and numerical listings of all parts used in the fryer. The alphabetical part list is arranged in alphabetical order according to the part name. Each part name also has the Pitco Frialator part number. The numerical list is in Pitco Frialator part number order. A brief description of each component is provided for each part. The third column of the part list identifies which model fryer or filter unit the part is applicable to.

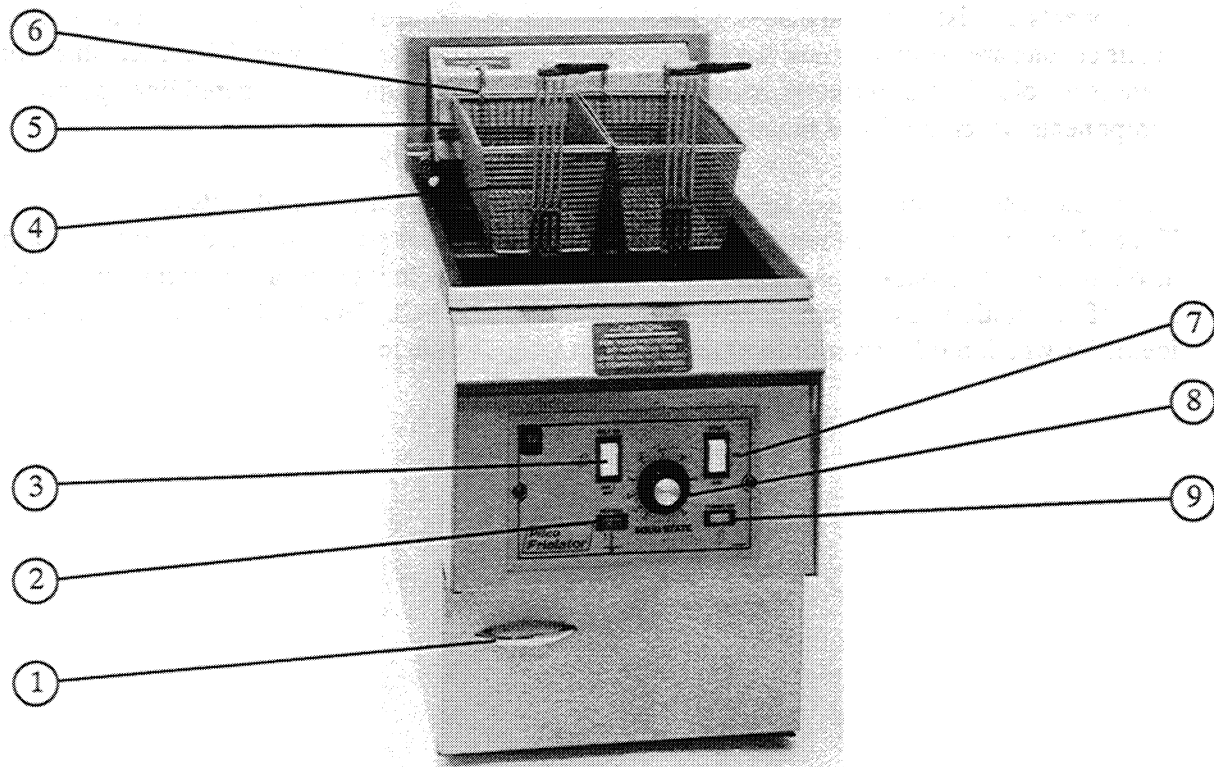

Index Number	Description	Index Number	Description
1	Door Handle		
2	HEATING Light		
3	Melt Switch		
4	Basket		
5	Basket Hanger		
6	High Limit Switch		
7	OFF-ON-START Switch		
8	Thermostat Knob		
9	Power ON Light		

Figure 4-1 Outside View

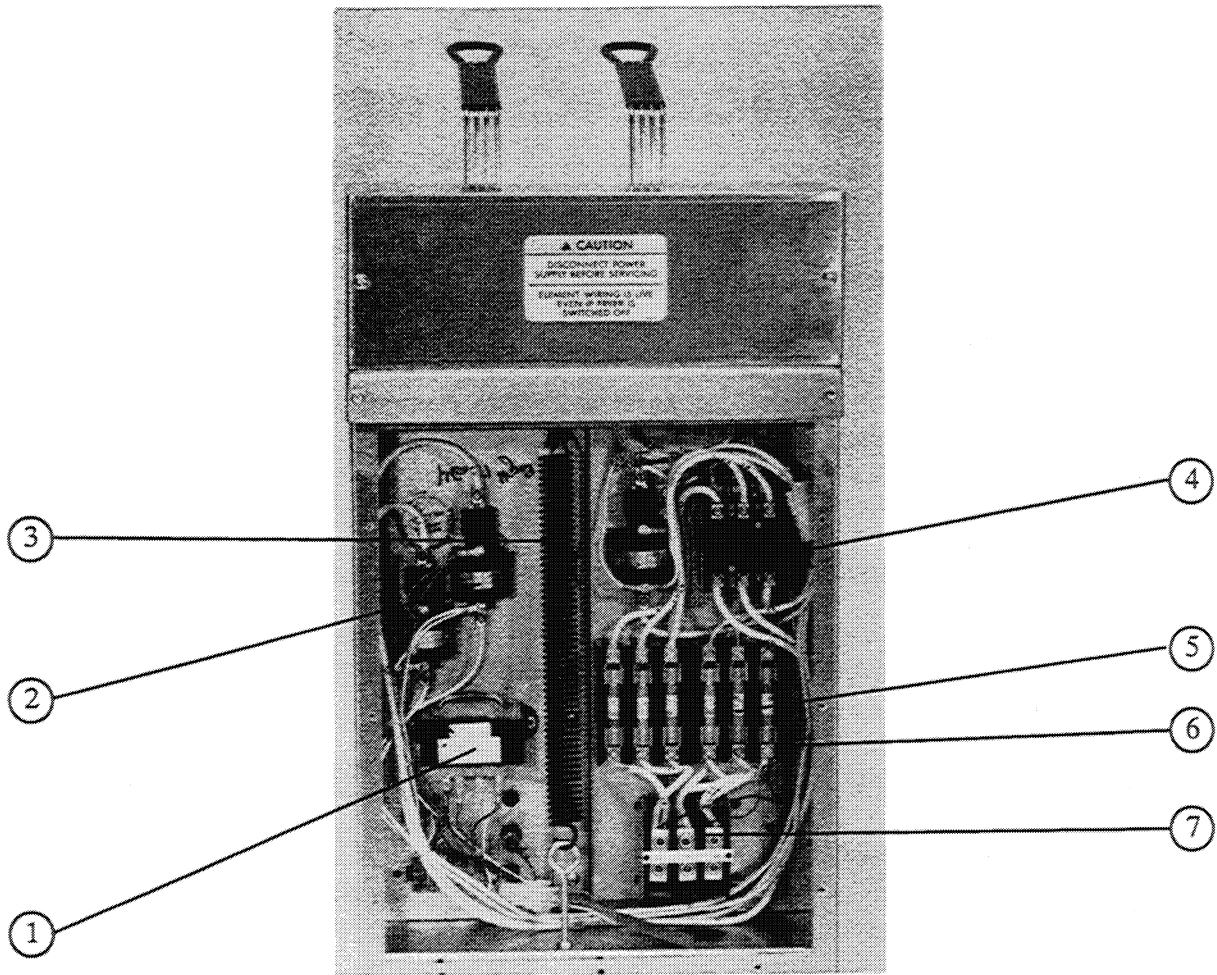

Index Number	Description	Index Number	Description
1	Transformer		
2	Mercury Contactor		
3	Heating Element Spring		
4	Contactor		
5	Fuses (6)		
6	Fuse Block		
7	Terminal Block		

Figure 4-2 Fryer Electrical Components (Back of Fryer)

ALPHABETICAL PART LIST

Part Description	Pitco Frialator Part Number
BASKET HANGER, STAINLESS STEEL	A1100404
CHANNEL STRIP #12	A1900106
CLEAN OUT ROD	A3301001
CONNECTOR, JACK, 12 SOCKET MOLEX	PP10209
CONTACTOR, DEFINITE PURPOSE 40AMP 24 VAC 3PST-NO	PP10560
CONTACTOR, MERCURY-40AMP 24 VAC SPST-NO	PP10553
COUNTER BALANCE BEARING ASSEMBLY	B7361703
COUNTER BALANCE HINGE BRACKET	B7361802
COVER SCREWS	P0101200
DOOR, UNIVERSAL, STAINLESS STEEL OUTSIDE	B2301203
DOOR HANDLE	P6071516
DOOR MAGNET	P6071300
DRAIN OUTLET NIPPLE, 1"	A2502501
DRAIN VALVE, 1" STANDARD	P6071769
ELEMENT BOTTOM BAR	A2801801-1
ELEMENT HOUSING BOX COVER	A2603204
ELEMENT RACK	B2800703-1
ELEMENT WIRES	SPECIAL ORDER
FAT CONTAINER	B7404012
FUSE, 40 AMP	P5045701
FUSE HOLDER	P5045792
GROUND CLAMP	P5045241
HEATING ELEMENT, 208V	P5046923
HEATING ELEMENT, 240V	P5046924
HEATING ELEMENT, 480V	P5046951
HIGH LIMIT BULB CLAMP	B7370402
HIGH LIMIT CAPILLARY CLAMP	A1400902
HIGH LIMIT COVER	B7370101-3
HIGH LIMIT SWITCH	P5047216
HINGE, DOOR-BOTTOM LH	B7230301
HINGE, DOOR-BOTTOM, RH	B7230302
HINGE, DOOR-TOP, LH	B7230201
HINGE, DOOR-TOP, RH	B7230202
INTERLOCK SWITCH	P5047170
INTERLOCK SWITCH COVER	A2601502
LAMP, 24 VAC CLEAR RECTANGULAR	P5045043
LAMP, 24 VAC AMBER RECTANGULAR	P5045044
LOCK ARM TIP	P5045161
POTENTIOMETER 0-900 OHMS	P5046582
PROBE STANDOFF CLAMP	B7370403
SPRING, HEATING ELEMENT	P6071636
SQUARE BASKETS, REGULAR MESH	P6072123
SQUARE BASKETS, FINE MESH	P6072124

ALPHABETICAL PART LIST (Continued)

Part Description	Pitco Frialator Part Number
SWITCH , ROCKER, DPDT (OFF-ON-MON ON)	PP10559
SWITCH, ROCKER, (ON-ON)	PP10093
TERMINAL BLOCK (TB3)	P5047303
TEMP CONTROL MODULE G0-24VAC ON-4S OFF-26S	PP10562
THERMOSTAT KNOB	P6071270
THERMOSTAT PROBE	B6700602
TRANSFORMER 80VA 120/208/240 VAC TO 24 VAC	PP10429

NUMERICAL PART LIST

Pitco Frialator Part Number	Part Description
A1100404	BASKET HANGER, STAINLESS STEEL
A1400902	HIGH LIMIT CAPILLARY CLAMP
A1900106	CHANNEL STRIP #12
A2502503	DRAIN OUTLET NIPPLE, 1"
A2601502	INTERLOCK SWITCH COVER
A2603204	ELEMENT HOUSING BOX COVER
A2801801-1	ELEMENT BOTTOM BAR
A3301001	CLEAN OUT ROD
B2301203	DOOR, UNIVERSAL, STAINLESS STEEL OUTSIDE
B2800703-1	ELEMENT RACK
B7230201	HINGE, DOOR-TOP, LH
B7230202	HINGE, DOOR-TOP, RH
B7230301	HINGE, DOOR-BOTTOM LH
B7230302	HINGE, DOOR-BOTTOM, RH
B7361703	COUNTER BALANCE BEARING ASSEMBLY
B7361802	COUNTER BALANCE HINGE BRACKET
B7370101-3	HIGH LIMIT COVER
B7370402	HIGH LIMIT BULB CLAMP
B7370403	PROBE STANDOFF CLAMP
B7404012	FAT CONTAINER
P0101200	COVER SCREWS
P5045043	LAMP, 24 VAC WHITE RECTANGULAR
P5045044	LAMP, 24 VAC AMBER RECTANGULAR
P5045161	LOCK ARM TIP
P5045241	GROUND CLAMP
P5045701	FUSE, 40 AMP
P5045792	FUSE HOLDER
P5046582	POTENTIOMETER 0-900 OHMS
P5046923	HEATING ELEMENT, 208V
P5046929	HEATING ELEMENT, 240V
P5046951	HEATING ELEMENT, 480V
P5047170	INTERLOCK SWITCH,
P5047216	HIGH LIMIT SWITCH
P5047303	TERMINAL BLOCK (TB3)
P6071270	THERMOSTAT KNOB
P6071300	DOOR MAGNET
P6071516	DOOR HANDLE
P6071636	SPRING, HEATING ELEMENT
P6071769	DRAIN VALVE, 1" STANDARD
P6072123	SQUARE BASKETS, REGULAR MESH
P6072124	SQUARE BASKETS, FINE MESH
P6700602	THERMOSTAT PROBE
PP10209	CONNECTOR, JACK, 12 SOCKET MOLEX
PP10429	TRANSFORMER 80VA 120/208/240 VAC TO 24 VAC

NUMERICAL PART LIST (Continued)

Pitco Frialator Part Number	Part Description
PP10553 PP10559 PP10560 PP10562 SPECIAL ORDER	CONTACTOR, MERCURY-40AMP 24 VAC SPST-NO SWITCH , ROCKER, DPDT (OFF-ON-MON ON) CONTACTOR, DEFINITE PURPOSE 40AMP 24 VAC 3PST-NO TEMP CONTROL MODULE G0-24VAC ON-4S OFF-26S ELEMENT WIRES

Chapter 5: Schematics

Schematic Description	Schematic Number
SCHEMATIC, E12 - ALL OPTIONS	700084

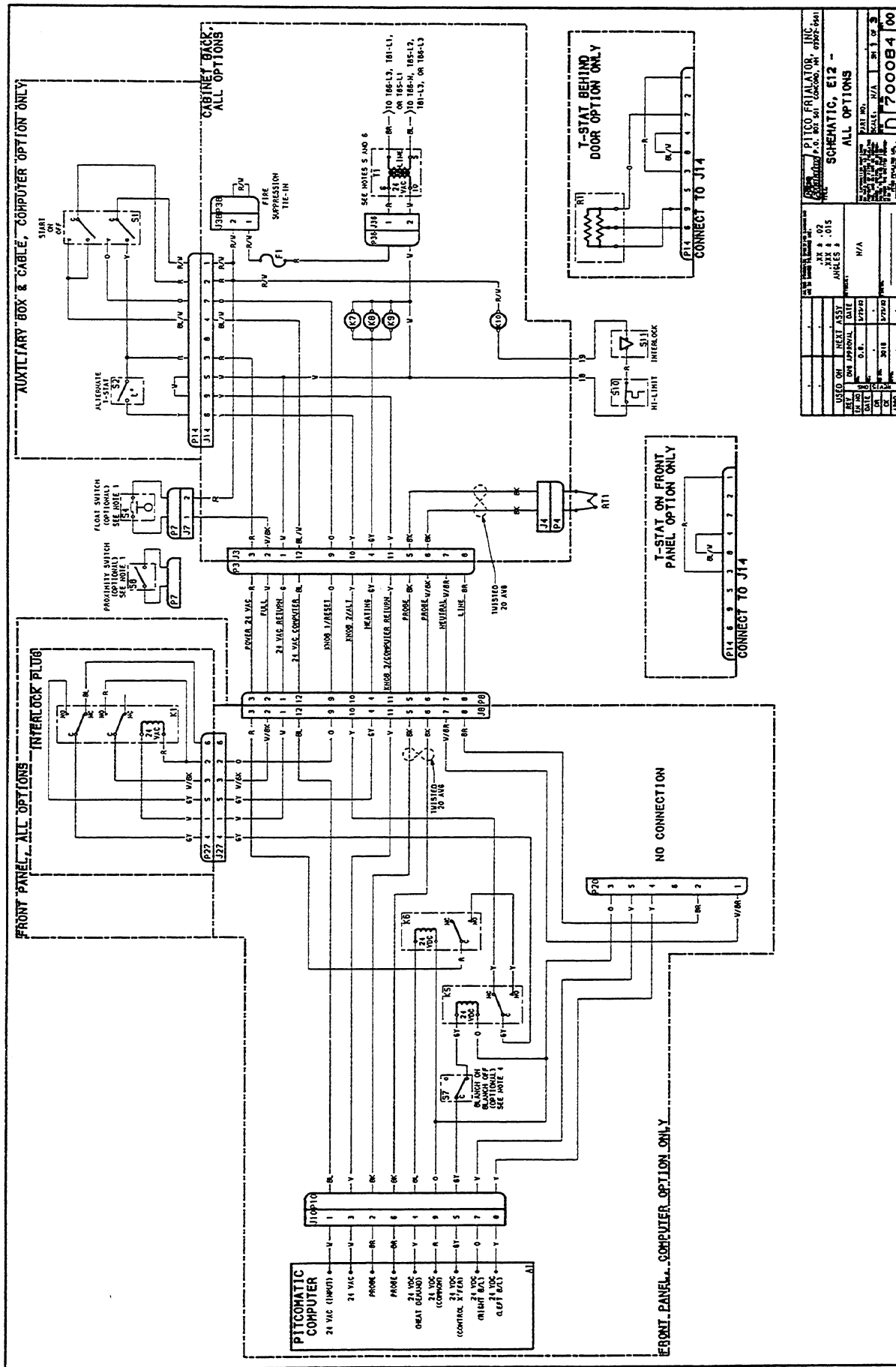

PITCO FRIGATOR, INC.		P.O. BOX 501		CONCORD, NH 03301	
SCHEMATIC, E12 - ALL OPTIONS					
REV.	DATE	BY	CHK'D	DATE	BY
01	08/18				
02					
03					
04					
05					
06					
07					
08					
09					
10					
11					
12					
13					
14					
15					
16					
17					
18					
19					
20					
21					
22					
23					
24					
25					
26					
27					
28					
29					
30					
31					
32					
33					
34					
35					
36					
37					
38					
39					
40					
41					
42					
43					
44					
45					
46					
47					
48					
49					
50					
51					
52					
53					
54					
55					
56					
57					
58					
59					
60					
61					
62					
63					
64					
65					
66					
67					
68					
69					
70					
71					
72					
73					
74					
75					
76					
77					
78					
79					
80					
81					
82					
83					
84					
85					
86					
87					
88					
89					
90					
91					
92					
93					
94					
95					
96					
97					
98					
99					
100					

FRONT PANEL, T-STAT BEHIND DOOR OPTION ONLY

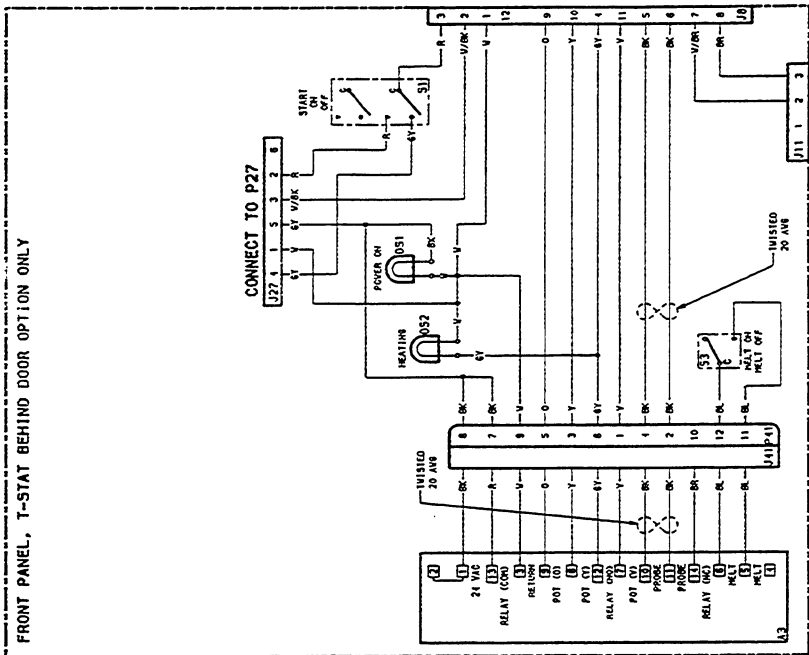

CONNECT TO P8

NO CONNECTION

FRONT PANEL, T-STAT ON FRONT PANEL OPTION ONLY

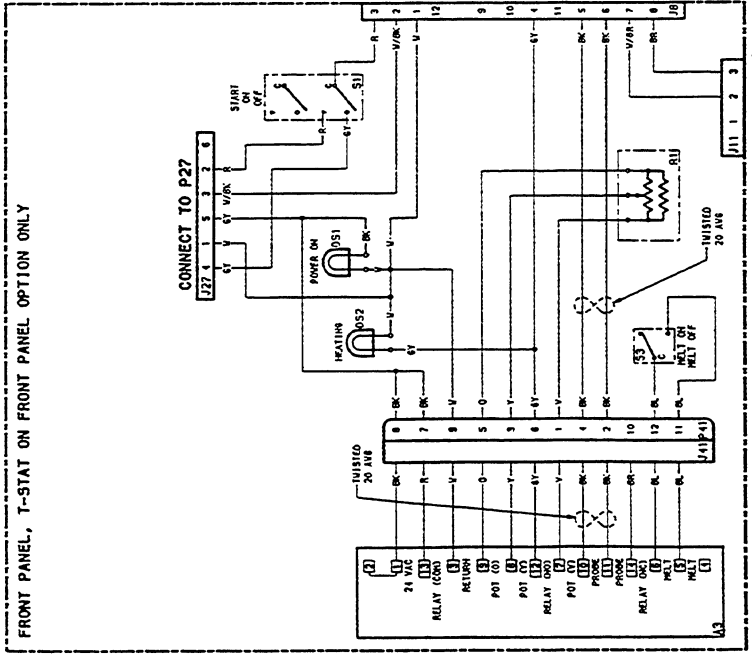

CONNECT TO P8

NO CONNECTION

NOTES:

1. THE BROWN WIRE TO J7 POSITION 2 IS CONNECTED DIRECTLY TO J3 POSITION 2 INSTEAD WHEN EITHER THE FLOAT SWITCH 34 NOR THE DRAIN SWITCH 58 IS AN OPTION.
2. AT FUSE F1 USE FUSE HOLDER PS045784.
3. UNLESS OTHERWISE SPECIFIED ALL COLORED WIRES ARE 18 AWG.
4. ALL T-STAT CONDUITORS ARE NUMBERED.
5. A CONTINUOUS GREY WIRE IS CONNECTED BETWEEN P10 POSITION 5 AND K5 WHEN THE BLANCH SWITCH 37 IS NOT AN OPTION.
6. FOR 200, 208, OR 346/240 VAC UNITS, CONNECT BROWN LEAD FROM T1 TO P10 POSITION 2 ON J11.
7. FOR 220, 240, 480, 380/270 OR 415/240 VAC UNITS, CONNECT BROWN LEAD FROM T1, T85, OR T86 TO PIN 1 ON T1.
8. FOR 480 VAC UNITS, T1 IS PITCO P/N PP10428. ALL OTHERS USE PP10429.
9. UNITS WITH DUAL POWER SUPPLY, T1 IS PITCO P/N PP10429. ADD TERMINAL BLOCK (4 POST BARRIER, PITCO P/N PS045282) TO CABINET BACK. USE BROWN LEAD TO CONNECT T1-3 TO TERMINAL 1 ON THE TERMINAL BLOCK. USE BLUE LEAD TO CONNECT T1-5 TO TERMINAL 2 ON THE TERMINAL BLOCK. T1 IS NOT CONNECTED TO T81, T85, OR T86.

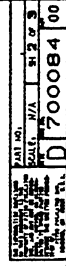

E12 POWER WIRING (INTERNATIONAL APPLICATIONS AND 480 VAC 3 PHASE NORTH AMERICAN APPLICATIONS)

TABLE 2

VOLTAGE	MODEL E12	HRI-HR3
220	LINE/AMPS	P506924
	SINGLE PHASE	L1-10.0 AMPS L2-10.0 AMPS
	2 WIRE & GND	3.0KW/ELEMENT
270	LINE/AMPS	P506924
	3 PHASE	L1-23.2 AMPS L2-23.2 AMPS L3-23.2 AMPS
	3 WIRE & GND	3.0KW/ELEMENT (DELTA CONNECT)
380/230	LINE/AMPS	P506924
	3 PHASE	L1-13.3 AMPS L2-13.3 AMPS L3-13.3 AMPS
	3 WIRE & GND	3.0KW/ELEMENT (Y CONNECT)
480	LINE/AMPS	P506924
	3 PHASE	L1-14.6 AMPS L2-14.6 AMPS L3-14.6 AMPS
	3 WIRE & GND	3.5KW/ELEMENT (Y CONNECT)
200	LINE/AMPS	P506923
	SINGLE PHASE	L1-16.1 AMPS L2-16.1 AMPS L3-16.1 AMPS
	2 WIRE & GND	3.3KW/ELEMENT (DELTA CONNECT)
200	LINE/AMPS	P506851
	SINGLE PHASE	L1-12.6 AMPS L2-12.6 AMPS L3-12.6 AMPS
	2 WIRE & GND	3.5KW/ELEMENT (DELTA CONNECT)

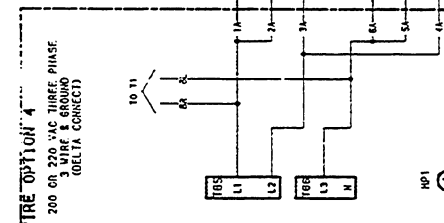
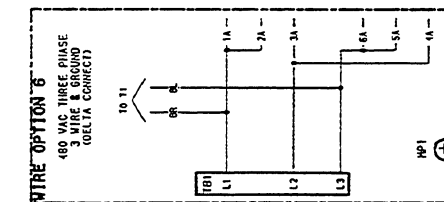
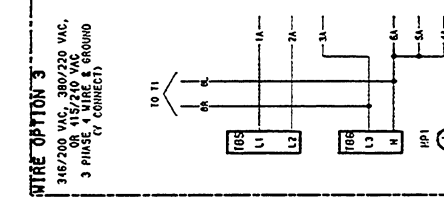
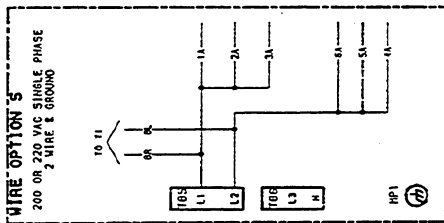
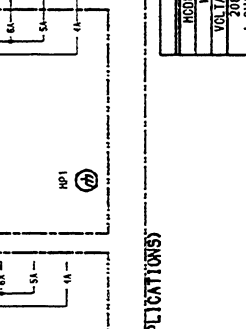
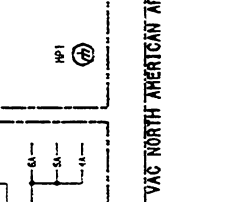
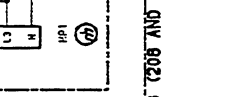
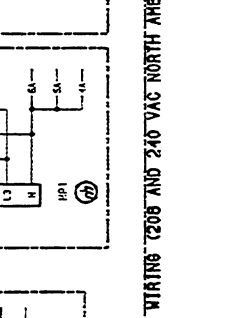

TABLE 1

MODEL E12 - TUBULAR ELEMENTS	HRI-HR3
10.5 KV, 3.5 KW/ELEMENT	P506923
1 PHASE	L1-50.5 AMPS
2 WIRE & GND	L3-50.5 AMPS
1 PHASE	L1-43.8 AMPS
2 WIRE & GND	L3-43.8 AMPS
3 PHASE	L1-29.2 AMPS L2-29.2 AMPS L3-29.2 AMPS
3 WIRE & GND	L1-25.3 AMPS L2-25.3 AMPS L3-25.3 AMPS



PARTS LIST

D81	P506923	AMP REGULATOR - CLEAR 24 VAC
D82	P506924	AMP REGULATOR - AMBER 24 VAC
P1	P10158	RELAY - 120/208/240V TO 24V
R1	P501438	REAR BOVA-380V/40V/40V TO 24V
T1	P501438	BOOSE THERMISTOR - 100K
T2	P501301	TEMP BLOCK 3 POS - ENHANCE
T3	P501303	TEMP BLOCK 3 POS - ENHANCE
S1	P501210	SWITCH, INTERLOCK
S2	P501232	SWITCH, HI TEMPERATURE LIMIT
S3	P501169	SWITCH, PROXIMITY SENSOR (OVI ONLY)
S4	P501237	SWITCH, FOLLO (OPTI SW) (ON/OFF)
S5	P501033	SWITCH, ROCKER (SPOT)
S6	P501359	SWITCH, 1-STATE ELECTRIC (ALTERNATE)
S7	P501355	SWITCH, ROCKER (OPT W/KEY (0-1-1))
P14	P501560	CONNECTOR - PLUS-9 PIN MOLEX
P10	P501526	CONNECTOR - PLUS-8 PIN MOLEX
P10	P501523	CONNECTOR - PLUS-8 PIN MOLEX
P10	P501523	CONNECTOR - PLUS-12 PIN MOLEX
P10	P501524	LUS - GROUND #8-2 ANG.
K10	P101550	CONTACTOR, DEF PUMP-40AMP 24VAC 3PS1-10
E7-49	P101553	CONTACTOR, MERCURY-40AMP 24VAC SP51-10
E5-K6	P5016680	RELAY, 24VAC - SPOT
K1	P5016686	RELAY, 24 VAC - OPT 4/M16 TABS
R1	P5016582	POTENTIOMETER, 300K
J11	P101093	CONNECTOR, JACK-3 SKT MOLEX
J14	P5015818	CONNECTOR, JACK-8 SKT MOLEX
J2	P101205	CONNECTOR, JACK-8 SKT MOLEX
J10	P5015827	CONNECTOR, JACK-8 SKT
J4, J7, J38, J39	P5015819	CONNECTOR, JACK-2 SKT MOLEX
J3, J9, J41	P101203	CONNECTOR, JACK-12 SKT MOLEX
HRI-HR3	SEE ELEMENT, TUBULAR	
F81, F82	P5015792	FUSE BLOCK, 3 POS1
F4, F6, F9, F11	P5015701	FUSE, 40 AMP-500V BLOW
F1	P5015720	FUSE, 4 AMP-500V BLOW (GLASS)
A1	P5014856	CHPTR, AUTOMATIC BL-7 OH-45 OFF-265
A3	P5014855	CHPTR, AUTOMATIC BL-7 OH-45 OFF-265
A3	P101562	CONTROLLER, 60 - 24 VAC OH-45 OFF-265

McQUAY-NORRIS
 AIR CONDITIONING
 HEATING
 REFRIGERATION
 PART NO. 700084 00

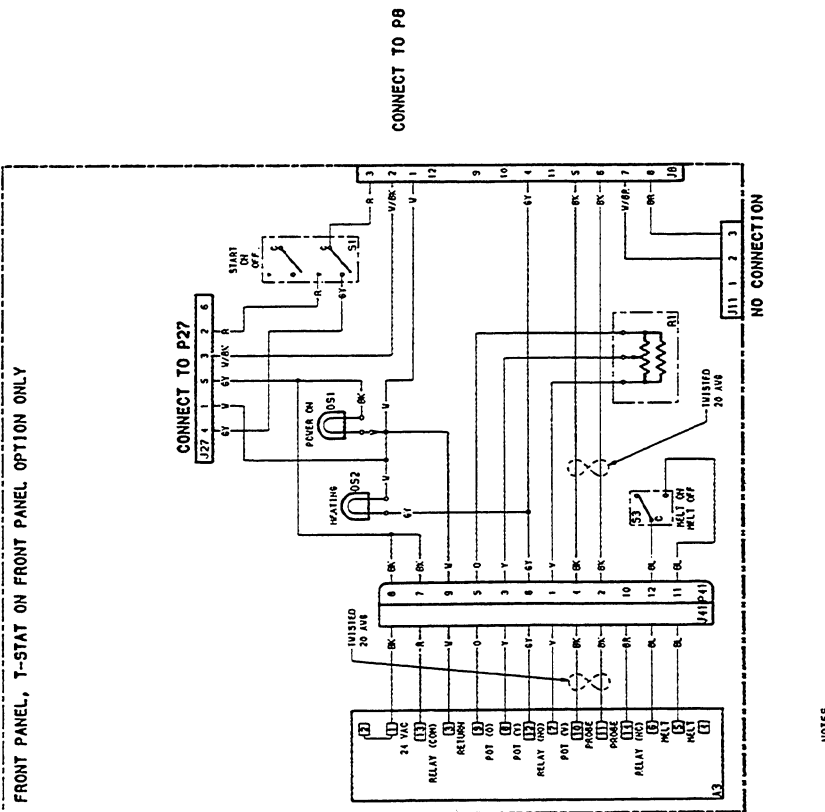
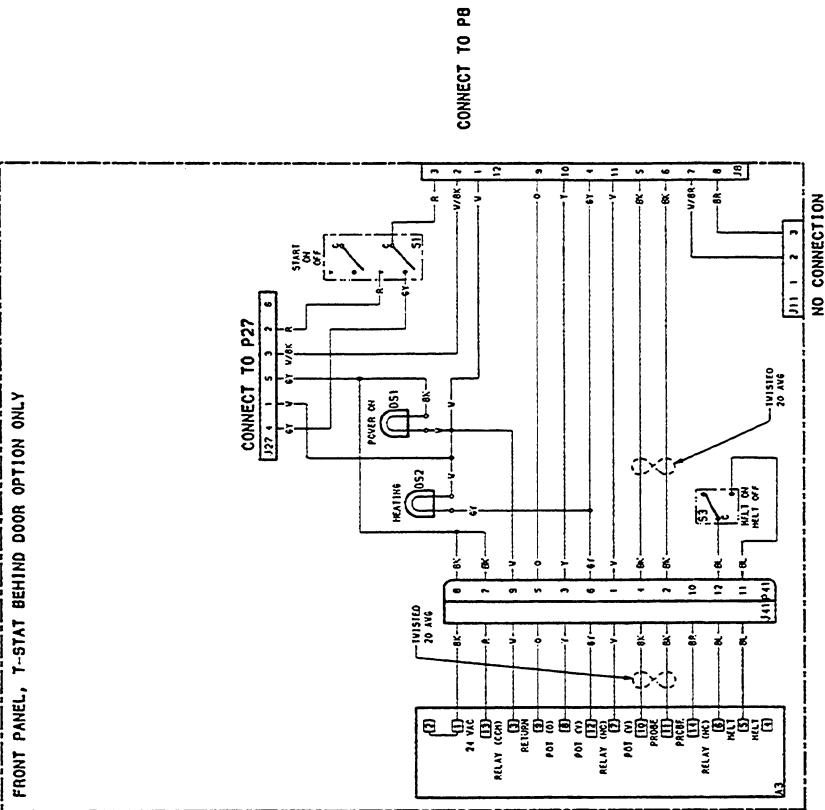

- NOTES:
1. THE BROWN WIRE TO J2 POSITION 2 IS CONNECTED DIRECTLY TO J3 POSITION 2 INSTEAD OF THROUGH THE FUSE HOLDER PS045794.
 2. AT FUSE F1 USE FUSE HOLDER PS045794.
 3. UNLESS OTHERWISE SPECIFIED ALL COLORED WIRES ARE 18 AWG.
 4. A CONTINUOUS GREY WIRE IS CONNECTED BETWEEN P10 POSITION 5 AND X5 WHEN THE BLANCH SWITCH 57 IS NOT AN OPTION.
 5. FOR 200, 208, OR 346/200 VAC UNITS, CONNECT BROWN LEAD FROM T81, T85, OR T85 TO PIN 2 ON T1.
 6. FOR 220, 240, 480, 380/220 OR 415/240 VAC UNITS, CONNECT BROWN LEAD FROM T81, T85, OR T85 TO PIN 1 ON T1.
 7. FOR 480 VAC UNITS, T1 IS P100 P/N PP10429. ALL OTHERS USE PP10429.
 8. UNITS WITH DUAL POWER SUPPLY (15-15-15) AND P/N PS045794 TO UNIT BACK, USE BROWN LEAD TO CONNECT P10 POSITION 5 TO TERMINAL 1 ON THE TERMINAL BLOCK. USE BLUE LEAD TO CONNECT T1-5 TO TERMINAL 2 ON THE TERMINAL BLOCK. T1 IS NOT CONNECTED TO T81, T85, OR T85.

ET2 POWER WIRING (INTERNATIONAL APPLICATIONS AND 480 VAC 3 PHASE NORTH AMERICAN APPLICATIONS)

TABLE 2

VOLTAG	MODEL ET2	LINE/AMPS	HR1-HR3
220	L1-40.0 AMPS	8.5KV	P5046924
SINGLE PHASE	L2-40.0 AMPS	3.0KV/ELEMENT	
2 WIRE & GND			
220	L1-23.2 AMPS	8.5KV	P5046924
3 PHASE	L2-23.2 AMPS	8.5KV	
3 PHASE	L3-23.2 AMPS	3.0KV/ELEMENT	
(DELTA CONNECT)			
380/220	L1-13.3 AMPS	10.5KV	P5046924
4 WIRE & GND	L2-13.3 AMPS	10.5KV	
(Y CONNECT)	L3-13.3 AMPS	3.0KV/ELEMENT	
480	L1-14.6 AMPS	10.5KV	P5046924
3 PHASE	L2-14.6 AMPS	10.5KV	
3 PHASE	L3-14.6 AMPS	3.5KV/ELEMENT	
(Y CONNECT)			
480	L1-48.4 AMPS	9.8KV	P5046923
SINGLE PHASE	L2-48.4 AMPS	9.8KV	
2 WIRE & GND		3.3KV/ELEMENT	
220	L1-28.0 AMPS	9.8KV	P5046923
3 PHASE	L2-28.0 AMPS	9.8KV	
3 PHASE	L3-28.0 AMPS	3.3KV/ELEMENT	
(DELTA CONNECT)			
348/220	L1-16.1 AMPS	9.8KV	P5046923
3 PHASE	L2-16.1 AMPS	9.8KV	
3 PHASE	L3-16.1 AMPS	3.3KV/ELEMENT	
(Y CONNECT)			
240	L1-12.6 AMPS	10.5KV	P5046924
3 WIRE & GND	L2-12.6 AMPS	10.5KV	
3 WIRE & GND	L3-12.6 AMPS	3.5KV/ELEMENT	
(DELTA CONNECT)			

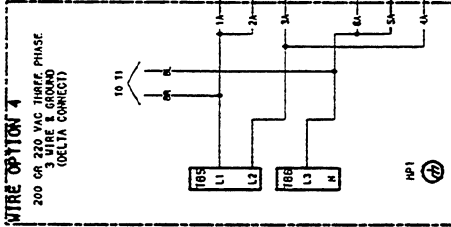
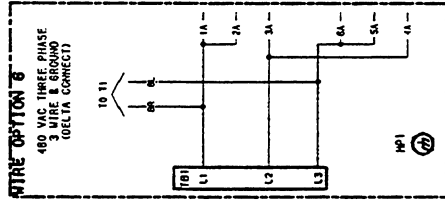
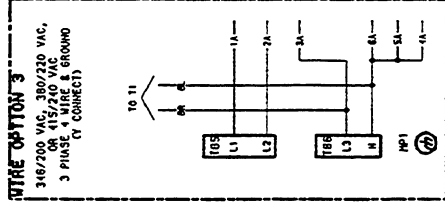
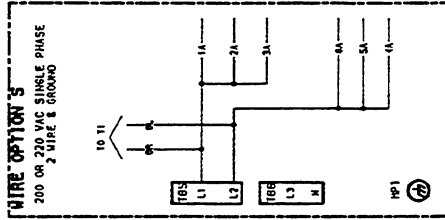

QST	DESCRIPTION	
P5045043	LAMP, RECTANGULAR - CLEAR, 24 VAC	
P5045044	LAMP, RECTANGULAR - RED, 24 VAC	
P210429	WTRB, 80VA-120V/208/240V TO 24V	
P210428	WTRB, 80VA-300/440/480V TO 24V	
A11	P5044883 PROBE, THERMISTOR - 100K	
HR1	P5047301 TERM BLOCK, 3 POST-ENTRANCE	
HR2	P5047302 TERM BLOCK, 2 POST-ENTRANCE	
HR3	P5047170 SWITCH, INTERLOCK	
S10	P5047215 SWITCH, HI TEMPERATURE LIMIT	
S8	P5047162 SWITCH, PROXIMITY SENSOR (OVI ONLY)	
S7	P5047217 SWITCH, 1086L-951 (BRANCH OPTION)	
S4	P5047217 SWITCH, FLOAT (OPTIONAL)	
S3	P210093 SWITCH, ROCKER - SPDT (ON-ON)	
S2	P5047367 SWITCH, 1-STAT ELECTRIC (ALTERNATE)	
P14	P5045860 SWITCH, ROCKER-OPDT W/BK (0-1-(1))	
P10	P210204 CONNECTOR, PLUG-9 PIN MOLEX	
P20, P27	P5045826 CONNECTOR, PLUG-6 PIN MOLEX	
P4, P7, P36, P38	P5045829 CONNECTOR, PLUG-2 PIN MOLEX	
P3, P8, P41	P210208 CONNECTOR, PLUG-12 PIN MOLEX	
HR1	P5045241 LUG, GROUND 48-2 ANG.	
K10	P210560 CONTACTOR, DEF PURP-10AMP 24VAC 3P3T-RO	
K7-K9	P210553 CONTACTOR, RECURY-10AMP 24VAC 3P3T-RO	
K5, K6	P5046890 RELAY, 24VAC - SPDT	
K1	P5046886 RELAY, 24 VAC - OPDT W/R10 TABS	
R1	P5046592 POTENTIOMETER, 9000	
J11	P210089 CONNECTOR, JACK-3 SKT MOLEX	
J14	P5045830 CONNECTOR, JACK-9 SKT MOLEX	
J27	P210205 CONNECTOR, JACK-6 SKT MOLEX	
J10	P5045827 CONNECTOR, JACK-9 SKT	
J4, J7, J36, J38	P5045839 CONNECTOR, JACK-2 SKT MOLEX	
J3, J9, J41	P210209 CONNECTOR, JACK-12 SKT MOLEX	
HR1-HR3	SEE ELEMENT, TUBULAR	
F81, F82	P5045792 FUSE BLOCK, 3 POST	
F4, F8, F9, F11	P5045720 FUSE, 40 AMP-5.00 BLOW	
F1	P5045720 FUSE, 4 AMP-5.00 BLOW (GLASS)	
A1	P5044856 CMTB, PTCOMMATIC 184-T ON-4S OFF-285	
A3	P5044855 CMTB, PTCOMMATIC 184-T ON-4S OFF-285	
	P210562 CONTROLLER, 60 - 24 VAC ON-4S OFF-285	
NUMERICAL	PART NO.	DESCRIPTION

ET2 POWER WIRING (208 AND 240 VAC NORTH AMERICAN APPLICATIONS)

MODEL ET2 - TUBULAR ELEMENTS	LINE/AMPS	HR1-HR3
10.5 KV, 3.5 KV/ELEMENT		
1 PHASE	L1-50.5 AMPS	P5046923
2 WIRE & GND	L3-50.5 AMPS	
200	L1-43.8 AMPS	P5046924
1 PHASE	L2-29.2 AMPS	
2 WIRE & GND	L3-43.8 AMPS	
240	L1-29.2 AMPS	P5046923
3 PHASE	L2-29.2 AMPS	
3 WIRE & GND	L3-43.8 AMPS	
240	L1-25.3 AMPS	P5046924
3 PHASE	L2-25.3 AMPS	
3 WIRE & GND	L3-25.3 AMPS	

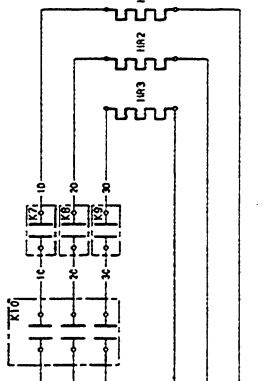
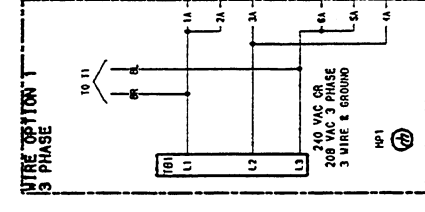
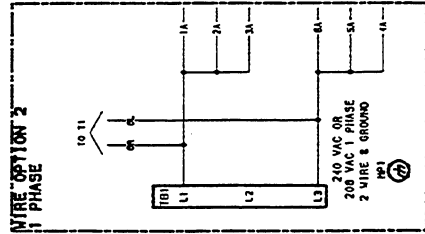

SCALE: N/A
 PART NO. 700084 00
 DATE: 3/83

In the event of problems with or questions about your order, please contact the Pitco Frialator factory, from 8:00 a.m. - 5:00 p.m., Eastern Standard Time, Monday through Friday, toll-free at:

1/800/258-3708.

In the event of problems with or questions about the equipment, please contact your local ASAP (Authorized Service and Parts) representative through the ASAP network number: 1/800/356-1008.

Free Manuals Download Website

<http://myh66.com>

<http://usermanuals.us>

<http://www.somanuals.com>

<http://www.4manuals.cc>

<http://www.manual-lib.com>

<http://www.404manual.com>

<http://www.luxmanual.com>

<http://aubethermostatmanual.com>

Golf course search by state

<http://golfingnear.com>

Email search by domain

<http://emailbydomain.com>

Auto manuals search

<http://auto.somanuals.com>

TV manuals search

<http://tv.somanuals.com>