



IMPORTANT INFORMATION FOR FUTURE REFERENCE

Record the following information from the appliance ID plate and retain this manual for the life of the equipment:

Model #: _____

Serial #: _____

Date Purchased: _____

English

Service Manual

for Pitco P/N 60149505 Spin Fryer

I12 Cooking Computer

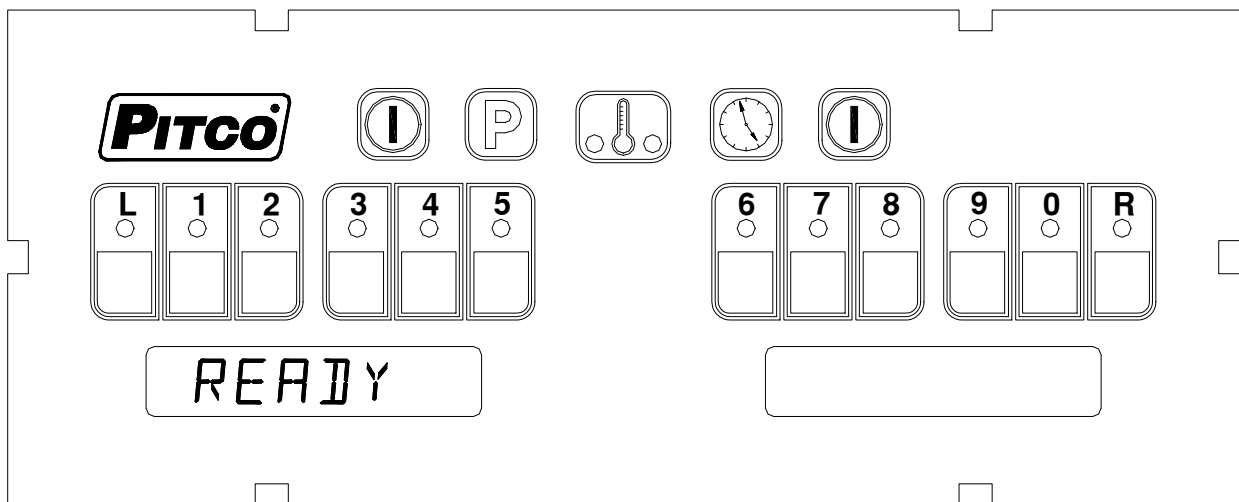

This control was developed specifically for Pitco fryer products. It utilizes the latest in microprocessor technology and is completely solid state. This control offers the latest cooking technology, including temperature and time compensation that requires no user adjustments for consistently cooked product. Other features include, drain valve interlock, faulty probe detection, selectable melt cycles, beeper volume, and cook temperature. Each product key may be programmed with cook, shake and hold times to keep pace with changing menus over time.

This manual details the operation and adjustment of the Spin Fryer I12 Cooking Computer control. The target audience for this text is the Service Technician. This manual reveals all adjustments that are possible by keyboard entry, including passwords.

Table of Contents:

1	Key Locations and Functions:	4
1.1	To turn the appliance ON: _____	4
1.2	To turn the appliance OFF: _____	4
1.3	To start a cook: _____	4
1.4	To cancel a cook: _____	5
1.5	To check Actual and Set temperatures: _____	5
1.6	To View Current Settings for Cook, Shake, Hold, and Hold Pre-Alarm: _____	5
1.7	To perform a Boil Out operation: _____	6
1.7.1	Automatic Boil Entry (Water Detection):	6
1.7.2	Manual Boil Entry:	6
2	To Enter Programming Level 1 (for the Store Manager):	7
2.1	To Set Cook Temperature: _____	7
2.2	To Change a Product Key–Cook, Shake, Hold, Hold Pre-Alarm, Spin Time, and Spin Speed: ____	8
2.2.1	Cook Time	8
2.2.2	Shake Time	8
2.2.3	Hold Time	8
2.2.4	Hold Pre-Alarm	9
2.2.5	Spin Time	9
2.2.6	Spin Rate	9
2.3	To Exit Level 1 programming: _____	9
3	To Change Options Level 2 (for the Store Manager):	10
3.1	Fahrenheit or Celsius Display: _____	10
3.2	Password Change or Required? _____	10
3.3	Beeper ON/OFF: _____	11
3.4	Language Selection: _____	11
3.5	Melt Cycle Type: _____	11
3.6	Recovery Test Value: _____	12
4	To Enter Programming Level 3 (for the Technician)	13
4.1	Offset the Temperature Display: _____	13
4.2	Melt Cycle ON Time _____	13
4.3	Minimum ON and OFF Cycle Time _____	14
4.4	Recovery Times: _____	14
4.5	Diagnostic Menu Entry _____	15
4.5.1	Basket Lift Output	15
4.5.2	Brake	15
4.5.3	Heat Demand Output	15
4.5.4	Side On Output	15
4.5.5	Drain Switch Input	15
4.5.6	Lamp Test	15
4.5.7	Heat Feedback Input	15
4.5.8	Exit Diagnostic Menu	15
4.6	Ready Level _____	16
4.7	Temperature Operating Range _____	16
4.8	More Service Menu Entry _____	16
4.8.1	Instant On Toggle	16



4.8.2	Heat Demand Profile	17
4.8.3	Shake Alarm Duration	17
4.8.4	Hold Alarm Duration	17
4.8.5	Cancel Duration.....	17
4.8.6	Configuration Value.....	17
4.8.7	Factory Reset	18
4.8.8	Standing Pilot Toggle	18
4.8.9	Set Network Address.....	18
4.9	To Exit Programming Level 3	18
5	Factory Menu Level 4 (for the Technician)	19
5.1	Pitco Collect (toggle)	19
5.2	Offset Temperature Display	19
5.3	Melt Cycle ON Time	19
5.4	Minimum ON and OFF Cycle Time.....	19
5.5	Recovery Test Values	20
5.6	Diagnostic Menu Entry	20
5.7	Ready Level	20
5.8	Operating Temperature Range.....	20
5.9	High Limit Value	20
5.10	Spin Diagnostics	21
5.10.1	Motor On/Off	21
5.10.2	Motor Speed - Increase	21
5.10.3	Motor Speed Decrease.....	21
5.10.4	Spin Direction.....	21
5.10.5	Door Open	21
5.10.6	Cook Position Indicator.....	21
5.10.7	Load Position Indicator	21
5.10.8	Spin Position Indicator	21
5.10.9	Basket Lift Position (Cook)	21
5.10.10	Basket Lift Position (Load).....	21
5.10.11	Basket Lift Position (Spin).....	21
5.11	Test On/Off	22
5.12	More Factory Menu Entry	22
5.12.1	Control ID Display	22
5.12.2	Set Network Address	22
5.13	To Exit Factory Menu (Level 4):	22
6	Other Displays:	23
7	Mechanical Dimensions:	25
8	Electrical Connections at LEFT and RIGHT connectors):.....	26
9	Probe Resistance Chart:.....	27

1 Key Locations and Functions:

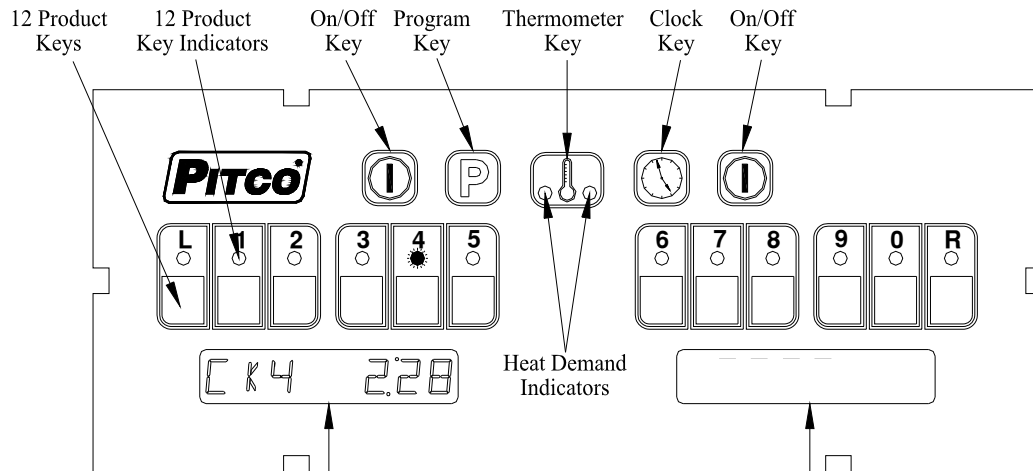

Displays show current operation. Throughout this text, a left only display will be printed as [CK4]. When both left and right displays should be interpreted together, this text will show them as [CK4 2:28]

1.1 To turn the appliance ON:

If power is applied to the appliance, the displays will show **OFF**. Press the key.

Displays will show one of the following:

MELT; **HEATING**, or **READY**. Some messages may show in both left and right displays. Wait for the appliance to heat up to the [READY] condition before cooking.

1.2 To turn the appliance OFF:



Press the key. Display will momentarily show the software version number **0149501-**, and then **OFF**.

1.3 To start a cook:



When the display is showing **READY** the appliance has reached set temperature and is ready to cook. Press the desired product key, and place product into the vat. The indicator above the product key will flash to indicate the cook timer is running. In the example above, product 4 is cooking with 2 minutes and 28 seconds remaining.





1.4 To cancel a cook:

Press and hold the product key to cancel a running cook. The controller displays . Press the '6' button to spin the basket and the '0' button to not spin the basket. If neither button is pressed after 15 second the system will default back to  state.

1.5 To check Actual and Set temperatures:

To view the actual vat temperature, press the  key. The display will show  or , where "F" is Fahrenheit, and "C" is Celsius. After a few moments, the display will return to [READY], [MELT], or [HEATING] if no cooks are running. [CKn mm:ss] will display for any cooks still running.

To view the set temperature, press the  key *twice*. The display will show  or , where "F" is Fahrenheit, and "C" is Celsius. After a few moments, the display will return to [READY], [MELT], or [HEATING] , or, [CKn mm:ss] for any cook still running.

1.6 To View Current Settings for Cook, Shake, Hold, and Hold Pre-Alarm:

To view the current settings for any product key, press the  key, followed by the desired product key. The display will show [CKn mm:ss], followed by [SHn mm:ss], then [HDn mm:ss], ending with [PA4 mm:ss]. Where "n" is the key number, and "mm:ss" is the time setting.

After a few moments, the display will return to  ;  , or  , or, [CKn mm:ss] for any cook still running.

Typical displays using key 4 as an example:

Key 4 Cook Time [CK4] is set for 3 minutes and 28 seconds.

Key 4 Shake Time [SH4] is set for 2 minutes and 00 seconds before the end of the Cook. When this time is met the cook will be suspended and basket will spin for 10 seconds unless Spin Time [ST4] is less than 10 seconds, then they are equal. The basket then returns to the cooking position. *Default value is 00:00, or inactive.*

Key 4 Hold Time [HD4] is set for 2:00 minutes. This is the amount of time cooked product may sit in holding bins before a new batch is started. *Default value is 00:00, or inactive.*

Key 4 Hold Pre-Alarm [PA4] is set for 00:00 and is inactive (*default setting*). When activated his alarm warns the operators that the Hold Time is about to run out.

Key 4 Spin Time [ST4] is set for 00:30. When activated this is the time that the basket will spin for at the end of the cook. *Default value is 00:30.*

Key 4 Spin Rate [SR4] is set to 350. When active this is the speed at which the basket will spin.

Default value is 350, or inactive.

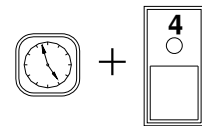

1.7 To perform a Boil Out operation:

Normal maintenance of a fryer requires regular tank cleaning. This process involves draining the vat of oil and filling with water. Cleaning solution is added, and the control is set to boil by one of the following methods:

1.7.1 Automatic Boil Entry (Water Detection):

Fill the appliance with water and turn the appliance on. Heat will be applied to the vat warming the water. This control will detect the presence of water by temperatures not rising above the boiling point of water; 212°F (100°C). After a time at this temperature, displays will show

PRESS 0 TO BOIL

Heat will be disabled until the operator responds to this prompt. Pressing the [0] key is a **YES** response to the boil prompt. If pressed, display will show BOIL. Heat will maintain vat temperature at 185°F (85°C) for cleaning as long as the control remains on. To exit boil mode control must be turned off.

*Warning: Pressing any other key at the [PRESS 0] [TO BOIL] prompt is regarded by the control as a **NO** response. With this response, the control will apply heat to the vat as if oil were present in the vat. With water in the vat, a rolling boil will result. This will cause undesirable foam over conditions. And, a potential steam burn hazards to operators performing cleaning operations.*

1.7.2 Manual Boil Entry:

After filling an empty vat with water, turn the appliance on. Press the



key and enter key sequence [2], [1], [2]. *If control is set to display in the Celsius scale, press [1], [0], [0] keys to manually enter boil mode.* The display will show BOIL to indicate entry into boil mode.

To exit boil mode, control must be turned off.

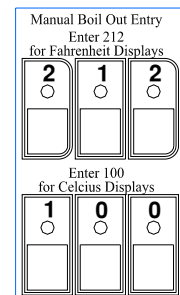





2 To Enter Programming Level 1 (for the Store Manager):

Note: The factory default setting for this control does not require a password to be entered. However, the operator password requirement and value may be changed in section 3.2. Entry of a password when NOT required will not interfere with the programming process.

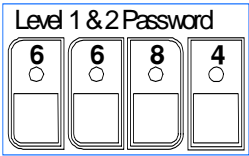



With no cook timers running, displays will show one of the following displays:  ;

 , or  . Press the  key.

<p>If display shows:</p> <p> , a password is required.</p> <p>Enter password  using the product keys as a numeric keypad for entry. With correct password entry, display will show  .</p>	<p>If display shows:</p> <p> ; you do not need to enter a password.</p>
----------------------------------------------------------------------------------------------------------------------------------------------------------------------------------------------------------------------------------------------------------------------------------------------------------------------------------------------------------------------------------------------------------------------------------------------	------------------------------------------------------------------------------------------------------------------------------------------------------------

From the  display, continue with this section or go to section 3, or 4.

2.1 To Set Cook Temperature:

- ❑ Press the  key once. The display will show [SET xxxF] [TEMP] or [SET xxxC] [TEMP], where “xxx” is the temperature setting.
- ❑ Use the product keys for numeric entry to adjust the current setting. Press the  key to save setting. Display now shows  . To exit here, press  again, or continue.

2.2 To Change a Product Key–Cook, Shake, Hold, Hold Pre-Alarm, Spin Time, and Spin Speed:

For each product key, Cook, Shake, Hold, and Hold Pre-alarm times are set in this section.

- ❑ With display showing **PROGRAM**, continue with the following section for each product key to change. Press the  key.
- ❑ Display will show **SELECT PRODUCT**. Press the desired product key to change.

2.2.1 Cook Time

Cook Time may be set for each product key. To deactivate any product key enter a zero value for cook time.

- ❑ Display shows [nCK mm:ss] [TIME] where “n” is the key number, “CK” means Cook, and “mm:ss” is minutes and seconds.
- ❑ Use the product keys for numeric entry to adjust the current setting. Press the  key to save cook time and continue setup for this product key.

2.2.2 Shake Time

Shake time is an alarm that sounds during Cook Time to prompt operators that the basket is about to perform a spinning process. Default for this value is zero, meaning the Shake Time is inactive. To use Shake Time, the time value must be a non-zero value, and, must be set to a value less than cook time.

- ❑ Display shows [nSH mm:ss] [TIME] where “n” is the key number, “SH” means Shake, and “mm:ss” is time in minutes and seconds.
- ❑ Use the product keys for numeric entry to adjust the current setting. Press the  key to save shake time and continue setup for this product key.
- ❑ Spin time for shake is set to 10 seconds, unless Spin Time section 2.2.5 is less than 10 seconds then they are the same.
- ❑ Spin Rate for shake is same as Spin Rate section 2.2.6.

Note: The value entered for shake time is the time from the end of the cook.

2.2.3 Hold Time

Cooked product may stand in holding bins for a period of time. This timer produces an alarm to inform operators to discard old product and start a new cook. *Default for this value is zero, meaning the Hold Time is inactive.*

- ❑ Display shows [nHD mm:ss] [TIME], where “n” is the key number, “HD means HOLD, and “mm:ss” is minutes and seconds.
- ❑ Use the product keys for numeric entry to adjust the current setting. Press the  key to save hold time and continue setup for this product key.

2.2.4 Hold Pre-Alarm

Hold Pre-Alarm is a timer setting that is used to warn operators that the Hold Time is about to expire. To use Hold Pre-Alarm, the time value must be a non-zero value, and, must be set to a value less than Hold Time. *Default value is zero, meaning the Hold Pre-Alarm is inactive.*

- ❑ Display shows [nPA mm:ss] [TIME] where “n” is the key number, PA means Pre-Alarm, and “mm:ss” is minutes and seconds.
- ❑ Use the product keys for numeric entry to adjust the current setting. Press the  key to save pre-alarm time. *Note: Value entered for hold pre-alarm time is the time from the end of the hold period.*

2.2.5 Spin Time

Spin time is the duration that the basket will spin after the cook cycle. The basket will not spin after a cook cycle if the set spin time is set to 0.

- ❑ Display shows [nST mm:ss] [TIME] where “n” is the key number, ST means Spin Time, and “mm:ss” is minutes and seconds.
- ❑ Use the product keys for numeric entry to adjust the current setting. Press the  key to save spin time.

2.2.6 Spin Rate

Spin rate is the maximum speed the basket will spin after the cook cycle. The spin rate value must be between 200 and 500.

- ❑ Display shows [nSR XXX] [TIME] where “n” is the key number, SR means Spin Rate, and “XXX” is the rate in RPMs.
- ❑ Use the product keys for numeric entry to adjust the current setting. Press the  key to save spin rate.

Display will again return to . Repeat steps from section 2.2.2 to make changes to any other product keys or continue.

2.3 To Exit Level 1 programming:

Display shows .

Press the  key. Display shows . Continue to section 3 “To Change Options”, or, exit here in the next step.

To exit Level 1 programming, press the  key again.

Displays will show ; , or , when no active cooks are running.

3 To Change Options Level 2 (for the Store Manager):

The display must show **PROGRAM** from section 2 to change these options. When the product key [0] is pressed, the display will show **SELECT OPTIONS**. Indicator lights above product keys will illuminate to represent options that may be changed. Each option listed below uses the product key [0] to toggle or scroll through available choices in the display.

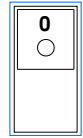

When the correct value is displayed, press the  key to save choice. The display will again return to **PROGRAM** for another option selection.

3.1 Fahrenheit or Celsius Display:

The Controller will display temperatures in the Fahrenheit or Celsius scales. The default scale is °F. With display showing **PROGRAM**, press the product key [0].

- ❑ Display shows **SELECT OPTIONS**.
- ❑ Press product key 1, display shows [DEGREE n] [F OR C], where “n” is the current setting.
- ❑ Use the product key [0] to scroll through choices (F or C). Press  key to save choice.
- ❑ Display shows **PROGRAM**.

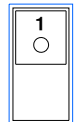

3.2 Password Change or Required?

With factory settings, an operator password is not required to enter programming Levels 1 and 2. The password may be activated or changed in these steps.

With display showing **PROGRAM**, press the product key [0].

- ❑ Display will show **SELECT OPTIONS**.
- ❑ Press product key 2, display shows [SET PAS] [NEW PASS]. Use the product key [0] to scroll through choices [NO PASS] or [PASS REQ]. Press  key to save choice.
- ❑ If [NO PASS] is selected Display returns to **PROGRAM**.
- ❑ If [PASS REQ]. is selected, display will show [PASSnnnn] [NEW PASS] to prompt for new password. Displayed value “nnnn” is the current password. Use the product keys for numeric entry to change password. Press [P] key to save choice. Display then shows **PROGRAM**.

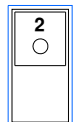

Note: The factory default password (6684) will always work even if a different password is selected here.

3.3 Beeper ON/OFF:

With display showing **PROGRAM**, press the product key [0].

□ Display will show **SELECT** **OPTIONS**. Press product key **3**, display shows [BEEPER][ON].

□ Use the product key [0] to toggle ON of OFF.

□ Press  key to save choice. Display shows **PROGRAM**.

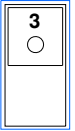
**3.4 Language Selection:**

With display showing **PROGRAM**, press the product key [0].

□ Display will show **SELECT** **OPTIONS**.

□ Press product key **4**, display shows [ENGLISH] [LANGUAGE].

□ Use the product key [0] to scroll through choices (ENGLISH, ESPANOL, FRANCAIS, DEUTSCH, HOLLAND).

□ Press  key to save choice. Display shows **PROGRAM**.

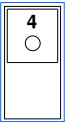
**3.5 Melt Cycle Type:**

This adjustment allows selection of the melt cycle type and requirement when starting the appliance from a cold start.

With display showing **PROGRAM**, press the product key [0].

□ Display will show **SELECT** **OPTIONS**.

□ Press product key **5**, display shows [LIQUID], the default setting.

□ Use the product key [0] to scroll through choices (liquid, solid, or, no melt).

□ Press  key to save choice. Display will again return to **PROGRAM**.

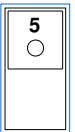

3.6 Recovery Test Value:

This controller maintains a record of heat up times for the appliance. A poorly running appliance will have increased recovery times stored in this display. There is no selection done here, just the display of recovery time values.

With display showing **PROGRAM**, press the product key [0].

- Display will show **SELECT** **OPTIONS**.
- Press product key **6**; display will show [RECOVERY] [TEST].
- Press the product key [0]. Display will show [FnnnLyyy], where nnn is the factory recovery value, and yyy is the last warm- up recovery value. Record these values for later comparison.

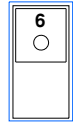

4 To Enter Programming Level 3 (for the Technician)

With no cook timers running, displays will show one of the following displays:

MELT ; **HEATING** , or **READY** .

- ❑ Press the **P** key. The left display will show **PROGRAM** . The right display will be blank.

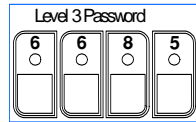

- ❑ Enter password using the product keys as a numeric keypad for entry.
- ❑ Display will show **SERVICE** . Product key indicators will illuminate to prompt operator to select a key. This section details parameters that may be changed in Level 3 programming.

4.1 Offset the Temperature Display:

This adjustment allows the displayed temperature value to be offset to reflect the true center vat temperature while reading the probe tip temperature. Default value is +2. With zero value set, displayed values are the probe temperature.

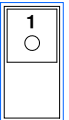

With display showing **FACTORY** press product key 1.

- ❑ Display shows [OFF nn F] [DEGREES], where “nn” is the value of the adjustment.
- ❑ Negative values are preceded with a minus sign. To change this value, use the product keys for numeric entry of a new value.
- ❑ Press the **P** key. Display will show [POSITIVE] [DEGREES]. Use the product key to scroll choices (Positive or Negative value).
- ❑ After selection, press the **P** key. Display shows **FACTORY** .

Note: Computer Display Temp – Center Vat Temp = Offset (+/-). Example: Computer Display shows 350F while Center Vat Temp measures 352F. 350F – 352F = - 2 °F. A negative offset value. Proper equipment and expertise is required to correctly adjust this value. Even small changes may negatively affect cooking performance.

4.2 Melt Cycle ON Time

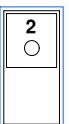

With display showing **SERVICE** press product key 2.

- ❑ Display shows [MLTON :nn] [MELT ON], where “nn” is the value, in seconds, of time for a melt cycle heat pulse.
- ❑ To change this value, use the product keys for numeric entry of a new value.
- ❑ Press the **P** key. Display returns to **SERVICE** .



4.3 Minimum ON and OFF Cycle Time

With display showing **SERVICE** press product key **3**.

- ❑ Display shows [MIN ON:nn] [MIN ON], where “nn” is the value, in seconds, of time for minimum heat pulse period.
- ❑ To change this value, use the product keys for numeric entry of a new value, then press the  key to save.
- ❑ Display shows [MIN OFF:nn] [MIN OFF], where “nn” is the value, in seconds, of time for minimum heat off period. Use the product keys for numeric entry of a new value.
- ❑ Press the  key. Display now shows **SERVICE**.

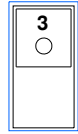

4.4 Recovery Times:

This controller maintains a record of heat up times for the appliance. A poorly running appliance will have increased recovery times stored in this display. There is no selection done here, just the display of recovery time values.

With display showing **PROGRAM**, press the product key [0].

- ❑ Display will show **SELECT OPTIONS**.
- ❑ Press product key **6**; display will show [RECOVERY] [TEST].
- ❑ Press the product key [0]. Display will show [FnnnLyyy], where nnn is the factory recovery value, and yyy is the last warm- up recovery value.
- ❑ After recording these values, press the  key. Display will again return to **PROGRAM**.

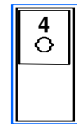

4.5 Diagnostic Menu Entry

The diagnostic menu is used to determine the functionality of controller outputs and inputs. By exercising each output and examining inputs, a determination can be made if an appliance problem is controller related. In the diagnostic menu, product keys are assigned specific inputs or outputs.

All outputs in the ON state should produce 22VDC at the appropriate pins on the controller connector. Controller inputs can be verified by the on or off state of the indicator above the product key. This section details the process of checking each input and output.

- ❑ With display showing SERVICE press product key **5**.
- ❑ Display will show [DIAGNOST] [DIAGNOST].

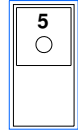

The following list describes the function of each key in the diagnostic mode.

Function	Description	Button
4.5.1 Basket Lift Output	Toggles basket lift output on and off. Display will show [BASKET]	1
4.5.2 Brake	Toggles basket lift brake output on and off. Display will show [Brake] [Brake]	2
4.5.3 Heat Demand Output	Hold the product key 3 to force Heat Demand output ON. Display will show [HEAT DEM]. Releasing the key will force output OFF.	3
4.5.4 Side On Output	Toggles the "Side ON" output ON. Display will show [SIDE ON] Press again to toggle output OFF.	4
4.5.5 Drain Switch Input	Display will show state of the Drain Valve input. Display will show [DRN ON (or OFF)]. Product key 5 indicator shows the ON or OFF state of the input.	5
4.5.6 Lamp Test	All display indicators will be forced on. The purpose is to reveal non-functional indicators or displays.	6
4.5.7 Heat Feedback Input	Display will show state of the Heat Feedback input [FB xxx], where xxx is ON or OFF. Key 7 indicator shows the ON or OFF state of this input.	7

4.5.8 Exit Diagnostic Menu

To exit diagnostic menu, press the P key. Display will return to SERVICE. Other service menu items may be selected for changes.

To return to programming, press the P key again. Display will show PROGRAM. Other settings can be made in section 2.

To return to normal operations, press the P key again. Display will show one of the normal displays: MELT; HEATING, or READY.

4.6 Ready Level

With display showing **SERVICE** press product key 6.

Display shows [READY nn], where “nn” is the value, in degrees below set temperature that the **READY** message is displayed.

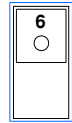

To change this value, use the product keys for numeric entry of a new value.

Press the **P** key. Display now shows **SERVICE**.

4.7 Temperature Operating Range

Forces the control to display the range of temperatures that may be set by operators.

With display showing **SERVICE** press product key 7.

Display shows [RANGE 1] [200 380]. No adjustments are permitted here. This is an information display only.

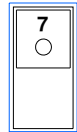

Press the **P** key. Display returns to **SERVICE**.

4.8 More Service Menu Entry

With display showing **SERVICE** press product key 8 to enter submenu. Display now shows **MORE SERVICE**.

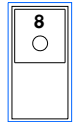

Product keys will illuminate where adjustments are permitted; all other keys are inactive. The following section details each product key function in the **MORE SERVICE** menu.

4.8.1 Instant On Toggle

This setting is to allow disabling the instant on feature. This feature applies a momentary heat pulse to the appliance when a cook key is pressed. *Factory default value is ON.*

With display showing **MORE SERVICE**, press product key L.

Display will show [INST ON [xxx]], where “xxx” is ON or OFF.

Use product key [0] change value. Press the **P** to save choice.

Display returns to **MORE SERVICE**.

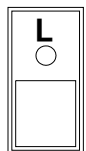

4.8.2 Heat Demand Profile

With display showing **MORE** **SERVICE**, press product key **3**. Display will show [xxxxxxx] [HEAT DEM], where xxxxxx may be one of 6 heat control profiles listed below.

1. [GENERIC 1] for gas fired fryer appliance. *This is the factory default.*
2. [GENERIC 2] for electric fryer appliances, and model SGH50.
3. [TEST] for use in special cook testing, do not select this setting for normal operations.

Use product key [0] change value, then press the **P** to save choice Display returns to

MORE **SERVICE**.



4.8.3 Shake Alarm Duration

With display showing **MORE** **SERVICE**, press product key **4**. Display will show [SH-DUR:nn] [DURATION], where “nn” is the time in seconds the shake alarm will sound. Use

product keys for numeric entry of desired value, then press the **P** to save choice. Display

returns to **MORE** **SERVICE**.

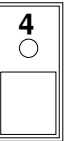

4.8.4 Hold Alarm Duration

With the display showing **MORE** **SERVICE**, press product key **5**. Display will show [HD-DUR:nn] [DURATION], where “nn” is the time in seconds the hold alarm will sound.

Use product keys for numeric entry of desired value, then press the **P** to save choice.

Display returns to **MORE** **SERVICE**.



4.8.5 Cancel Duration

With the display showing **MORE** **SERVICE**, press product key **6**. Display will show [CANCEL:nn] [DELAY], where “nn” is the time in seconds the operators must press a product key to cancel a cook. Use product keys for numeric entry of desired value, then press

the **P** to save choice. Display returns to **MORE** **SERVICE**. Default value is 2 seconds.

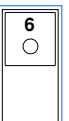

4.8.6 Configuration Value

With display showing **MORE** **SERVICE**, press product key **7**. Display will show [CFG hhhh], where “hhhh” is a hexadecimal checksum of the configuration memory contained in the controller. Modifications to any part of the setup of this control will change the check

sum value. Press the **P** display will return to **MORE** **SERVICE**.

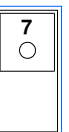

4.8.7 Factory Reset

Factory Reset provides a quick way to erase all setup changes and restore control to factory settings.

Warning: Any settings made prior to a factory reset will be lost. This includes customer specific downloads performed at Pitco Frialator. Heat profile after a reset is Generic 1 for gas appliances.

With the display showing **MORE SERVICE**, press **8** product key. After a few moments, the display will show [P]. Press the **P** display will return to **MORE SERVICE**.

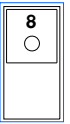

4.8.8 Standing Pilot Toggle

For some applications, it is desirable to maintain the gas pilot flame when the appliance is OFF. Heat from the pilot keeps solid shortening in the liquid state for quicker warm-ups in the morning. Default setting for standing pilot is off.

Note: Heat Demand Profile (section 4.8.3) must be set to Generic 1, or T-stat. Standing Pilot toggle has no effect in with any other setting.

With the display showing **MORE SERVICE**, press product key **9**. Display will show [STANDING] [PILOT n], where “n” is ON or OFF. Use product key [0] change value, then press the **P** to save choice. Display returns to **MORE SERVICE**.

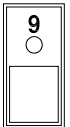

4.8.9 Set Network Address

With the display showing **MORE SERVICE**, press key **R**.

- ❑ Display will show [ADDR aa], where “aa” is a current address (**default is 31**) for this control. When controls are connected together for data collection, all controls must have different addresses for cooking computers that are tied together with the RS-485 communications port.
- ❑ To change this value, use the product keys for numeric entry of a new value.
- ❑ Press the **P** key. Display returns to **MORE SERVICE**.

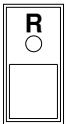

4.9 To Exit Programming Level 3

With display showing **SERVICE**, press the **P** key.

- ❑ Display will show **PROGRAM**. Continue with changes in sections 2 or 3, or continue exit with the next step. To return to normal operations, press the **P** key again.

5 Factory Menu Level 4 (for the Technician)

With no cook timers running, displays will show one of the following displays:

MELT ; HEATING , or READY .

- Press the  key. The left display will show PROGRAM . The right display will be blank.

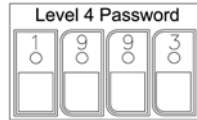

- Enter password using the product keys as a numeric keypad for entry.
- Display will show FACTORY . Product key indicators will illuminate to prompt operator to select a key. This section details parameters that may be changed in Level 4 programming.

5.1 Pitco Collect (toggle)

With display showing FACTORY press product key L.

- Display shows [PCOLLECT] [OFF]. This toggle forces the RS-485 link to output data collection parameters during test, and calibration. This has no meaningful use in the field.

Note: Do not change this setting. Factory shipped default is OFF.

- To change this value, use the 0 key to select a new value.
- Press the  key. Display returns to FACTORY .

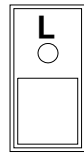

5.2 Offset Temperature Display

This menu is identical to Offset Temperature Display section 4.5

except FACTORY is displayed instead of [SERVICE].

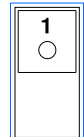

5.3 Melt Cycle ON Time

This menu is identical to Melt Cycle ON Time section 4.1 except FACTORY is displayed instead of [SERVICE].

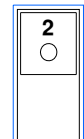

5.4 Minimum ON and OFF Cycle Time

This menu is identical to Minimum ON and OFF Cycle Time section 4.2 except FACTORY is displayed instead of [SERVICE].



5.5 Recovery Test Values

This menu is identical to Recovery Times section 4.4 except **FACTORY** is displayed instead of [SERVICE].

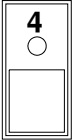

5.6 Diagnostic Menu Entry

This menu is identical to Diagnostic Menu section 4.5 except **FACTORY** is displayed instead of [SERVICE].

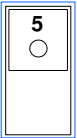

5.7 Ready Level

This menu is identical to Ready Level section 4.6 except **FACTORY** is displayed instead of [SERVICE].

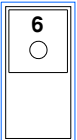

5.8 Operating Temperature Range

This menu is identical to Temperature Operating Range section 4.7 except **FACTORY** is displayed instead of [SERVICE].

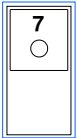

5.9 High Limit Value

With display showing **FACTORY** press product key 8.

- ❑ Pressing product key 8 forces the control to display the temperature above the set temperature, where the high limit alarm will sound. This is a display only value, this value cannot be changed with a keypad entry.
- ❑ Press the  key. Display now shows **FACTORY**.

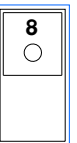

Note: Factory default value is 40°F over set temperature, or 410°F absolute, whichever is less.

5.10 Spin Diagnostics

The Spin Diagnostic menu is used to determine the functionality of controller outputs and inputs. By exercising each output and examining inputs, a determination can be made if an appliance problem is controller related. In the diagnostic menu, product keys are assigned specific inputs or outputs.

All outputs in the ON state should produce 22VDC at the appropriate pins on the controller connector. Controller inputs can be verified by the on or off state of the indicator above the product key. This section details the process of checking each input and output.

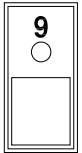

- With display showing **FACTORY** press product key **9**. The screen will show [SPIN][DIAGNOST]

The following list describes the function of each key in the spin diagnostic mode.

Function	Description	Button
5.10.1 Motor On/Off	Toggles spin motor on and off.	L
5.10.2 Motor Speed - Increase	Increases the spin motor's speed in 10 RPM increments up to a maximum of 500 RPM.	1
5.10.3 Motor Speed Decrease	Decreases the spin motor's speed in 10 RPM increments up to a minimum of 60 RPM.	2
5.10.4 Spin Direction	Toggles the motor's spin direction from spinning clockwise to counter-clockwise or vice-versa. <i>To be used if object becomes stuck during spinning.</i>	3
5.10.5 Door Open	Activates the indicator light to show the door's current position.	5
5.10.6 Cook Position Indicator	Activates the indicator light to show the basket lift's current position. <i>Shows CLOSED if not in the stated position.</i>	6
5.10.7 Load Position Indicator	Activates the indicator light to show the basket lift's current position. <i>Shows CLOSED if not in the stated position.</i>	7
5.10.8 Spin Position Indicator	Activates the indicator light to show the basket lift's current position. <i>Shows CLOSED if not in the stated position.</i>	8
5.10.9 Basket Lift Position (Cook)	Moves the basket lift into the cook position.	9
5.10.10 Basket Lift Position (Load)	Moves the basket lift into the load position.	0
5.10.11 Basket Lift Position (Spin)	Moves the basket lift into the spin position.	R

Note: LSW – Limit Switch. This is the black collar located on the basket lift actuator.

- Press  the display will return to **FACTORY**.

5.11 Test On/Off

With display showing **FACTORY** press product key **0**.

Display shows [TEST xx], where “xx” is ON or OFF. If ON is selected, temperatures displayed by the controller are probe tip temperatures unaltered by values set in section 4.1, or 5.1. *For normal operations, this setting should remain OFF.*

To change this value, use product key 0 to toggle choice (ON or OFF).

Press the  key. Display now shows **FACTORY**.

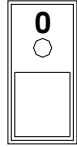

5.12 More Factory Menu Entry

With display showing **FACTORY** press product key **R**.

Display shows **MORE** **FACTORY**.

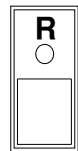

5.12.1 Control ID Display

From the **MORE** **FACTORY** display, press the [0] key.

Display will show [CONTROL] [60149505], the Pitco part number, 60149505.

Press the [0] key again.

Display will show [S/W] [0149501x], this is Pitco’s software number and current revision letter.

□ Press the [0] key again.

Display will show [CHECKSUM] [00Fxxxxx], the software check sum of the loaded software.

□ Press the [0] key again to repeat these items, or, press  to return to

MORE **FACTORY**.

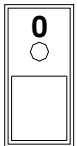

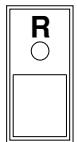

5.12.2 Set Network Address

*This menu is identical to Set Network Address section 4.8.9 except **FACTORY** is displayed instead of [SERVICE].*



5.13 To Exit Factory Menu (Level 4):

□ To exit Factory Programming, Press the  key. Display will show **PROGRAM**.
Continue with settings in section 2 or 3, or exit in the next step.

□ To return to normal operations, press the  key again.

□ Display shows **MELT**; **HEATING**, or **READY**.

6 Other Displays:

PROBE OP

Open probe detection is standard on all Pitco controls. If probe is detected open, normal heating and cooking activities are suspended.

HIGH TMP

This display warns operators that the vat temperature has exceeded set temperature by +40°F (+22°C), or an absolute maximum of 410°F (210°C). The alarm will also sound. This display does not show the status of the mechanical high limit switch.

DRAINING TURN OFF

This message indicates that the drain valve has been opened, the vat is assumed to be empty by the controller. Normal heat control activities are suspended. Display will show an alternating message [DRAINING] / [TURN OFF]. To restore to normal operation, close the drain valve. Display will show [TURN OFF].

Turn controller off, and refill the vat. Continue with normal operations at section 1.

HEAT FAILURE

This message indicates that the heating system failed to respond. Typically, the high temperature limit switch has tripped and is in need of resetting. In the case of gas fired appliances, this message will display if the pilot fails to light or is detected marginal by the ignition module. Display will show an alternating message [HEAT] / [FAILURE].

SYSTEM FAILURE

This message indicates a shorted probe. If probe is detected as a short circuit, normal heating and cooking activities are suspended. Display will show an alternating message [SYSTEM] / [FAILURE].

FACTORY Y OR N
RESET

This message indicates that a recoverable system error has occurred. Press '6' for YES to perform a factory reset or '0' for NO to return to OFF. Normal use of the system will only resume when a factory reset has been performed. Display will show an alternating message [FACTORY] / [RESET].

SM_POSIT FAILURE

This message indicates that the basket lift was unable to verify its active location during startup. Turn unit off and back on to attempt to fix. If problem persists attempt to reset basket lift manually. This could also indicate a faulty basket lift transformer. Display will show an alternating message [SM_POSIT] / [FAILURE].

BL_POSIT FAILURE

This message indicates that the basket lift was unable to detect the target position during operational basket lift movement. Basket lift will automatically reset and attempt to verify startup locations. A subsequent BL_POSIT FAILURE may be displayed if startup locations cannot be verified. If problem persists, attempt to adjust basket lift position sensors. This could also indicate a problem with a faulty circuit between the position sensors and the computer.

7 Mechanical Dimensions:

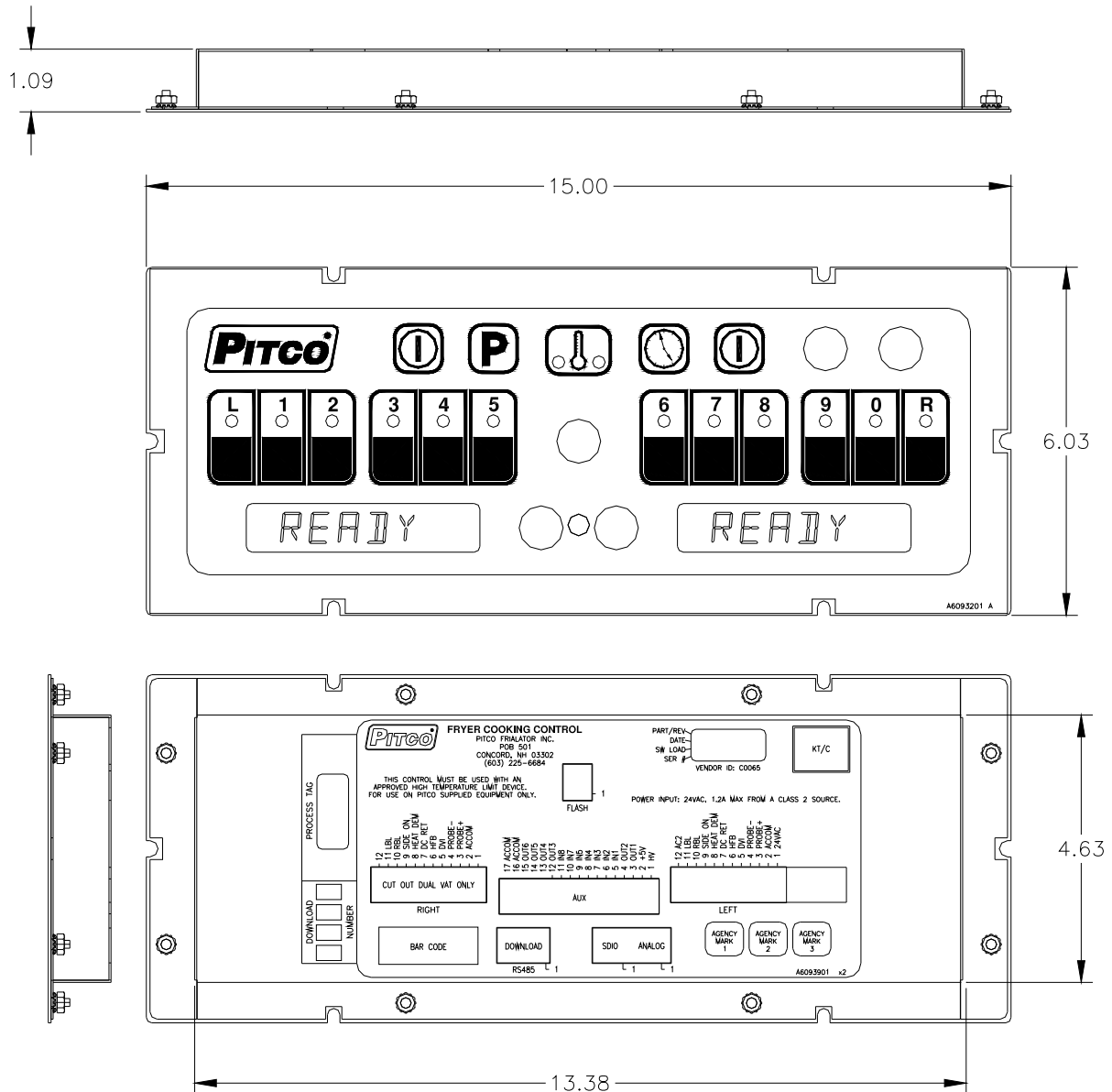

8 Electrical Connections at LEFT and RIGHT connectors):



As viewed from the rear of the control.

J1(Left)	Inputs	Type	Nominal	Notes:
1	ACH	PWR	24VAC	24VAC +20% -15% 50/60Hz.
2	ACN	PWR	24VACN	24VAC Return.
3	PROBE+	Thermistor Proble	Resistance varies with vat temperature. 942 Ohms @ 350°F	
4	PROBE-			
5	DVI	IN	24VAC	Drain Valve Interlock
6	HFB	IN	24VAC	Heat Feed Back
7	24VDC COM	IN	24VDC	DC Return
8	HD	OUT	24VDC	Heat Demand
9	SO/xFER	OUT	24VDC	Side ON or XFER
10	RBL	OUT	24VDC	Right Basket Lift
11	LBL	OUT	24VDC	Left Basket Lift
12	AC2	PWR	24VAC	Aux Power Input

Tip: Use the diagnostic menu to verify operation of outputs, and inputs.

9 Probe Resistance Chart:

Probe Resistance in 5°F Increments.								
Probe Temp (°F)	Probe Temp (°C)	Resistance (Ohms)	Probe Temp (°F)	Probe Temp (°C)	Resistance (Ohms)	Probe Temp (°F)	Probe Temp (°C)	Resistance (Ohms)
10	-12.2	562734	175	79.4	11719	340	171.1	1058.23
15	-9.4	483875	180	82.2	10716	345	173.9	998.09
20	-6.7	417167	185	85.0	9812	350	176.7	942.00
25	-3.9	360589	190	87.8	8995	355	179.4	889.67
30	-1.1	312474	195	90.6	8255	360	182.2	840.78
35	1.7	271446	200	93.3	7586	365	185.0	795.10
40	4.4	236370	205	96.1	6979	370	187.8	752.38
45	7.2	206311	210	98.9	6427	375	190.6	712.41
50	10.0	180491	215	101.7	5926	380	193.3	674.95
55	12.8	158252	220	104.4	5470	385	196.1	639.87
60	15.6	139055	225	107.2	5055	390	198.9	606.96
65	18.3	122489	230	110.0	4675	395	201.7	576.09
70	21.1	108051	235	112.8	4329	400	204.4	547.09
75	23.9	95539	240	115.6	4013	405	207.2	519.86
80	26.7	84644	245	118.3	3723	410	210.0	494.24
85	29.4	75136	250	121.1	3458	415	212.8	470.16
90	32.2	66823	255	123.9	3214	420	215.6	447.49
95	35.0	59540	260	126.7	2991	425	218.3	426.13
100	37.8	53146	265	129.4	2785	430	221.1	406.02
105	40.6	47523	270	132.2	2597	435	223.9	387.04
110	43.3	42569	275	135.0	2422	440	226.7	369.14
115	46.1	38195	280	137.8	2262	445	229.4	352.24
120	48.9	34328	285	140.6	2113.9	450	232.2	336.29
125	51.7	30902	290	143.3	1977.3	455	235.0	321.21
130	54.4	27862	295	146.1	1851.0	460	237.8	306.94
135	57.2	25161	300	148.9	1734.3	465	240.6	293.46
140	60.0	22755	305	151.7	1626.1	470	243.3	280.69
145	62.8	20610	310	154.4	1525.9	475	246.1	268.61
150	65.6	18695	315	157.2	1433.0	480	248.9	257.15
155	68.3	16981	320	160.0	1346.7	485	251.7	246.30
160	71.1	15446	325	162.8	1266.6	490	254.4	236.00
165	73.9	14069	330	165.6	1192.1	495	257.2	226.24
170	76.7	12823	335	168.3	1122.8	500	260.0	216.96

Notes: Resistance, of either probe lead, to the frame of the appliance should read as "open" on the meter. Typically this is 1Meg ohms or more.

°C = 5/9 (°F-32)

°F = (9/5 * °C) +32



In the event of problems with or questions about your order, please contact the Pitco Frialator factory at

(603) 225-6684 World Wide

www.pitco.com

In the event of problems with or questions about your equipment, please contact the Pitco Frialator Authorized Service and Parts representative (ASAP) covering your area, or contact Pitco at the numbers listed to the left.

MAILING ADDRESS – P.O. BOX 501, CONCORD, NH 03302-0501

SHIPPING ADDRESS – 10 FERRY ST., CONCORD, NH 03301

Free Manuals Download Website

<http://myh66.com>

<http://usermanuals.us>

<http://www.somanuals.com>

<http://www.4manuals.cc>

<http://www.manual-lib.com>

<http://www.404manual.com>

<http://www.luxmanual.com>

<http://aubethermostatmanual.com>

Golf course search by state

<http://golfingnear.com>

Email search by domain

<http://emailbydomain.com>

Auto manuals search

<http://auto.somanuals.com>

TV manuals search

<http://tv.somanuals.com>