



IMPORTANT FOR FUTURE REFERENCE
Please complete this information and retain this manual for the life of the equipment:

Model #: _____
Serial #: _____
Date Purchased: _____

ENGLISH

Service Manual

for

Solstice I12 Water Cooker

Part #60153301

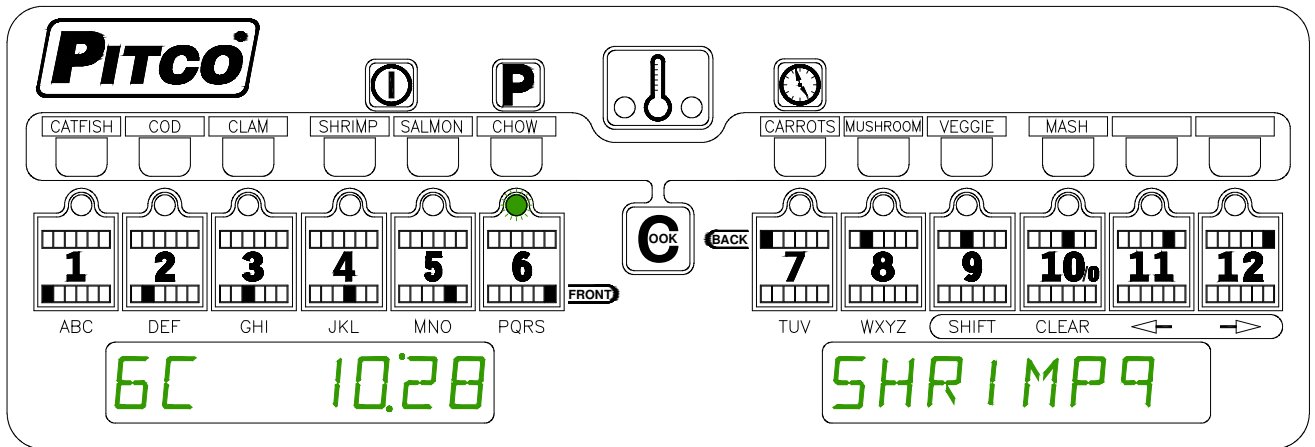

This manual details operations and adjustments of the Solstice I12 Water Cooker control developed for Pitco products. This microprocessor control offers the latest cooking technology, including temperature and time compensation that requires no user adjustments for consistently cooked product. Other features include drain valve interlock, faulty probe detection, beeper volume, and cook temperature displays. Each product key may be programmed with cook, shake and hold times, and set to display product names to keep pace with changing menus over time. This manual reveals all adjustments that are possible by keyboard entry, including passwords.

The target audience for this manual is the Service Technician.



1 Key Locations and Functions:	4
1.1 To turn the appliance ON:	4
1.2 To turn the appliance OFF:	4
1.3 To start a Cook:	4
1.4 To cancel a Cook or Hold:	5
1.5 To check Actual and Set temperatures:	5
1.6 To View Current Settings for a Product Key:	5
1.6.1 Typical displays using the above key 4 as an example:	5
2 To Enter Programming Level 1 (for the Store Manager):	6
2.1 To Set Cook Temperature:	6
2.2 To Change a Product Key–Cook, Shake, Hold and Hold Pre-Alarm Times, and Name:	6
2.2.1 Cook Time	6
2.2.2 Shake Time	6
2.2.3 Hold Time	7
2.2.4 Hold Pre-Alarm	7
2.2.5 Product Key Naming:	8
2.3 Set the Food Safe temperature for this key:	9
2.4 To Exit Level 1 programming:	9
3 To Enter Programming Level 2 (for the Store Manager):	10
3.1 Fahrenheit or Celsius Display:	10
3.2 To Change Password or Requirement:	10
3.3 Beeper Volume and Tone:	11
3.4 Language Selection:	11
3.5 Recovery Test Value:	11
3.6 Control or Timer:	12
4 To Enter Programming Level 3 (for the Technician)	13
4.1 Offset Temperature Display	13
4.2 Minimum Cycle Times	13
4.3 Recovery Time	14
4.4 Diagnostic Menu Entry	14
4.4.1 Left Basket Lift Output	14
4.4.2 Right Basket Lift Output	14
4.4.3 Heat Demand Output	14
4.4.4 Side On Output	14
4.4.5 Drain Switch Input	14
4.4.6 Lamp Test	14
4.4.7 Heat Feedback Input	14
4.4.8 Fill Done Input:	15
4.4.9 Exit Diagnostic Menu	15
4.5 Ready Level	15
4.6 Temperature Operating Range	15

4.7	More Service Menu Entry	15
4.7.1	Cook Now	15
4.7.2	Maximum Fill Time	16
4.7.3	Heat Demand Profile	16
4.7.4	Shake Alarm Duration	17
4.7.5	Hold Alarm Duration	17
4.7.6	Cancel Duration.....	17
4.7.7	Configuration Value	17
4.7.8	Factory Reset	17
4.7.9	Standing Pilot Toggle	18
4.7.10	To Exit More Service Menu.....	18
4.8	To Exit Programming Level 3	18
5	Factory Menu Level 4 (for the Technician).....	19
5.1	Offset Temperature Display.....	19
5.2	Minimum Cycle Time	19
5.3	Recovery Time	19
5.4	Diagnostic Menu Entry	20
5.5	Ready Level	20
5.6	Operating Temperature Range.....	20
5.7	High Limit Alarm Value	20
5.8	Test On/Off.....	20
5.9	To Exit Factory Menu (Level 4):.....	20
6	Other Displays:.....	21
7	Mechanical Dimensions:.....	22
8	Electrical Connections at J1:.....	23
9	Installing Menu Strips:.....	24
10	Probe Resistance Chart:.....	27

1 Key Locations and Functions:

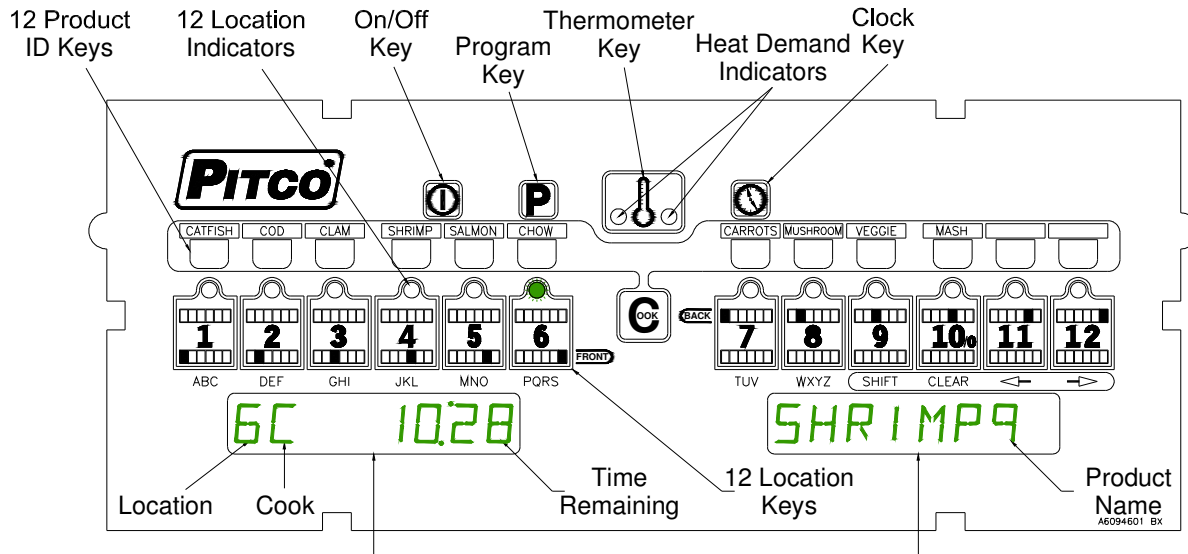

Displays show current operation. Throughout this text, a left or right only display reference will be printed as [SHRIMP9]. When both left and right displays should be interpreted together, this text will show them as [6C 10:28] [SHRIMP9].

1.1 To turn the appliance ON:

If power is applied to the appliance, the displays will show [OFF]. Press the [I/O] key. Displays will show one of the normal displays: [HEATING], [READY], or an alternating display when filling: [FILLING]<->[HEATING]. Some messages may show in both left and right displays. Wait for the appliance to heat up to the [READY] condition before cooking.



1.2 To turn the appliance OFF:



Press the [I/O] key. Display will momentarily show the software version number and then display [OFF].





1.3 To start a Cook:

When the display is showing [READY], the appliance has reached set temperature and is ready to cook. To start a cook, press the Cook key , followed by the Product key . The display will show [<name>] [RACK --], and the location indicators will light to show empty rack locations.

Press any key that is lit  and place the bag in that rack location. The indicator above the key will flash to indicate the cook timer is running.

In the example above, the cook key  was pressed, then the shrimp key ,

followed by the location 6 key . Displays then shows that SHRIMP is cooking with 10 minutes and 28 seconds remaining at location 6; [6C 10:28] [SHRIMP9].

Multiple cooks may run together. While cooks are running, the displays will always show the cook with the least time remaining. Longer running cooks will flash their indicators at a slower rate. Time remaining on any location may be checked by momentarily pressing , and a key with a flashing

light. When all cooks are done, Hold Times will be displayed in similar fashion, that is, least time remaining.

1.4 To cancel a Cook or Hold:



To cancel a running cook or hold, press and hold any key with a lit indicator. Display will momentarily display time and product, and then prompt for cancellation with the display of [2C mm:ss] [CANCEL]. Release the button immediately if you do not wish to cancel this product. Continuing to hold the button will cancel the timer.

If no other cooks or hold times are running, controller displays will return to [READY] or [HEATING].

1.5 To check Actual and Set temperatures:



To view the actual vat temperature, press the thermometer key .

The display will show [ACT tttF] or [ACT tttC], where ttt is the current vat temperature. After a few moments, the display will return to [nnC hh:mm] [product name] or [nnC mm:ss] [product name] when cooks or holds are still running. If no cooks or holds are running, then [READY] or [HEATING] is displayed.

To view the set temperature, press the thermometer key twice  + .

The display will show [SET tttF] or [SET tttC], where ttt is the current set temperature. After a few moments, the display will return to [nnC hh:mm] [product name] or [nnC mm:ss] [product name] when cooks or holds are still running. If no cooks or holds are running, then [READY] or [HEATING] is displayed.

1.6 To View Current Settings for a Product Key:

To view the current settings for any product key, press the clock key , followed by the desired product key .

The display will momentarily show the settings for Cook, Shake, Hold, and Hold Pre-Alarm for this product. The display will show the current settings for times in either [mm:ss, or h.mm:ss] for this product key. After a few moments, the display will return to [nnC h.h:mm] [product name] or [nnH mm:ss] [product name] when cooks or holds are still running.

If no cooks are running, then [READY] or [HEATING] is displayed.

1.6.1 Typical displays using the above key 4 as an example:

Key 4 has been named SHRIMP9. Cook time is set for 5 minutes and 30 seconds.

Shake time is set for 4 minutes and 15 seconds. Any time set here is an alarm before the end of the Cook.

Hold time for this product is set for 2 hours, 30 minutes.

Hold Pre-alarm is disabled by a setting of zero. Any time set here is an alarm before the end of the Hold period.

Food Safe Temperature Limit is disabled by a setting of zero, the factory default. Temperatures set here define the lower safe cooking temperature for a product key.







C	5:30	SHRIMP9
S	4:15	SHRIMP9
H	2:30:00	SHRIMP9
P	00:00	SHRIMP9
F	0F	

In a few moments, the display will return to [READY].

2 To Enter Programming Level 1 (for the Store Manager):

Note: The factory default setting for this control does not require an operator password to be entered. However, the operator password requirement and value may be changed in section 3.2. Both examples are shown in the next steps. Entry of a password when NOT required will not interfere with the programming process.



With no cooks or holds timers running, displays will show one of the following displays: [HEATING] or [READY]. Press the  key.

<p>If displays shows:</p>  <p>Enter password     using the location keys as a numeric keypad for entry. Display will show .</p>	<p>If display shows:  ; you do not need to enter a password.</p>
---	--

From this [PROGRAM] display, continue with this section or go to sections 3 or 4.

2.1 To Set Cook Temperature:

Press the  thermometer key.

The display will show [SET tttF] [TEMP] or [SET tttC] [TEMP], where “ttt” is the temperature setting. Use the location keys for numeric entry to adjust the current setting. Press the  key to save setting. The display now shows [PROGRAM]. To exit here, press  again, or continue.

2.2 To Change a Product Key–Cook, Shake, Hold and Hold Pre-Alarm Times, and Name:

Cook, Shake, Hold and Hold Pre-alarm times, and key names are set in the following steps. With display showing [PROGRAM], continue with the following section for each product key to change. Follow these steps for each product key.

2.2.1 Cook Time

Cook Time may be set for each product key. Press the  key; display will show [SELECT] [PRODUCT]. Press the desired product key to change.

The display is now showing [C hh.mm:ss] [NAME nn] where “nn” is the default key number, “C” means Cook, and “hh.mm:ss” is hour, minutes and seconds. Use the location keys for numeric entry to adjust the current setting. Press the  key to save cook time and continue with Shake Time for this product key.

Note: To deactivate any product, key enter a zero value for Cook Time.

2.2.2 Shake Time

Shake Time is an alarm that sounds during Cook Time to prompt operators to shake the basket or warn that Cook Time is about to end. Default for this value is zero, meaning the Shake Time is inactive. To use Shake Time, time value must be a non-zero value, and must be set to a value less than Cook Time.

Display shows [S hh.mm:ss] [NAME nn] where “nn” is the default key number, “S” means Shake, hh.mm:ss” is hour, minutes and seconds.

Use location keys for numeric entry to adjust the current setting. Press the key to save

Shake Time and continue with Hold Time for this product key. A display of [TOO HIGH] indicates an entry greater than Cook Time. Press the [10/0] key to clear entry, and re-enter a valid number.

Note: Cook Time minus the time from the beginning of the cook = Shake value to enter.

Example: With a 3:00 Cook Time and a desired shake alarm at 1 minute into the cook, the value you enter would be 2:00 minutes. 3:00 – 1:00 = 2:00.

2.2.3 Hold Time

Cooked product may stand in holding bins for a period of time. This timer produces an alarm to inform operators to discard old product and start a new cook. The Default for this value is zero, meaning the Hold Time is inactive.

Display is showing [H hh.mm:ss] [Name nn], where “nn” is the default key number, “H” means HOLD, and “h.mm:ss” is minutes and seconds. Use the location keys for numeric entry to

adjust the current setting. Press the key to save hold time and continue with Hold Pre-

Alarm for this product key.

2.2.4 Hold Pre-Alarm

Hold Pre-Alarm is a timer setting that is used to warn operators that the Hold Time is about to expire. To use Hold Pre-Alarm, time value must be a non-zero value, and must be set to a value less than Hold Time. The default value is zero, meaning the Hold Pre-Alarm is inactive.

Display is showing [P hh.mm:ss] [Name nn] where “nn” is the default key number, P means Pre-Alarm, and “hh.mm:ss” is minutes and seconds.

Use the location keys for numeric entry to adjust the current setting.

Press the key to save Hold Time and continue setup for this product key. A display of [TOO HIGH] indicates an entry greater than Hold Time. Press the [10/0] key to clear entry, and re-enter a valid number.

Note: Hold Time minus the time from the beginning of the cook = Hold value to enter.

Example: With a 55:00 hold time and a desired alarm at 35 minutes into the hold period, the value you enter would be 20:00 minutes. 55:00 – 35:00 = 20:00.

The prior four steps in table form:

		To Set a Product Key for Cook, Shake, Hold, HPA times, and Food Safe temperature		
	Press	[Clock]		
	Display shows	[SELECT] [PRODUCT]		
	Press	the desired product [Key#]		
Cook Time	Display shows	[C hh.mm:ss] [NAME nn]		C is Cook, nn is key
	Enter	enter/change desired Cook time.		
	Display shows	[C hh.mm:ss] [NAME nn]		
	Press	[Clock]		
Shake Time	Display shows	[S hh.mm:ss] [NAME nn]		S is Shake, nn is key
	Enter	enter/change desired Shake time.		
	Display shows	[S hh.mm:ss] [NAME nn]		
	Press	[Clock]		
Hold Time	Display shows	[H hh.mm:ss] [NAME nn]		H is Hold, nn is key
	Enter	enter/change desired Hold time.		
	Display shows	[H hh.mm:ss] [NAME nn]		
	Press	[Clock]		
PreAlarm Time	Display shows	[H hh.mm:ss] [NAME nn]		P is Pre-alarm, nn is key
	Enter	enter/change desired HPA time.		
	Display shows	[H hh.mm:ss] [NAME nn]		

2.2.5 Product Key Naming:

Display shows [P hh.mm:ss] [NAME nn] from the previous step. The first character is flashing to show the cursor location. *If the product name currently displayed is correct, press the  key.*

To change this character, press the key containing the letter. Press again, if needed, to get other letters listed under the key. When the correct letter shows in the display, press the right arrow key



to move the cursor to the next character position. Use the left and right editing arrow keys

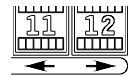

to move the flashing cursor. When naming is complete press the  key. Edit mistakes

with the left/right arrow key and the CLEAR key. To clear a character, press the CLEAR key .

This is also used to create a blank space character. Use the SHIFT key  to enter a number into a

character space. When editing is complete, press the  key to save name.

Example: Change the factory default name for key4 to SHRIMP9:

	Press	[Clock]	Program key 4 for SHRIMP 9
Enter product NAME on this key	Display shows	[KEY 4] [NAME 4]	N is flashing at cursor location
	Press key (PQRS) four times until S shows	[KEY 4] [SAME 4]	S is flashing
	Press --> move to next character	[KEY 4] [SAME 4]	A is flashing
	Press key (GHI) 2 times until H shows	[KEY 4] [SHME 4]	H is flashing
	Press --> move to next character	[KEY 4] [SHME 4]	M is flashing
	Press key (PQRS) three times	[KEY 4] [SHRE 4]	R is flashing
	Press --> move to next character	[KEY 4] [SHRE 4]	E is flashing
	Press key (GHI) three	[KEY 4] [SHRI 4]	I is flashing
	Press --> move to next character	[KEY 4] [SHRI-4]	"-" is flashing. "-" used as a place holder for blanks.
	Press key (MNO) one time	[KEY 4] [SHRIM4]	M is flashing
	Press --> move to next character	[KEY 4] [SHRIM4]	4 is flashing
	Press CLR to clear character (example)	[KEY 4] [SHRIM-]	"-" is flashing. "-" used as a place holder for blanks.
	Press key key (PQRS)	[KEY 4] [SHRIMP]	P is flashing
	Press --> move to next character	[KEY 4] [SHRIMP-]	"-" is flashing. "-" used as a place holder for blanks.
	Press --> move to next character	[KEY 4] [SHRIMP -]	creates a blank space character
	Press SHIFT key, then key 9	[KEY 4] [SHRIMP 9]	Entering a number with the shift key. 9 is flashing.
	Press Clock key	[KEY 4] [SHRIMP 9] (no flashing cursor)	Edit mistakes with -->, <--, and CLEAR keys
	Press Clock key again	[KEY 4] [SHRIMP 9]	Save this product label and continue.

--> Forward space the flashing cursor.

<-- Back space the flashing cursor.

CLR Delete the current character insert

2.3 Set the Food Safe temperature for this key:

A temperature value entered here defines the food safe temperature for this product key. Entry must also be less than Set temperature. When the vat temperature goes below this temperature, the cook timer halts. When the temperature is restored, the cook timer resumes. A zero value will disable this feature. *The factory default setting is 0°F, or inactive.*

Set Food Safe Temperature	Display shows	[SAFE ttt°F] [SHRIMP 9]	Enter the Food Safe Temperature for this product key
	Enter	enter/change SAFE temp. 0°F= off.	
	Press	[Clock]	
	Display shows	[SELECT] [TIME]	
Exit	Press	[P] to exit.	continue with other keys or exit
	Display shows	[PROGRAM] [<blank>]	



When display returns to [SELECT] [TIME]. Repeat steps from section 2.2.1 to make changes to any other product keys *or continue.*

2.4 To Exit Level 1 programming:

Display shows [SELECT] [PRODUCT].

Press the  key.

Display shows [PROGRAM]. Continue to section 3 to change options, or, exit here in the next step.

To exit Level 1 programming, press the  key again.

Displays will show [HEATING],or [READY].

3 To Enter Programming Level 2 (for the Store Manager):

The display must show [PROGRAM] from section 2 to change these options. When the location key



is pressed, the display will show [SELECT] [OPTIONS]. Indicator lights above location keys will illuminate to represent options that may be changed. Each option listed below uses the location key



to toggle or scroll through available choices in the display. When the correct value is displayed,

press the  key to save choice. The display will again return to [PROGRAM] for another option selection.

3.1 Fahrenheit or Celsius Display:

The Controller will display temperatures in the Fahrenheit or Celsius scales. The default scale is °F.



With display showing [PROGRAM], press the location key



Display shows [SELECT] [OPTIONS].

Press location key 1, display shows [DEGREE n] [F OR C], where “n” is the current setting.



Use the product key  to scroll through choices (F or C). Press  key to save choice.

Display shows [PROGRAM].

3.2 To Change Password or Requirement

With factory settings, an operator password is not required to enter programming Levels 1, 2, and 3. The password may be activated or changed in this section.

With display showing [PROGRAM], press the location key



The display will show [SELECT] [OPTIONS].

Press location key 2, display shows [SET PASS] [NEW PASS].

Use the location key  to scroll through choices [NO PASS] or [PASS REQ]. Press



 key to save choice.

If [NO PASS] is selected Display returns to [PROGRAM].

If [PASS REQ] is selected above, display will show [PASSnnnn] [NEW PASS] to prompt for new password. Displayed value “nnnn” is the current password. Use the location keys for numeric entry to change password. Press  key to save choice. Display shows [PROGRAM].



Note: The factory default password (6684) will always work even if a different password is selected above.

3.3 Beeper Volume and Tone:

Volume and Tone of the beeper alarm may be changed in this section. Volume ranges are 1,2 and 3, where 3 is the loudest setting. Later model controls have an additional selection for tones.

With display showing [PROGRAM], press the product key . Display will show [SELECT] [OPTIONS].

Press location key 3, display shows [VOLUME n] [BEEPER].

Use the product key  to scroll through choices (n= 1,2,3, or T). Beeper volume will change as each selection is made. Press  key to save choice.

If "T" is selected above, an additional display is shown, [TONE n] [BEEPER]. Use the product key

 to scroll through choices (n= 1,2,3). Beeper tone will change as each selection is made.

Press  key to save choice. Display shows [PROGRAM].

3.4 Language Selection:

With display showing [PROGRAM], press the location key .

Display shows [SELECT] [OPTIONS].

Press product key 4, display shows [ENGLISH] [LANGUAGE].

Use the location key  to scroll through choices (ENGLISH, ESPANOL, FRANCAIS, DEUTSCH, HOLLAND).

Press  key to save choice. Display shows [PROGRAM].

3.5 Recovery Test Value:

This controller maintains a record of heat up times for the appliance. A poorly running appliance will have increased recovery times stored in this display. There is no selection done here, just the display of recovery time values.

With display showing [PROGRAM], press the product key .

Display shows [SELECT] [OPTIONS].

Press product key 6; display will show [RECOVERY] [TEST].

Press the product key . Display will show [FnnnLyyy], where nnn is the factory recovery value, and yyy is the last warm up recovery value.

After recording these values, press the  key. Display returns to [PROGRAM].

3.6 Control or Timer:

With display showing [PROGRAM], press the product key . Display shows [SELECT]
[OPTIONS].

Press product key 7; display will show [CONTROL].

Use the product key  to scroll through choices (Control, Timer).

Press  key to save choice. Display shows [PROGRAM].

Note: If timer is selected, heat control outputs are disabled, leaving only the timer functions active. For normal appliance operation, this setting should be left on the "Control" setting.

4 To Enter Programming Level 3 (for the Technician)

With no cook timers running, displays will show one of the following displays: [HEATING]

or [READY]. Press the  program key. If [PASS ----] [PASSWORD] is displayed

refer to section 2.0. After entering the store managers password, the display will show [PROGRAM]. Right display will be blank.

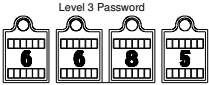
Enter technicians password  using the location keys as numeric keypad for entry.

Display will show [SERVICE]. Product key indicators will illuminate to prompt operator to select a key. This section details parameters that may be changed in Level 3 programming.



4.1 Offset Temperature Display

This adjustment allows the displayed temperature value to be offset to reflect the true center vat temperature while reading the probe tip temperature. Default value is zero. With zero value set, displayed values are the probe temperature.





With display showing [SERVICE] press product key 1.

Display shows [OFF nn F] [DEGREES], where “nn” is the value of the adjustment.

Negative values are preceded with a minus sign. To change this value, use the location keys for numeric entry of a new value.

Press the  key. Display will show [POSITIVE] [DEGREES].

Use the product key  to scroll choices (Positive or Negative value). After selection, press the

 key. Display shows [SERVICE].

Note: Computer Display Temp – Center Vat Temp = Offset (+/-). Example: Computer Display shows 185F while Center Vat Temp measures at 182F; 185F – 182F = - 3 °F. A negative offset value.

Warning: Proper equipment and expertise is required to properly adjust this value. Even small changes may negatively effect cooking performance.

4.2 Minimum Cycle Times

With display showing [SERVICE], press product key 3.

Display shows [MIN ON:nn] [MIN ON], where “nn” is the value, in seconds, for minimum heat pulse period. To change this value, use the location keys for numeric entry of a new

value, then press the  key. Display now shows [MINOFF:nn] [MIN OFF]. The value of nn is minimum number of seconds an off period can last.

Press the  key. Display now shows [SERVICE].



4.3 Recovery Time

With display showing [SERVICE], press product key 4.

Display shows [RECY nnn] [RECOVERY], where nnn is the last cold start recovery time. No adjustments are permitted here. This is an information display only.

Press the  key. Display returns to [SERVICE].



4.4 Diagnostic Menu Entry

The diagnostic menu is used to determine the functionality of controller outputs and inputs. By exercising each output and examining inputs, a determination can be made if an appliance problem is controller related. In the diagnostic menu, location keys are assigned specific inputs or outputs.

All outputs turned ON should produce 24VDC at the appropriate pins on the controller connector. Controller inputs can be verified by the on or off state of the indicator above the product key. This section details the process of checking each input and output.

With display showing [SERVICE], press product key 5.

Display will show: 



4.4.1 Left Basket Lift Output

Press the product key 1 to toggle the left basket lift output ON. Display will show [L BASKET]. Press again to toggle output OFF.

4.4.2 Right Basket Lift Output

Press the product key 2 to toggle the right basket lift output ON. Display will show [R BASKET]. Press again to toggle output OFF.

4.4.3 Heat Demand Output

Press and hold the product key 3 to force Heat Demand output ON. Display will show [HEAT DEM]. Releasing the key will turn the output OFF.

4.4.4 Side On Output

Press the product key 4 to toggle the Side ON output ON. Display will show [SIDE ON] Press again to toggle output OFF.

4.4.5 Drain Switch Input

Press the product key 5. Display will show state of the Drain Valve input. Display will show [DRN ON (or OFF)]. Product key 5 indicator shows the ON or OFF state of the input.

4.4.6 Lamp Test

Press the product key 6. All display indicators will be forced on. The purpose is to reveal non-functional indicators or displays.

4.4.7 Heat Feedback Input

Press the product key 7. Display will show state of the Heat Feedback input [FB xxx], where xxx is ON or OFF. Product key 7 indicator shows the ON or OFF state of the input.

4.4.8 Fill Done Input:

Press the product key 8. Display will show state of the Fill Done input [FD xxx], where xxx is ON or OFF. Product key 8 indicator shows the ON or OFF state of the input.

4.4.9 Exit Diagnostic Menu

To exit diagnostic menu, Press the  key. Display will return to [SERVICE]. Other service menu items may be selected for changes.

To return to programming press the  key again. Display will show [PROGRAM]. Other settings can be made in section 2.

To return to normal operations, press the  key again. Display will show one of the normal displays: [HEATING] or [READY].

4.5 Ready Level

With display showing [SERVICE], press product key 6.

Display shows [READY nn], where “nn” is the value, in degrees below set temperature that the READY message is displayed. To change this value, use the location keys for numeric entry of a new value. *Factory default value is 10 °F.*



Press the  key. Display now shows [SERVICE].

4.6 Temperature Operating Range

Forces the control to display the range of temperatures that may be set by operators.

With display showing [SERVICE], press product key 7.

Display shows [RANGE 1] [150 230]. No adjustments are permitted here. This is an information display only. Press the  key. Display returns to [SERVICE].



4.7 More Service Menu Entry

With display showing [SERVICE], press product key 8.



Display now shows



Location keys will illuminate where adjustments are permitted; all other keys are inactive. The following section details each product key function in the More Service Menu.

4.7.1 Cook Now

Should operators be forced to acknowledge a Cook Done Alarm before starting another cook? This setting forces that requirement. *Factory default value is OFF.*

With display showing [MORE] [SERVICE], press product  key 1. Display will show [NOW xxx] [COOK NOW], where “xxx” is ON or OFF. Use product key  change value, then press the  to save choice. Display returns to [MORE] [SERVICE].

Note: With OFF value selection, operators must acknowledge a done cook [DONE nn] display before starting any another cooks.

With an ON value, operators are permitted to start a cook on the opposite side before acknowledging a cook done alarm.

Example: The left display is showing [DONE 2] with the beeper alarm sounding. Indicator 2 is flashing needing to be acknowledged. All other product indicators are off.

With a set value of OFF, no other cooks can start until product key 2 is pressed to acknowledge and clear the cook done alarm.



With a value of ON set, a cook on the right side of the control (keys 7-12) may be started before operator clears the cook done alarm for product key #2 on the left side.

4.7.2 Maximum Fill Time

This setting is the maximum amount of time to fill, or re-fill the tank. Refill times exceeding this time will force an alarm [FILL] [FAILURE].

With display showing [MORE] [SERVICE], press key .



Display will show [mm:ss] [FILL]. The factory default time is 20:00.

Use product key  change value, then press the  to save choice. Display returns to [MORE] [SERVICE].



4.7.3 Heat Demand Profile

With display showing [MORE] [SERVICE], press key . Display will show [xxxxxxx] [HEAT DEM], where xxxxxx may be one of 3 heat control profiles listed below.



1. [GENERIC 1] for gas fired appliances. This is the factory default.
2. [GENERIC 2] for electric appliances.
3. [T-STAT] control operates as a mechanical thermostat for general purpose applications on gas or electric fryers. This setting offers the quickest possible recovery times at the expense of temperature overshoot suppression.

Use product key  change value, then press the  to save choice. Display returns to [MORE] [SERVICE].



4.7.4 Shake Alarm Duration

With display showing [MORE] [SERVICE], press key . Display will show [SH-DUR:nn] [DURATION], where “nn” is the time in seconds the shake alarm will sound. Use location keys for numeric entry of desired value, then press the  to save choice. Display returns to [MORE] [SERVICE].



4.7.5 Hold Alarm Duration

With display showing [MORE] [SERVICE], press key . Display will show [HD-DUR:nn] [DURATION], where “nn” is the time in seconds the hold alarm will sound. Use location keys for numeric entry of desired value, then press the  to save choice. Display returns to [MORE] [SERVICE].

4.7.6 Cancel Duration

With display showing [MORE] [SERVICE], press key . Display will show [CANCEL:nn] [DELAY], where “nn” is the time in seconds the operators must press a basket key to cancel a cook. Use location keys for numeric entry of desired value, then press the  to save choice. Display returns to [MORE] [SERVICE]. *Default value is 4 seconds.*

4.7.7 Configuration Value

With display showing [MORE] [SERVICE], press key . Display will show [CFG hhhh], where “hhhh” is a hexadecimal check sum of the program contained in the controller. Modifications to any part of the setup of this control will change the check sum value. Press the  key. Display will return to [MORE] [SERVICE].

4.7.8 Factory Reset

Factory Reset provides a quick way to erase all setup changes and restore control to factory settings.

Warning: Any settings made prior to a factory reset will be lost. This includes customer specific downloads performed at Pitco Frialator.

With display showing [MORE] [SERVICE], press key . After a few moments, the display will show [P] for reset. Press the  display will return to [MORE] [SERVICE].

4.7.9 Standing Pilot Toggle

For some applications, it is desirable to maintain the gas pilot flame when the appliance is OFF. Heat from the pilot keeps the vat warmer for quicker start-ups in the morning. Default setting for standing pilot is off.

Note: Heat Demand Profile (section 4.8.3) must be set to Generic 1, or T-stat. Standing Pilot toggle has no effect in any other setting.



With display showing [MORE] [SERVICE], press key . Display will show [STANDING]

[PILOT n], where “n” is ON or OFF. Use key  to toggle value, then press the  to save choice. Display returns to [MORE] [SERVICE].

4.7.10 To Exit More Service Menu

With display showing [MORE] [SERVICE], press the  key. Display returns to [SERVICE]. Continue with Level 2 programming in section 4 (display showing [SERVICE]), or continue.

4.8 To Exit Programming Level 3

- With display showing [SERVICE], press the  key. Display will show [PROGRAM]. Continue with changes in section 2, or continue.
- To return to normal operations, press the  key again. Display will show one of the normal displays: [HEATING] or [READY].

5 Factory Menu Level 4 (for the Technician)

With no cook timers running, displays will show one of the following: [HEATING or [READY]. Press the program key. Left display will show [PROGRAM]. Right display will be blank.

Enter password using the location keys as numeric keypad for entry.

Display will show . The key indicators will illuminate to prompt operator to select a key. This section details parameters that may be changed in Factory programming.

5.1 Offset Temperature Display

This adjustment allows the displayed temperature value to be offset to reflect the true center vat temperature while reading the probe tip temperature. Default value is zero. With zero value set, displayed values are the probe temperature.

With display showing [FACTORY], press product key 1.

Display shows [OFF nn F] [DEGREES], where “nn” is the value of the adjustment.

Negative values are preceded with a minus sign. To change this value, use the location keys for numeric entry of a new value.



Press the key. Display will show [POSITIVE] [DEGREES]. Use the product key to scroll

choices (Positive or Negative value). After selection, press the key. Display shows [FACTORY].

Note: Computer Display Temp – Center Vat Temp = Offset (+/-). Example: Computer Display shows 185F while Center Vat Temp measures at 182F; 185F – 182F = - 3 °F. A negative offset value.

Warning: Proper equipment and expertise is required to properly adjust this value. Even small changes may negatively effect cooking performance.

5.2 Minimum Cycle Time

With display showing [FACTORY], press product key 3.

Display shows [MIN ON :nn] [MIN ON], where “nn” is the value, in seconds, of time for minimum heat pulse period. To change this value, use the location keys for numeric entry of

a new value. Press the key. Display now shows [FACTORY].



5.3 Recovery Time

With display showing [FACTORY], press product key 4.

Display shows [RECY nnn] [RECOVERY], where nnn is the last cold start recovery time.

No adjustments are permitted here. This is an information display only. Press the



key. Display returns to [FACTORY].

5.4 Diagnostic Menu Entry

Same as section 4.5 except [FACTORY] is displayed instead of [SERVICE].



5.5 Ready Level

With display showing [FACTORY], press product key 6.

Display shows [READY nn], where “nn” is the value, in degrees below set temperature that the READY message is displayed. To change this value, use the location keys for numeric entry of a new value.



Press the  key. Display now shows [FACTORY].

5.6 Operating Temperature Range

With display showing [FACTORY], press product key 7. This forces the control to display the range of temperatures that may be set by operators.

Display shows [RANGE 1] [150 230]. No adjustments are permitted here. This is an information display only. Press the  key. Display returns to [FACTORY].



5.7 High Limit Alarm Value

Pressing product key 8 forces the control to display the temperature *above set temperature*, the high limit alarm will sound. This is a display only value, no changes can be made through the keypad. Press the  key. Display returns to [FACTORY].



Factory default value is 20 °F, or 240 °F absolute, whichever is less. This value can only be changed by factory download at Pitco.

5.8 Test On/Off

With display showing [FACTORY], press product key [10/0].

Display shows [TEST xx], where “xx” is ON or OFF. If ON is selected, temperatures displayed by the controller are probe tip temperatures unaltered by values set in section 4.1, or 5.1. For normal operations, this setting should remain OFF.



To change this value, use product key  to toggle choice (ON or OFF).

Press the  key. Display now shows [FACTORY].

5.9 To Exit Factory Menu (Level 4):

To exit Factory Programming, press the  key. Display will show [PROGRAM]. Continue with settings in section 2 or 3, or exit in the next step.

To return to normal operations, press the  key again.

Display will show one of the normal displays: [HEATING] or [READY].

6 Other Displays:

PROBE OP OPEN

Open probe detection is standard on all Pitco controls. If probe is detected open, normal heating and cooking activities are suspended.

HIGH TMP HIGH TMP

This display warns operators that the vat temperature has exceeded set temperature by +20°F (+11°C), or an absolute maximum of 240°F (156°C). This display does not show the status of the mechanical high limit switch.

DRAINING TURN OFF

This message indicates that the drain valve has been opened. The vat is assumed to be empty by the controller. Normal heat control activities are suspended. To restore to normal operation, close the drain valve. Display will show [TURN OFF].

Turn controller off, and refill the vat. Continue with normal operations at section 1.

HEAT FAILURE

This message indicates that the heating system failed to respond. Typically, the high temperature limit switch has tripped and is in need of resetting. On gas fired appliances, this message will display if the pilot fails to light or is detected marginal by the ignition module.

SYSTEM FAILURE

This message indicates a shorted probe. If probe is detected as a short circuit, normal heating and cooking activities are suspended.

FILL FAILURE

This message appears when the tank fails to fill within a set period of time. Check that the water supply line is turned ON. To restore to normal operation, turn the control OFF then ON again. While the tank is (re)filling, heat is disabled.

7 Mechanical Dimensions:

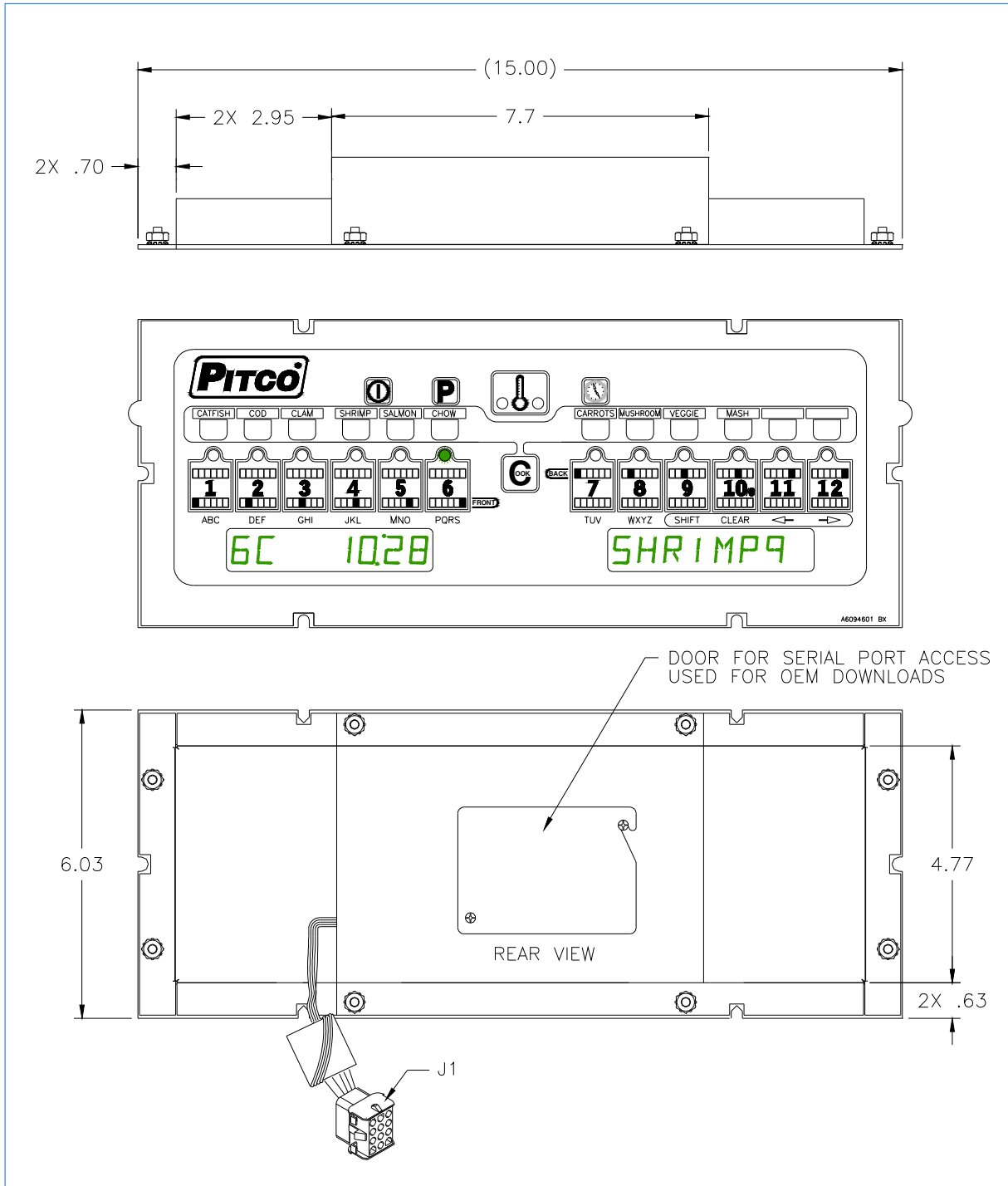

8 Electrical Connections at J1:

J1	Inputs	Type	Nominal	Notes:
1	ACH	PWR	24VAC	24VAC +20% -15% 50/60Hz.
2	ACN	PWR	24VACN	24VAC Return.
3	PROBE+	Thermistor Proble	Resistance varies with vat temperature. 942 Ohms @ 350°F	
4	PROBE-			
5	DVI	IN	24VAC	Drain Valve Interlock
6	HFB	IN	24VAC	Heat Feed Back
7	24VDC COM	IN	24VDC	DC Return
8	HD	OUT	24VDC	Heat Demand
9	SO/xFER	OUT	24VDC	Side ON or XFER
10	RBL	OUT	24VDC	Right Basket Lift
11	LBL	OUT	24VDC	Left Basket Lift
12	FD	IN	24VAC	Fill Done Input

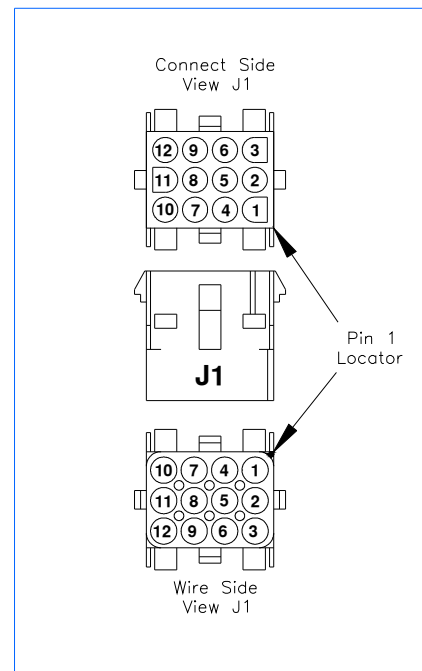

Tip: Use the diagnostic menu to check outputs, and verify inputs.

9 Installing Menu Strips:

Step 1:

- ❑ Remove the two screws holding the control and bezel.
- ❑ Gently pull the assembly out and down.

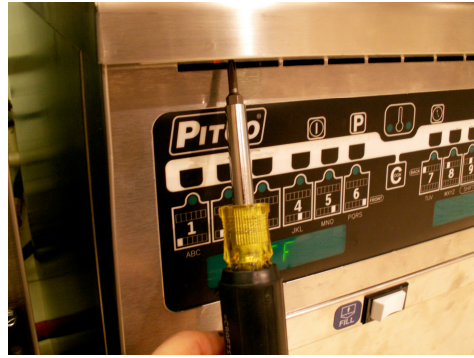

Step 2:

- ❑ Disconnect the molex connector and remove the bezel assembly from the unit.

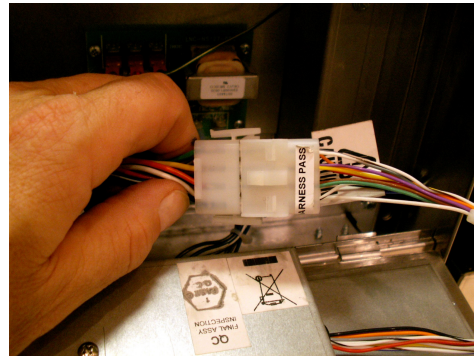

Step 3

- ❑ With the control face down, using a nut driver, remove two 5/16" nuts at the bottom of the bezel and loosen the top two 5/16" nuts.
- ❑ Remove the control and place on its back.

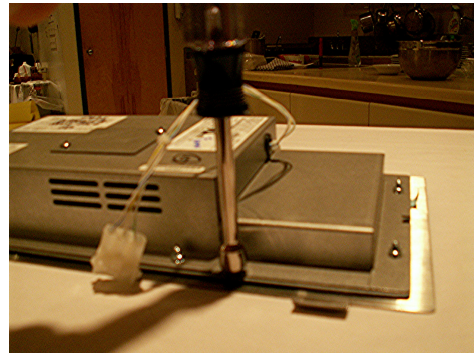

Step 4:

- ❑ Locate the menu strip and align with the black tab on the control.

- ❑ Gently slide the menu strip into the slot until the strip goes to the end of the control.

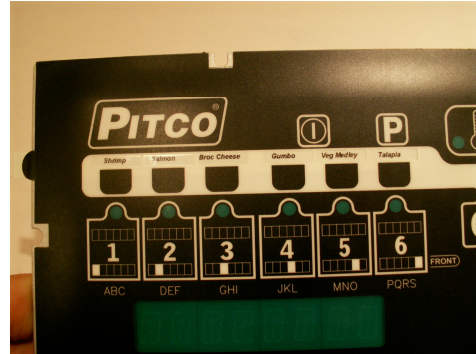
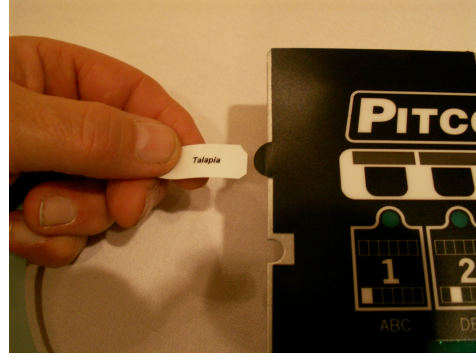
**Step 5:**

- ❑ Follow steps 3, 2, and 1 in reverse order to reinstall the control and bezel to the unit.





This page left blank

**10 Probe Resistance Chart:**

Probe Resistance in 5°F Increments.								
Probe Temp (°F)	Probe Temp (°C)	Resistance (Ohms)	Probe Temp (°F)	Probe Temp (°C)	Resistance (Ohms)	Probe Temp (°F)	Probe Temp (°C)	Resistance (Ohms)
10	-12.2	562734	175	79.4	11719	340	171.1	1058.23
15	-9.4	483875	180	82.2	10716	345	173.9	998.09
20	-6.7	417167	185	85.0	9812	350	176.7	942.00
25	-3.9	360589	190	87.8	8995	355	179.4	889.67
30	-1.1	312474	195	90.6	8255	360	182.2	840.78
35	1.7	271446	200	93.3	7586	365	185.0	795.10
40	4.4	236370	205	96.1	6979	370	187.8	752.38
45	7.2	206311	210	98.9	6427	375	190.6	712.41
50	10.0	180491	215	101.7	5926	380	193.3	674.95
55	12.8	158252	220	104.4	5470	385	196.1	639.87
60	15.6	139055	225	107.2	5055	390	198.9	606.96
65	18.3	122489	230	110.0	4675	395	201.7	576.09
70	21.1	108051	235	112.8	4329	400	204.4	547.09
75	23.9	95539	240	115.6	4013	405	207.2	519.86
80	26.7	84644	245	118.3	3723	410	210.0	494.24
85	29.4	75136	250	121.1	3458	415	212.8	470.16
90	32.2	66823	255	123.9	3214	420	215.6	447.49
95	35.0	59540	260	126.7	2991	425	218.3	426.13
100	37.8	53146	265	129.4	2785	430	221.1	406.02
105	40.6	47523	270	132.2	2597	435	223.9	387.04
110	43.3	42569	275	135.0	2422	440	226.7	369.14
115	46.1	38195	280	137.8	2262	445	229.4	352.24
120	48.9	34328	285	140.6	2113.9	450	232.2	336.29
125	51.7	30902	290	143.3	1977.3	455	235.0	321.21
130	54.4	27862	295	146.1	1851.0	460	237.8	306.94
135	57.2	25161	300	148.9	1734.3	465	240.6	293.46
140	60.0	22755	305	151.7	1626.1	470	243.3	280.69
145	62.8	20610	310	154.4	1525.9	475	246.1	268.61
150	65.6	18695	315	157.2	1433.0	480	248.9	257.15
155	68.3	16981	320	160.0	1346.7	485	251.7	246.30
160	71.1	15446	325	162.8	1266.6	490	254.4	236.00
165	73.9	14069	330	165.6	1192.1	495	257.2	226.24
170	76.7	12823	335	168.3	1122.8	500	260.0	216.96

Notes: Resistance of either probe lead to the frame of the appliance should read as "open" on the meter. Typically this is 1Meg ohms or more.

$$^{\circ}\text{C} = 5/9 (^{\circ}\text{F} - 32)$$

$$^{\circ}\text{F} = (9/5 * ^{\circ}\text{C}) + 32$$



In the event of problems with or questions about your order, please contact the Pitco Frialator factory at

(800) 258-3708 US and Canada only

(603) 225-6684 World Wide

In the event of problems with or questions about your equipment, please contact the Pitco Frialator Authorized Service and Parts representative (ASAP) covering your area, or contact Pitco at the numbers listed to the left.

MAILING ADDRESS – P.O. BOX 501, CONCORD, NH 03302-0501

SHIPPING ADDRESS – 10 FERRY ST., CONCORD, NH 03301

L22-306 Rev 0 (09/07)

Free Manuals Download Website

<http://myh66.com>

<http://usermanuals.us>

<http://www.somanuals.com>

<http://www.4manuals.cc>

<http://www.manual-lib.com>

<http://www.404manual.com>

<http://www.luxmanual.com>

<http://aubethermostatmanual.com>

Golf course search by state

<http://golfingnear.com>

Email search by domain

<http://emailbydomain.com>

Auto manuals search

<http://auto.somanuals.com>

TV manuals search

<http://tv.somanuals.com>