

**PLANAR**<sup>®</sup>

# PLANAR LCD MONITOR CT1905S MANUAL

[www.planar.com](http://www.planar.com)





---

## **FCC Compliance Statement**

---

This device complies with part 15 of the FCC Rules. Operation is subject to the following two conditions:

1. this device may not cause harmful interference, and
2. this device must accept any interference received, including interference that may cause undesired operation.

### **FCC WARNING**

This equipment has been tested and found to comply with the limits for a Class B digital device, pursuant to Part 15 of the FCC Rules. These limits are designed to provide reasonable protection against harmful interference in a residential installation.

This equipment generates, uses and can radiate radio frequency energy and, if not installed and used in accordance with the instructions, may cause harmful interference to radio communications.

However, there is no guarantee that interference will not occur in a particular installation. If this equipment does cause harmful interference to radio or television reception, which can be determined by turning the equipment off and on, the user is encouraged to try to correct the interference by one or more of the following measures:

- Reorient or relocate the receiving antenna.
- Increase the separation between the equipment and the receiver.
- Connect the equipment into an outlet different from that to which the receiver is connected.
- Consult the dealer or an experienced radio/TV technician for help.

### **Caution:**

To comply with the limits for an FCC Class B computing device, always use the shielded signal cord supplied with this unit.

The Federal Communications Commission warns that changes or modifications of the unit not expressly approved by the party responsible for compliance could void the user's authority to operate the equipment.

**CE mark for Class B ITE (Following European standard EN55022/1998; EN61000-3-2/1995; EN61000-3-3/1995, EN55024/1998, EN60950/1992+A1+A2+A3+A4+A11)**

---

---

## **Radio Frequency Interference Statement**

---

### **Warning:**

This is a Class B product. In a domestic environment, this product may cause radio interference in which case the user may be required to take adequate measures.

---

## **Canadian Doc Notice**

---

### **For Class B Computing Devices**

This digital apparatus does not exceed the Class B limits for radio noise emissions from digital apparatus as set out in the Radio Interference Regulation of the Canadian Department of Communications.

“Le présent appareil numérique n'émet pas de bruits radioélectriques dépassant les limites applicables aux appareils numériques de la class B prescrites dans le Règlement sur le brouillage radioélectrique édicté par le ministère des Communications du Canada”



---

### Important Safety Instructions

---

Please read the following instructions carefully. This manual should be retained for future use.

1. To clean the LCD Monitor screen, first, make sure the Monitor is in the power off mode. Unplug the Monitor from its power source before cleaning it. Do not spray liquid cleaners directly onto the unit. Stand away from the LCD Monitor and spray cleaning solution onto a rag. Without applying excessive pressure, clean the screen with the slightly dampened rag.
2. Do not place your LCD Monitor near a window. Exposing the Monitor to rain, water, moisture or sunlight can severely damage it.
3. Do not place anything on top of the Monitor-to-PC signal cord. Make sure the cord is placed in an area where it will not be stepped on.
4. Do not apply pressure to the LCD screen. Excessive pressure may cause permanent damage to the display.
5. Do not remove the cover or attempt to service this unit by yourself. You may void the warranty. Servicing of any nature should be performed only by an authorized technician.
6. Safe storage of the LCD Monitor is in a range of minus 20 to plus 60 degrees Celsius (68°F-140°F). Storing your LCD Monitor outside this range could result in permanent damage.
7. If any of the following occurs, immediately unplug your Monitor and call an authorized technician.
  - The power or Monitor-to-PC signal cord is frayed or damaged.
  - Liquid has been spilled onto the Monitor, or it has been exposed to rain.
  - The Monitor has been dropped or the case has been damaged.



**TABLE OF CONTENTS**

**PREFACE** ..... I

**TABLE OF CONTENTS** ..... III

**CHAPTER 1** ..... 1

**Your new LCD Monitor!** ..... 1

**Unpacking** ..... 1

**Identifying Components** ..... 2

*The LCD Monitor — Front View* ..... 2

*The LCD Monitor — Rear View* ..... 2

**Adjusting the Viewing Angle** ..... 3

**Connecting AC Power** ..... 3

**Connecting Video** ..... 4

**Connecting the Stereo Speakers** ..... 4

**Connecting the Optional Touch Screen** ..... 5

**Power Management System** ..... 5

**CHAPTER 2** ..... 6

**The LCD Monitor's Display Controls** ..... 6

*OSD Main Menu* ..... 6

**The hotkey descriptions** ..... 9

**APPENDIX A** ..... 10

**TFT LCD Monitor Specifications** ..... 10

**APPENDIX B** ..... 11

**APPENDIX C** ..... 12

**Troubleshooting Procedures** ..... 12



# **The LCD Monitor**

## **Your new LCD Monitor!**

Your LCD Monitor has been designed to be versatile, ergonomic and user-friendly. The LCD Monitor is capable of displaying most standards, from 640 x 480 VGA to 1600 x 1200 UXGA. The digital controls located on the front panel allow the user to easily adjust the Monitor's display parameters. The LCD Monitor's small footprint allows you more room in your workspace for other peripherals. Lightweight and compact, the LCD Monitor is the perfect solution for all type of users.

## **Unpacking**

Before you unpack your LCD Monitor, prepare a suitable workspace for your LCD Monitor and computer. You need a stable, level and clean surface near a wall outlet. Even though the LCD Monitor uses very little power, you should put it in a location, which allows sufficient airflow to ensure that the LCD Monitor and your computer does not become too hot. Set up your LCD Monitor so that the panel doesn't face a window where sunlight often comes in. The glare caused by sunlight reflecting off the LCD Monitor's screen will make it difficult to see. After you unpack your LCD Monitor; make sure the following items are included in the box and in good condition:

- LCD Monitor
- Monitor-to-PC Analog signal cable (15-pin)
- Monitor-to-PC Digital signal cable (24-pin)
- USB cable
- Stereo Jack Audio cable
- Power cord
- This user's manual
- 

If you find that any of these items are missing or appear damaged, contact your dealer immediately. Do not throw away the packing material or shipping carton in case you need to ship or store the LCD Monitor in the future.



## Identifying Components

The LCD Monitor has been designed to provide easy access to all controls and peripheral ports. The following figures will help you identify the LCD Monitor's controls and ports.

### The LCD Monitor — Front View

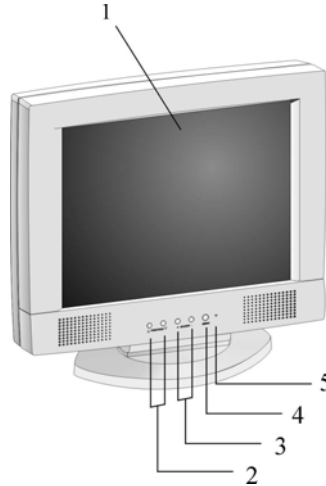

1. **Display Module**  
The display is a 19-inch diagonal, Active Matrix Liquid Crystal Display (AMLCD). The screen is capable of supporting a maximum resolution of 1600 x 1200 (UXGA).
2. **◀▶ Function Select Buttons**  
These two buttons allow you to select the control functions in the OSD. Press either button to scroll through the main menu and submenu items.
3. **⊖ Adjust ⊕ Control Buttons**  
The ⊕ button allows you to increase the menu item value.  
The ⊖ button allows you to decrease the menu item value.
4. **Port Select**  
Push the Port select button to select either Digital input or Analog input mode.
5. **LED Power Mode Indicator**  
This LED indicator stays lit when the power is on and when the monitor is receiving a proper video signal. The LED will blink slowly when the LCD monitor is in power saving mode.

### The LCD Monitor — Rear View

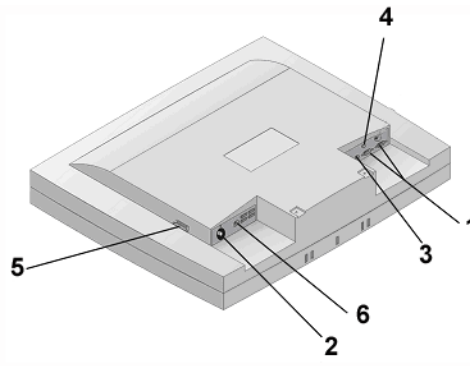





**1. Input signal ports**

The monitor can accept signal input from either a traditional analog 15-pin D-Sub VGA connector or the 24-pin Digital Video Interface (DVI) connector. If both cables are connected, the PORT SELECT button on the front of the monitor can select which input is displayed.

**2. AC Power Jack**

The supplied AC/DC power adaptor is attached here. Connect the supplied power cable to power adaptor and the other end directly to a wall outlet.

**3. Audio Line-In**

Connect your PC's Line out to this jack to listen to the PC's audio through the LCD Monitor's stereo speakers. (You can also connect your CD-ROM's Line out to this jack.)

**4. Stereo Headphone Jack**

Stereo headphones may be connected to the headphone jack.

**5. Power Switch**

Powers the monitor ON or OFF.

**6. USB Hub**

Connect the USB cable from this port to PC HOST. Up to 4 devices may be connected through this hub.

## Adjusting the Viewing Angle

Your LCD Monitor can be adjusted both horizontally and vertically.

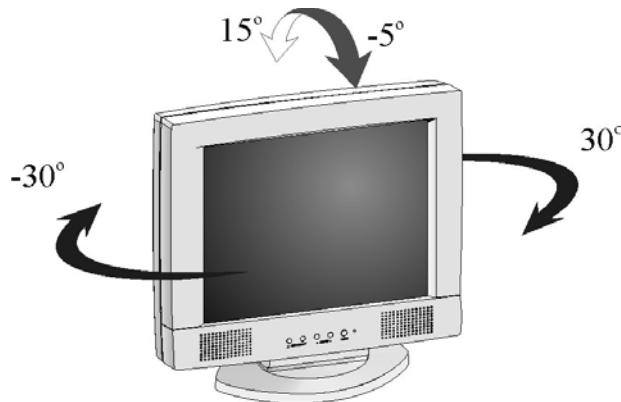

## Connecting AC Power

Plug the female end of the power cable into the AC power connector. Plug the male end of the power cord into a wall socket. The plug on the power cable will vary according to the electrical standard in your area.

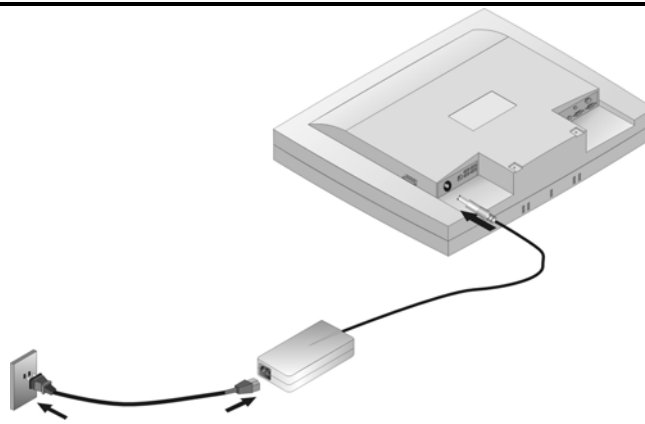

### Connecting Video

1. Before connecting your monitor to the PC, please power-off both devices.
2. Connect one end of the VGA signal cable to the PC's 15-pin VGA port and the other end to the monitor 15-pin VGA port.

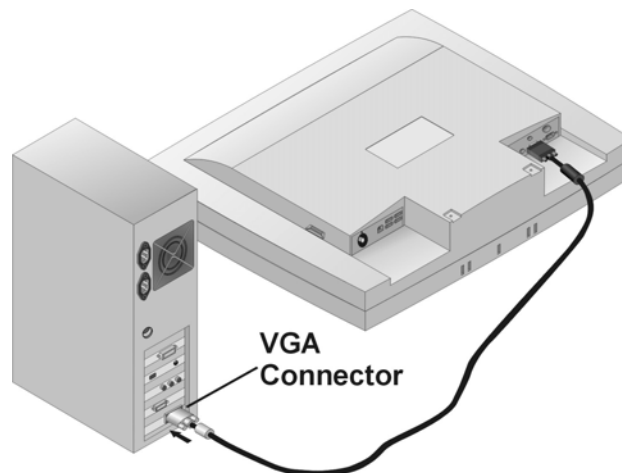

3. Connect one end of the DVI signal cable to the PC's 24-pin DVI port and the other end to the monitor 24-pin DVI port.
4. Make sure the signal cables are securely connected to both the monitor and PC. Tighten the connecting screws to ensure a secure connection.



**Note** *If both analog (15-pin D-sub VGA) and digital (24-pin DVI) input ports are connected at the same time, the signal input can be selected with the port select button. Please go to the next chapter for details.*

### Connecting the Stereo Speakers

1. Connect the 1.5M audio cable to the Line-OUT of your PC's audio card.
2. Connect the opposite end of the 1.5M audio cable to the LCD Monitor's line-IN connector.

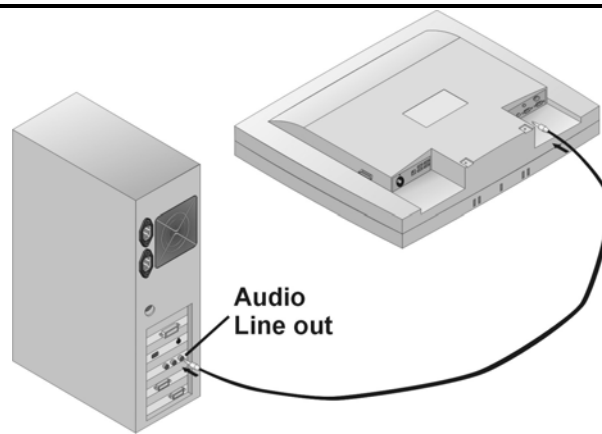

## Connecting the Optional Touch Screen

Your LCD Monitor has an optional touch screen feature. If your LCD monitor has this feature, connect the LCD Monitor's PS/2 connector to your PC's 9-pin RS232 serial port to enable the touch screen.

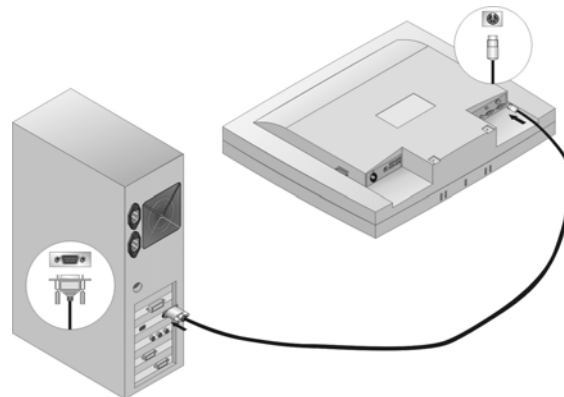

1. Install the Touch Screen Drivers to your PC.
2. Following the Touch Screen driver guide to align your touch screen positioning.

## Power Management System

The LCD Monitor complies with the VESA DPMS (version 1.0p) power management proposal. The VESA DPMS proposal provides four phases of power saving modes by detecting the horizontal or vertical sync signal. When the LCD Monitor is in power saving mode or detects an incorrect timing, the Monitor screen will go blank, and the power LED indicator will start to blink.

# The Display Controls

## The LCD Monitor's Display Controls

The LCD Monitor features an intuitive, menu-driven, On-Screen Display (OSD). You can access the OSD any time when the PC is powered on. If the PC is in a power saving mode, or is powered off, the OSD is inaccessible.

The OSD make the adjusting display settings quick and simple. Use the *MENU* button to access the OSD and the *Function* buttons are used scroll through the menu items. Use the *Adjustment* buttons to make changes to the selected menu item.

## Adjusting the Display

The LCD monitor features an intuitive, menu-driven, On-Screen Display (OSD). You can access the OSD any time that the PC is powered up. If the PC is in a power saving mode, or is powered down, the OSD is inaccessible.



### OSD Main Menu

To activate the OSD Main Menu, press the left ◀ Function key. To navigate the topline menu, use either the right ▶ or left ◀ function keys to scroll between the main menu choices.

The option that is currently selected is highlighted in red. Each main menu has an associated submenu and is further described.

### The 4-topline menus are:

	<p>The Display menu allows you to adjust the displays Contrast, Brightness, DOS Graphic Mode, Automatic Display Adjustment, Audio Volume, and Exit</p>
	<p>The Geometric Mode allows you to adjust the LCD monitor's display characteristics such as scaling, display clock adjustment, display phase adjustment, display horizontal position, and display vertical position.</p>
	<p>The OSD Adjust Mode allows you to adjust the position and setting of the monitor's On Screen Display, OSD text language, and get the information of current video input mode.</p>

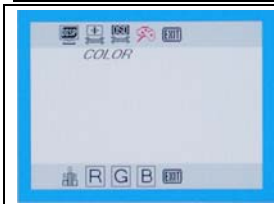

The Color Mode allows you to adjust the display's color temperature and individual Red, Green, or Blue color coordinate settings.

The submenus for each are further described below.



### The Display Menu

Pressing the **ADJUST** key on the monitor activates the Display Menu. Use the **FUNCTION** select buttons to scroll between the submenu items

	<b>Contrast:</b> Use the <b>Adjust</b> keys to adjust the difference between the lightest and darkest areas on the display. The contrast level can range from 0 to 63.
	<b>Brightness:</b> Use the <b>Adjust</b> keys to adjust the intensity of the monitor backlight.
	<b>Speaker Volume:</b> Use the <b>Adjust</b> to adjust the monitor speaker volume.
	<b>Graph/Text:</b> Use the <b>Adjust</b> to change between DOS graphic 640x400 or 720x400. This function is not used within MS Windows.
	<b>Auto Adjust:</b> While the Auto-Adjust sub-menu is selected, press the <b>Adjust</b> key to activate the Auto Adjust procedure. The Auto Adjust procedure takes approximately 2 seconds to complete. Once finished, the OSD menu will disappear after a short time-out period.
	<b>Exit:</b> Press the <b>Adjust</b> key to exit the Graphic-Control submenu.

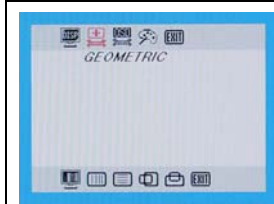

### Geometric Menu

Pressing the **Adjust** key on the monitor activates the Geometric submenu. Use the **FUNCTION** select buttons to scroll between the submenu items. *You should only use this menu item if the results of the Auto Adjust function are not satisfactory.*

	<b>Scale:</b> Press the <b>Adjust</b> key to change to full screen scaling or native resolution.
	<b>Clock:</b> Press the <b>Adjust</b> key to stabilize the display clock timing. An improper clock setting will result in wide vertical bands on the display.
	<b>Phase:</b> Press the <b>Adjust</b> key to fine-tune the displayed image. An improper phase adjustment will result in pixel jitter or display noise.
	<b>Horizontal Position:</b> Press the <b>Adjust</b> keys horizontally move the display image to the desired position.
	<b>Vertical Position:</b> Press the <b>Adjust</b> keys vertically move the display image to the desired position.
	<b>Exit:</b> Press the <b>Adjust</b> key to exit the Geometric submenu.

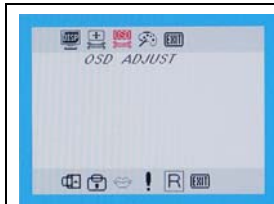

### OSD Adjust Option

Pressing the **Adjust** key on the monitor activates the OSD Adjust Menu. Use the **FUNCTION** select buttons to scroll between the submenu items.



	<b>OSD-H-Position:</b> Use the ◀ Adjust ▶ keys to horizontally move the OSD menu.
	<b>OSD-V-Position:</b> Use the ◀ Adjust ▶ keys to vertically move the OSD menu.
	<b>Language:</b> Use the ◀ Adjust ▶ keys to select the desired OSD display language. Languages supported: English, German, French, Dutch, Swedish and Japanese.
	<b>Information:</b> The Information submenu displays the current resolution, vertical refresh rate, and monitor firmware version.
	<b>Reset:</b> Use the Adjust ▶ key to reset the OSD values to factory default.
	<b>Exit:</b> Use the Adjust ▶ key to exit the OSD Adjust Menu.

	<h2><u>Color Adjust Option</u></h2>
<p>Pressing the Adjust ▶ key on the monitor activates the Color Adjust menu. Use the ◀FUNCTION▶ select buttons to scroll between the submenu items.</p>	
	<b>9300:</b> Use the Adjust ▶ key to select 9300-temperature setting.
	<b>6500:</b> Use the Adjust ▶ key to select 6500-temperature setting.
	<b>R:</b> Use the ◀ Adjust ▶ to make desired color level for color component Red.
	<b>G:</b> Use the ◀ Adjust ▶ to make desired color level for color component Green.
	<b>B:</b> Use the ◀ Adjust ▶ to make desired color level for color component Blue.
	<b>Exit:</b> Use the Adjust ▶ key to exit the OSD Adjust Menu.

**Note:**

- When there is no input signal**  
When the monitor is ON and there is no Video signal received, the following message will be displayed.



(Analog mode)





(Digital mode)

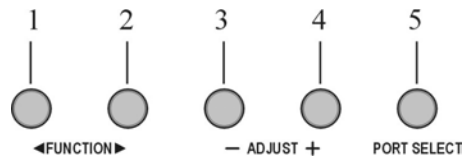

## The hotkey descriptions

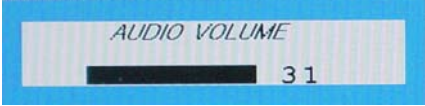
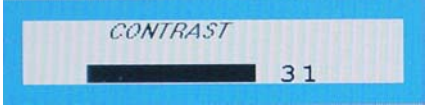

- 1. Main Menu pop up /Auto-Adjust Hotkey**  
Press and release this button within 2 seconds will pop up the OSD Main Menu. Press this button over 2 seconds will activate the Auto-Adjust function.
- 2. Audio Volume Hotkey**  
Press this button will pop up the Audio Volume adjust icon, and then use Adjustment control buttons to get the prefer setting.  

- 3. Contrast Adjust Hotkey**  
Press this button will pop up the Contrast Adjust icon, and use Adjustment control buttons to get the prefer setting.  

- 4. Brightness Adjust Hotkey**  
Press this button will pop up the Brightness Adjust icon, and then use Adjustment control buttons to get the prefer setting.  

- 5. Port Select Hotkey**  
Press and release this button within 2 seconds to select either Digital or Analog input mode

# Technical Information

## TFT LCD Monitor Specifications

Model	Planar CT1905U
LCD Panel	19" UXGA
Control Functions Power	Rocker switch with LED indicator
On-Screen Display (OSD)	DISPLAY-----CONTRAST/BRIGHTNESS/AUDIO VOLUME./GRAPH./TEXT/AUTO ADJUST GEOMETRIC-----SCALE/CLOCK/PHASE/H-POSITION/V-POSITION. OSD ADJUST-----OSD H-POSITION/OSD V-POSITION/LANGUAGE./INFORMATION /RESET. COLOR-----USER (9300/6500)/R/G/B. LANGUAGE-----ENGLISH/JAPANESE/DEUTSCH/FRANÇAIS/NEDERLANDS /SVENSKA.
Display Area (mm)	386.4x 289.8mm (19 inch diagonal)
Response Time	25/25 ms typical
Contrast Ratio	300:1 typical
Brightness	200 cd/m <sup>2</sup> typical
Pixel Pitch (mm)	0.2415 x 0.2415
Viewing Angle	Horizontal: 160° Vertical: 160°
Display Colors	16.7M
Video Interface	Analog port: VGA Compatible Analog RGB (15-pin D-Sub) Separate Sync. /Composite Digital port: DDWG compliant Single Link Tmds Digital Visual Interface (DVI) (with port AUTO-detection)
Scanning Frequency H/V, Hz (Analog mode)	24-80kHz 50-90
Scanning Frequency H/V, Hz (Digital mode)	30-80kHz 56-85
Number of Factory Preset Mode	37
Power Management	Meets VESA DPMS
Power Consumption (ON mode/OFF mode)	90W (max.)/5W (max.)(Measured from AC inlet)
Dimensions WxHxD mm	467 x 452 x 242
Net Weight (Kg)	6.9 kg
Power Supply	12V /6A, 72W Universal Input AC Adapter (External)
Options	Wall-mounted bracket, Arm-mounted bracket (VESA Compliance) USB Hub (1 up and 4 down streams), Touch Screen, B.N.C. Adapter cable, DVI to DFP Digital Cable
Environment	Operating Temperature: 0 to 40° C Relative Humidity: 10% to 90%
Audio (Two 1 Watt speakers with amplifier)	Yes
Regulatory	UL/CUL, TÜV-GS, CE Mark, VCCI, FCC B DoC, Nordic, TCO '99, EPA Energy Star Program



## Supported Timing

## Timing for Model CT1905U (UXGA Resolution)

Item	Standards	Resolution	Dot Clock (MHz)	Vertical Scanning Frequency (Hz)	Horizontal Scanning Frequency (kHz)	Sync Polarity or composite sync (H/V)	Operating Mode
1	NEC PC98	640x400	25.20	70.15	31.50	-/-	A
2	NEC PC98	640x400	21.05	56.42	24.83	-/-	A
3	MAC 13" mode	640x480	30.24	66.67	35.00	-/-	A/D
4	MAC 16" mode	832x624	57.28	74.55	49.73	-/-	A/D
5	MAC 17" mode	1024x768	80.00	75.02	60.24	-/-	A/D
6	VGA	640x350	25.18	70.09	31.47	+/-	A/D
7	VESA	640x350	31.50	85.08	37.86	+/-	A/D
8	VGA	640x400	25.18	70.09	31.47	-/+	A
9	VESA	640x400	31.50	85.08	37.86	-/+	A
10	VGA	640x480	25.18	59.94	31.47	-/-	A/D
11	VESA	640x480	31.50	72.81	37.86	-/-	A/D
12	VESA	640x480	31.50	75.00	37.50	-/-	A/D
13	VESA	640x480	36.00	85.01	43.27	-/-	A/D
14	VESA	800x600	36.00	56.25	35.16	+/+	A/D
15	SVGA	800x600	40.00	60.32	37.88	+/+	A/D
16	VESA	800x600	50.00	72.19	48.08	+/+	A/D
17	VESA	800x600	49.50	75.00	46.88	+/+	A/D
18	VESA	800x600	56.25	85.06	53.67	+/+	A/D
19	VGA	720x400	28.32	70.09	31.47	-/+	A
20	VESA	720x400	35.50	85.04	37.93	-/+	A
21	XGA	1024x768	65.00	60.00	48.36	-/-	A/D
22	VESA	1024x768	75.00	70.07	56.48	-/-	A/D
23	VESA	1024x768	78.75	75.03	60.02	+/+	A/D
24		1024x768	71.64	66.13	53.96	+/+	A/D
25	VESA	1152x864	108.0	75.00	67.50	+/+	A/D
26	VESA	1152x864	121.5	85.00	77.09	+/+	A/D
27	VESA	1024x768	94.50	85.00	68.68	+/+	A/D
28	VESA	1280x960	108.0	60.0	60.0	+/+	A/D
29	VESA	1280x1024	108.0	60.02	63.98	+/+	A/D
30	VESA	1280x1024	127.0	69.85	74.88	+/+	A/D
31	VESA	1280x1024	135.0	75.03	79.98	+/+	A/D
32	SUN	1024x768	64.13	59.98	48.29	H+V	A
33	SUN	1024x768	74.25	70.04	56.59	H+V	A
34	SUN	1024x768	84.38	77.07	62.04	H+V	A
35	SUN	1280x1024	117.0	67.19	71.69	H+V	A
36	SUN	1280x1024	135.0	76.10	81.13	H+V	A
37	VESA	1600x1200	162.0	60.00	75.00	+/+	A/D

\*A=Analog Mode; D=Digital Mode

\*Once a mode is optimized, there is no need to make any further adjustment as long as the VGA card remains unchanged.

\*Specifications are subject to change without notice.

# Troubleshooting

## Troubleshooting Procedures

This LCD Monitor was pre-adjusted in the factory with standard VGA timing. Due to output timing differences among various VGA cards, you may initially experience an unstable or unclear display when a new display mode or new VGA card is selected.



*This LCD Monitor Supports Multiple VGA Modes. Refer to Addendum for a listing of the factory preset modes supported by this LCD Monitor.*

### **PROBLEM: Display is Unclear and Unstable**

To stabilize and clarify your display, follow this procedure in this order:

1. It's best to adjust the display on a screen displaying of vertical lines. In Windows, load a wallpaper bitmap that has vertical lines in it. (Or you can the select window shut down screen)
2. After you have the wallpaper loaded, open the OSD and select the "Clock" function. Press the top (or bottom) Adjustment Control button and continue pressing the button until you see vertical dark and light lines across the screen.
3. When you can see distinct light and dark vertical bands, stop pressing the Adjustment Control button. Now press the opposite (top or bottom) Adjustment Control button. The vertical dark and light bands will decrease in number. Keep pressing the button until the distinct bands disappear and you have a clear display.
4. Next press the Function Control button to choose the "Phase" function. The Phase will adjust the horizontal display. Press the top (or bottom) Adjustment Control button and you will see horizontal dark and light lines appear. The number of lines increases as you press the button. Now press the bottom (or top) Adjustment Control button until the lines disappear and you have a clear display.

### **PROBLEM: There is no LCD Display**

If there is no display on the LCD, please perform the following steps:

1. Make sure that the power indicator on the LCD Monitor is lit, all connections are secure, and the system is running on the correct timing. Refer to the Addendum for information on timing.
2. Turn off the LCD Monitor and then turn it back on again. Press the upper Function Control button (refer to Chapter 2) once and then press either the upper or lower Adjustment Control button several times. If there is still no display, press the other Adjustment Control button several times.
3. If step 2 doesn't work, connect your PC system to another external CRT Monitor. If your PC System function properly with a CRT Monitor but it does not function with the LCD Monitor and the LCD Monitor's power LED is blinking, the output timing of the PC's VGA card may be out of the LCD's synchronous range. Please change to an alternate mode listed in Addendum or replace the VGA card and repeat steps 1 and 2.
4. If the PC (or Notebook PC) doesn't function with the CRT monitor neither, check BIOS to see if there is a *Simultaneous Display* setting under the display mode item. Set the BIOS display mode to *Simultaneous Display* or *CRT* and try again. If there is still no display, then there may be a problem with your system. Contact technical support.
5. If the power LED is not lit, check to see if the AC power connector is securely connected. If the power LED is not lit, please contact your dealer for assistance.

## Free Manuals Download Website

<http://myh66.com>

<http://usermanuals.us>

<http://www.somanuals.com>

<http://www.4manuals.cc>

<http://www.manual-lib.com>

<http://www.404manual.com>

<http://www.luxmanual.com>

<http://aubethermostatmanual.com>

Golf course search by state

<http://golfingnear.com>

Email search by domain

<http://emailbydomain.com>

Auto manuals search

<http://auto.somanuals.com>

TV manuals search

<http://tv.somanuals.com>